

Industrial Automation Headquarters

Delta Electronics, Inc.

Taoyuan Technology Center
No.18, Xinglong Rd., Taoyuan District,
Taoyuan City 33068, Taiwan
TEL: +886-3-362-6301 / FAX: +886-3-371-6301

Asia

Delta Electronics (Shanghai) Co., Ltd.

No.182 Minyu Rd., Pudong Shanghai, P.R.C.
Post code : 201209
TEL: +86-21-6872-3988 / FAX: +86-21-6872-3996
Customer Service: 400-820-9595

Delta Electronics (Japan), Inc.

Industrial Automation Sales Department
2-1-14 Shibadaimon, Minato-ku
Tokyo, Japan 105-0012
TEL: +81-3-5733-1155 / FAX: +81-3-5733-1255

Delta Electronics (Korea), Inc.

1511, 219, Gasan Digital 1-Ro., Geumcheon-gu,
Seoul, 08501 South Korea
TEL: +82-2-515-5305 / FAX: +82-2-515-5302

Delta Energy Systems (Singapore) Pte Ltd.

4 Kaki Bukit Avenue 1, #05-04, Singapore 417939
TEL: +65-6747-5155 / FAX: +65-6744-9228

Delta Electronics (India) Pvt. Ltd.

Plot No.43, Sector 35, HSIIDC Gurgaon,
PIN 122001, Haryana, India
TEL: +91-124-4874900 / FAX: +91-124-4874945

Delta Electronics (Thailand) PCL.

909 Soi 9, Moo 4, Bangpoo Industrial Estate (E.P.Z),
Pattana 1 Rd., T.Phraksa, A.Muang,
Samutprakarn 10280, Thailand
TEL: +66-2709-2800 / FAX: +66-2709-2827

Delta Electronics (Australia) Pty Ltd.

Unit 2, Building A, 18-24 Ricketts Road,
Mount Waverley, Victoria 3149 Australia
Mail: IA.au@deltaww.com
TEL: +61-1300-335-823 / +61-3-9543-3720

Americas

Delta Electronics (Americas) Ltd.

5101 Davis Drive, Research Triangle Park, NC 27709, U.S.A.
TEL: +1-919-767-3813 / FAX: +1-919-767-3969

Delta Electronics Brazil Ltd.

Estrada Velha Rio-São Paulo, 5300 Eugênio de
Melo - São José dos Campos CEP: 12247-004 - SP - Brazil
TEL: +55-12-3932-2300 / FAX: +55-12-3932-237

Delta Electronics International Mexico S.A. de C.V.

Gustavo Baz No. 309 Edificio E PB 103
Colonia La Loma, CP 54060
Tlalnepantla, Estado de México
TEL: +52-55-3603-9200

EMEA

Delta Electronics (Netherlands) B.V.

Sales: Sales.IA.EMEA@deltaww.com
Marketing: Marketing.IA.EMEA@deltaww.com
Technical Support: iatechnicalsupport@deltaww.com
Customer Support: Customer-Support@deltaww.com
Service: Service.IA.emea@deltaww.com
TEL: +31(0)40 800 3900

Delta Electronics (Netherlands) B.V.

Automotive Campus 260, 5708 JZ Helmond, The Netherlands
Mail: Sales.IA.Benelux@deltaww.com
TEL: +31(0)40 800 3900

Delta Electronics (Netherlands) B.V.

Coesterweg 45, D-59494 Soest, Germany
Mail: Sales.IA.DACH@deltaww.com
TEL: +49 2921 987 238

Delta Electronics (France) S.A.

ZI du bois Challand 2, 15 rue des Pyrénées,
Lisses, 91090 Evry Cedex, France
Mail: Sales.IA.FR@deltaww.com
TEL: +33(0)1 69 77 82 60

Delta Electronics Solutions (Spain) S.L.U

Ctra. De Villaverde a Vallecas, 265 1º Dcha Ed.
Hormigueras - P.I. de Vallecas 28031 Madrid
TEL: +34(0)91 223 74 20

Carrer Llacuna 166, 08018 Barcelona, Spain

Mail: Sales.IA.Iberia@deltaww.com

Delta Electronics (Italy) S.r.l.

Via Meda 2-22060 Novedrate(CO)
Piazza Grazioli 18 00186 Roma Italy
Mail: Sales.IA.Italy@deltaww.com
TEL: +39 039 8900365

Delta Energy System LLC

Vereyskaya Plaza II, office 112 Vereyskaya str.
17 121357 Moscow Russia
Mail: Sales.IA.RU@deltaww.com
TEL: +7 495 644 3240

Delta Greentech Elektronik San. Ltd. Sti. (Turkey)

Şerifali Mah. Hendem Cad. Kule Sok. No:16-A
34775 Ümraniye - İstanbul
Mail: Sales.IA.Turkey@deltaww.com
TEL: + 90 216 499 9910

Eltek Dubai (Eltek MEA DMCC)

OFFICE 2504, 25th Floor, Saba Tower 1,
Jumeirah Lakes Towers, Dubai, UAE
Mail: Sales.IA.MEA@deltaww.com
TEL: +971(0)4 2690148



Digitized Automation for a Changing World

AX-3 Series Operation Manual

AX-3 Series Operation Manual

Revision History

Version	Revision	Date
1 st	The first version was published.	2020/10/30
2 nd	<ol style="list-style-type: none"> Chapter 1 & 2: added information for new products, AX-300NA0PA1, AX-324NA0PA1P and AX-308EA0MA1P. Chapter 4: Updated images of new version DIADesigner-AX software. Added descriptions for new setting page System Setting in section 4.2.1.11. Added Added LocalIIO Fresh Task Delay Time table in section 4.2.2. Added Timing for the Variable to be Cleared to Zero in section 4.3.2.5. Added three new motion control function blocks in the list of Synchronization axes in section 4.4.1.4. Chapter 7: Added velocity axis description in section 7.4.2. Added information of Servo Gear Ratio Setting in section 7.4.2.1. Updated step information and corrected the wording Trapezoid in section 7.4.3. Added new variables for axis group in section 7.5.2. Chapter 8: Updated software images in section 8.2. Deleted information about Matrikon ® FLEX™ OPC UA. Added Setting up an Encrypted Connection with the "UaExpert" . Chapter 9: Added information about Startup Checking and Timeouts in section 9.1.3. Added notes in section 9.3.1.2. 	2021/04/26
3 rd	<ol style="list-style-type: none"> Chapter 2: Product name correction in section 2.2.1. 	2021/05/12
4 th	<ol style="list-style-type: none"> Chapter 1 & 2: Added information for new products: AX-304ELA0PA1T, AX-304ELA0PA1P, AX-316EA0MA1T, AS02PU-A, AS04PU-A, AS02HC-A, Chapter 4: Updated the table in section 4.3.2.5. Added section 4.3.2.6: Timing for the Default Value to be Valid. Update the table in section 4.4.1.4. Added 4.5 Recipe Manager. Updated the content of step 9 in section 8.3.4. Added section 9.4 EtherNet/IP in chapter 9. Appendix A: Updated the content of troubleshooting error code 16#1807 in section A.4.2.2 and added information for new products: AS02HC-A, AS02PU-A and AS04PU-A. 	2021/9/31
5 th	<ol style="list-style-type: none"> Added description of AX-332 and AS02ADH-A module to section 1.1.2. Added information of flammability rating and AX-332 model to chapter 2. Add wiring configuration of new model types to section 2.2.5. Added related information of model AX-332 to chapter 3. Added description of project ID and AX-332 model to 	2022/8/11

Version	Revision	Date
	<p>section 4.2.1.11.</p> <p>5. Added information of settings related to Delta servo system in section 7.4.2.1. Add version information to section 7.6.3.5. Update the software display and relating information in section 7.7.7.6. Add description of axis group limit in section 7.7.8.2.</p> <p>6. Added section 9.1.4 Backup Parameters for EtherCAT Slaves to chapter 9. Update information of values when instance=1. Add section 9.6 FTP Functions.</p>	
6 th	<p>1. Chapter 1: Updated information of program capacity and data capacity in section 1.1.2. Updated the conversion time for analog I/O modules. Added a new type of sensor for AS06RTD-A. Added new product information for AS00SCM-A and AS04SIL-A. Updated the model names of ECAT cables for motion controller from UC-EMCXXX-02A to UC-EMCXXX-02C. Added a table of firmware interoperability in section 1.1.3. Added a table of operating modes supported by AX-3 Motion Controllers in section 1.1.4.</p> <p>2. Chapter 2: Updated the information of ambient air temperature-barometric pressure-altitude in section 2.1. Added information of Ethernet port as well as PROFINET. Updated information of RS485 port, EtherNet/IP and the specification of AX-332EP in section 2.2.1.</p> <p>3. Chapter 4: Added Licensed Software Metrics in section 4.2.1.8. Added options of Apply IP Settings While Download and Retain Settings for System Setting in section 4.2.1.9. Updated contents of Right Settings in section 4.2.1.10. Added a table of firmware interoperability in section 4.2.1.10.1. Updated information of Symbol Rights in section 4.2.1.10.3. Updated the timing for the variable to be cleared to zero in section 4.3.2.5. Updated the timing for the default value to be effective in section 4.3.2.6.</p> <p>4. Chapter 7: Added a new code 1031 for Synchronous axis in section 7.5.1. Added a new function "PlanningPriority" in section 7.5.2. Added SingleAxis mode for transition modes in section 7.7.6.1. Updated DIADesigner-AX operating images. Updated the input range for hardware filter in section 7.7.7.2. Added a description of connecting interfaces for SSI encoders and updated the function of Clock Frequency under General in section 7.7.7.3. Added a description of connecting interfaces for pulse encoders in section 7.7.7.4. Added operating descriptions for AX-332E in section 7.7.7.4. Added a description of pulse output functions in section 7.7.7.6.</p>	2023/5/24

Version	Revision	Date
	<p>5. Chapter 9: Added a compatibility table of firmware version of AX-3 Series PLC CPU and the version of the EtherCAT function library in section 9.1. Added a new section for introducing PROFINET IO in section 9.3.5; removed section 9.6 FTP Functions.</p> <p>6. Added Chapter 10 Convenience Functions.</p> <p>7. Appendix A: Added error LED codes 16#7, 16#8 and 16#D in sections A.2.3 and A.5.1. Changed the name of DL_BuiltInIO_AX3 to DL_BuiltInIO in section A.3.1.</p>	

AX-3 Series Operation Manual

Table of Contents

Chapter 1 Product Introduction

1.1	Overview	1-2
1.1.1	Related Manuals.....	1-2
1.1.2	Models Descriptions.....	1-3
1.1.3	Firmware Interoperability	1-10
1.1.4	Operating Modes Supported by AX-3 Series Motion Controllers	1-11
1.2	DIADesigner-AX Software Overview.....	1-12
1.2.1	Features.....	1-12

Chapter 2 Specifications and System Configurations

2.1	General Specifications	2-2
2.2	CPU Module Specifications	2-4
2.2.1	Functional specifications	2-4
2.2.2	Electrical specifications	2-12
2.2.3	CPU Module Profiles.....	2-14
2.2.4	CPU Module Input/Output Terminals.....	2-20
2.2.5	Wiring Configuration.....	2-22
2.3	Power Supply Module Specifications.....	2-29
2.3.1	General Specifications	2-29
2.3.2	Power Supply Module Profiles	2-29
2.3.3	Power Supply Module Terminals.....	2-30
2.4	Extension Modules	2-32

Chapter 3 Installing Hardware and Getting Started

3.1	Installing Hardware.....	3-2
3.1.1	Installing and Removing a Memory Card	3-2
3.1.2	Installing and Replacing a Button Cell Battery.....	3-3

3.1.3	Installing the AX-3 Series PLC in the Control Cabinet.....	3-5
3.2	Installing and Uninstalling DIADesigner-AX	3-7
3.2.1	Installing DIADesign-AX	3-8
3.2.2	Uninstalling DIADesigner-AX	3-14
3.3	Getting Started and Setting up Communication.....	3-15
3.3.1	Getting Started.....	3-15
3.3.2	Setting up Communication	3-16

Chapter 4 Basic Operation

4.1	Introduction on DIADesigner-AX	4-2
4.1.1	Creating a New Project	4-2
4.2	Setting Items on the Device Page.....	4-4
4.2.1	CPU Parameter Settings.....	4-4
4.2.2	Extension Module Parameter Settings.....	4-31
4.3	Data Type and Variables	4-32
4.3.1	Data Type.....	4-32
4.3.2	Variables	4-33
4.4	Task.....	4-44
4.4.1	Task Configuration	4-44
4.5	Recipe Manager	4-49
4.5.1	Recipe Manager	4-51
4.5.2	Recipe Definition.....	4-53
4.5.3	RecipeManCommand	4-55

Chapter 5 Hardware Configuration

5.1	Environment of Hardware Configuration	5-2
5.2	Add a Module	5-5
5.3	Remove a Module	5-7
5.4	Copy and Paste a Module	5-9
5.4.1	Copy a Module.....	5-9
5.4.2	Paste a Module	5-10

5.5 Cut and Paste a Module	5-11
5.5.1 Cut a Module	5-11
5.5.2 Paste a Module	5-12

Chapter 6 Network Configuration

6.1 Network Configuration	6-2
6.1.1 Introduction	6-2
6.1.2 Basic Knowledge	6-3
6.1.3 Creating a Network Topology.....	6-5

Chapter 7 Motion Control Basic Settings and Operation

7.1 Introduction on Motion Control Instructions	7-5
7.1.1 Motion Control Instructions	7-5
7.1.2 Application Notes on Motion Control Instructions.....	7-5
7.1.3 Categories of Motion Control Instructions.....	7-6
7.2 Creating Motion Control Project.....	7-7
7.2.1 Process Flowchart	7-7
7.2.2 Process for Creating a Project.....	7-8
7.3 Commissioning	7-14
7.3.1 Procedure for Commissioning	7-14
7.3.2 Example of Axis Parameter Settings	7-14
7.3.3 Perform Axes Commissioning	7-16
7.4 Motion Control Device.....	7-19
7.4.1 Overview	7-19
7.4.2 Introduction to Axis.....	7-19
7.4.3 Procedure for Single-axis Configuration	7-29
7.4.4 Axis Group Settings.....	7-36
7.5 Motion Axis Variables	7-44
7.5.1 Variables for Single Axis	7-44
7.5.2 Variables for Axis Group	7-47
7.6 Motion Control Programming.....	7-50
7.6.1 Motion Control Program	7-50
7.6.2 Axis State Transitions	7-54

7.6.3	Execution and Status Indication for Motion Control Instructions.....	7-57
7.6.4	Position	7-67
7.6.5	CAM Tables and Framework.....	7-67
7.7	Motion Control Functions.....	7-72
7.7.1	System Structure.....	7-72
7.7.2	Single-axis Control.....	7-72
7.7.3	Velocity Control	7-90
7.7.4	Torque control	7-92
7.7.5	Common Functions for Single-axis Control	7-93
7.7.6	Axis Group Control.....	7-100
7.7.7	High-speed IO.....	7-105
7.7.8	Other Features	7-145
7.8	Programming Example	7-149
7.8.1	Device Framework	7-149
7.8.2	Examples.....	7-149

Chapter 8 OPC UA Server

8.1	OPC UA Server.....	8-2
8.1.1	Creating a Project for OPC UA Access	8-2
8.2	Setting up a Connection with the “UaExpert” Client	8-4
8.3	Setting up an Encrypted Connection.....	8-8
8.3.1	Setting up User Account and Password	8-8
8.3.2	CODESYS Security Agent	8-9
8.3.3	Setting up an Encrypted Connection with the “Prosys OPC UA Client”	8-12
8.3.4	Setting up an Encrypted Connection with the “UaExpert”	8-15

Chapter 9 Communication

9.1	Introduction to EtherCAT Communication	9-3
9.1.1	Features of EtherCAT Fieldbus	9-3
9.1.2	Settings up EtherCAT Master	9-4
9.1.3	Setting up the EtherCAT Slave.....	9-6
9.1.4	Backup Parameters for EtherCAT Slaves	9-9
9.2	Introduction to Modbus Serial Communication	9-16

9.2.1 Modbus Serial Port	9-16
9.2.2 Modbus Serial Master	9-19
9.2.3 Modbus Serial Slave	9-29
9.3 Introduction to Ethernet Communication.....	9-32
9.3.1 Network Security	9-32
9.3.2 Ethernet	9-32
9.3.3 Modbus TCP Master (Client)	9-37
9.3.4 Modbus TCP Slave (Server)	9-47
9.3.5 PROFINET IO	9-51
9.4 EtherNet/IP.....	9-58
9.4.1 Introduction to EtherNet/IP	9-58
9.4.2 EtherNet/IP Scanner Function	9-61
9.4.3 EtherNet/IP Adapter Function	9-83
9.4.4 CIP Object	9-95
9.4.5 Delta EIP Product List	9-105

Chapter 10 Convenience Functions

10.1 SD Card Functions	10-2
10.1.1 Instructions for Reading/Writing from/to an SD Card	10-2
10.1.2 Startup Command.....	10-6
10.1.3 Backup and Restore EtherCAT Slave Parameters	10-14

Appendix A Troubleshooting

A.1 Troubleshooting	A-2
A.1.1 Basic Troubleshooting Steps	A-2
A.1.2 Clear the Error States	A-2
A.1.3 Troubleshooting SOP	A-3
A.1.4 Viewing Log.....	A-3
A.2 Troubleshooting of CPU Modules	A-6
A.2.1 ERROR LED Indicators Blinking Every 0.5 Seconds	A-6
A.2.2 ERROR LED Indicators Blinking Rapidly Every 0.2 Seconds	A-8
A.2.3 ERROR LED Indicators Slow Blinking Every 3 Seconds and Lighting up for 1 Second.....	A-8
A.2.4 BAT. LOW LED Indicators Are ON	A-8

A.2.5	BAT. LOW LED Indicators Blinking Every 0.5 Seconds.....	A-9
A.2.6	Others.....	A-9
A.3	Troubleshooting of the Function Blocks.....	A-10
A.3.1	DL_BuiltInIO_AX3.....	A-10
A.3.2	Motion Control Related Instructions.....	A-13
A.4	Troubleshooting of I/O Modules.....	A-14
A.4.1	Troubleshooting of Analog Modules (AD/DA/XA) and Temperature Modules (RTD/TC)	A-14
A.4.2	Troubleshooting of Loadcell Modules AS02LC.....	A-16
A.5	Error Codes and LED Indicators for CPU Modules	A-17
A.5.1	Error Codes and LED Indicators for CPU Modules	A-18
A.5.2	Error Codes and LED Indicators for Analog and Temperature Module ..	A-20

Chapter 1 Product Introduction

Table of Contents

1.1	Overview	1-2
1.1.1	Related Manuals	1-2
1.1.2	Models Descriptions.....	1-3
1.1.3	Firmware Interoperability.....	1-10
1.1.4	Operating Modes Supported by AX-3 Series Motion Controllers	1-11
1.2	DIADesigner-AX Software Overview.....	1-12
1.2.1	Features	1-12

1.1 Overview

This manual introduces the AX-3 Series CPU functions, devices, module tables, troubleshooting, and so forth.

1.1.1 Related Manuals

The related manuals for AX-3 Series programmable logic controllers are listed below.

- **AX-3 Series Operation Manual**
This manual introduces CPU functions, devices, module tables, electrical specifications, appearances and dimension, basic concept of motion control, basic configurations, troubleshooting, and so forth.
- **AX-3 Series Quick Start**
This quick start helps you create and use the system in a short time. Besides presenting you with basic system framework, this quick start uses example to demonstrate how to design, write programs, use variables as well as function blocks (FB) and download the PLC program to the PLC. Refer to Appendix A Troubleshooting of AX-3 Series Operation Manual, if any error occurs.
- **AX Series Motion Controller Manual**
This introduces single-axis and multi-axes instructions for programming the AX Series Motion Controllers.
- **AX Series Standard Instructions Manual**
This introduces standard instructions for programming the AX Series Controllers.
- **AS Series Hardware and Operation Manual**
This manual introduces electrical specifications, wirings of CPU modules and modules, appearances, dimensions, and so forth.
- **AS Series Module Manual**
This manual introduces special I/O modules such as network modules, analog I/O modules, temperature measurement modules, and so forth.
- **DIADesigner-AX User Manual**
This manual introduces the use of the software, programming languages, including Ladder Diagram (LD), Sequential Function Chart (SFC), Structured Text (ST), and Function Block Diagram (FBD), as well as Program Organization Unit (POU), tasks and editing techniques for motion control programs.

1.1.2 Models Descriptions

Classification	Model Name	Description
Power Supply Module	AS-PS02	Input: 100-240 VAC, 50/60 Hz Output: 24VDC/2A, 48W (for PLC internal use)
	AS-PS02A	Input: 100-240 VAC, 50/60 Hz Output: 24VDC/1.5A, 36W (for PLC internal use) Output: 24VDC/0.5A, 12W (for external use)
AX-3 Logic Controller CPU Module	AX-300NA0PA1	CPU module, built-in with 2x Ethernet port switches, 1x RS-485, 1x RS-232, 1 USB, Micro SD interface. Program capacity: 8 MB; removable terminal blocks
	AX-324NA0PA1P	CPU module, PNP output, built-in with 16DI (200KHz), 8 DO (200KHz), 2x Ethernet port switches, 1x RS-485, 1x RS-232, 1 USB, Micro SD interface. Program capacity: 8 MB; removable terminal blocks
AX-3 Motion Controller CPU Module	AX-304ELA0PA1T	4-axis motion controller CPU module, NPN output, 16 DI (200KHz), 8 DO (200KHz NPN), 2x Ethernet port switches, 1x EtherCAT, 1x RS-485, 1x RS-232, 1 USB, Micro SD interface. Program capacity: 8 MB; removable terminal blocks
	AX-304ELA0PA1P	4-axis motion controller CPU module, PNP output, 16 DI (200KHz), 8 DO (200KHz NPN), 2x Ethernet port switches, 1x EtherCAT, 1x RS-485, 1x RS-232, 1 USB, Micro SD interface. Program capacity: 8 MB; removable terminal blocks
	AX-308EA0MA1T	8-axis motion controller CPU module, NPN output, 2 X built-in Incremental encoders, 1 X SSI, 16 DI (200KHz), 8 DO (200KHz NPN), 2x Ethernet port switches, 1x EtherCAT, 1x RS-485, 1x RS-232, 1 USB, Micro SD interface. Program capacity: 8 MB; removable terminal blocks
	AX-308EA0MA1P	8-axis motion controller CPU module, PNP output, 2x built-in Incremental encoders, 1x SSI, 16 DI (200KHz), 8 DO (200KHz), 2x Ethernet port switches, 1x EtherCAT, 1x RS-485, 1x RS-232, 1 USB, Micro SD interface. Program capacity: 8 MB; removable terminal blocks
	AX-316EA0MA1T	16-axis motion controller CPU module, NPN output, 2 X built-in Incremental encoders, 1 X SSI, 16 DI (200KHz), 8 DO (200KHz NPN), 2x Ethernet port switches, 1x EtherCAT, 1x RS-485, 1x RS-232, 1 USB, Micro SD interface. Program capacity: 8 MB; removable terminal blocks

1

Classification	Model Name	Description
	AX-332EP0MB1T	32-axis motion controller CPU module, NPN output, 2x built-in Incremental encoders, 1x SSI, 16 DI (200KHz), 6 DO (200KHz NPN), 2x Ethernet port switches, 1x EtherCAT, 1x RS-485, 1x RS-232, 1 USB, Micro SD interface. Program capacity: 128 MB; removable terminal blocks.
	AX-364ELA0MA1T	64-axis motion controller CPU module, NPN output, 2x built-in Incremental encoders, 1x SSI, 16 DI (200KHz), 8 DO (200KHz NPN), 2x Ethernet port switches, 1x EtherCAT, 1x RS-485, 1x RS-232, 1 USB, Micro SD interface. Program capacity: 8 MB; removable terminal blocks
Digital input/output module	AS08AM10N-A	24VDC 5mA 8 inputs Spring-clamp terminal block
	AS08AN01P-A	5 - 30VDC 0.5A/output, 4A/COM 8 outputs Sourcing output Spring-clamp terminal block
	AS08AN01R-A	240VAC/24VDC 2A/output, 8A/COM 8 outputs Relay Spring-clamp terminal block
	AS08AN01T-A	5 - 30VDC 0.5A/output, 4A/COM 8 outputs Sinking output Spring-clamp terminal block
	AS16AM10N-A	24VDC 5mA 16 inputs Spring-clamp terminal block
	AS16AN01P-A	5 - 30VDC 0.5A/output, 4A/COM 16 outputs

Classification	Model Name	Description
		Sourcing output Spring-clamp terminal block
	AS16AN01R-A	240VAC/24VDC 2A/output, 8A/COM 16 outputs Relay Spring-clamp terminal block
	AS16AN01T-A	5 - 30VDC 0.5A/output, 4A/COM 16 outputs Sinking output Spring-clamp terminal block
	AS16AP11P-A	24VDC 5mA 8 inputs 5 - 30VDC 0.5A/output, 4A/COM 8 outputs Sourcing output Spring-clamp terminal block
	AS16AP11R-A	24VDC 5mA 8 inputs 240VAC/24VDC 2A/output, 8A/COM 8 outputs Relay Spring-clamp terminal block
	AS16AP11T-A	24VDC 5mA 8 inputs 5 - 30VDC 0.5A/output, 4A/COM 8 outputs Sinking output Spring-clamp terminal block

1

Classification	Model Name	Description
	AS32AM10N-A	24VDC 3.2mA 32 inputs MIL connector
	AS32AN02T-A	5 - 30VDC 0.1A/output, 3.2A/COM 32 outputs Sinking output MIL connector
	AS64AM10N-A	24VDC 3.2mA 64 inputs MIL connector
	AS64AN02T-A	5 - 30VDC 0.1A/output, 3.2A/COM 64 outputs Sinking output MIL connector
Analog input/output module	AS04AD-A	4-channel analog input module Hardware resolution: 16 bits 0–10V, 0/1–5V, -5 to +5V, -10 to +10V, 0/4–20mA, -20–+20mA Conversion time: 2 ms/channel (upgraded for FW V1.02 or later: 1 ms/channel)
	AS08AD-B	8-channel analog input module Hardware resolution: 16 bits 0 to +10V, 0/1–5V, -5V to +5V, -10V to +10V Conversion time: 2 ms/channel (upgraded for FW V1.02 or later: 1 ms/channel)
	AS08AD-C	8-channel analog input module Hardware resolution: 16 bits 0/4–20mA, -20mA–+20mA Conversion time: 2 ms/channel (upgraded for FW V1.02 or later: 1 ms/channel)
	AS04DA-A	4-channel analog output module Hardware resolution: 12 bits -10 to +10V, 0–20mA, 4–20mA

Classification	Model Name	Description
		Conversion time: 2 ms/channel
	AS06XA-A	4-channel analog input Hardware resolution: 16 bits 0–10V, 0/1–5V, -5 to +5V, -10 to +10V, 0/4–20mA, -20 to +20mA Conversion time: 2 ms/channel 2-channel analog output Hardware resolution: 12 bits -10 to +10V, 0–20mA, 4–20mA Conversion time: 2 ms/channel (upgraded for FW V1.02 or later: 1 ms/channel)
	AS02ADH-A	2-channel analog input Hardware resolution: 16 bits 0–10V, 0/1–5V, -5 to +5V, -10 to +10V, 0/4–20mA, -20 to +20mA High-speed conversion time: 20us max Full isolation, including channel-to-channel isolation A max of 2000 records with peak values and triggering records FIR lowpass and bandpass filter
Temperature measurement module	AS04RTD-A	4-channel, 2-wire/3-wire RTD Sensor type: Pt100 / Ni100 / Pt1000 / Ni1000 / JPt100 / LG-Ni1000 / Cu50 / Cu100 / 0-300Ω / 0-3000Ω Resolution: 0.1°C/0.1°F (16 bits) Conversion time: 200ms/channel
	AS06RTD-A	6-channel, 2-wire/3-wire RTD Sensor type: Pt100 / Ni100 / Pt1000 / Ni1000 / JPt100 / LG-Ni1000 / Cu50 / Cu100 / 0-300Ω / 0-3000Ω / Ni120 (FW V1.06 or later); Resolution: 0.1°C/0.1°F (16 bits) Conversion time: 200ms/channel
	AS04TC-A	4-channel thermocouple Sensor type: J, K, R, S, T, E, N, B and -100 to +100 mV Resolution: 0.1°C/0.1°F (24 bits) Conversion time: 200ms/channel
	AS08TC-A	8-channel thermocouple Sensor type: J, K, R, S, T, E, N, B and -100 to +100 mV Resolution: 0.1°C/0.1°F (24 bits) Conversion time: 200ms/channel
Positioning	AS02PU-A	2-axis motion control

Classification	Model Name	Description
module		5~24VDC, one differential input (A/B/Z phase) with a maximum bandwidth of 200KHz. 24VDC, 5mA, 5 inputs with a maximum bandwidth of 1KHz. 5VDC, 2-axis (4 points) differential input with a maximum bandwidth of 200KHz.
	AS04PU-A	4-axis motion control 24VDC, 5mA, 6 inputs with a maximum bandwidth of 1KHz. 5~30VDC, 0.1A, 4-axis (8 points) NPN output with a maximum bandwidth of 100KHz.
Counter module	AS02HC-A	2 channels high speed counter module Two counting methods available – pulse input (up to 200Hz) and SSI input (up to 1.25Hz). Open collector 4 - point output, 5~30VDC, 0.1A, compatible with high speed comparators.
Load cell module	AS02LC-A	2-channel, 4-wire/6-wire load cell sensor Eigenvalue applicable to a load cell: 1, 2, 4, 6, 20, 40, 80 mV/V Highest accuracy: 0.04% of full-scale ADC Resolution : 24 bits Conversion time: 2.5~400 ms (nine options to choose from)
Network module	AS00SCM-A	Serial communication module, 2x communication ports for communication cards, supporting Modbus protocols
	AS04SIL-A	IO-Link module, built-in with 4 IO-Link communication ports
Programming cable	UC-PRG015-01A (1.5M)	Used for the connection between a PLC and a PC via a mini USB port, use for AS Series CPU modules
	UC-PRG030-01A (3M)	Use for the connection between a PLC and a PC with a mini USB port, use for AS Series CPU modules
	UC-PRG030-20A (3M)	Use for the connection between a PLC and a PC with a RJ45 port, use for AS Series CPU modules and AS-FEN02 function card
I/O extension cable	UC-ET010-24B (1M)	MIL connector, 40Pin ↔ 40Pin, shielded, use for AS32AM10N-A, AS32AN02T-A, AS64AM10N-A and AS64AN02T-A
	UC-ET020-24B (2M)	
	UC-ET030-24B (3M)	
	UC-ET010-24D	MIL connector, 40Pin ↔ 2x 20Pin, shielded, use for AS332T-A,

Classification	Model Name	Description
	(1M) UC-ET020-24D (2M) UC-ET030-24D (3M)	AS332P-A, AS324MT-A, AS32AM10N-A, AS32AN02T-A, AS64AM10N-A, and AS64AN02T-A
External terminal module	UB-10-ID16A	16 inputs/outputs, 20-Pin MIL connector, use for AS332T-A, AS332P-A, AS324MT-A, AS32AM10N-A, AS32AN02T-A, AS64AM10N-A and AS64AN02T-A
	UB-10-ID32A	32 inputs, 40-Pin MIL connector, use for AS32AM10N-A and AS64AM10N-A
	UB-10-IO32D	Terminal block (spring clamp/MIL connector), MIL connector to 40-Pin spring clamp terminal block, use for AS332T-A, AS332P-A, AS324MT-A, AS32AM10N-A, AS32AN02T-A
	UB-10-OR16A	16 relay outputs, 20-Pin MIL connector, NPN, use for AS332T-A, AS32AN02T-A and AS64AN02T-A
	UB-10-OR16B	16 relay outputs, 20-Pin MIL connector, PNP, use for AS332P-A
	UB-10-OT32A	32 transistor outputs, 40-Pin MIL connector, NPN, use for AS32AN02T-A and AS64AN02T-A
ECAT cables for motion controller	UC-EMC003-02C	Ethernet communication cable, 0.3M
	UC-EMC005-02C	Ethernet communication cable, 0.5M
	UC-EMC010-02C	Ethernet communication cable, 1M
	UC-EMC020-02C	Ethernet communication cable, 2M
	UC-EMC050-02C	Ethernet communication cable, 5M
	UC-EMC100-02C	Ethernet communication cable, 10M
	UC-EMC200-02C	Ethernet communication cable, 20M
	UC-EMC003-02B	Ethernet communication cable, 0.3M
	UC-EMC005-02B	Ethernet communication cable, 0.5M
	UC-EMC010-02B	Ethernet communication cable, 1M
	UC-EMC020-02B	Ethernet communication cable, 2M
	UC-EMC030-02B	Ethernet communication cable, 3M
	UC-EMC050-02B	Ethernet communication cable, 5M
	UC-EMC100-02B	Ethernet communication cable, 10M

1.1.3 Firmware Interoperability

The firmware version has been validated to work with the devices listed in the table below.

AX-3 Series PLC CPU Firmware Version	Module Type	Module Name	Module Firmware Version
V1.00.00 and later	Digital I/O Module	AS08AM10N-A	V1.00.00 and later
		AS08AN01P-A	
		AS08AN01R-A	
		AS08AN01T-A	
		AS16AM10N-A	
		AS16AN01P-A	
		AS16AN01R-A	
		AS16AN01T-A	
		AS16AP11P-A	
		AS16AP11R-A	
		AS16AP11T-A	
		AS32AM10N-A	
		AS32AN02T-A	
		AS64AM10N-A	
AS64AN02T-A			
V1.00.00 and later	Analog I/O Module	AS04AD-A	V1.00.00 and later
		AS08AD-B	
		AS08AD-C	
		AS04DA-A	
		AS06XA-A	
V1.00.03 and later		AS02ADH-A	V1.00.00 and later
V1.00.00 and later	Temperature Measurement Module	AS04RTD-A	V1.00.00 and later
		AS06RTD-A	
		AS04TC-A	
		AS08TC-A	
V1.00.00 and later	Load Cell Module	AS02LC-A	V1.06.00 and later
V1.00.01 and later	Positioning Module	AS02PU-A	V1.00.00 and later
		AS04PU-A	
V1.00.01 and later	Counter Module	AS02HC-A	V1.00.00 and later
V1.00.05 and later	Network Module	AS00SCM-A	V2.00.00 and later

1.1.4 Operating Modes Supported by AX-3 Series Motion Controllers

CiA 402 is the device profile for applications of drives and motion controls. The operating modes including Profile Position Mode, Profile Velocity Mode, Cyclic Synchronous Position Mode, Cyclic Synchronous Velocity Mode, and Cyclic Synchronous Position Mode are defined in CiA 402.

Mode	Description	Supported FB
P2P	Design the motions between points to points for slaves. Available CiA 402 operating modes include Profile Position Mode and Profile Velocity Mode.	DL_MotionControlLight
P2P & Synchronized	Design the motions between points to points for slaves and Electronic CAM. Available CiA 402 operating modes include Cyclic Synchronous Position Mode and Cyclic Synchronous Velocity Mode.	SM3_Basic DL_MotionControl
Group	Multi-axes interpolation motions; Available CiA 402 operating modes include Cyclic Synchronous Position Mode.	DL_MotionControl

Model \ Mode	P2P	P2P & Synchronized	Group
AX-304ELA0PA1T/P	Y	N	N
AX-308EA0MA1T/P	Y	Y	Y
AX-316EA0MA1T	Y	Y	Y
AX-332EP0MB1T	Y	Y	Y
AX-364ELA0MA1T	Y	Y	Y

Y = supported

N = not supported

1.2 DIADesigner-AX Software Overview

Conformed to IEC61131-3, DIADesigner-AX is a new programming tool for a new generation Delta PLC. With the abundant applied instructions and an adequate motion function library, DIADesigner-AX provides a friendly and multilingual programming interface for a more convenient and efficient development environment.

1.2.1 Features

DIADesigner-AX is applicable to AX-8 and AX-3 series.

- Support all the programming languages that IEC 61131-3 defines, including LD, SFC, ST, and FBD, as well as POU, tasks and other programming language standard.
- Powerful and proven function library for various applications.
- Input assistance for the input and configuration.
- User-friendly programming with mouse and keyboard in IEC 61131-3 supported programming languages.
- Extensive debugging and online features for the fast optimization of the application code and to speed up testing and commissioning.
- Numerous security features for the protection of the source code and for safeguarding the operation of the controller.
- Programmable devices from different manufacturers.
- The user interface is extendible and adaptable without leaving the framework.
- Transparent internal structures of the development tool and the available components.
- Many seamlessly integrated tools for different kinds of automation tasks.

Two built-in configuration tools:

- Hardware Configuration: the hardware configurations and parameter managements for the system.
- Network Configuration: the network configurations and data exchange management for the system.

Providing various solutions for motion control including PLCopen, MC function block, G-code editor, E-CAM editor, positioning planning chart tool and many more.

- Support PLCopen POUs for single and multi-axis motions
- Support PLCopen POUs for add-on functions, including diagnostics, stop, and CAM controller
- Additional POUs for different tasks including monitoring dynamic data, following error, operating CAMs and CAM controllers
- Integrated graphical CAM editor with loads of configuration options
- Virtual and logical axes are supported.
- Integrated drivers for numerous Modbus and EtherCAT protocols
- Configuration of the drives as standard field devices.

Chapter 2 Specifications and System Configurations

Table of Contents

2.1	General Specifications	2-2
2.2	CPU Module Specifications	2-4
2.2.1	Functional specifications	2-4
2.2.2	Electrical specifications	2-12
2.2.3	CPU Module Profiles.....	2-14
2.2.4	CPU Module Input/Output Terminals.....	2-20
2.2.5	Wiring Configuration.....	2-22
2.3	Power Supply Module Specifications.....	2-29
2.3.1	General Specifications	2-29
2.3.2	Power Supply Module Profiles	2-29
2.3.3	Power Supply Module Terminals.....	2-30
2.4	Extension Modules	2-32

2.1 General Specifications

Item	Specifications
Operating temperature	-20 to 55°C*1; -20~50°C ^(AX-332)
Storage temperature	-40 to 80°C
Operating humidity	5~95% No condensation
Storage humidity	5~95% No condensation
Work environment	No corrosive gas exists.
Installation location	In a control box
Pollution degree	2
Ingress protection (IP ratings)	IP20
EMC Standard (electromagnetic compatibility)	Refer to tables of EMI, EMS and conducted immunity test below.
Vibration resistance	Tested with: 5 Hz ≤ f ≤ 8.4 Hz, constant amplitude 3.5 mm; 8.4 Hz ≤ f ≤ 150 Hz, constant acceleration 1g Duration of oscillation: 10 sweep cycles per axis on each direction of the three mutually perpendicular axes International Standard IEC 61131-2 & IEC 60068-2-6 (TEST Fc)
Shock resistance	Tested with: Half-sine wave: Strength of shock 15 g peak value, 11 ms duration; Shock direction: The shocks in each in direction per axis, on three mutually perpendicular axes (total of 18 shocks) International Standard IEC 61131-2 & IEC 60068-2-27 (TEST Ea)
Safety	Conforms to IEC 61131-2, UL508
Ambient air temperature-barometric pressure-altitude	Operating: 1013 ~ 795hPa (0 ~ 2000 m) Storage:1013 ~ 660hPa (0 ~ 3500 m)
Silicone Flammability Rating	UL94V-0

*1: Leave the AX-3 Series PLC in an environment within the operating temperature for at least one hour to ensure the AX-3 Series PLC temperature is within the operating temperature.

- EMI

Port	Frequency range	Level (Normative)	Reference standard
Enclosure port (radiated) (measured at a distance of 10 meters)	30-230 MHz	40 dB (μV/m) quasi-peak	IEC 61000-6-4
	230-1000 MHz	47 dB (μV/m) quasi-peak	
AC power port (conducted)	0.15-0.5 MHz	79 dB (μV) quasi-peak	IEC 61000-6-4
		66 dB (μV) average	
	0.5-30 MHz	73 dB (μV) quasi-peak	
		60 dB (μV) average	

- EMS

Environmental phenomenon	Reference standard	Test	Test level	
Electrostatic discharge	IEC 61000-4-2	Contact	± 4 kV	
		Air	± 8 kV	
Radio frequency electromagnetic field Amplitude modulated	IEC 61000-4-3	80% AM, 1 kHz sinusoidal	2.0-2.7 GHz	1 V/m
			1.4-2.0 GHz	3 V/m
			80-1000 MHz	10 V/m
Power frequency magnetic field	IEC 61000-4-8	60 Hz	30 A/m	
		50 Hz	30 A/m	

- Conducted immunity test

Environmental phenomenon		Fast transient burst	High energy surge	Radio frequency interference
Reference standard		IEC 61000-4-4	IEC 61000-4-5	IEC 61000-4-6
Interface/Port	Specific interface/port	Test level	Test level	Test level
Data communication	Shielded cable	1 kV	1 kV CM	10 V
	Unshielded cable	1 kV	1 kV CM	10 V
Digital and analog I/O	AC I/O (unshielded)	2 kV	2 kV CM 1 kV DM	10 V
	Analog or DC I/O(unshielded)	1 kV	1 kV CM	10 V
	All shielded lines (to the earth)	1 kV	1 kV CM	10 V
Equipment power	AC power	2 kV	2 kV CM 1 kV DM	10 V
	DC power	2 kV	0.5 kV CM 0.5 kV DM	10 V
I/O power and auxiliary power output	AC I/O and AC auxiliary power	2 kV	2 kV CM 1 kV DM	10 V
	DC I/O and DC auxiliary power	2 kV	0.5 kV CM 0.5 kV DM	10 V

2.2 CPU Module Specifications

2.2.1 Functional specifications

- Logic Controller CPU Module

Type			AX-300NA ^{*1}	AX-324NA ^{*2}
Process time	Execution time	LD instruction	5 nanoseconds (ns)	
		Arithmetic instructions (LREAL data type)	36 nanoseconds (ns)	
Program	Program capacity	Capacity		8 MB
	Variable memory	Retain	Retain	768 KB (device memory (%M) is counted in)
			Persist	128 KB
		Non-retain		16 MB
Device memory (%M)	Size		512 KB	
Ethernet port	Number of ports		2	
	Physical media types		10BASE-T, 100BASE-TX, 1000BASE-T Switch	
	Topology		Star, linear	
	Transmission speed		10, 100, 1000 Mbps	
	Cable		Category 5e or later, 100 meters (Max.)	
	Communication protocol		ARP, IP, TCP, UDP, MODBUS TCP, EtherNet/IP, OPC UA, PROFINET	
USB port	Number of ports		1	
	Type		Mini USB	
RS232 port	Number of ports		1	
	Baud rate		9,600 / 19,200 / 38,400 / 57,600 / 76,800 / 115,200 bps	
	Serial communication format		Stop bit: 1, 2; Parity bit: None, Odd, Even; Data bit: 7, 8	
	Communication protocol		Modbus ASCII/RTU	
RS485 port	Number of ports		1	
	Baud rate		9,600 / 19,200 / 38,400 / 57,600 / 76,800 / 115,200 bps	
	Serial communication format		Stop bit: 1, 2; Parity bit: None, Odd, Even; Data bit: 7, 8	
	Communication protocol		Modbus ASCII/RTU	

Type			AX-300NA ^{*1}	AX-324NA ^{*2}
TCP	Modbus TCP	Maximum number of the connections	32 (Server + Client)	
	SOCKET	Maximum number of the TCP connections		
	Modbus TCP	Maximum data length per connection	100 words	
	SOCKET	Maximum data length per instruction	8 KB	

Type			AX-300NA ^{*1}	AX-324NA ^{*2}
EtherNet/IP	CIP IO Connection	Maximum number of the Scanner connections	12	
		Maximum number of the Adapter connections	1	
		Requested Packet Interval (RPI)	20 ~ 1,000 ms (unit: 1 ms)	
		Maximum Transmission Speed	2,200 pps	
		Maximum data length per connection	Input: 509 bytes (T → O) Output: 505 bytes (O → T) O: Originator T: Target	
	CIP Explicit Message	Number of Connections	12	
		UCMM	Yes	
		Class 3 / UCMM	Get_Attribute_Single (FB) Get_Attributes_All (FB) Set_Attribute_Single (FB) Set_Attributes_All (FB)	
		CIP objects supported	Identity, Message Router, Assembly, Connection, Manager, Port, TCP/IP interface, Ethernet link, Vendor specific	
	OPC UA server	Supported profiles and models		PLCopen and OPC Foundation: OPC UA Information Model for IEC 61131-3
Endpoints and connecting ports		TCP: 4840 (Reconfigurable via configuration file)		
Maximum number of sessions (Client)		5		
Maximum number of monitored items per server		1000		
Sampling rate of the monitored items (ms)		100, 300, 500, 1000, 2500, 5000		

2

Type		AX-300NA*1	AX-324NA*2
OPC UA server	Maximum number of subscriptions per server		100
	Maximum number of variables that can be published		10,000
	Maximum number of value attributes that can be published		10,000
	Maximum number of structure definitions that can be published		100
	Conditions that can not be published for each network-published variable		<ul style="list-style-type: none"> ● More than three dimensional arrays ● Array of Array ● The OPC UA Stack will limit messages to about 300 kB. This is the maximum for values too. ● Pointer variables, Interface variables ● Structures containing pointers and interfaces
	Security mode and policy		None Sign - Basic256Sha256 SignAndEncrypt - Basic256Sha2566
	Application authentication	Authentication	X.509
		Number of certificates that can be stored	Trusted applications: 32 Issuer certificates: 32 Rejected applications: 32
User authentication	Method of user authentication	User name / password / Anonymous	
PROFINET	Max. IO Slot Supported		64
	Minimum Time for Data Exchange to Operate		1 ms
	Maximum Data Length/Per Transmission		Input: 1440 bytes Output: 1440 bytes
IO configuration	Number of IO extension modules supported		32
	I/O capacity		IN: 8,192byte OUT: 8,192byte
	Built-in IO	High speed counter	- 6 (200 KHz)
		PWM	- 8 (200 KHz)
Memory card	SD card type		Micro SD (SDHC, 32GB max.)
Real-time clock	Year, Month, Date, Hour, Minute, Second, Week		One CR1620 battery is required.

*1 : AX-300NA represents model AX-300NA0PA1

*2 : AX-324NA represents model AX-324NA0PA1P

● Motion Controller CPU Module

Type			AX-304 EL *1	AX-308 EA*2	AX-316 EA*3	AX-364 EL *4	AX-332E P *5	
Process time	Execution time	LD instruction	5 nanoseconds (ns)				1.6 ns	
		Arithmetic instructions (LREAL data type)	36 nanoseconds (ns)				1.6 ns	
Program	Program capacity	Capacity		8 MB			128 MB	
	Variable memory	Retain tive	Retain	768 KB (device memory (%M) is counted in)			1.5 MB (device memory included %M)	
			Persist	128 KB			512 KB	
		Non-retainitive		16 MB			256 MB	
	Device memory (%M)	Size		512 KB				
Motion control	Number of controlled axes	Maximum number of controlled axes		4 axes	16 axes	32 axes	64 axes	32 axes
		EtherCAT axes		4 axes	8 axes	16 axes	4 axes	32 axes
		Pulse Out axes		-	4 axes			1 axes
		Maximum number of axes for linear interpolation axis control		-	6 axes			
		Maximum number of axes for circular interpolation axis control		-	2 axes			
	Maximum number of axes groups			-	8 groups			16 groups
	Motion control period			The same control period as that is used for the process data communications cycle for EtherCAT.				
	CAM	Number of CAM data points	Max. points per CAM table	-	256 points			32,767 points

			Max. points for all CAM tables	-	20,480 points	655,340 points
			Maximum number of CAM tables	-	80	160
Ethernet port	Number of ports		2			
	Physical media types		10BASE-T, 100BASE-TX, 1000BASE-T Switch		IEEE 802.3/802.3u/802.3ab 1G bps (Intel I210IT)	
	Topology		Star, linear			
	Transmission speed		10, 100, 1000 Mbps			
	Cable		Category 5e or later, 100 meters (Max.)			
	Communication Protocols		ARP, IP, TCP, UDP, Modbus TCP, EtherNet/IP, OPC UA, PROFINET			
USB port	Number of ports		1			
	Type		Mini USB		USB 2.0 (0.5A)	
RS232 port	Number of ports		1			
	Baud rate		9,600 / 19,200 / 38,400 / 57,600 / 76,800 / 115,200 bps			
	Serial communication format		Stop bit: 1, 2; Parity bit: None, Odd, Even; Data bit: 7, 8			
	Communication protocol		Modbus ASCII/RTU			
RS485 port	Number of ports		1			
	Baud rate		9,600 / 19,200 / 38,400 / 57,600 / 76,800 / 115,200 bps			
	Serial communication format		Stop bit: 1, 2; Parity bit: None, Odd, Even; Data bit: 7, 8			
	Communication protocol		Modbus ASCII/RTU			
EtherCAT port	EtherCAT Master		Class B			
	Physical media types		100BASE-TX		IEEE 802.3/802.3u/802.3ab 1G bps (Intel I210IT)	

	Transmission speed		100 Mbps				
	Topology		Line, daisy chain, and branching				
	Cable		Category 5e or later, 100 meters (Max.)				
	Maximum number of Slaves		16	64	64	96	256
	Transmission cycle		2,000 μ s ~ 32,000 μ s (only AX-332 can set the unit to 250 μ s)				
TCP	Modbus TCP	Maximum number of the connections	32 (Server + Client)				
	SOCKET	Maximum number of the TCP connections					
	Modbus TCP	Maximum data length per connection	100 words				
	SOCKET	Maximum data length per instruction	8 KB				
EtherNet/IP	CIP IO Connection	Number of adapter to be connected	8				
		Maximum number of the CIP connections (Scanner)	12				
		Maximum number of the CIP connections (Adapter)	1				
		Requested Packet Interval (RPI)	20 ~ 1,000ms (unit: 1 ms)				
		Maximum Transmission Speed	2,200 pps				
		Maximum data length per connection	Input: 509 bytes (T \rightarrow O) Output: 505 bytes (O \rightarrow T) O: Originator T: Target				
	CIP Explicit Message	Number of Connections	12				
		UCMM	Yes				

2

		Class 3 / UCMM	Get_Attribute_Single (FB) Get_Attributes_All (FB) Set_Attribute_Single (FB) Set_Attributes_All (FB)
		CIP objects supported	Identity, Message Router, Assembly, Connection Manager, Port, TCP/IP interface, Ethernet link, Vendor specific
OPC UA server	Supported profiles and models		PLCopen and OPC Foundation: OPC UA Information Model for IEC 61131-3
	Endpoints and connecting ports		TCP: 4840 (Reconfigurable via configuration file)
	Maximum number of sessions (Client)		5
	Maximum number of monitored items per server		1000
	Sampling rate of the monitored items (ms)		100, 300, 500, 1000, 2500, 5000
	Maximum number of subscriptions per server		100
	Maximum number of variables that can be published		10,000
	Maximum number of value attributes that can be published		10,000
	Maximum number of structure definitions that can be published		100
	Conditions that can not be published for each network-published variable		<ul style="list-style-type: none"> ● More than three dimensional arrays ● Array of Array ● The OPC UA Stack will limit messages to about 300 kB. This is the maximum for values too. ● Pointer variables, Interface variables ● Structures containing pointers and interfaces
	Security mode and policy		None Sign - Basic256Sha256 SignAndEncrypt - Basic256Sha2566
	Application authentication	Authentication	X.509
		Number of certificates that can be stored	Trusted applications: 32 Issuer certificates: 32 Rejected applications: 32
User authentication	Method of user authentication	User name / password / Anonymous	
PROFINET	Max. IO Slot Supported		64
	Minimum Time for Data Exchange to Operate		1 ms

	Maximum Data Length/Per Transmission	Input: 1440 bytes Output: 1440 bytes			
IO configuration	Number of IO extension modules supported	32			
	I/O capacity	Input: 8,192byte Output: 8,192byte			
	Built-in IO	Encoder	-	2	1
		SSI	-	1	
		High speed counter	6 (200 KHz)		
		Pulse out	-	4 (200 KHz)	1 (200 KHz)
		PWM	8 (200 KHz)		4 (200 KHz)
Memory card	SD card type	Micro SD (SDHC, 32GB max.)		Micro SD (SD3.0/S DR50/SDXC)	
Real-time clock	Year, Month, Date, Hour, Minute, Second, Week	One CR1620 battery is required.			

*1: AX-304EL includes model AX-304ELA0PA1T and AX-304ELA0PA1P.

*2: AX-308EA includes model AX-308EA0MA1T and AX-308EA0MA1P.

*3: AX-316EA represents model AX-316EA0MA1T.

*4: AX-364EL represents model AX-364ELA0MA1T.

*5: AX-332EP represents model AX-332EP0MB1T.

*6: Except for AX-332, other AX series models are only applicable to a commercially available CR1620 3V battery. For model AX-332EP, please contact your local agents for batteries and accessories.

EtherCAT axes include positioning axes and synchronization axes. The maximum number of the axes are listed below.

Model \ Item	Maximum number of positioning axes	Maximum number of synchronization axes	Maximum number of positioning and synchronization axes
AX-304EL *1	4	-	4
AX-308EA *2	8	8	8
AX-316EA *3	16	16	16
AX-364EL *4	64	8	64
AX-332EP *5	32	32	32

*1: AX-304EL includes model AX-304ELA0PA1T and AX-304ELA0PA1P.

*2: AX-308EA includes model AX-308EA0MA1T and AX-308EA0MA1P.

*3: AX-316EA represents model AX-316EA0MA1T.

*4: AX-364EL represents model AX-364ELA0MA1T.

*5: AX-332EP represents model AX-332EP0MB1T.

2.2.2 Electrical specifications

Item	Model			
	AX-300NA0PA1	AX-304ELA0PA1T/P AX-324NA0PA1P	AX-308EA0MA1T/P AX-316EA0MA1T AX-364ELA0MA1T	AX-332EP0MB1T
Supply voltage	24 VDC (20.4 VDC~28.8 VDC) (-15%~+20%)			
Power consumption (W)	4	5	11	24
Weight (g)	240	300	380	390

- Electrical specifications for the inputs on digital input/output module. The signals passing through the inputs are 24 VDC signals.

Item	Model	
	AX-304ELA0PA1T/P, AX-308EA0MA1T/P, AX-316EA0MA1T, AX-324NA0PA1P, AX-364ELA0MA1T	AX-332EP0MB1T
Number of inputs	16	6
Connector type	Removable terminal blocks	
Input type	Digital input	
Input form	Direct current (sinking or sourcing)	
Input voltage/ current	24 VDC, 5 mA	
Action level	OFF→ON	>15 VDC
	ON→OFF	<5 VDC
Response time	OFF→ON	2.5 μs
	ON→OFF	5 μs
Maximum input frequency	200KHz	
Input impedance	5.6 kΩ	
Input electrical isolation	optocoupler	
Input display	When the optocoupler is driven, the input LED indicator is ON.	

- Electrical specifications for the outputs on digital input/output module.

Item		Model	AX-304ELA0PA1T AX-308EA0MA1T AX-316EA0MA1T AX-364ELA0MA1T	AX-304ELA0PA1P AX-308EA0MA1P AX-324NA0PA1P	AX-332EP0MB1T
Number of outputs		8			6
Connector type		Removable terminal blocks			
Output form		NPN (Sinking)	PNP (Sourcing)		N-MOS
Voltage		5~30VDC			24 VDC (-15% ~ +20%)
Maximum load	Resistance	0.1A/output			
	Inductance	-			
	Bulb	-			
Maximum output frequency*1		200 KHz			
Maximum Response time	OFF→ON	2.5 μs			

2.2.3 CPU Module Profiles

- AX-300NA0PA1

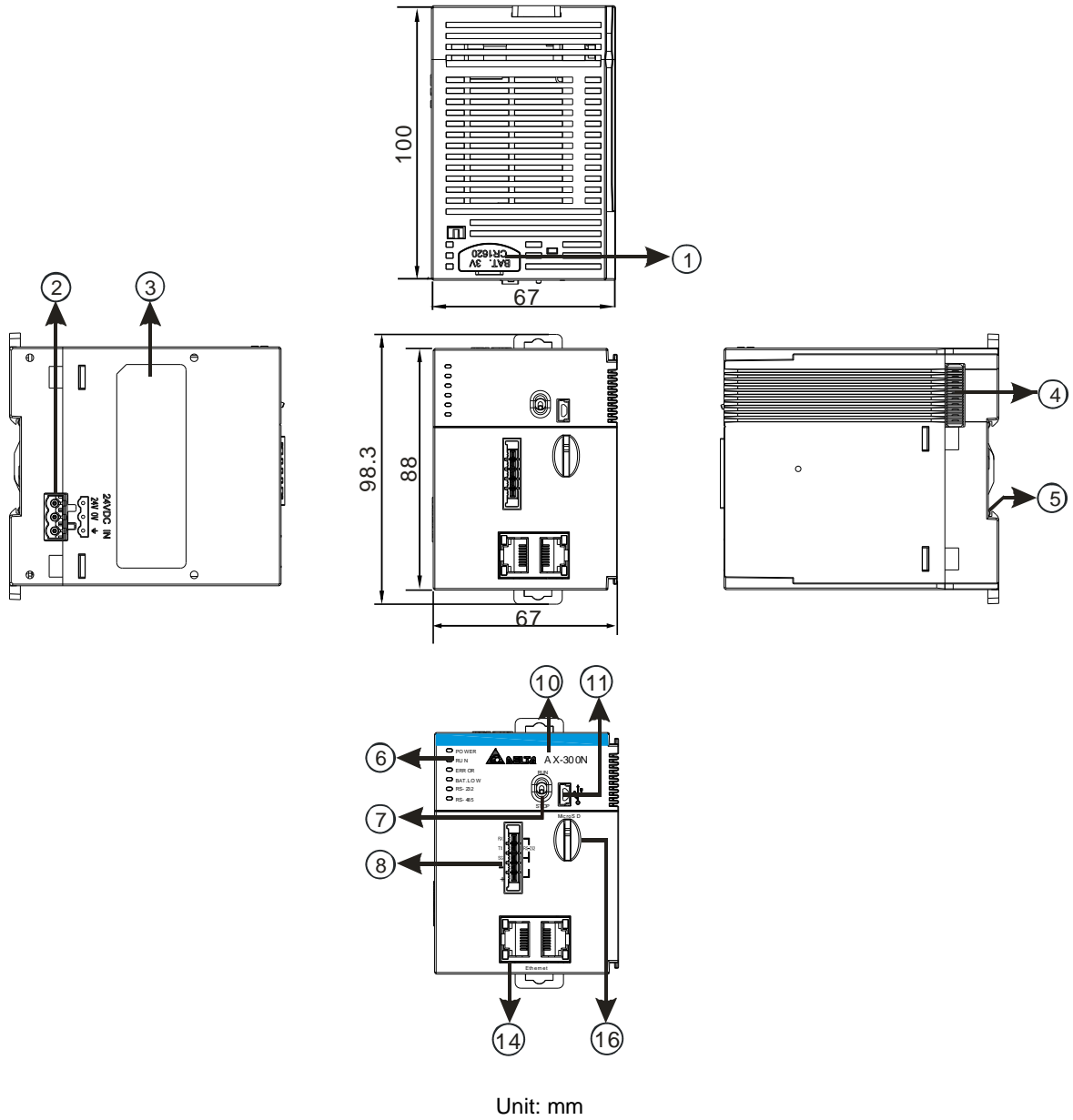

• AX-304ELA0PA1T / AX-304ELA0PA1P

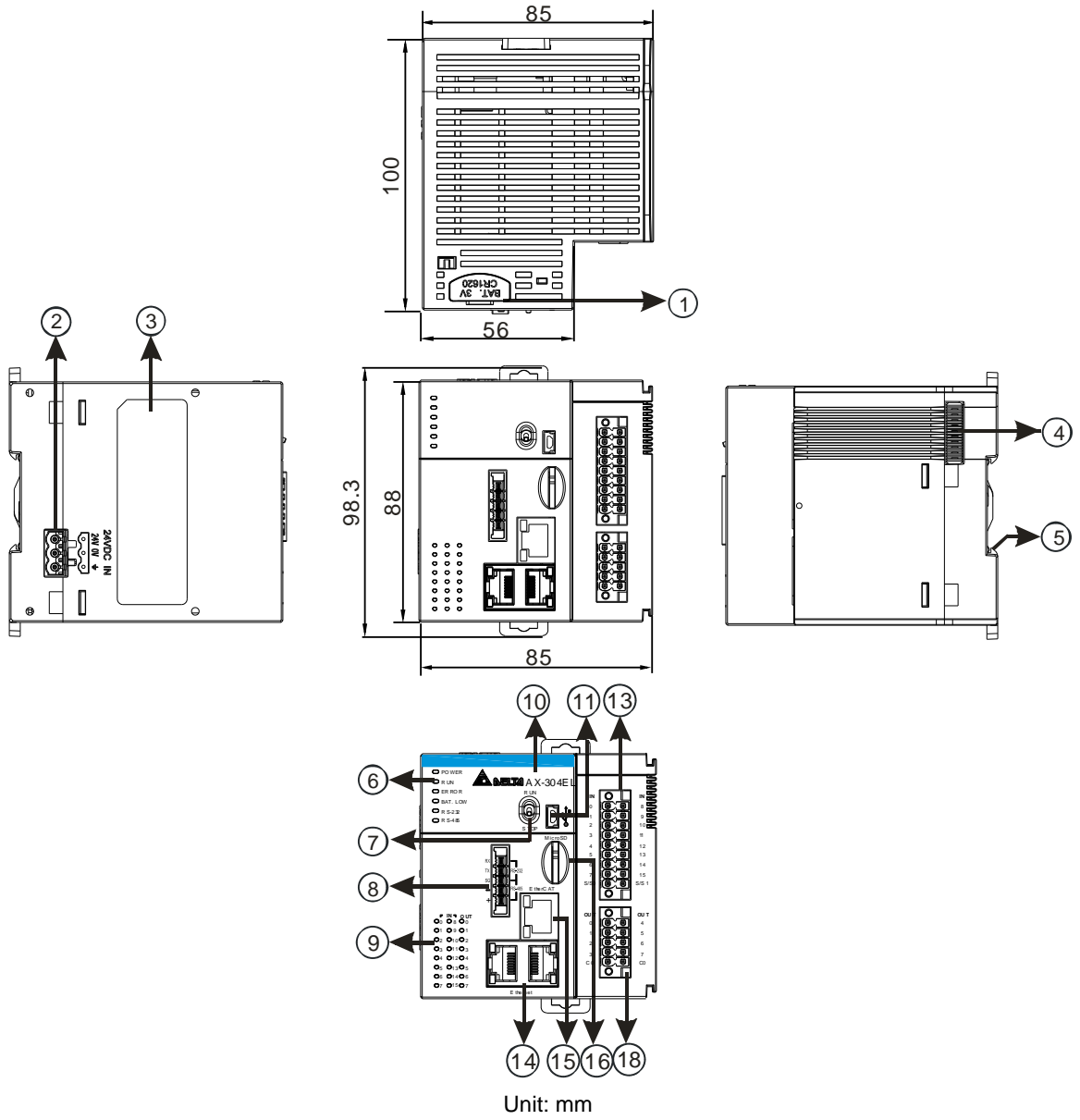

- AX-308EA0MA1T / AX-308EA0MA1P / AX-316EA0MA1T / AX-364ELA0MA1T

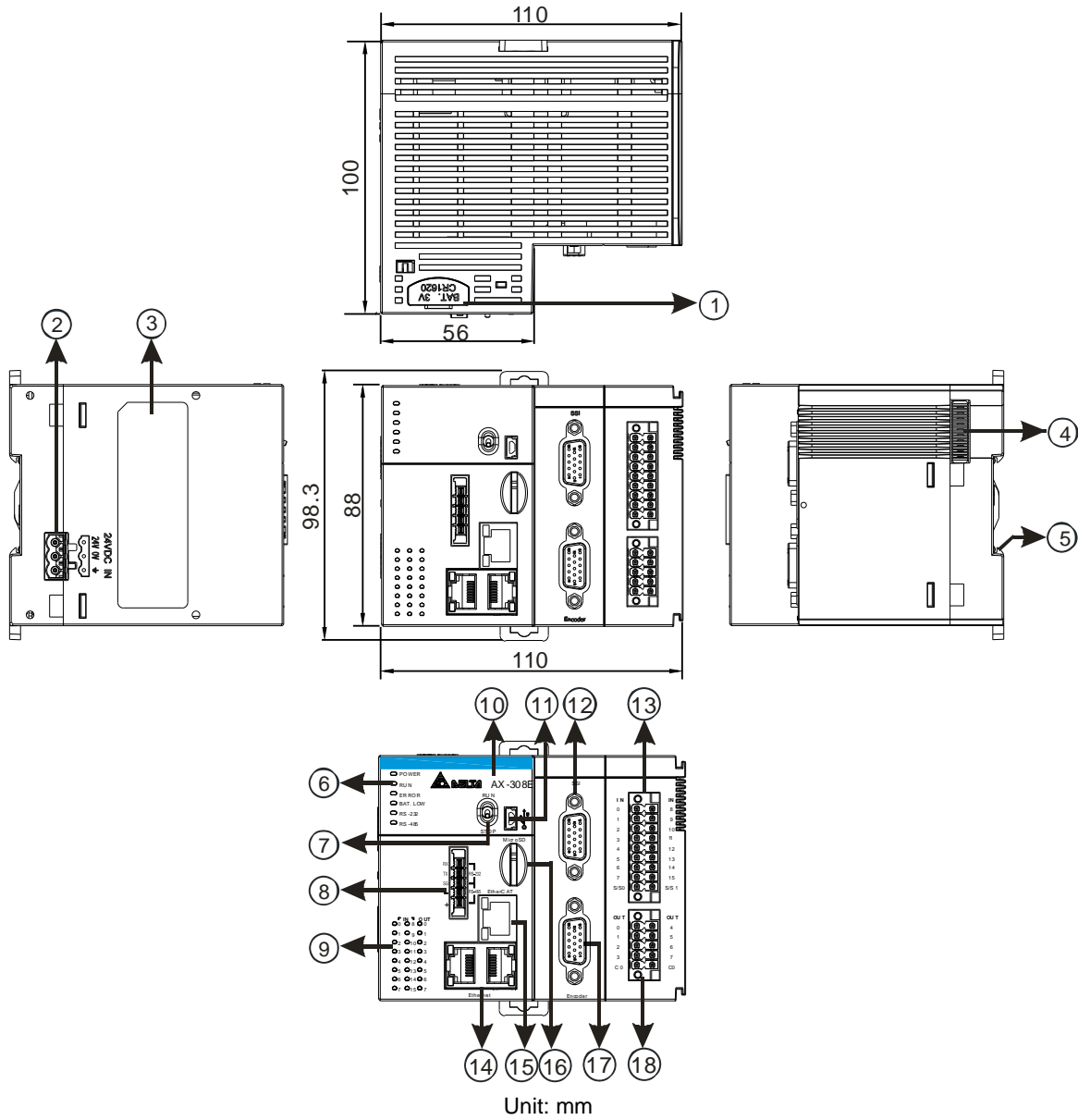

● AX-324NA0PA1P

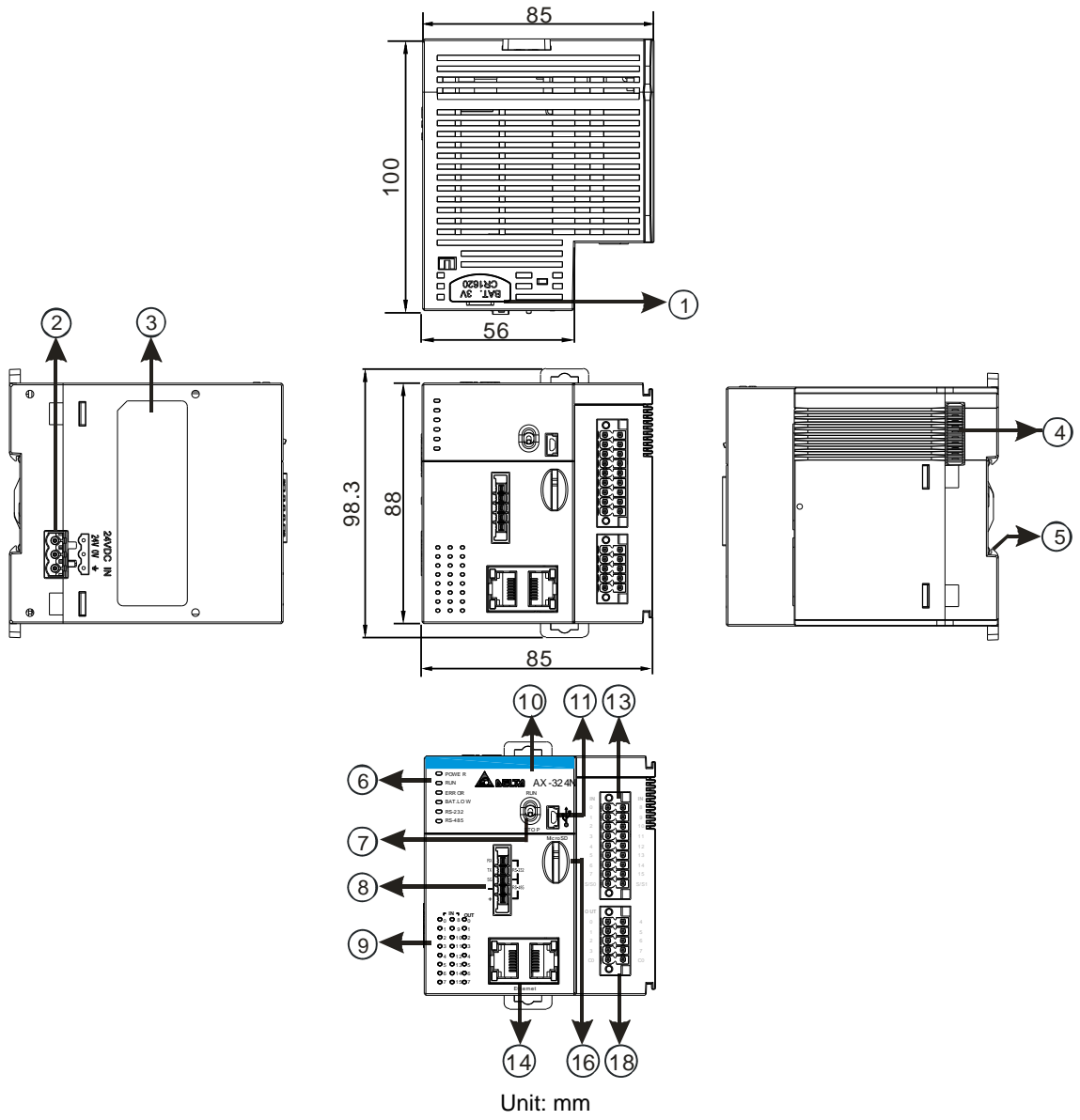

• AX-332EP0MB1T

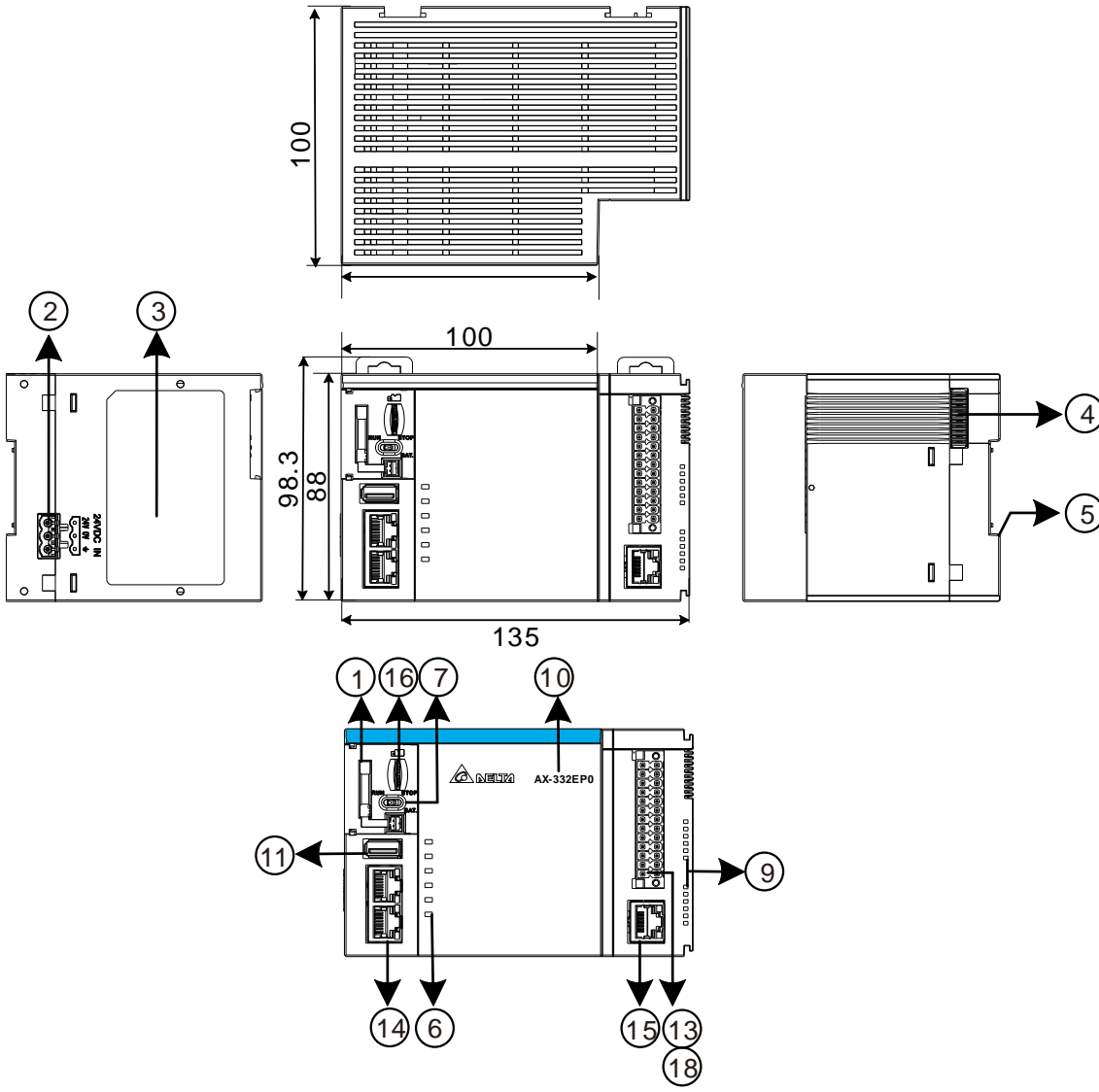

Unit: mm

Number	Name	Description
1	Battery holder	A case for holding a battery (not enclosed) for the real-time clock function
2	Power supply	For power supply
3	Label	Nameplate
4	External module port	Connects the modules
5	Grounding clip	For grounding
6	Power LED indicator	Indicates the power status of the CPU module
	Run LED indicator	Operating status of the CPU module ON: the module is running. OFF: the module is stopped. Blinking: the module is detecting an error.
	Error LED indicator	Error status of the module ON: a serious error occurs in the module. OFF: the module is normal. Blinking: a minor error occurs in the module.

Number	Name	Description
	BAT.LOW LED indicator	Indicates the battery status of the CPU module.
	COM1 LED COM2 LED	Indicates the communication status of the COM port. OFF: no communication over the COM port Blinking: communication over the COM port
	FB1 LED FB2 LED	Indicates the communication status of the FB port. FB1 OFF: no communication over ECAT. FB1 blinking: normal communication over ECAT. FB2 OFF: no communication over CAN bus. FB2 blinking: normal communication over CAN bus.
7	Run/Stop	RUN: execute the programs STOP: stop the programs
8	COM Port	Provides an interface for RS-485 and RS-232 communication
9	Input/Output LED indicator	If there is an input signal, the input LED indicator is ON. If there is an output signal, the output LED indicator is ON.
10	Model name	Shows the model name of the CPU module.
11	USB Port	AX-3 Series (except for AX-332): Mini USB communication port AX-332: USB 2.0 port
12	SSI Port	SSI Encoder communication port
13	Input Terminals	For input wiring
14	Ethernet Port	Ethernet Switch communication port LINK indicator (Green): <ul style="list-style-type: none"> ■ LED ON: The network connection is established. ■ LED OFF: The network connection is NOT established. ACT indicator (Orange): <ul style="list-style-type: none"> ■ LED blinking: Data transmission (sending/receiving) ■ LED OFF: No data transmission
15	EtherCAT Port	EtherCAT communication port LINK indicator (Green): <ul style="list-style-type: none"> ■ LED ON: The network connection is established. ■ LED OFF: The network connection is NOT established. ACT indicator (Orange): <ul style="list-style-type: none"> ■ LED blinking: Data transmission (sending/receiving) ■ LED OFF: No data transmission
16	SD Card Slot	Provides an interface for an SD card
17	Encoder Port	Incremental encoder communication port
18	Output Terminals	For output wiring

2.2.4 CPU Module Input/Output Terminals

AX-304ELA0PA1T / AX-304ELA0PA1P																																	
<p>The diagram shows the front panel of the AX-304ELA0PA1T / AX-304ELA0PA1P CPU module. It includes a status indicator section with LEDs for POWER, RUN, ERROR, BAT. LOW, RS-232, and RS-485. There are also buttons for STOP and RUN, and a USB port. Connectors include Micro SD, RS-232 (TX, RX, SG), RS-485, EtherCAT, Ethernet, and two sets of 16-pin D-sub connectors labeled IN (S/S0 to S/S1) and OUT (C0).</p>	<table border="1"> <thead> <tr> <th colspan="2">IN</th> </tr> </thead> <tbody> <tr><td>0</td><td>8</td></tr> <tr><td>1</td><td>9</td></tr> <tr><td>2</td><td>10</td></tr> <tr><td>3</td><td>11</td></tr> <tr><td>4</td><td>12</td></tr> <tr><td>5</td><td>13</td></tr> <tr><td>6</td><td>14</td></tr> <tr><td>7</td><td>15</td></tr> <tr><td>S/S0</td><td>S/S1</td></tr> <tr> <th colspan="2">OUT</th> </tr> <tr><td>0</td><td>4</td></tr> <tr><td>1</td><td>5</td></tr> <tr><td>2</td><td>6</td></tr> <tr><td>3</td><td>7</td></tr> <tr><td>C0</td><td>C0</td></tr> </tbody> </table>	IN		0	8	1	9	2	10	3	11	4	12	5	13	6	14	7	15	S/S0	S/S1	OUT		0	4	1	5	2	6	3	7	C0	C0
	IN																																
	0	8																															
	1	9																															
	2	10																															
	3	11																															
	4	12																															
	5	13																															
	6	14																															
	7	15																															
	S/S0	S/S1																															
	OUT																																
	0	4																															
	1	5																															
	2	6																															
	3	7																															
C0	C0																																

AX-308EA0MA1T / AX-308EA0MA1P / AX-316EA0MA1T / AX-364ELA0MA1T																																																																	
<p>The diagram shows the front panel of the AX-308EA0MA1T / AX-308EA0MA1P / AX-316EA0MA1T / AX-364ELA0MA1T CPU module. It includes a status indicator section with LEDs for POWER, RUN, ERROR, BAT. LOW, RS-232, and RS-485. There are also buttons for STOP and RUN, and a USB port. Connectors include Micro SD, RS-232 (TX, RX, SG), RS-485, EtherCAT, Ethernet, two sets of 16-pin D-sub connectors labeled IN (S/S0 to S/S1) and OUT (C0), and two sets of 15-pin D-sub connectors labeled SSI and Encoder.</p>	<table border="1"> <thead> <tr> <th>SSI</th> <th>ENCNDOR</th> <th colspan="2">IN</th> </tr> </thead> <tbody> <tr><td>1</td><td>DATA+</td><td>X0.0</td><td>X0.8</td></tr> <tr><td>2</td><td>DATA-</td><td>X0.1</td><td>X0.9</td></tr> <tr><td>6</td><td>CLK+</td><td>X0.2</td><td>X0.10</td></tr> <tr><td>14</td><td>CLK-</td><td>X0.3</td><td>X0.11</td></tr> <tr><td>8</td><td>GND</td><td>X0.4</td><td>X0.12</td></tr> <tr><td>15</td><td>5V</td><td>X0.5</td><td>X0.13</td></tr> <tr><td></td><td>+5V1</td><td>X0.6</td><td>X0.14</td></tr> <tr><td></td><td>A2+</td><td>X0.7</td><td>X0.15</td></tr> <tr><td></td><td>A2-</td><td>S/S0</td><td>S/S1</td></tr> <tr> <td></td> <td>B2+</td> <th colspan="2">OUT</th> </tr> <tr><td></td><td>B2-</td><td>Y0.0</td><td>Y0.4</td></tr> <tr><td></td><td>Z2+</td><td>Y0.1</td><td>Y0.5</td></tr> <tr><td></td><td>Z2-</td><td>Y0.2</td><td>Y0.6</td></tr> <tr><td></td><td>+5V2</td><td>Y0.3</td><td>Y0.7</td></tr> <tr><td></td><td>0V</td><td>C0</td><td>C0</td></tr> </tbody> </table>	SSI	ENCNDOR	IN		1	DATA+	X0.0	X0.8	2	DATA-	X0.1	X0.9	6	CLK+	X0.2	X0.10	14	CLK-	X0.3	X0.11	8	GND	X0.4	X0.12	15	5V	X0.5	X0.13		+5V1	X0.6	X0.14		A2+	X0.7	X0.15		A2-	S/S0	S/S1		B2+	OUT			B2-	Y0.0	Y0.4		Z2+	Y0.1	Y0.5		Z2-	Y0.2	Y0.6		+5V2	Y0.3	Y0.7		0V	C0	C0
	SSI	ENCNDOR	IN																																																														
	1	DATA+	X0.0	X0.8																																																													
	2	DATA-	X0.1	X0.9																																																													
	6	CLK+	X0.2	X0.10																																																													
	14	CLK-	X0.3	X0.11																																																													
	8	GND	X0.4	X0.12																																																													
	15	5V	X0.5	X0.13																																																													
		+5V1	X0.6	X0.14																																																													
		A2+	X0.7	X0.15																																																													
		A2-	S/S0	S/S1																																																													
		B2+	OUT																																																														
		B2-	Y0.0	Y0.4																																																													
		Z2+	Y0.1	Y0.5																																																													
		Z2-	Y0.2	Y0.6																																																													
		+5V2	Y0.3	Y0.7																																																													
	0V	C0	C0																																																														

AX-324NA0PA1P

IN	
0	8
1	9
2	10
3	11
4	12
5	13
6	14
7	15
S/S0	S/S1
OUT	
0	4
1	5
2	6
3	7
C0	C0

2

AX-332EP0MB1T

ENCODER			
1	TX+	2	TX-
3	SG	4	SG
5	RX+	6	RX-
7	A+	8	A-
9	B+	10	B-
11	Z+	12	Z-
13	IN 0	14	OUT 0
15	IN 1	16	OUT 1
17	IN 2	18	OUT 2
19	IN 3	20	OUT 3
21	IN 4	22	OUT 4
23	IN 5	24	OUT 5
25	S/S	26	C0

2.2.5 Wiring Configuration

Attentions for wiring:

1. When connect high-speed inputs of AX series PLCs with (NPN / PNP) open connector outputs, we would suggest to add (pull-up/ pull-down) parallel resistors between the specified Input point and S/S. For resistors, we suggest you to use 3W/470ohm or 2W/1Kohm resistors.
2. If using push-pull outputs to connect high-speed inputs of AX series PLCs, parallel resistors would not be required.

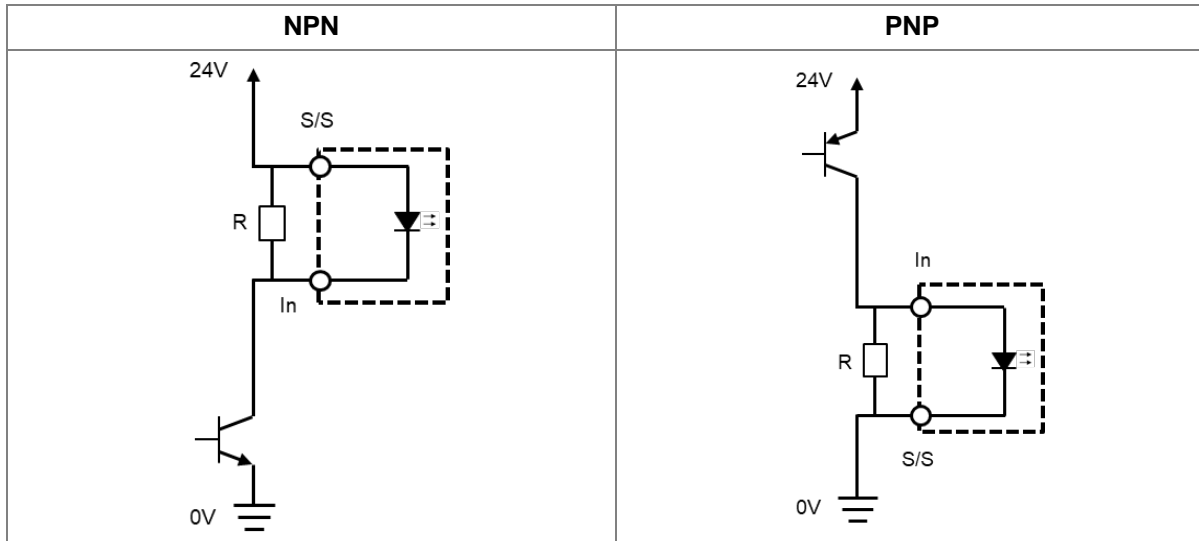

2.2.5.1 AX-304ELA0PA1T Wiring

Input Type	Direct current (Sinking or Sourcing)
Input voltage/Current	24VDC, 5mA
Output Type	Sinking transistors
Output voltage/Current	5~30VDC, 0.1A

- Please find section 2.2.5.3 for wiring specification of high-speed counters.
- Normal I/O Wiring

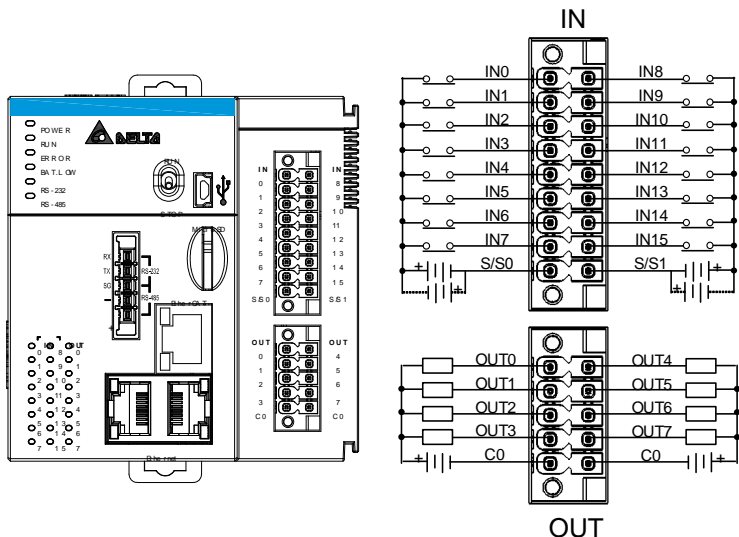

2.2.5.2 AX-304ELA0PA1P Wiring

Input Type	Direct current (Sinking or Sourcing)
Input voltage/Current	24VDC, 5mA
Output Type	Sourcing transistors
Output voltage/Current	5~30VDC, 0.1A

- Please find section 2.2.5.3 for wiring specification of high-speed counters.
- General I/O Wiring

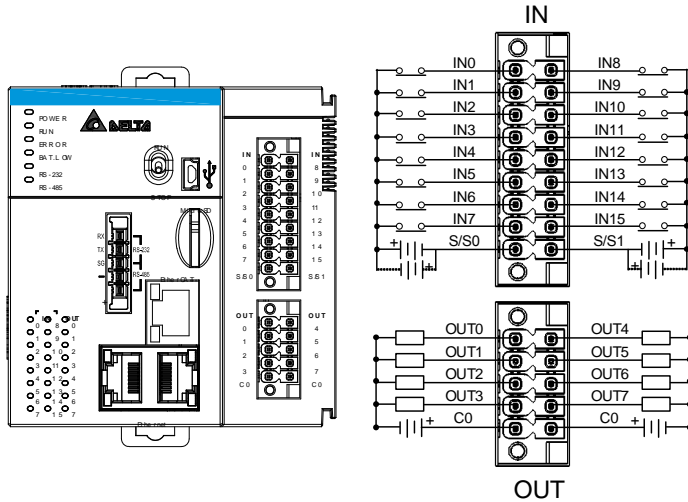

2.2.5.3 AX-308EA0MA1T / AX-316EAMA1T / AX-364ELA0MA1T Wiring

Input Type	IN0~IN15: Direct current (Sinking or Sourcing)
Input voltage/Current	IN0~IN15: 24VDC, 5mA
Output Type	Out0~Out7: Sinking transistors
Output voltage/Current	Out0~Out7 : 5~30VDC, 0.1A

- SSI Wiring

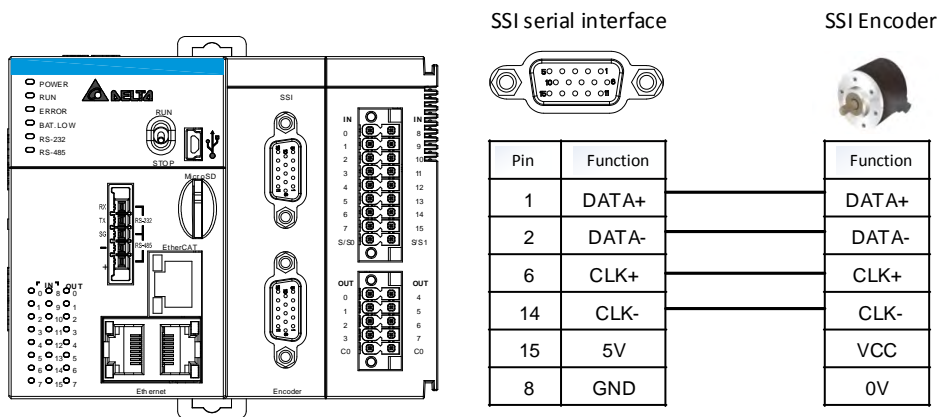

***Note:** A 5V power supply is provided to SSI interface.

When VCC = 5V, SSI encoder power supply voltage(VCC) can be connected to pin 15 on the SSI interface as well as connecting encoder 0V terminal to Pin8 on the SSI interface. If VCC ≠ 5V, please supply power to the SSI encoder separately based on the actual power voltage of the encoder.

● Encoder Wiring

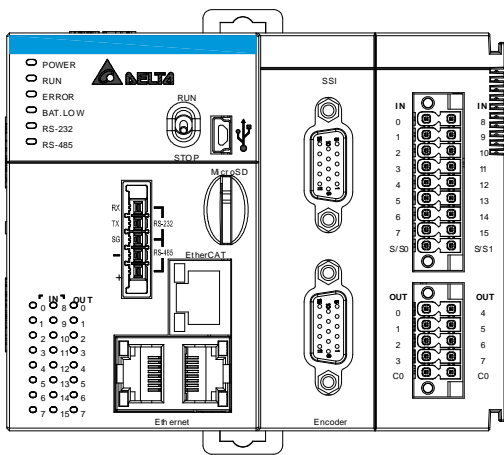

Encoder interface

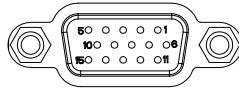

Encoder



Pin	Function	Function
1	A1+	A
2	A1-	\bar{A}
10	B1+	B
11	B1-	\bar{B}
4	Z1+	Z
5	Z1-	\bar{Z}
15	5V	VCC
8	GND	0V

***Note:** A 5V power supply is provided to Encoder interface.

When VCC = 5V, encoder power supply voltage(VCC) can be connected to pin 15 on the SSI interface as well as connecting encoder 0V terminal to Pin8 on the SSI interface. If VCC ≠ 5V, please supply power to the SSI encoder separately based on the actual power voltage of the encoder.

● General Wiring

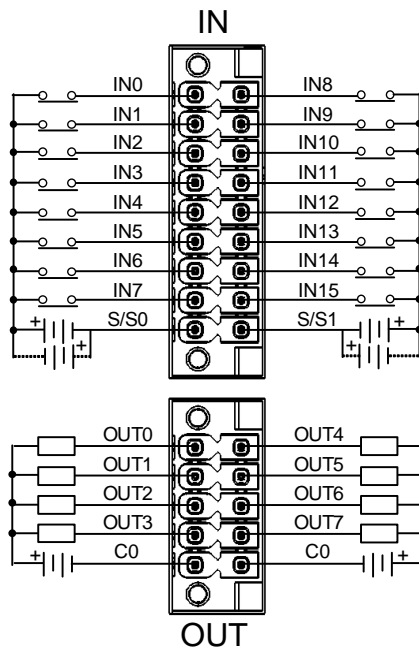
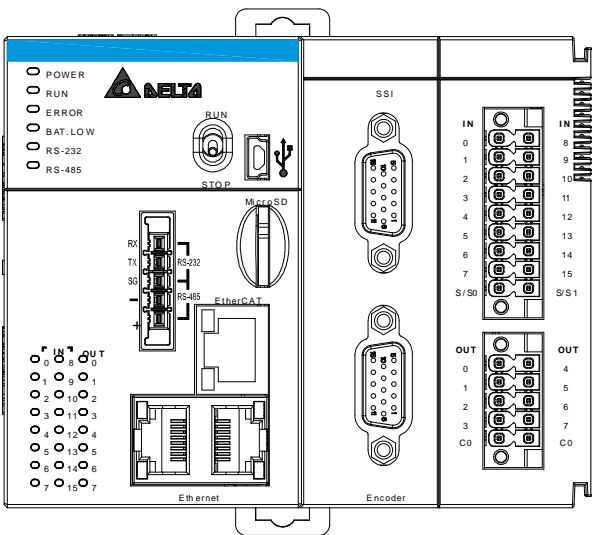

● High-speed Counter Wiring (PNP)

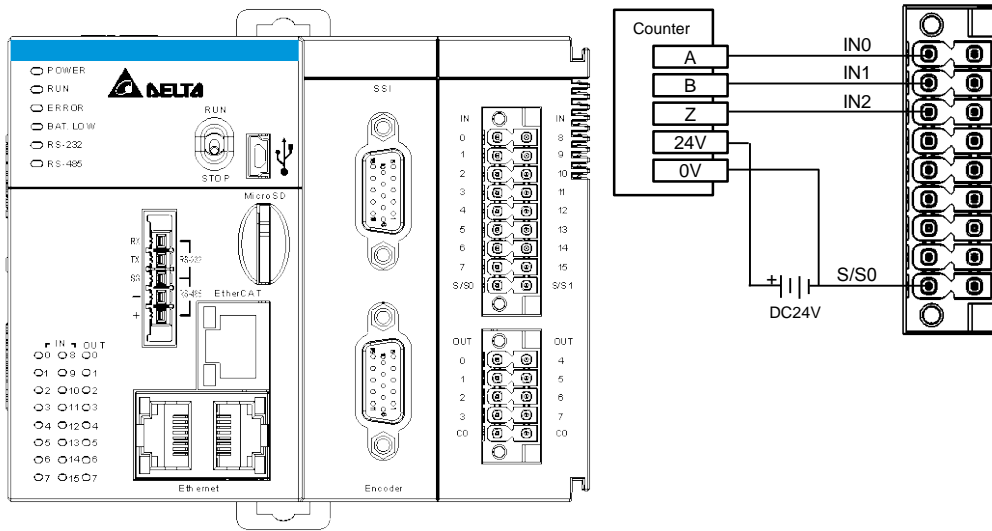

● High-speed Output Wiring

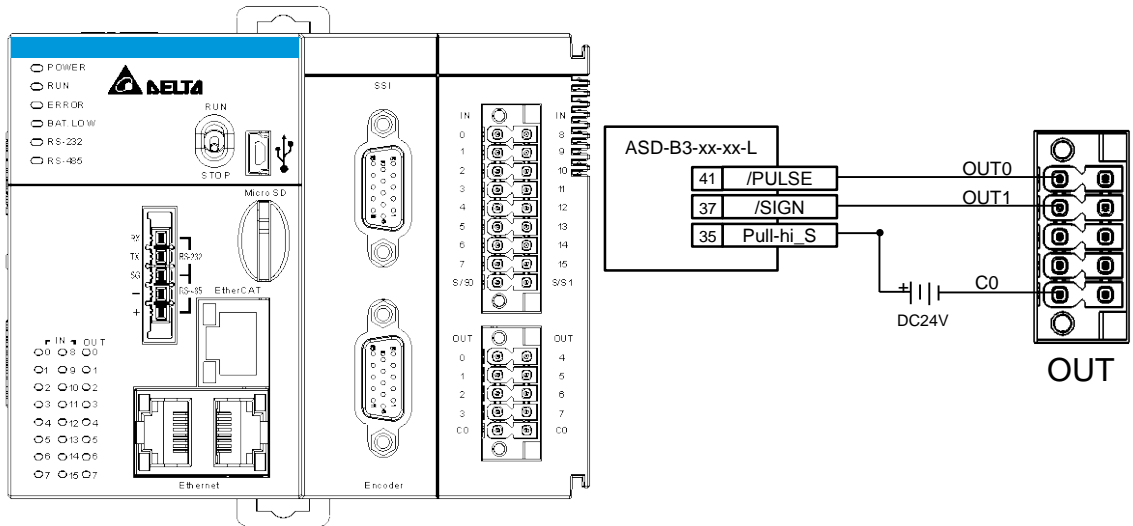

2.2.5.4 AX-308EA0M1P Wiring

Input Type	IN0~IN15: Direct current (Sinking or Sourcing)
Input voltage/Current	IN0~IN15: 24VDC, 5mA
Output Type	Out0~Out7: Sourcing transistors
Output voltage/Current	Out0~Out7 : 5~30VDC, 0.1A

- Please find section 2.2.5.3 for SSI, Encoder and high-speed counter wiring specification.
- General I/O Wiring

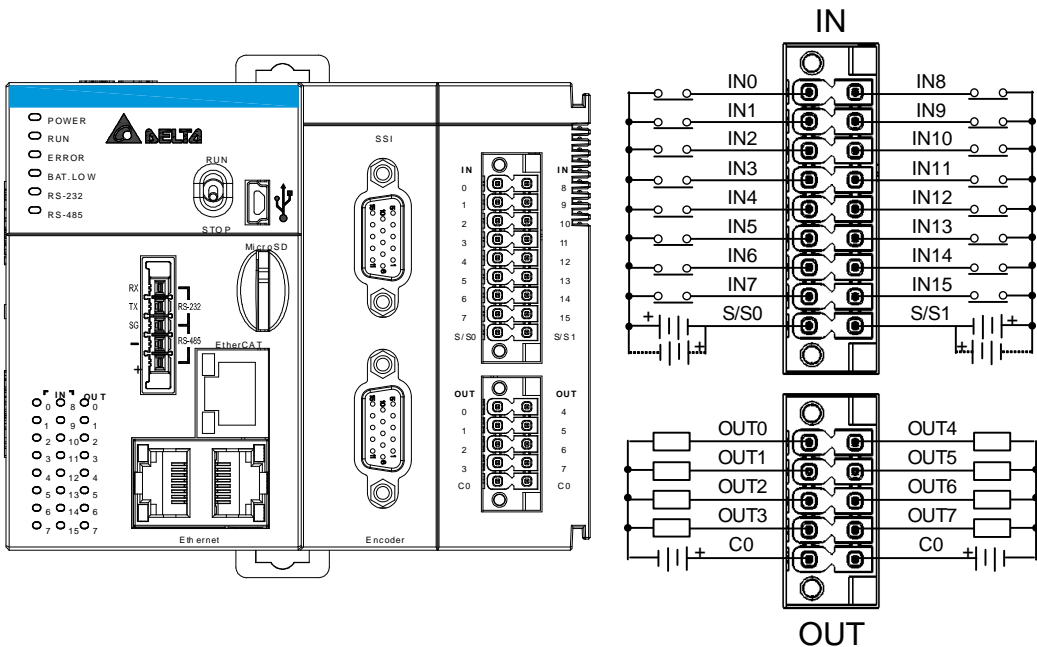

- High-speed Output Wiring

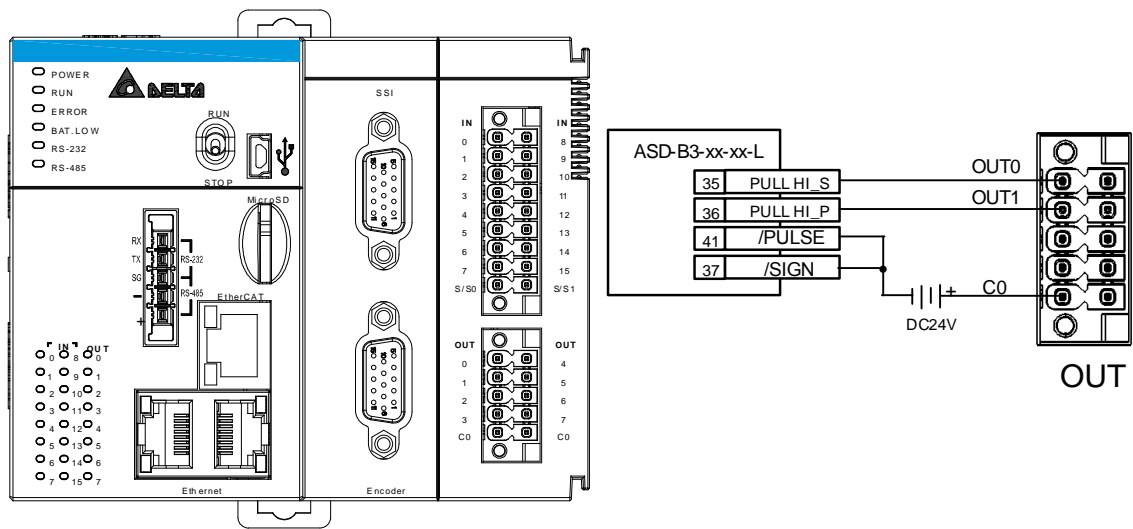

2.2.5.5 AX-324NA0PA1P Wiring

Input Type	Direct current (Sinking or Sourcing)
Input voltage/Current	24VDC, 5mA
Output Type	Sourcing transistors
Output voltage/Current	5~30VDC, 0.1A

- General I/O Wiring

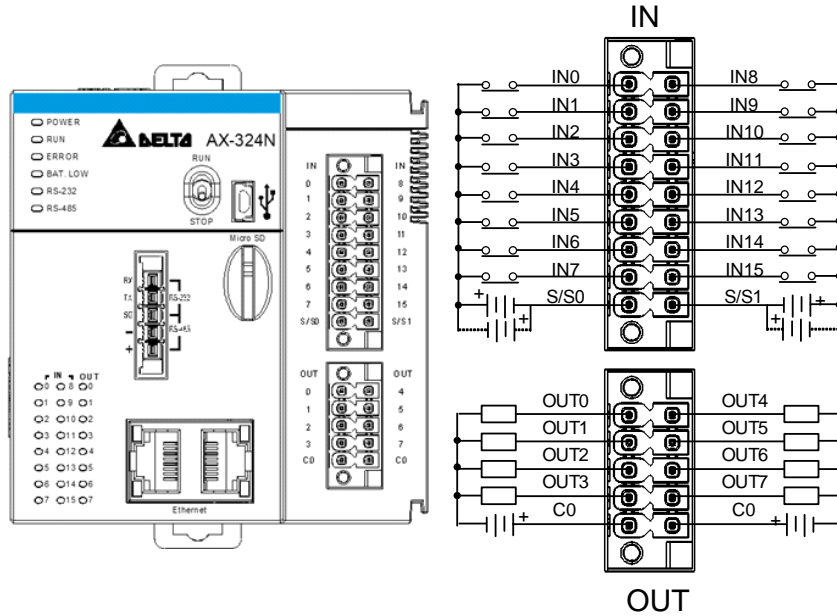

2.2.5.6 AX-332EPOMB1T Wiring

Input Type	Direct current (Sinking or Sourcing)
Input voltage/Current	24VDC, 5mA
Output Type	Sinking transistors
Output voltage/Current	5~30VDC, 0.1A

- General I/O Wiring

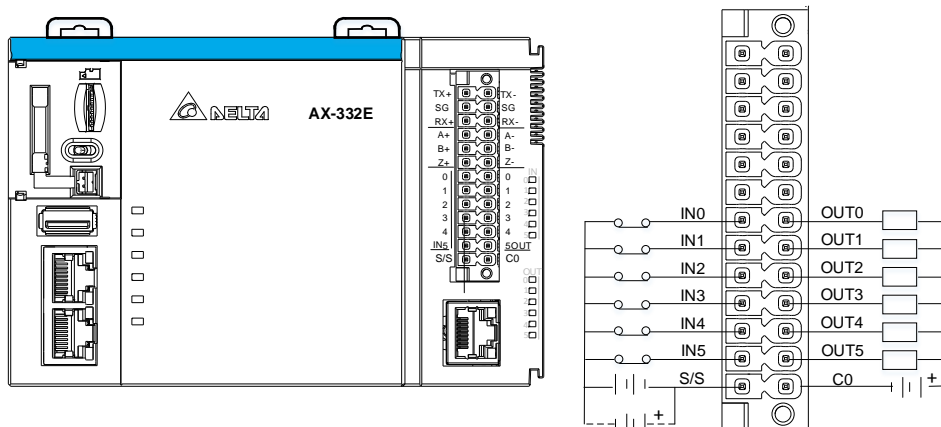

• RS-422 / RS-485 Wiring

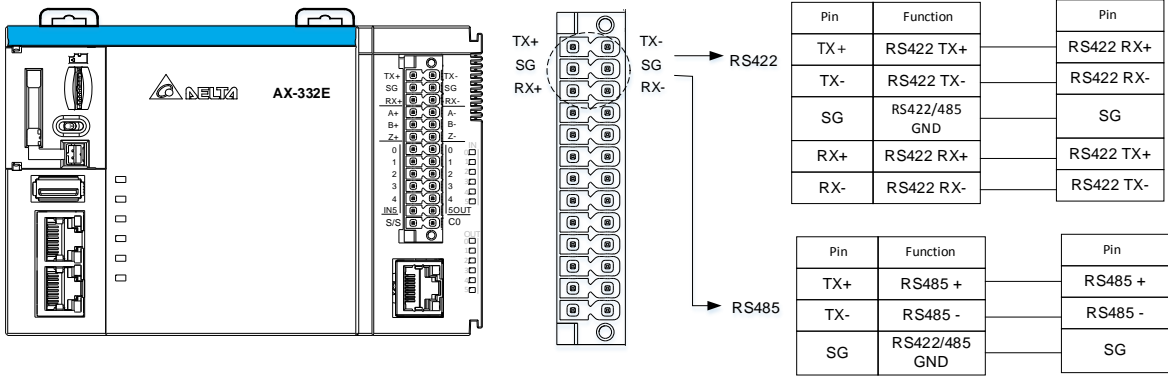

• Encoder Wiring

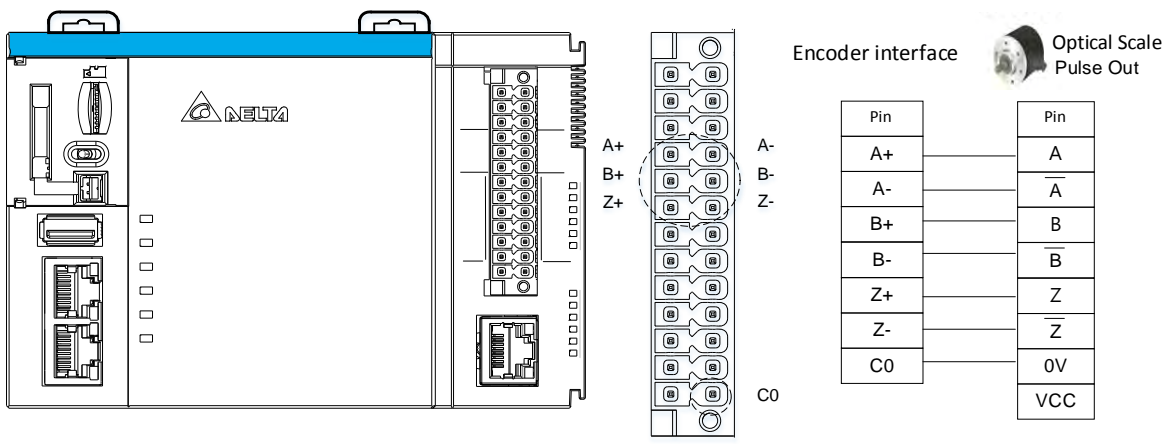

*Note: The encoder interface is with 5V DC only.

2.3 Power Supply Module Specifications

2.3.1 General Specifications

- AS-PS02/AS-PS02A

Item	Specifications	
Supply voltage	100–240 VAC (-15% to +10%) 50/60 Hz±5%	
Action specifications	If the input power supply is larger than 85 VAC, the power supply module can function normally.	
Allowable instantaneous power failure time	If the instantaneous power failure time is less than ten milliseconds, the power supply module keeps running.	
Fuse	2.5A/250 VAC	
Inrush current	< 70A@115 VAC	
24 VDC output	AS-PS02: 2 A for internal use: the CPU and the modules. AS-PS02A: 1.5 A for internal use: the CPU and the modules; 0.5 A for external use.	
Power protection	The 24 VDC output is equipped with the short circuit protection and the overcurrent protection.	
Electrical isolation	1,500 VAC (Primary-secondary), 1,500 VAC (Primary-PE), 500 VAC (Secondary-PE)	
Insulation voltage	Above 5 MΩ The voltage between all inputs/outputs and the ground is 500 VDC.	
Ground	The diameter of the ground should not be less than the diameters of the cables connected to the terminals L and N.	
Weight	AS-PS02	270 g
	AS-PS02A	310 g

2.3.2 Power Supply Module Profiles

- AS-PS02

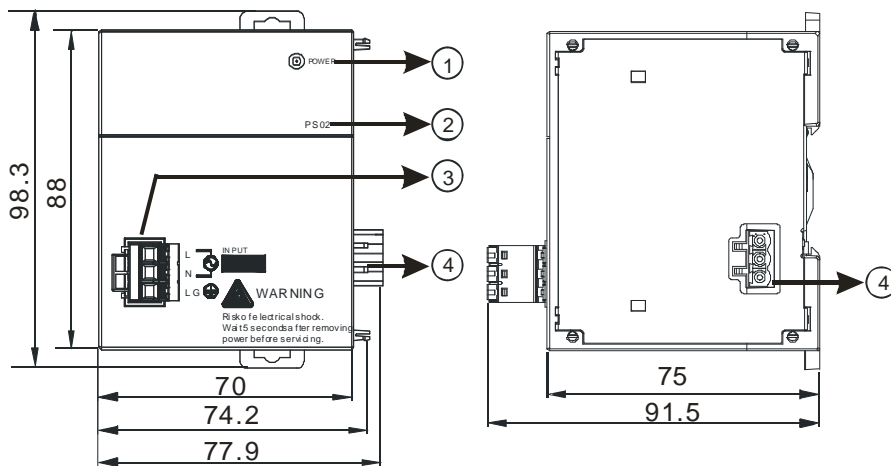

Unit: mm

● AS-PS02A

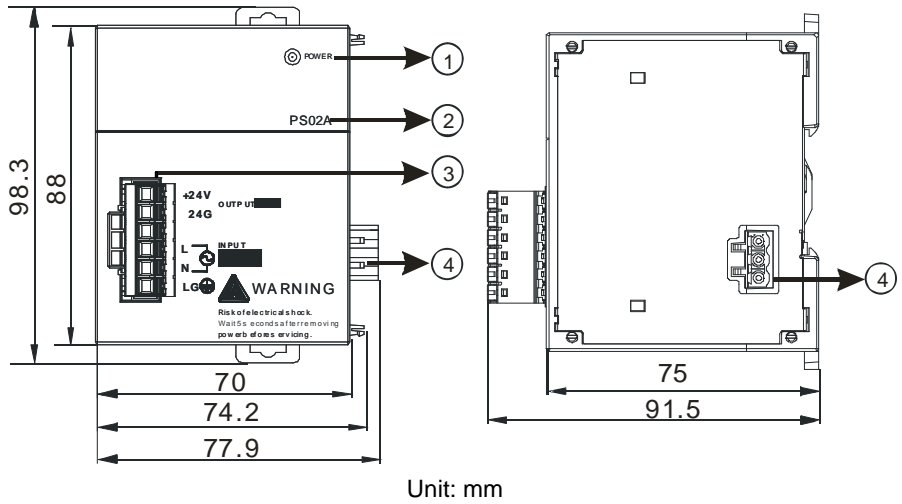

Number	Name	Description
1	POWER LED indicator (green)	Indicates the status of the power supply
2	Model name	Model name of the power supply module
3	Arrangement of the output terminals (only for AS-PS02A)	+24V: current output 24VDC, 500mA 24G: current output ground referenced
4	Arrangement of the input terminals	L: AC power input Line N: AC power input Neutral LG: Line ground
5	Power output (connect to CPU module)	

2.3.3 Power Supply Module Terminals

● AS-PS02

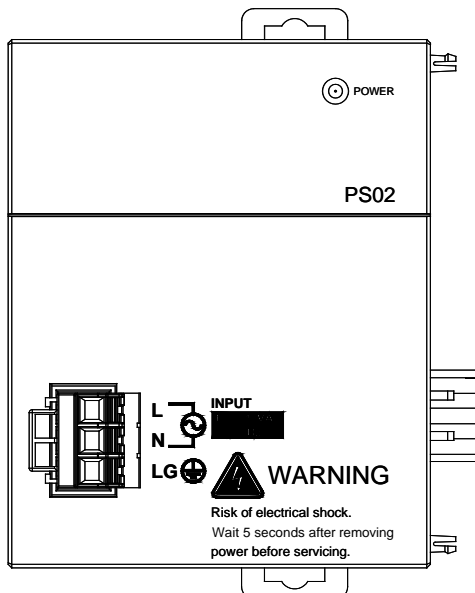

- L/N: AC power input
- LG: Line ground

● AS-PS02A

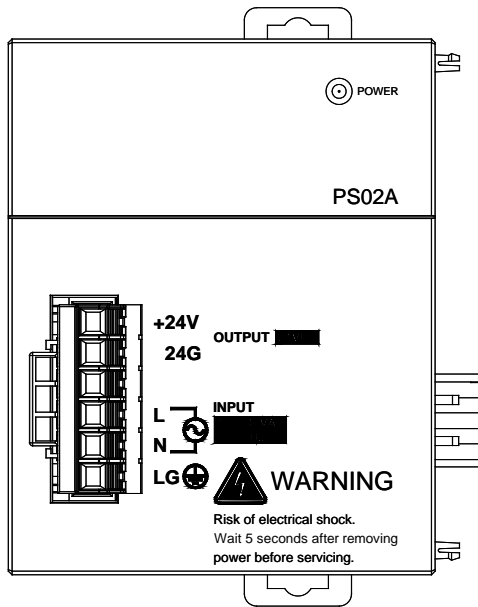

- +24V: connecting external 24VDC +
- 24G: connecting external 24G
- L/N: AC power input
- LG: Line ground

2.4 Extension Modules

You can connect the AS Series modules to AX-3 Series CPU. Refer to AS Series Module Manual for more information.

Chapter 3 Installing Hardware and Getting Started

Table of Contents

3.1	Installing Hardware.....	3-2
3.1.1	Installing and Removing a Memory Card	3-2
3.1.2	Installing and Replacing a Button Cell Battery.....	3-3
3.1.3	Installing the AX-3 Series PLC in the Control Cabinet.....	3-5
3.2	Installing and Uninstalling DIADesigner-AX	3-7
3.2.1	Installing DIADesign-AX.....	3-8
3.2.2	Uninstalling DIADesigner-AX	3-14
3.3	Getting Started and Setting up Communication	3-15
3.3.1	Getting Started.....	3-15
3.3.2	Setting up Communication	3-16

3.1 Installing Hardware

3.1.1 Installing and Removing a Memory Card

- **Memory Card Slot of the CPU Module**

The memory card slot is on the front side of the AX Series PLC.

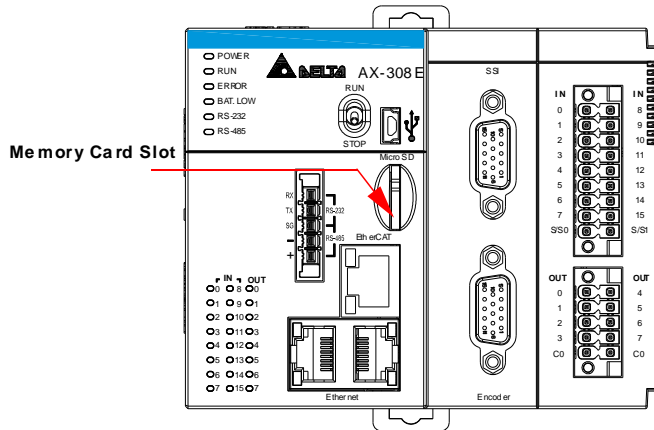

- **Installing a Memory Card**

Insert a memory card into the CPU module memory card slot and push it to the end of the slot until it clicks. Be sure the memory card is fixed firmly in the slot; if the memory card is loose, it is not installed correctly. With a fool-proofing design, the memory card can only be inserted in one direction. Do not force to push the memory card into the slot or you may damage the CPU module. See the instructions in the figures below for reference.

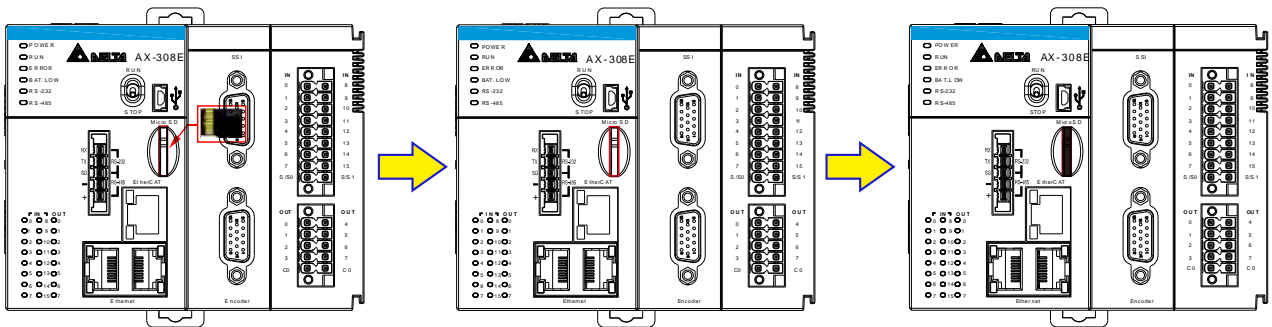

- **Removing a Memory Card**

You can remove a memory card by pushing it further into the slot. And then the card springs from the slot.

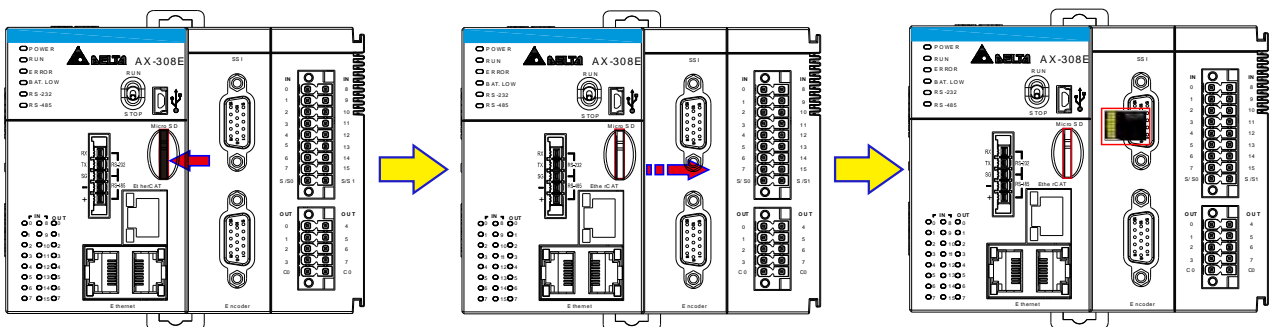

3.1.2 Installing and Replacing a Button Cell Battery

- Installation

⚠ Warning

The real-time clock (RTC) cannot work unless the battery power is properly supplied. The AX-3 Series PLC does NOT include the battery when it leaves the factory. You need to purchase and install the CR1620 3V battery beforehand. And before installing the battery, you must get rid of the static electricity in the body by touching the grounded metal or you can wear antistatic gloves to avoid the static electricity.

The first-time battery installation can be done whether the AX-3 Series PLC is powered on or off. After installation, you can set the RTC through DIADesigner-AX. Follow the steps below for installing a battery.

1. Pull out the battery holder from the AX-3 Series PLC with the tip of a screwdriver at the concave part of the battery compartment as shown below.

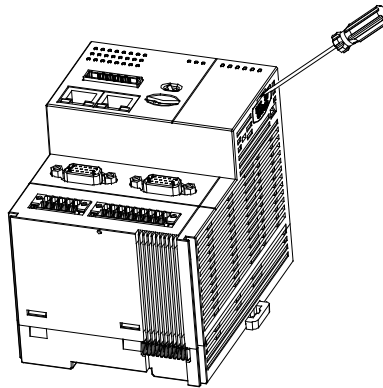

2. Put the CR1620 3V battery in the battery holder in the direction indicated by the arrow below.

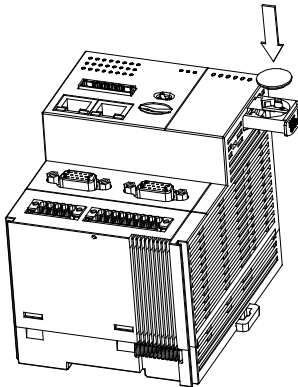

3. After putting the battery in the battery holder, push the battery holder back into the AX-3 Series PLC as shown below.

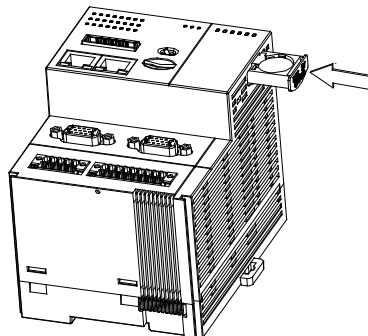

● Replacement

 Warning

When the BAT LOW indicator of the AX-3 Series PLC is red, it indicates there is no battery installed or the battery voltage is low and you need to install or replace the battery of the AX-3 Series PLC. It is suggested to replace the battery while the AX-3 Series PLC is powered on. If you replace the battery while the PLC is powered off, the real-time clock data will be lost. Before replacing the battery, you must get rid of the static electricity in the body by touching the grounded metal or you can wear antistatic gloves to avoid the static electricity.

Follow the steps below for replacing a battery.

- 3**
1. Pull out the battery holder from the AX-3 Series PLC with the tip of a screwdriver at the concave part of the battery compartment as shown below.

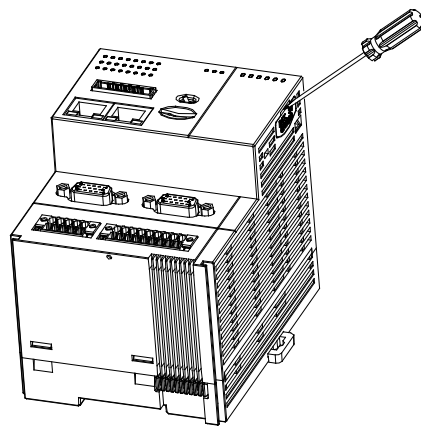

2. Take the CR1620 3V battery out of the battery holder in the direction indicated by the arrow below.

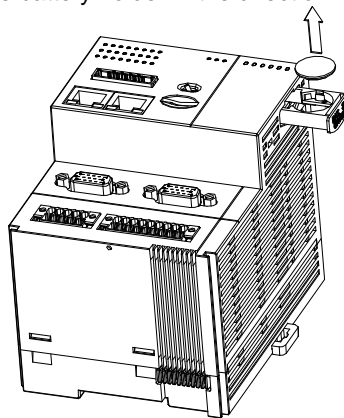

3. After the battery is removed, put in a new one and push the battery holder back into the AX-3 Series PLC as shown below.

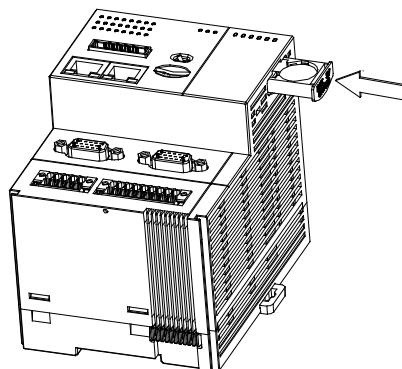

3.1.3 Installing the AX-3 Series PLC in the Control Cabinet

- **Environmental Temperature Requirement for the Control Cabinet**

⚠ Warning
<ul style="list-style-type: none"> ● The ambient temperature of the control cabinet should be -20 ~ 55°C and the humidity 5 ~ 95%. ● DO NOT install the control cabinet near flammable material or high-temperature equipment. ● Keep enough space for air ventilation. ● Install fans or air conditioning system if the environment temperature exceeds 55°C. ● The equipment is for indoor use only. ● Install the control cabinet around 1.0m~2.0m in height for easier installation and operation. ● Keep the installation away from the high-voltage equipment or power equipment. ● Cut off the power supply of the control cabinet before installation.

- **Actions for Anti-interference**

⚠ Warning
<ul style="list-style-type: none"> ● Do not install the AX-3 Series PLC in the control cabinet with high-voltage equipment. ● Keep at least 200mm away from the power wire. ● The control cabinet should be grounded. ● Use the AX-3 Series PLC according to the instructions on the manual. If operating the AX-3 Series PLC in a manner not specified by the manufacturer, it may weaken the protection provided.

- **Dimension Requirement for the Control Cabinet**

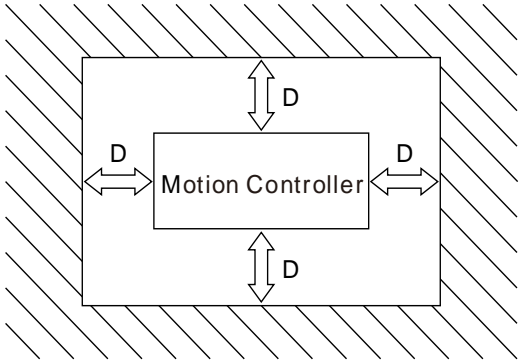
<p>The AX-3 Series PLC has to be installed in an enclosure. In order to ensure that the AX-3 Series PLC radiates heat normally, the space between the AX-3 Series PLC and the enclosure should be larger than 50 millimeters. ($D > 50\text{mm}$)</p>	 <p>The diagram illustrates a rectangular enclosure with diagonal hatching. Inside the enclosure is a smaller rectangle labeled 'Motion Controller'. Four double-headed arrows, each labeled 'D', indicate the clearance between the Motion Controller and the enclosure walls: top, bottom, left, and right.</p>
---	---

● **Installing the AX-3 Series PLC on DIN rail**

Pull out the fixing clips at the rear of the AX-3 Series PLC. Then edge in the horizontal slots which are at the rear of the AX-3 Series PLC on the DIN rail. And then push and lock the fixing clips to have the AX-3 Series PLC securely installed in the control cabinet. (The image below is for illustration purposes only; refer to AS500E Series Motion Controller Operation Manual for more information.)

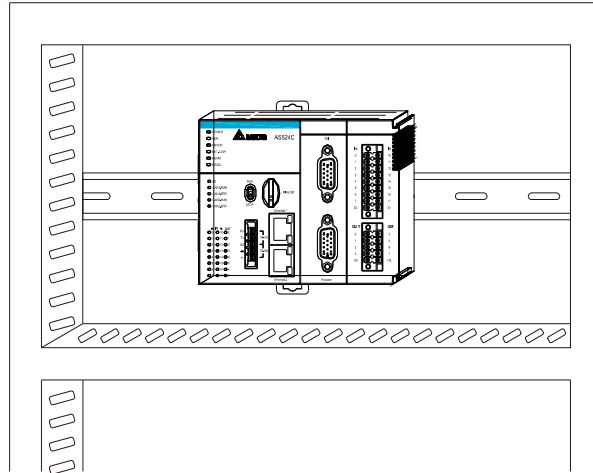

● **The installation inside the control cabinet** (The image below is for illustration purposes only; refer to AS500E Series Motion Controller Operation Manual for more information.)

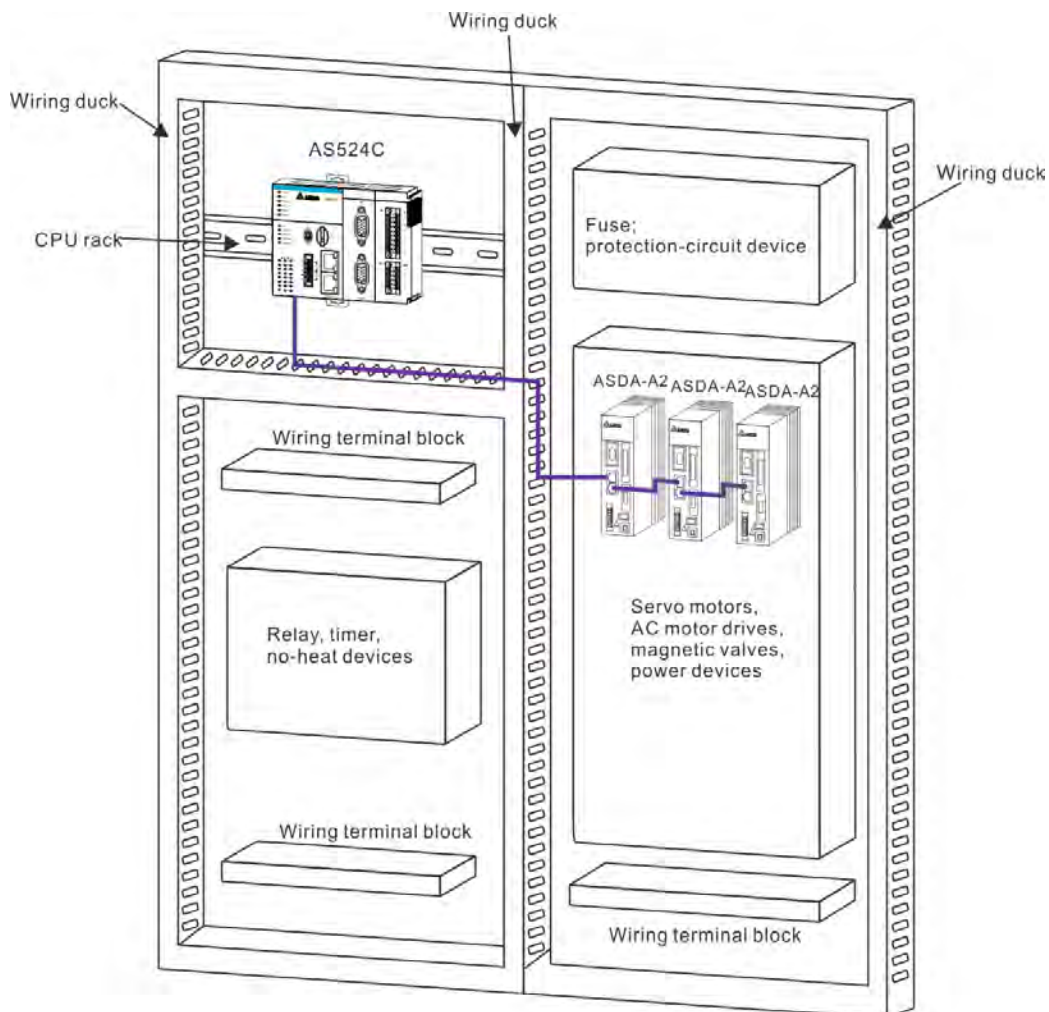

3.2 Installing and Uninstalling DIADesigner-AX

- System requirements

Project	System Requirement
Runtime System	DIADesigner-AX V1.00 or later
Operating System	Windows 7 / 8.1 / 10 (32/64 bits)
CPU	Intel Celeron 540 1.8 GHz (min.), Intel Core i5 M520 2.4 GHz (min.)
Memory	2GB or above (recommend to use 4GB or more)
Hard Disk Drive	10GB or more
Monitor	Resolution 1920 x 1080 Pixels recommend
Keyboard/Mouse	General Keyboard Mouse or Windows compatible device
PC interface	Ethernet, USB, Serial port (depends on product interface)
Software	Need to install .Net Framework 4.6.2

3.2.1 Installing DIADesign-AX

Before installation begins, make sure the computer used for installing DIADesigner-AX meets the minimum system requirements listed in section 3.2.

The **DIInstaller** is a software installer which assists you to download and install **DIASudio** software applications. You can download, install, and update products such as **DIASelector**, **DIADesigner**, **DIAScreen**, and **COMMGR**. Go to <https://diastudio.deltaww.com/home/downloads> to download the **DIASudio** for **DIInstaller**.

Before entering the download page, you need to sign in or sign up.

3

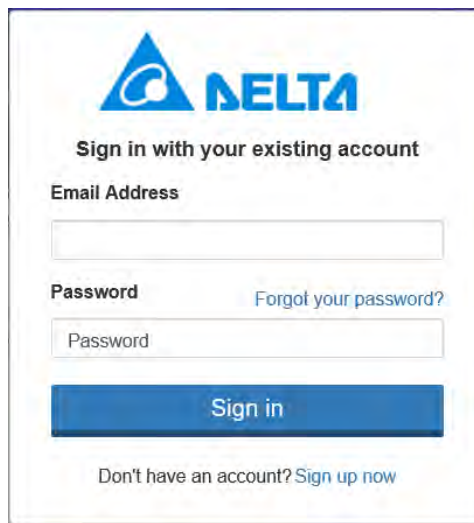

The image shows a login form for Delta. At the top is the Delta logo, which consists of a blue triangle with a white circle inside, followed by the word "DELTA" in blue. Below the logo is the text "Sign in with your existing account". There are two input fields: "Email Address" and "Password". The "Password" field has a link "Forgot your password?" next to it. Below the input fields is a blue button labeled "Sign in". At the bottom of the form, there is a link "Don't have an account? Sign up now".

After logging-in, click DIASudio download button to download **DIInstaller** as the image shown below.

Software

Software Name	Description	OS	Issue Date	File
DIASelector App V0.4 (Early Access!)	DIASelector Mobile App	Android Lollipop (5.0) and above	2020/05/06	 
DIASudio V0.4 (Early Access!)	DIASudio Software download and Installation Tool	Windows 7 / 8.1 / 10 / Server 2012 R2 32/64 bit	2020/05/06	

Follow the steps below for installing DIADesigner-AX.

1. Double-click DIAInstaller icon to see the latest version of DIADesigner-AX.
2. Click **Download**.

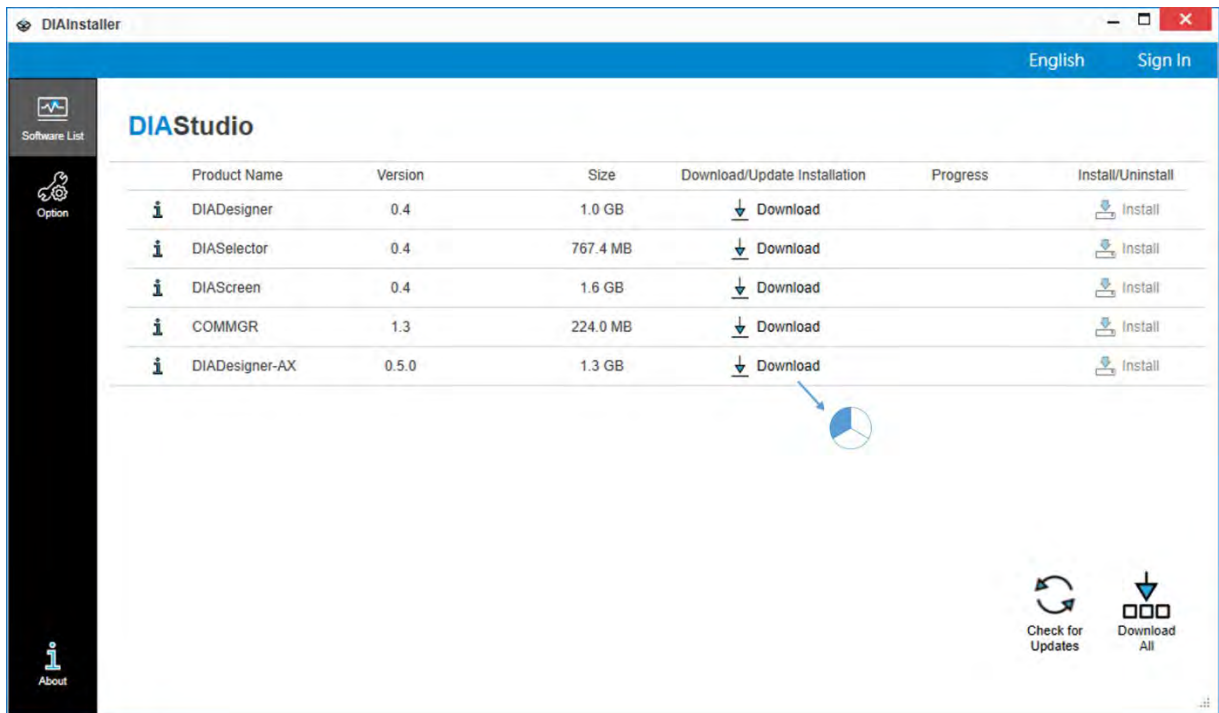

3. After that, you can see DIADesigner-AX is downloaded and grayed out. Click **Install**.

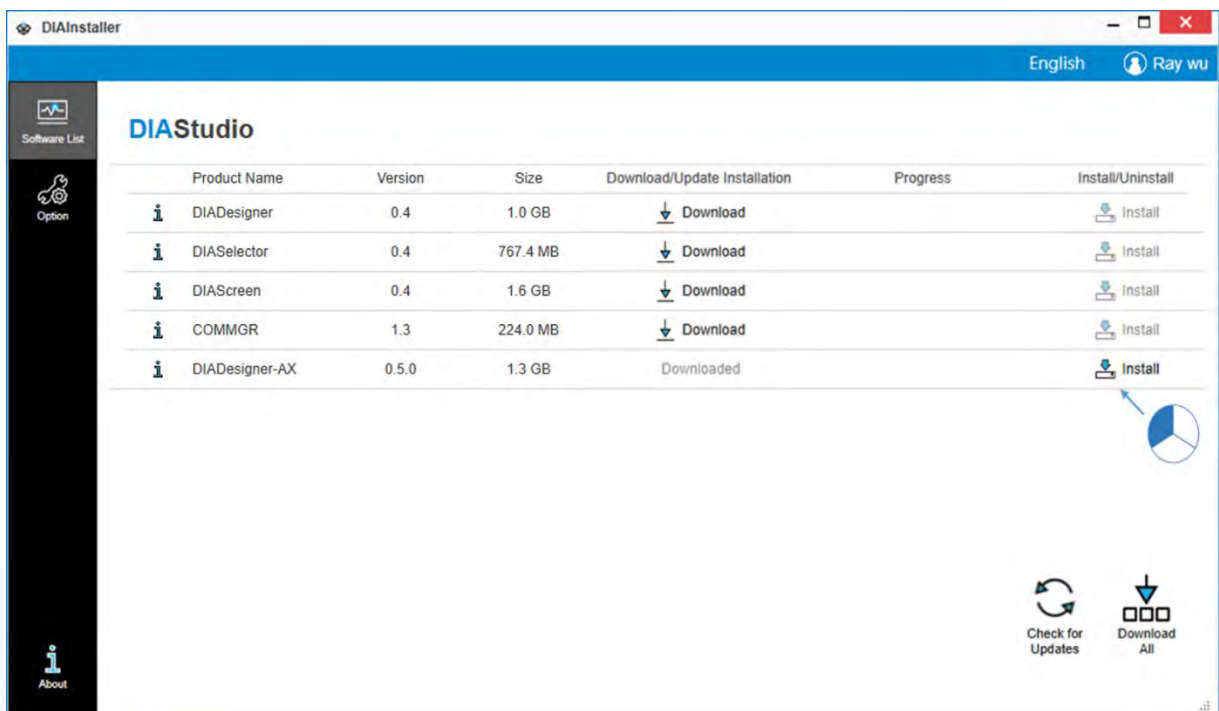

4. An **InstallShield Wizard** shows up and starts installing. Click **Next**.

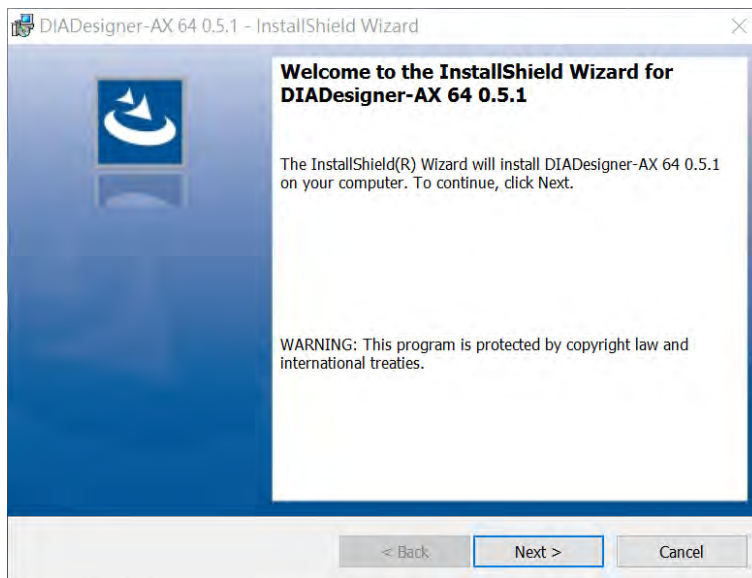
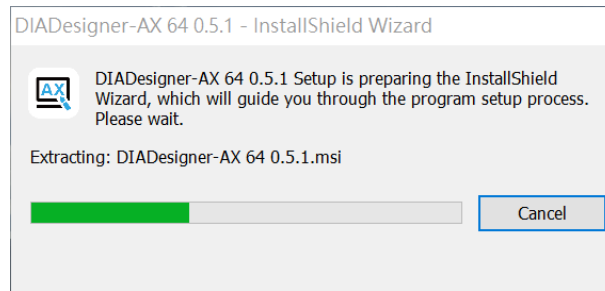

5. The window of License Agreement shows up. Select "I accept the terms in the license agreement" and then click **Next**.

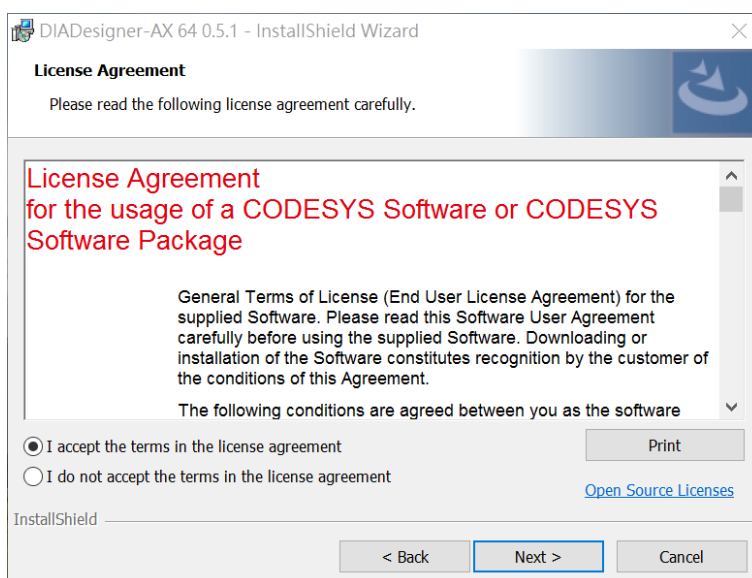

6. Click **Change...** to change the download path. Or leave the default path unchanged. Click **Next**.

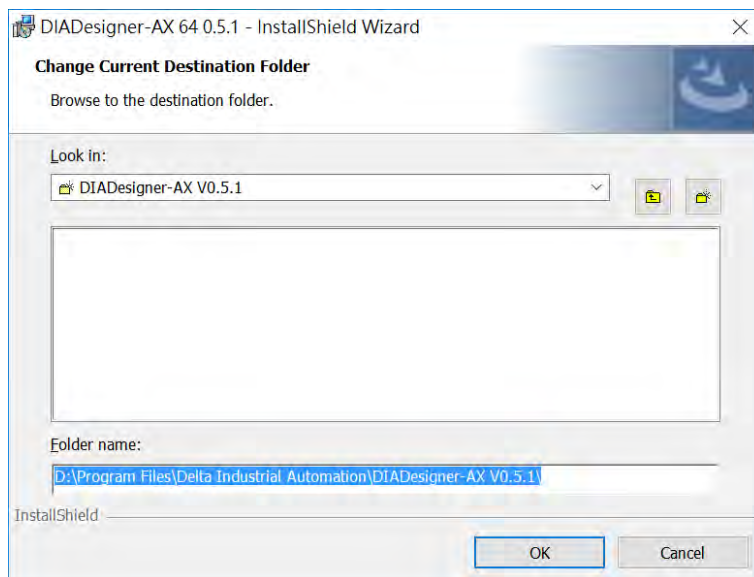
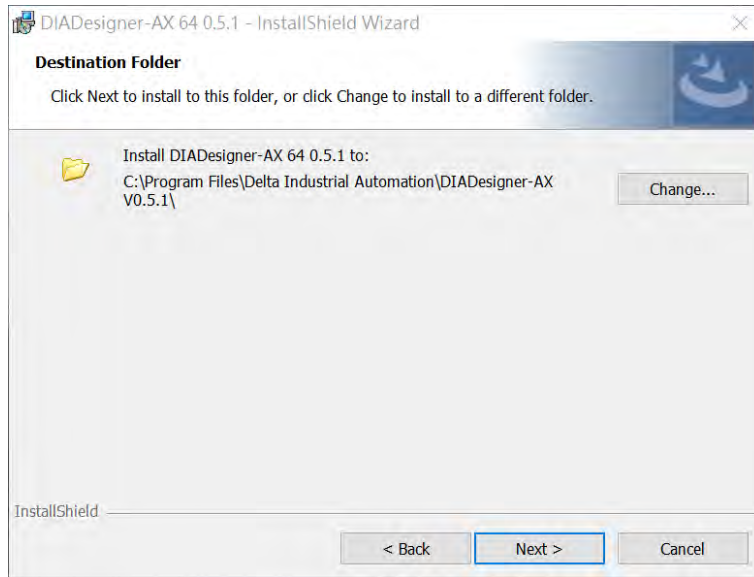

7. The window of Setup Type shows up as the image shown below. Select the one you need and then click **Next**.

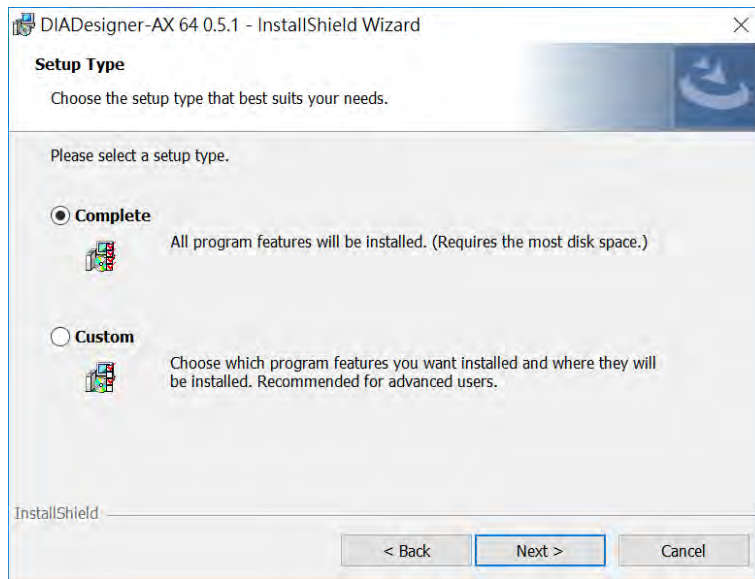

8. The window of Ready to Install the Program appears as below and then click **Install**.

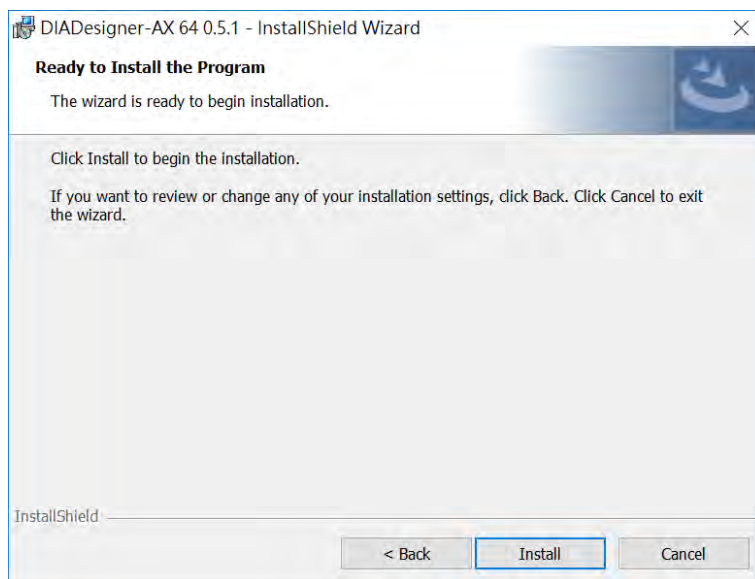

It may take some time to install.

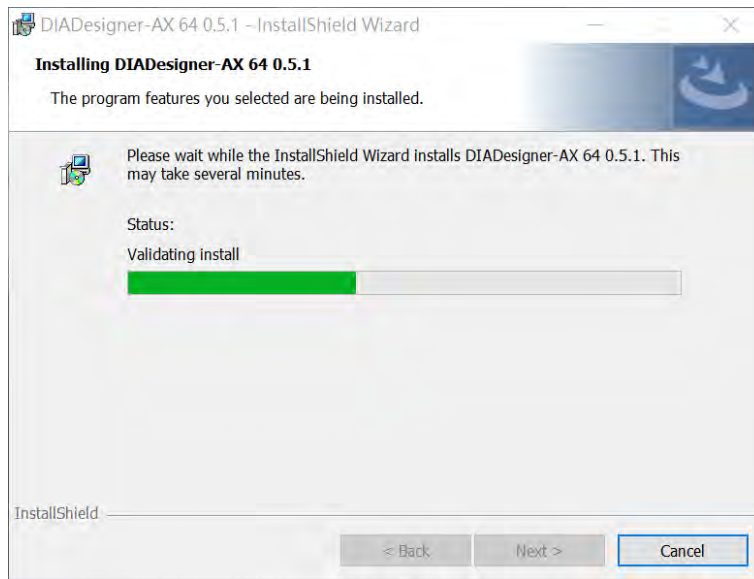

3

9. After installation, the window of InstallShield Wizard Completed appears. Click **Finish** to complete the installation.

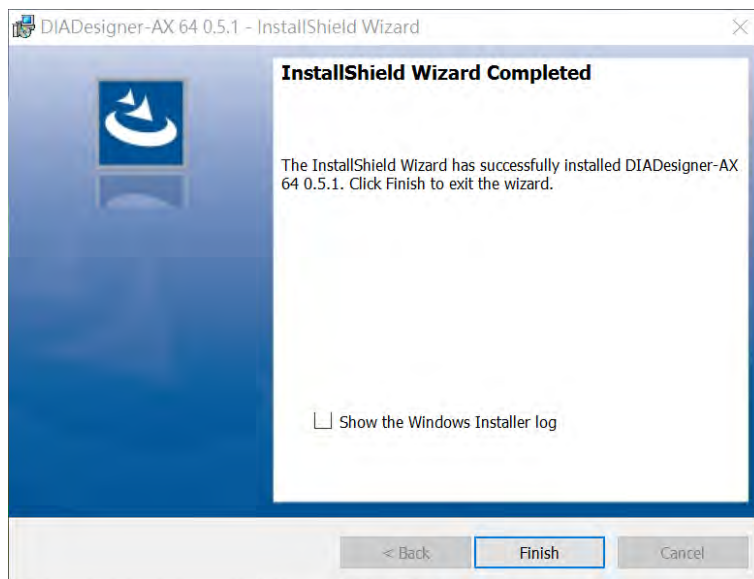

3.2.2 Uninstalling DIADesigner-AX

Follow the steps below for uninstalling DIADesigner-AX.

1. Double-click DIAInstaller icon to open and then click **Uninstall**.

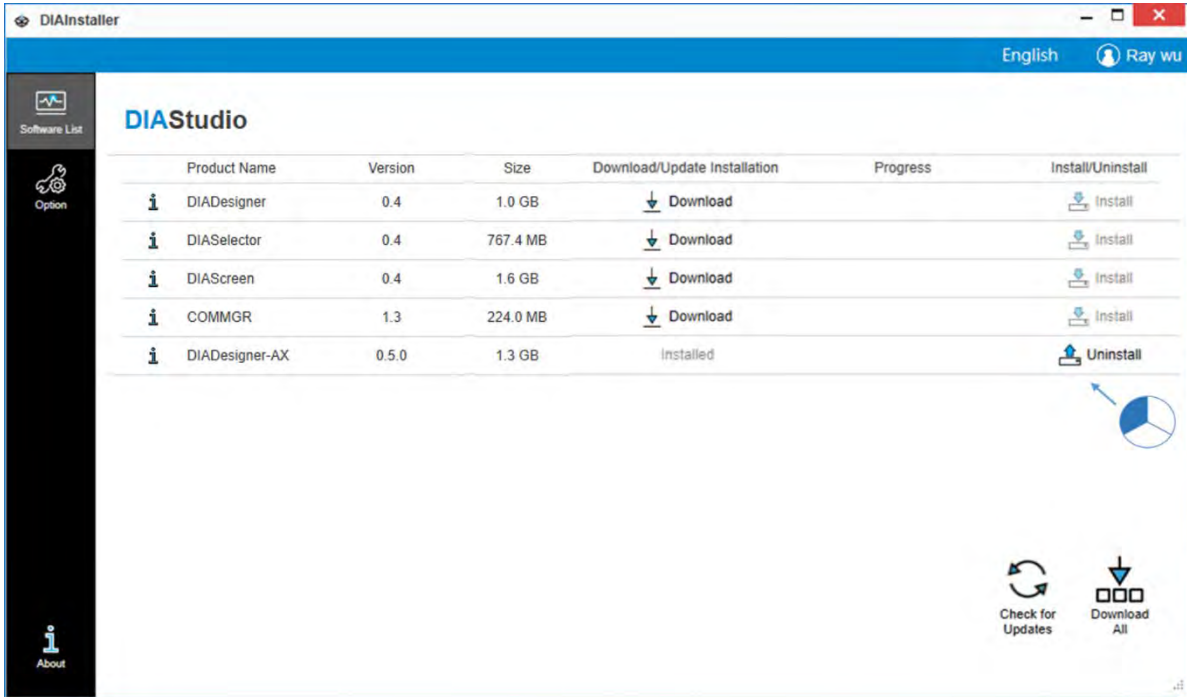

2. The system will remove DIADesigner-AX from your computer in the background.

3.3 Getting Started and Setting up Communication

3.3.1 Getting Started

After DIADesigner-AX is successfully installed, click **Start** , you can find it under the folder of Delta Industrial Automation and you can also find its short cut on the desktop. Double-click either one to start the software. You can open more than one DIADesigner-AX software to achieve multitasking.

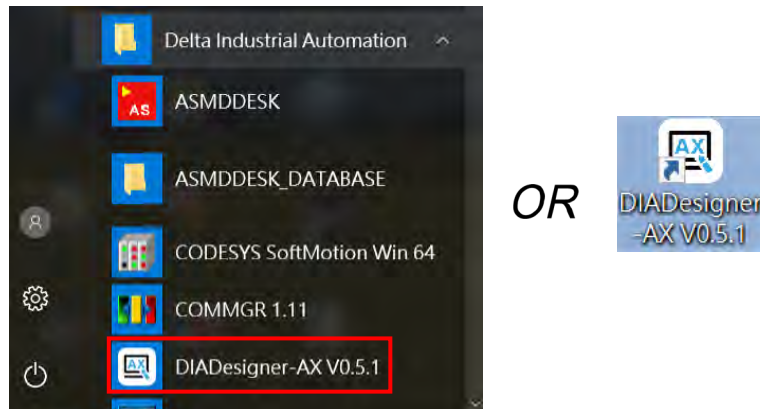

After the loading is done, you can see the start page as below. Refer to Chapter 4 for more details on operation.

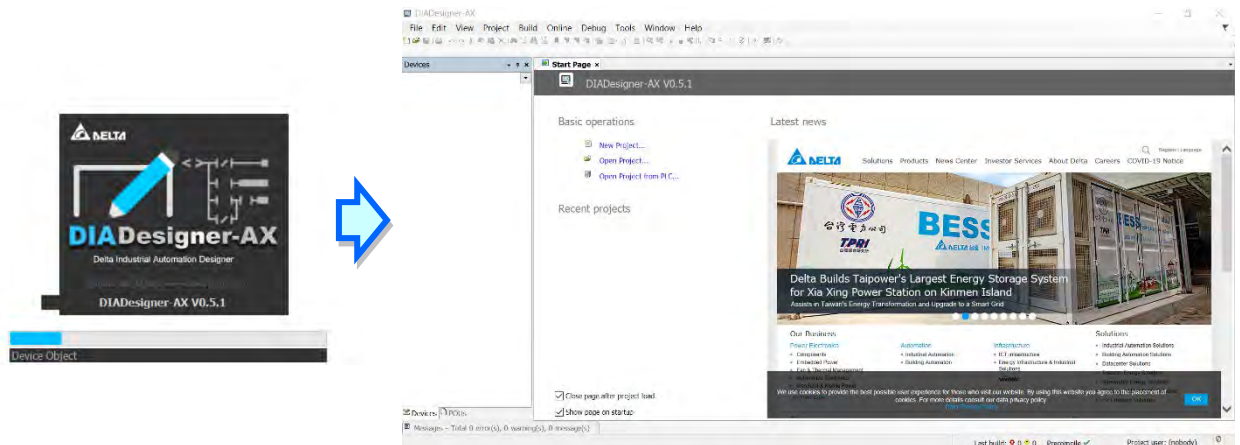



3.3.2 Setting up Communication

After DIADesigner-AX is successfully installed, the system creates the execution file **CODESYS Gateway V3** under the folder of Delta Industrial Automation and **GatewaySysTray.exe** in the Program Files folder. Double-click either one to start the Gateway. After that, the system starts Gateway automatically whenever you turn your computer on. And its

icon  will appear on the taskbar. If not, go to the execution file **CODESYS Gateway V3** under the folder of Delta Industrial Automation or **GatewaySysTray.exe** in the Program Files folder to start the Gateway manually.

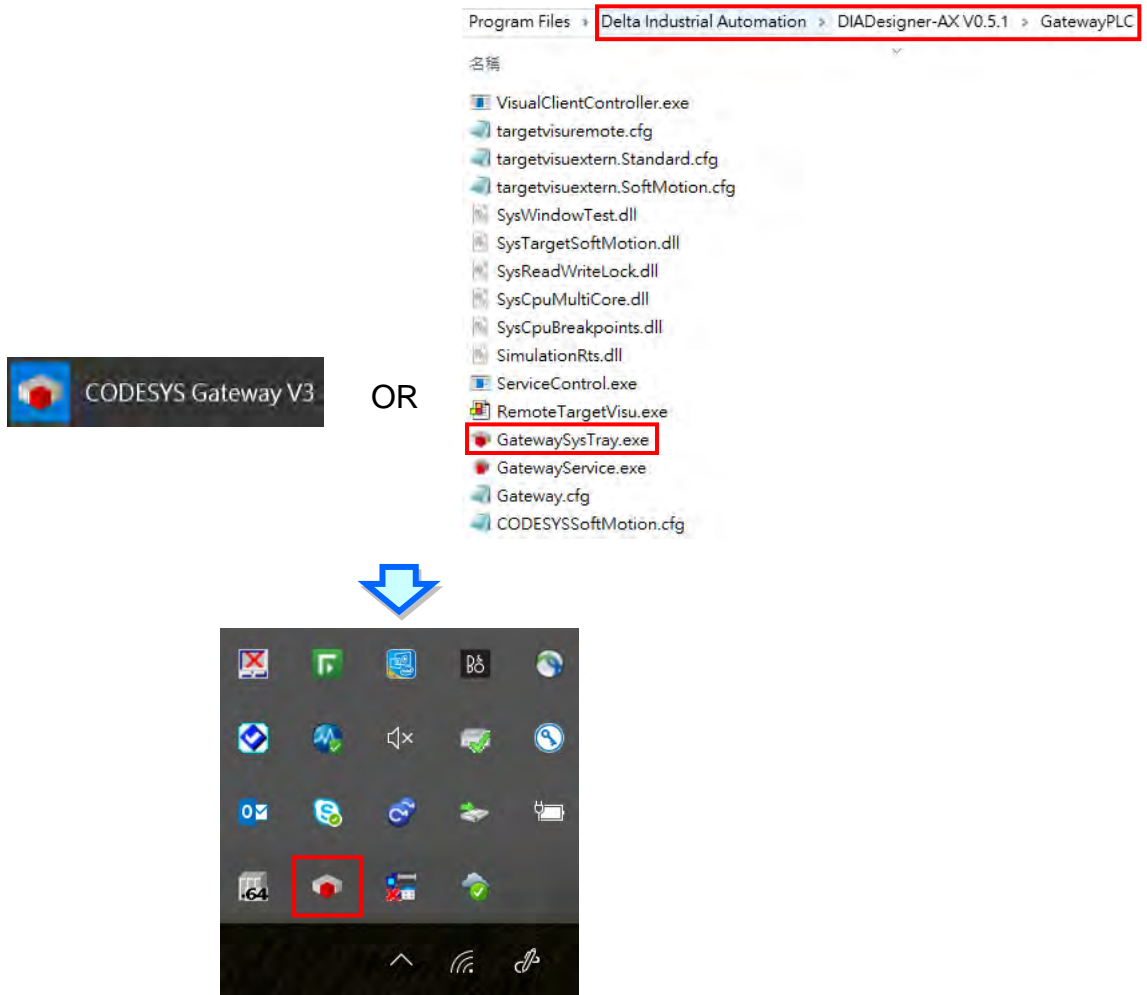
3



You can click the Gateway icon  on the taskbar to see the Gateway status.

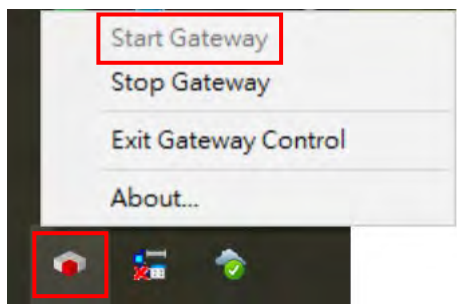

Click **Stop Gateway** if you need to stop gateway working.



3

If you need to discontinue the execution of GatewaySysTray completely, you can click **Exit Gateway Control** and the icon  will disappear on the taskbar.

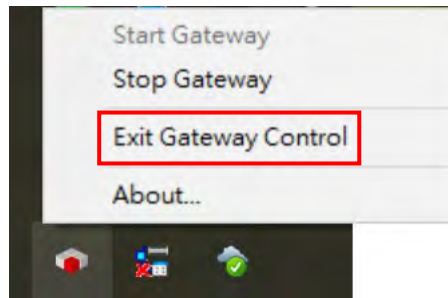

Open the software DIADesigner-AX and open/create your project to see the project-setting page. Double-click Device (Product Name) to open the device-setting page. You can find the Gateway status under the Communication Settings tab. If the Gateway is started, its light is green. If the Gateway is stopped, its light is red.

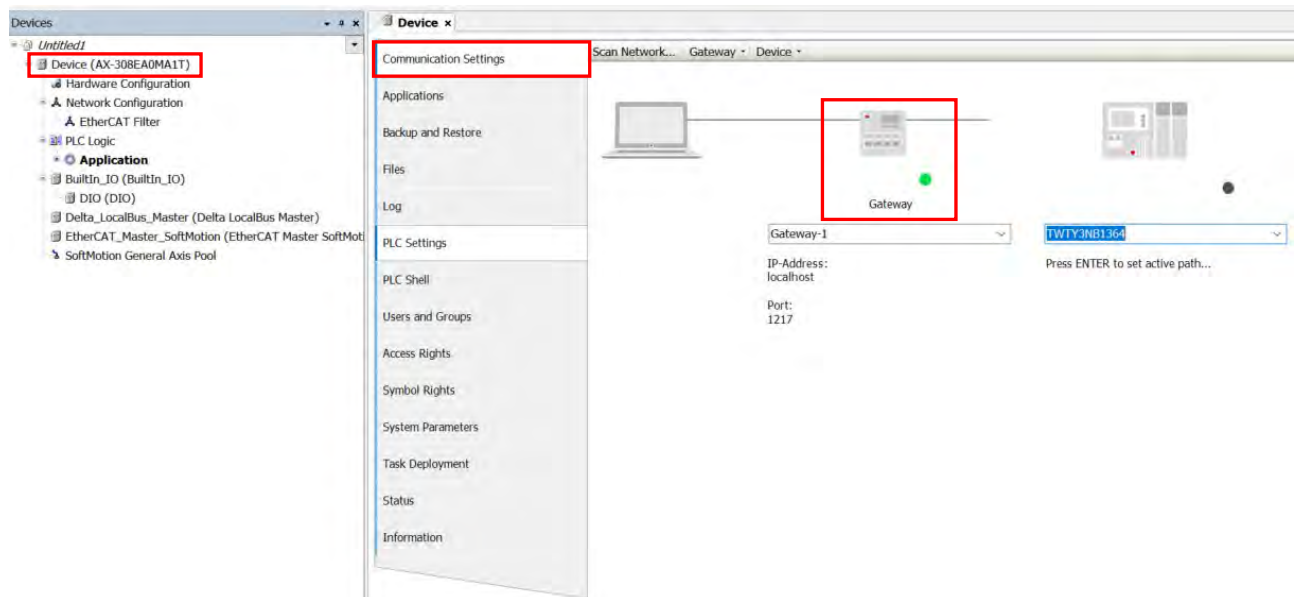

You can configure the Local Gateway. Click **Gateway** and click the option **Configure the Local Gateway** to open the setting page.

3

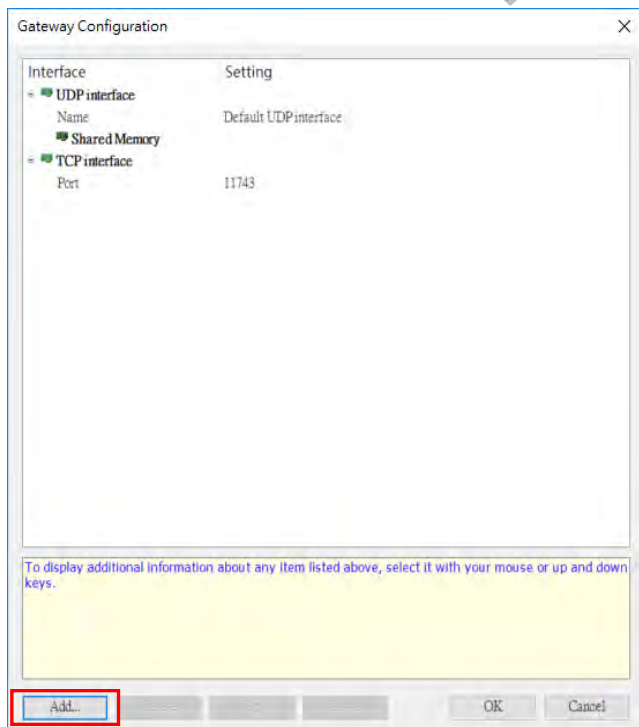
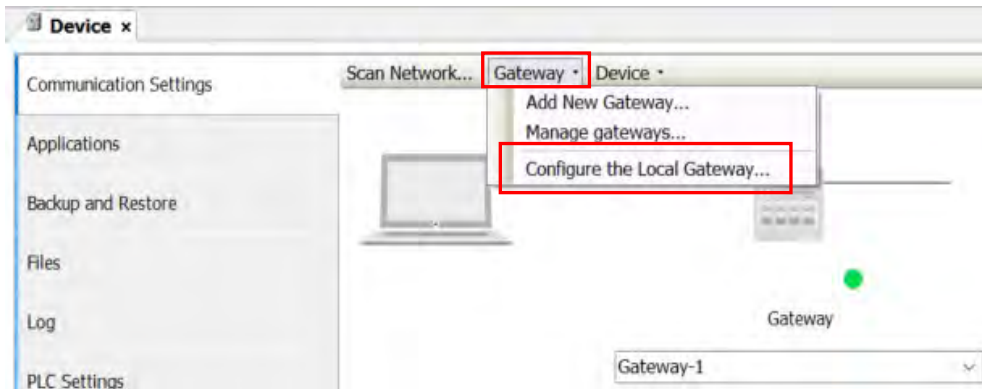

You can find two interfaces under Local Gateway, including UDP interface and TCP interface. You can also create a different port. Click **Add** and select **Add top level interface** and then use the drop-down list to select the port you needed to add. Here we use adding COM Port as an example.

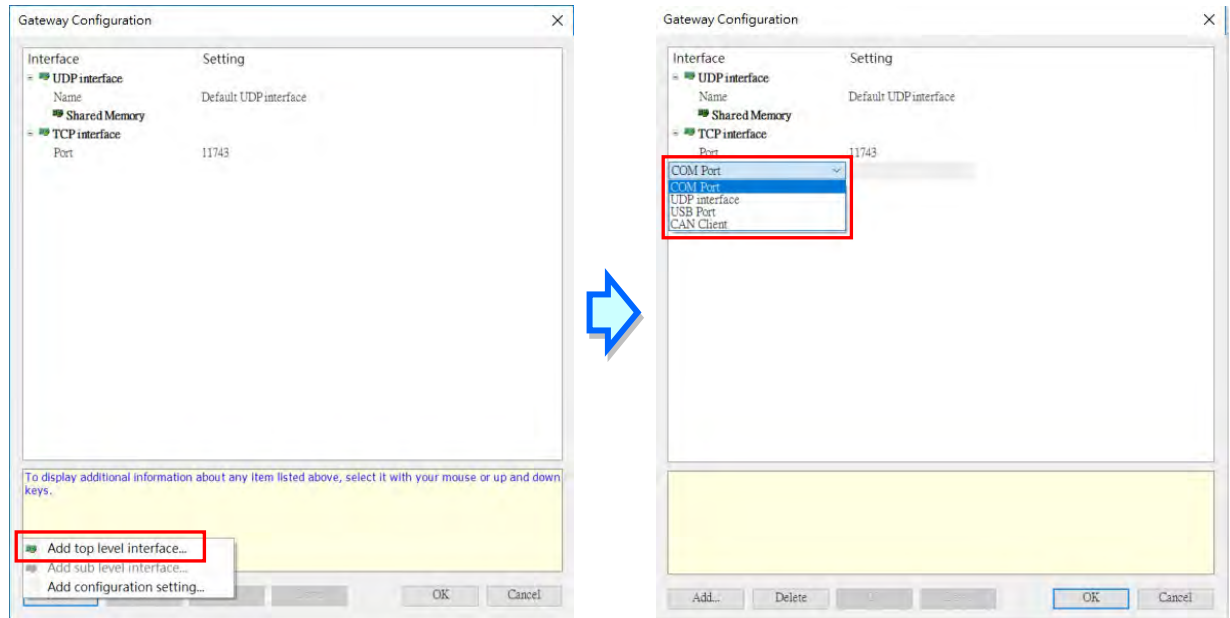

After adding COM Port, you can set up the COM port name, its corresponding port and the baudrate. Once the setting is done, click **OK**. You need to Stop/Start GatewaySysTray again to ensure the following action, such as Scan Network to work properly. Refer to the previous steps to run GatewaySysTray again.

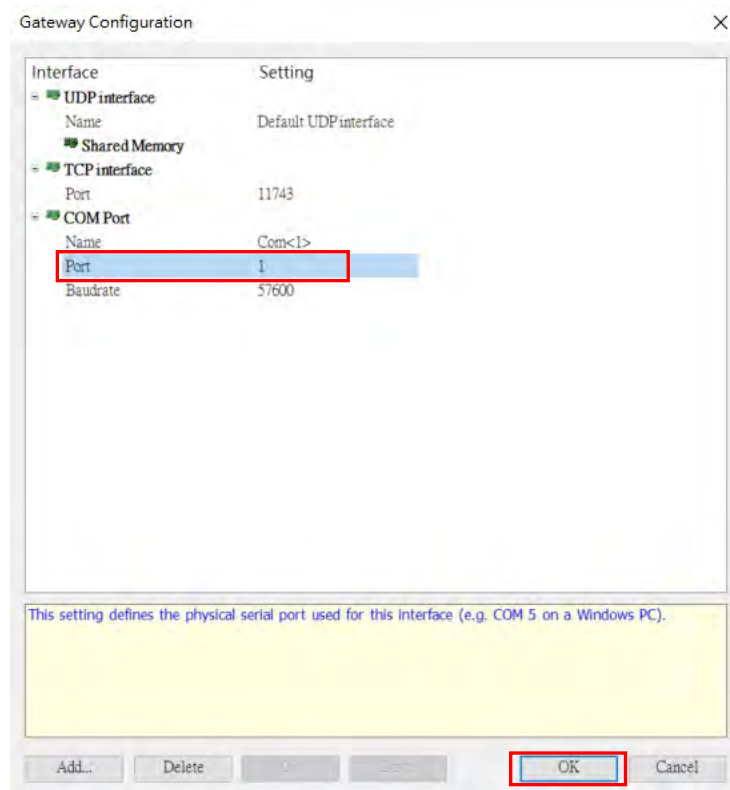

You can add configuration settings under COM Port. Right-click the COM Port icon  , select **Add configuration setting.....** to add the setting items. After that you can further define the setting values. Once the setting is done, click **OK**.

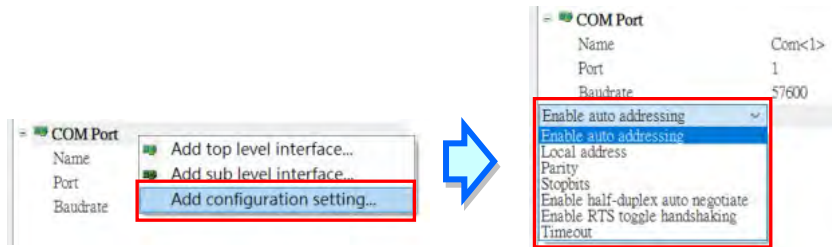

3

After the configurations of Local Gateway are set, you can select the **Scan Network** tab to bring out network scanned results on the **Select Device** setting page. Select **AX-308EA0MA1T** and then click **OK**.

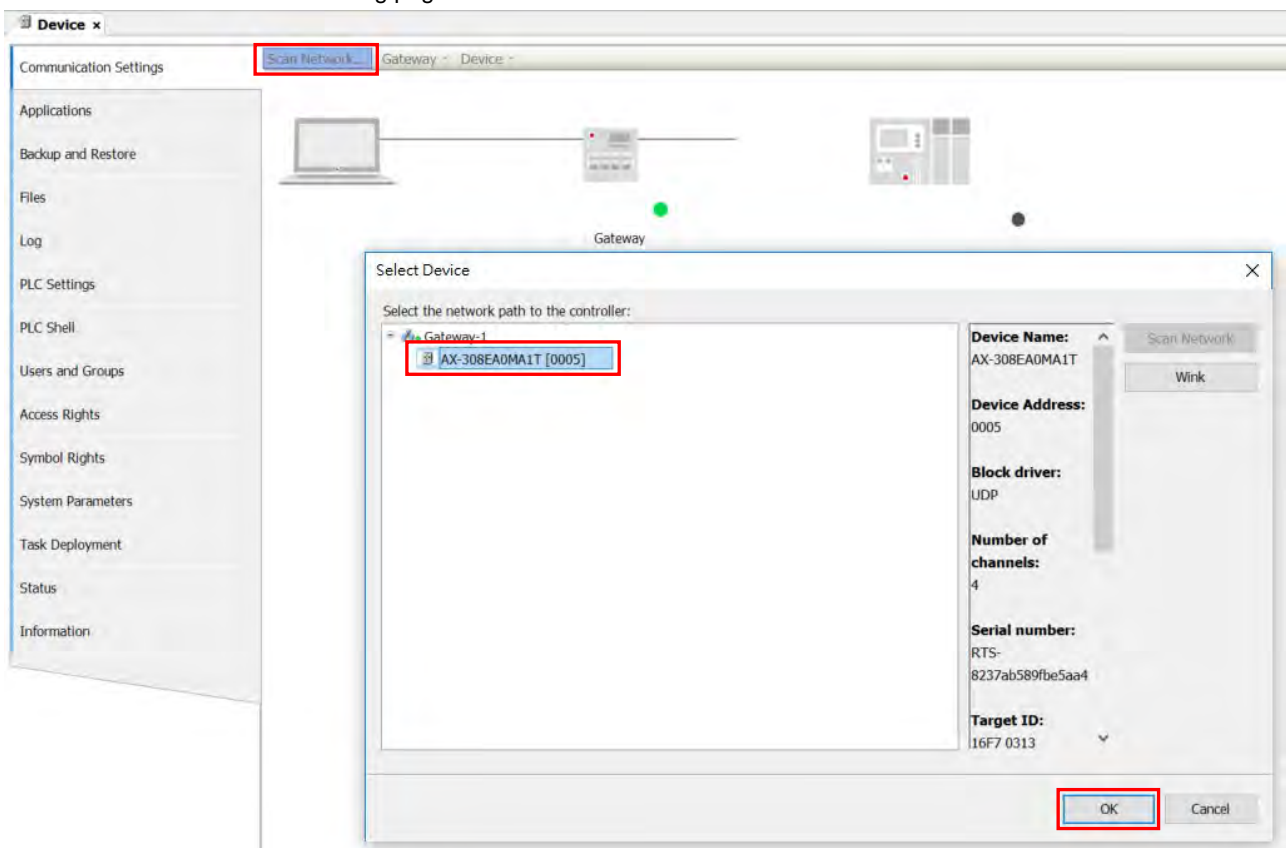

If the connection is established successfully, you can find that the status light is green and the detailed device information under the device image.

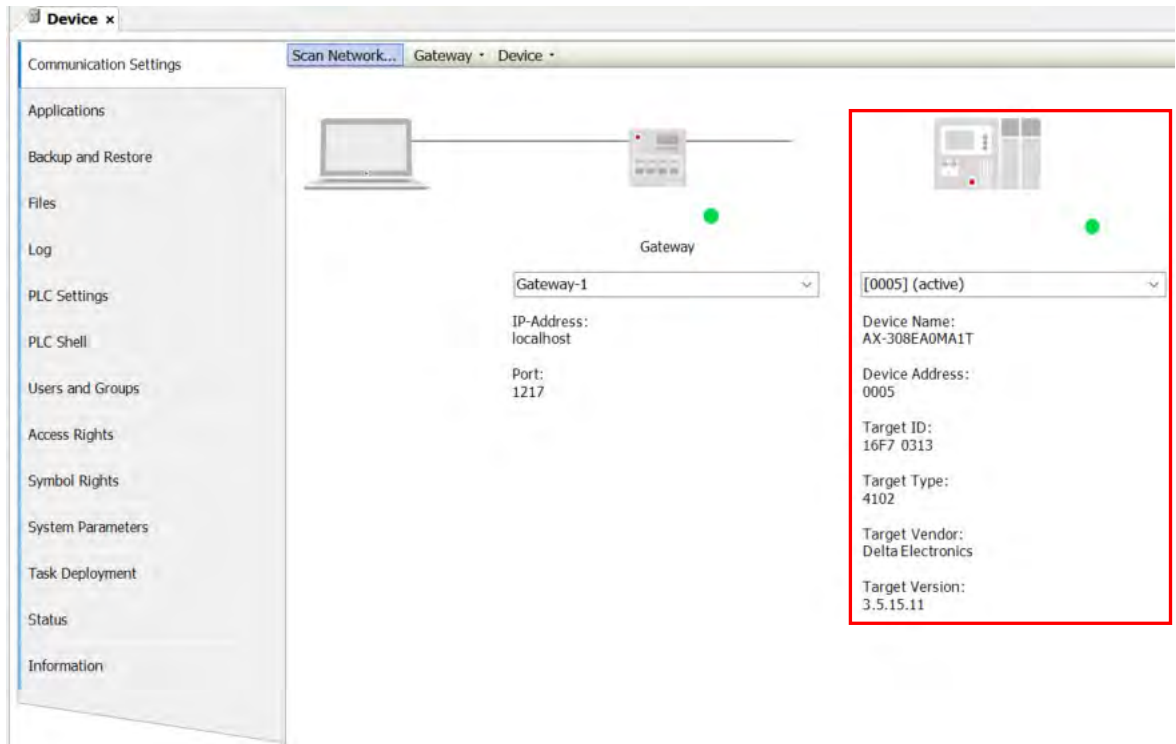

MEMO

Chapter 4 Basic Operation

Table of Contents

4.1 Introduction on DIADesigner-AX.....	4-2
4.1.1 Creating a New Project.....	4-2
4.2 Setting Items on the Device Page	4-4
4.2.1 CPU Parameter Settings	4-4
4.2.1.1 Communication Settings	4-4
4.2.1.2 Applications.....	4-7
4.2.1.3 Backup and Restore.....	4-8
4.2.1.4 Files	4-9
4.2.1.5 Log.....	4-9
4.2.1.6 PLC Settings	4-11
4.2.1.7 PLC Shell.....	4-12
4.2.1.8 Licensed Software Metrics	4-13
4.2.1.9 System Setting	4-13
4.2.1.10 Right Settings.....	4-16
4.2.1.10.1 Users and Groups	4-17
4.2.1.10.2 Access Rights.....	4-21
4.2.1.10.3 Symbol Rights.....	4-26
4.2.1.11 System Parameters	4-28
4.2.1.12 Task Deployment	4-29
4.2.1.13 Status.....	4-30
4.2.1.14 Information	4-30
4.2.2 Extension Module Parameter Settings	4-31
4.3 Data Type and Variables.....	4-32
4.3.1 Data Type	4-32
4.3.2 Variables	4-33
4.3.2.1 Declaration of Variables	4-33
4.3.2.2 Address Assignments.....	4-34
4.3.2.3 Variables.....	4-35
4.3.2.4 User-defined Data Types.....	4-39
4.3.2.5 Timing for the Variable to be Cleared to Zero.....	4-42
4.3.2.6 Timing for the Default Value to be Effective	4-43
4.4 Task	4-44
4.4.1 Task Configuration.....	4-44
4.4.1.1 Task Types	4-44
4.4.1.2 Bus Cycle Task.....	4-45
4.4.1.3 Watchdog.....	4-46
4.4.1.4 Motion Instructions for Types of Tasks	4-47
4.5 Recipe Manager	4-49
4.5.1 Recipe Manager.....	4-51
4.5.2 Recipe Definition	4-53
4.5.3 RecipeManCommand.....	4-55

4.1 Introduction on DIADesigner-AX

DIADesigner-AX is an open platform for PLC development system and industrial automation. The adaptable DIADesigner-AX provides an easy way to create professional engineering of IEC 61131-3 automation projects. Based on the IEC 61131-3 data structure and the high-level language programming, DIADesigner-AX is strong in functionality, easy to develop, reliable, extendable and open for development. Integrated with components such as visualization and Safety solution, DIADesigner-AX offers a variety of user-friendly engineering functions for your professional applications in controller development system sectors including PLC and motion control.

In DIADesigner-AX, you can customize the user interface by arranging the window layout and the appearance of menus, toolbars and commands according to your requirements.

4.1.1 Creating a New Project

Double-click the DIADesigner-AX icon  to open DIADesigner-AX. Click **New Project**  on the Start Page or select **File > New Project (Ctrl+N)** to create a new project.

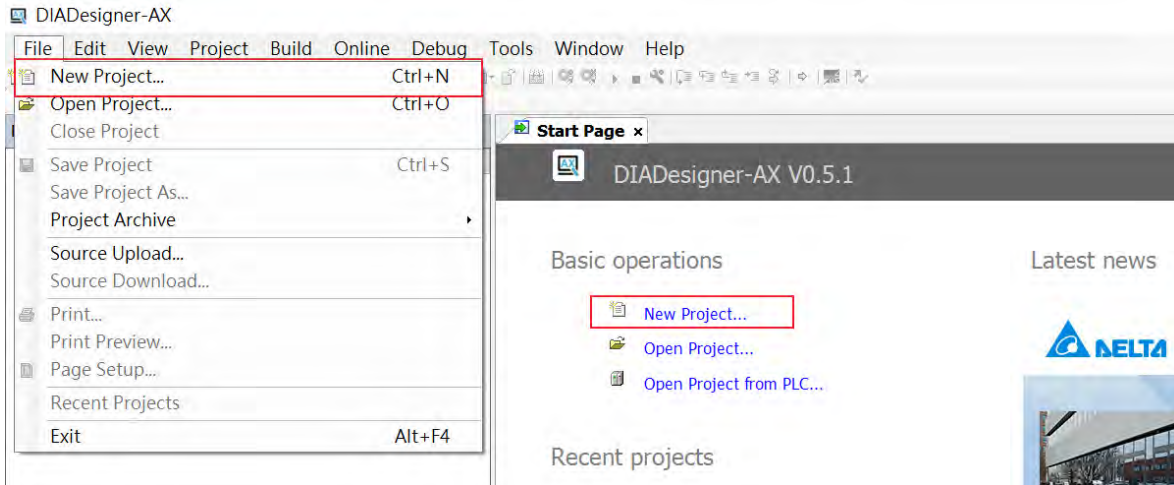

Next you will see a window with two sections, Categories and Templates. Click **Projects** in the Categories section and click **Standard project** in the Templates section. After that create a Name and specify a location for the project and then click **OK**.

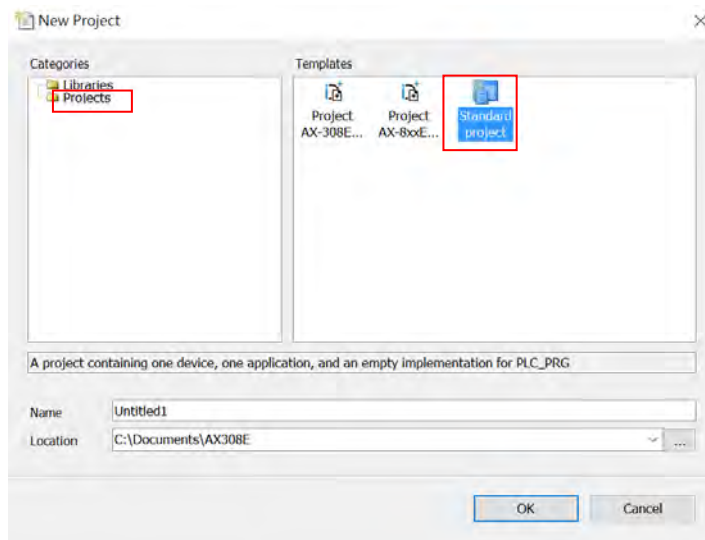

And a Standard Project dialog appears. You can select the device and the programming language from the drop-down list. Click **OK**, the system generates a cyclic task with a default PLC_PRG.

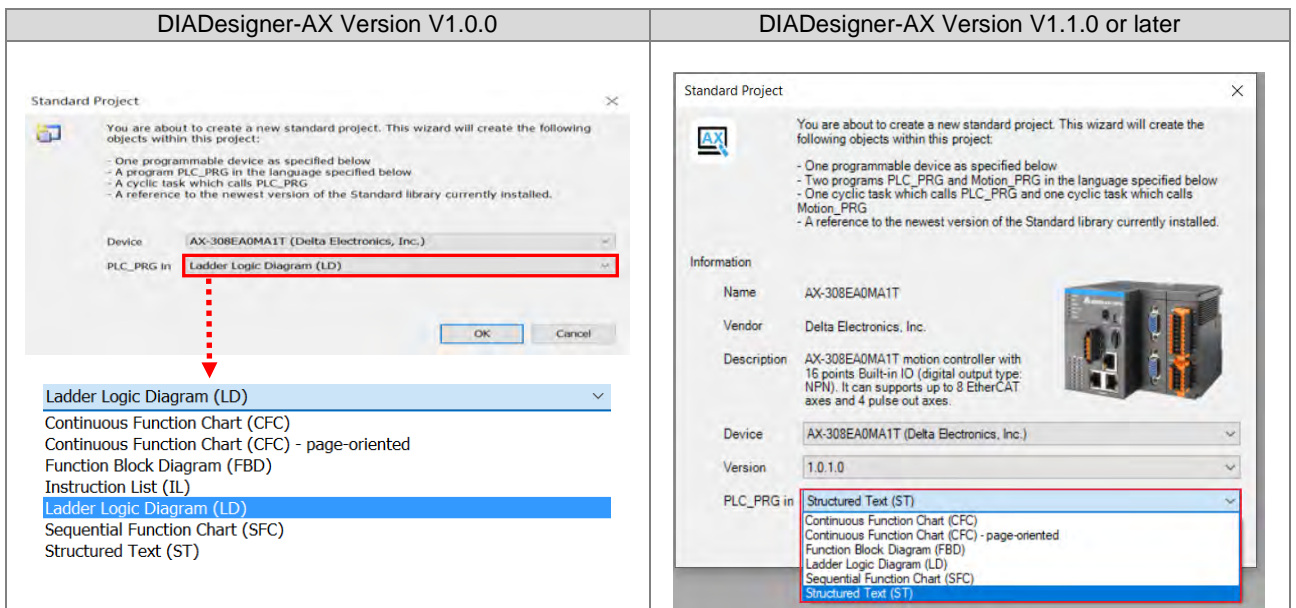

4

After a new project is successfully created, you can see a project management area in the left side of the window. All the options are listed in nodes. Click *View -> Devices (Alt+0)* on the toolbar, if nothing appears in the project management area.

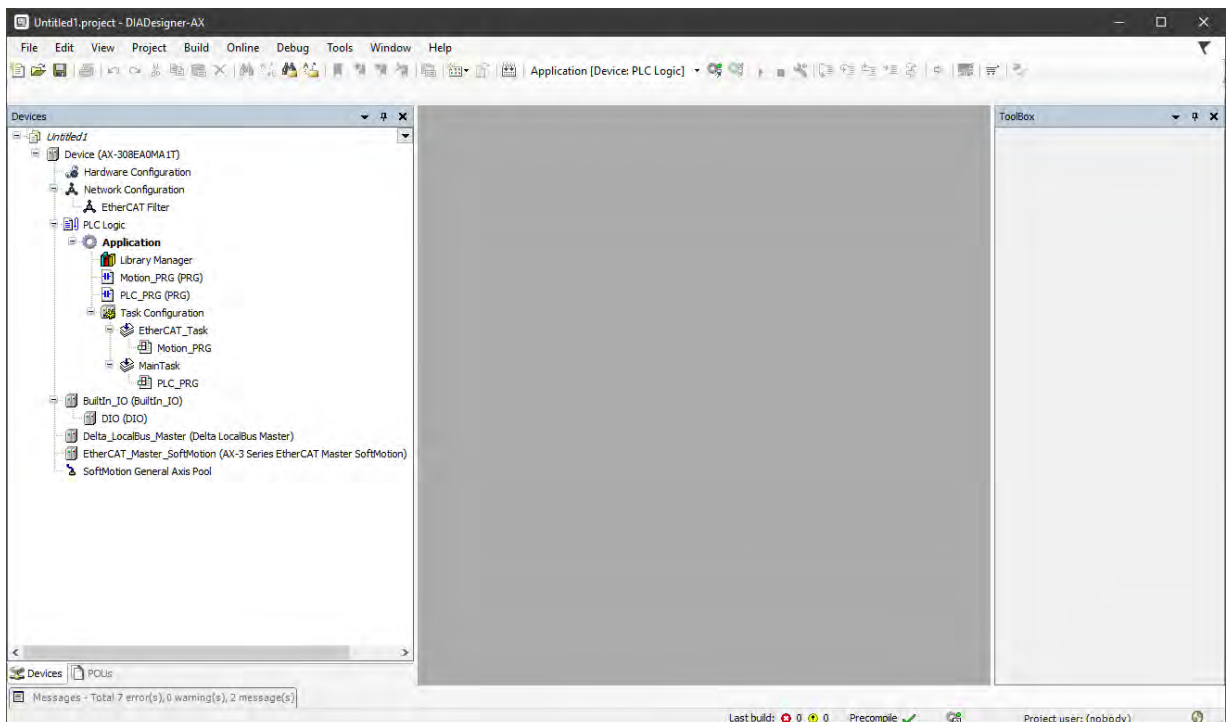

4.2 Setting Items on the Device Page

This section introduces all the setting items on the Device Page.

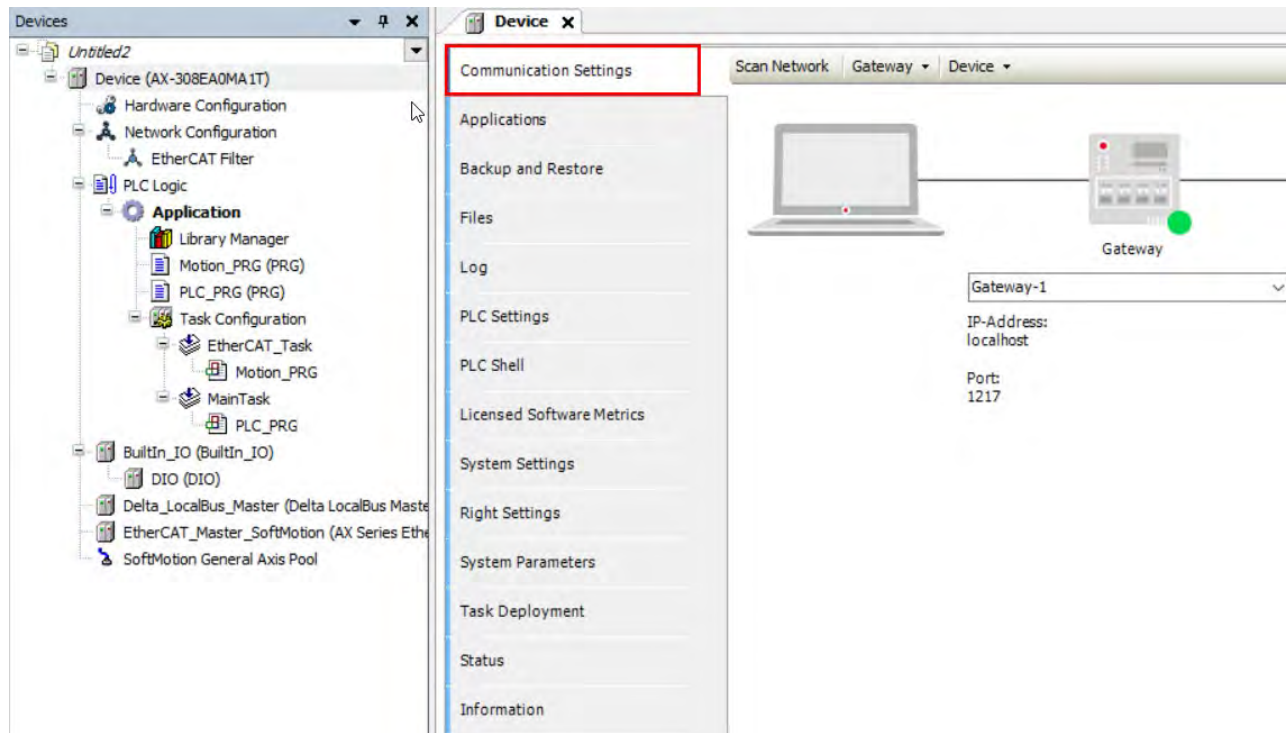

4.2.1 CPU Parameter Settings

4.2.1.1 Communication Settings

On the Communication Settings page, you can define the communication method for DIADesigner-AX and controller. Use the drop-down list of the Gateway tab to add new gateways or manage existing gateways or configure local gateways. You can simply specify an IP address or DNS address for the gateway while adding new gateways. This is useful if you want to connect to a remote gateway running on another PC or device. If you use DNS the address must begin with “dns”. For the setting of PLC, you can enter its IP address (e.g. 192.168.1.5) or its device name (e.g. AX-308EAOMA1T) in the field under the controller image. After that DIADesigner-AX scans to search for the PLC in the network of the gateway.

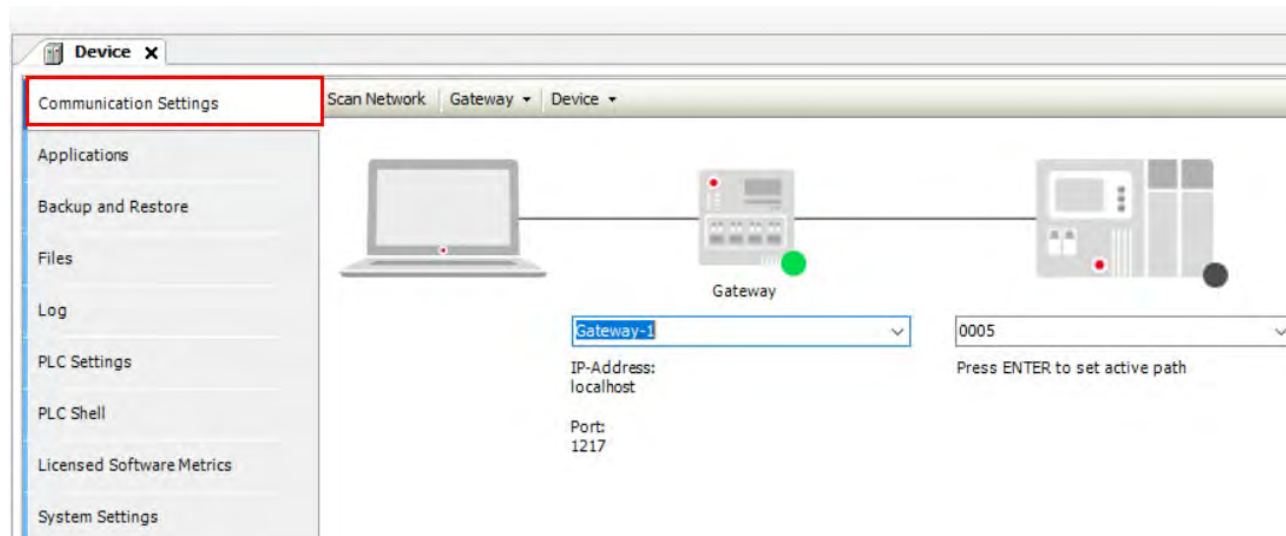

● Status of the Connection

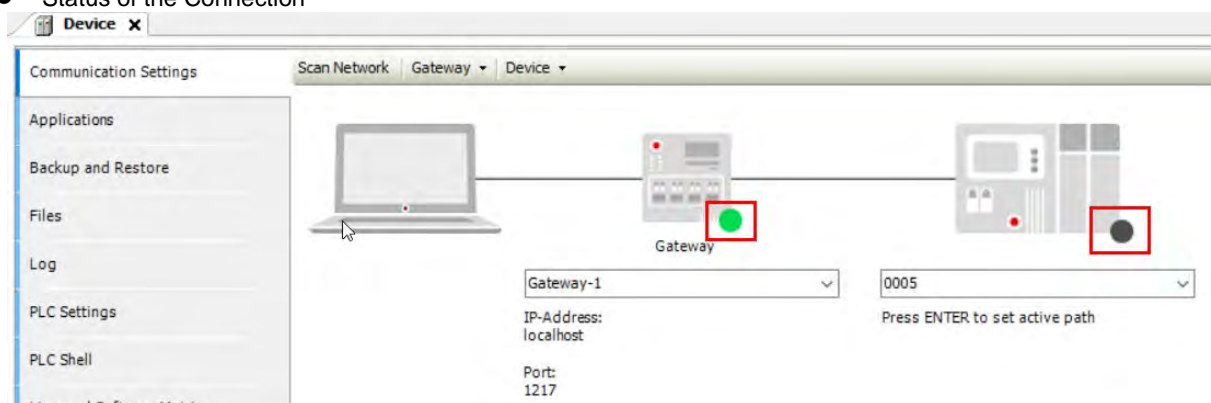

The dots under the images of gateway and controller indicate the connection status.

Red: Not be able to establish a connection

Green: A connection is established.

Black: Unknown connection status

Tab	Description
Scan Network	Click Scan Network to open the Select Device page. This page lists all configured gateways with the associated devices. You can select one target device from this list.
Gateway	This menu includes the following setting items: <ul style="list-style-type: none"> ● Add New Gateway: You can add and define a new gateway channel here. ● Manage Gateways: This page is with an overview of all gateways. You can add or delete entries here or change their order. ● Configure the Local Gateway: Select this setting item to open the Gateway Configuration page. You can configure the block drivers for the local gateway.
Device	This menu includes the following setting items: <p>Options:</p> <ul style="list-style-type: none"> ● Add Current Device to Favorites: Adds the currently set device to the list of favorite devices. ● Manage Favorite Devices: Click this option to open a list of all preferred devices. You can add or delete entries or change their order. The top device is the default. ● <input checked="" type="checkbox"/> : Filter Network Scans by Target ID: The display is limited on the devices that have the same target ID as the current device configured in the project. ● <input checked="" type="checkbox"/> : Confirm Online Mode: DIADesigner-AX requires you to confirm the followings when calling the following online commands (for safety purposes): Force values, Write values, Multiple loading, Remove force list, Single cycle, Start, and Stop. ● Store Communication Settings in Project: <ul style="list-style-type: none"> <input checked="" type="checkbox"/> : DIADesigner-AX saves the communication settings in the project for reuse on the same computer. Note: If you use the project on another computer, you need to reset the active path. <input type="checkbox"/> : DIADesigner-AX saves the communication settings in the options of the local installation for reuse on the same computer. <p>Note: When using DIADesigner-AX SVN, the option should be cleared in order to prevent blocking the device object.</p>

Tab	Description
	<p>Rename Active Device: Click this setting item to open the Change Device Name page.</p> <p>Wink Current Device: Devices that support this function illuminate a flashing signal.</p> <p>Send Echo Service: DIADesigner-AX sends five echo services to the PLC. These are used to test the network connection, similar to the ping function. The services are sent first without data packets and then with data packets. The scope of the data packets depends on the communication buffer of the PLC. A message box opens with information about the average echo service delay and the scope of the sent data packets.</p> <p>Encrypted Communication:</p> <p><input checked="" type="checkbox"/>: The communication to this controller is encrypted. A certificate of the controller is required in order to log in to the controller. If the certificate is not available, then an error message shows up prompting whether or not the certificate should be displayed and installed.</p> <p>If the Enforce Encrypted Communication option is selected as Security level in the <i>Security Screen</i> view, then the Encrypted Communication is disabled here.</p> <p>Change Communication Policy: Click this setting item to open the Change Communication Policy page for changing the device setting for the encryption of communication. If a new communication policy is selected in this dialog, then the configuration on the controller is changed.</p>
Communication	
Current policy	The currently selected policy for the encryption of communication
New policy	Drop-down list for the new policy for encryption <ul style="list-style-type: none"> • <i>No encryption:</i> The controller does not support encrypted communication. • <i>Optional encryption:</i> The controller supports encrypted and unencrypted communication. • <i>Enforced encryption:</i> The controller supports encrypted communication only.
Device User Management	
Current policy	The currently selected policy for user management
New policy	Drop-down list for the new policy for user management <ul style="list-style-type: none"> • <i>Optional user management:</i> It is the responsibility of the user to enable user management on the device or leave the device unprotected. • <i>Enforced user management:</i> The user management on the device is enabled and cannot be disabled by the user.

4.2.1.2 Applications

Here you can check and manage the applications on the PLC.

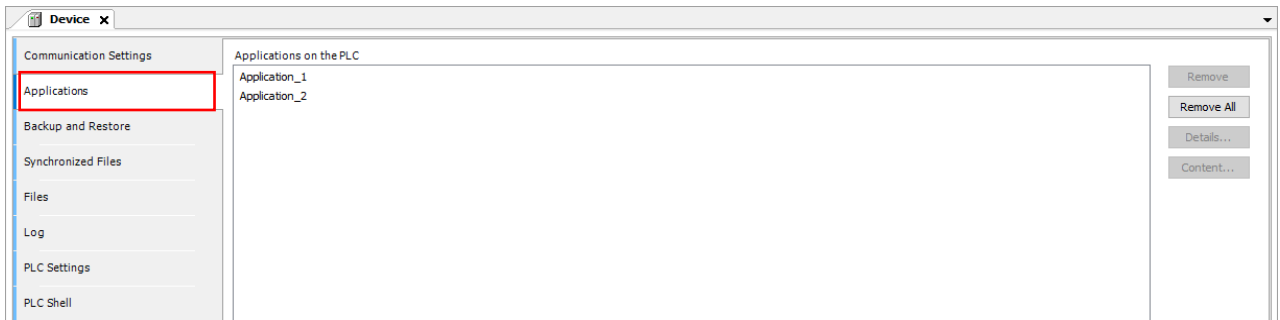

Button	Description
Remove / Remove All	Remove: Deletes the application selected in the list. Remove All: Deletes all listed applications on the PLC.
Details...	Click Details button to see information defined for the application on the Information tab of the dialog box Properties.
Content...	Requirement: Go to <i>Application > Proprieties > Application Generation Options</i> to activate the Download the application info option. This causes information about the contents of the application to be additionally loaded to the PLC. Click Content button to see additional information about the differences between the latest generated code and the application code that exists on the controller. The different modules are displayed in a comparison view.
Refresh List	Click Refresh List button to have the controller scanned for applications and the list is refreshed accordingly.

4.2.1.3 Backup and Restore

You can backup and restore the application-specific file on the PLC by saving and reading a zip archive.

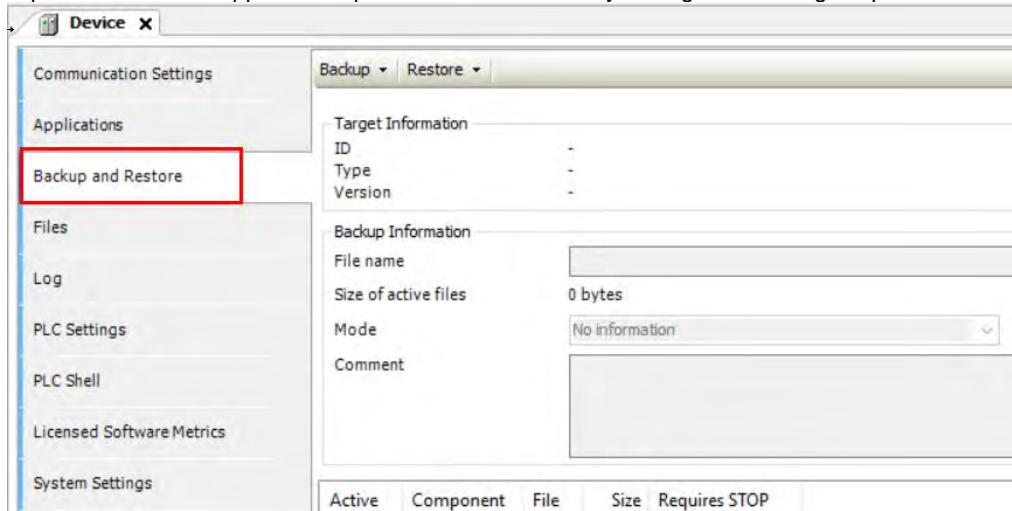

4

Tab	Description
Backup	<p>Click Backup tab to see the followings</p> <ul style="list-style-type: none"> ● Read Backup Information from Device: Use this function to search for application-specific files from the \$PlcLogic\$ directory of the PLC and lists them on the Backup tab page. ● Create Backup File and Save to Disk: Use this function to compress the files in into a backup zip file. The file extension is tbf (=“Target Backup File”). ● Save Backup File to Device: Use this function to save the backup file to the TBF directory of the PLC.
Restore	<ul style="list-style-type: none"> ● Load Backup File from Disk: After clicking this button, the system generates a list of all backup files found on the disk. Select one of these files to view its contents. ● Load Backup File from Device: After clicking this button, the system generates a list of all backup files found on the PLC. Select one of these files to view its contents. ● Restore on Device: This function is available if at least one component of the backup file that is currently loaded in the tabbed page is set to active. It prompts for restoring the application status on the device.

● **Target Information**

ID	ID of the PLC
Type	Device type
Version	Device version





● **Backup Information**

File name	Storage path of the backup file.
Size of active files	Total size of the files set as active in the table
Mode	Defines the scope of the backup: Application. The application-related files are added to the archive.
Comment	Optional entry for comments to be saved in the meta.info file of the backup and reading when the files are restored.

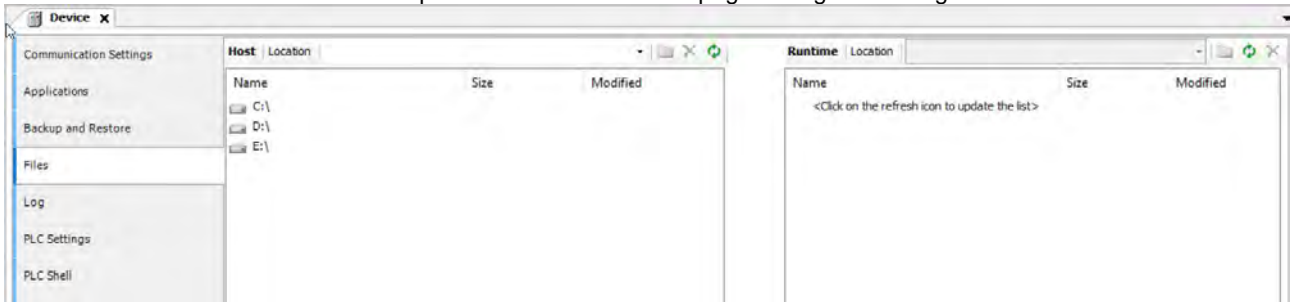
4.2.1.4 Files

You can transfer files between the computer and the PLC on this page through DIADesigner-AX. .









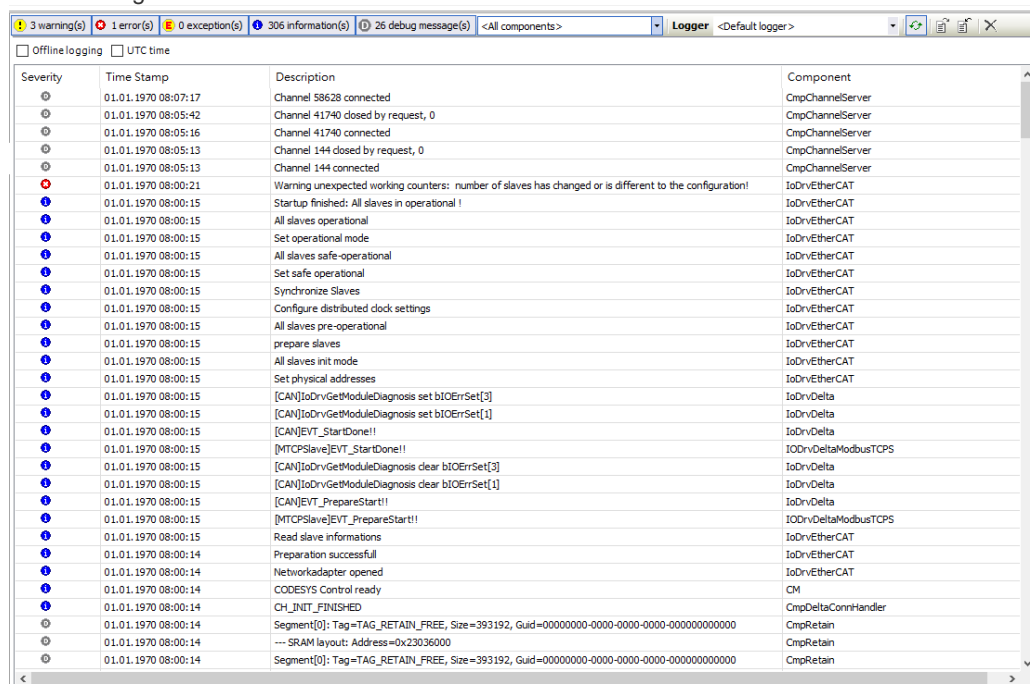

Item	Description
Location	Path in the file system of the computer. Subdirectories and files are shown in the lower part of the view with name, size, and change date.
	Click this button to create a new file folder
	Deletes the selected files or folders
	Updates the list of files and folders for the set path (location)
	Write File to the PLC
	Write File from the PLC

4.2.1.5 Log

You can view the PLC log here. It lists the events that were recorded on the target system, including

- Events during the startup and shutdown of the system (components loaded, with version)
- Application download and loading of the boot application
- Custom entries
- Log entries from I/O drivers
- Log entries from data sources



Item	Description
Offline logging	<input type="checkbox"/> : Default settings <input checked="" type="checkbox"/> : The PLC also records actions that are not related to the connection with the controller. However, this is currently available only for the safety version of CODESYS.
UTC time	<input type="checkbox"/> : Standard setting; the time stamp is converted to the local time on the computer as indicated by the time zone of the operating system. <input checked="" type="checkbox"/> : The time stamp of the runtime system is displayed.
Severity	Four categories for the severity of the event: <ul style="list-style-type: none"> •  : Message •  : Warning •  : Error •  : Debugging You can show or hide each category by clicking corresponding buttons in the bar. Each button shows the number of log entries of the category concerned.
Time stamp	Date and time (example: 08-01-2020 09:48)
Description	Description of the event
Component	Name of the runtime system component concerned, e.g. CmpApp
Drop-down list with component names	The log list displays only events that concern the selected component
Logger	Drop-down list with all available logs. The standard setting is the <Default Logger> specified by the target system; now it is identical to 'StdLogger for DIADesigner-AX runtime system.'
	 Refreshes the log list
	 Exports the list contents to an xml file.
	 Imports a log list from an xml file.  Deletes the displayed log list. All entries are deleted.

4

4.2.1.6 PLC Settings

You can make the basic settings for the configuration of the PLC here, for example the handling of inputs and outputs and the bus cycle task.

① Application for I/O handling

Item	Description
Application for I/O handling	Application that is for the I/O handling.

② PLC Settings

Item	Description
Update IO while in stop	<input type="checkbox"/> : DIADesigner-AX does not refresh the values of the input and output channels when the PLC is in the stop state. <input checked="" type="checkbox"/> : DIADesigner-AX refreshes the values of the input and output channels even if the PLC is in the stop state. If the watchdog detects a malfunction, the outputs are set to the predefined default values.
Behavior of the outputs in stop	Handling of the output channels when the controller enters the stop state: <ul style="list-style-type: none"> • Keep current values: The current values are retained. • Set all outputs to default: The default values resulting from the I/O mapping are assigned. • Execute program: You can control the handling of the output values via a program contained in the project, which DIADesigner-AX executes at “STOP”. Enter the name of the program in the field on the right.
Always update variables	Global setting that defines whether or not DIADesigner-AX updates the I/O variables in the bus cycle task. This setting is effective for I/O variables of the slaves and modules only if 'disabled' is defined in their update settings. <ul style="list-style-type: none"> • Disabled (update only if used in a task): DIADesigner-AX updates the I/O variables only if they are used in a task. • Enabled 1 (use bus cycle task if not used in another task): DIADesigner-AX updates the I/O variables in the bus cycle task if they are not used in any other task. • Enabled 2 (always in bus cycle task): DIADesigner-AX updates all variables in each cycle of the bus cycle task, regardless of whether they are used and whether they are mapped to an input or output channel.

③ Bus Cycle Options

Item	Description
Bus cycle task *1	Task that controls the bus cycle. By default the task defined by the device description is entered.

Note 1: Before you select the <unspecified> setting for the bus cycle task, you should be aware that “<unspecified>” means that the default setting given in the device description goes into effects. You should therefore check this description. Use of the task with the shortest cycle time may be defined as the default there, but use of the task with the longest cycle time could equally well be defined!

④ Additional Settings

Item	Description
Generate Force variables for I/O mapping	The device does not support this function.
Enable Diagnostics for devices	<input checked="" type="checkbox"/> : DIADesigner-AX automatically integrates the library CAA Device Diagnosis in the project and creates an implicit function block for each device. If there is already a function block for the device, then either an extended FB is used (for example with EtherCAT) or a further FB instance is added. This then contains a general implementation of the device diagnostics.
Show I/O warnings as errors	Warnings concerning the I/O configuration are displayed as errors.

4

4.2.1.7 PLC Shell

You can use this text-based control monitor for querying specific information from the controller. You can specify device-dependent commands for this and receive the response from the controller in a result window.

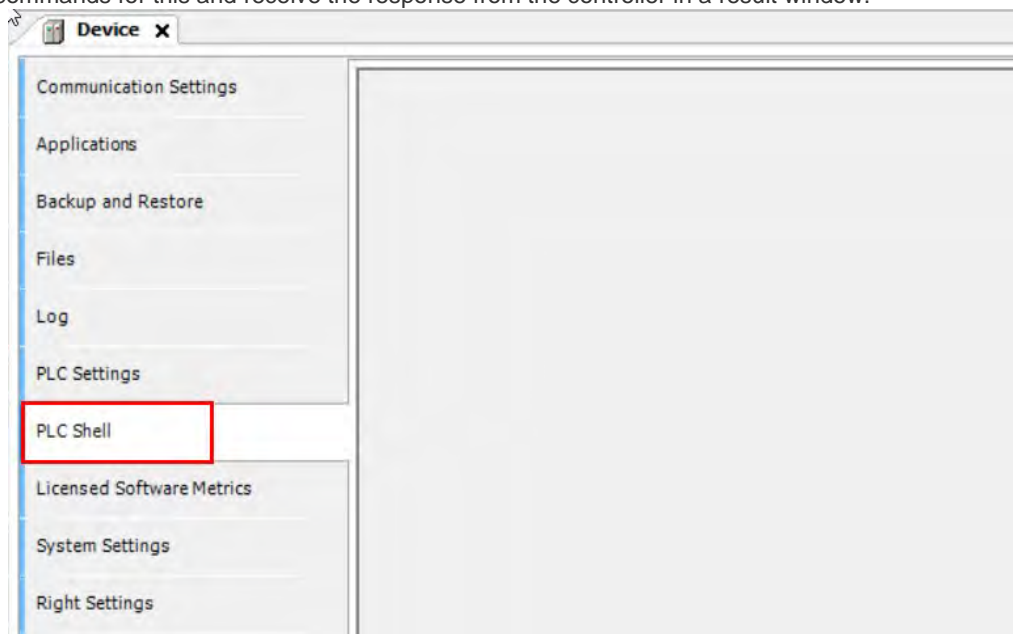

4.2.1.8 Licensed Software Metrics

Here you can find the code sizes of the applications of the open project. The data is updated when clicking *Build -> Generate Code* or *Online -> Login*. If the compile information is deleted, the data of the corresponding application shown here is reset.

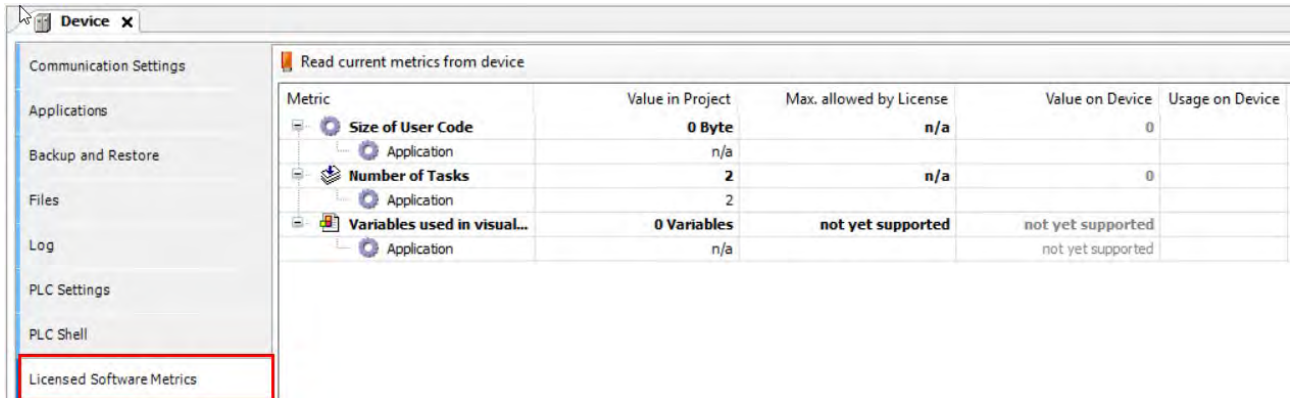

Metric	Value in Project	Max. allowed by License	Value on Device	Usage on Device
Size of User Code	0 Byte	n/a	0	
Application	n/a			
Number of Tasks	2	n/a	0	
Application	2			
Variables used in visual...	0 Variables	not yet supported	not yet supported	
Application	n/a		not yet supported	

4.2.1.9 System Setting

Here you can set up the system settings for the AX-3 Series PLC. Before setting up, make sure that DIADesigner-AX is successfully connected to AX-3 Series PLC. Refer to section 4.2.1.1 for establishing the connection between DIADesigner-AX and AX-3 Series PLC.

Note: the name of this setting page was “Runtime Clock Configuration” in DIADesigner-AX V1.0.0. Now in DIADesigner-AX V1.1.0, this page is named “System Settings”, given that Network Settings are included here.

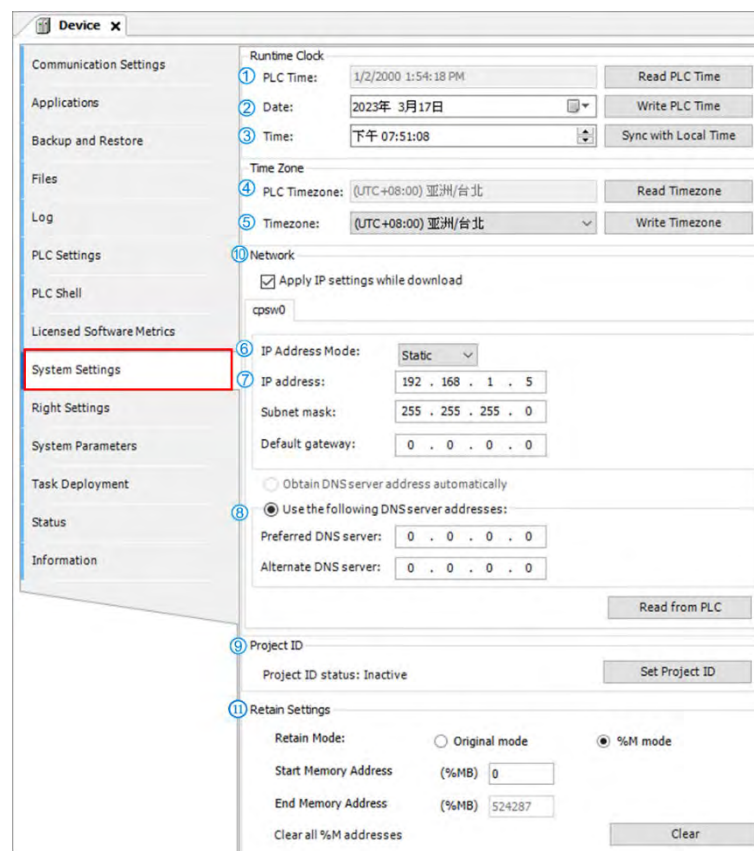

Runtime Clock

① PLC Time: 1/2/2000 1:54:18 PM

② Date: 2023年 3月17日

③ Time: 下午 07:51:08

Time Zone

④ PLC Timezone: (UTC+08:00) 亚洲/台北

⑤ Timezone: (UTC+08:00) 亚洲/台北

⑩ **Network**

Apply IP settings while download

cpw0

⑥ IP Address Mode: Static

⑦ IP address: 192 . 168 . 1 . 5

Subnet mask: 255 . 255 . 255 . 0

Default gateway: 0 . 0 . 0 . 0

Obtain DNS server address automatically

⑧ Use the following DNS server addresses:

Preferred DNS server: 0 . 0 . 0 . 0

Alternate DNS server: 0 . 0 . 0 . 0

⑨ **Project ID**

Project ID status: Inactive

⑪ **Retain Settings**

Retain Mode: Original mode %M mode

Start Memory Address (%MB) 0

End Memory Address (%MB) 524287

Clear all %M addresses

● **Runtime Clock**

- ① **PLC Time:** Use the button **Read PLC Time** to read the PLC current date and time and the result will be updated here.
- ② **Date:** Use the button **Write PLC Time** to write the date on DIADesigner-AX (PC) into PLC and the result will be updated here.
- ③ **Time:** Use the button **Sync with Local Time** to write the time on DIADesigner-AX (PC) into PLC and the result will be updated here.

● **Time Zone**

- ④ **PLC Timezone:** Use the button **Read Timezone** to read the PLC current timezone and the result will be updated here.
- ⑤ **Timezone:** Use the button **Write Timezone** to write the timezone on DIADesigner-AX (PC) into PLC and the result will be updated here.

● **Network (available for DIADesigner-AX V1.1.0 or later)**

- ⑥ **IP Address Mode:** Static.
- ⑦ **IP address:** You can input your own IP address, Subnet mask and Default gateway.
- ⑧ **DNS settings:** You can obtain DNS server address automatically or define your own DNS server addresses.
- ⑩ **Apply IP settings while download*4:** The IP address setting is effective once the parameters are downloaded.

● **Project ID**

- ⑨ **Set Project ID:** After enabling Project ID feature, this setting must be complete before downloading projects.

● **Retain Settings**

⑪ **Retain Settings*4**

Retain Mode for the variables:

- Original mode: Determined by the retainability of the variable type.
- %M mode: If the variable is in the section of %M, it is retainable.
 - ◆ Start Memory Address: If the variable is in the starting address of the %M section (not user-defined).
 - ◆ End Memory Address: If the variable is in the ending address of the %M section (not user-defined).
 - ◆ Clear all %M addresses: Clear the values in the %M section.

***Note:**

1. Diamond directive files of AX series PLCs must be V1.0.1.0 and above so as to configure the network parameter settings on this page.
2. Model AX-332 PLCs support dual LAN ports and the network settings are shown in the figure below. If the checkbox of Enable Gateway and DNS Setting is checked, you would only be able to configure the setting values of PLC Gateway and DNS configuration on the tab page (GLAN1) as shown in the figure below. If the checkbox is unchecked, the fields of setting values would be grey and not editable.
3. With firmware version 1.0.4.0 and above, the operation of Project ID feature is detailed in chapter 8.2 in DIADesigner-AX user manual.

Network

GLAN1 GLAN2

Enable Gateway and DNS Setting

IP Address Mode: Static

IP address: 192 . 168 . 0 . 10

Subnet mask: 255 . 255 . 255 . 0

Default gateway: 0 . 0 . 0 . 0

Obtain DNS server address automatically

Use the following DNS server addresses:

Preferred DNS server: 0 . 0 . 0 . 0

Alternate DNS server: 0 . 0 . 0 . 0

Read from PLC

- This functionality is only available for AX-3 Series PLC with firmware version 1.0.5.0 or later which can be found in the DDF file.



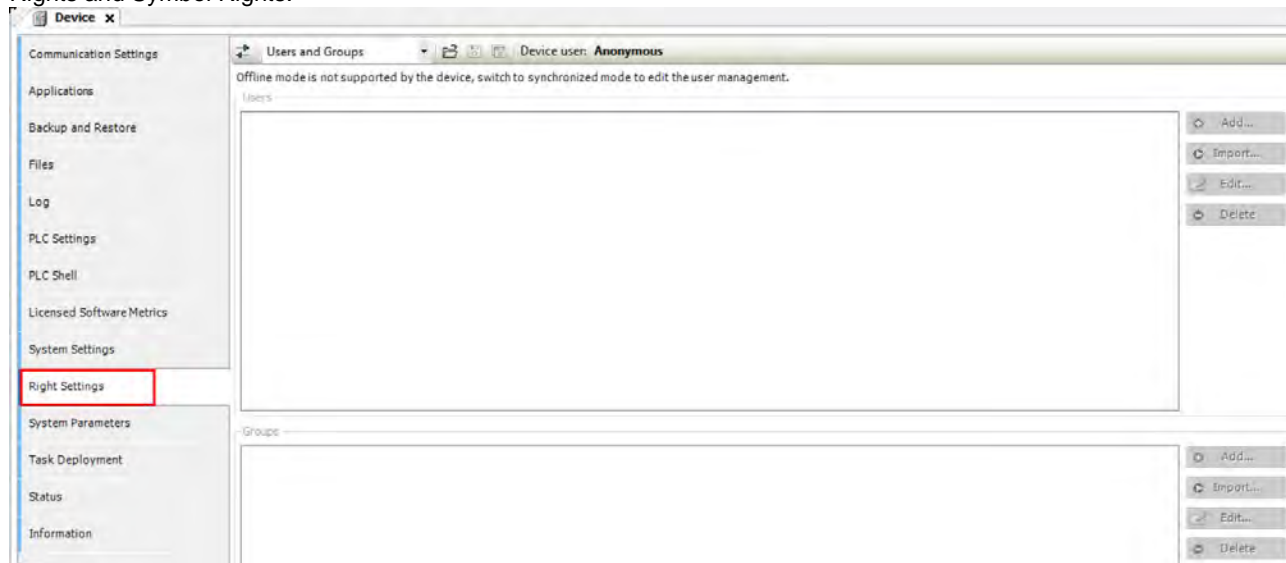

4.2.1.10 Right Settings

Settings here are only available for DIADesigner-AX V1.3.0 or later. The settings include Users and Groups, Access Rights and Symbol Rights.



4

● **Toolbar of the tab**

Item	Description
 Synchronization	1. Switches on and off the synchronization between the editor and the user management on the device. 2. If the button is not pressed, then the editor is blank or it contains a configuration that you loaded from the hard disk. 3. If the button is pressed, then DIADesigner-AX synchronizes the display in the editor continuously with the current user management on the connected device. 4. If you activate the synchronization while the editor contains a user configuration that is not synchronized with the device yet, then you are prompted what should happen to the editor contents. Options: <ul style="list-style-type: none"> Upload from the device and overwrite the editor content: The configuration on the device is loaded into the editor, overwriting the current contents. Download the editor content to the device and overwrite the user management there: The configuration in the editor is transferred to the device and applied there.
 Import from disk	Click this button and then to select and import a user management configuration from the file.
 Export to disk	Click this button and then to save the current user management configuration as an XML file.
 Export all to disk	Click this button and then to save all the user management configurations as an XML file.
Device user	User name of the user currently logged in on the device

4.2.1.10.1 Users and Groups

It is important that the firmware version of AX-3 Series PLC should work with specific software version of DIADesigner-AX. If not, this functionality cannot be used. You can upgrade either the firmware or the software to make them compatible with each other.

Firmware Interoperability

Group	Firmware version of AX-3	Software version of DIADesigner-AX
1	V1.0.4 or previous versions	V1.3.0
2	V1.0.5 or later versions	V1.4.0

- **For Group 1:**

You can edit the device user management of the controller, define user accounts and user groups. In combination with the configuration on the Access Rights tab, you can control access to control objects and files at runtime. For the first time use, use default settings "Administrator" as the user name and password. After logging-in, for security reasons, change the defaults of the username and password.

- **For Group 2:**

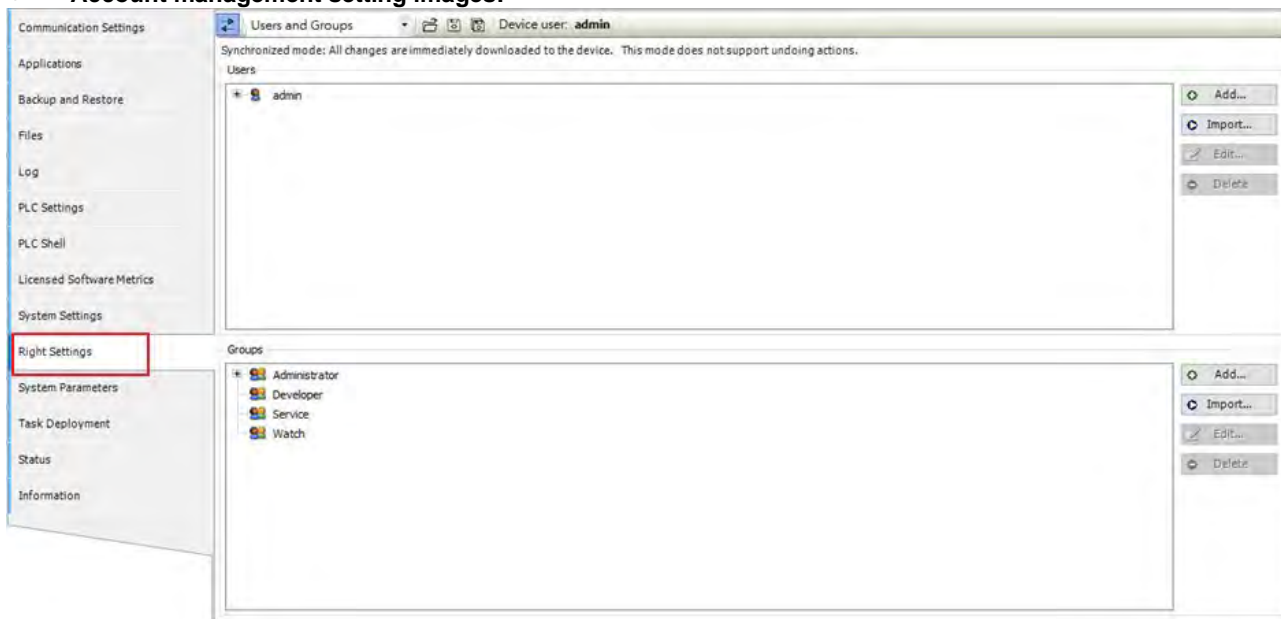

You will need to set up the user account and password for the first time use.

● Account management setting images:







4





● Toolbar of the tab

Item	Description
 Synchronization	<ol style="list-style-type: none"> Switches on and off the synchronization between the editor and the user management on the device. If the button is not pressed, then the editor is blank or it contains a configuration that you loaded from the hard disk. If the button is pressed, then DIADesigner-AX synchronizes the display in the editor continuously with the current user management on the connected device. If you activate the synchronization while the editor contains a user configuration that is not synchronized with the device yet, then you are prompted what should happen to the editor contents. Options: <ul style="list-style-type: none"> Upload from the device and overwrite the editor content: The configuration on the device is loaded into the editor, overwriting the current contents. Download the editor content to the device and overwrite the user management there: The configuration in the editor is transferred to the device and applied there.
 Import from disk	Click this button and then to select and import a user management configuration from the file.
 Export to disk	Click this button and then to save the user management configuration as an XML file.
Device user	User name of the user currently logged in on the device

● Users

Item	Description
 Add	Click this button to create a new user account. ^{*1}
 Import	Click this button to select the desired entries to import users into the device user management. ^{*2}
 Edit	Click this button to change the settings of the selected user account.
 Delete	Click this button to delete the account of the selected user.

● **Groups**

Item	Description
 Add	Click this button to create a new user group. ^{*3}
 Import	Click this button to select the desired entries to import groups into the device user management. ^{*4}
 Edit	Click this button to change the settings of the selected group.
 Delete	Click this button to delete the selected group.

Note 1: The **Add User** setting page

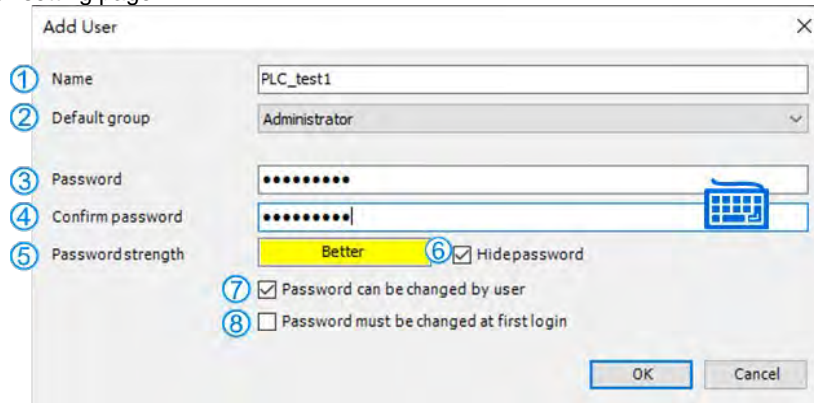

	Item	Description
①	Name	User name
②	Default group	Use the drop-down list to select the default group
③	Password	Password
④	Confirm password	Confirm password
⑤	Password strength	Levels from <i>Very weak</i> to <i>Very good</i>
⑥	Hide password	<input checked="" type="checkbox"/> : The password is shown only with asterisks "*" when it is typed in.
⑦	Password can be changed by user	<input checked="" type="checkbox"/> : Password can be changed by the user
⑧	Password must be changed at first login	<input checked="" type="checkbox"/> : Password must be changed at first login

Note 2: The **Import User** setting page

After selected the user from the list, click **OK** to import.

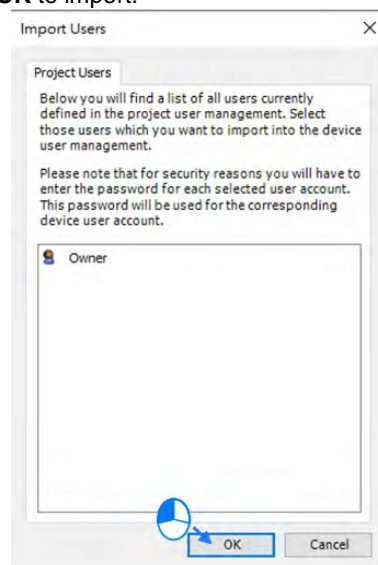

Note 3: The **Add Group** setting page

Type in the new group name and select the to-be-added group members for this new group and then click **OK**.

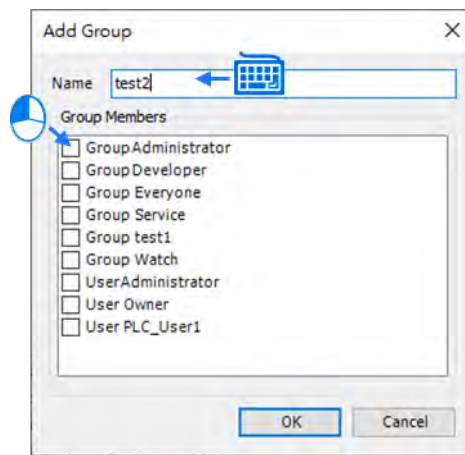

4

Note 4: The **Import Group** setting page

After selected the group from the list, click **OK** to import.

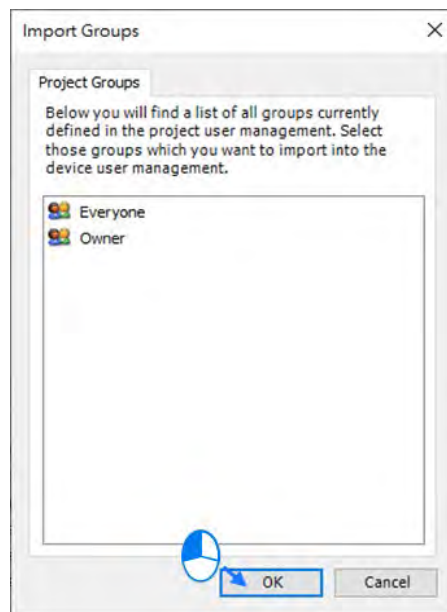

4.2.1.10.2 Access Rights

Here you can define the device access rights of device users to objects on AX-3 Series PLC. As in the project user management, users must be members of at least one user group and only user groups can be granted certain access rights.

Requirements for the Access Rights tab to be displayed:



- In the DIADesigner-AX options, in the Device editor category, the Show access rights page option must be selected.
Note that this DIADesigner-AX option can be overwritten by the device description.

Requirements for the access rights to be granted to user groups

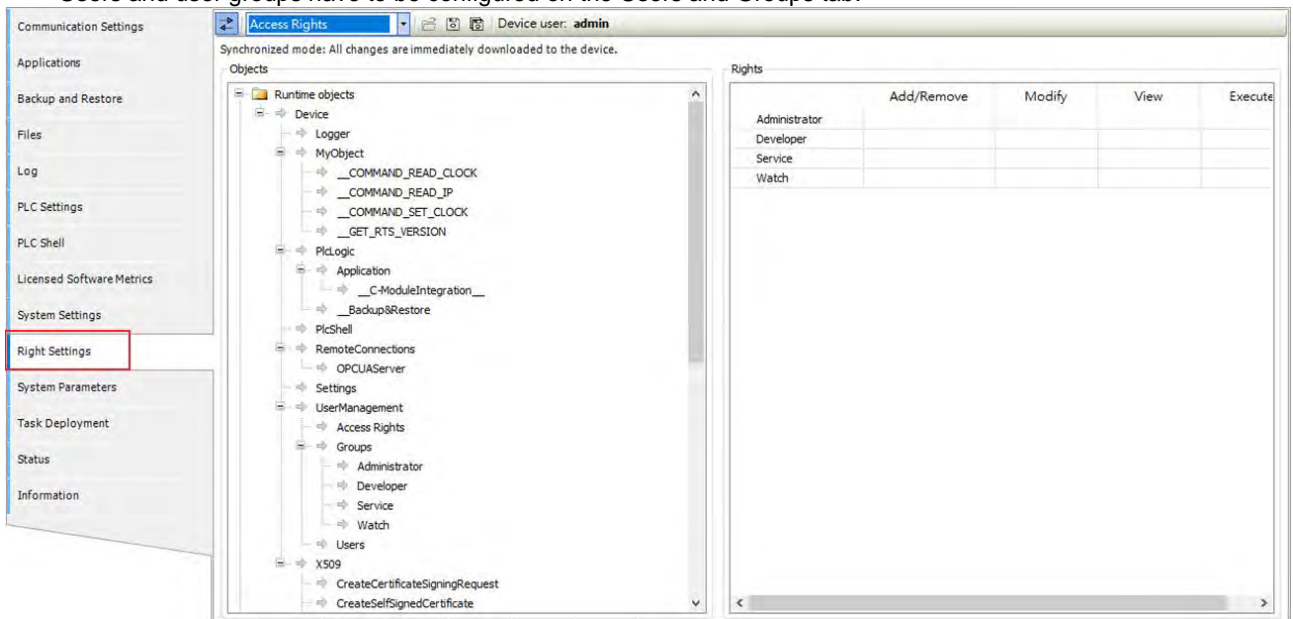
- A component for the user management has to be available on AX-3 Series PLC. That is the primary requirement.
- Users and user groups have to be configured on the Users and Groups tab.



- **Toolbar of the tab**

Item	Description
 Synchronization	<ol style="list-style-type: none"> 1. Switches on and off the synchronization between the editor and the user management on the device. 2. If the button is not pressed, then the editor is blank or it contains a configuration that you loaded from the hard disk. 3. If the button is pressed, then DIADesigner-AX synchronizes the display in the editor continuously with the current user management on the connected device. 4. If you activate the synchronization while the editor contains a user configuration that is not synchronized with the device yet, then you are prompted what should happen to the editor contents. Options: <ul style="list-style-type: none"> • Upload from the device and overwrite the editor content: The configuration on the device is loaded into the editor, overwriting the current contents. • Download the editor content to the device and overwrite the user management there: The configuration in the editor is transferred to the device and applied there.
 Import from disk	Click this button and then to select and import a user management configuration

Item	Description
	from the file.
 Export to disk	Click this button and then to save the user management configuration as an XML file.
Device user	User name of the user currently logged in on the device

● **Objects**

Description
In the tree structure, the objects are listed to which actions can be executed at runtime. The objects are each assigned by their object source and partially sorted in object groups. In the Rights view, you can configure the access options for a user group to a selected object.
Object source (root node) <ul style="list-style-type: none"> File system objects ▶ Device: In these objects, the rights can be granted to folders of the current execution directory of the AX-3 Series PLC. Runtime objects ▶ /: In these objects, all objects are managed that have online access in the AX-3 Series PLC and therefore have to control the access rights. <p>A description of the objects is located in the table. Overview of the objects</p>
Object groups and objects (indented) Example: Device with child nodes Logger, PlcLogic, Settings, UserManagement.

● **Rights**

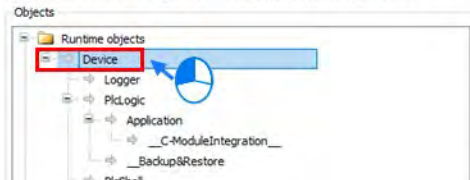
Description																																			
In general, the access rights are inherited from the root object (also Device or /) to the sub-objects. This means that if a permission of a user group is denied or explicitly granted to a parent object, then this first affects all child objects. The table applies for the object that is currently selected in the tree. For every user group, it shows the rights currently configured for the possible actions on this object.																																			
<div style="display: flex; align-items: flex-start;"> <div style="flex: 1;"> <p>Synchronized mode: All changes are immediately downloaded to the device.</p>  </div> <div style="flex: 1;"> <p>Rights</p> <table border="1"> <thead> <tr> <th></th> <th>Add/Remove</th> <th>Modify</th> <th>View</th> <th>Execute</th> </tr> </thead> <tbody> <tr> <td>Administrator</td> <td style="text-align: center;">+</td> <td style="text-align: center;">+</td> <td style="text-align: center;">+</td> <td style="text-align: center;">+</td> </tr> <tr> <td>Developer</td> <td style="text-align: center;">+</td> <td style="text-align: center;">-</td> <td style="text-align: center;">+</td> <td style="text-align: center;">-</td> </tr> <tr> <td>Everyone</td> <td style="text-align: center;">-</td> <td style="text-align: center;">-</td> <td style="text-align: center;">+</td> <td style="text-align: center;">-</td> </tr> <tr> <td>Service</td> <td style="text-align: center;">+</td> <td style="text-align: center;">-</td> <td style="text-align: center;">+</td> <td style="text-align: center;">-</td> </tr> <tr> <td>test_group</td> <td style="text-align: center;">x</td> <td style="text-align: center;">x</td> <td style="text-align: center;">x</td> <td style="text-align: center;">x</td> </tr> <tr> <td>Watch</td> <td style="text-align: center;">-</td> <td style="text-align: center;">-</td> <td style="text-align: center;">+</td> <td style="text-align: center;">-</td> </tr> </tbody> </table> </div> </div>		Add/Remove	Modify	View	Execute	Administrator	+	+	+	+	Developer	+	-	+	-	Everyone	-	-	+	-	Service	+	-	+	-	test_group	x	x	x	x	Watch	-	-	+	-
	Add/Remove	Modify	View	Execute																															
Administrator	+	+	+	+																															
Developer	+	-	+	-																															
Everyone	-	-	+	-																															
Service	+	-	+	-																															
test_group	x	x	x	x																															
Watch	-	-	+	-																															
Possible actions on the object: <ul style="list-style-type: none"> Add/Remove Modify View Execute 																																			
When an object is clicked, a table on the right side shows the access rights of the available user groups for the selected object. This allows you to quickly see: <ul style="list-style-type: none"> Which access rights are evaluated by an object Which user group has which effective rights to which object 																																			
Meanings of the symbols																																			

- **+**: Access right granted explicitly
- **-**: Access right denied explicitly
- **+**: Access right granted through inheritance
- **-**: Access right denied through inheritance
- **X**: The access right was not granted or denied explicitly and also not inherited by the parent object. Access is not possible.
- No symbol: Multiple objects are selected that have different access rights.

Change the permission by clicking the symbol.

- **Overview**

- ◆ **Runtime objects > Device**

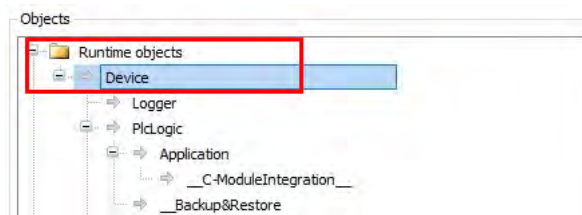

- **Device > Logger**

The Logger object on the Access Rights tab was created by the “Logger” component and controls its access rights. The possible access rights for this object can be granted only for the View action.

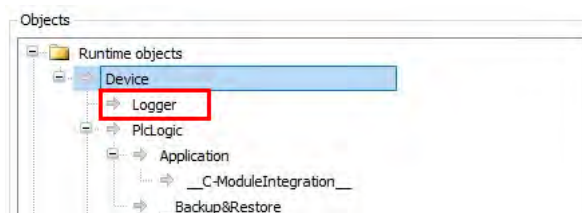

- **Device > PlcLogic**

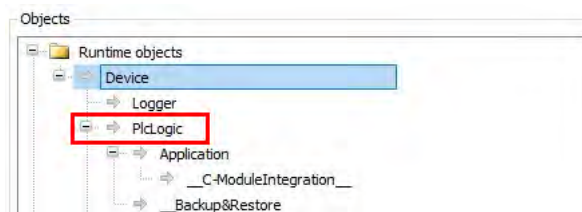

All IEC applications are inserted here automatically as child objects during download. When an application is deleted, it is removed automatically. This allows specific control of online access to the application. Access rights can be assigned centrally over all applications in the PlcLogic. The Administrator and Developer user groups have full access to the IEC applications. The Service and Watch user groups only have read access (for example for read-only monitoring of values).

➤ **PlcLogic > Application**

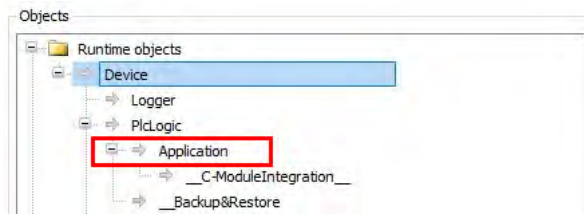

The following table shows which action is affected in particular when a specific access right is granted for an IEC application.

x: The right has to be set explicitly.

-: The right is not relevant.

	Operation	Access rights			
		Add/Remove	Execute	Modify	View
Application	Login	•	•	•	x
	Create	x	•	•	•
	Create child object	x	•	•	•
	Delete	x	•	•	•
	Download / online change	x	•	•	•
	Create boot application	x	•	•	•
	Read variable	•	•	•	x
	Write variable	•	•	x	x
	Force variable	•	•	x	x
	Set and delete breakpoint	•	x	x	•
	Set next statement	•	x	x	•
	Read call stack	•	•	•	x
	Single cycle	•	x	•	•
	Switch on flow control	•	x	x	•
	Start / Stop	•	x	•	•
	Reset	•	x	•	•
	Restore retain variables	•	x	•	•
Save retain variables	•	•	•	x	

➤ **PlcShell**

Only the Modify permission is evaluated at this time. This means that only when the Modify permission has been granted to a user group can PLC shell commands also be evaluated.

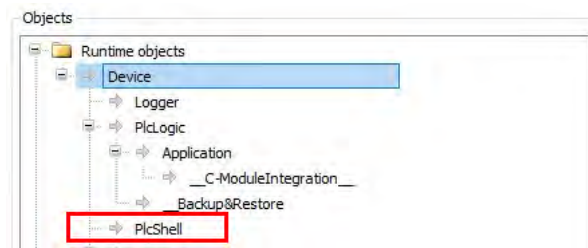

➤ **RemoteConnections**

Additional external connections to the AX-3 Series PLC can be configured below this node. Currently, access to the OPC UA server can be configured here.



➤ **Settings**

This is the online access to the configuration settings of the AX-3 Series PLC. By default, access to Modify is granted only to the administrator.

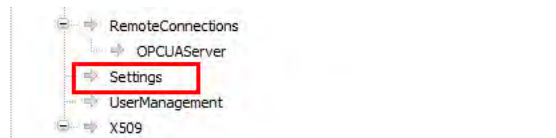

➤ **UserManagement**

This is the online access to the user management of AX-3 Series PLC. By default, read/write access is granted only to the administrator.

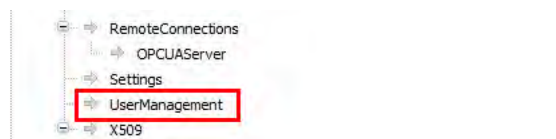

➤ **X509**

This controls the online access to the X.509 certificates. Two types of access are distinguished here:

Read (View)

Write (Modify)

Every operation is assigned to one of these two access rights. Each operation is inserted as a child object below X509. Therefore, access per operation can now be fine-tuned even more.

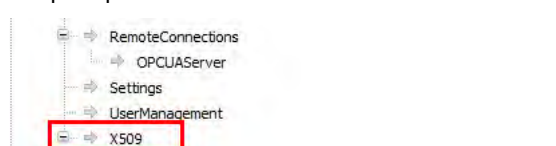

◆ **File system objects > /**

All folders from the execution path of the AX-3 Series PLC are inserted below the “/” file system object. This allows you to grant specific rights to each folder of the file system.

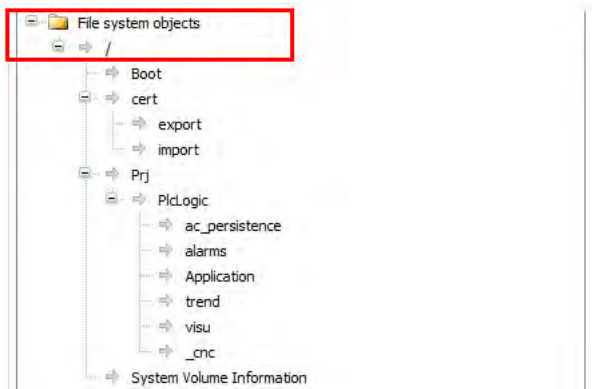





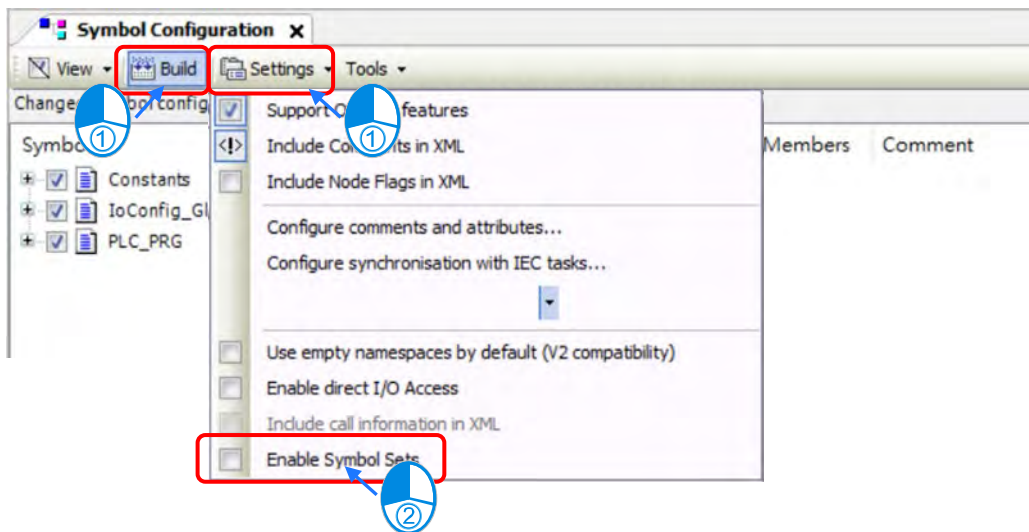

4

4.2.1.10.3 Symbol Rights

Here you can define the access rights of different user groups to the individual symbol sets available on the AX-3 Series PLC. Before that you need to enable the Symbol set under Symbol Configuration and then download the project to the controller. See the following examples for reference.



Use the icons  or  for synchronization. Upload the controller current parameters to the DIADesigner-AX3 and then you can set up the access right. You can find the user groups in the column of Rights. And when you select the Application under Symbol Sets you can see the corresponding access right for different user groups in the column of Rights. : Access granted; : Access not granted. You can change the access rights by double-clicking the symbol. Click the  button to save the current access configuration to an XML file. The file type is Device symbol management files (*.dsm). Click the  button to read a file like this from the computer.

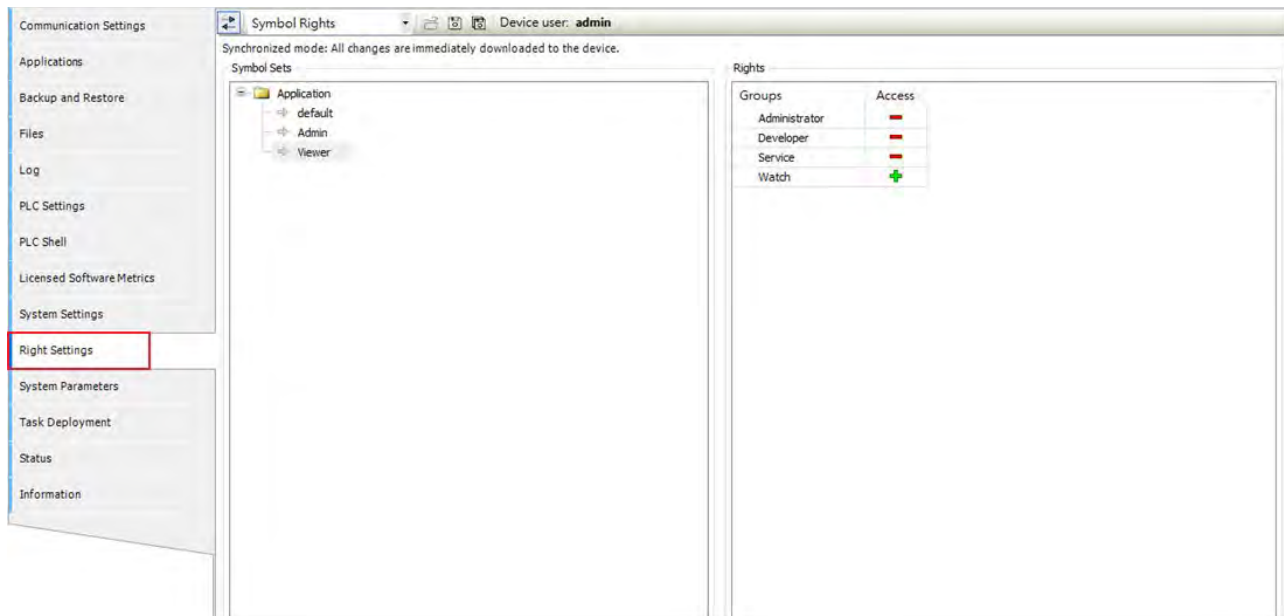

4.2.1.11 System Parameters

Here you can set up the various parameters for the AX-3 Series PLC. Note that settings on this page do NOT support on-line editing.

Parameter	Type	Value	Default Value	Unit	Description
I/O module CONFIG by Manual/Max when Power On	Enumeration of BOOL	Manual	Manual		
CPU module Stop when I/O Module No Response	Enumeration of BOOL	Stop	Stop		
CPU module Stop when I/O Module Occurred Error	Enumeration of BOOL	Keep Run	Keep Run		
Select Action when 24V dc Input unstable	Enumeration of BOOL	Continue Running when power stable	Continue Running when power stable		
Show Battery Low Voltage Error	Enumeration of BOOL	Enable	Enable		
Execute Startup Command when Power On	Enumeration of BOOL	Enable	Enable		

4

- **I/O module CONFIG by Manual/Max when Power On**

You can set the number of I/O modules here.

- Manual (default): The actual module placement should be based on the configuration set in HWCONFIG. If the settings are matched, the PLC can run normally.
- Max: Sets a maximum number for the module placement. An alarm shows if your actual I/O module placement is larger than the maximum setting.

- **CPU module Stop when I/O Module No Response**

The parameter sets whether the CPU and other normal modules can operate constantly when there is an extension module, which does not response during offline period.

- Stop (default): The CPU module stops running and then shows errors.
- Keep Run: The CPU module and other normal modules keep running.

- **CPU module Stop when I/O Module Occurred Error**

The parameter sets the method to deal with a minor error in the extension modules.

- Stop: The CPU stops running and sends an error.
- Keep Run (default): The CPU keeps running but records the warning message.

- **Select Action When 24Vdc Input Unstable**

What to do when the 24Vdc power is unstable

- Continue Running when power stable (default): The CPU stops and waits till the power is stable and then the CPU begins to run.
- Into Error Status: The CPU stops and ERROR LED blinks; even after the power is stable again, the CPU still stays stop.

- **Show Battery Low Voltage Error**

The parameter sets whether the alarm is shown when the lithium battery for the real-time clock is of low voltage or is not installed.

- Disable: The function is closed.
- Enable (default): An alarm shows when the lithium battery is of low voltage or not installed.

4.2.1.12 Task Deployment

Here displays a table of inputs and outputs and their assignments to the defined tasks and bus cycle task. You can search for the relevant information here. The information is refreshed after the project is compiled and downloaded to the CPU. If the search result is not as expected, you can use the information to troubleshoot.

I/O channels	Channel	EtherCAT_Task (0)	MainTask (1)
DI0			
%IB0	IN:0-7		
%IX0.0	IN0		
%IX0.1	IN1		
%IX0.2	IN2		
%IX0.3	IN3		
%IX0.4	IN4		
%IX0.5	IN5		
%IX0.6	IN6		
%IX0.7	IN7		
%IB1	IN:8-15		
%IX1.0	IN8		
%IX1.1	IN9		
%IX1.2	IN10		
%IX1.3	IN11		
%IX1.4	IN12		
%IX1.5	IN13		
%IX1.6	IN14		
%IX1.7	IN15		
%IB2	Encoder		
%IX2.0	A1		
%IX2.1	B1		
%IX2.2	Z1		
%IX2.3	Reserve		
%IX2.4	A2		
%IX2.5	B2		
%IX2.6	Z2		
%IX2.7	Reserve		
%QB0	OUT:0-7		
%QX0.0	OUT0		
%QX0.1	OUT1		
%QX0.2	OUT2		

= Bus Cycle Task

	The task defined as a Bus cycle task in the PLC Settings of the device
	For inputs and outputs that are written or read by a task.

4.2.1.13 Status

Here you can find the device status information, for example 'Running' or 'Stopped', and specific diagnostic messages from the respective device, also information about the card used and the internal bus system.

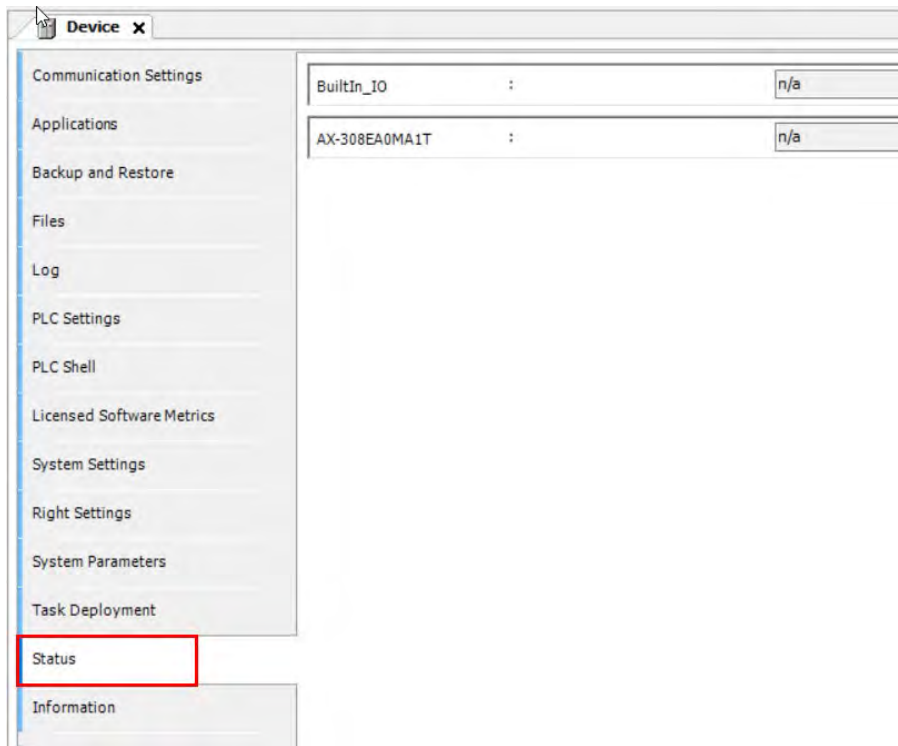

4

4.2.1.14 Information

Here you can find general information that originates from the device description file: name, vendor, categories, version, order number, description, and other relevant information.

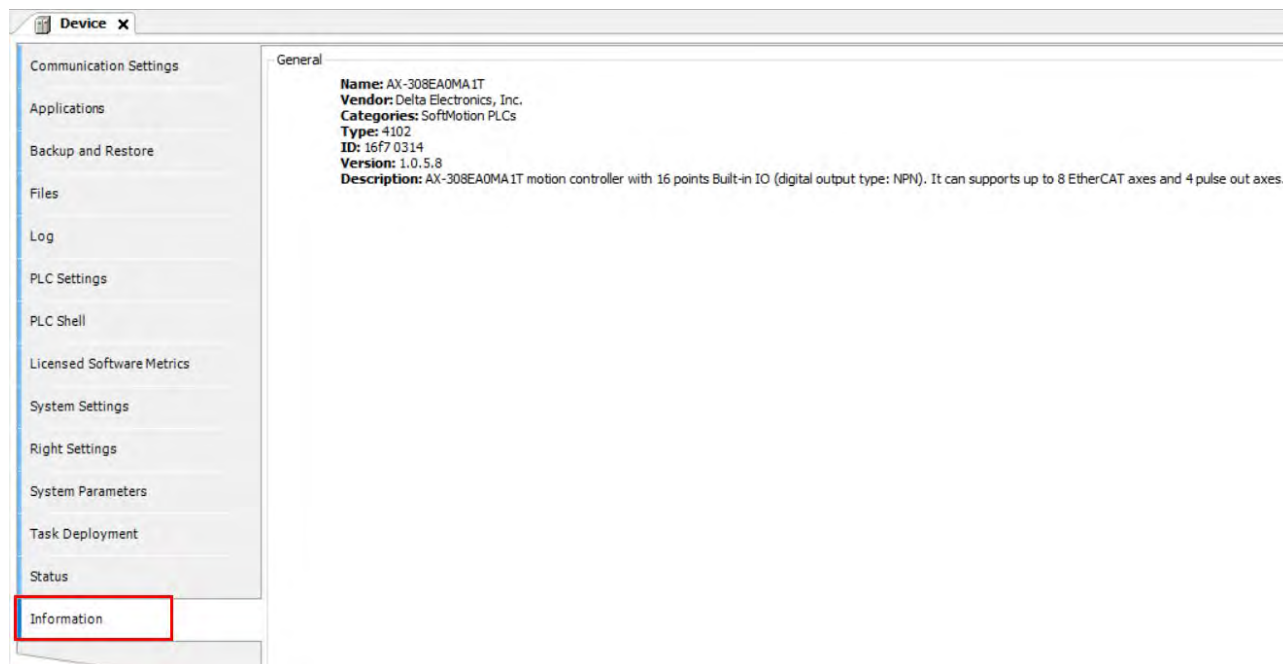

4.2.2 Extension Module Parameter Settings

You can set up the extension settings, including IO update task time, command task priority and task delay time in this setting page.

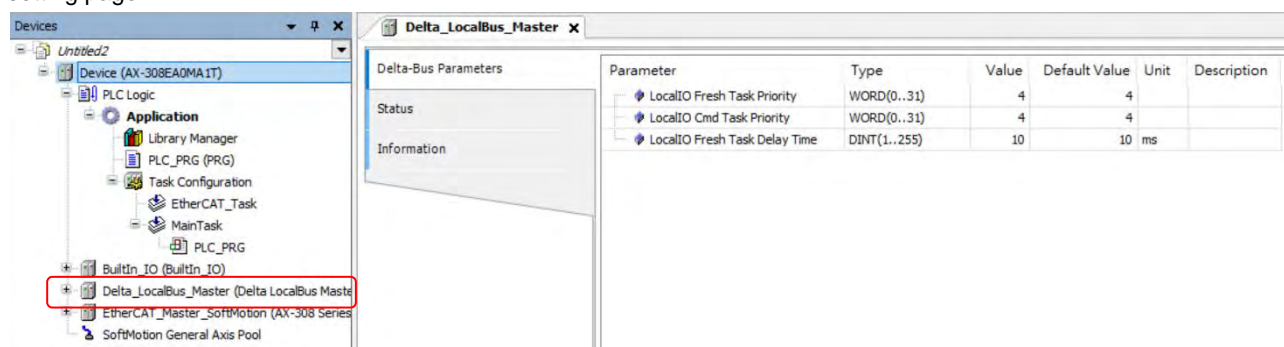

- **LocalIO Fresh Task Priority :**

It is the priority of the data exchange tasks between the CPU module and the extension modules. Set the priority level from 0 to 31.**

- **LocalIO Cmd Task Priority :**

It is the priority of the extension module tasks, including module Run/Stop, module parameter read/write, module instruction From/To and so forth. Set the priority level from 0 to 31.**

- **LocalIO Fresh Task Delay Time :**

This is used for editing the importing/exporting cycle time of the extension modules. You can set the task delay time according to the module types. Below is the data exchange time table for the AS Series modules. Refer to section 4.4.1.2 for more information on Bus Cycle Task.

Module	Time (ms)	Module	Time (ms)
AS02HC	*2	AS08AM	0.6
AS02PU	1.5	AS08AN	0.6
AS04PU	2.1	AS06RTD	0.9
AS02LC	0.6	AS16AP11R	1.2
AS02ADH	0.6	AS16AN01T	0.6
AS04AD	0.9	AS16AM10N	0.6
AS04DA	0.9	AS06XA	1.5
AS08AD	1.2	AS32AM	0.6
AS04RTD	0.9	AS32AN	0.6
AS04TC	0.9	AS64AM	0.9
AS08TC	1.2	AS64AN	0.9

Note 1: It is suggested not to change the task priority or it might affect the communication of module or EtherCAT functions.

Note 2: The duration for the module to perform data exchange varies according to the instructions used in the program.

4.3 Data Type and Variables

4.3.1 Data Type

Data Type	Minimum Value	Maximum Value	Data Width
BOOL	FALSE	TRUE	1 bit
BYTE	0	255	8 bit
WORD	0	65535	16 bit
DWORD	0	4294967295	32 bit
LWORD	0	$2^{64}-1$	64 bit
SINT	-128	127	8bit
USINT	0	255	8 bit
INT	-32768	32767	16 bit
UINT	0	65565	16 bit
DINT	-2147483648	2147483647	32 bit
UDINT	0	4294967295	32 bit
LINT	-2^{63}	$2^{63}-1$	64 bit
ULINT	0	$2^{64}-1$	64 bit
REAL	-3.402823E+38	3.402823E+38	32 bit
LREAL	-1.7976931348623157E+308	1.7976931348623157E+308	64 bit
TIME	T#0ms	T#49d17h2m47s295ms	32 bit
LTIME	LTIME#0ns	LTIME#213503d23h34n33s 709ms551us615ns	64 bit
TIME_OF_DAY (TOD)	TOD#00:00:00.000	TOD#23:59:59.999	32 bit
DATE	D#1970-1-1 (01/01/70)	DATE#2106-2-7 (February 07, 2106)	32 bit
DATE_AND_TIME	DT#1979-1-1-00:00:00 (01/01/1970 00:00:00)	DT#2106-2-7-6:28:15 (February 07, 2106 6:28:15)	32 bit
STRING	ASCII format (8 bit): up to 255 characters		
WSTRING	Unicode format (16 bit): no limit on the length		

4.3.2 Variables

Rules for identifiers of variables:

- No spaces or special characters
- Not case sensitive (For example, Var0 and VAR0 are seen as the same variable)
- No multiple consecutive underscores (For example, b__Var0 is not permitted)

Rules for multiple use of identifiers

- Local variable cannot be declared more than one time.
- If a local variable and a global variable share the same name, the local variable has priority within the POU.
- Variables with the same name can be declared in different global variables list.

(For example, globe_list1.bvar and globe_list2.bvar can co-exist in two different global variables lists.)

Comments

- Single comment: the symbol // indicates a single comment, for example: // Variable Define
- Multiple comments: the symbol (* XX : XX *) indicates multiples comments from XX to XX, for example (* Variable Define : Variable Define*)

4.3.2.1 Declaration of Variables

In DIADesigner-AX projects you can declare variables in the following methods.

Syntax: <Variable Name> : <Data Type> := <Initialization> ;

Example:

```

VAR
    bVar      :   BOOL  ;
    byVar     :   BYTE  := 1  ;
    wVar      :   WORD  := 16#0001  ;
    todVar    :   TOD   := TOD#02:30:15.100;
END_VAR

```

Array

Syntax : <Variable Name> : ARRAY[0..N] OF <Data Type>

Example:

```

VAR
    byVar_Array :   ARRAY[0..10] OF BYTE  ;
    wVar_Array  :   ARRAY[0..30] OF WORD  ;
    rVar_Array  :   ARRAY[0..50] OF REAL  ;
END_VAR

```

4.3.2.2 Address Assignments

In AX-3 Series, there are three ranges in the memory area, including I (input memory range), Q (output memory range) and M (flag memory range). You can use specific character strings to express memory position and size. For the M flag memory range in AX-3 Series PLC, you cannot manually use the bit operation when in online mode.

Syntax: %<Memory Area Prefix><Size Prefix><Memory Position>

Memory Area	Description	Range
I	Input Memory Range	8 KB
Q	Output Memory Range	8 KB
M	Flag Memory Range	512 KB

Size Prefix	Data Type	Data Width
X	--	1 bit
B	Byte	8 bit
W	Word	16 bit
D	DWord	32 bit
L	LWord	64 bit

***Note1:** For flag memory (M) in AX-3 series PLCs, bits cannot be used while in online mode. %MX would only be supported by devices equipped with firmware version V1.0.3.0 and above.

- Memory Area**

The numbering that you use for addressing the memory position depends on the target system. Before specifying the address value in the memory area, you need to know the mapping corresponding relationship of devices to prevent the overlapping memory ranges. See the table below for reference.

Memory Area							
X0.63~X0.56	X0.55~X0.48	X0.47~X0.40	X0.39~X0.32	X0.31~X0.17	X0.23~X0.16	X0.15~X0.8	X0.7~X0.0
X7.7~X7.0	X6.7~X6.0	X5.7~X5.0	X4.7~X4.0	X3.7~X3.0	X2.7~X2.0	X1.7~X1.0	X0.7~X0.0
B7	B6	B5	B4	B3	B2	B1	B0
W3		W2		W1		W0	
D1				D0			
L0							

- **Example**

Address	Description
%QX7.5	Single bit address of the output bit 7.5
%IW215	Word address of the input word 215
%QB7	Byte address of the output byte 7
%MD48	Address of a double word at memory position 48 in flag memory
VAR wVar0 AT %IW0 : WORD; END_VAR	Variable declaration with address information of an input word
VAR bVar0 AT IX7.5 : BOOL; END_VAR	Boolean variable declaration with address information of an input bit X7.5.

4

4.3.2.3 Variables

- **Global Variables**

If a variable that is declared in the POU, it is a local variable and it can only be used in the same POU. If a variable that is declared in the global variable list, it is a global variable and it can be used in any POU.

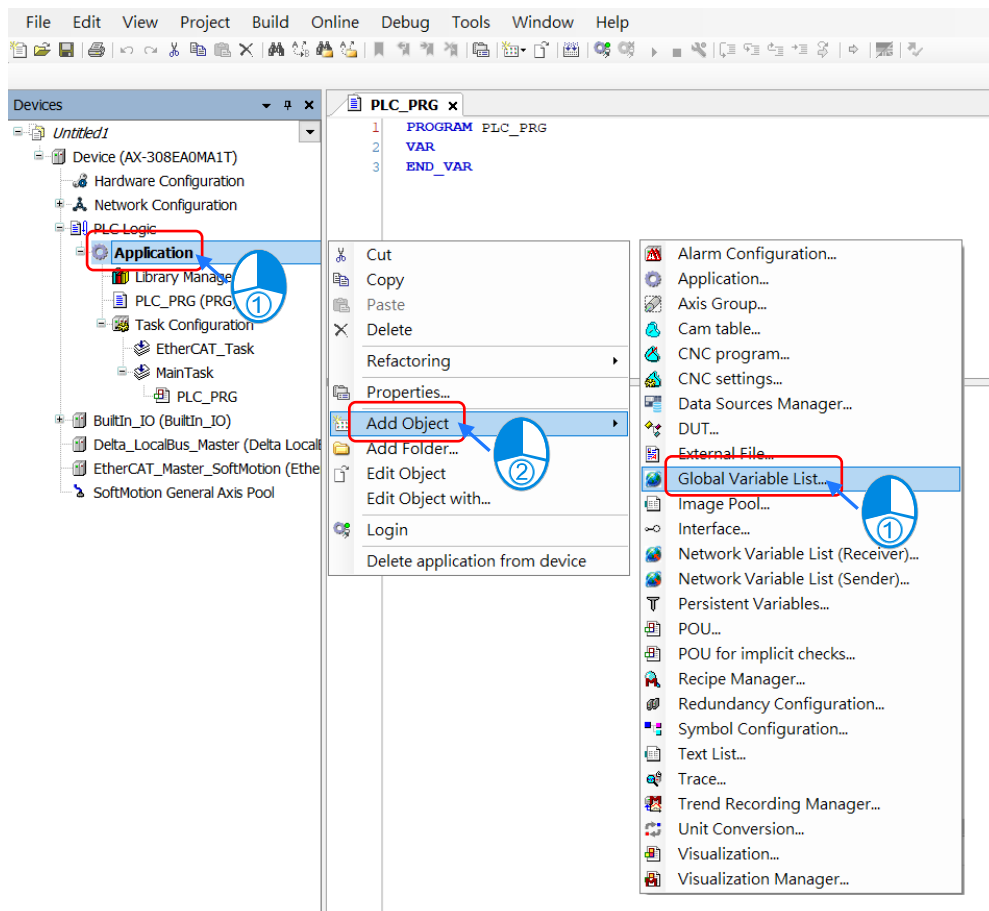

4

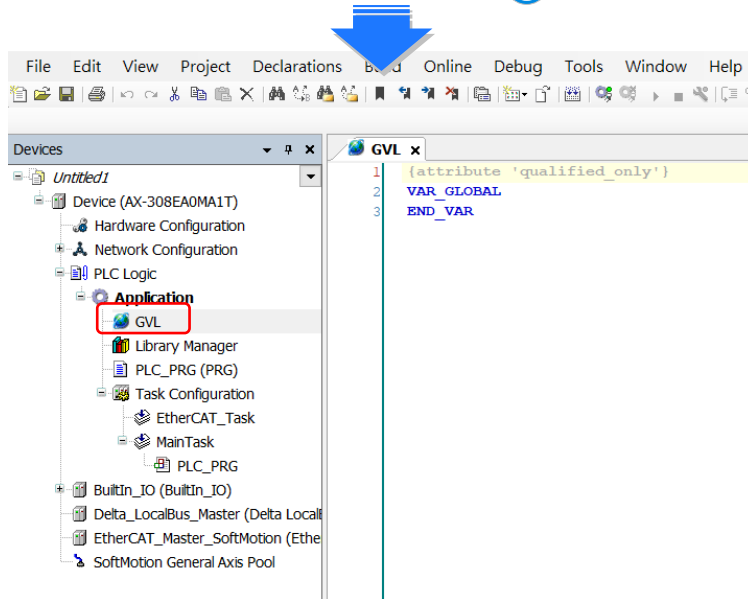
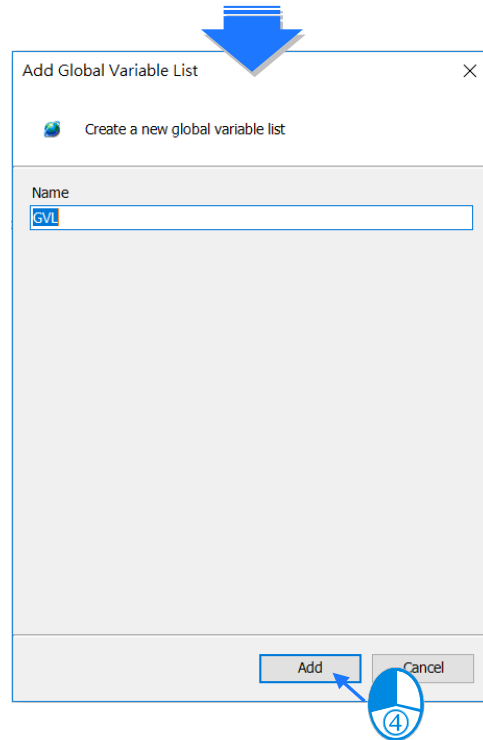

- **Constant Variables**

You can declare a variable as a constant variable. Constant variables can be accessed as read-only and without assigning an initialization value.

Declaration of Constant Variables

```

VAR CONSTANT
    pi : REAL := 3.14159 ;
END_VAR
    
```

• **Retain Variables**

You can declare a variable as retentive or use retain / persistent variable directly. Refer to the table below for differences among variable, retain variable and persistent variable.

	Initialize				
	Reboot PLC	Reset warm	Reset cold	Download	Reset Origin
Variable	O	O	O	O	O
Retain Variable	X	X	O	O	O
Persistent Variable	X	X	X	X	O

Declaration of Retain Variables

```

VAR RETAIN
  bVar : BOOL ;
  byVar : BYTE ;
  wVar : WORD ;
END_VAR
    
```

You can declare the Persistent Variable / Retain Persistent Variable / Persistent Retain Variable in the Persistent Variable Object and the results are the same.

Persistent Variable List:

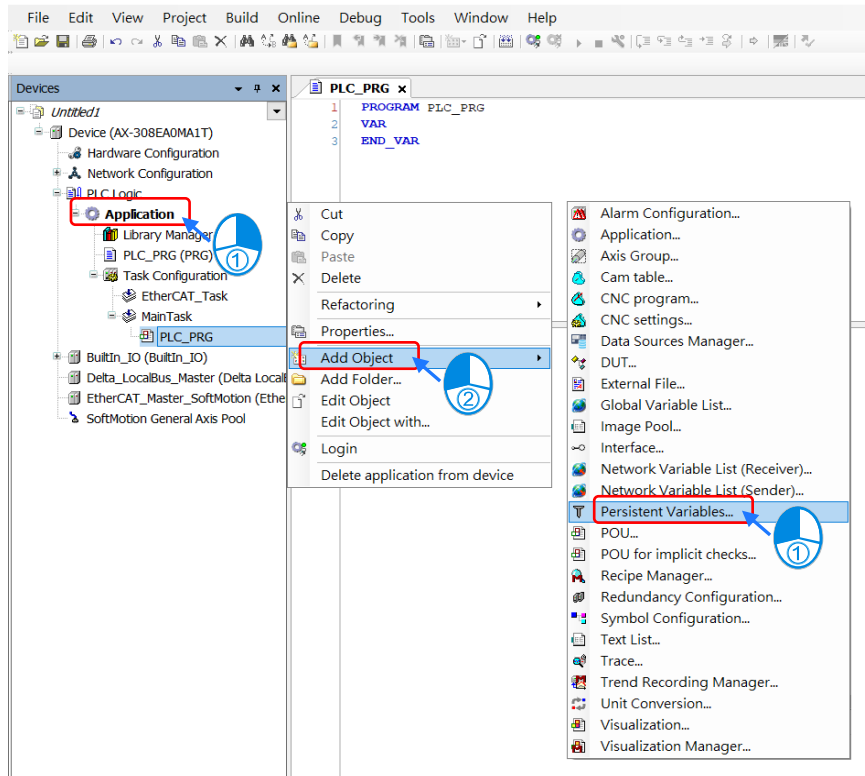

4

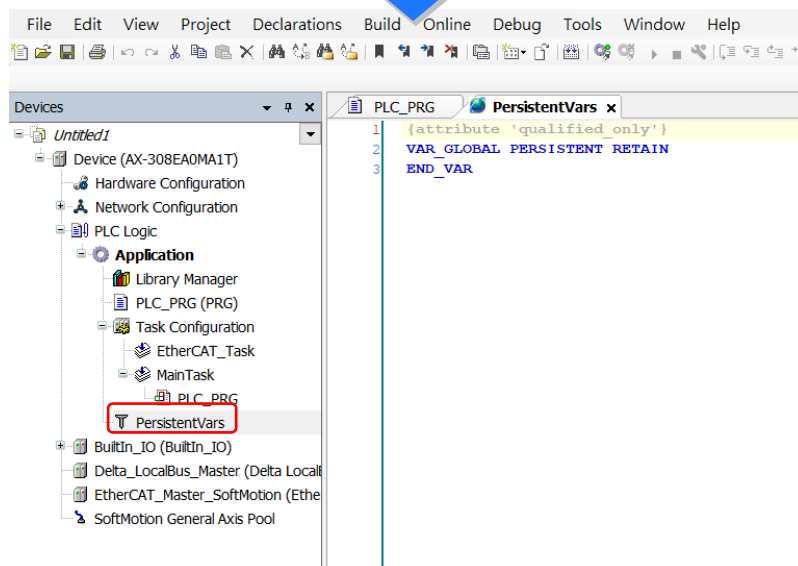
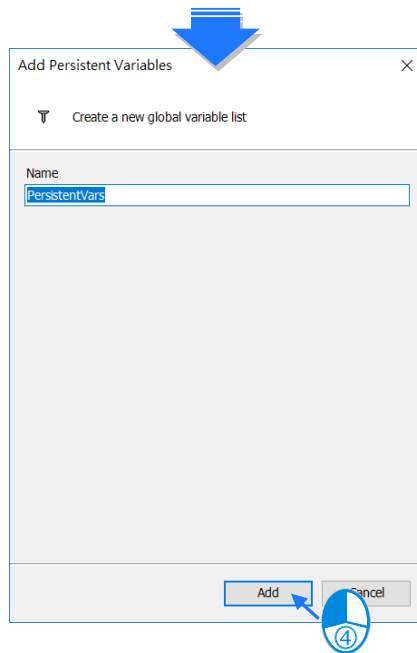

If you need to declare a local variable as persistent, you need to add the variable instance path in the persistent variable list.

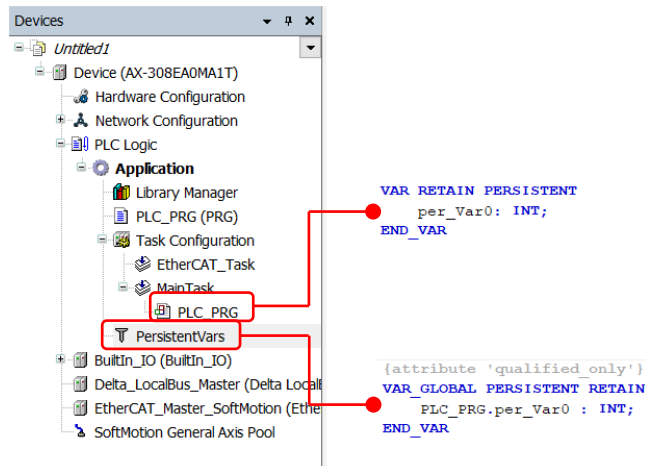

4.3.2.4 User-defined Data Types

You can create your own data type, DUT (Data Type Unit) or UDT (User-defined Data Type), by clicking ADD Object and selecting DUT. Four data types can be created, including Structure, Enumeration, Alias and Union.

DUT:

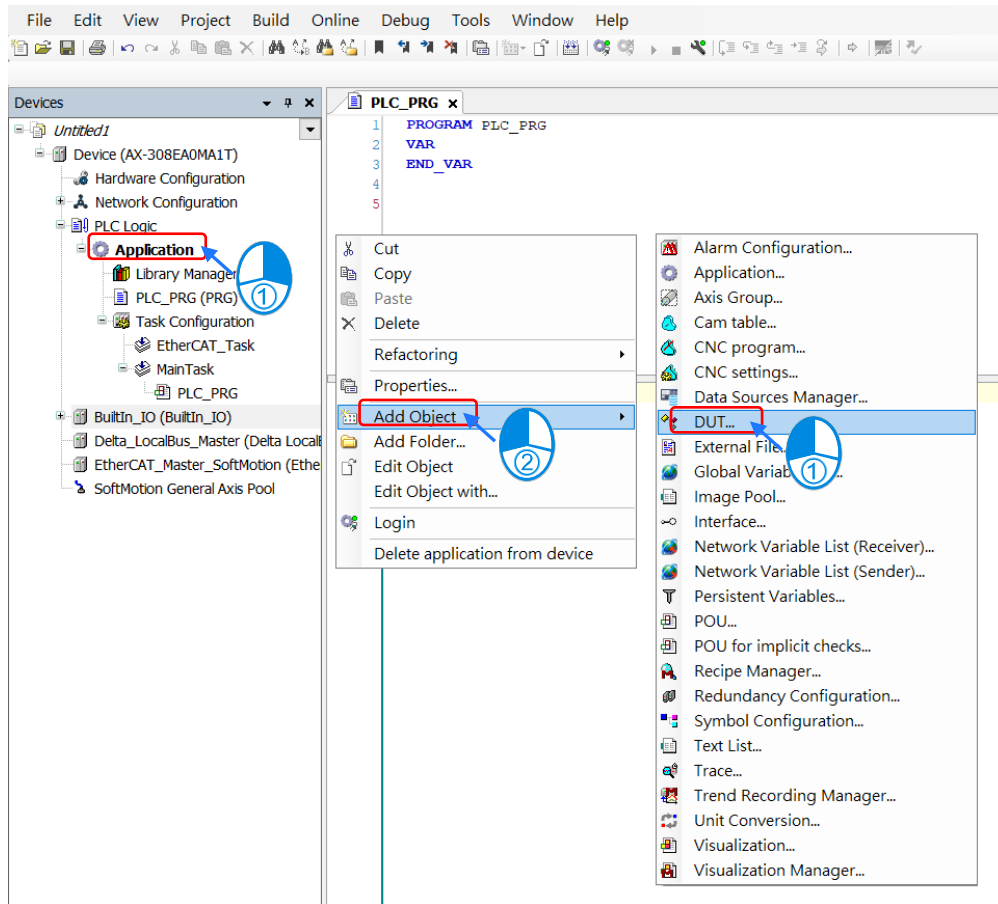

- **Structure :**

A structure is a compound data type used for grouping simple data types or other compound data types.

Syntax:

TYPE <Structure Name>:

STRUCT

 <Variable Declaration 1>

 ...

 <Variable Declaration n>

END_STRUCT

END_TYPE

Example:

```

TYPE DUT :
STRUCT
    bVar    :   BOOL    ;
    wVar    :   WORD    ;
    iVar_Array :   ARRAY[0..2]OF INT    ;
END_STRUCT
END_TYPE
    
```

Applications:

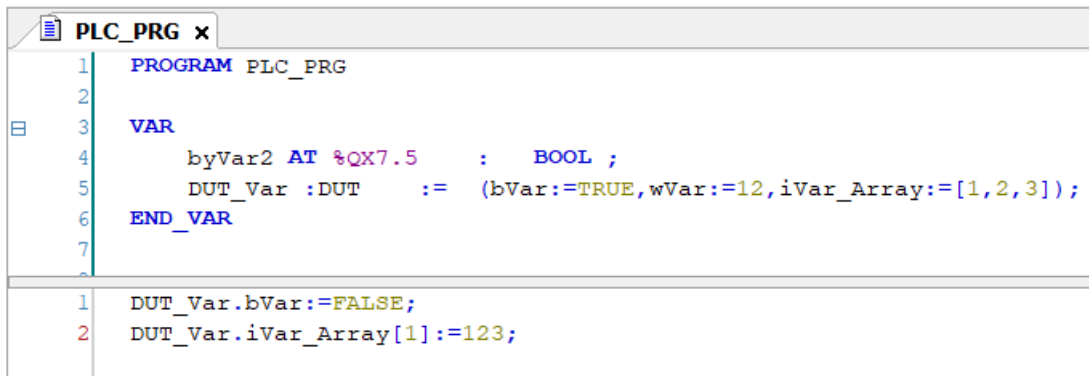

```

PLC_PRG x
1 PROGRAM PLC_PRG
2
3 VAR
4   byVar2 AT %QX7.5 : BOOL ;
5   DUT_Var :DUT := (bVar:=TRUE,wVar:=12,iVar_Array:=[1,2,3]);
6 END_VAR
7
8
9 DUT_Var.bVar:=FALSE;
10 DUT_Var.iVar_Array[1]:=123;
    
```

• **Enumeration :**

An enumeration is used to map a set of names to numeric values. Enumerated data types help make the code more self-documenting and make program listing more readable.

Syntax:

TYPE <Enumeration Name> :

```

(
    <First Component Declaration>:= Component Declaration,
    ... ,
    < Last Component Declaration >:= Component Declaration
) <Basic Data Type> := Default Variable Initialization;
END_TYPE
    
```

Example:

```

TYPE Enumeration_0 :
(
    GREEN := 0,
    YELLOW:=3,
    RED:=8
) INT:=YELLOW;
END_TYPE
    
```

- **Alias :**

Alias is a scalar data type for a variable that can save a single value and self-define the data type.

Example:

```
TYPE <Alias Name> : STRING(20); END_TYPE
```

- **Union :**

Union is a data structure that contains different data types. All components have the same amount of memory.

Syntax:

```
TYPE <Union Name>:
```

```
UNION
```

```
    <Variable Declaration 1>
```

```
    ...
```

```
    <Variable Declaration n>
```

```
END_UNION
```

```
END_TYPE
```

Example:

```
TYPE DUT_Union :  
UNION  
    unVar0:WORD;  
    unVar1:DWORD;  
END_UNION  
END_TYPE
```

4.3.2.5 Timing for the Variable to be Cleared to Zero

For different types of variables, the timing to clear the variables to zero is various. Find the various timings below for the variables to be cleared to zero under different occasions.

- Retain Mode : Original mode

Action	VAR	VAR Retain	VAR Retain Persistent
Online Change	●	●	●
Reboot PLC	○	●	●
Reset Warm	○	●	●
Reset Cold	○	○	●
Download	○	○	●
Reset Origin	○	○	○

- Retain Mode : %M mode

Action	VAR	VAR Retain	VAR Retain Persistent
	The variable address is in the retainable area.		
Online Change	●	●	●
Reboot PLC	●	●	●
Reset Warm	●	●	●
Reset Cold	●	●	●
Download	●	●	●
Reset Origin	○	○	○

Action	VAR	VAR Retain	VAR Retain Persistent
	The variable address is out of the retainable area.		
Online Change	●	●	●
Reboot PLC	○	●	●
Reset Warm	○	●	●
Reset Cold	○	○	●
Download	○	○	●
Reset Origin	○	○	○

- = Value retained
- = Clear to zero

*Note: If there's no function of retained values, default values would be effective.

4.3.2.6 Timing for the Default Value to be Effective

- Retain Mode : Original mode

Action	VAR	VAR Retain	VAR Retain Persistent
Online Change	●	●	●
Reboot PLC	○	●	●
Reset Warm	○	●	●
Reset Cold	○	○	●
Download	○	○	●
Reset Origin	○	○	○

- Retain Mode : %M mode

Action	VAR	VAR Retain	VAR Retain Persistent
	The variable address is in the retainable area.		
Online Change	●	●	●
Reboot PLC	●	●	●
Reset Warm	●	●	●
Reset Cold	●	●	●
Download	●	●	●
Reset Origin	○	○	○

Action	VAR	VAR Retain	VAR Retain Persistent
	The variable address is out of the retainable area.		
Online Change	●	●	●
Reboot PLC	○	●	●
Reset Warm	○	●	●
Reset Cold	○	○	●
Download	○	○	●
Reset Origin	○	○	○

● = Invalid

○ = Valid

4.4 Task

4.4.1 Task Configuration

You define one or more tasks for controlling and executing the program blocks (POUs) in the PLC. You define a task with a name, a priority, and a type, which determines which condition triggers the start of the task. You can define this condition either by time (cyclic-interval, freewheeling) or by the occurrence of an internal or external event to process the task.

A task calls one or more program blocks (POUs). With the combination of priority and condition, you define the order in which the tasks are processed. You can configure a watchdog for each task.

Rules for the processing order of the defined tasks:

- If the task condition is satisfied, then the system processes the task.
- If several tasks satisfy the condition for processing at the same time, then the system processes the tasks with the highest priority first.
- If several tasks with the same priority level satisfy the condition for processing at the same time, then the system processes the longest waiting task first.
- The program calls are processed in the order they appear in the configuration dialog of the task.
- If a called program has the same name in the device tree of the application and in a library or project-global in the POU window, then the application program is used.

Note: Set the priority level from 0 to 31. If the set number is closer to 0, it has higher priority.

4.4.1.1 Task Types

There are five types of task types:

- **Cyclic Task :**
The system processes the task in cycles. The cycle time of the task is defined in the input field Interval.
- **Event Task :**
The system starts processing the Event Task as soon as the global variable defined in the input field Event contains a rising edge.
- **Freewheeling Task :**
The system starts processing the Freewheeling Task again automatically in a continuous loop at program start and at the end of a complete pass.
- **Status Task :**
The system starts Status Task processing as soon as the variable defined in the Event input field yields the Boolean value TRUE.

4.4.1.2 Bus Cycle Task

If the task condition is satisfied, then the system processes the task.

Set the priority level from 0 to 31. If the set number is closer to 0, it has higher priority.

The system processes the task in the order of Task Group in Task Configuration.

Behavior of the bus cycle

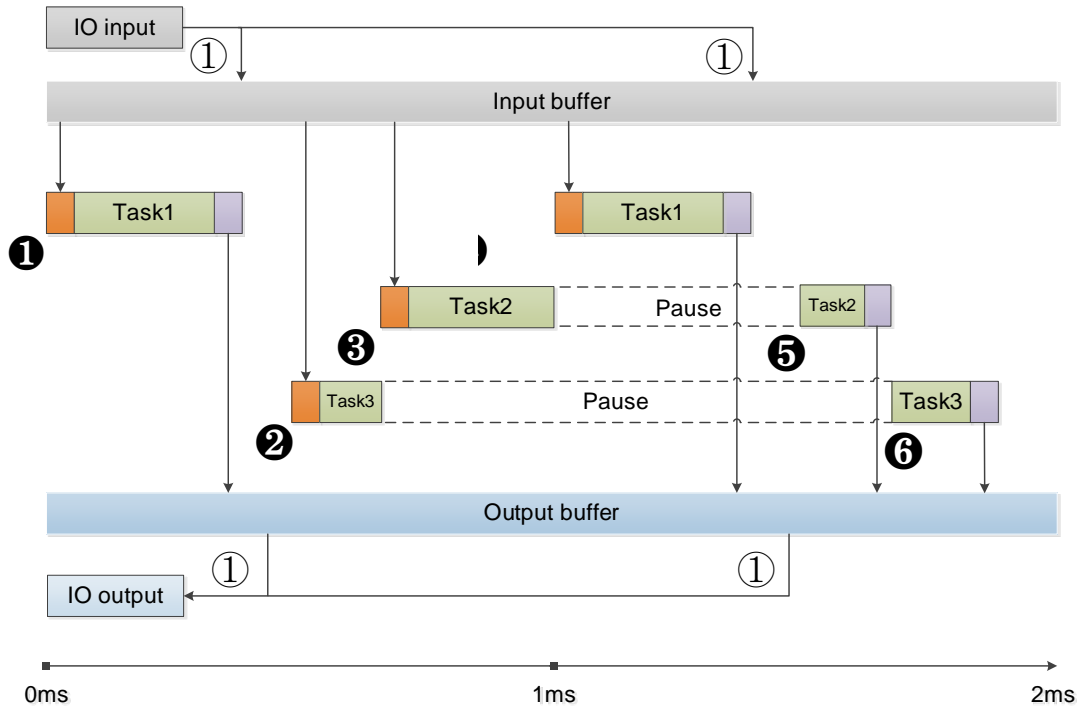

① Bus cycle

Task 1: Priority = 1, Bus cycle Task, Cyclic Task

Task 2: Priority = 3, Event Task

Task 3: Priority = 5, Freewheeling Task

- ① The condition for starting Task 1 is met; Task 1 starts.
- ② Task 1 completes and the I/O data from buffer is exchanged with the I/O channel (physical hardware.) Task 3 starts.
- ③ The condition for starting Task 2 is met and Task 2 has higher priority than Task 3 does. Thus Task 2 starts and Task 3 halts.
- ④ The condition for starting Task 1 is met and Task 1 has higher priority than Task 2 does. Thus Task 3 starts and Task 4 halts.
- ⑤ Task 1 completes and the I/O data from buffer is exchanged with the I/O channel (physical hardware.) Task 2 starts again.
- ⑥ Task 2 completes and the Task 3 starts again.

Note ①: The messages are normally sent on the bus in this task. Other tasks copy only the I/O data from an internal buffer that is exchanged only with the physical hardware in the bus cycle task.

4.4.1.3 Watchdog

If the task exceeds the time set for the watchdog, then the task is halted with an error status.

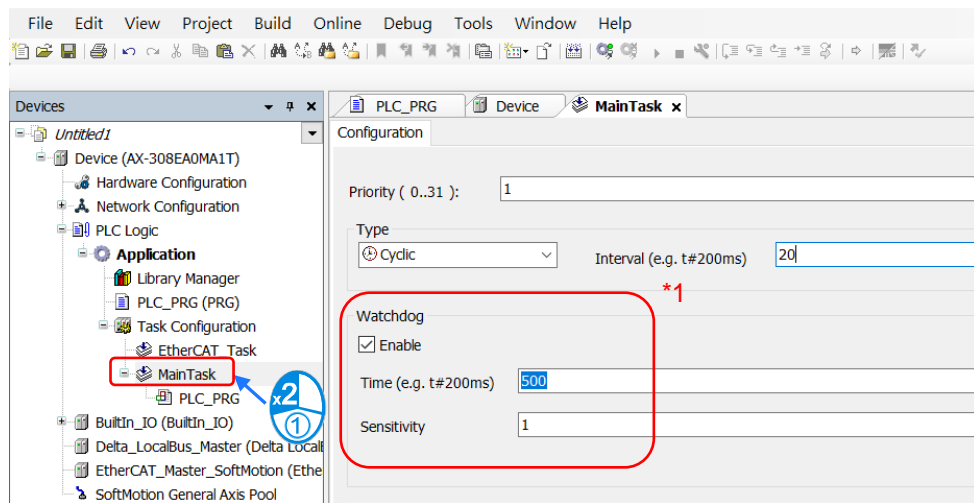

4

- Several consecutive timeouts:
 Sensitivity: 0, watchdog timeout = time *1
 Sensitivity: n, watchdog timeout = time *n

4.4.1.4 Motion Instructions for Types of Tasks

Here is the table of motion instructions for different task types. "V" means the motion instruction can be executed for the task type.

- Synchronization axes

Classification	Instruction Name	Task Type		
		Cyclic	Freewheeling	Bus Cycle EtherCAT
Motion Control Function Blocks	MC_Home			V
	MC_Stop			V
	MC_Halt			V
	MC_MoveAbsolute			V
	MC_MoveRelative			V
	MC_MoveAdditive			V
	MC_MoveSuperImposed			V
	MC_CamIn			V
	MC_CamOut			V
	MC_MoveVelocity			V
	MC_PositionProfile			V
	MC_VelocityProfile			V
	MC_AccelerationProfile			V
	MC_Jog			V
	MC_GearIn			V
	MC_GearOut			V
	MC_GearInPos			V
	MC_Phasing			V
	DMC_TorqueControl			V
	DMC_VelocityControl			V
	DMC_MoveLinearAbsolute			V
	DMC_MoveLinearRelative			V
	DMC_MoveCircularAbsolute			V
	DMC_MoveCircularRelative			V
	DMC_GroupStop			V
	DMC_GroupHalt			V
	DMC_Home_P			V
DMC_GroupInterrupt			V	
DMC_GroupContinue			V	
DMC_ImmediateStop_P			V	
Instructions for Management	MC_Power	V	V	V
	MC_SetPosition	V	V	V
	MC_ReadParameter	V	V	V
	MC_WriteParameter	V	V	V
	MC_ReadBoolParameter	V	V	V
	MC_WriteBoolParameter	V	V	V
	MC_ReadActualPosition	V	V	V
	MC_ReadActualVelocity	V	V	V
	MC_ReadActualTorque	V	V	V

4

Classification	Instruction Name	Task Type		
		Cyclic	Freewheeling	Bus Cycle EtherCAT
	MC_Reset	V	V	V
	MC_ReadStatus	V	V	V
	MC_ReadAxisError	V	V	V
	MC_CamTableSelect	V	V	V
	MC_TouchProbe	V	V	V
	MC_AbortTrigger	V	V	V
	MC_DigitalCamSwitch	V	V	V
	DMC_GroupEnable	V	V	V
	DMC_GroupDisable	V	V	V
	DMC_GroupReadStatus	V	V	V
	DMC_GroupReadError	V	V	V
	DMC_GroupReset	V	V	V
	DMC_CamReadTappetStatus	V	V	V
	DMC_CamReadTappetValue	V	V	V
	DMC_CamWriteTappetValue	V	V	V
	DMC_CamAddTappet	V	V	V
	DMC_CamDeleteTappet	V	V	V
	DMC_CamReadPoint	V	V	V
	DMC_CamWritePoint	V	V	V
	DMC_ChangeMechanismGearRation	V	V	V
	DMC_ReadMotionState	V	V	V
	DMC_GroupReadParameter	V	V	V
	DMC_GroupWriteParameter	V	V	V

Note: it is suggested a motion function block should be created within a bus cycle EtherCAT to avoid inconsistent movement.

● Positioning axes

Classification	Instruction Name	Task Type		
		Cyclic	Freewheeling	Bus Cycle EtherCAT
Motion Control Function Blocks	MC_Halt_DML	V	V	V
	MC_Home_DML	V	V	V
	MC_MoveAbsolute_DML	V	V	V
	MC_MoveRelative_DML	V	V	V
	MC_MoveVelocity_DML	V	V	V
	MC_Stop_DML	V	V	V
Instructions for Management	MC_Power_DML	V	V	V
	MC_ReadBoolParameter_DML	V	V	V
	MC_ReadParameter_DML	V	V	V
	MC_ReadStatus_DML	V	V	V
	MC_Reset_DML	V	V	V
	MC_WriteBoolParameter_DML	V	V	V
	MC_WriteBoolParameter_DML	V	V	V
	MC_ChangeAxisConfig_DML	V	V	V
	MC_ReinitDrive_DML	V	V	V
	MC_SetOpmode_DML	V	V	V
	MC_StartupDrive_DML	V	V	V

4.5 Recipe Manager

With Recipe Manager, you are allowed to import recipe files and export specific parameters to recipe files by using "RecipeManCommands" from "Recipe_Management.library" function block.

- Add recipe manager

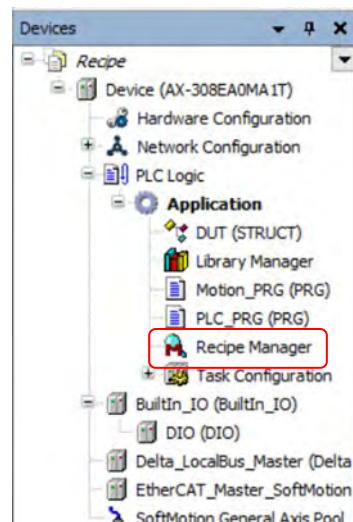
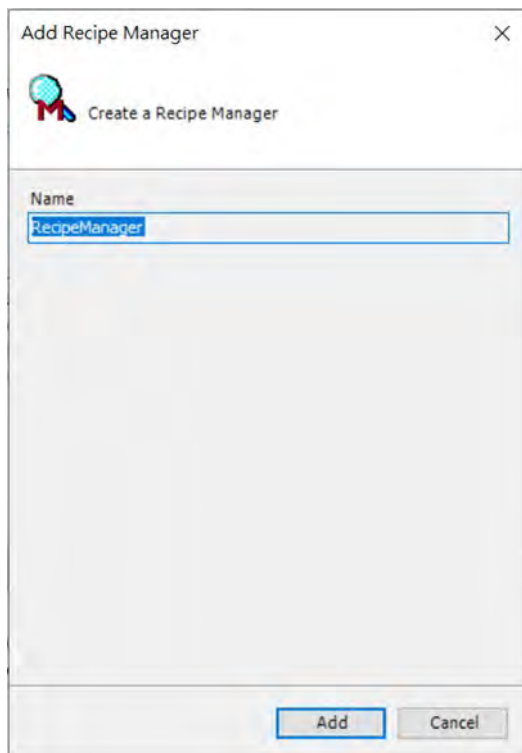
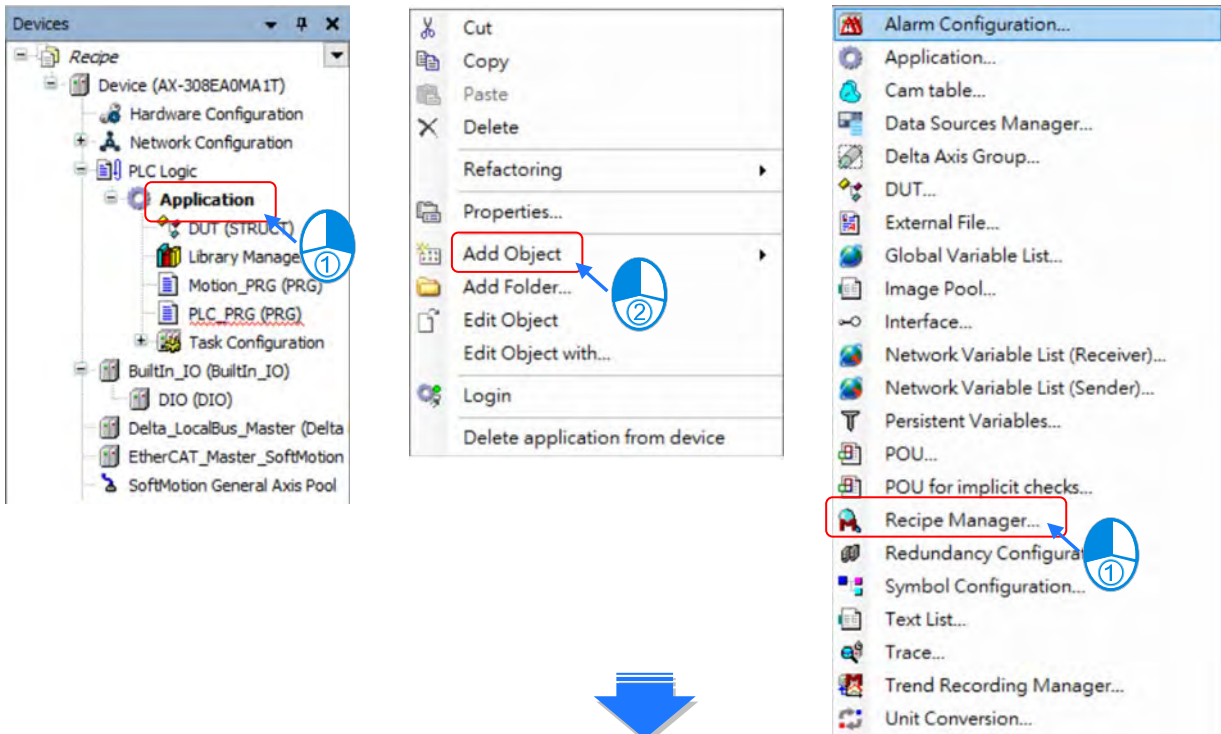

- Add recipe definition

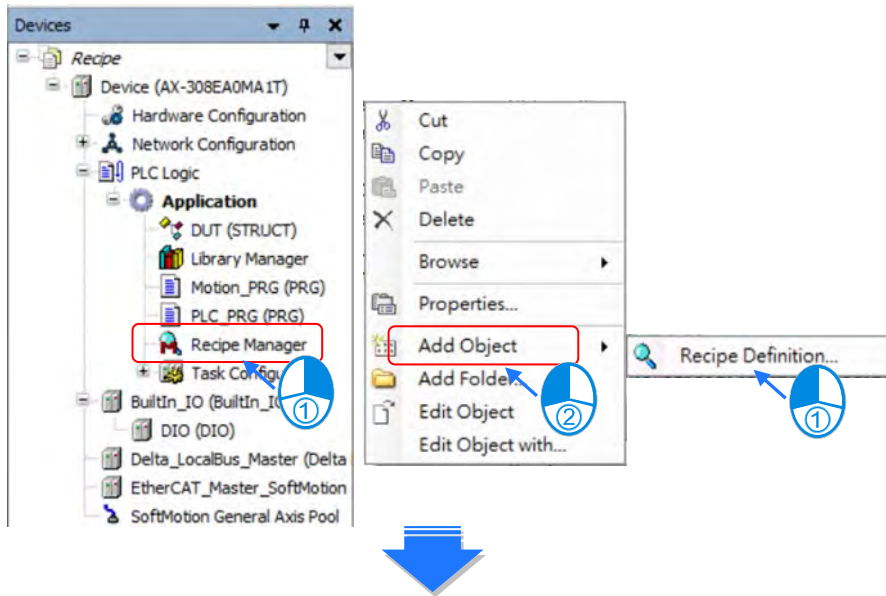

4

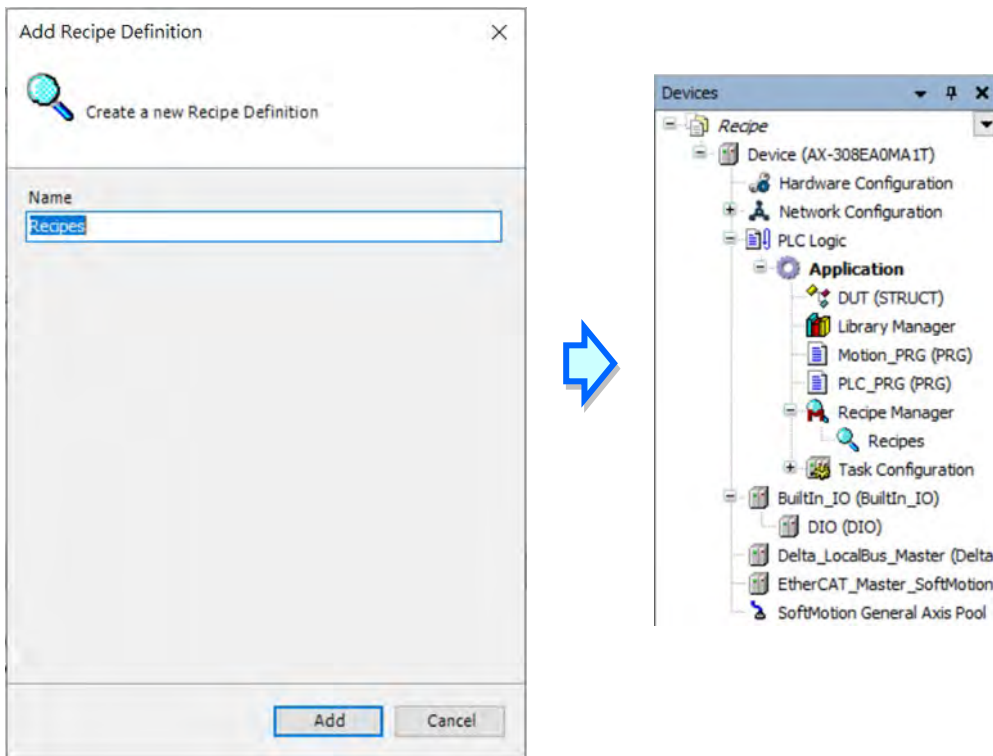

4.5.1 Recipe Manager

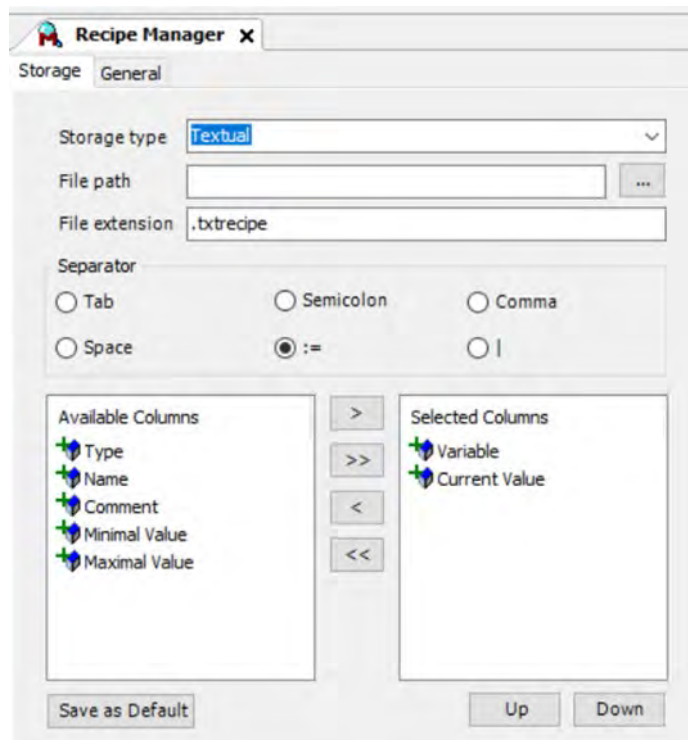

Selection	Description
Storage type	The file format to save recipe files. You can choose between Textual and Binary.
File path	The path to save recipe files. Example: If choosing to save files in AllRecipes, the path would be PlcLogic/AllRecipes.
File extension	The extension of the file <file extension> The naming format of extension files <recipe>.<recipe definition>.<file extension>.
Separator	Separators between each values in recipe files.
Available Columns Selected Columns	Define contents and order of recipe files.
Save as Default	Apply the setting to all the recipe managers in the project.

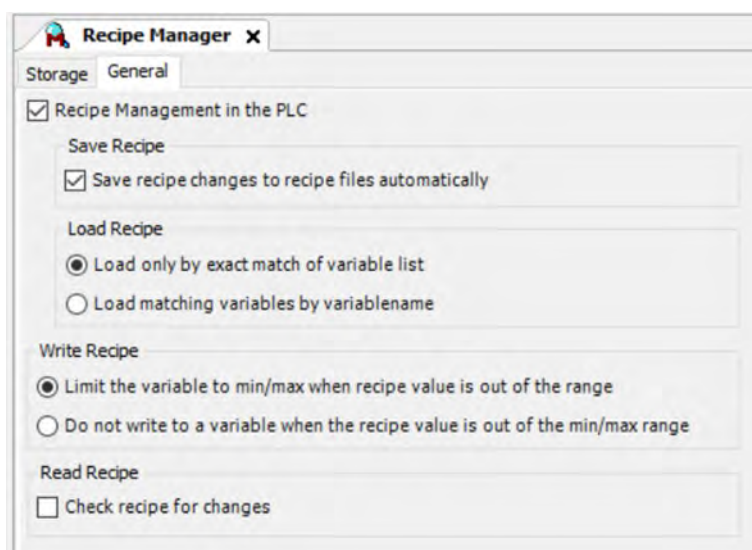

Selection	Description
Recipe management in the PLC	After this item has been selected, Recipe Manager would be activated.
Save Recipe	
Save recipe changes to recipe files automatically	After this item has been selected, recipe files would be updated automatically while downloading projects. In case that Recipe changes, it would be auto-saved to the recipe file.
Load Recipe	
Load only by exact match variable list	Select this item to load recipe files to the variables in the controller. The variables in the file must be in the same order as in the variable list while loading the recipe. Otherwise, the recipe cannot be loaded. (Additional entries at the end are ignored.)
Load matching variables by variable name	Select this item to load only variables with matching variable names from the recipe file, even though the order of variables or the contents in Name column do not match to the setting in the variable list.
Write Recipe	
Limit the variable to min/max when recipe value is out of the range	In case that the recipe value is out of the min/max range, the maximum or minimum value would be written to the corresponding variables in the controller.
Do not write to a variable when the recipe value is out of the min/max range	Prevent a value from being written to the controller if the recipe contains a value that is beyond the value range.

4.5.2 Recipe Definition

Variable	Type	Name	Comment	Minimal Value	Maximal Value	Current Value	Case1
%MW3	WORD	MW3 Variable		10	500		350
PLC_PRG.iVar	INT	int Variable					800
PLC_PRG.dwVar	DWORD	dword Variable		100	800		250

① : Recipe definition name

② : Recipe name

Parameter	Description
Variable	In the table, you can specify any variable including variables defined in a POU.
Type	This column would automatically display the relevant data type of the specified variable.
Name	You can define names of variables for inspection and comparison of Load Recipe.
Comment	Additional information.
Minimal Value Maximal Value	You can optionally specify the maximum and minimum value for values which should be permissible for being written on this variable. When the recipe value is out of the min/max range, the controller would determine whether to write the value on the variable according to the recipe manager.
Current Value	The current value would be displayed in online mode.

- Add a new variable

You can directly enter the name of variable or double click on the blank cell to open “Input Assistant” to choose the target variable.

Variable	Type	Name	Comment	Minimal Value	Maximal Value	Current Value	Case1
%MW3	WORD	MW3 Variable		10	500		350
PLC_PRG.iVar	INT	int Variable					800
PLC_PRG.dwVar	DWORD	dword Variable		100	800		250

OR

Variable	Type	Name	Comment
%MW3	WORD	MW3 Variable	
PLC_PRG.iVar	INT	int Variable	
PLC_PRG.dwVar	DWORD	dword Variable	
			...

- Add a new recipe

Right click on the page and select “Add a New Recipe”.

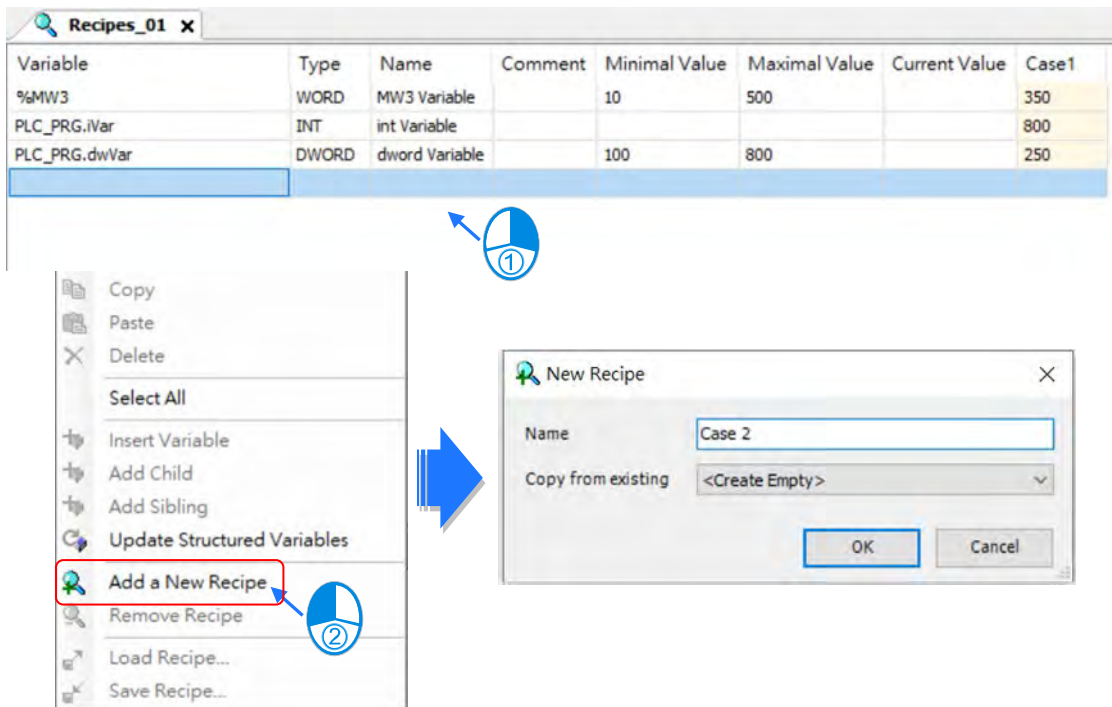

4

- Recipe files generated from the controller

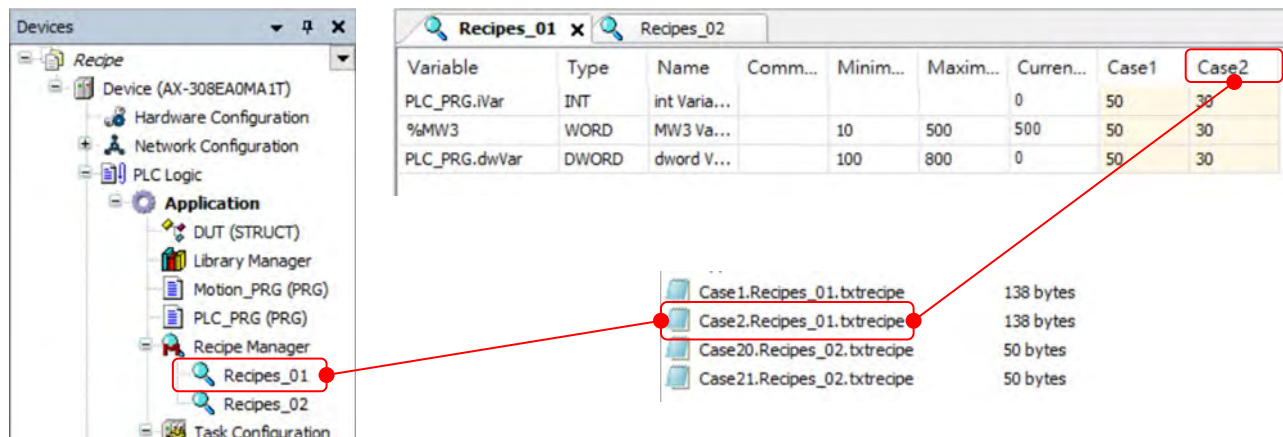

4.5.3 RecipeManCommand

Function block “RecipeManCommands” from “Recipe_Management.library” gives you different methods to load recipe files or export recipe files from the controller.

RecipeManCommands	Description
LoadAndWriteRecipe	Load the default recipe file and write the recipe to variables in the controller.
LoadFromAndWriteRecipe	Load the specified recipe file and write the recipe to variables in the controller.
ReadAndSaveAS	Save the variables of the controller in the target file.
ReadAndSaveRecipe	Read the current PLC values into the default recipe.
ReadAndSaveRecipeAS	Read the current PLC values into the default recipe and save the recipe to a specified recipe file.

● Example 1p

In this example, we add “StartDone” event by using “Add Event Handler” with “LoadAndWriteRecipe” method. So the recipe “Case 1” from the recipe definition “Recipes_01” would be loaded automatically to the corresponding variables in the controller when the PLC state changes from “STOP” to “RUN”.

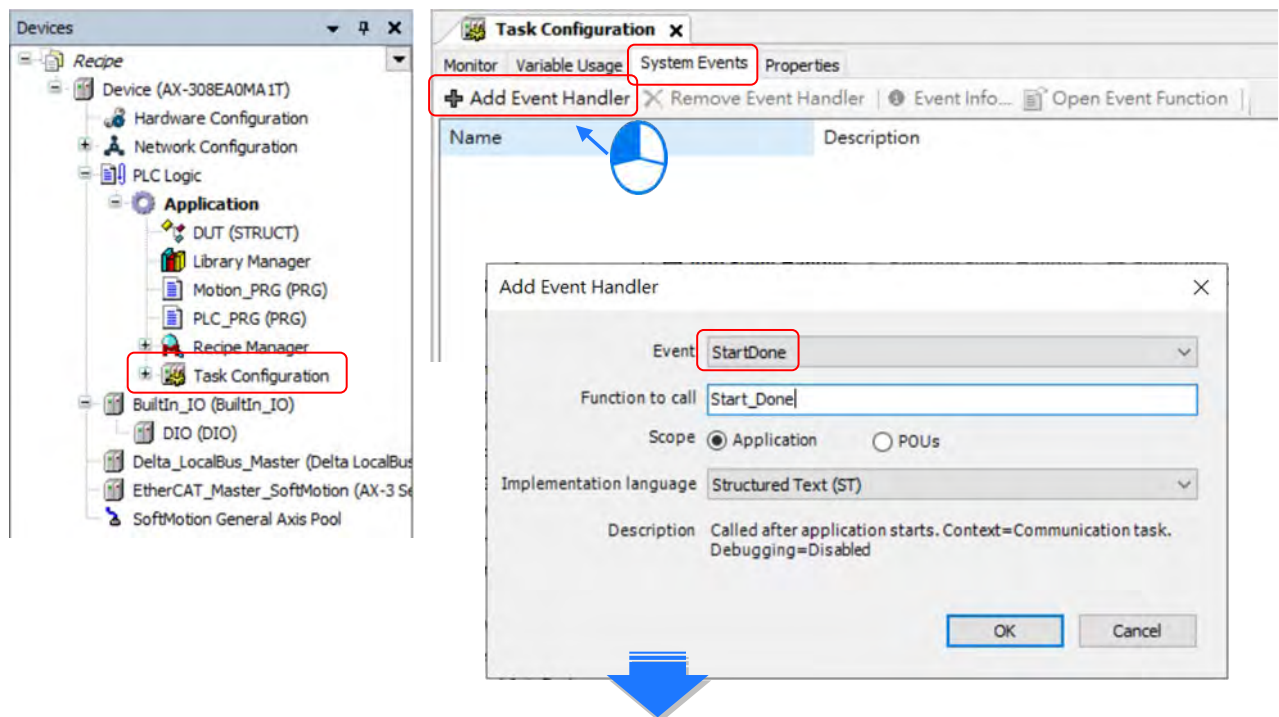

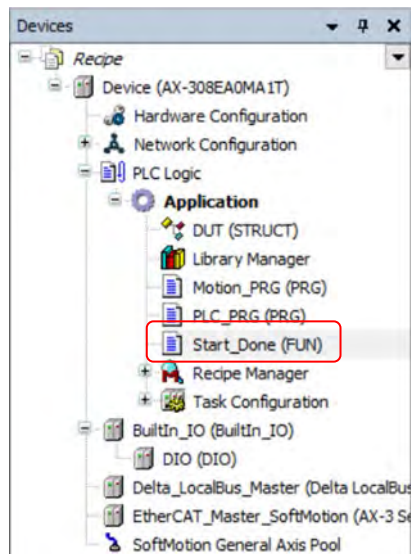

```

POU: Start_Done

1  FUNCTION Start_Done : DWORD
2  VAR_IN_OUT
3      EventPrm : CmpApp . EVTPARAM_CmpApp ;
4  END_VAR
5  VAR
6      FB0 : RecipeManCommands ;
7  END_VAR
8
9
10
11
12
13
14  FB0 . LoadAndWriteRecipe ( RecipeDefinitionName := 'Recipes_01' , RecipeName :=
15  'Case1' );
16
17
18
19

```

4

● Example 2

In this example, we use methods “ReadAndSaveRecipe” and “ReadAndSaveAS” to read the current PLC values into the default recipe as well as the specified recipe file.

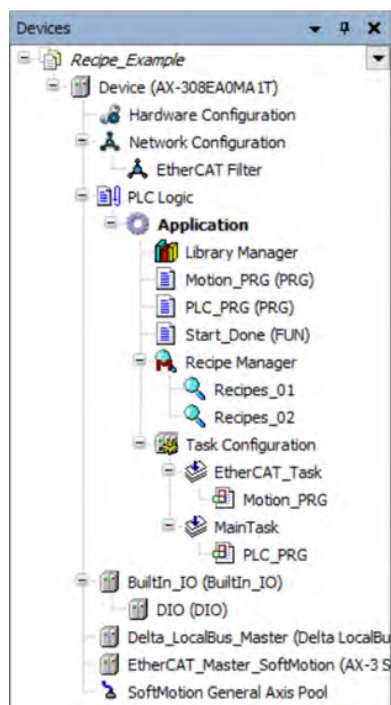

```

POU: PLC_PRG

1  PROGRAM PLC_PRG
2  VAR
3      iVar : INT ;
4      dwVar , dw_Return : DWORD ;
5      udi_Return : UDINT ;
6      bVar0 , bVar1 : BOOL ;
7      FB1 : RecipeManCommands ;
8  END_VAR
9
10
11
12
13
14
15
16  IF bVar0 THEN
17      %MW3 := 50 ;
18      iVar := 60 ;
19      dwVar := 70 ;
20      udi_Return := FB1 . ReadAndSaveRecipe ( RecipeDefinitionName :=
21      'Recipes_01' , RecipeName := 'Case1' ) ;
22      bVar0 := FALSE ;
23  END_IF
24
25  IF bVar1 THEN
26      %MW3 := %MW3 + 10 ;
27      iVar := iVar + 20 ;
28      dwVar := dwVar + 30 ;
29      udi_Return := FB1 . ReadAndSaveAS ( RecipeDefinitionName := 'Recipes_01' ,
30      FileName := 'POU_Variable.txtrecipe' ) ;
31      bVar1 := FALSE ;
32  END_IF
33
34
35
36

```

Chapter 5 Hardware Configuration

Table of Contents

5.1 Environment of Hardware Configuration.....	5-2
5.2. Add a Module	5-5
5.3 Remove a Module.....	5-7
5.4 Copy and Paste a Module	5-9
5.4.1 Copy a Module.....	5-9
5.4.2 Paste a Module	5-10
5.5 Cut and Paste a Module	5-11
5.5.1 Cut a Module.....	5-11
5.5.2 Paste a Module	5-12

Hardware Configuration is the tools in DIADesign-AX for hardware configuration. Its functions include setting parameters for CPU and modules. This chapter will introduce the abovementioned functions.

5.1 Environment of Hardware Configuration

Double-click  **Hardware Configuration** on the Device section to open the Hardware Configuration (Device) window as the image shown below.

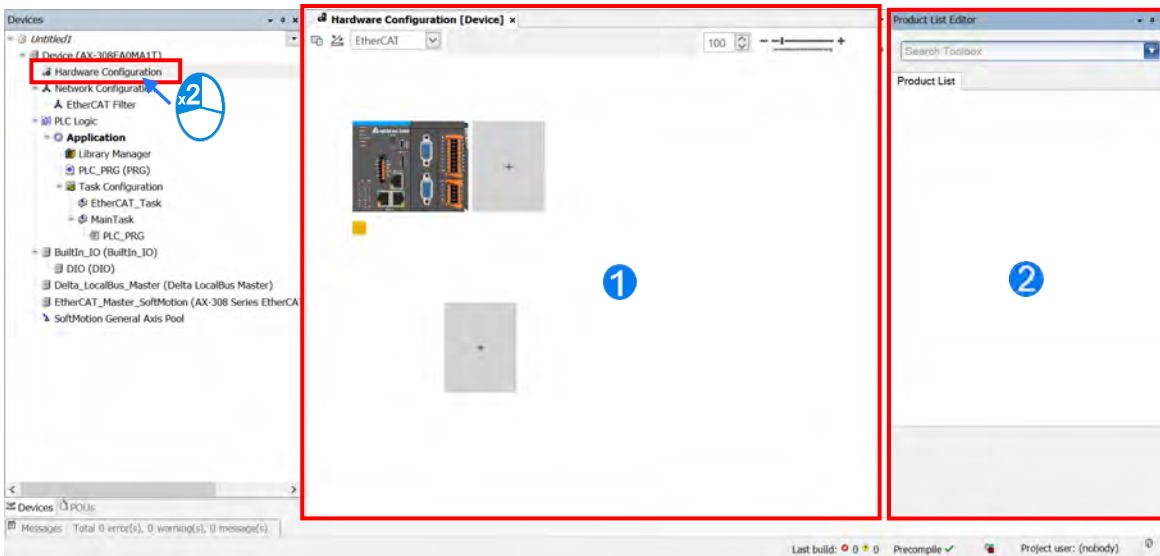



① Hardware Configuration (Device): This is the main work area for system configuration and settings.

② Product List Editor: Here listed out all supported modules for the selected CPU.

Click  to see all the supported modules on the right window (Product List Editor).

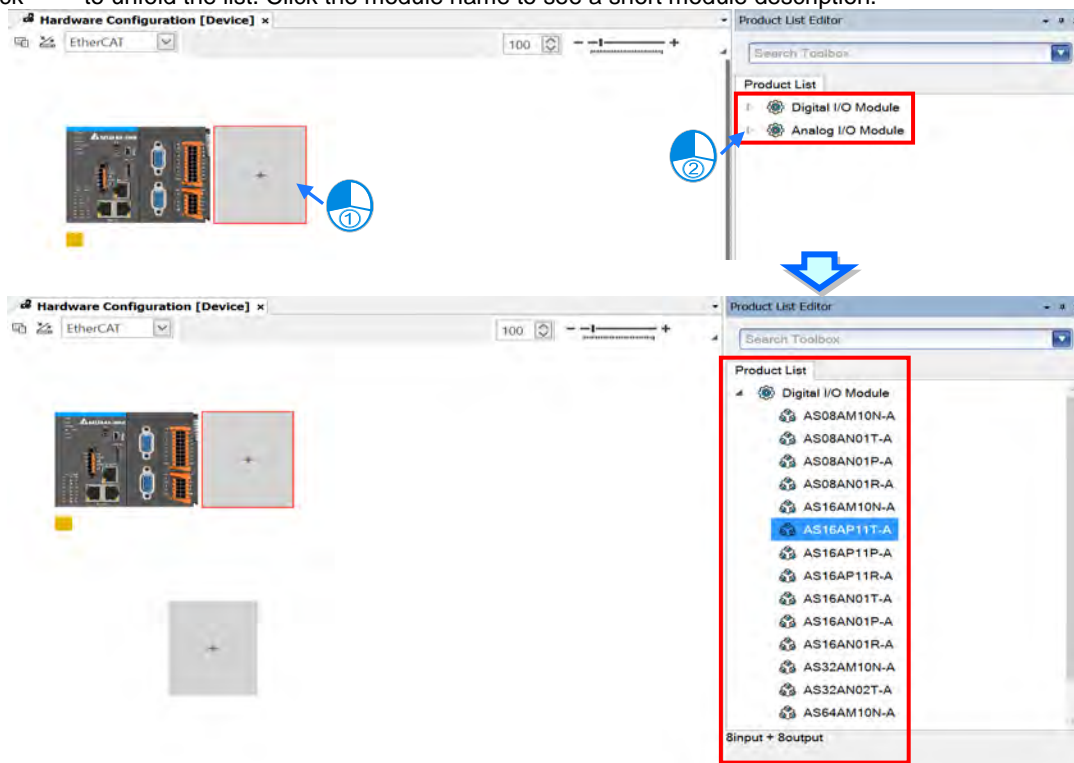
Click  to unfold the list. Click the module name to see a short module description.



Click  on the upper-left corner to see the current configurations. For example, the width of the total connected module, the current consumption and power current output.

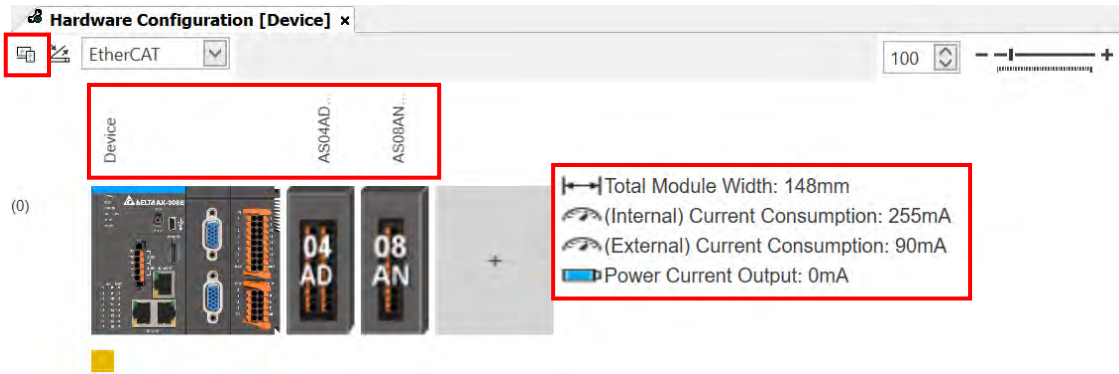

Use  on the upper-right corner to rearrange the device image for better viewing experience and easier operation.

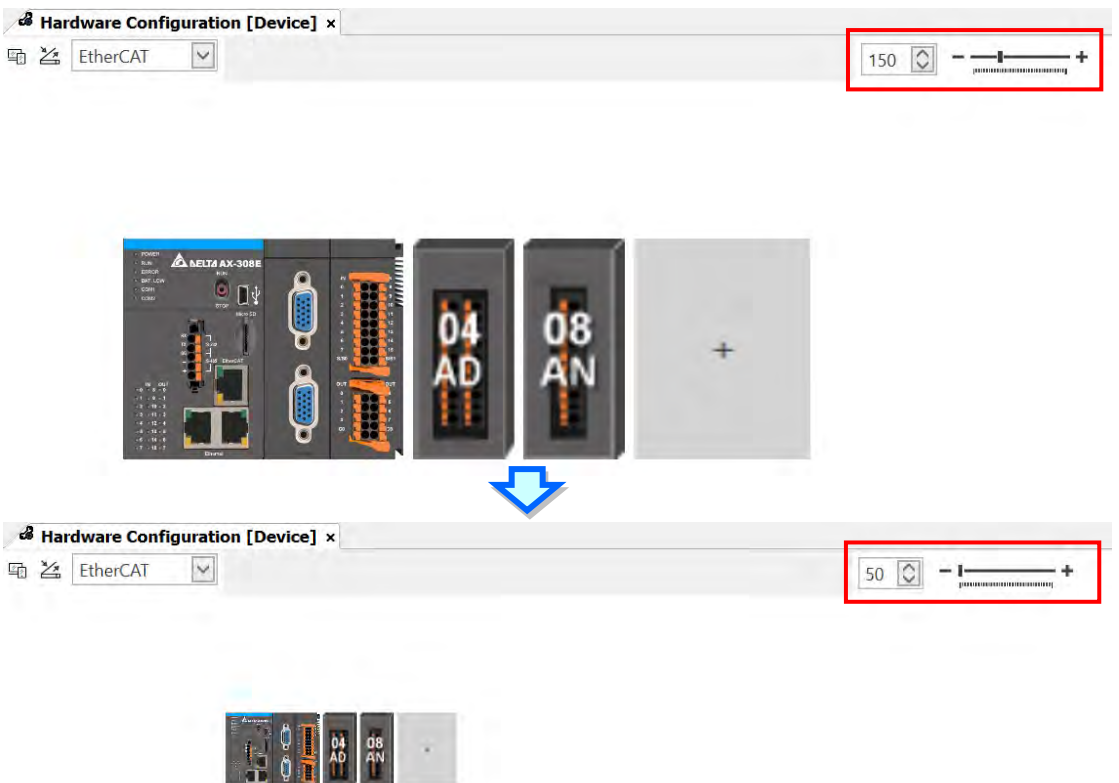

Enter a key word in the **Search Toolbox** on the right-side window and press “Enter” button on your keyboard to search for the matched modules.

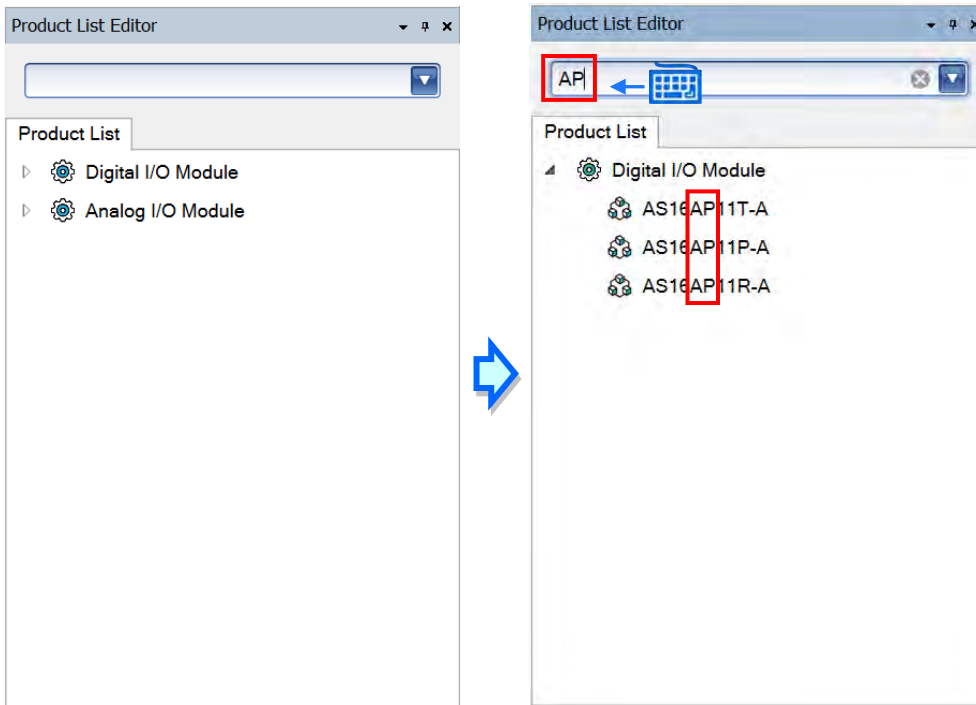

5.2. Add a Module

- **Method 1**

With AX-3 Series PLC backplaneless design, the extension module can install on the right-side of AX-3 Series PLC directly. Double-click or drag and drop the extension module that you'd like to add from the Product List. Newly added extension modules will appear on the right-side of the AX-3 Series PLC. And the device names will also show up on the left-side under Delta_LocalBus_Master.

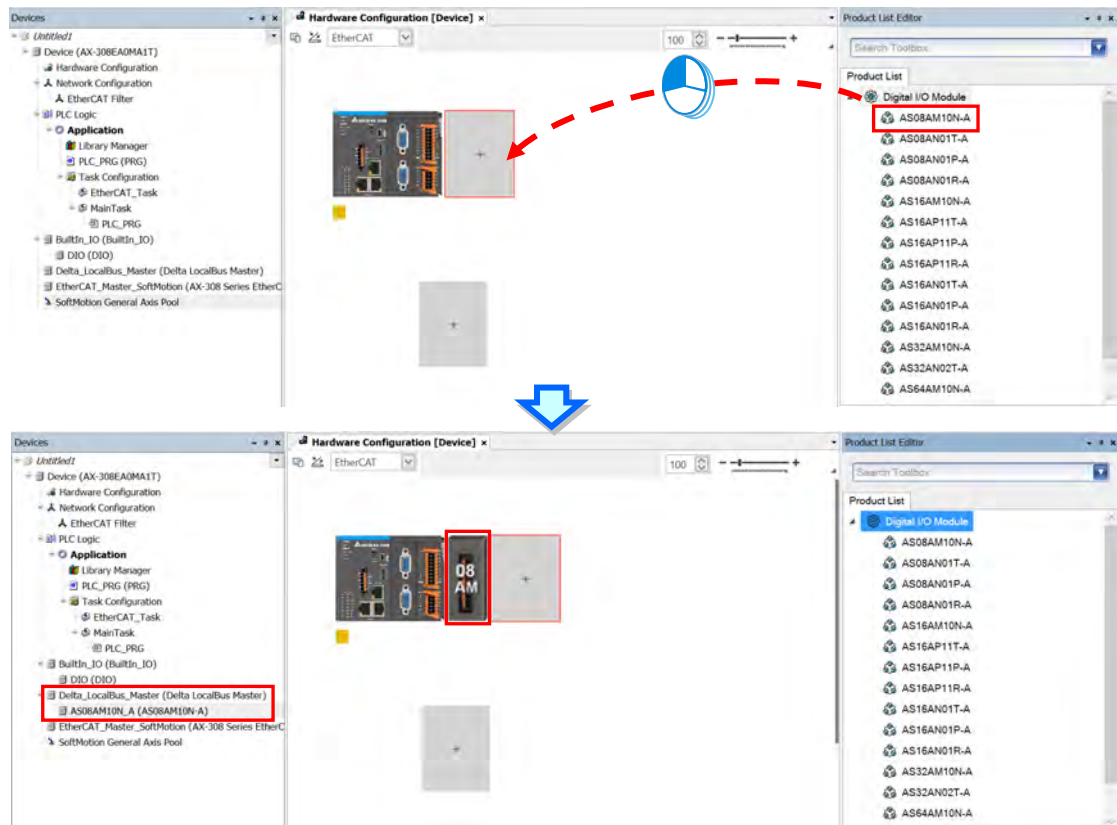

- **Method 2**

If the AX-3 Series PLC and its connected extension module are powered on and the gateway is correctly set, you can use the icon  to scan and add the modules in. Newly added extension modules will appear on the right-side of the AX-3 Series PLC. And the device names will also show up on the left-side under Delta_LocalBus_Master.

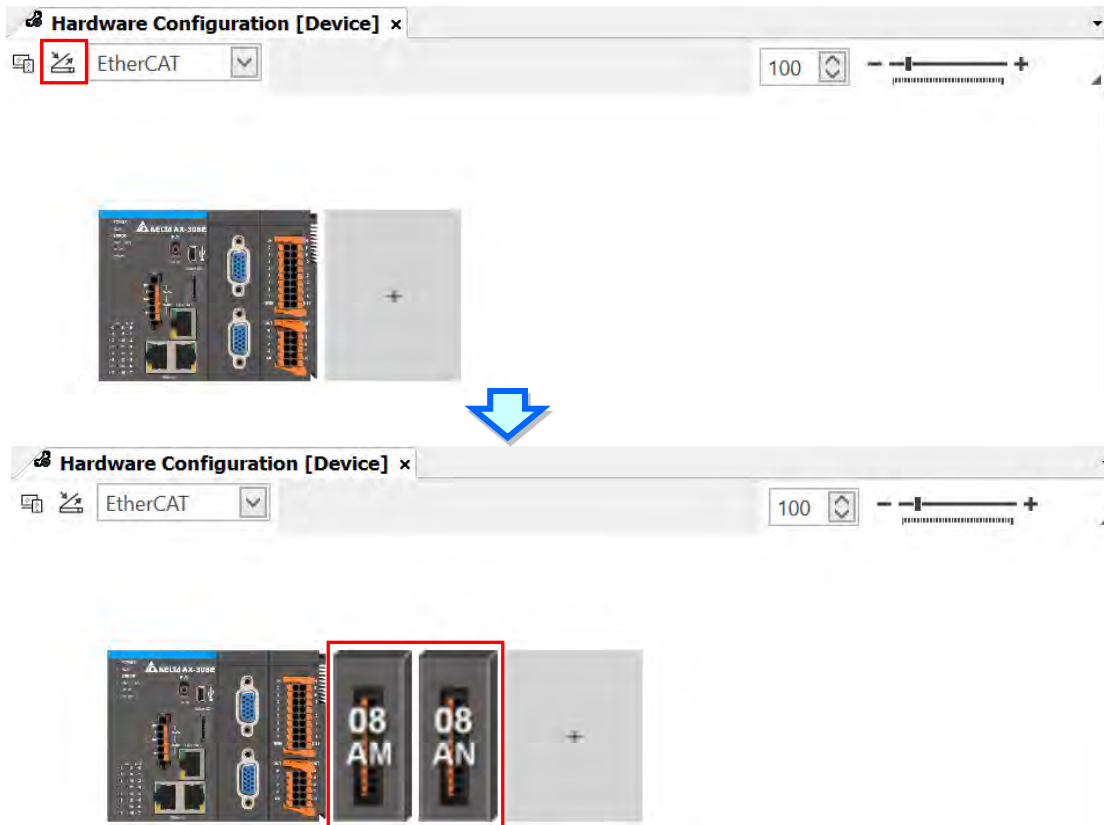

5.3 Remove a Module

You cannot remove a CPU. You can only delete extension modules.

- **Method 1**

Right-click the module image that you'd like to remove to open the context menu and click the option **Delete** or use the Delete Button on your keyboard to remove the module.

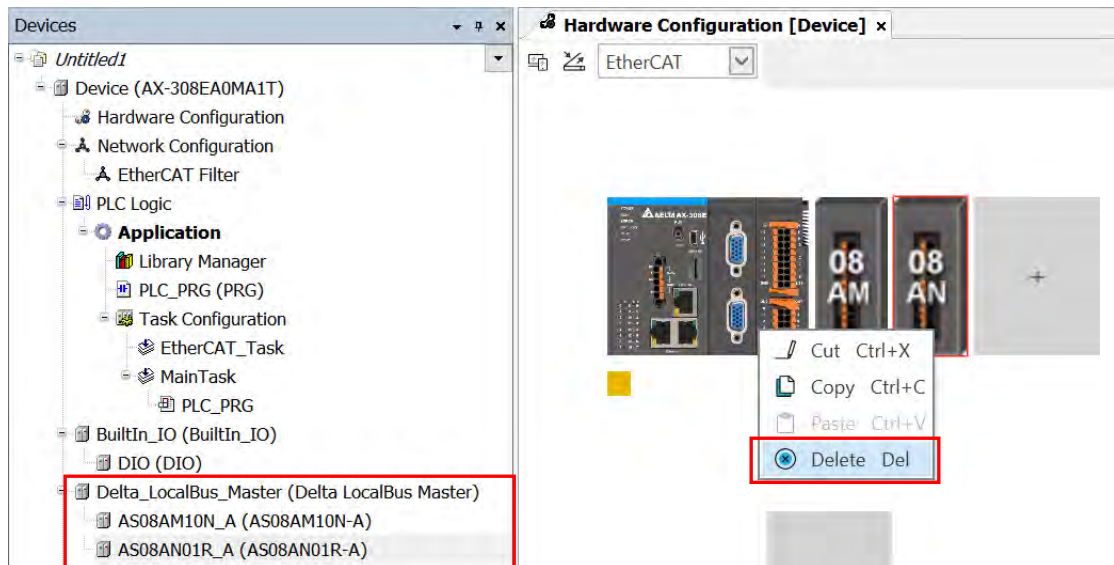

After you click **Delete**, a confirmation shows up. Click **Yes** to delete the module.

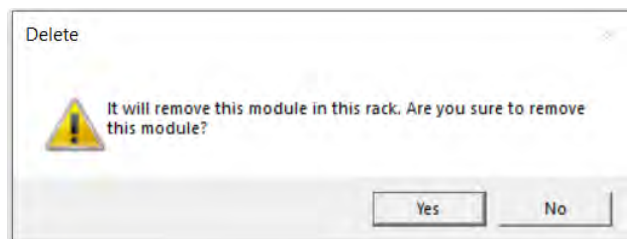

And the device names will also be removed from the left-side under Delta_LocalBus_Master.

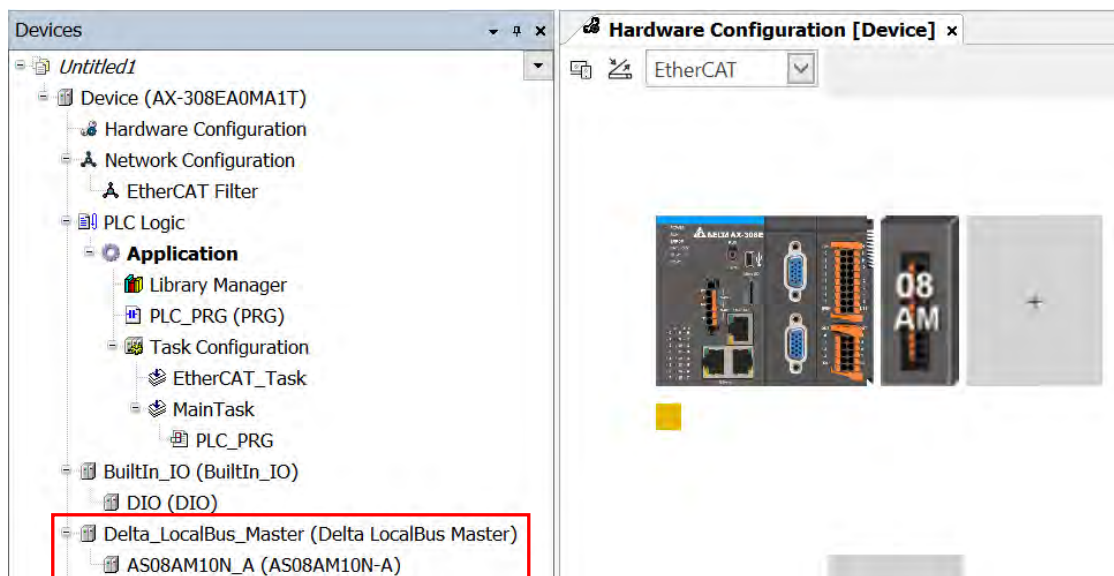

● **Method 2**

Right-click the device name under Delta_LocalBus_Master that you'd like to remove to open the context menu and click the option **Delete** or use the Delete Button on your keyboard to remove the module. After that the device image will also be removed from the editing area.

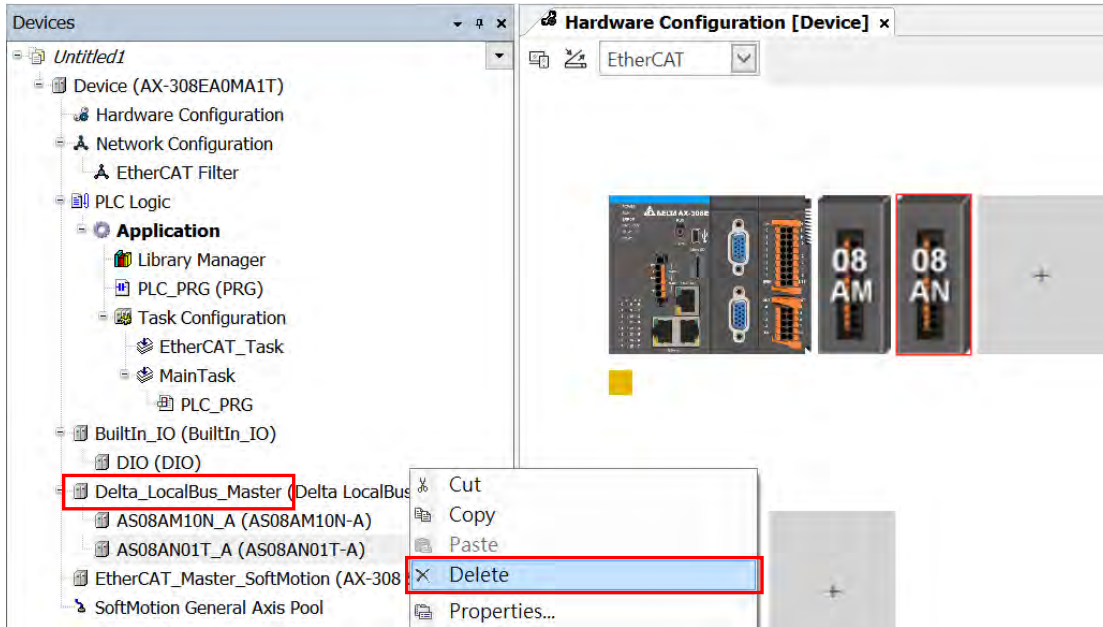

5.4 Copy and Paste a Module

You cannot use copy and paste on a CPU. You can only use copy and paste on extension modules.

5.4.1 Copy a Module

- **Method 1**

Right-click the module image that you'd like to copy to open the context menu and click the option **Copy** to duplicate the module.

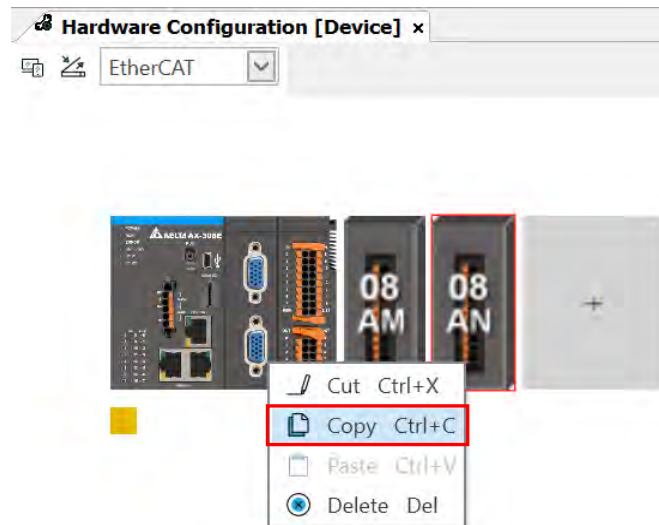

- **Method 2**

Right-click the device name under Delta_LocalBus_Master that you'd like to copy to open the context menu and click the option **Copy** to copy the module.

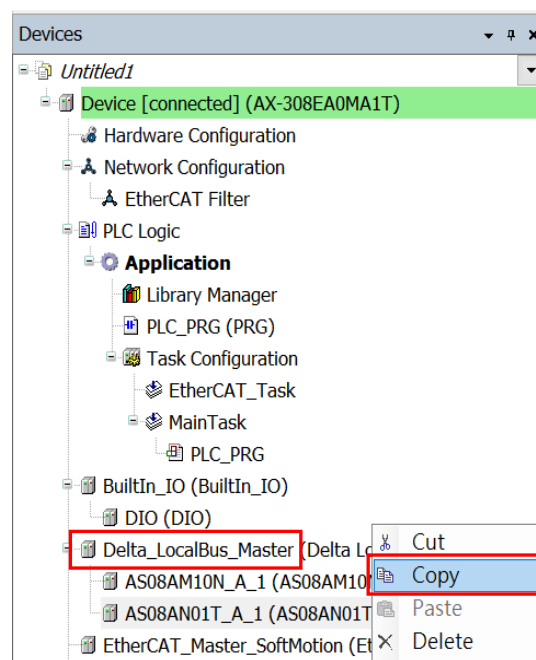

5.4.2 Paste a Module

- **Method 1**

You can place the module between modules. Right-click where you'd like to paste the module to open the context menu and click the option **Paste** to place the module on the left of the module you had clicked. Or you can place the module at the end by right-clicking the + to paste the copied module there.

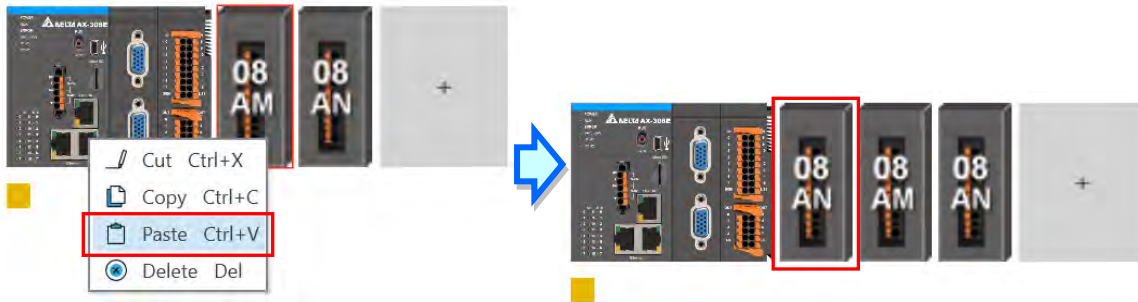

And the device names will also be updated on the left-side under Delta_LocalBus_Master.

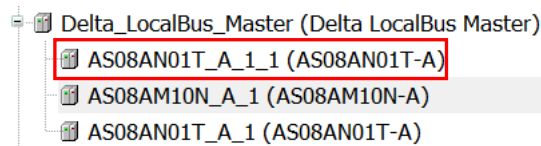

- **Method 2**

You can place the module between modules. Right-click where you'd like to paste the module under Delta_LocalBus_Master to open the context menu and click the option **Paste** to place the module above the module you had clicked. Or you can place the module at the end by right-clicking Delta_LocalBus_Master to paste the copied module.

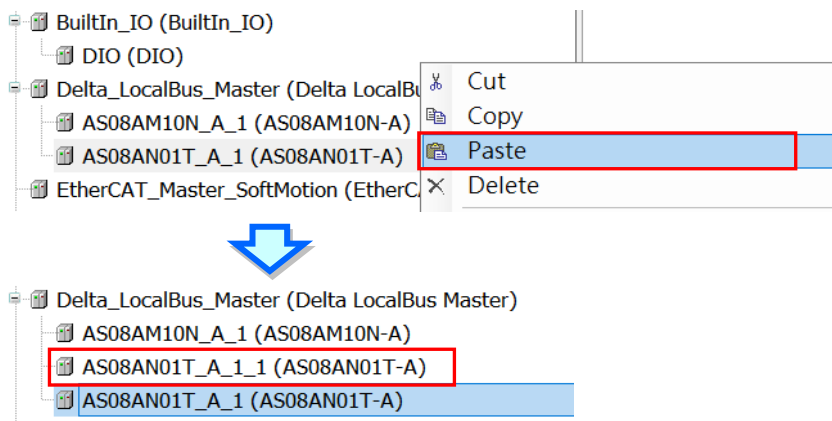

And the module image will also be updated on the editing area.



5.5 Cut and Paste a Module

You cannot use cut and paste on a CPU. You can only use cut and paste on extension modules.

5.5.1 Cut a Module

- **Method 1**

Right-click the module image that you'd like to cut to open the context menu and click the option **Cut** to take out the module.

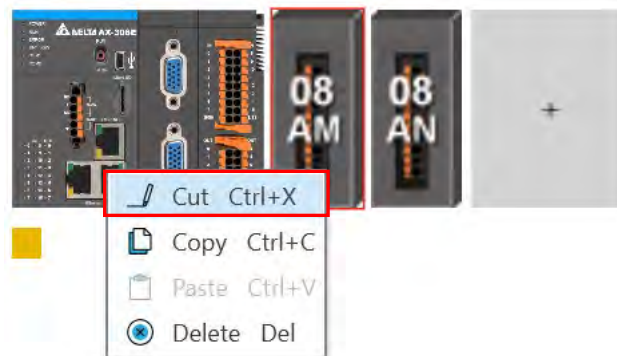

- **Method 2**

Right-click the device name under Delta_LocalBus_Master that you'd like to cut to open the context menu and click the option **Cut** to take out the module.

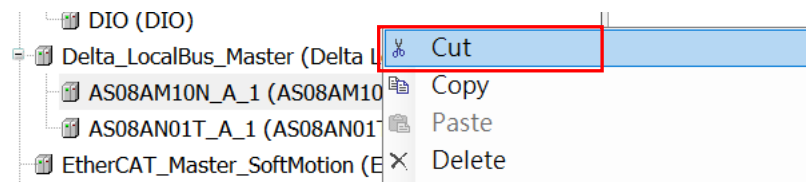

5.5.2 Paste a Module

- **Method 1**

You can place the module between modules. Right-click where you'd like to paste the module to open the context menu and click the option **Paste** to place the module on the left of the module you had clicked. Or you can place the module at the end by right-clicking the + to paste the copied module there.

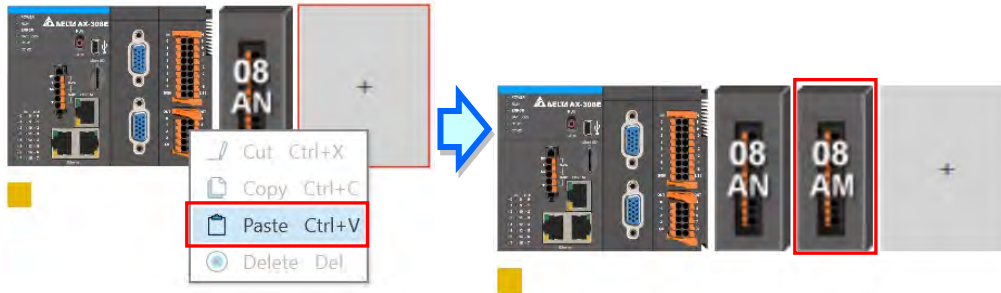

And the device names will also be updated on the left-side under Delta_LocalBus_Master.

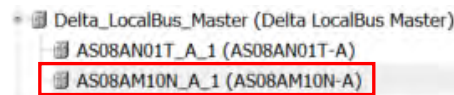

- **Method 2**

You can place the module between modules. Right-click where you'd like to paste the module under Delta_LocalBus_Master to open the context menu and click the option **Paste** to place the module above the module you had clicked. Or you can place the module at the end by right-clicking Delta_LocalBus_Master to paste the copied module.

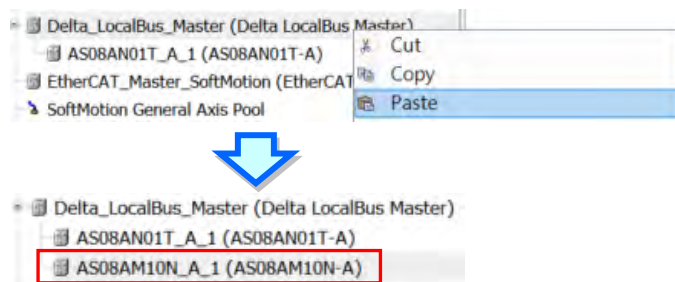

And the module image will also be updated on the editing area.



Chapter 6 Network Configuration

Table of Contents

- 6.1 Network Configuration 6-2**
- 6.1.1 Introduction 6-2
- 6.1.2 Basic Knowledge..... 6-3
- 6.1.3 Creating a Network Topology..... 6-5

6.1 Network Configuration

DIADesigner-AX provides a Network Configuration tool for users to configure the network in a project. Detailed network setting information will be covered in the following sections.

6.1.1 Introduction

You can use Network Configuration to to:

- (a) create networks such as EtherCAT, Modbus, Ethernet, CANOpen in a project and set up file sending paths
- (b) set up EtherCAT Master
- (c) set up Modbus COM port
- (d) set up Ethernet IP settings

Network Configuration is under the Device tree. You can double-click  **Network Configuration** to open its setting page and start planning a network framework for the project.

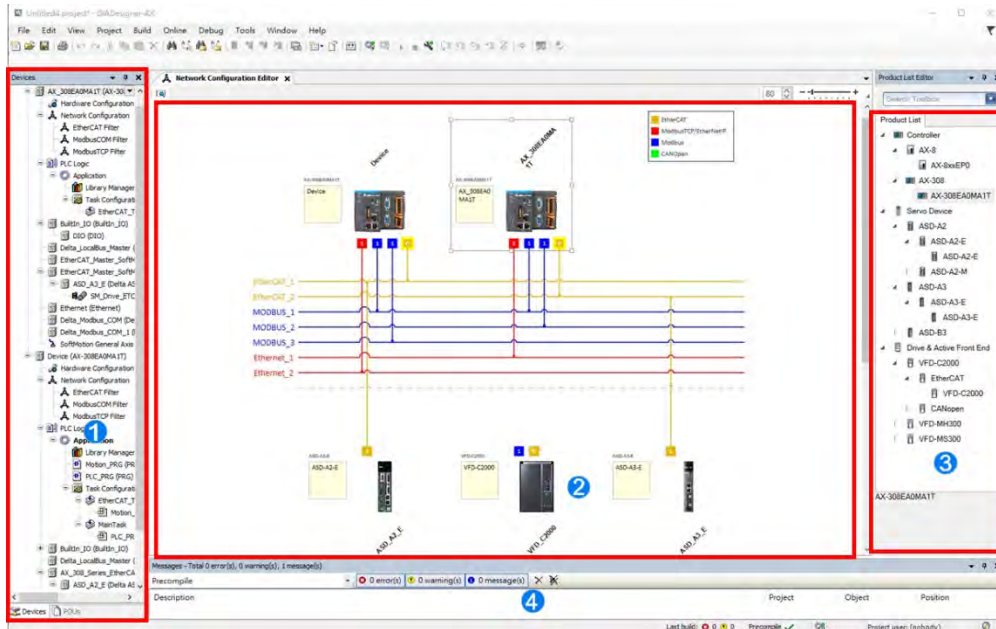
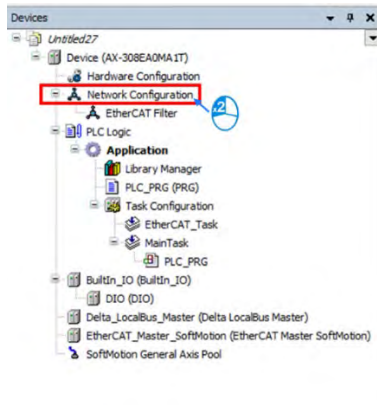

- ❶ **Device:** Here shows all the configured devices in a tree view.
- ❷ **Working area:** Here is the main working area for you to create a network framework.
- ❸ **Device list:** Here lists all the available devices in a tree view.
- ❹ **Message display area:** Here displays operational messages.

6.1.2 Basic Knowledge

Before creating networks, you need to have some basic knowledge. Here we provide some basic knowledge in the following sections for you.

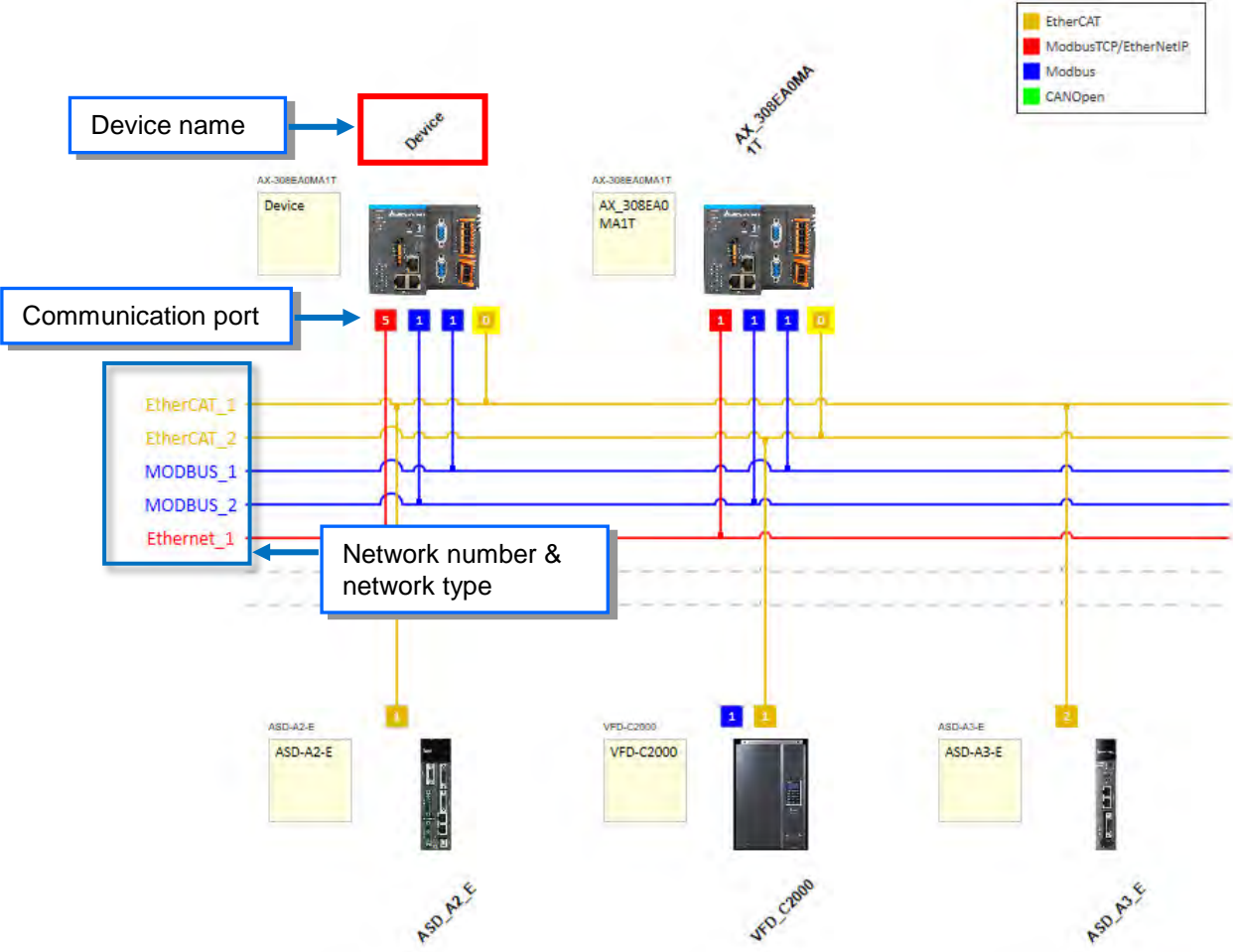

- **Device and Network**

A device is the most basic element in a network. It can be a PLC, a servo, a drive or any device that you defined. Here a network is a collection of devices which are interconnected. Every communication port should be assigned with a network type, such as Modbus, Ethernet, EtherCAT or CANOpen. A physical interface that a device uses to connect to a network is a communication port of the device. If there are more than two ports on a device, the device can connect to different networks.

- **Device Name**

A device name is the identity of the device. You can identify a device in the Device Tree by its name. However it bears little significance on operation.

● **Network Type and Communication Port**

■ **EtherCAT**

The orange yellow line indicates the EtherCAT communication. Double-click the Master station node to open the EtherCAT setting page of the Master. The number of Master Station is 0 and that cannot be changed. Double-click the connection of Slave to open the EtherCAT setting page of the Slave. The last digit appeared in the EtherCAT address 1001 is used as an indicator of this connection on the Network Configuration Editor page.

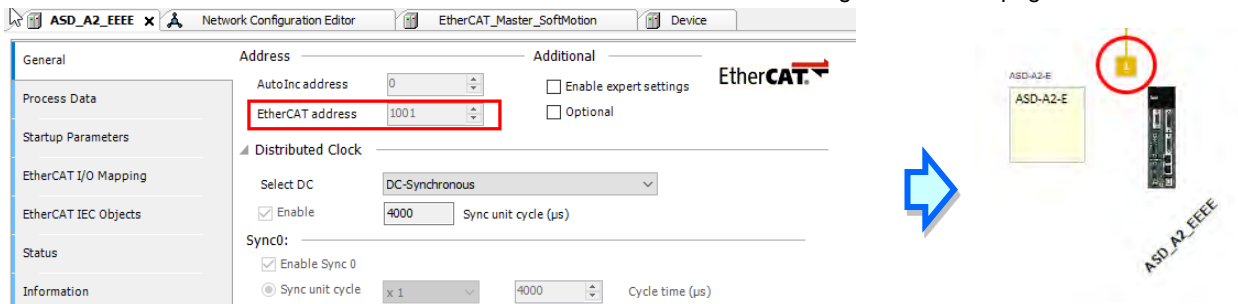

■ **Modbus TCP/EtherNETIP**

The blue line indicates the Modbus TCP/EtherNetIP communication. Double-click this line to open its setting page to edit IP addresses. The last digit appeared in the last section of the IP address is used as an indicator of this connection on the Network Configuration Editor page.

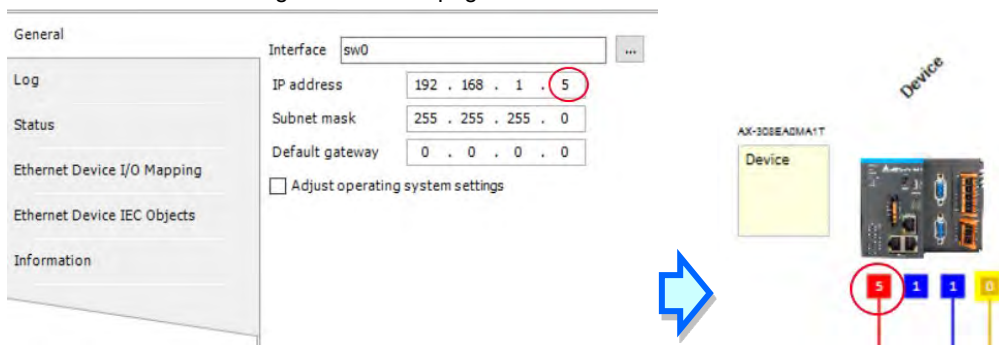

■ **Modbus**

The blue line indicates the Modbus communication (RS-232 / RS-485). Double-click this line to open the Modbus communication port setting page.

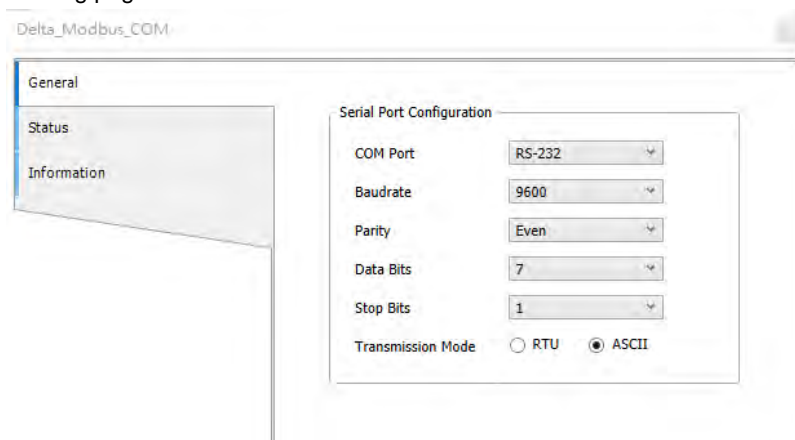

6.1.3 Creating a Network Topology

6.1.3.1 Station Nodes

When you open the Network Configuration for the first time, the system creates a graphical representation automatically.

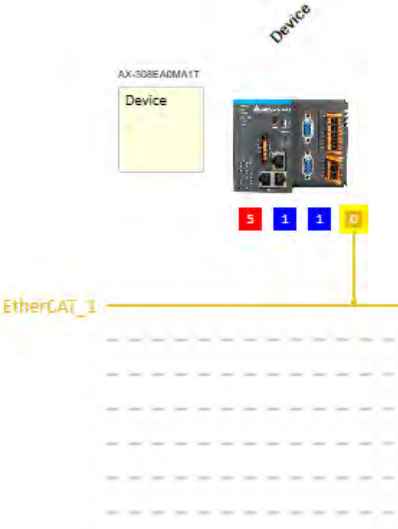

You can use the following methods to add devices including PLCs, servo motors, and drives in the network topology.

- **Method 1**

Double-click the device that you want to add from the **Product List** on the right. After that you can see the added device is updated in the graphical representation and also on the Device Tree.

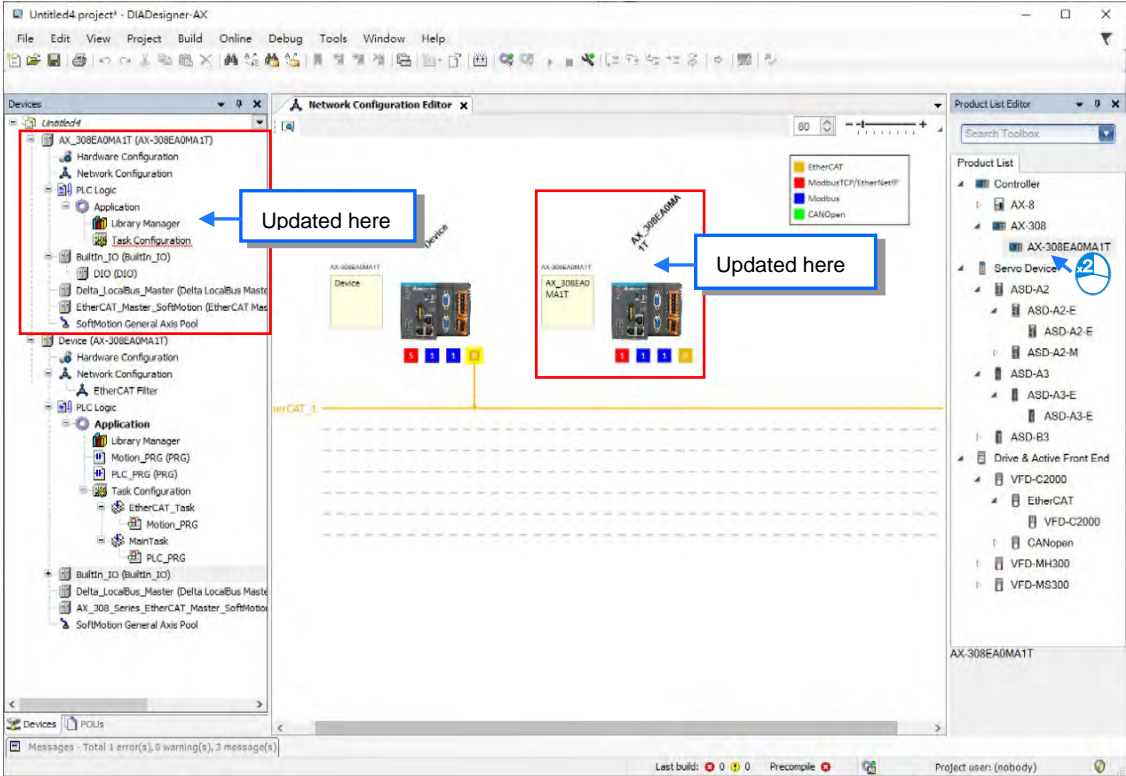

● **Method 2**

Right-click the project name on the Device Tree to bring out the context menu. Double-click **Add Device** on the context menu to open a setting page for adding devices. Double-click the device you'd like to add or click **Add Device** to add the device in.

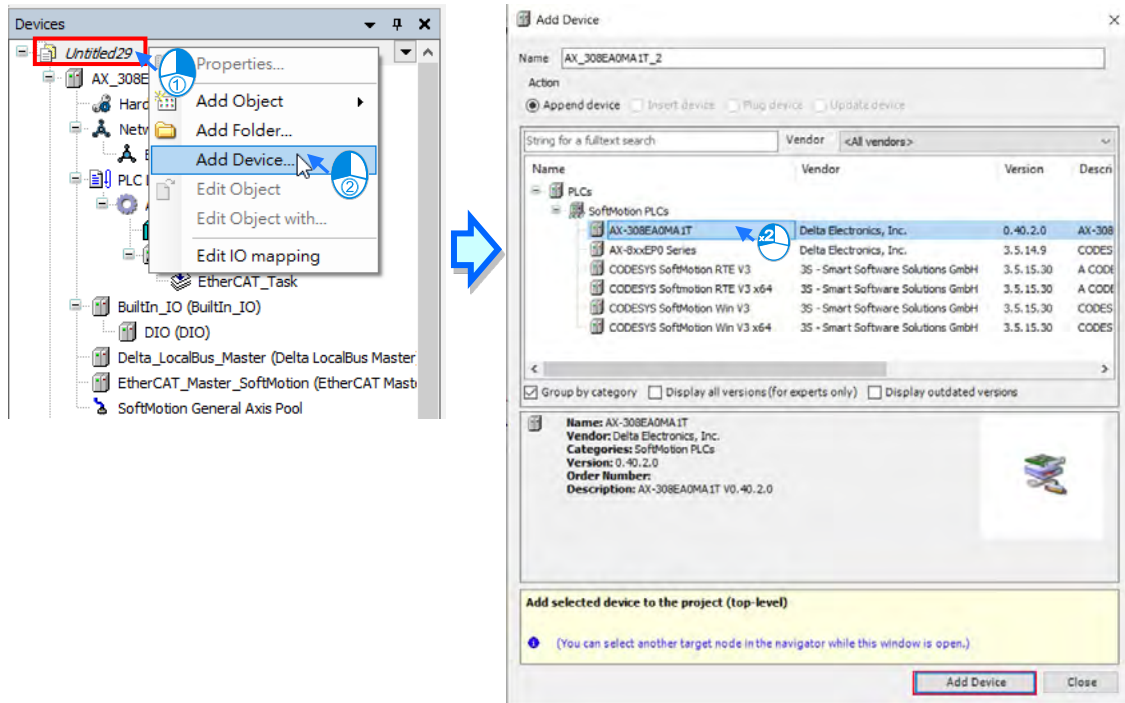

● **Method 3**

Right-click the device to bring out the context menu and click **Network Scan** or click the icon  for Network Scan to automatically scan and then add the connected configured devices and network in the project.

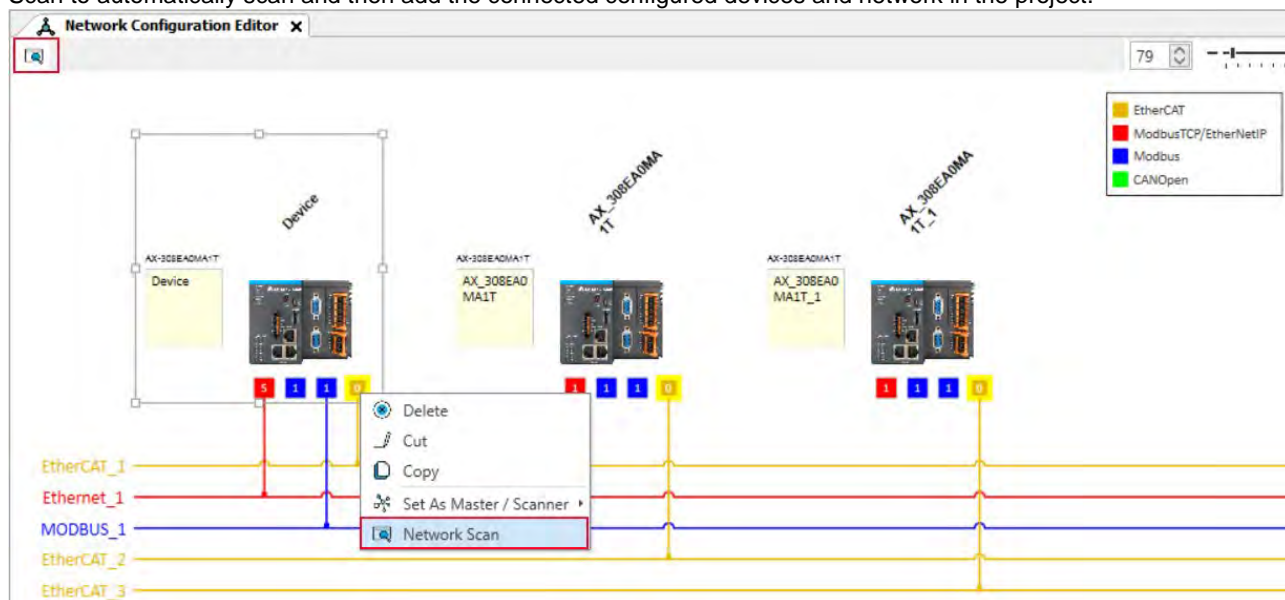

6.1.3.2 Creating a Connection

After creating the station nodes, you can start to create connections. The network types include Modbus, Ethernet, EtherCAT and CANOpen. Refer to 6.1.2 for more information.

You can use the following methods to add created network connections.

- **Method 1**

Drag and drop the communication port to the corresponding network type shown in line to create a connection between devices.

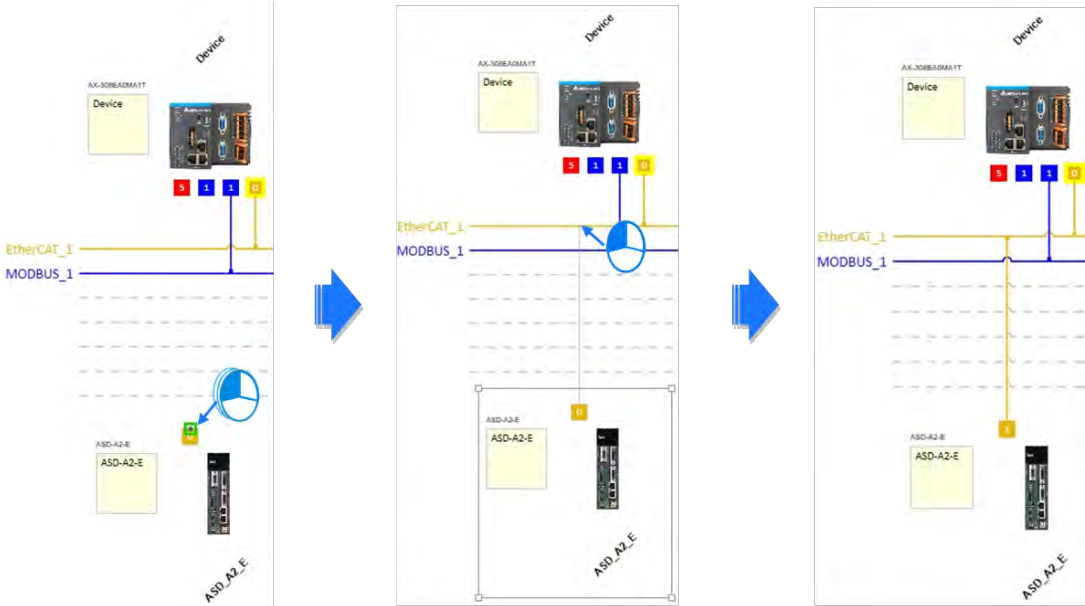

- **Method 2**

Hold the communication port and drag it to the unused dotted line to create a network connection that is the same as the selected network communication type and then a new gray unused dotted line will also be created.

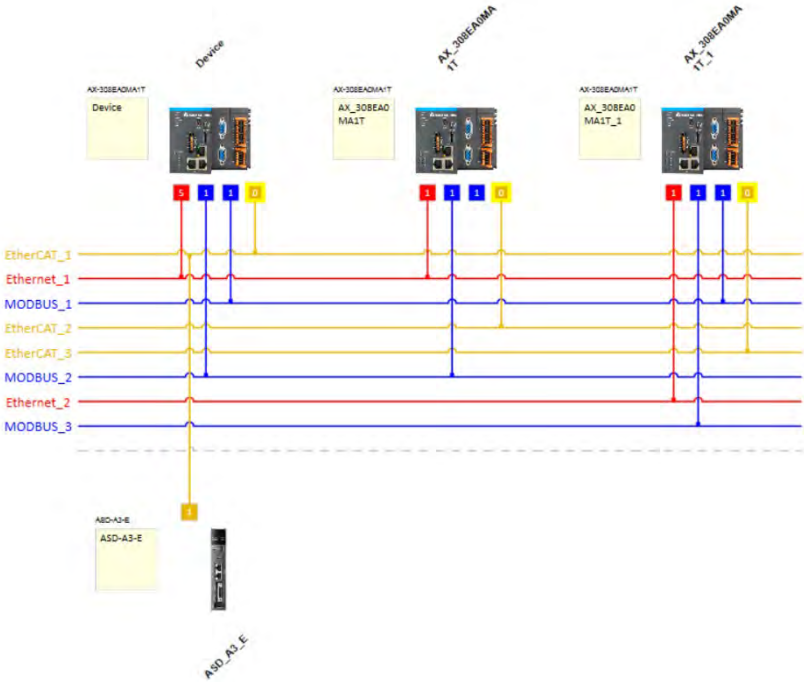

MEMO

Chapter 7 Motion Control Setup & Operation

Table of Contents

7.1	Introduction on Motion Control Instructions	7-5
7.1.1	Motion Control Instructions	7-5
7.1.2	Application Notes on Motion Control Instructions.....	7-5
7.1.3	Categories of Motion Control Instructions.....	7-6
7.2	Creating Motion Control Project	7-7
7.2.1	Process Flowchart	7-7
7.2.2	Process for Creating a Project.....	7-8
7.3	Commissioning	7-14
7.3.1	Procedure for Commissioning	7-14
7.3.2	Example of Axis Parameter Settings	7-14
7.3.3	Perform Axes Commissioning.....	7-16
7.4	Motion Control Device	7-19
7.4.1	Overview	7-19
7.4.2	Introduction to Axis.....	7-19
7.4.2.1	About Axis Parameters	7-20
7.4.2.2	Axis Application in Program	7-28
7.4.3	Procedure for Single-axis Configuration	7-29
7.4.4	Axis Group Settings.....	7-36
7.4.4.1	Parameters for Axis Group	7-36
7.4.4.2	Using Axis Groups in Program	7-38
7.4.5	Procedure for Axis Group Configuration.....	7-39
7.5	Motion Axis Variables	7-44
7.5.1	Variables for Single Axis.....	7-44
7.5.2	Variables for Axis Group.....	7-47
7.6	Motion Control Programming	7-50
7.6.1	Motion Control Program	7-50
7.6.1.1	Program Architecture and Types in DIADesigner-AX.....	7-50

7.6.1.2	POU in DIADesigner-AX.....	7-51
7.6.1.3	Adding POU in DIADesigner-AX	7-51
7.6.1.4	PDO Mapping.....	7-53
7.6.2	Axis State Transitions	7-54
7.6.2.1	Axis State	7-54
7.6.2.2	Axis Group State.....	7-56
7.6.3	Execution and Status Indication for Motion Control Instructions.....	7-57
7.6.3.1	Basic Rules of Executing Instructions.....	7-58
7.6.3.2	Timing Diagram for Input/Outputs.....	7-60
7.6.3.3	Repeated Execution Behavior of Single Axis Motion Instructions	7-60
7.6.3.4	Multi-execution of Motion Control Instructions	7-61
7.6.3.5	Synchronous Execution Eehavior of Motion Instructions	7-61
7.6.4	Position	7-67
7.6.4.1	Types of Positions	7-67
7.6.5	CAM Tables and Framework	7-67
7.6.5.1	E-CAM Framework.....	7-67
7.6.5.2	Creating E-CAM.....	7-68
7.7	Motion Control Functions	7-72
7.7.1	System Structure.....	7-72
7.7.2	Single-axis Control.....	7-72
7.7.2.1	Cyclic Synchronous Position Mode	7-72
7.7.2.2	Profile Position Mode.....	7-73
7.7.2.3	Positioning	7-73
7.7.2.4	Stop Method.....	7-74
7.7.2.5	MC_GearIn	7-77
7.7.2.6	MC_GearInPos	7-79
7.7.2.7	MC_CamIn	7-80
7.7.3	Velocity Control	7-90
7.7.3.1	CSP Mode.....	7-90
7.7.3.2	CSV Mode	7-91
7.7.3.3	Profile Velocity Mode.....	7-91
7.7.4	Torque control	7-92
7.7.5	Common Functions for Single-axis Control	7-93
7.7.5.1	Command Position	7-93

7.7.5.2	Velocity Command	7-95
7.7.5.3	Acceleration and Deceleration Command	7-96
7.7.5.4	Jerk Command	7-97
7.7.5.5	Axis Direction	7-98
7.7.6	Axis Group Control	7-100
7.7.6.1	Linear Interpolation	7-100
7.7.6.2	Circular Interpolation	7-102
7.7.6.3	Group Stop Command	7-104
7.7.7	High-speed IO	7-105
7.7.7.1	IO Configurations	7-105
7.7.7.2	DIO Settings	7-107
7.7.7.3	SSI Encoder Settings	7-111
7.7.7.4	Pulse Encoder Settings	7-119
7.7.7.5	Capture/Compare Function Settings	7-133
7.7.7.6	Pulse Output Function Settings	7-139
7.7.7.7	Confirm High-Speed IO Errors	7-144
7.7.8	Other Features	7-145
7.7.8.1	Change Current Position	7-145
7.7.8.2	Software Limit	7-145
7.7.8.3	Position Lag Settings	7-146
7.7.8.4	Cam Switch Functions	7-147
7.7.8.5	Position Capture	7-147
7.8	Programming Example	7-149
7.8.1	Device Framework	7-149
7.8.1.1	Utilization	7-149
7.8.1.2	Configurations	7-149
7.8.2	Examples	7-149
7.8.2.1	Servo On	7-151
7.8.2.2	Reset and Control Single-axis Error	7-152
7.8.2.3	Control on Instruction Errors	7-155
7.8.2.4	Quick Stop for Single Axes	7-157
7.8.2.5	Home Positioning	7-159
7.8.2.6	Absolute Positioning	7-162
7.8.2.7	Switch CAM Table during CAM Operation	7-163

7.8.2.8	Perform Master PhaseOffset for CAM.....	7-172
7.8.2.9	Change Current Position in Movement.....	7-179
7.8.2.10	Perform Superimposed during Gear Engagment.....	7-184

7.1 Introduction on Motion Control Instructions

7.1.1 Motion Control Instructions

This manual introduces the elements for motion control programming including devices, symbols and motion control instructions.

Motion control instructions are defined as function blocks (FB) and are used in the program for performing a variety of motion control purposes. The motion control (MC) instructions are developed based on the specifications of PLCopen* motion control function blocks.

This section gives an overview of the motion control instructions for both PLCopen-based function blocks and Delta-defined function blocks. PLCopen defines the program and function block interfaces so as to achieve a standardized motion control programming environment for the languages specified in IEC61131-3. Using PLCopen-based instructions together with Delta-defined instructions reduces the costs for training and support.

Before using the instructions, please be sure that you understand the devices, symbols and the function of instructions sufficiently.

You can also refer to the **Appendices** for a quick reference of the motion control instruction list and error codes.

***Note:**

PLCopen is an organization promoting industrial control based on IEC61131-3, which is an international standard widely adopted for PLC programming. For more information regarding PLCopen, check the official website at: <http://www.plcopen.org/>

7.1.2 Application Notes on Motion Control Instructions

This section explains important specifications and limitations when applying motion control instructions. For detailed information of each instruction in this manual, refer to section 7.6.3 Motion Control Programming.

■ Programming languages for motion control instructions

You can use all programming languages provided by DIADesigner-AX to create, edit, or maintain the program. The supported languages include Ladder Diagram (LD), Sequential Function Chart (SFC), Continuous Function Chart (CFC), Structured Text (ST) and Function Block Diagram (FBD).

For detailed information about the programming languages, refer to **DIADesigner-AX Software Manual**.

7.1.3 Categories of Motion Control Instructions

This section explains the categories of motion control instructions. The relating instructions can be found in the libraries of SM3_Basic, DL_MotionControl and DL_MotionControlLight, which the details are set out in **AX Series Motion Controller Manual**.

Categories	Type	Function Group	Description
Single-axis motion control instructions	Motion	Single axis positioning	“SMC”: Motion instructions “MC_”: PLCopen motion control instructions “DMC_”: Delta motion control instructions “MC_XXX_DML”: Delta motion control instructions, used with positioning axis.
		Velocity control on single axis	
		Torque control on single axis	
		Synchronized control on single axis	
	Administrative	Administrative functions on single axis	
Multiple-axis motion control instructions	Motion	Axis group movement functions	Multiple-axes motion
	Administrative	Administrative functions on multiple axes	Multiple-axes configuration, monitoring and reset function.

7.2 Creating Motion Control Project

7.2.1 Process Flowchart

The following flowchart shows the process of creating motion control project and positioning axis.

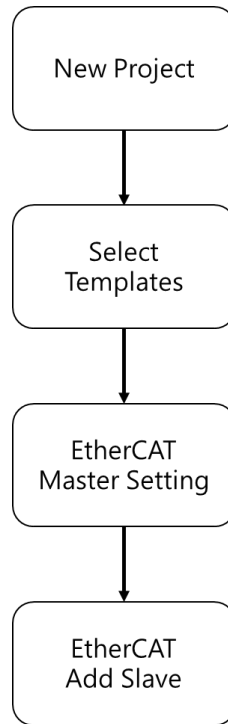

7.2.2 Process for Creating a Project

- Create a new project
- Double click on the DIADesigner-AX icon to open the software.



- Click **File**.



- Choose **New Project**

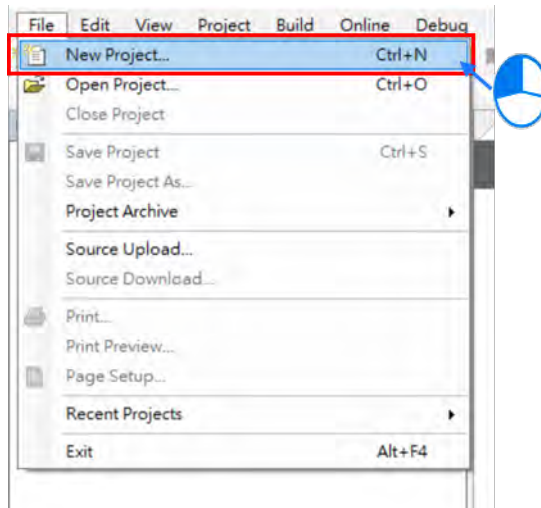

- Type in the fields of **Name** and **Location** in the New Project window, select the desired project and then click **OK**. Model AX-308E is taken as an example to illustrate the process, which the project name is shown as "Project AX-308EA0MA1T".

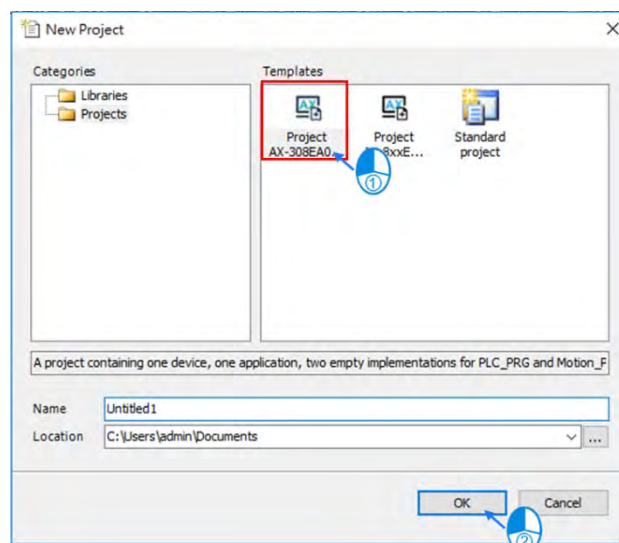

- Double-click on “Network Configuration” to continue with EtherCAT settings.

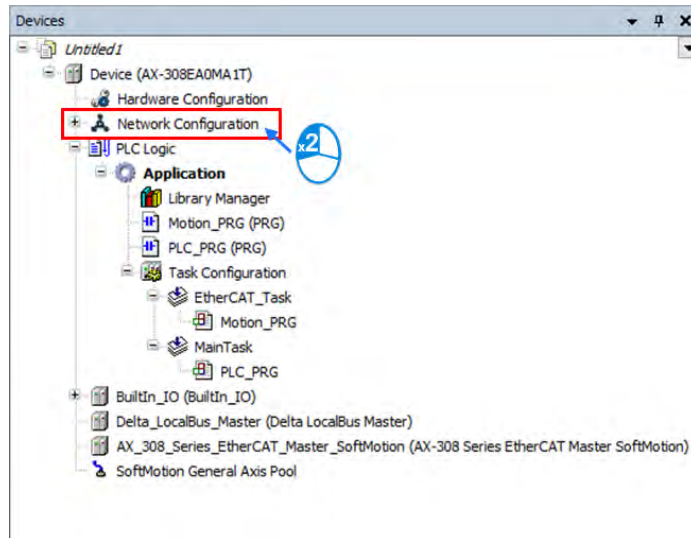

- “Network Configuration Editor” window will pop up after double-click. Find the target slave devices from “Product List Editor” on the right.

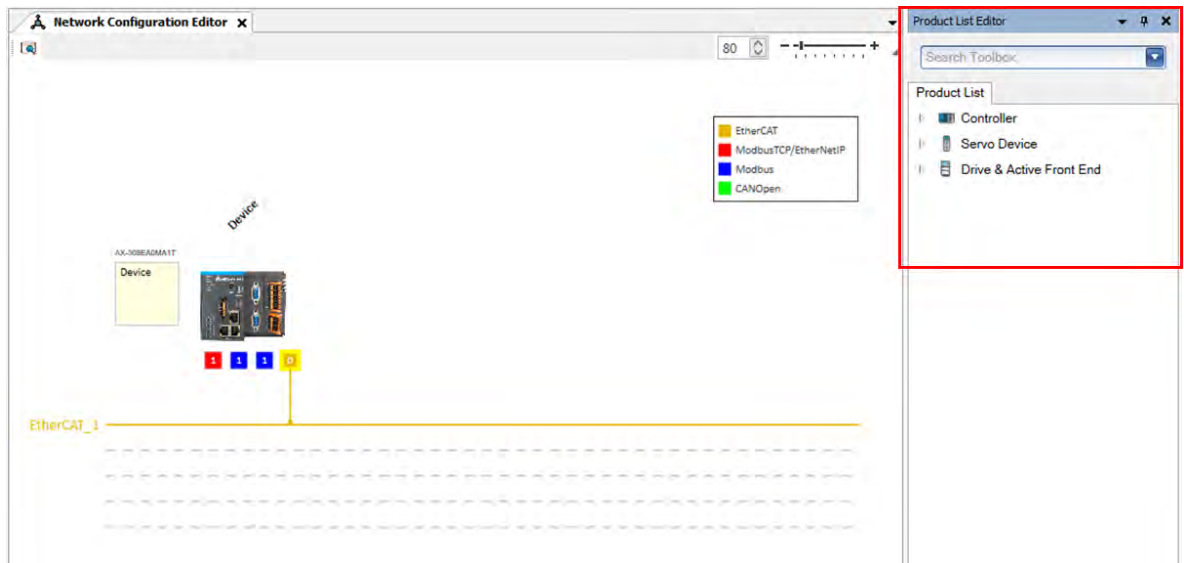

- Choose “Servo Device” → “ASD-A2” → “ASD-A2-E” from the product list. Then, the device will be automatically added to “Network Configuration Editor” after a double-click

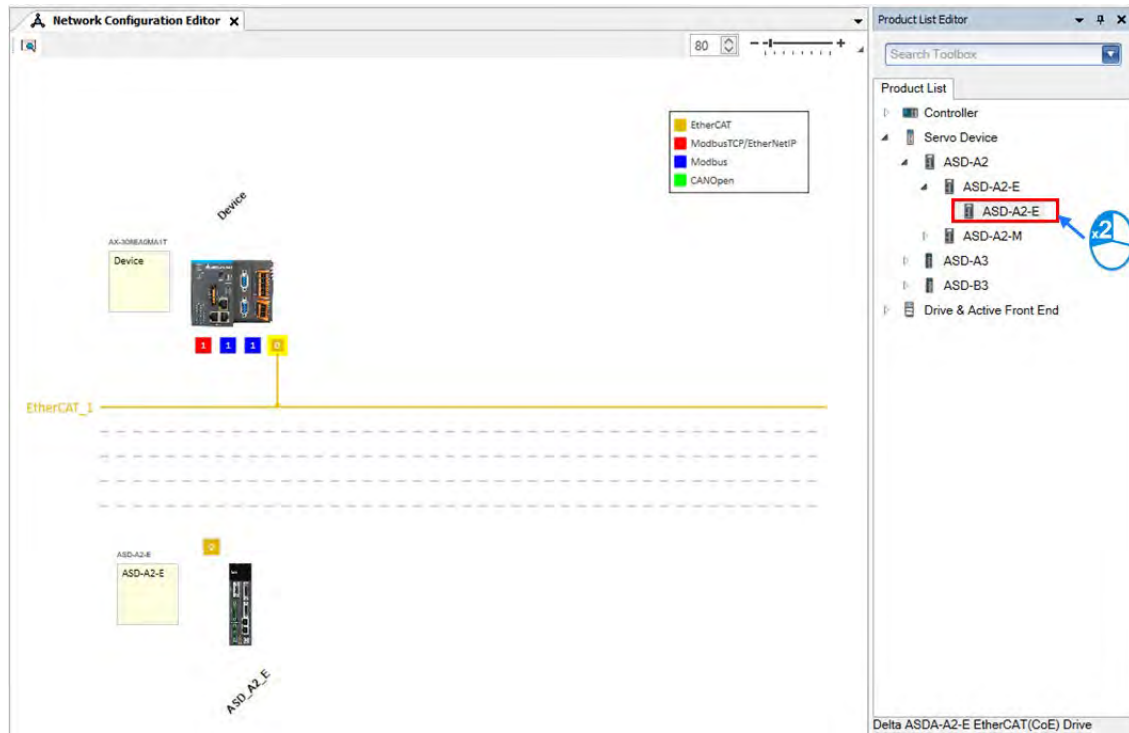

- Click and hold the left mouse button on the yellow box of slave device and drag it towards the EtherCAT main line to complete the configuration of master-slave connection.

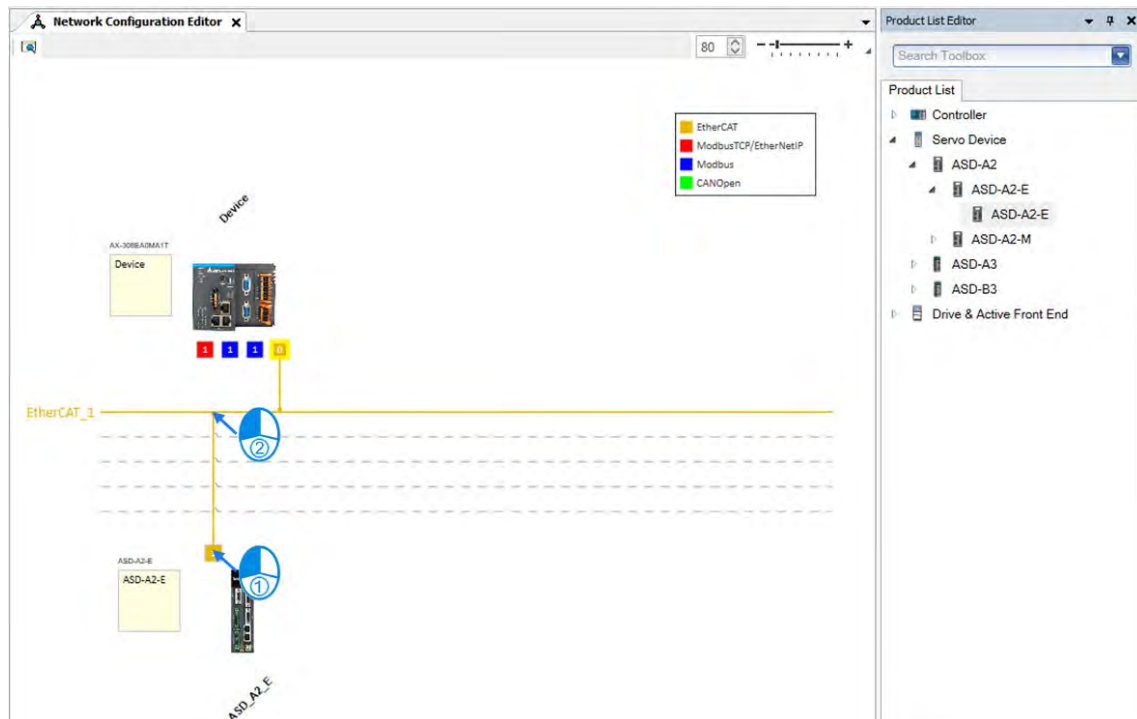

- Double-click on the yellow box of master device to continue on parameter settings for EtherCAT master device.

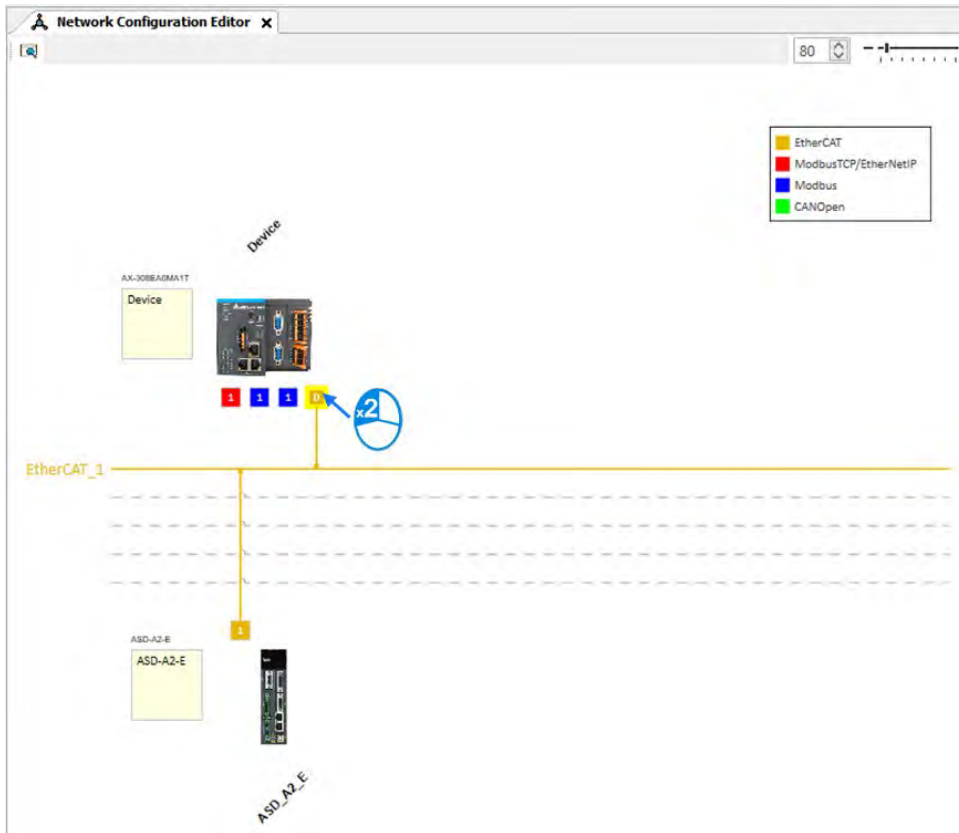

- EtherCAT distributed clock can be configured within master device settings.

General Autoconfig Master/Slaves **EtherCAT**

EtherCAT NIC Setting

Destination address (MAC) FF-FF-FF-FF-FF-FF Broadcast Enable redundancy

Source address (MAC) 00-00-00-00-00-00

Network Name cpsw1

Select network by MAC Select network by name

Distributed Clock Options

Cycle time 2000 μs

Sync offset 50 %

Sync window monitoring

Sync window 1 μs

7

- Double-click on the slave device to continue on EtherCAT slave device settings.

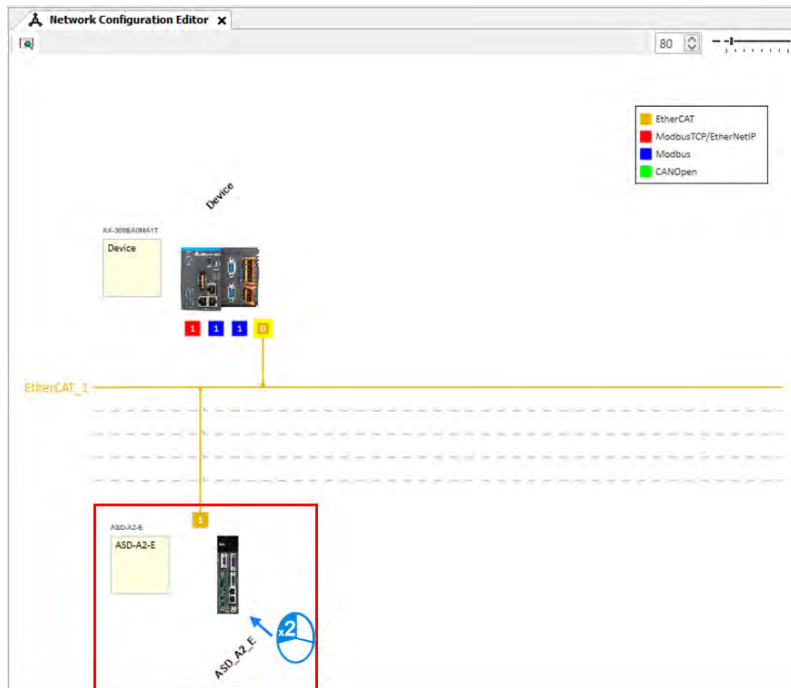

- Tabs relating to slave device configuration will be displayed after double-clicking, such as Station address setting, "Process Data" and "Startup Parameters".

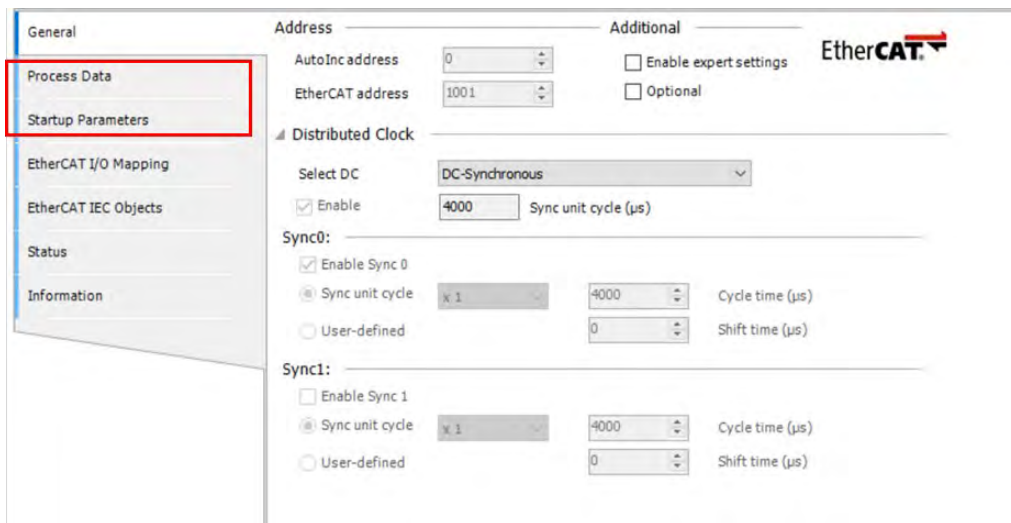

- Afterwards, you can start writing programs with motion function blocks in POU, which should be placed under “EtherCAT+Task”, to ensure normal operation of function blocks.

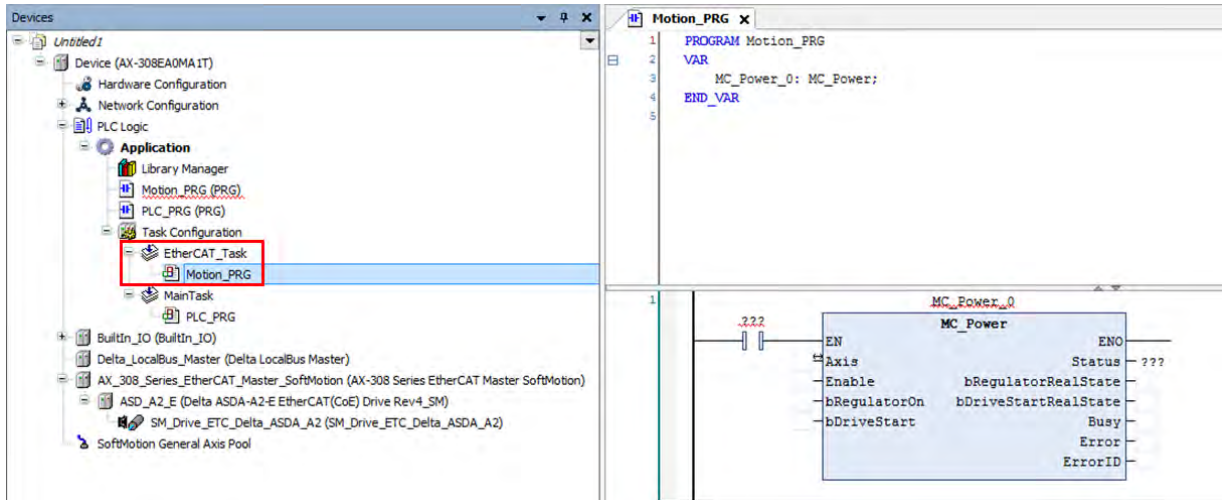

7.3 Commissioning

7.3.1 Procedure for Commissioning

The chart below shows the steps to build a commissioning process:

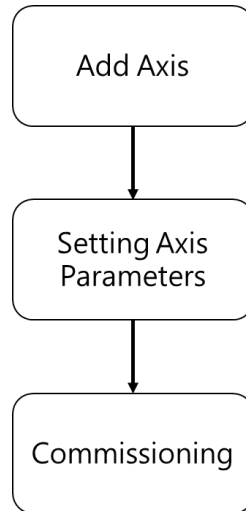

7.3.2 Example of Axis Parameter Settings

Before using software to perform commissioning, axis parameters must be set first. The figure below illustrates the setting method.

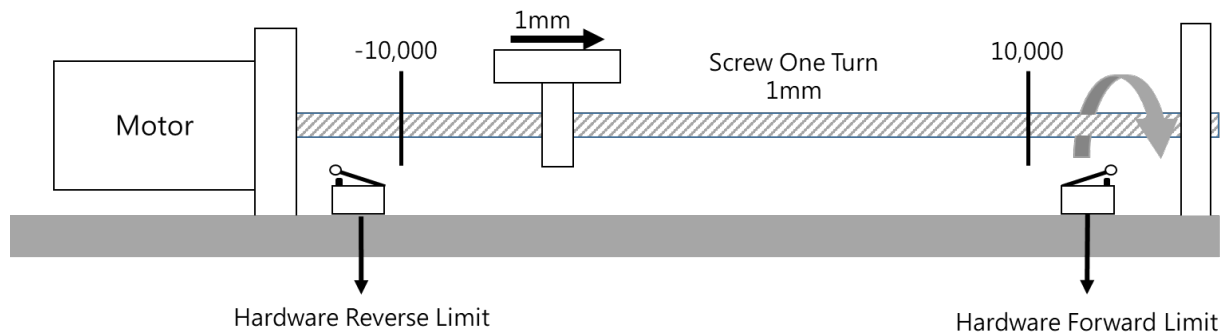

● Axis configuration screen

Axis Type and Limits

Virtual mode

Linear Axis

Rotary Axis

Linear Axis Software Limits

Activated

Negative [u]: -10000

Positive [u]: 10000

Rotary Axis Modulo Setting

Modulo value [u]: 360

Motion Parameter

Error Reaction

Quick Stop Deceleration [u/s²]: 100

Velocity Ramp Type

Trapezoid Sin² Quadratic Quadratic(smooth)

Position Lag Supervision

Position Lag Reaction: Deactivated Lag Limit [u]: 1

Transmission Mechanism

Mechanism Type: Ball Screw

Mechanism Setting

(1) Command pulse per motor rotation: 10000 [Pulse]

(4) Pitch: 1 [Unit]

Gear Box

Gear Ratio = $\frac{(2) \text{ Gear ratio numerator } 1}{(3) \text{ Gear ratio denominator } 1}$

● Parameters setting

Name	Setting
Axis Type①	Linear Axis
Command pulse per motor rotation③	10,000
Pitch③ [Unit]	1*1
Gear ratio denominator	128*2
Gear ratio numerator	1*2
Software limit_Posotive②	10,000
Software limit_Negative②	-10,000

***Note:**

1. In case of the Unit [mm], the input parameter should be 0.001 for moving 1um.
2. It's a must to set P1-44 and P1-45 of the servo drive.

7.3.3 Perform Axes Commissioning

- Select “EtherCAT_Master_SoftMotion” and double-click on it.

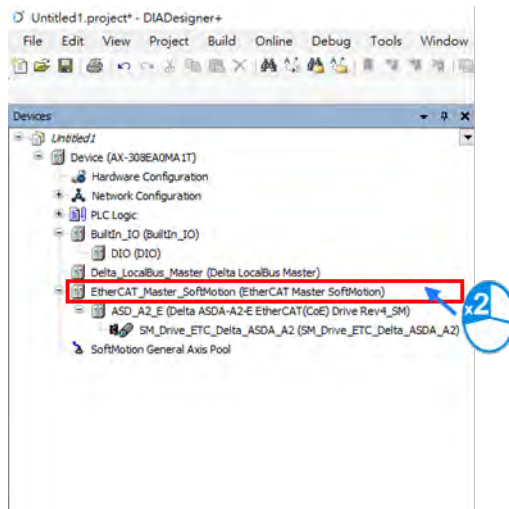

- Left click on the “Online Config Mode” icon.

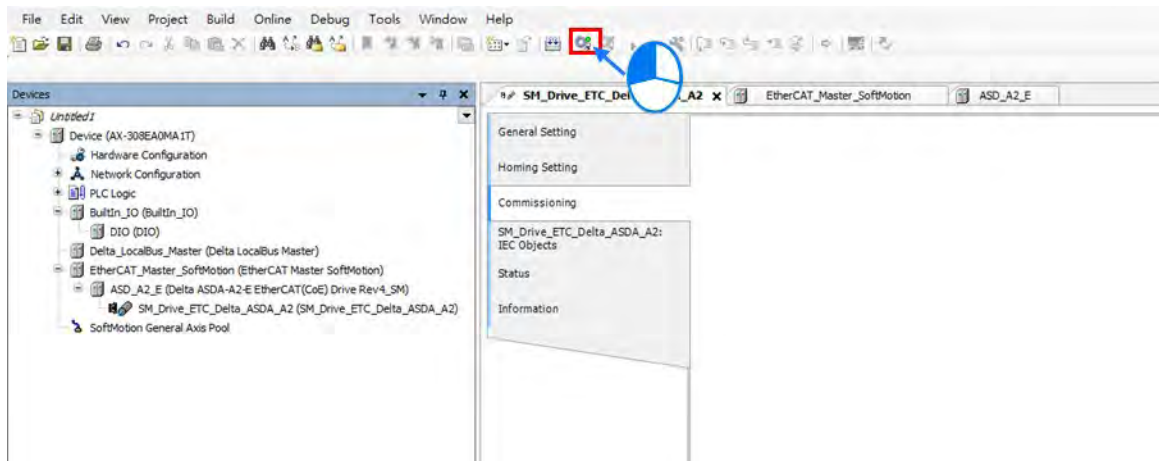

- After entering online commissioning, double-click on “SM_Drive_ETC_Delta_ASDA_A2”

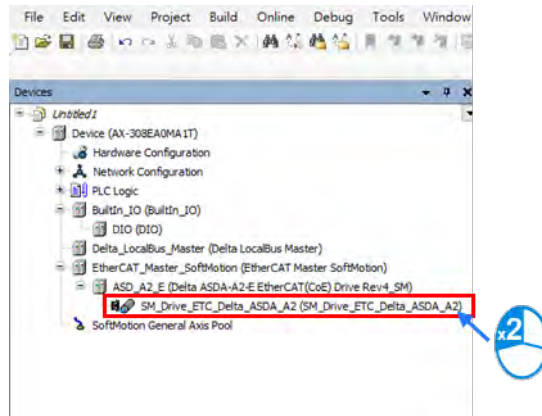

- Open “Commissioning” tab after entering the setting screen of axis parameters.

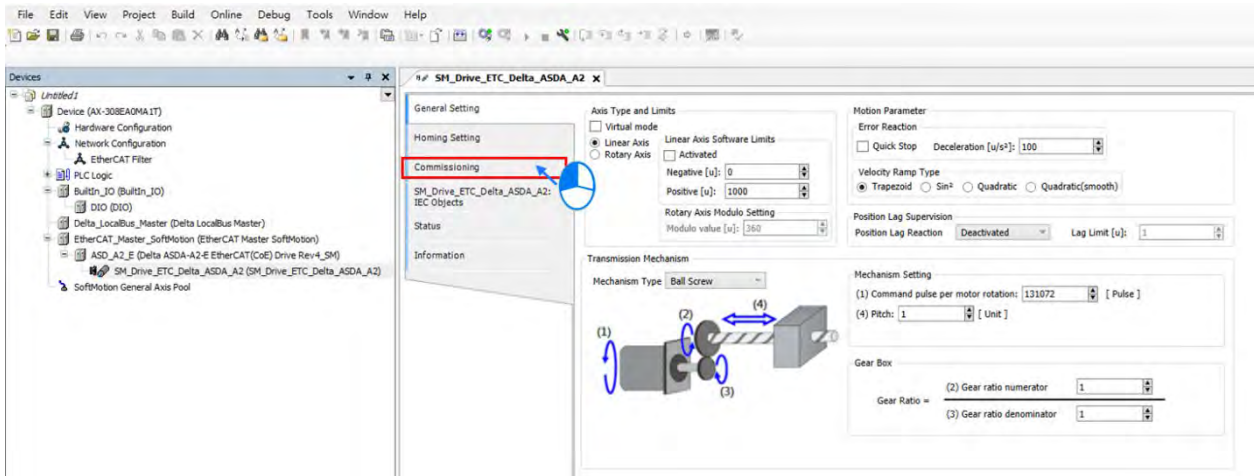

- Introduction of commissioning screen

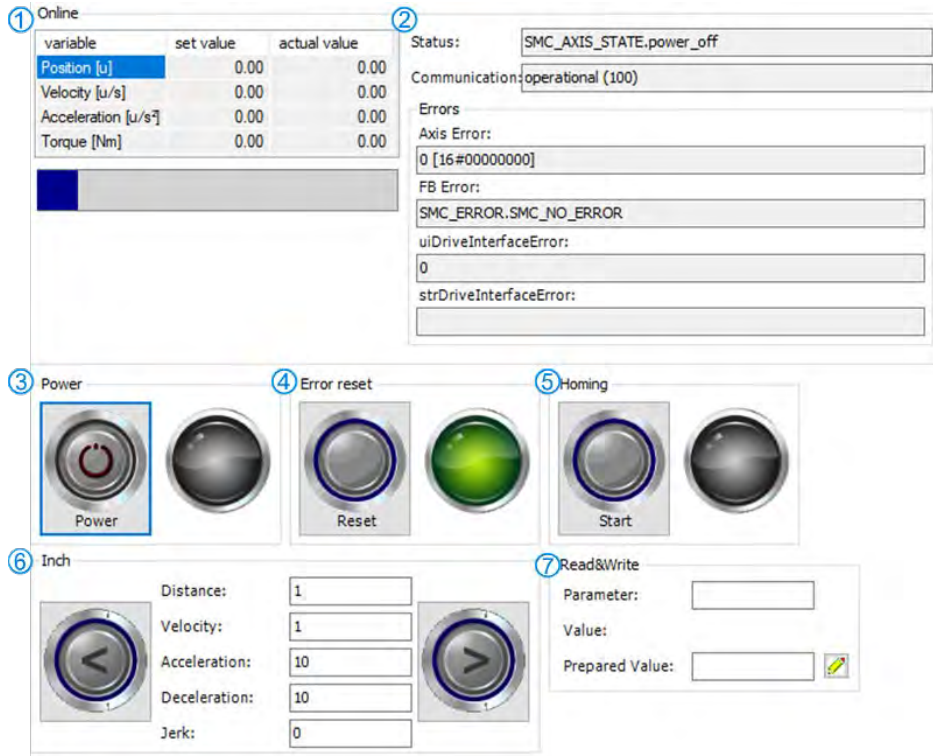

- ① Information of axis commands

Name	Function
Position[u]	Command position and actual position
Velocity[u/s]	Command value and actual value of velocity
Acceleration[u/s ²]	Command value and actual value of acceleration
Torque[Nm]	Command value and actual value of torque

■ ② Axis status and communication status

Name	Function
Status	Axis status
Communication	Communication status

- ③ Axis power: Set power ON/ OFF.
- ④ Error reset: Clear error messages of servo axis.
- ⑤ Homing: Make the axis back to the start position.
- ⑥ Inch

Name	Function
Distance	Moving distance
Velocity	Moving velocity
Acceleration	Acceleration rate
Deceleration	Deceleration rate
Jerk	Command value of jerk

■ ⑦ Read&Write: Read-write parameters of upper axes. If need be, you can read and modify Object Dictionary by inputting as follows.

- Read and write the parameter 0x6098 in object dictionary

16#1609800

1 = fixed number

6098 =the parameter to be read and written

00 = sub of the parameter

1. Convert 0x1609800 to demical number as 23,107,584
2. Change 23,107,584 to -23,107,584
3. Enter -23,107,584 in the "Parameter" field to read the parameter "0x6098".

7.4 Motion Control Device

7.4.1 Overview

Motion control devices are mainly used for configuring parameters for motion axis. In most applications, you can set up axis parameters in DIADesigner-AX software, a convenient environment for you, where axis parameters required for configuring motion control on axis are defined as Structure. A Structure is a data type applicable to group the data elements together.

7.4.2 Introduction to Axis

The axis is used to perform motion control in the system and includes real servo drives, encoders and virtual servo drives. The following table shows the axis types:

Type	Description
Positioning axis ^{*1}	Achieve basic positioning control via EtherCAT, such as functions of absolute positioning, relative positioning, and etc.
Velocity axis ^{*1}	Achieve velocity control and torque control. (as seen in CIA 402 Velocity Mode)
Synchronous axis ^{*2}	Achieve servo motor control and basic positioning control via EtherCAT, as well as synchronous motion control like electronic cam function.
Pulse-type axis	Achieve real servo motor control with pulses.
Virtual axis	Execute motion control commands without using real servo motor.
Encoder axis	Use real encoder (SSI or incremental encoder) as feedback signals.
Virtual encoder axis	Can only be used in the program without encoders.

***Note 1:**

- Positioning and velocity axes must match the function library of DL_MotionControlLight.
- When AX-364EL uses Ethercat with the number of axes exceeding 64 and the Soft Motion version is below V4.7.0.0, the parameters of MAX_MAILBOX_CHANNELS and MAX_SDO_Channels in the Library (IODrvEtherCat → ETC_Parameter) must be changed to 128.

***Note 2:** Synchronous axes must match DL_MotionControl and the function library of SM3_Basic.

7.4.2.1 About Axis Parameters

After creating a servo axis, the corresponding axis parameters will be generated as well. The following table details the relating description.

- Synchronous Axis

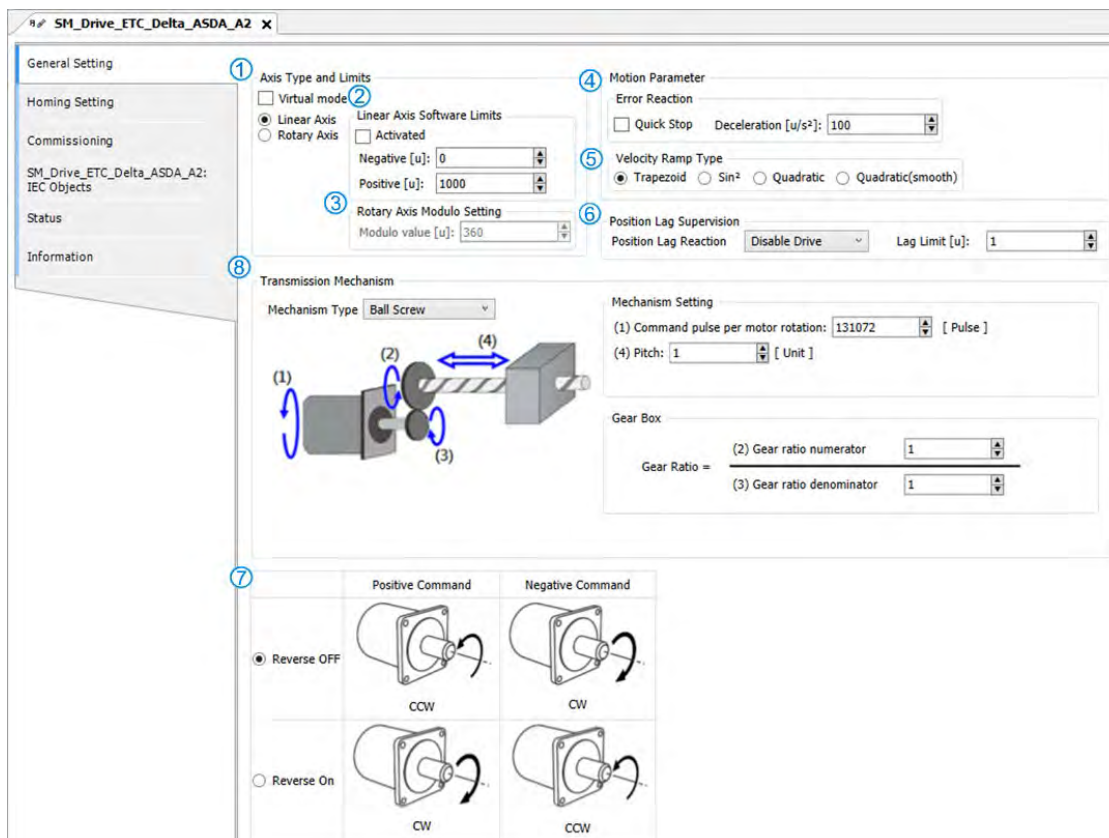

① Axis Type and Limits

Name	Function
Virtual	Activate virtual axes.
Linear Axis / Rotary Axis	Set to be linear axis or rotary axis.

② Linear Axis Software Limits

Name	Function
Activated	Activate software limits (only supports Linear axis)
Negative[u]	Reverse software limit.
Positive[u]	Forward software limit.

③ Rotary Axis Modulo Setting

Name	Function
Modulo Value[u]	Set the area of rotation for a turn. (only supports rotary axes)

④ Error Reaction

Name	Function
Quick Stop	Emergency stop for axes
Deceleration[u/s ²]	Deceleration stop for axes (effective when Quick Stop is inactive)

⑤ Velocity Ramp Type

Name	Function
Trapezoid/Sin2/Quadratic/ Quadratic(Smooth)	Motion curves setting for axes

⑥ Position Lag Supervision

Name	Function
Positon Lag Reaction	Set the reaction for position lag.
Lag Limit [u]	Set the value of lag limit.

⑦ Positive / Negative Command

Name	Function
Reverse OFF / ON	Enable or disable reverse function for positive/negative command setting.

⑧ Transmission Mechanism

◆ Servo Gear Ratio Setting

Name	Function
Unit Numerator	Numerator factor of the electronic gear unit
Unit Denominator	Denominator factor of the electronic gear unit

Descriptions of different machanism types are as follows:

◆ Ball Screw

Transmission Mechanism

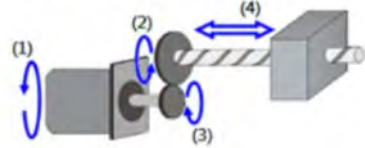

Mechanism Type: Ball Screw

Mechanism Setting

(1) Command pulse per motor rotation: [Pulse]

(4) Pitch: [Unit]

Gear Box

Gear Ratio = $\frac{(2) \text{ Gear ratio numerator } \input{type="text" value="1"}{(3) \text{ Gear ratio denominator } \input{type="text" value="1"}}$

Name	Function
(1) Command Pulse per motor rotation	The command pulse value for per motor rotation
(4) Pitch	The distance between screw threads
(2) Gear ratio numerator	Numerator of gear ratio
(3) Gear ratio denominator	Denominator of gear ratio

◆ Round Table

Transmission Mechanism

Mechanism Type: Round Table

Mechanism Setting

(1) Command pulse per motor rotation: 1 [Pulse]

(4) Movement distance per motor rotation: 1 [Unit]

Gear Box

Gear Ratio = $\frac{(2) \text{ Gear ratio numerator } 1}{(3) \text{ Gear ratio denominator } 1}$

Name	Function
(1) Command Pulse per motor rotation	The command pulse value for per motor rotation
(4) Movement distance per motor rotation	Movement distance for one full motor rotation
(2) Gear ratio numerator	Numerator of gear ratio
(3) Gear ratio denominator	Denominator of gear ratio

◆ Belt Pully

Transmission Mechanism

Mechanism Type: Belt Pully

Mechanism Setting

(1) Command pulse per motor rotation: 1 [Pulse]

(4) Diameter: 1 [Unit]

Movement distance per motor rotation: Diameter * n

Gear Box

Gear Ratio = $\frac{(2) \text{ Gear ratio numerator } 1}{(3) \text{ Gear ratio denominator } 1}$

Name	Function
(1) Command Pulse per motor rotation	The command pulse value for per motor rotation
(4) Diameter* (Movement distance per motor rotation: Diameter X π)	Diameter (Movement distance per motor rotation: Diameter X π)
(2) Gear ratio numerator	Numerator of gear ratio
(3) Gear ratio denominator	Denominator of gear ratio

Note:

For DIADesigner-AX V1.3 or previous versions, the measured diameter should multiply π .

For DIADesigner-AX V1.4 or later versions, the result of diameter is already multiplied π automatically.

⑨ Homing Setting

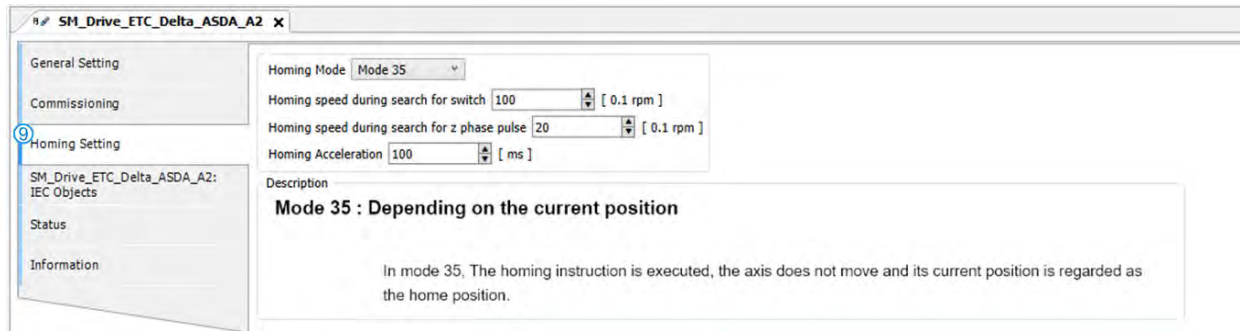

Name	Function
Homing Mode	Configure homing mode setting.
Homing Speed during search for switch	Set the homing speed during search for switch.
Homing Speed during search for z phase pulse	Set the homing speed during search for Z phase pulse.
Homing Acceleration	Set the homing acceleration rate.

● Positioning Axis

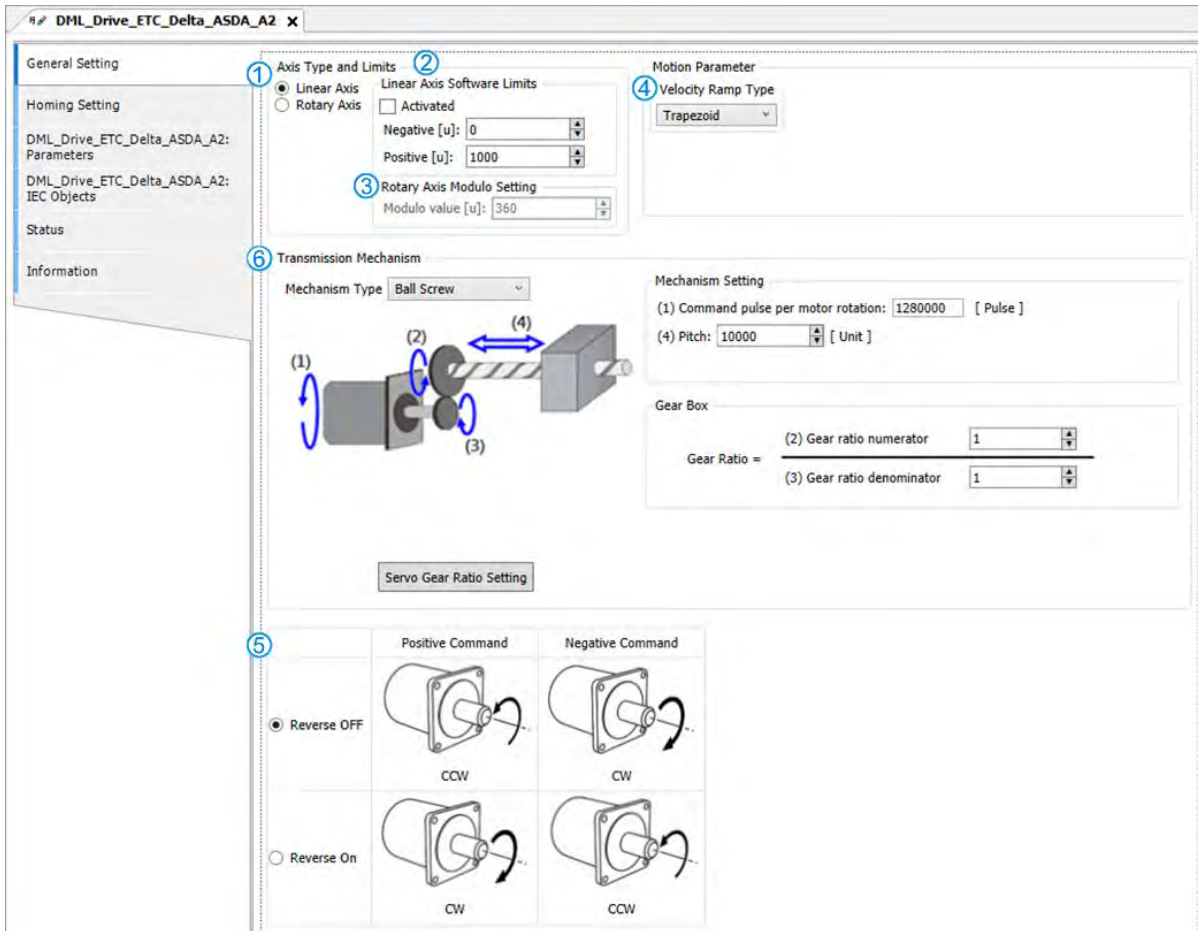

① Axis Type and Limits

Name	Function
Linear Axis / Rotary Axis	Set to be linear axis or rotary axis.

② Linear Axis Software Limits

Name	Function
Activated	Activate software limits (only supports Linear axis)
Negative[u]	Reverse software limit.
Positive[u]	Forward software limit.

③ Rotary Axis Modulo Setting

Name	Function
Modulo Value[u]	Set the area of rotation for a turn. (only supports rotary axes)

④ Velocity Ramp Type

Name	Function
Trapezoid/Sin2	Motion curves setting for axes

⑤ Positive / Negative Command

Name	Function
Reverse OFF / On	Enable or disable reverse function for positive/negative command setting.

⑥ Transmission Mechanism

◆ Servo Gear Ratio Setting

Name	Function
Unit Numerator	Numerator factor of the electronic gear unit
Unit Denominator	Denominator factor of the electronic gear unit

Descriptions of different mechanism types are as follows:

◆ Ball Screw

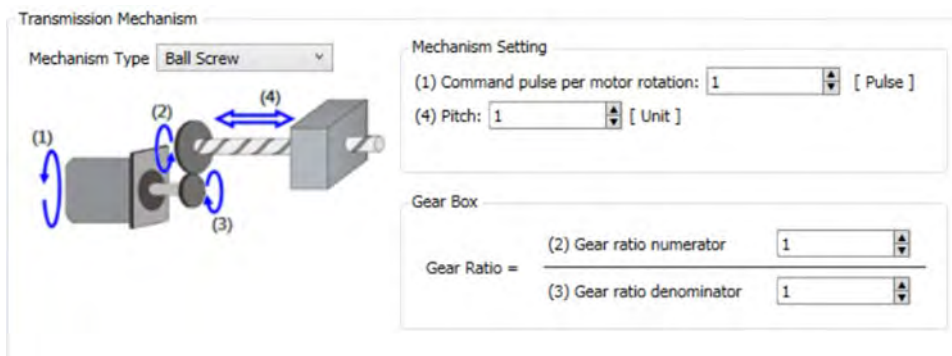

Name	Function
(4) Command Pulse per motor rotation	The command pulse value for per motor rotation
(4) Pitch	The distance between screw threads
(5) Gear ratio numerator	Numerator of gear ratio
(6) Gear ratio denominator	Denominator of gear ratio

◆ Round Table

Transmission Mechanism

Mechanism Type Round Table

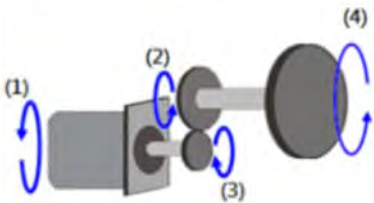

Mechanism Setting

(1) Command pulse per motor rotation: [Pulse]

(4) Movement distance per motor rotation: [Unit]

Gear Box

Gear Ratio = $\frac{(2) \text{ Gear ratio numerator } \text{ }}{(3) \text{ Gear ratio denominator } \text{ }}$

Name	Function
(1) Command Pulse per motor rotation	The command pulse value for per motor rotation
(4) Movement distance per motor rotation	Movement distance for one full motor rotation
(5) Gear ratio numerator	Numerator of gear ratio
(6) Gear ratio denominator	Denominator of gear ratio

◆ Belt Pully

Transmission Mechanism

Mechanism Type Belt Pully

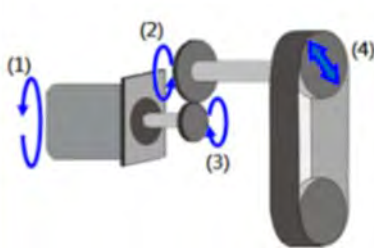

Mechanism Setting

(1) Command pulse per motor rotation: [Pulse]

(4) Diameter: [Unit]

Movement distance per motor rotation: Diameter * π

Gear Box

Gear Ratio = $\frac{(2) \text{ Gear ratio numerator } \text{ }}{(3) \text{ Gear ratio denominator } \text{ }}$

Name	Function
(4) Command Pulse per motor rotation	The command pulse value for per motor rotation
(4) Diameter (Movement distance motor rotation : Diameter X π)	Diameter (Movement distance per motor rotation: Diameter X π)
(5) Gear ratio numerator	Numerator of gear ratio
(6) Gear ratio denominator	Denominator of gear ratio

Note:

For DIADesigner-AX V1.3 or previous versions, the measured diameter should multiply π.

For DIADesigner-AX V1.4 or later versions, the result of diameter is already multiplied π automatically.

⑦ Homing Setting

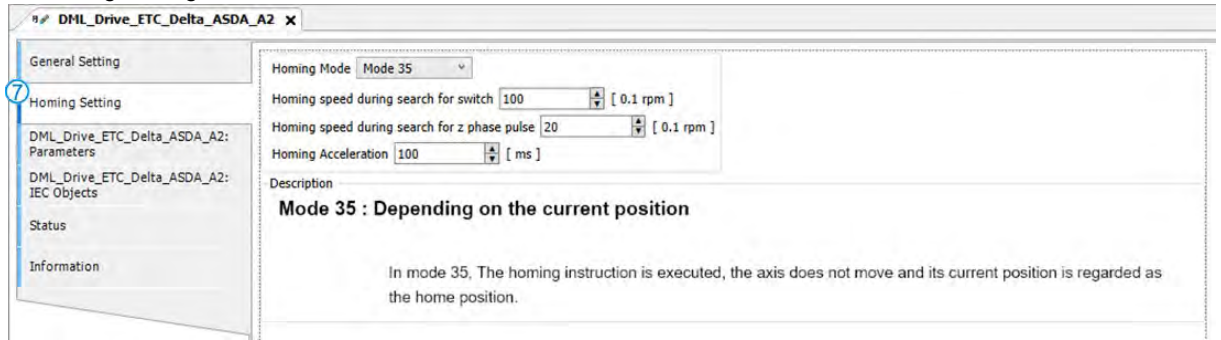

DML Drive ETC Delta ASDA A2

General Setting

Homing Setting

DML Drive ETC Delta ASDA A2: Parameters

DML Drive ETC Delta ASDA A2: IEC Objects

Status

Information

Homing Mode Mode 35

Homing speed during search for switch 100 [0.1 rpm]

Homing speed during search for z phase pulse 20 [0.1 rpm]

Homing Acceleration 100 [ms]

Description

Mode 35 : Depending on the current position

In mode 35, The homing instruction is executed, the axis does not move and its current position is regarded as the home position.

Name	Function
Homing Mode	Configure homing mode setting.
Homing Speed during search for switch	Set the homing speed during search for switch.
Homing Speed during search for z phase pulse	Set the homing speed during search for Z phase pulse.
Homing Acceleration	Set the homing acceleration rate.

7.4.2.2 Axis Application in Program

After a servo axis is newly added in the project, the name of servo axis will be generated automatically (you are allowed to change the name) and input to the function block.

- **Synchronous Axis**

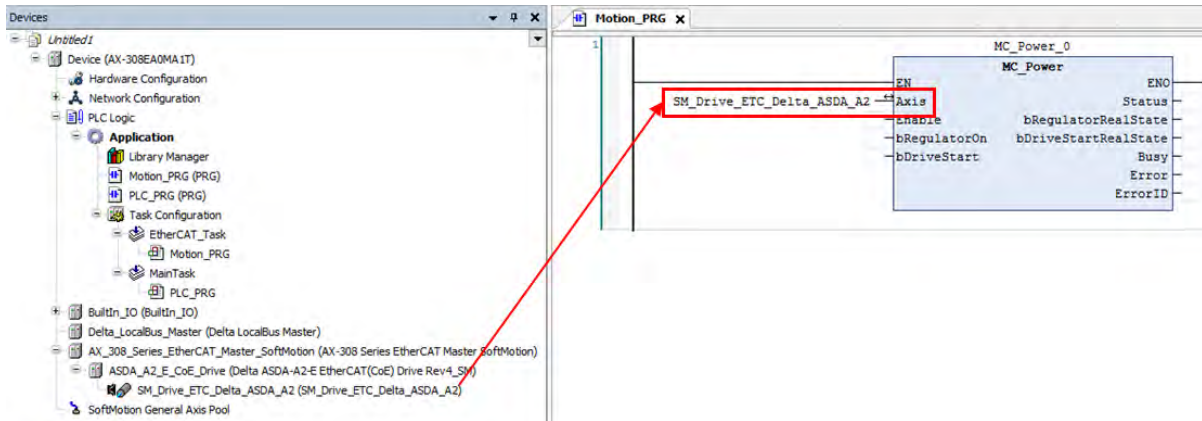

- **Positioning Axis**

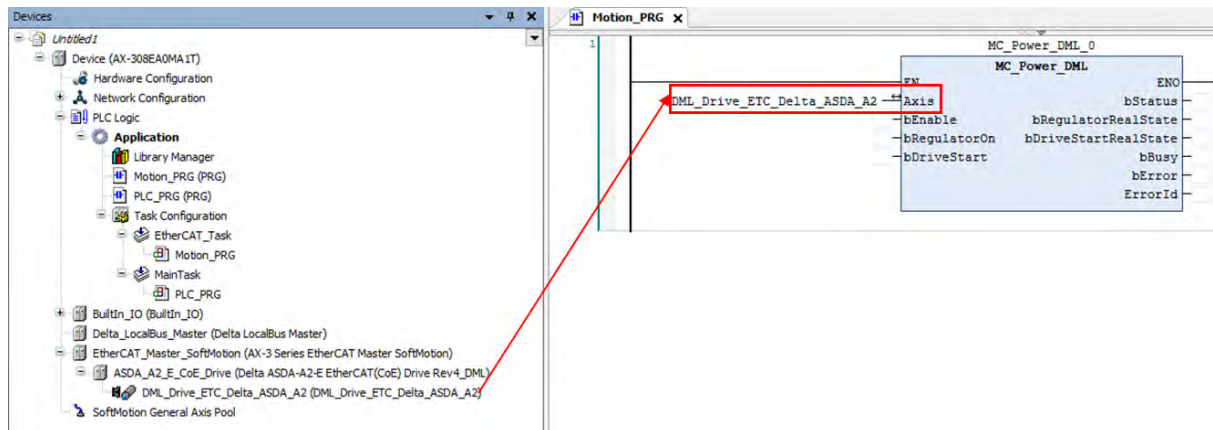

7.4.3 Procedure for Single-axis Configuration

- The procedure for axis settings is shown as follows. For more details of creating new projects, please find section 7.2.

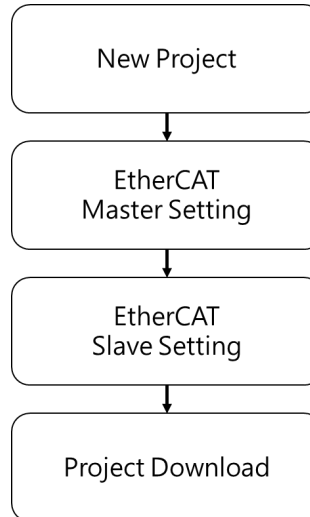

- Configure EtherCAT settings after opening the project. First, click “Network Configuration”.

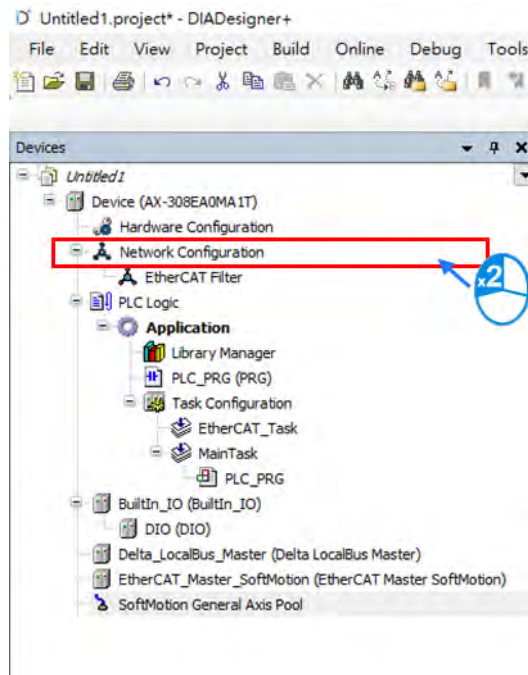

- Click "Delta ASDA-A2-E EtherCAT(CoE) Drive Rev4_SM" *1 after entering Network Configuration page and connect ① to the line above.

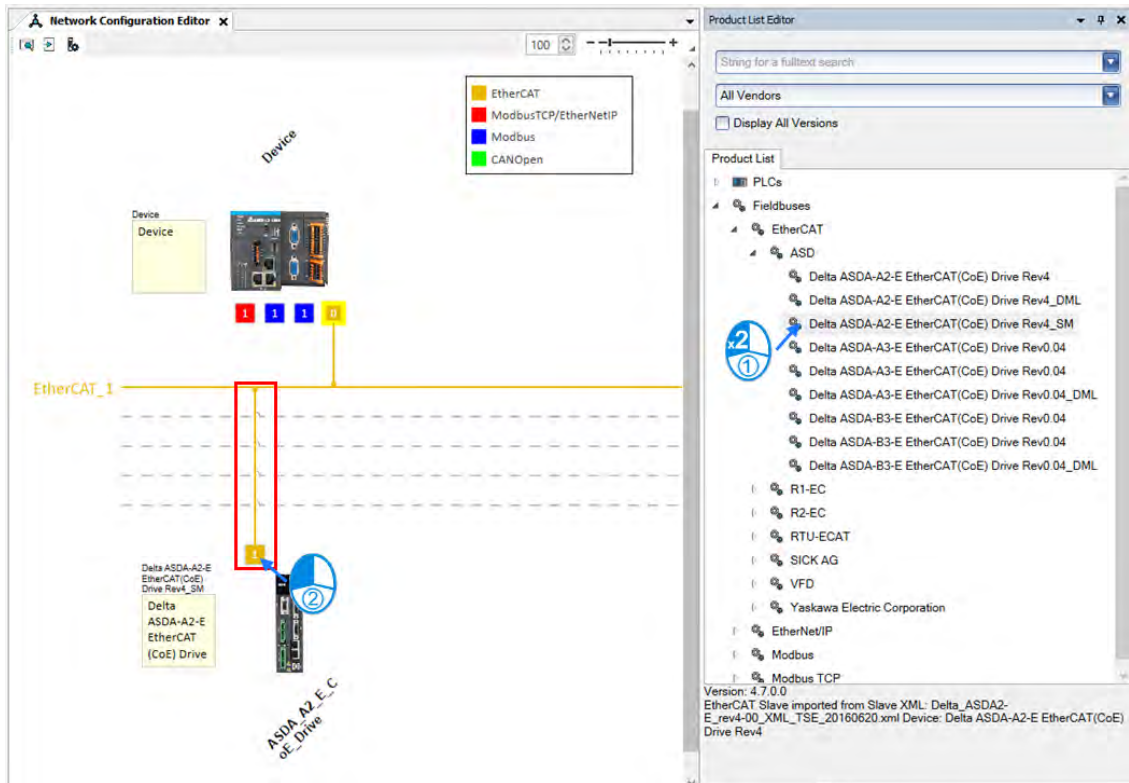

Note 1: *1 Delta ASDA-A2-E EtherCAT(CoE) Drive Rev4_SM is a synchronous axis. If a positioning axis is what you need, select Delta ASDA-A2-E EtherCAT(CoE) Drive Rev4_DML instead. After that, the operational procedures are the same for the synchronous axis and positioning axis.

- Double-click on the slave device after finishing the connection.

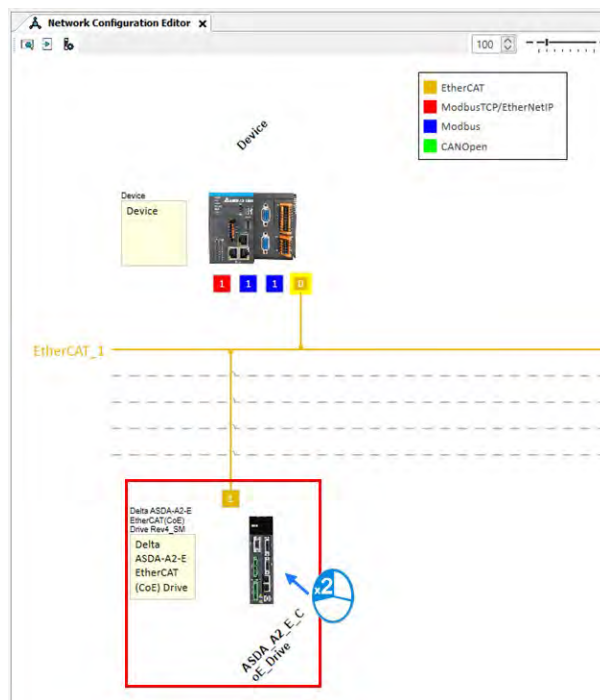

- Switch to “Process Data” page to configure mapping groups of PDO. The default setting for ASDA-A2 is second group, which can operate normally with most function blocks. If additional groups or parameters of PDO need to be selected and added, please refer to content concerning function blocks description in **AX Series Motion Controller Manual**.

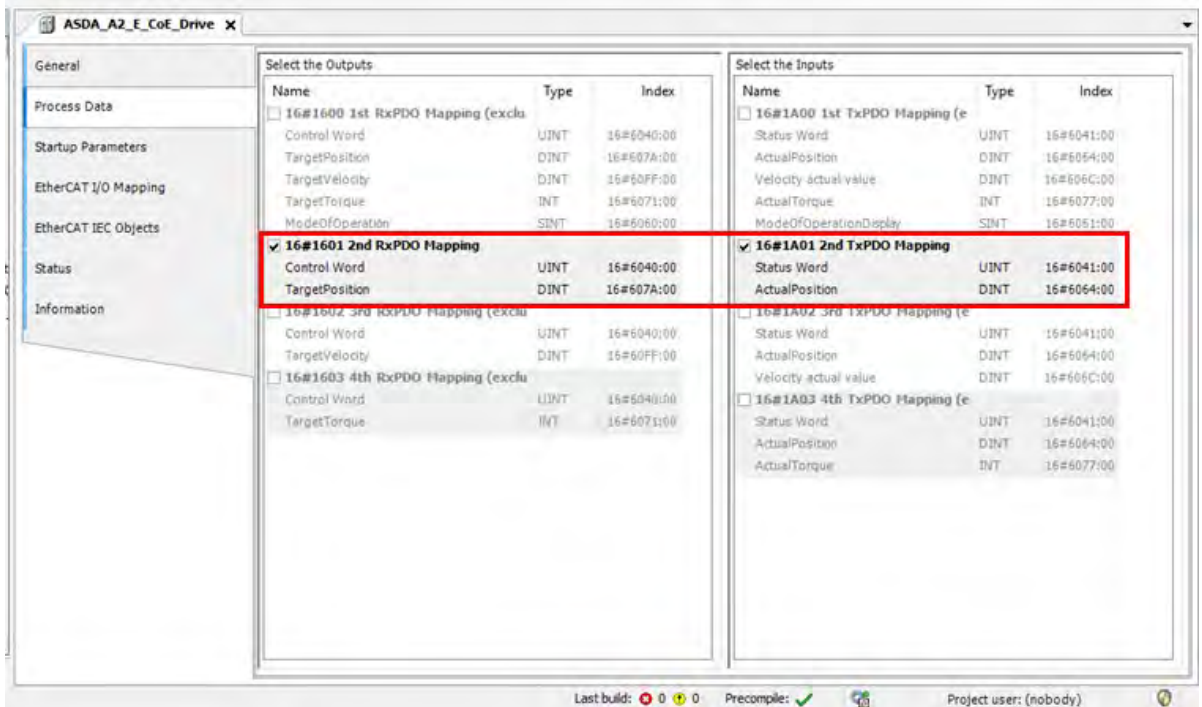

- Initialize EtherCAT communication**

After initialization is completed, you need to input fixed values for the required Object Dictionary which can be configured on “Startup Parameters” page.

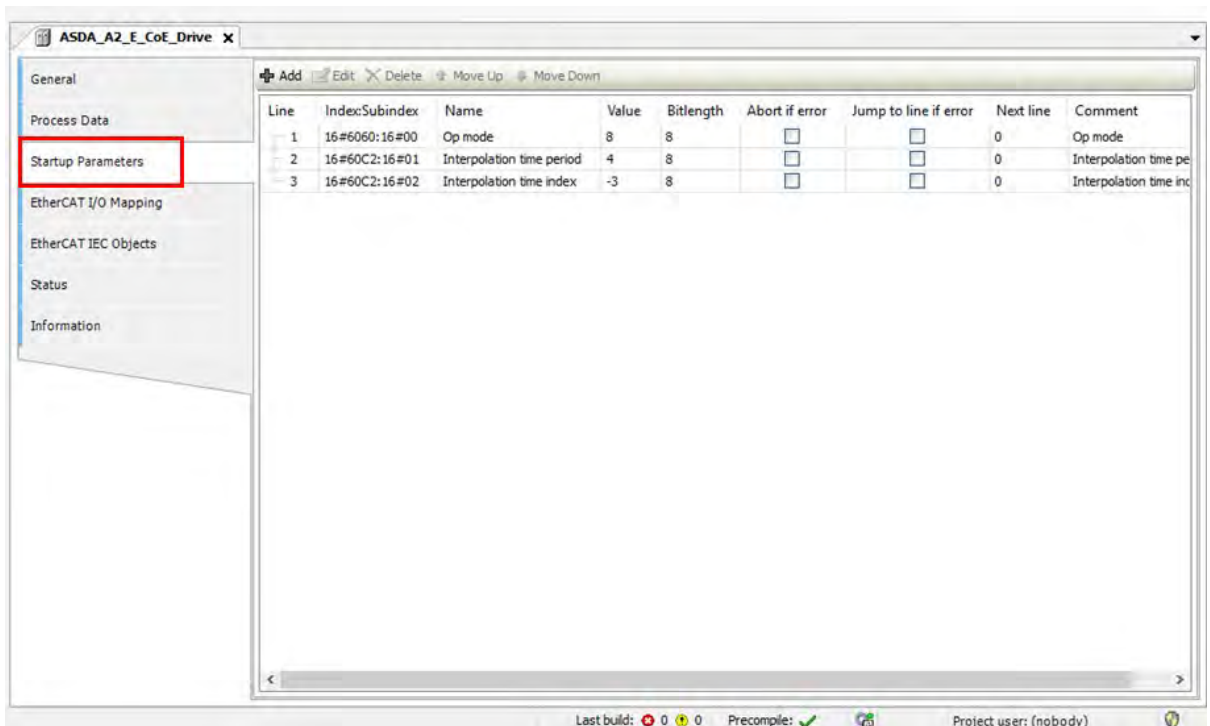

- After finishing the settings of axis communication, double-click on “SM_Drive_ETC_Delta_ASDA_A2”.

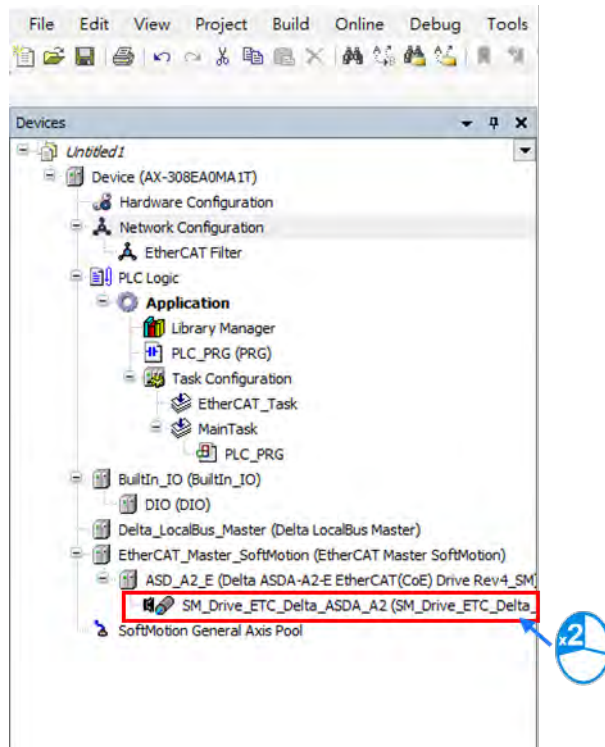

- Axis settings page

Options of axis type: “Rotary Axis” and “Linear Axis”

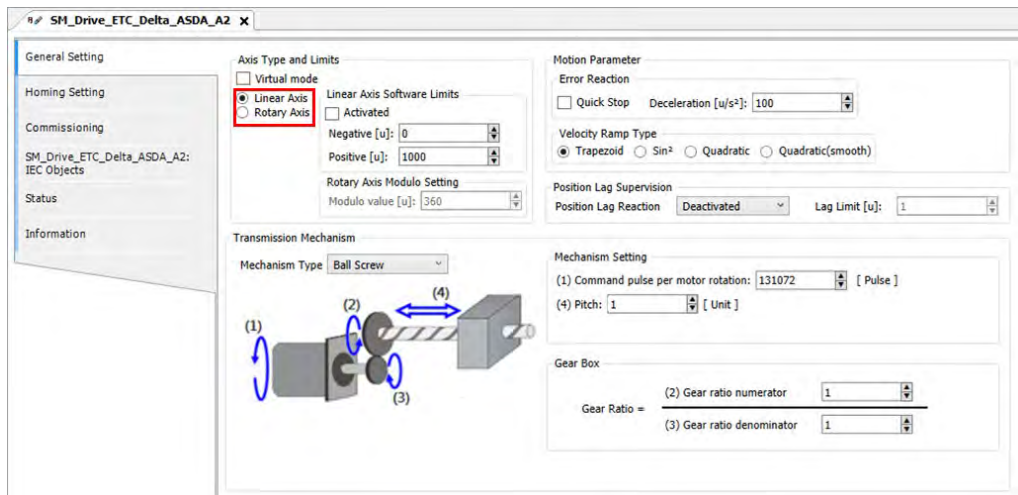

- Setup Software Limits for linear axis. Click Activated to start software limit that contains negative limits (“Negative”) and positive limits (“Positive”).

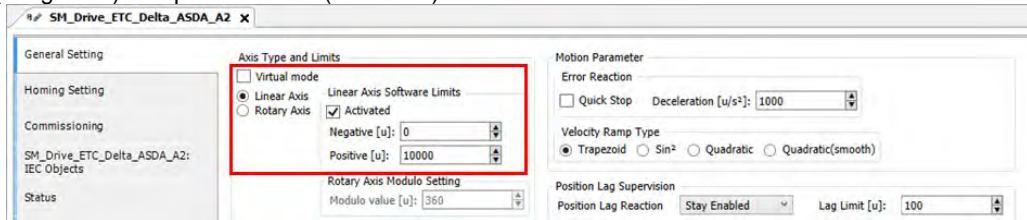

- The rotation range must be defined after finishing rotary axis settings. Please setup “Modulo value” IN “Modulo settings”.

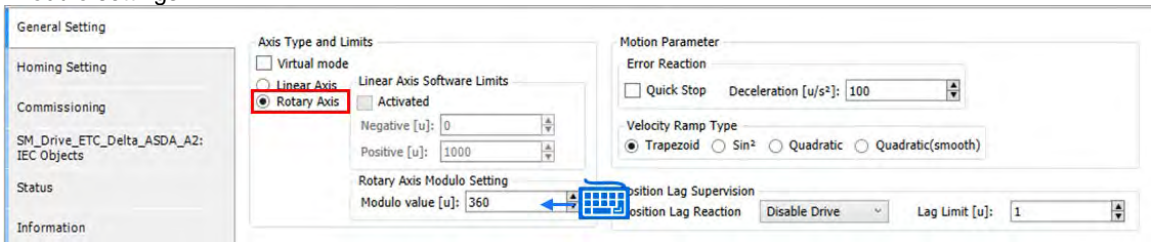

- Scaling/ Mapping page

Set the pulse value for “Command pulse per motor rotation”. Set the movement distance within one full motor rotation for “Pitch”.

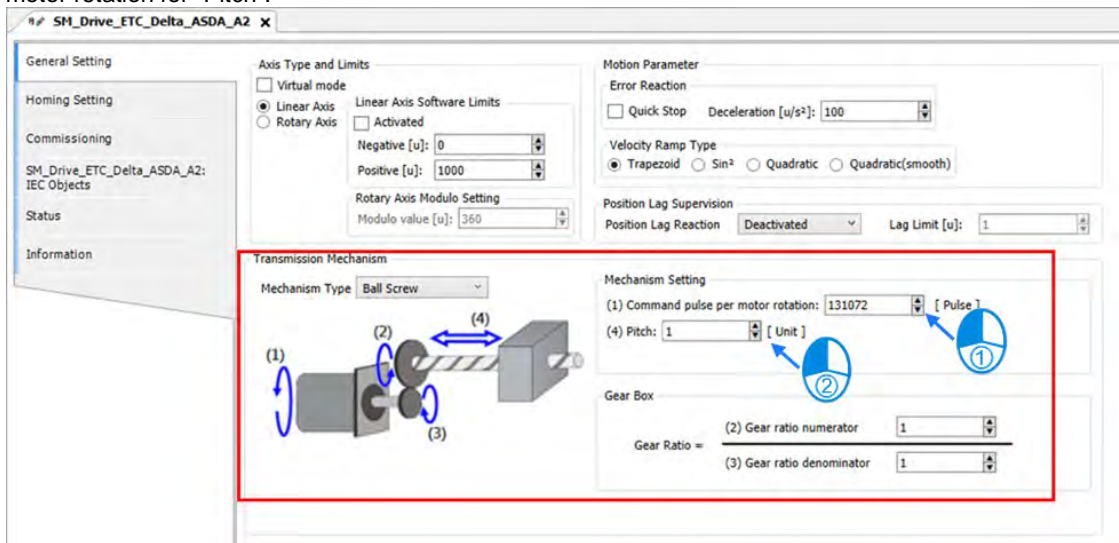

- To configure the communication cycle time of Ethernet, click “EtherCAT_Master_SoftMotion”, then set the value of “Cycle time” as 2000 and “Sync offset” as 50.

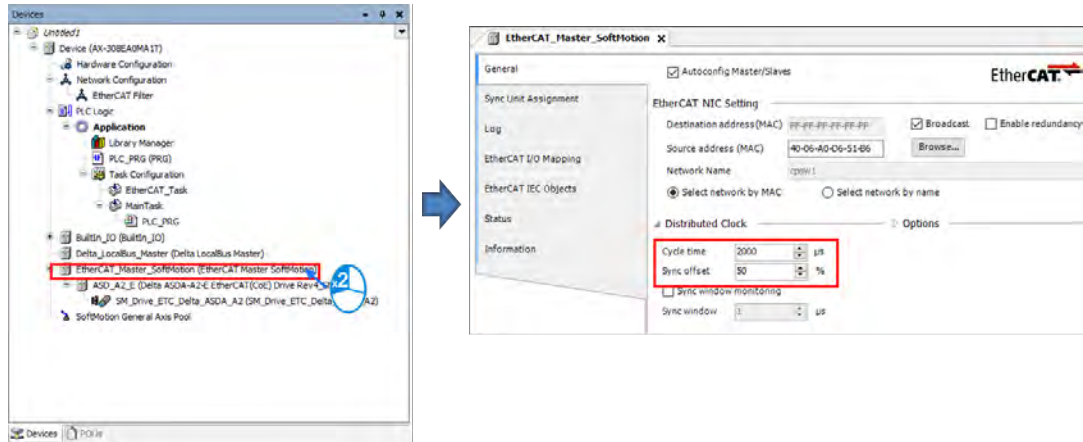

- Scan PLC controller

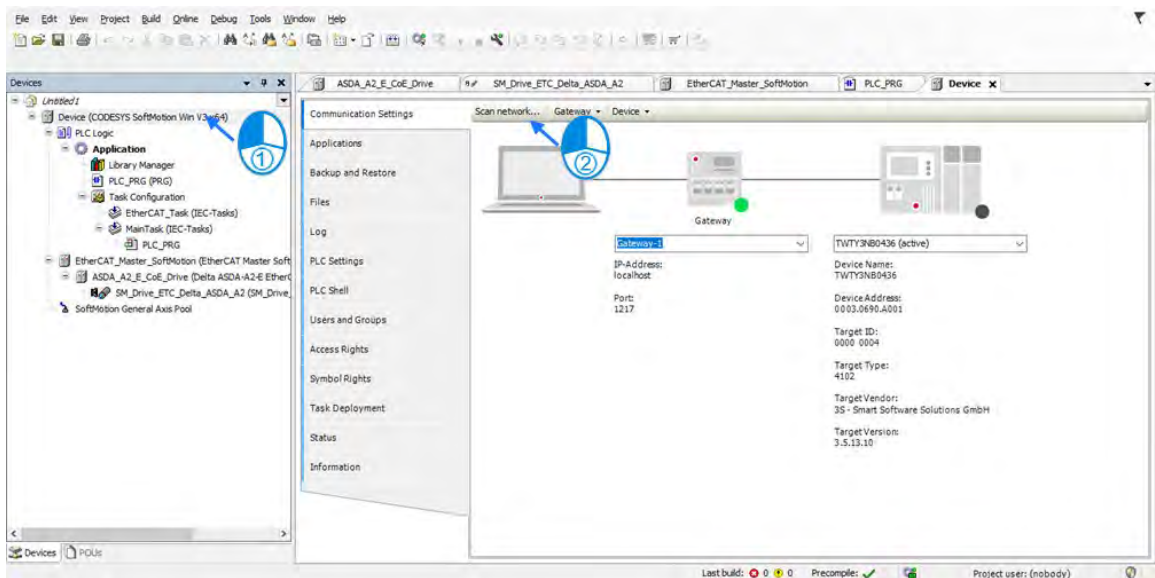

- Add the newly scanned PLC controller and click “OK”.

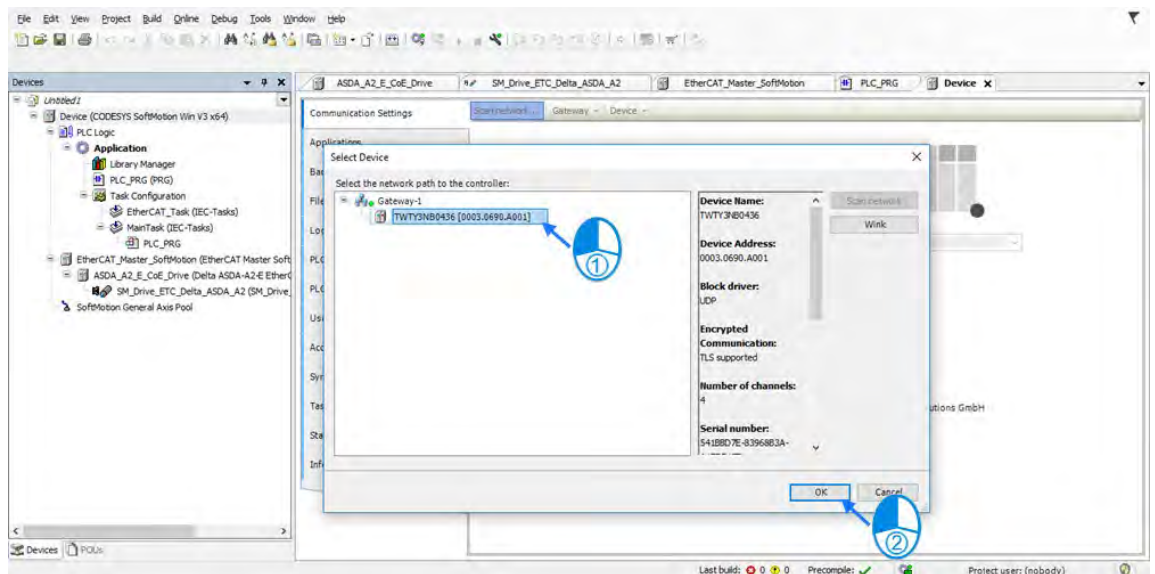

- A green light icon will be shown if the connection is successful, then click “Login”.

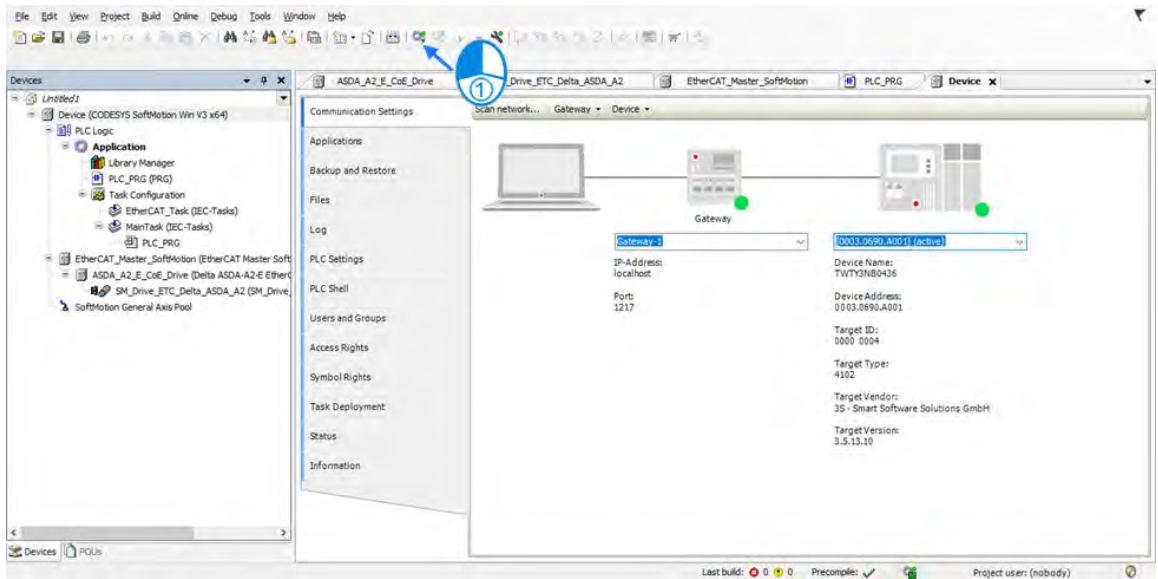

- A prompt box will pop out to remind you if you want to perform a download, click “Yes” to continue.

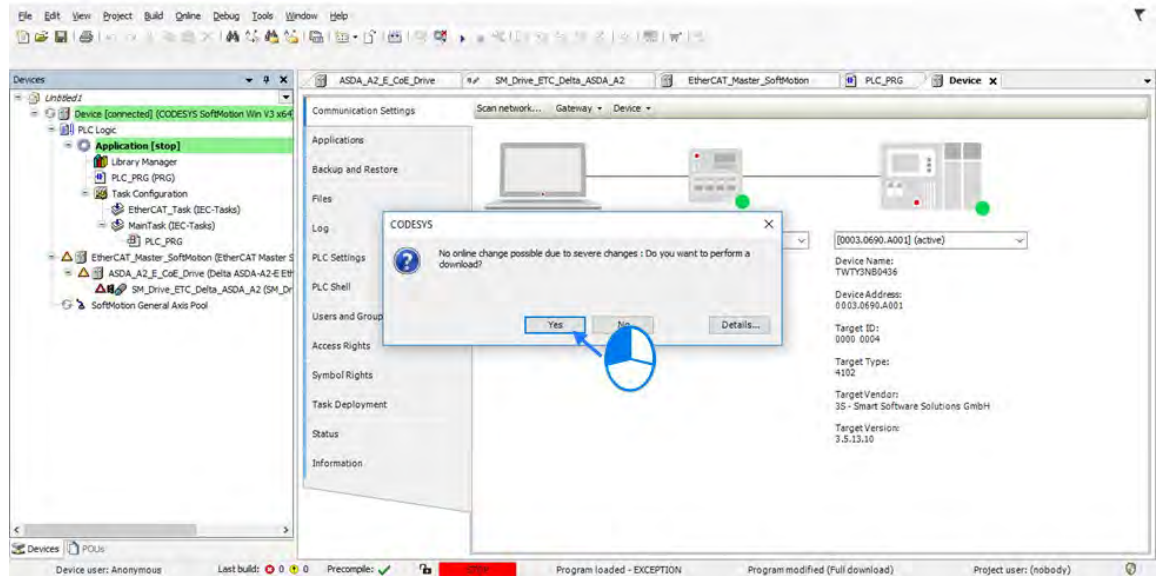

7.4.4 Axis Group Settings

Axis group movement will be functioned when executes linear interpolation and circular interpolation with multiple axes. DIADesigner-AX is required for grouping axes.

Maximum controll axes	Linear interpolation	6 axes
	Circular interpolation	6 axes (3 follower axes)

7.4.4.1 Prameters for Axis Group

The parameters used for axis group movement are as follows.

DeltaAxisGroup

1 Kinematic

Configuration

Axis X: ...

Axis Y: ...

Axis Z: ...

Axis A: ...

Axis B: ...

Axis C: ...

Note

$$\text{Following Ratio} = \frac{\text{Target Position of Following Axis}}{\text{Target Position of Axis Group}}$$

2 Motion Parameter

RampType:

Max Velocity Limit: (user unit)/s

Max Acceleration Limit: (user unit)/s²

Max Deceleration Limit: (user unit)/s²

Max Jerk Limit (Reserved): (user unit)/s³

3 Tasks

Bus Task: ...

① Kinematic

Name	Function
Axis X ^{*1}	X axis in axis group
Axis Y ^{*1}	Y axis in axis group
Axis Z ^{*1}	Z axis in axis group
Axis A ^{*1}	A axis in axis group
Axis B ^{*1}	B axis in axis group
Axis C ^{*1}	C axis in axis group

② Motion Parameter

Name	Function
Ramp Type*2	Velocity ramp type
Max Velocity Limit*3	The max velocity of axis group
Max Acceleration Limit*3	The max acceleration of axis group
Max Deceleration Limit*3	The max deceleration of axis group
Max Jerk Limit(Reserved)*3	The max jerk rate of axis group (Reserved)

③ Tasks

Name	Function
Bus Task	Configure the updating task for axis groups.

Note 1: Axis X ~ Axis C: Enter the names of axes individually.

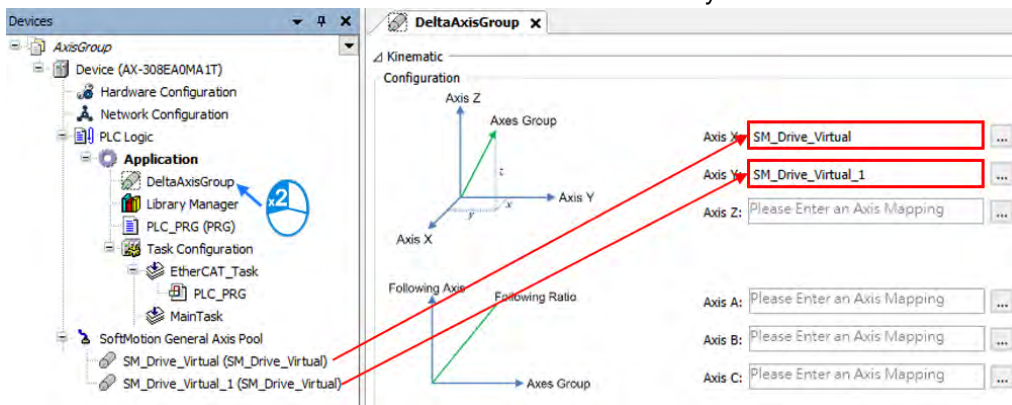

Note 2: There are two Ramp Type: Trapezoid and S-curve type, which are shown in the following figures.

■ Trapezoid

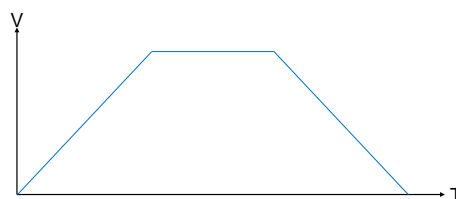

■ S Curve

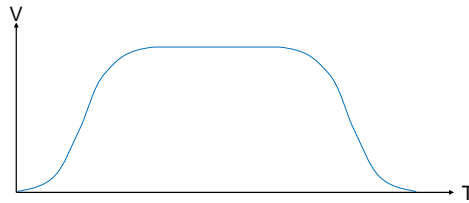

Note 3:

- Max Velocity Limit : An error occurs when the velocity exceeds the setting value.
- Max Acceleration Limit : An error occurs when the acceleration exceeds the setting value.
- Max Deceleration Limit : An error occurs when the deceleration exceeds the setting value.

7.4.4.2 Using Axis Groups in Program

To follow the procedure, you must add the node of axis group to the project tree and names the required axis in the group individually before using the AxisGroup function block. After finishes the settings, please connect the node of axis group to AxisGroup input of each function block.

7.4.5 Procedure for Axis Group Configuration

- To use the axis group movement function, you must name the axis group and set the corresponding individual axes with DIADesigner-AX. The process flowchart of creating axis groups is shown below.

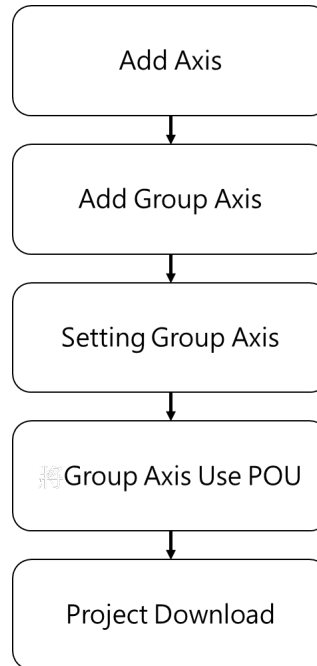

- **Procedure of creating axis groups in program**

- (1) Add single axes. The following example starts from creating two virtual axes.

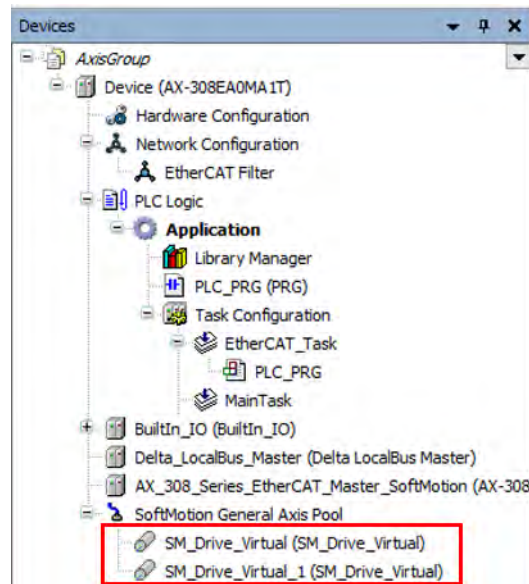

- (2) After finish creating axes, select “Application” and right click “Add Object” → “Delta Axis Group”

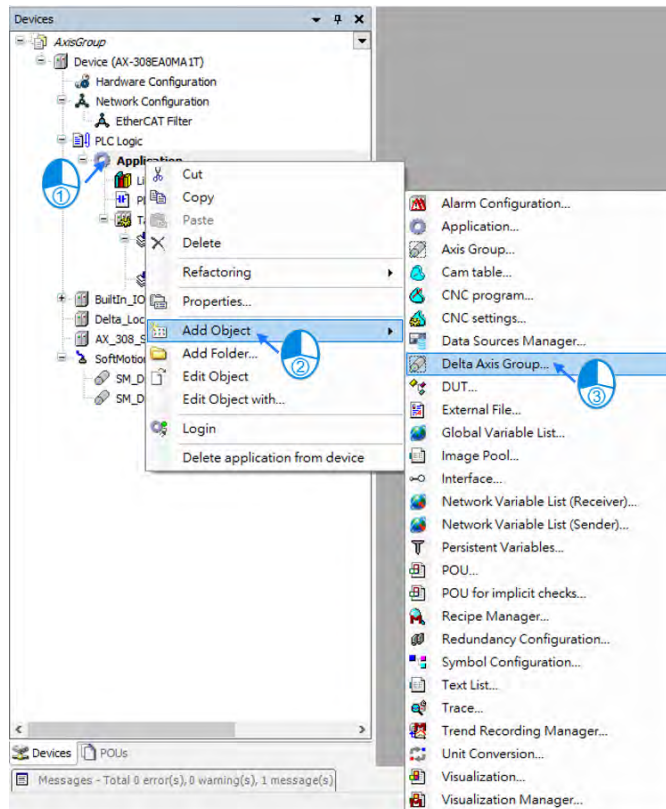

- (3) Set the name for axis group on the “Add Delta Axis Group” page, then click “Add”

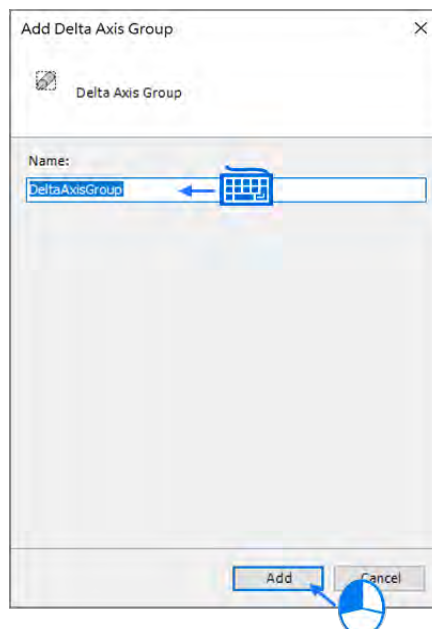

- (4) Afterwards, “DMC_Axis_Group” will be shown on the Project tree.

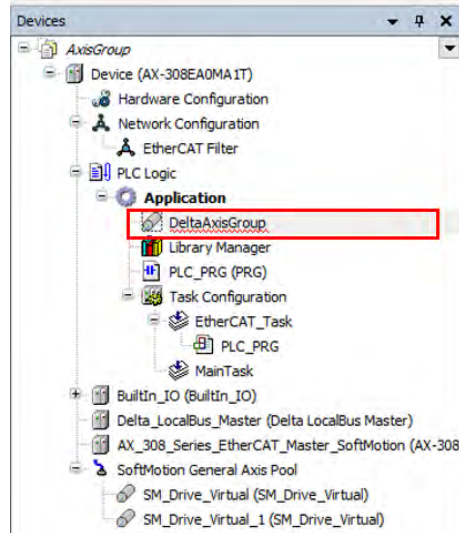

- (5) Click “DeltaAxisGroup”, then enter the names of two virtual axes into the fields of “Axis X” and “Axis Y”.

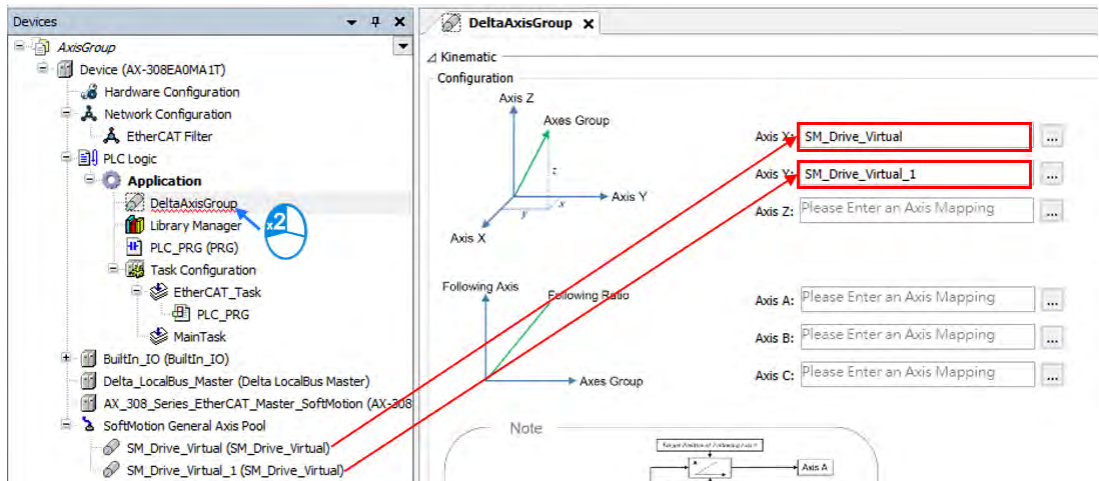

- (6) Click “Bus Task” to enter “Input Assistant”, then choose “EtherCAT_Task” on the screen and click “OK” with “EtherCAT_Task” shown in the Tasks field afterwards.

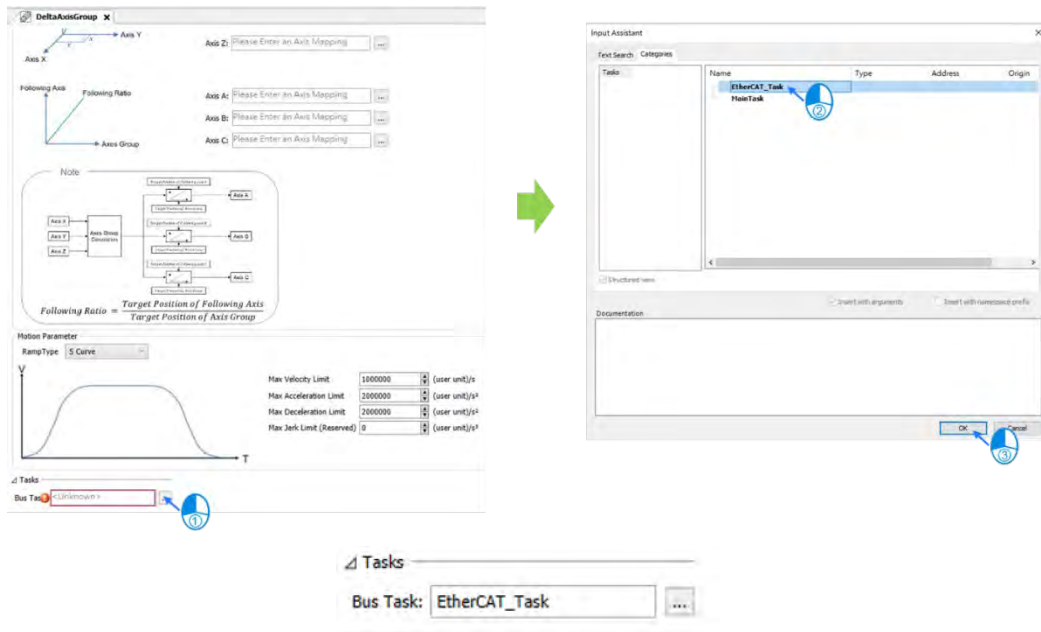

- (7) Add “DMC_GroupEnable” function block below PLC_PRG and connect the name of axis group to the AxisGroup input.

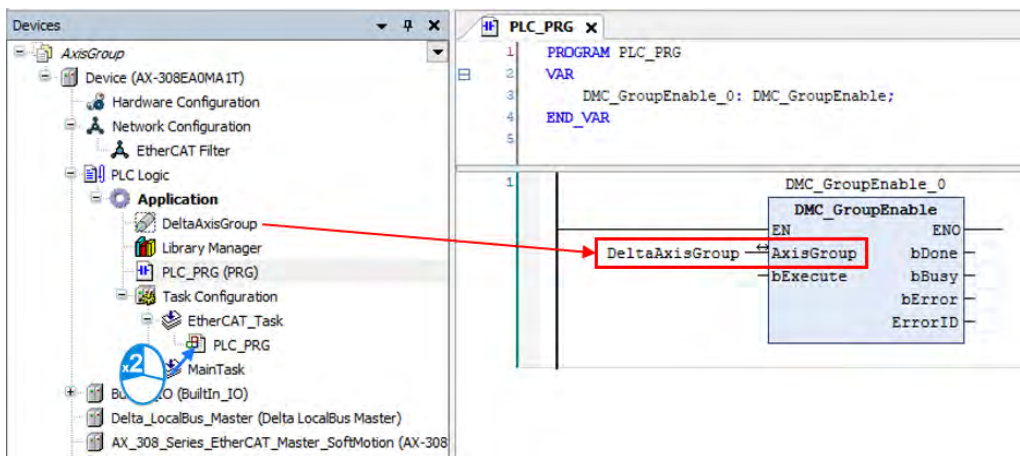

(8) After the program writing is completed, click the Compile button to confirm the validity.

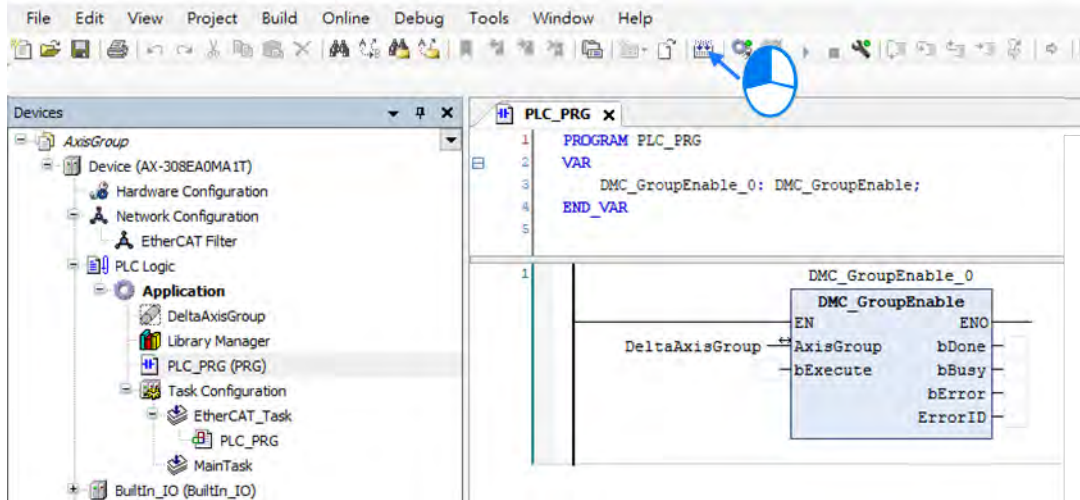

(9) After compilation, click Online Monitoring button to download the program.

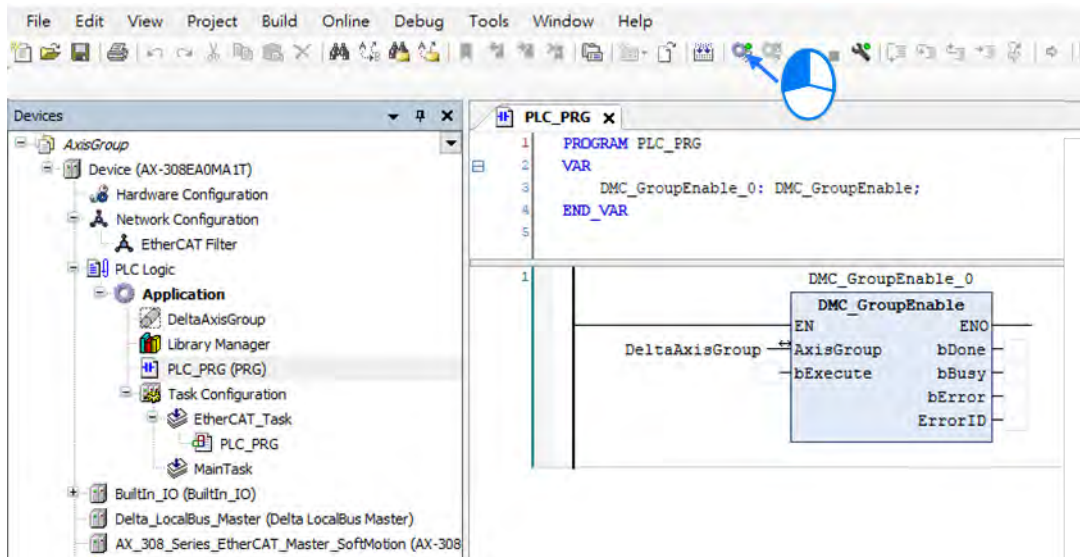

7.5 Motion Axis Variables

7.5.1 Variables for Single Axis

After creating axes in the Project tree with DIADesigner_AX, the corresponding axis parameters (read-only) will be generated automatically. Axes are categorized into two types: synchronous axis (Axis_REF_SM3) and positioning axis (Axis_REF_DML), which are set out in the following table

- **Synchronous axis (Axis_REF_SM3)**

Numbering	Name	Data type	Default value	Description
1000	nAxisState	SMC_AXIS_STATE(INT)	Standstill (3)	Operating state of the current axis according to MC_ReadStatus
1012	bCommunication	BOOL	FALSE	When communication is normal (refer as True), if disconnected (refer as False)
1014	uiDriveInterfaceError	UINT	0	When Driver Interface detects an error, Error Handling occurs
1021	wDriveId	WORD	Driver	The number in driver nodes on the Field bus
1025	fTaskCycle	LREAL	Driver	EtherCAT cycle time of task
1031	dwErrorID	DWORD	0	Error code of Slave (Add the parameter 0x603F in PDO and use the function block MC_ReadAxisError to read the error code.)
1035	fbeFBError	ARRAY [0..g_SMC_NUMBER_FB_ERRORS] OF SMC_FBERROR	0	Axis-related error table
1040	bVirtual	BOOL	FALSE	True: virtual axis ; false: real axis
1051	iRatioTechUnitsNum	DINT	1	Change gear ratio in axis setting (denominator)
1052	dwRatioTechUnitsDenom	DWORD	1	Change gear ratio in axis setting (numerator)
1060	iMovementType	INT	1	0 = Modulo 1 = Finite

Numbering	Name	Data type	Default value	Description
1061	fPositionPeriod	LREAL	1000	Max movement distance of rotary axis
1062	eRampType	SMC_RAMP TYPE	Trapez	Velocity ramp type: <ul style="list-style-type: none"> ■ Trapezoid ■ sin^2 ■ Quadratic ■ Quadratic(smooth)
1100/1	fSetPosition	LREAL	0	Commanded position (User-defined unit)
1101	fActPosition	LREAL	0	Feedback position (User-defined unit)
1110,11	fSetVelocity	LREAL	0	Commanded velocity (User-defined unit /s)
1111,10	fActVelocity	LREAL	0	Feedback velocity (User-defined unit /s)
1115	bConstantVelocity	BOOL	FALSE	True: the axis is driving with constant velocity
1120	fSetAcceleration	LREAL	0	Commanded acceleration (Unit: User-defined unit /s^2)
1125	bAccelerating	BOOL	FALSE	True when Axis is accelerating
1135	bDecelerating	BOOL	FALSE	True when Axis is decelerating
1140	fSetJerk	LREAL	0	Commanded jerk value
1160	fSetTorque	LREAL	0	Commanded torque (Nm)
1161	fActTorque	LREAL	0	Actual torque (Nm)
1200,2	fSWLimitPositive	LREAL	0	Setting the range of positive software limit
1201,3	fSWLimitNegative	LREAL	0	Setting the range of positive software limit
1204	bSWEndSwitchActive	BOOL	FALSE	True when software limit switch activated State machine changes to ErrorStop
1205	bSWLimitEnable	BOOL	FALSE	Software limit end switches: True (Enable) /False(Disable)
-	strDriveInterfaceError	STRING	"	Axis error

● Positioning Axis (Axis_REF_DML)

Numbering	Name	Data Type	Default value	Description
1000	nAxisState	SML_AXIS_STATE	SML_AS_PowerOff(0)	Operating state of the current axis according to MC_ReadStatus
1012	bCommunication	BOOL	FALSE	When communication is normal (refer as True), if disconnected (refer as False)
1014	uiDriveInterfaceError	UINT	0	When Driver Interface detects an error, Error Handling occurs
1051	iRatioTechUnitsNum	DINT	1	Change gear ratio in axis setting (denominator)
1052	dwRatioTechUnitsDenom	DWORD	1	Change gear ratio in axis setting (numerator)
1060	iMovementType	SML_MovementType	SML_MT_MODULO	Axis types SML_MT_MODULO = Rotary axis SML_MT_FINITE = Linear axis
1062	eRampType ^{e*1}	SMC_RAMPTYPE	Trapez	Setting Ramp type: ■ Trapezoid ■ sin ²
1101	fActPosition	LREAL	0	Feedback position (User-defined unit)
-	strDriveInterfaceError	STRING	''	Axis error

*Note 1: Only support Trapezoid and sin²

7.5.2 Variables for Axis Group

After creating axis groups in project tree with DIADesigner-AX, the corresponding axis variables will be generated automatically, which are set out in the following table.

Name	Data Type	Setting Value (Default Value)	Function
GroupState	DMC_GROUP_STATE	GroupDisabled / GroupStandby / GroupMoving / GroupHoming / GroupStopping / GroupErrorstop (GroupDisabled)	Commands for axis group status.
bError	BOOL	TRUE / FALSE (FALSE)	TRUE when an error occurs in the axis group
dwErrorId	DMC_ERROR	DMC_ERROR (DMC_GM_NO_ERROR)	Detailed error description
IrVelocity	LREAL	0 ~ 1.798E+308 (0)	Current velocity of axis group
IrAcceleration	LREAL	Positive number, negative number or zero (0)	Current acceleration of axis group
IrJerk	LREAL	Positive number, negative number or zero (0)	Current jerk of axis group
bAccelerating	BOOL	TRUE / FALSE (FALSE)	TRUE when accelerating
bDecelerating	BOOL	TRUE / FALSE (FALSE)	TRUE when decelerating
bConstantVelocity	BOOL	TRUE / FALSE (FALSE)	TRUE when moving at a constant velocity (including zero velocity)
bInPosition	BOOL	TRUE / FALSE (FALSE)	TRUE when positioning is done.
bContinueDataWriten	BOOL	TRUE / FALSE (FALSE)	TRUE when axis group is forced to stop and the relevant data can be used by DMC_GroupContinue.
ContinuePos	ARRAY [0..5] OF LREAL	[0,0,0,0,0,0]	When the execution of DMC_GroupInterrupt is done, the position of the current axis group is recorded.
AxisX_Name*	String		Display the Axis_X name for current axis group
AxisY_Name*	String		Display the Axis_Y name for current axis group
AxisZ_Name*	String		Display the Axis_Z name for current axis group
AxisA_Name*	String		Display the Axis_A name for current axis group
AxisB_Name*	String		Display the Axis_B name for current

Name	Data Type	Setting Value (Default Value)	Function
			axis group
AxisC_Name ^{*1}	String		Display the Axis_C name for current axis group
RampType	DMC_GROUP_RAMP_TYPE	Trapezoid / S Curve (S Curve)	Ramp type of current S-curve
IrMaxVelocityLimit	LREAL	Positive number or zero (1000000)	The maximum velocity of axis group
IrMaxAcceleration Limit	LREAL	Positive number or zero (2000000)	The maximum acceleration of axis group
IrMaxDecelerationLimit	LREAL	Positive number or zero (2000000)	The maximum deceleration of axis group
IrMaxJerkLimit (Reserved)	LREAL	Positive number or zero (0)	The maximum jerk of axis group (Reserved)
PlanningPriority ^{*2}	DMC_GROUP_PLANNING_PRIORITY	Velocity / Acceleration (Velocity)	Planning the path: Velocity: Acceleration or deceleration can be ignored in order to meet the condition of velocity. Acceleration: Velocity can be ignored in order to meet the condition of acceleration / deceleration.
bVelocityWarning	BOOL	TRUE / FALSE (FALSE)	When the velocity of axis group exceeds the proportionality, the state is TRUE.
bAccelerationWarning	BOOL	TRUE / FALSE (FALSE)	When the acceleration of axis group exceeds the proportionality, the state is TRUE.
bDecelerationWarning	BOOL	TRUE / FALSE (FALSE)	When the deceleration of axis group exceeds the proportionality, the state is TRUE.
bJerkWarning (Reserved)	BOOL	TRUE / FALSE (FALSE)	When the jerk of axis group exceeds the proportionality, the state is TRUE.
StopMethod	Enum of BYTE	Immediate Stop / MaxGroupDecStop / MaxAxisDecStop (Immediate Stop)	Set the stop method when an error occurs to the axis group or in the middle of motions
IrVelocityWarning Percentage	LREAL	0 ~ 1 (0)	Set the proportionality of the maximum velocity of axis group for the warning to start. Once the set percentage is reached, the warning starts. Set the value to 0 to stop the warning.
IrAccelerationWarning Percentage	LREAL	0 ~ 1 (0)	Set the proportionality of the maximum acceleration of axis group for the warning to start. Once the set percentage is reached, the warning starts. Set the value to 0 to stop the warning.

Name	Data Type	Setting Value (Default Value)	Function
IrDecelerationWarning Percentage	LREAL	0 ~ 1 (0)	Set the proportionality of the maximum deceleration of axis group for the warning to start. Once the set percentage is reached, the warning starts. Set the value to 0 to stop the warning.
IrJerkWarning Percentage (Reserved)	LREAL	0 ~ 1 (0)	Set the proportionality of the maximum jerk of axis group for the warning to start. Once the set percentage is reached, the warning starts. Set the value to 0 to stop the warning.
Radius Correction	LREAL	0 ~ 100 (0, 1)	This is to set the tolerance for setting the radius when circular interpolation is selected in the function block of DMC_MoveCircularRelative.AuxPoint. Tolerance % = the distance between the center point and the bisection of the starting and ending points to be divided by the radius.
bVelocityWarning	BOOL	TRUE / FALSE (FALSE)	TRUE when the velocity of axis group exceeds the value set in the IrVelocityWarning Percentage.
bAccelerationWarning	BOOL	TRUE / FALSE (FALSE)	TRUE when the acceleration of axis group exceeds the value set in the IrAccelerationWarningPercentage.
bDecelerationWarning	BOOL	TRUE / FALSE (FALSE)	TRUE when the deceleration of axis group exceeds the value set in the IrDecelerationWarningPercentage.
bJerkWarning (Reserved)	BOOL	TRUE / FALSE (FALSE)	TRUE when the jerk of axis group exceeds the value set in the IrDecelerationWarningPercentage.
StopMethod	Enum of BYTE	Immediate Stop / MaxGroupDecStop / MaxAxisDecStop (Immediate Stop)	Set the stop method for the axis group when errors occur or when it is time to stop the movement.

Note:

1. When the rotary type of axis is selected, the range of motion can NOT exceed the value set in modulo, otherwise, an error message "Axis limit violated" will occur." appears.
2. For the DL_MotionControl library of V1.3.3.0 or later versions, the display of PlanningPriority is supported.

7.6 Motion Control Programming

7.6.1 Motion Control Program

Before programming in DIADesigner-AX, please take the following descriptions as reference.

7.6.1.1 Program Architecture and Types in DIADesigner-AX

In the classic architecture, a source code for a PLC is composed of procedures including subroutines. When the size of a program becomes larger, maintenance and debugging also becomes a huge burden. Under the IEC 61131-3 architecture, a program is divided into several units according to the functions or characteristics which makes developing and maintaining much easier. Since POU are modularized, different POU can be developed by different designers to enhance distribution of professional manpower and project execution

There are three types of POUs: program (PROG), function block (FB) and function (FC).

- Program (PROG):

The program type plays a major process role in a PLC program. The execution is assigned by Task which includes specific scan cycle or interrupt subroutines and provides scan order arrangement for programs in the Task list. Besides, a POU of the program type can call a function block (FB).

- Function block (FB):

A static symbol can be declared in a function block (FB). As a result, the value of the symbol after an operation can be retained. Owing to the fact that the operation is performed on the value memorized in the function block and an input value, the output values may be different even if the input values are the same.

Besides, a function block can call another function block. The function block (FB) type is similar to subroutines. The FB process requires suitable parameters and can only execute once called by a program.

- Function (FC):

Function (FC) is used to return back operation results. Contrary to FBs, it have no memory and can only return a single value. Since an FC does not have any memory of its own, it cannot call a function block but a function.

- Tasks

Each program POU needs to assign a Task that determines the order for program execution or start.

The programming structure characteristic of IEC 61131-3 is that a program can be divided into several independent POUs. When POUs are compiled, they are rearranged and combined into an execution code for scanning. The new combination order of POUs are based on the assigned Tasks.

Below are types of tasks:

- Cyclic: Assigned POU sets interval time for per scan.
- Event: When Bool variable is set from False to True, a scan execution is performed.
- External: When external triggers to send a signal, a corresponding POU is executed.
- Freewheeling: Assigned POU performs scan automatically in a continuous loop when the previous scan has been completed.
- Status: When Bool variable is set from False to True, a scan cycle is executed.

Please refer to section 4.4.1 for the details of task operating process.

7.6.1.2 POU in DIADesigner-AX

All POU created by you are listed in the project management area with programs and function blocks been managed separately. In addition, the icon of POU may vary based on different program and function block programming languages which also includes information beside the POU name.

Double-click the POU in the project management area for editing. The POU editing section is composed of two parts. The upper part of the editing section is the symbol table of local variables, while the lower part is the main part of the program. Also, the editing environment at the lower part of the editing section is different when using different programming languages. For more information on symbol tables and programming, please refer to the following sections.



7.6.1.3 Adding POU in DIADesigner-AX

- Open the existed projects in DIADesigner-AX and right-click “Application” to select “Add Object”, then choose “POU”.

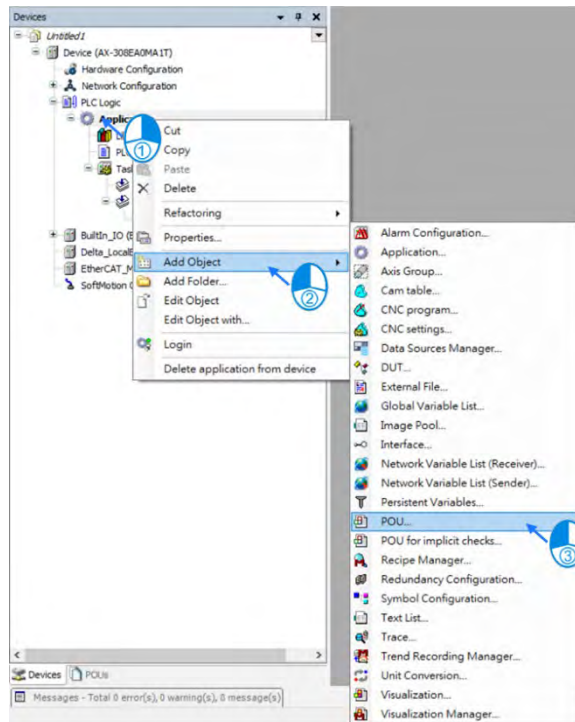

- Type in POU name. For Implementation language, select a programming language then click “Add”

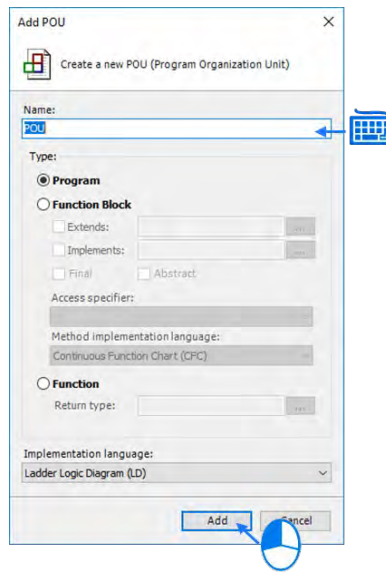

- The POU appears in the left column. Double-click on “EtherCAT_Task” and choose “Add Call”.

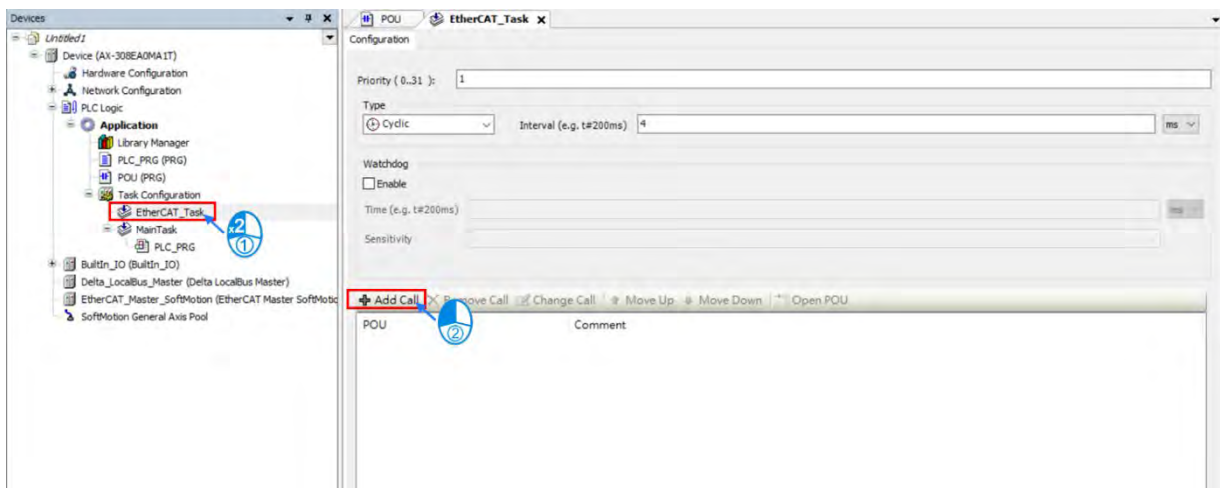

- Select the created POU and click “OK”.

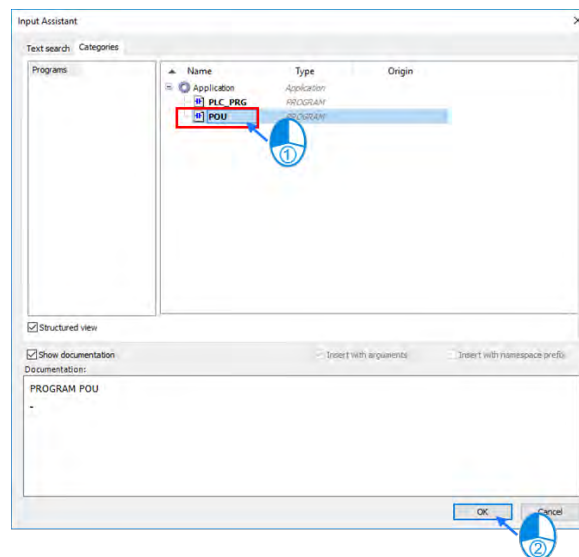

- Choose POU in EtherCAT_Task item to compile a program .

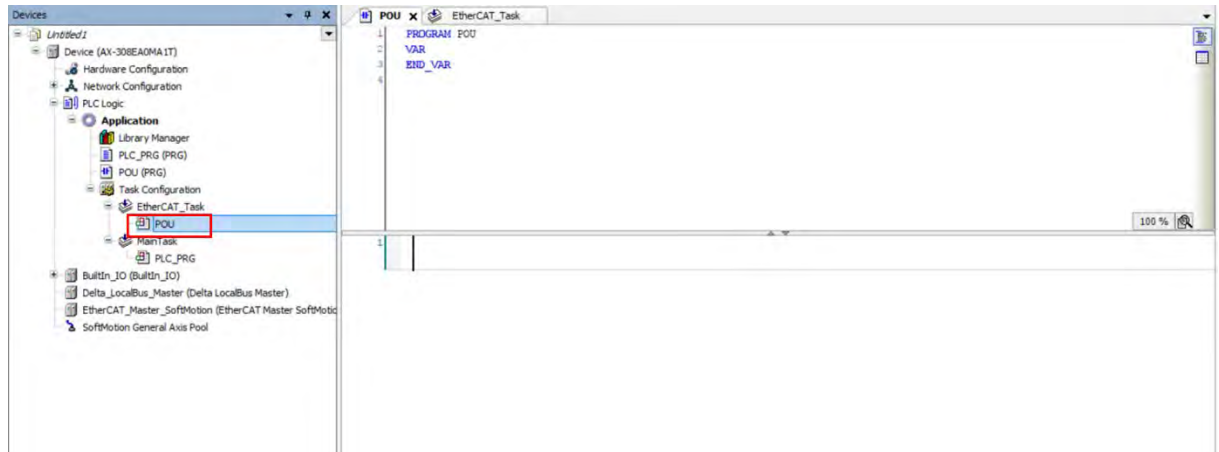

7.6.1.4 PDO Mapping

Before using motion control instructions, the communication of PDO (Process Data Objects) Mapping between the software DIADesigner-AX and AX motion CPU must be setup first.

Setting values for PDO Mapping

RxPDO(1600 hex)	Control Word(6040 hex) · TargetPosition(607A hex)
TxPDO(1A00 hex)	Status Word(6041 hex) · ActualPosition(6064 hex)

The table above is the pre-determined PDO Mapping parameters for ASDA-A2-E.

Please refer to **AX Series Motion Controller Manual** for the PDO parameters required by the related motion function blocks.

7.6.2 Axis State Transitions

This section introduces single axis state transitions and multi-axis state transitions in axis groups for multiple function block use. The transition rules fulfill PLCopen motion control standard.

7.6.2.1 Axis State

- Synchronous Axis

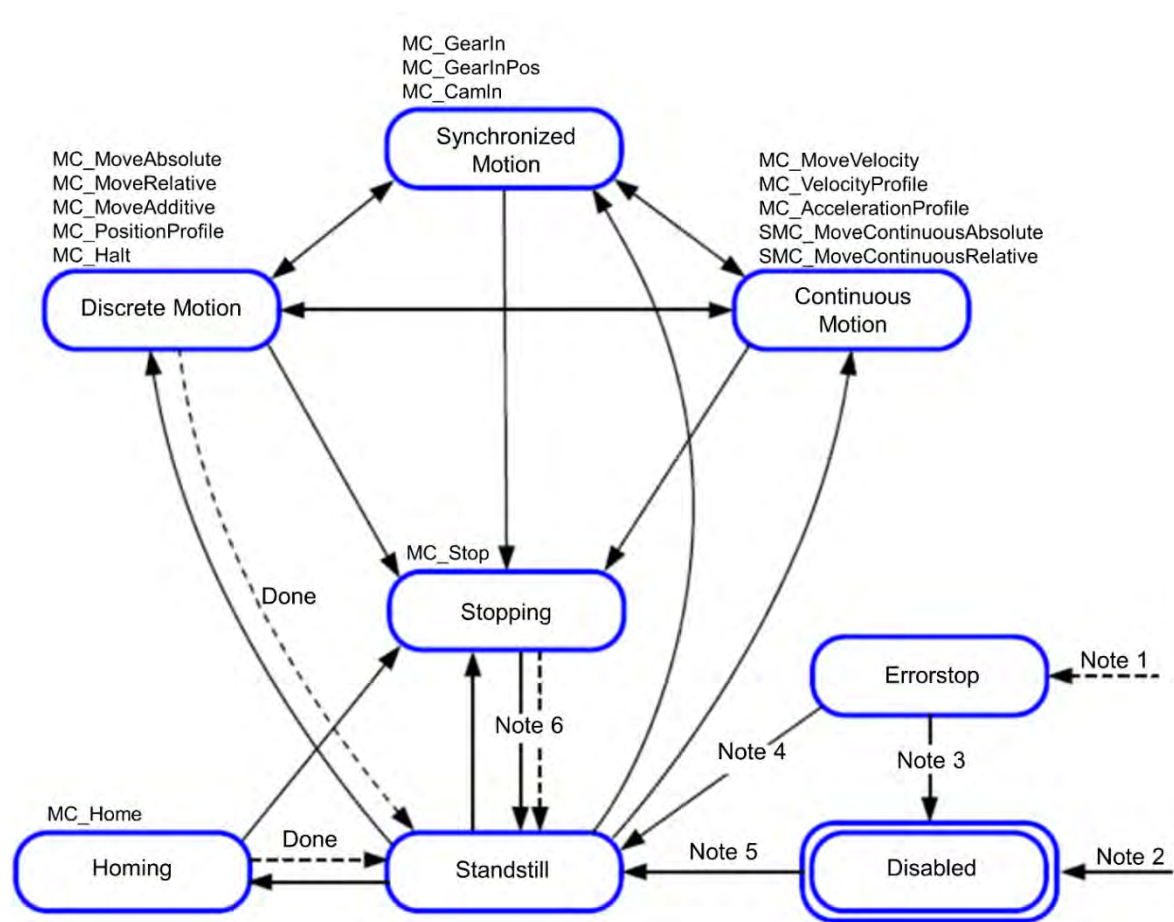

Note 1: Regardless of the state. An error in the axis has occurred.

Note 2: Regardless of the state. MC_Power.Enable = FALSE. There is no error in the axis.

Note 3: MC_Reset and MC_Power.Status = FALSE

Note 4: MC_Reset and MC_Power.Status = TRUE and MC_Power.Enable = TRUE

Note 5: MC_Power.Enable = TRUE and MC_Power.Status = TRUE

Note 6: MC_Stop.Done = TRUE and MC_Stop.Execute = FALSE

State	Meaning
Disabled	Axis during servo OFF, standstill, ready to execute
Standstill	Axis during servo ON, standstill
Discrete Motion	The state would be Discrete Motion while executing single-axis motion instructions.
Continuous Motion	The state would be Continuous Motion while executing continuous motion instructions of single-axis.
Synchronized	Achieves state of synchronized motion via instructions for synchronized control. Includes synchronous waiting state.
Stopping	When Execute is True via MC_Stop instructions Cannot execute axis instructions during this state When CommandAborted is TRUE, the instruction is executed
ErrorStop	Axis during servo ON or axis errors Cannot execute axis motion instructions under this state and all instructions are in CommandAborted = 1 state.
Homing	The state would be Homing while executing MC_Home or MC_HomeWithParameter instructions for single axis.

● Positioning Axis

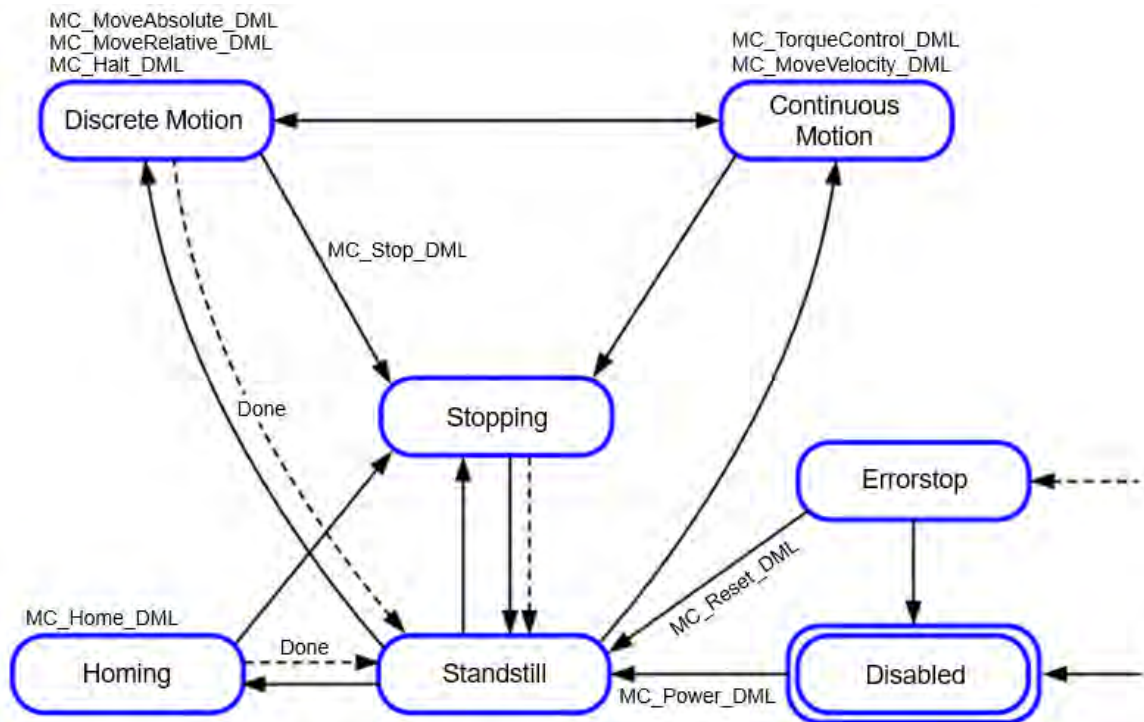

State	Meaning
Disabled	Axis during servo OFF, standstill, ready to execute
Standstill	Axis during servo ON, standstill
Discrete Motion	The state would be Discrete Motion while executing single-axis motion instructions.
Continuous Motion	The state would be Continuous Motion while executing continuous motion instructions of single-axis.
Stopping	When Execute is True via MC_Stop instructions Cannot execute axis instructions during this state
ErrorStop	When an error occurs in the single axis. Cannot execute axis motion instructions for single axis under this state.
Homing	The state would be Homing while executing MC_Home or MC_HomeWithParameter instructions for single axis.

7.6.2.2 Axis Group State

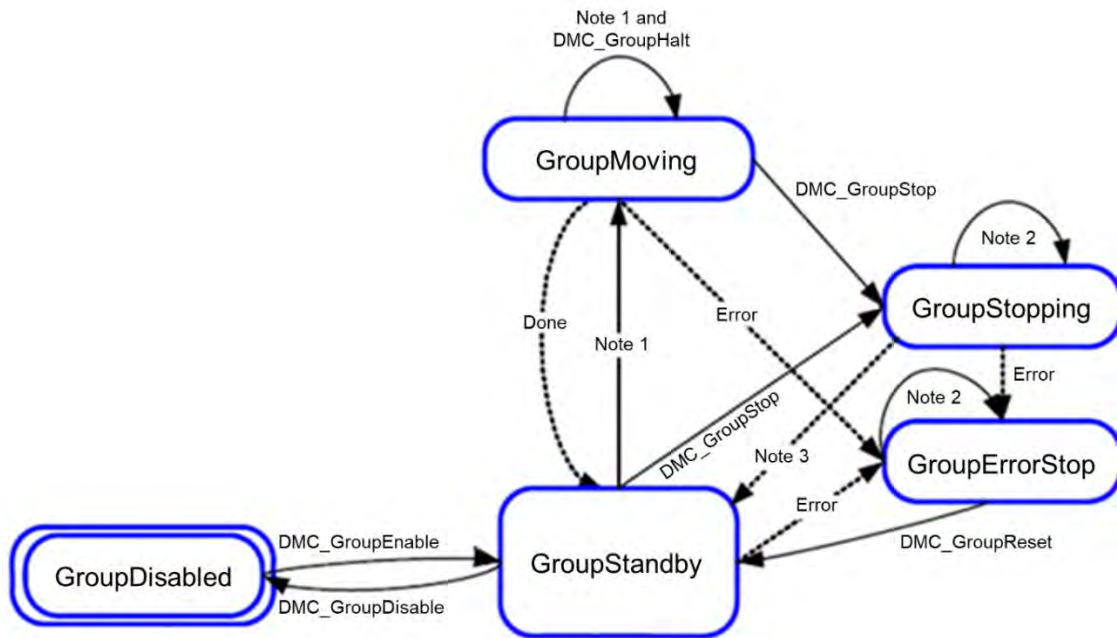

Note 1: Applicable to all function blocks of group moving, non-administrative.

Note 2: All motion function blocks are able to be executed when the state is GroupErrorStop or GroupStopping

Note 3: When DMC_GroupStop is Done or MC_GroupStop is not Execute.

Note 4: The state of GroupDisabled can only be changed under GroupStandby state , or an error will occur.

Status	Definition
GroupDisabled	Execute MC_GroupDisable and switch axis to GroupDisabled.
GroupStandby	No motion instructions has been executed and the state of axis group is GroupStandby.
GroupMoving	A group positioning instruction is being executed, the state of axis group is GroupMoving.Moving °
GroupStopping	When Active of MC_GroupSto is True, the state of axis group is GroupStopping. No motion instructions can be executed under this state.
GroupErrorStop	The axis group will enter GroupErrorStop state, once an error occurs.

- Interaction between single-axis state and axis group state
 - (1) If one of the axes in the group is in ErrorStop and the axis group is not in GroupDisabled, the group would be in GroupErrorStop status.
 - (2) When state GroupMoving/GroupStopping/GroupHoming disconnect the power of an axis, the axis group would be in GroupErrorStop state.
 - (3) If all axes are in Standstill, the axis group can be in state GroupStandby, GroupDisabled or GroupErrorStop.
 - (4) If the motion of a single-axis interrupts the motion of axis group, the other axes in the group should be stopped and enter state Stopping, while the state of the axis group entering state GroupStandby.
 - (5) In case that the axis group is in GroupStandby, there's no need for all the single axes being in state SynchronizedMotion.
 - (6) For axis group motion instructions (including MC_GroupStop), all single axes in the axis group should be in state SynchronizedMotion.
 - (7) When an error occurs during the movement of axis group, all axis in the group should stop immediately till the axis group entering state GroupErrorStop. Those single axes with no errors will enter state Standstill.
 - (8) When the state of axis group is GroupErrorStop, the state of single axes will not be affected.

7.6.3 Execution and Status Indication for Motion Control Instructions

The motion function blocks are grouped under two main categories with AX series motion controllers:

Category	Description
MC_	PLCopen motion control function blocks
DMC_	Delta self-defined function blocks*

***Note:** Delta self-defined function blocks (DMC) include motion control type and other administrative/ non-administrative type applicable for AX series motion CPU. Please find AX

General pins for motion control function blocks include input, output and in-out. The section explains the meanings and behaviors of these pins. For more details concerning motion function blocks, please refer to **AX Series Motion Controller Manual**.

7.6.3.1 Basic Rules of Executing Instructions

- Defining input and output pins

Common inputs and outputs in motion control function blocks are listed below. Usually, a function block consists of at least one or a part of the input/output pins listed below. For example, a function block contains either Execute or Enable input pin based on the properties of the motion control function block.

Inputs			
Name	Description	Date Type	Setting value (Default)
En	Receiving the logic status in front of the instruction	BOOL	True/False (False)
Enable	Enabling motion control function block	BOOL	True/False (False)
Execute	Executing motion control function block	BOOL	True/False (False)
Outputs			
Name	Description	Date Type	Setting value(Default)
Eno	Transferring the input logic state of the <i>En</i> to the next serial instruction	BOOL	True/False (False)
Done	The execution of the function block is completed	BOOL	True/False (False)
Valid	The output pin value is valid	BOOL	True/False (False)
Busy	The motion control function block is listed for execution	BOOL	True/False (False)
Active	Axes are been controlled by function blocks	BOOL	True/False (False)
CommandAborted(Aborted)	Aborts execution for motion control function blocks	BOOL	True/False (False)
Error	Error occurs in function blocks	BOOL	True/False (False)

A motion control function block usually consists of Execute or Enable input pin and is used to either execute or enable a motion control function block. In addition, a motion control function block has Busy and Done output pins. The Busy and Done outputs refer to the status of motion control function blocks. When execution of motion control function blocks can be aborted by another motion control function block, the CommandAborted/Aborted output pin appears in the function block. Nevertheless, when Error output pin is True, this indicates error during function block execution.

A motion control function block not only has Execute/Enable input, but also include the input value/state. The characteristics are described below.

- Use input value
 - When a function block contains Execute input, each input value is used once Execute input signal changes from False to True. However, when Execute is re-triggered, input values are not updated as a result.
 - When a function block contains Enable input, each input value is used once Enable input signal changes from False to True. Compare to Execute input, function blocks of Enable input usually have more input values which need to be continuously updated. (Refer to each function block for more detail).

- Input value exceeds range

When a motion control function block is enabled, the system restricts you to input values that exceeds the permitted range. Nevertheless, error occurs during execution of motion control function blocks and results in motion axes errors. You should avoid input incorrect values in programs.

- Output pins are mutually exclusive.

- When a function block contains Execute input, Busy output, Done output, CommandAborted output or Error output, only one state is set to True during the same time. When Execute input is set True, one output (Busy, Done, CommandAborted or Error) must set True.

- When a function block contains Enable input, while Valid output and Error output are mutually exclusive, this indicates only one output is set True.

- Valid time for output data/status value

- When a function block contains Execute input and the input signal changes from True to False, the current Done output, Error output, CommandAborted output of current True and output pin data are reset or cleared. However, when a function block is Busy, despite that the Execute input signal changes from True to False, execution of the function block will not stop. The expected output state (Done output, Error output, CommandAborted output) will generate to True and retain for one week.

- When a function block contains Enable input and input signal changes from True to False, Valid output, Busy output and Error output are reset. (For input and output description not mentioned, please refer to MC_Power instruction for more details.)

- Characteristic of Done output

When execution of a motion control function block is completed, Done output is set to True.

- Characteristic of Busy output

- When a function block contains Execute input and uses Buy output to indicate incomplete execution, new output state (value) is to be generated. When Execute input signal changes from False to True, then Busy output is set to True. When Done output, CommandAborted output or Error output is set to True, then Busy output is reset.

- When a function block contains Enable input and uses Buy output to indicate incomplete execution, new output state (value) is to be generated. When Enable input signal changes from False to True and as long as Busy output is set True, changes in input state (value) can be expected.

- Characteristic of CommandAborted/Aborted output

When execution of a motion control function block is aborted, CommandAborted/Aborted output is set True.

- Relation between Enable input and Valid output

A function block contains Enable input and uses Valid output to indicate validity of output data/status. Only when Enable input is set True and output data/status is valid, then Valid output is set True; when errors occur in function blocks, then output data/status is invalid and Valid output is set to False; when errors are cleared in motion control function blocks and output data/status changes to valid, then Valid output is set to True.

7.6.3.2 Timing Diagram for Input/Outputs

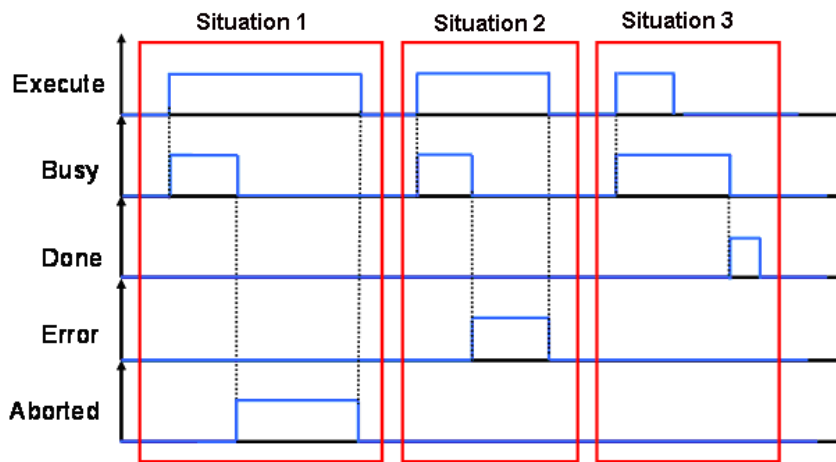

Situation 1: The execution of motion control function block is aborted.

Situation 2: Errors occur in motion control function blocks.

Situation 3: The execution of motion control function block is completed.

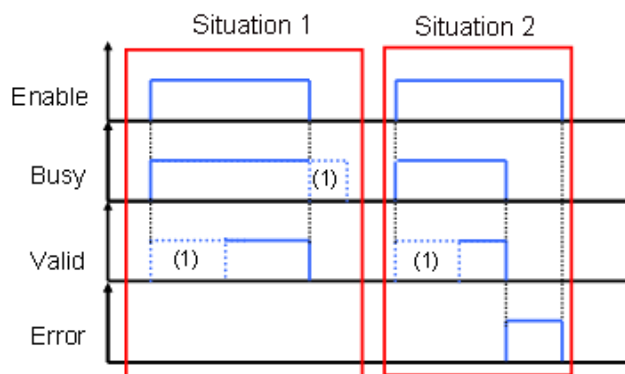

Situation 1: The execution of motion control function block is normal.

Situation 2: An error occurs in a motion control function block.

7.6.3.3 Repeated Execution Behavior of Single Axis Motion Instructions

When single axis motion function blocks are executing (Busy state), variables for input pins can be modified and function block pins can be re-triggered on the rising. Meanwhile, the state of function block output pins remain the same (remain Busy), while the system is executing which means it is aborting the previous rising edge-trigger instruction under buffer mode. For similar mode of behavior, refer to section 7.6.3.5 Single Axis Buffer Mode (Aborting) for more details.

7.6.3.4 Multi-execution of Motion Control Instructions

This section describes executing multiple motion control instructions for the same axis or axis group within the same scan period.

- In the following programming, instruction instances Move1 and Move2 start in the same task period when contact A turns ON.
- According to the ladder logic, instructions in a program are executed from the top. Therefore Motion1 starts first, and then Motion 2 will be executed once Motion 1 is finished.
- This is considered multi-execution of motion control instructions. Since the motion combination is determined by input variables of BufferMode, BufferMode setting in Motion 2 is used to execute Motion 2 in relation to Motion 1.

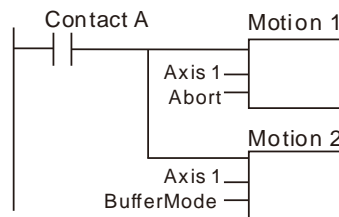

7.6.3.5 Synchronous Execution Behavior of Motion Instructions

■ Single Axis Buffer Mode

You can execute another motion control instruction while an axis is moving. A total of six types of BufferMode can be chosen to proceed multi-execution of two instructions, which you can set the BufferMode input variables to the later motion control instruction to select one of the six Buffer Modes.

The meanings of terms relating to BufferMode shown as follows:

1. Current instruction: The motion control instruction that was in operation just before executing the multi-execution instruction.
2. Buffered instruction: A motion control instruction that was executed during an axis motion and is waiting to be executed
3. Transit velocity: The velocity to use by the current instruction to transfer to the buffered instruction.
4. Target Velocity: The Velocity parameters of the instruction.
5. Target position: the Position or Distance parameters of relating move instructions.

BufferMode	Description of Operation
0 : mcAborting (Aborting)	The current instruction is aborted and the multi-executed instruction is executed.
1 : mcBuffered (Buffered)	The buffered instruction is executed after the operation for the current instruction is normally finished.
2 : mcBlendingLow (Low velocity)	The buffered instruction is executed after the target position of the current instruction is reached. The transit velocity is set to the target velocity of the current instruction or the buffered instruction, whichever is lowest.
3 : mcBlendingPrevious (Previous velocity)	The buffered instruction is executed after the target position of the current instruction is reached. The target velocity of the current instruction is used as the transit velocity
4 : mcBlendingNext (Next velocity)	The buffered instruction is executed after the target position of the current instruction is reached. The target velocity of the buffered instruction is used as the transit velocity.

BufferMode	Description of Operation
5 : mcBlendingHigh (High velocity)	The buffered instruction is executed after the target position of the current instruction is reached. The transit velocity is set to the target velocity of the current instruction or the buffered instruction, whichever is highest.

● **Example:** Briefly explain with two MoveRelative instructions

The max velocity and the displacement of the first and second instruction are respectively V_1 , S_1 and V_2 , S_2 .

Different types of BufferModes set for the second instruction result in various transiting situation shown as follows.

■ **Buffermode=mcAborting**

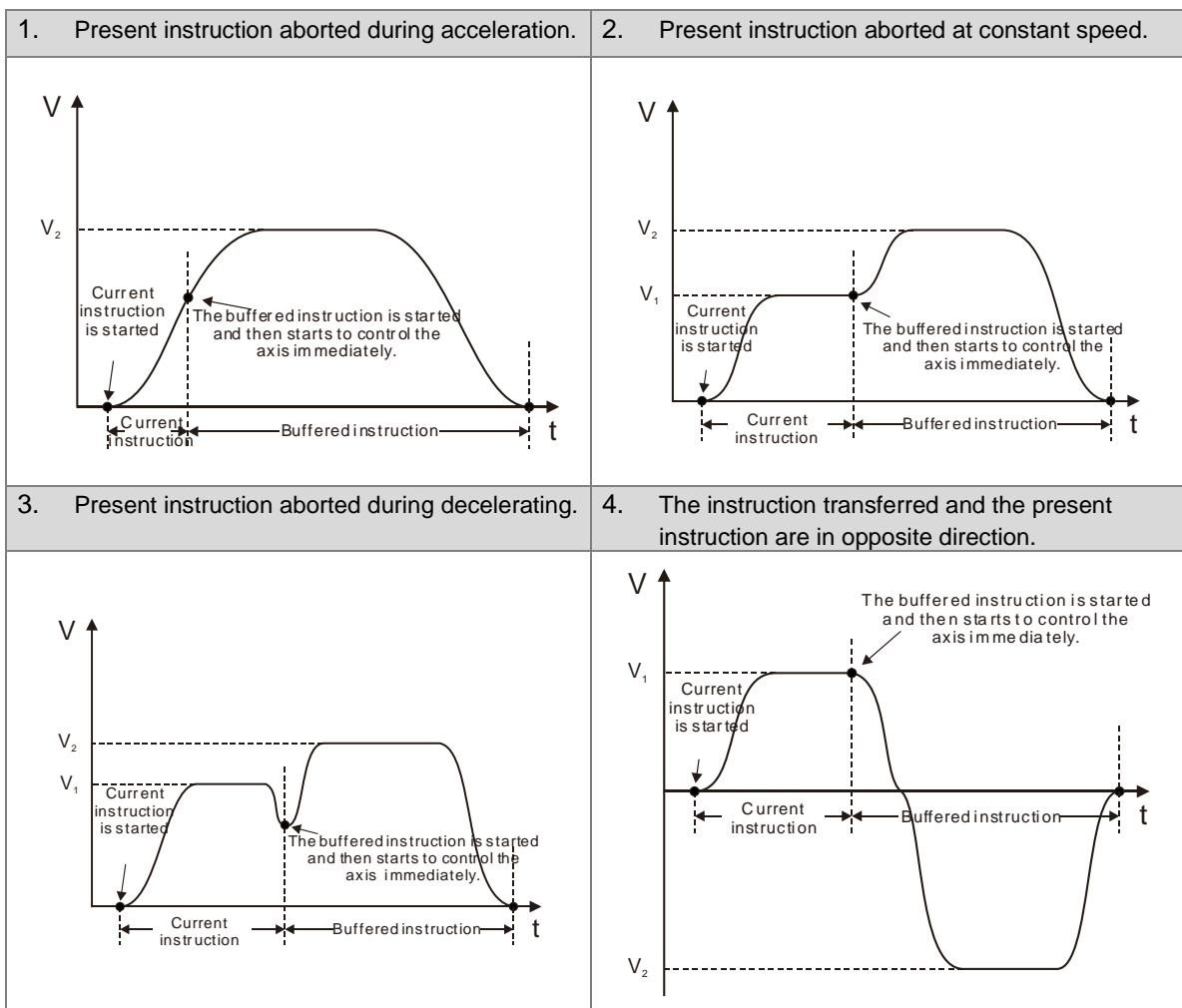

■ Buffermode=mcBuffered

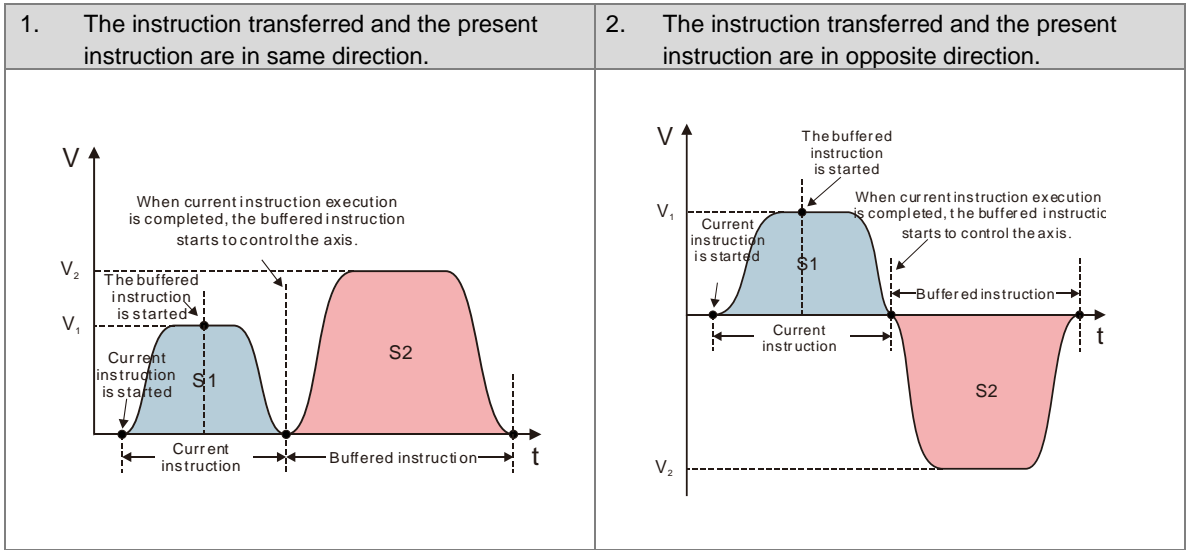

■ Buffermode=mcBlendingLow

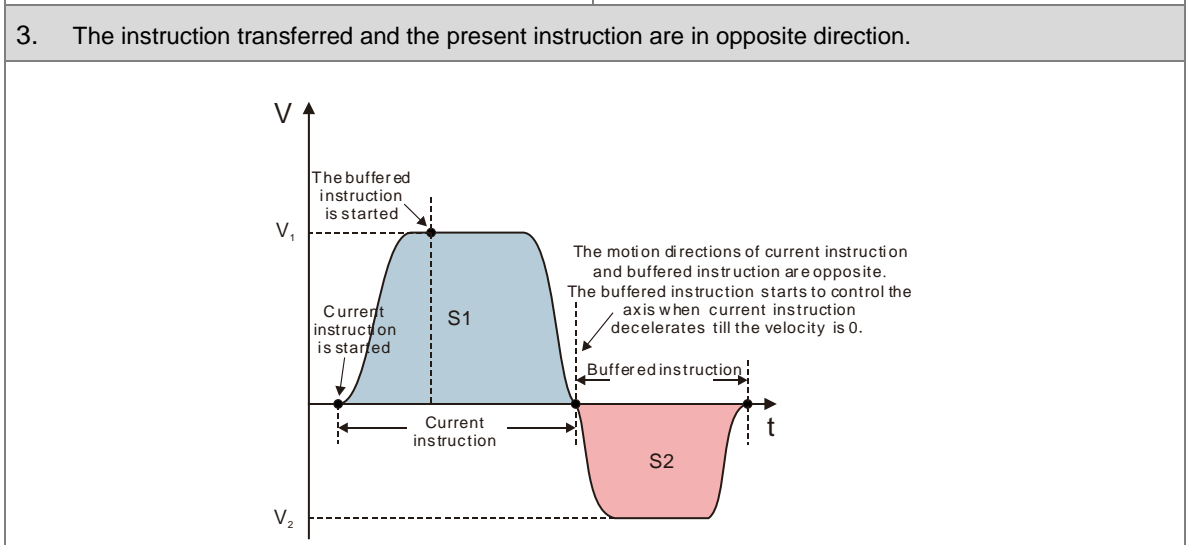
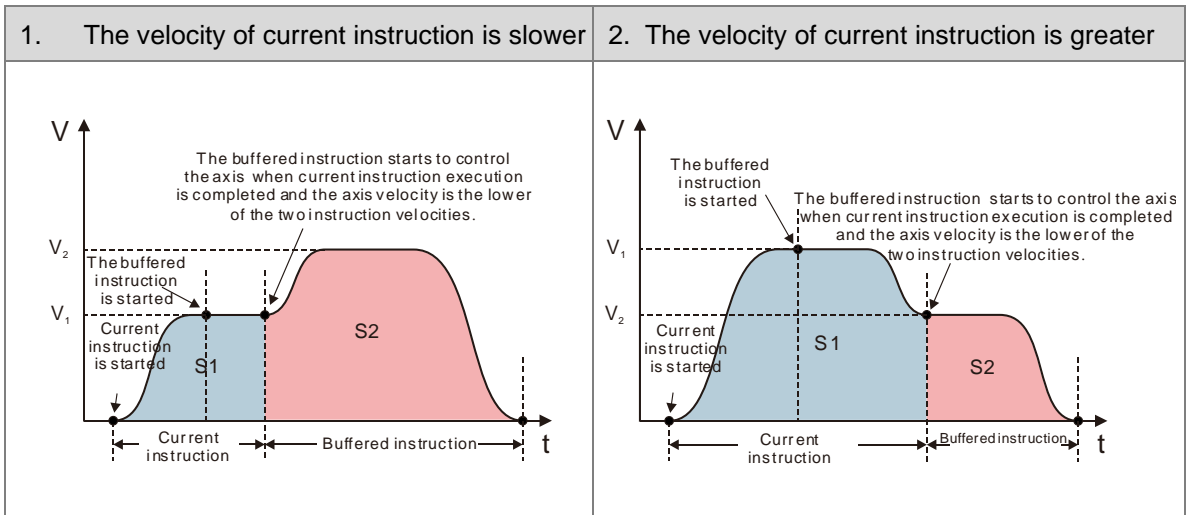

■ Buffermode=mcBlendingPrevious

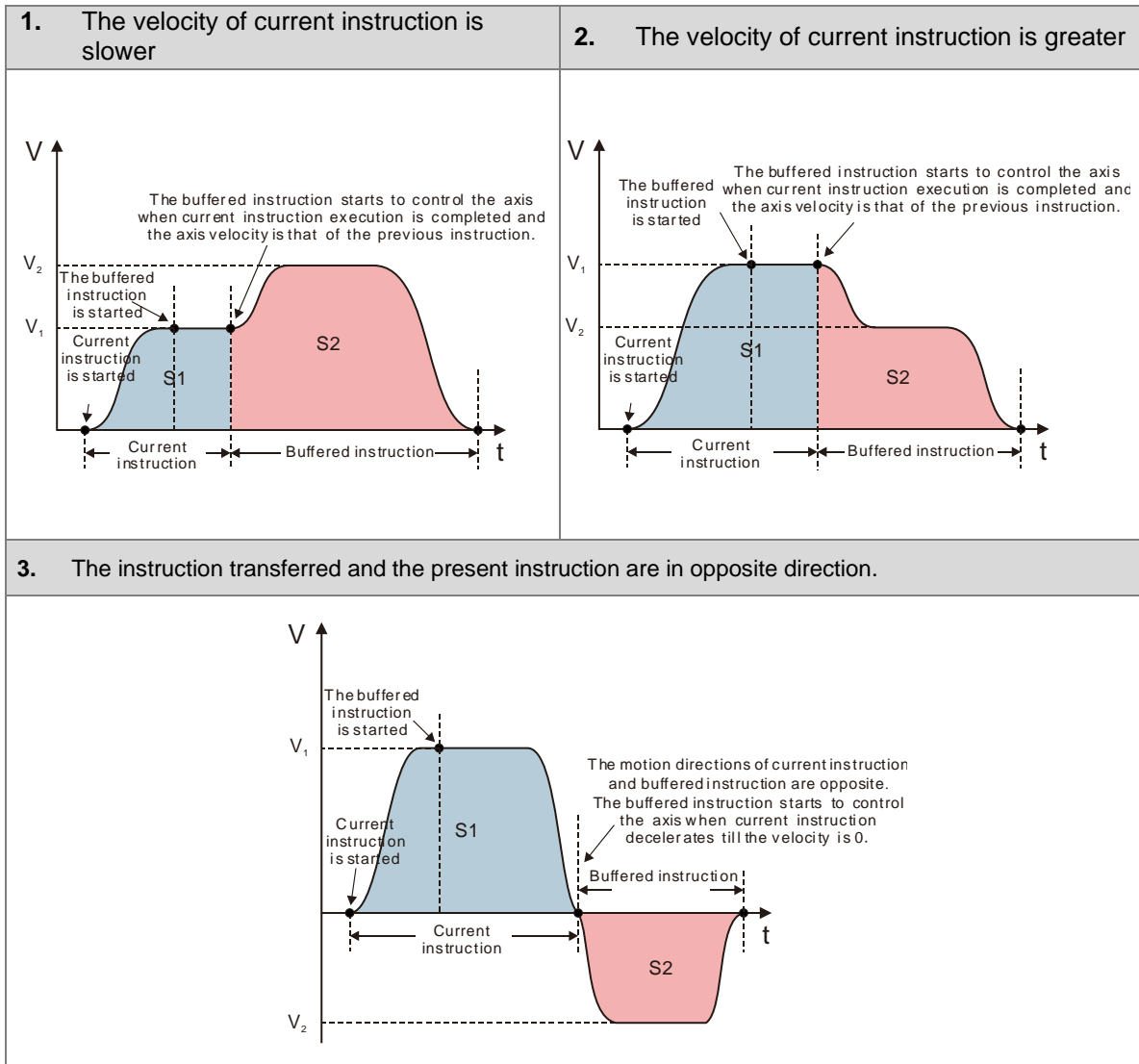

■ Buffermode=mcBlendingNext

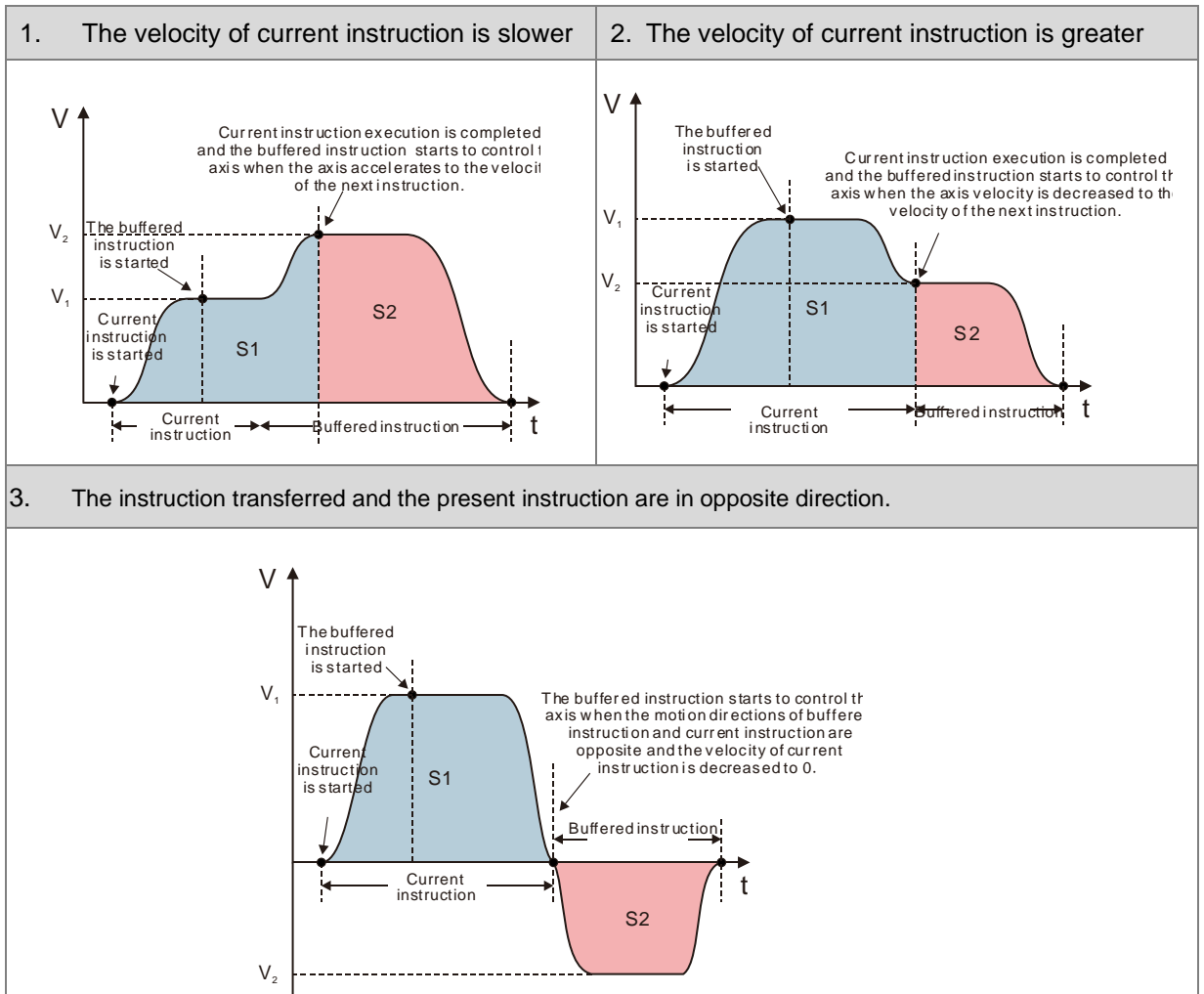

■ Buffermode=mcBlendingHigh

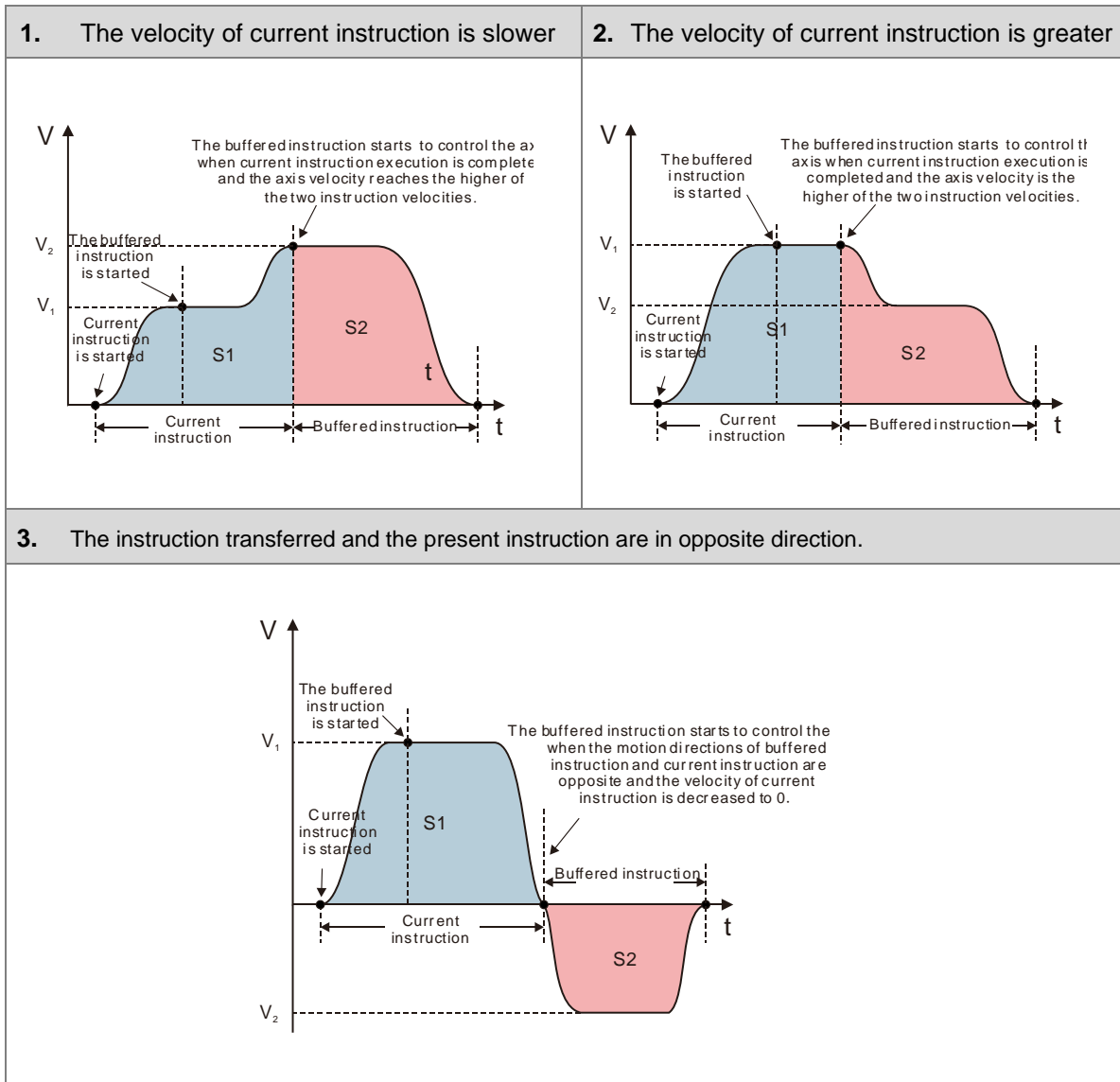

*Note: Single-axis motion instructions MC support only Buffermode=mcAborting while motion instructions for axis group support all of the above BufferMode.

7.6.4 Position

This section describes the position processes of motion control programming.

7.6.4.1 Types of Positions

MC function blocks are formed by the following two types of positions.

- Command position: MC function block provides command position.
- Actual position: The actual feedback position from servo drives.

The following figure indicates the relationship between the command position and the actual position.

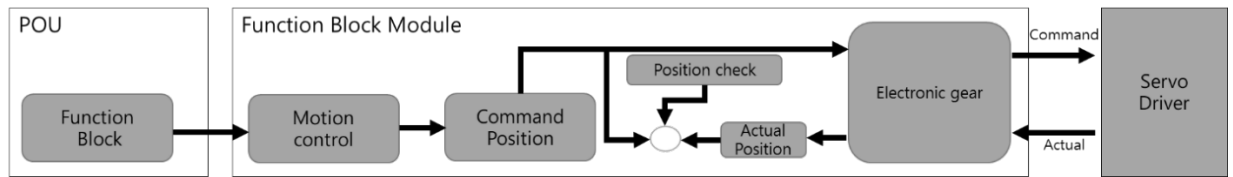

The following item of command position and actual position is the same.

Position Type	Description
Command position	This is the position that motion controller outputs to servo drive
Actual (feedback) position	This is the position feedback from servo drive or encoder

***Note:** For axes configured as Virtual, the actual position is equal to the command.

7.6.5 CAM Tables and Framework

This section introduces electronic cam (E-CAM) operation and using DIADesigner-AX to generate CAM table settings as well as E-CAM applications. For details regarding instructions, please refer to **AX Series Motion Controller Manual**.

7.6.5.1 E-CAM Framework

Adopt CAM Editor function from software DIADesigner-AX for planning CAM curves and download to PLC via communication protocols so that MC function blocks can be used to control CAM.

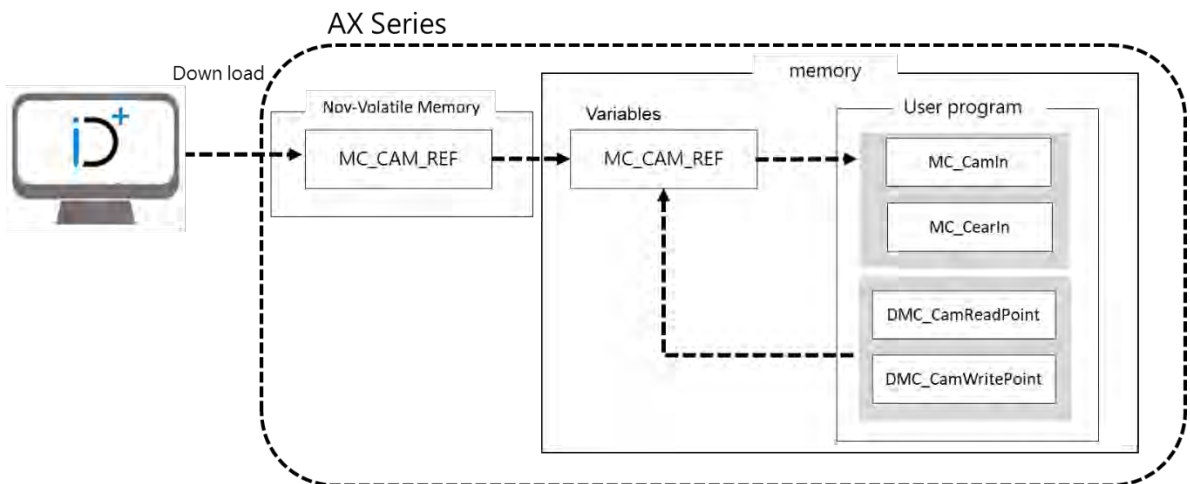

7.6.5.2 Creating E-CAM

The data that defines the relationship between master/slave (CAM axis) is called E-CAM data.

When using CAM Editor of DIADesigner-AX , it is crucial to know the relationship between master and slave axis position through the two methods described below:

Method 1: Obtains the relationship between master and slave axis position based on E-CAM data setting.

Method 2: Measures the corresponding relationship between master and slave axis position through real task.

When the CAM master and slave relationship is confirmed, the slave position can be obtained based on the master axis position.

• Create DIADesigner-AX CAM tables

(1) Right-click “Application”, choose “Add Object” and then select “CAM Table”.

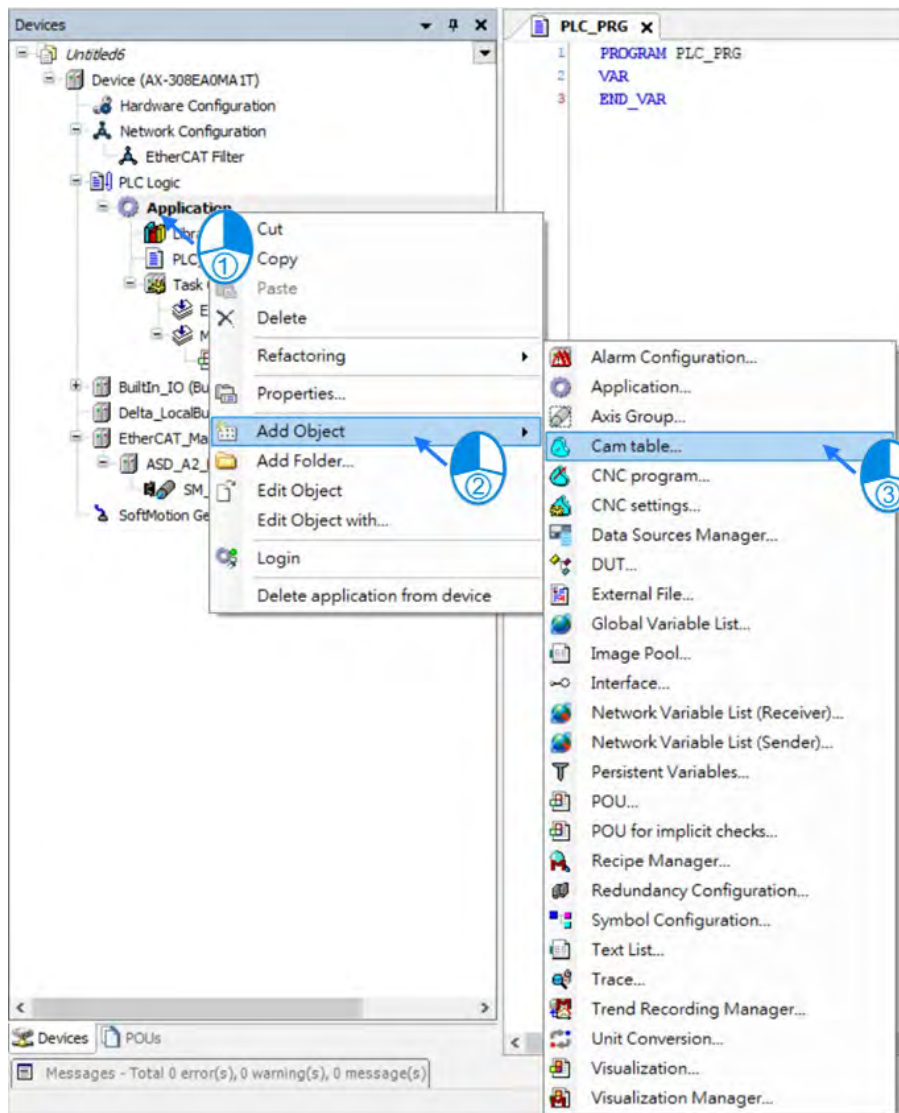

(2) Type the name of the CAM table.

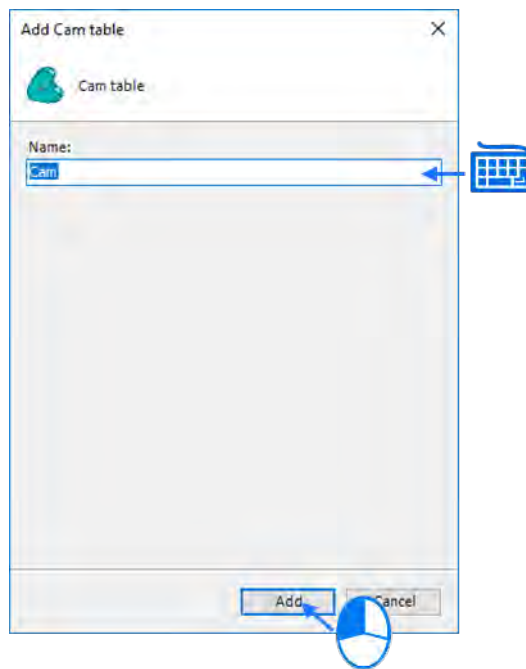

(3) After clicking "Add", CAM icon is shown on the left item box.

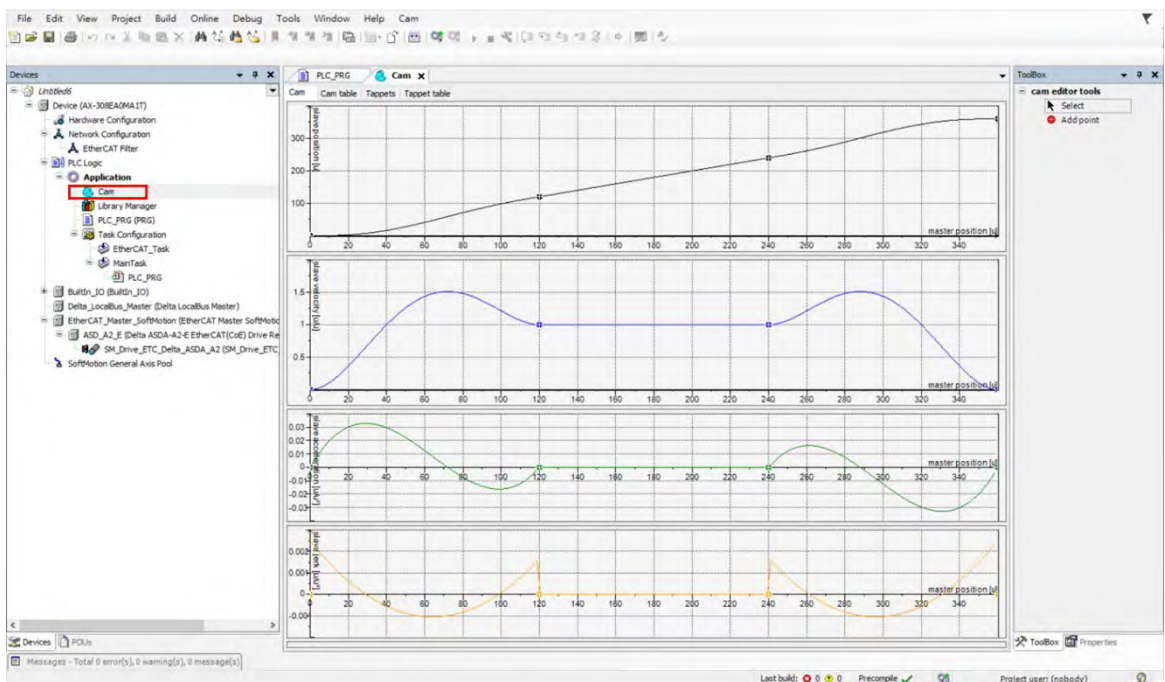

(4) Click “Cam Table” on the CAM page.

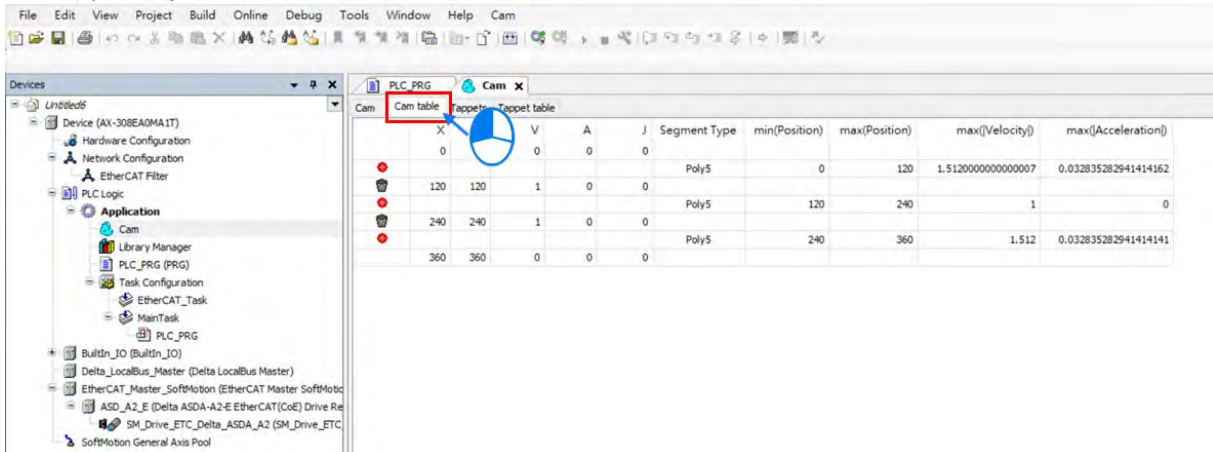

(5) Add or delete CAM data on the CAM Table screen

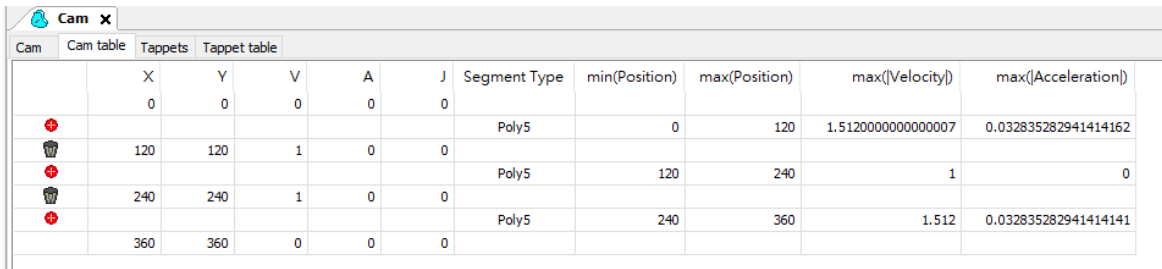

- Click to add new CAM data
- Click to delete CAM data
- X: Position data of master axis
- Y: Position data of slave axis
- A: Acceleration of slave axis
- J: Jerk of slave axis
- Segment Type: Curve type



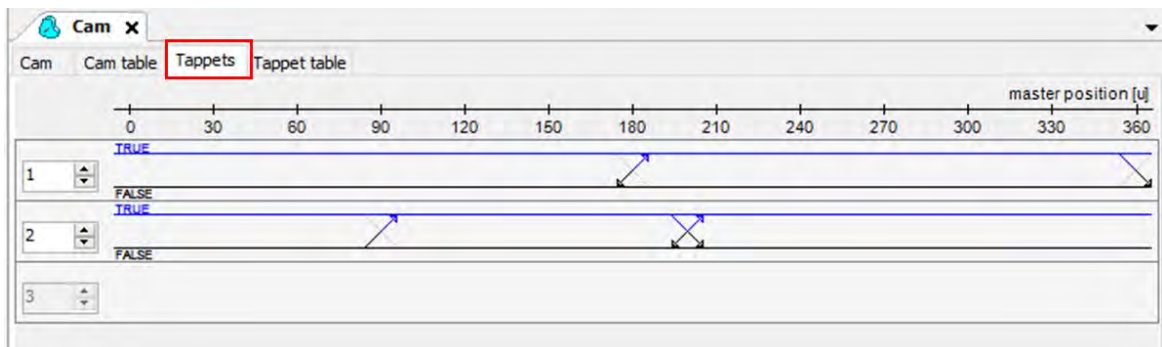





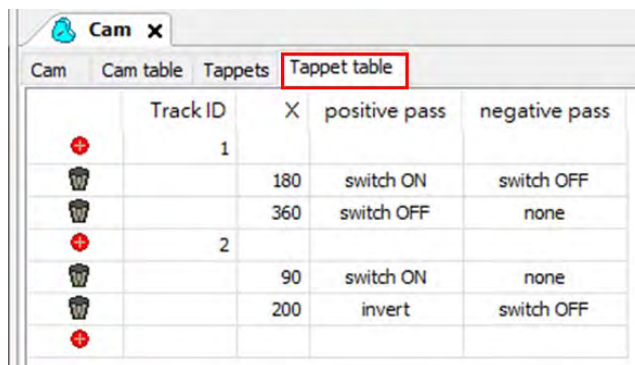

(6) You can configur multiple tappets on “Tappets” page and several tappets can be set for each tappet ID. After finishing setting “Tappet table”, a diagram which illustrates the relation between tappets and master axes would be shown on “Tappets “ page. While moving the points on Tappets page, the setting parameters on Tappet table page would be changed simultaneously.



(7) You can configure tappets on “Tappet table” page and read the status of tappets with SMC_GetTappetValue, which can also be modified according to the settings in “Tappet table” and the direction when CAM master passing the tappets.

- Click  to add new Track ID.
- Click  to delete TrackID.
- Track ID: Tappet ID
- X: Master position
- Positive pass: Axis passes tappets in positive direction, which the setting is as below:
 - ◆ None: No action
 - ◆ Switch to ON: TRUE
 - ◆ Switch to OFF: FALSE
 - ◆ Invert: Opposite direction
- Negative pass: Axis passes tappets in negative direction, which the setting is as below:
 - ◆ None: No action
 - ◆ Switch to ON: TRUE
 - ◆ Switch to OFF: FALSE
 - ◆ Invert: Opposite direction



	Track ID	X	positive pass	negative pass
	1			
		180	switch ON	switch OFF
		360	switch OFF	none
	2			
		90	switch ON	none
		200	invert	switch OFF
				

7.7 Motion Control Functions

7.7.1 System Structure

The single axis motion instructions of MC function blocks can generate specified motion path for axis based on user-defined parameters under three control modes including position control, velocity control, and torque control.

The CANopen over EtherCAT (CoE) protocol is based on standard CiA402 which includes Cyclic Synchronous Position Mode, Cyclic Synchronous Velocity Mode and Cyclic Synchronous Torque Mode (explained in the following sections).

7.7.2 Single-axis Control

7.7.2.1 Cyclic Synchronous Position Mode

The synchronization between AX series controllers and servo drives is implemented via sync signal transmission sent by controllers. These incoming data would not be valid until the Distributed Clocks (DC)* in each servo drives are synchronized. In the following figure, four servo drives receive control data at different timing (t_1 , t_2 , t_3 , t_4) within a synchronous cyclic time (T). However, the data is valid after all servo drives are synchronized with the SYNC event of the distributed clock system.

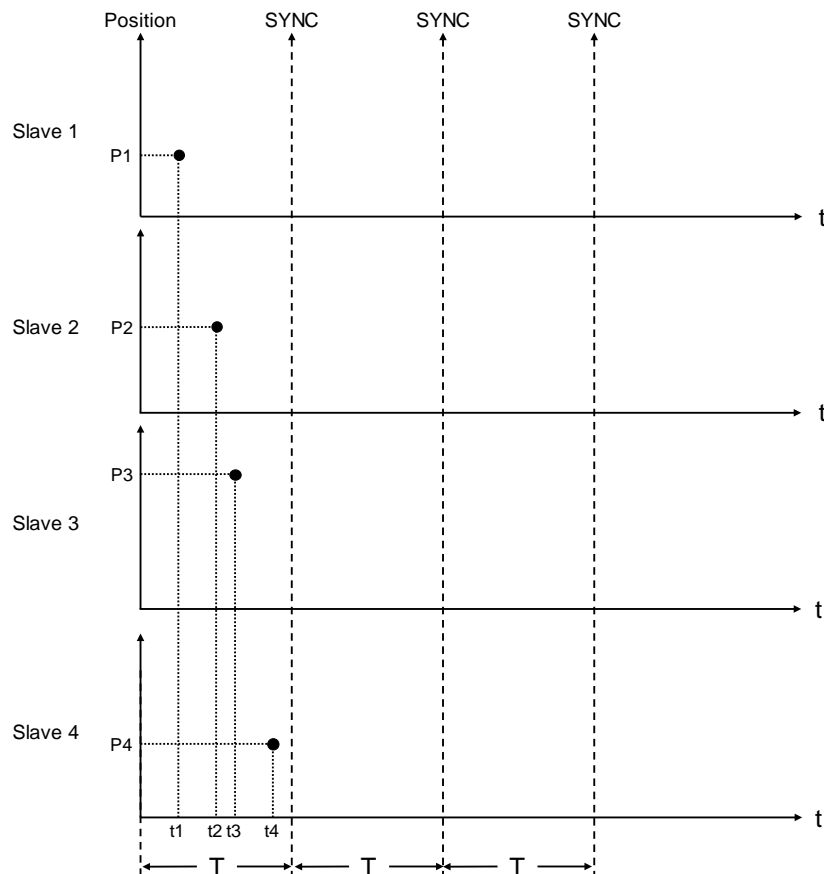

***Note:** Cyclic synchronous position mode is used only for synchronous axes.

7.7.2.2 Profile Position Mode

After the servo drive receives position demands from the master device, the drive controls the motor to reach the target position. Under profile position mode*, at first the master device only inform the drive about configuration relating to target position, velocity command, acceleration, and deceleration. All motion plannings are executed by the trajectory generator inside servo drive, from triggering demand to reaching target position.

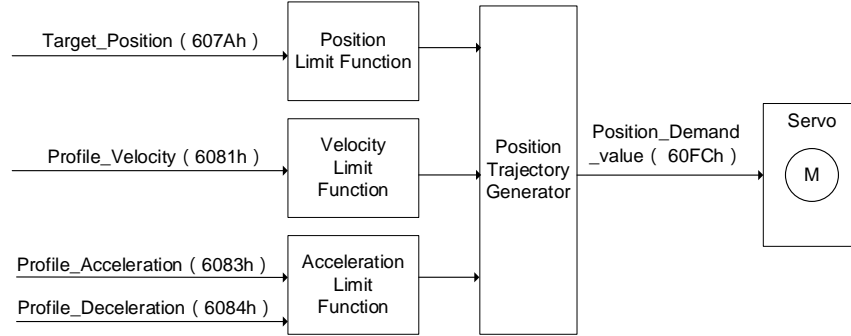

* Profile position mode is only used for positioning axes.

7.7.2.3 Positioning

- **Absolute positioning**

The curves for motion planning allows axis to move to the absolute coordinates of the target position in relation to home. In addition, the absolute positioning range for modulo axis is limited to the range of its cyclic rotation. Please refer to MC_MoveAbsolute function block for more information.

The following figure shows the motion trajectory for absolute positioning.

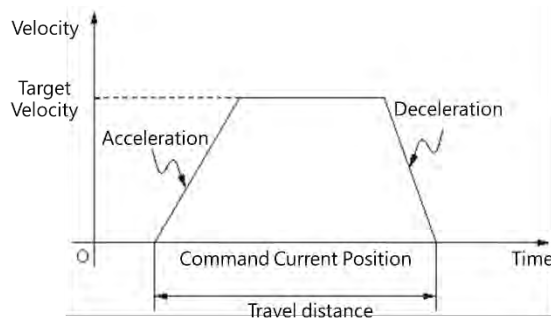

● **Rotary axes setting**

- After choosing “Rotary Axis” for axis type, set the angle of rotation for rotary axis in “Modulo value” area.

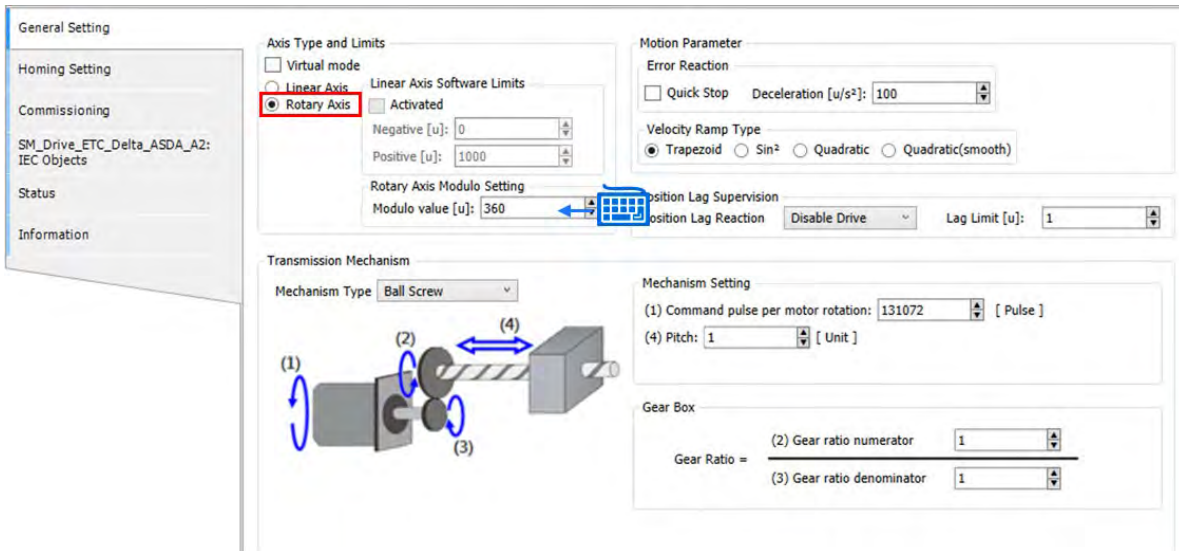

● **Relative positioning**

The curves for motion planning allow axis to move to the relative coordinates of the target position in relation to the actual position. Please refer to MC_MoveRelative function block for more information.

The following figure shows the motion trajectory for relative positioning.

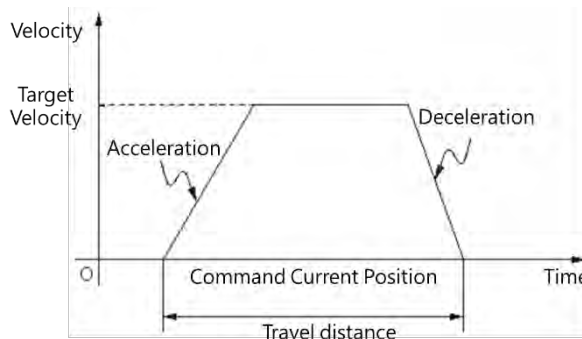

7.7.2.4 Stop Method

The stopping state includes using motion instructions or enabled limit input as well as error stop input to stop axis operation. The stop behavior regarding clear error and limit input differs depending on the servo drives.

■ **Using motion instructions to stop**

To stop single-axis movement, use MC_Stop or MC_Halt instruction.

■ **MC_Stop**

- MC_Stop stops an axis in motion based on specified method and changes the state to “Stopping”.
- The instruction aborts any instructions in execution. When the axis state is “Stopping”, no instructions can be executed.

- The state of “Stopping” continues until velocity reaches 0 or Execute becomes False. When velocity is 0, Done changes to True.
- When Done becomes True and Execute is False, the axis changes to “Standstill” state.

The following diagram shows MC_Stop motion trajectory.

Velocity is determined by specified deceleration (DT).

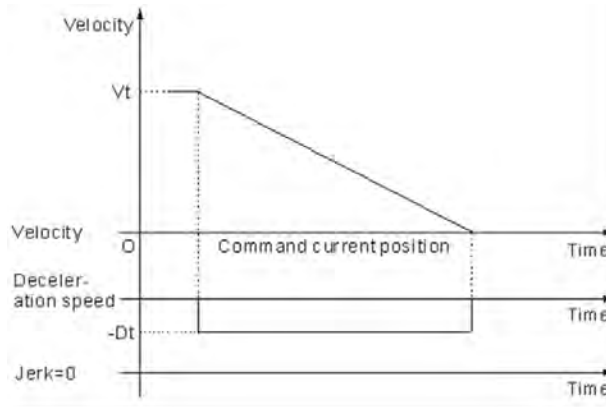

Vt : Velocity before the deceleration slope starts Dt : The specified deceleration rate

MC_Halt

- MC_Halt temporarily stops an axis in motion and changes axis state to “DscreteMotion” until axis velocity reaches 0. When the axis stops, the axis state changes to “Standstill”.
- During axis deceleration, other motion instructions can be executed to immediately abort MC_Halt operation.

Limit input stop

Software limit: You can activate/ inactivate software limit and configure its parameter settings on axis parameter setting page. When the axis is close to software limit during the movement, it will start the deceleration stop based on the axis parameters and stop under the software limit.

The example is shown as below:

- The positive and negative limit are respectively set as 10000 and 0 with “Activated” being selected. Then set 1000 for Deceleration.

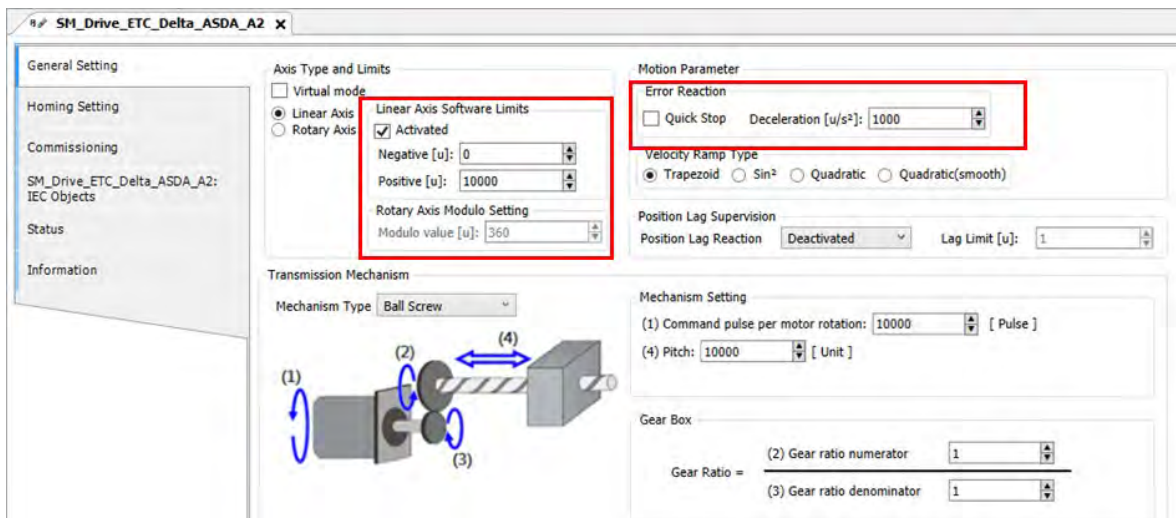

- Use function block MC_MoveRelative and activate the function block when the position reaches 11,000. After the axis moving to about 8,000, Busy of the function block will shift from TRUE to FALSE, while CommandAborted shifts from FALSE to TRUE. The axis then starts to decelerate and stop at the position inside software limit

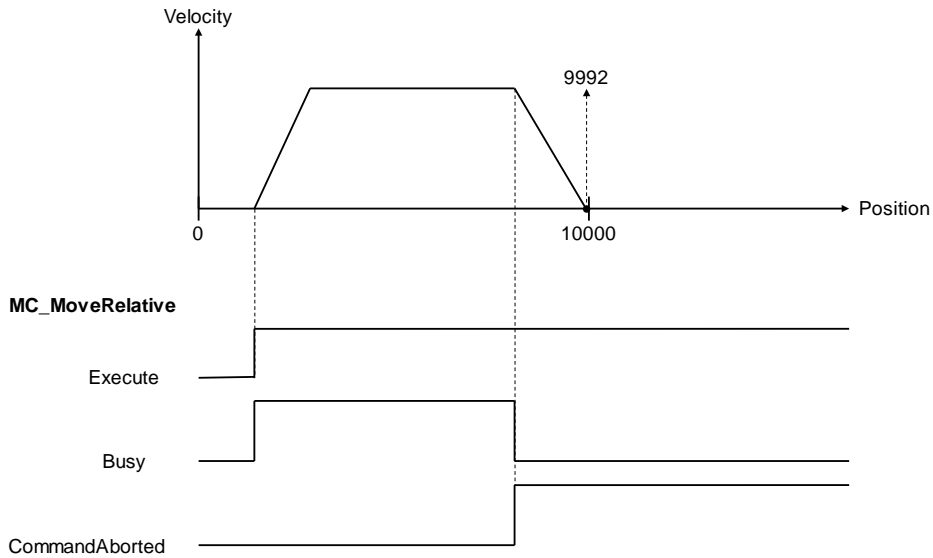

Hardware limit: Since the EtherCAT servo wires carry the hardware limit signals, the stop method for hardware limit may be different between companies and brands. The following description takes Delta ASDA-A2-E servo drive as example:

- Use MC_Jog function block to perform axis rotating in positive direction. Once the hardware limit is reached during the rotation, ASDA-A2-E servo drive will be stopped and report error messages via communication.

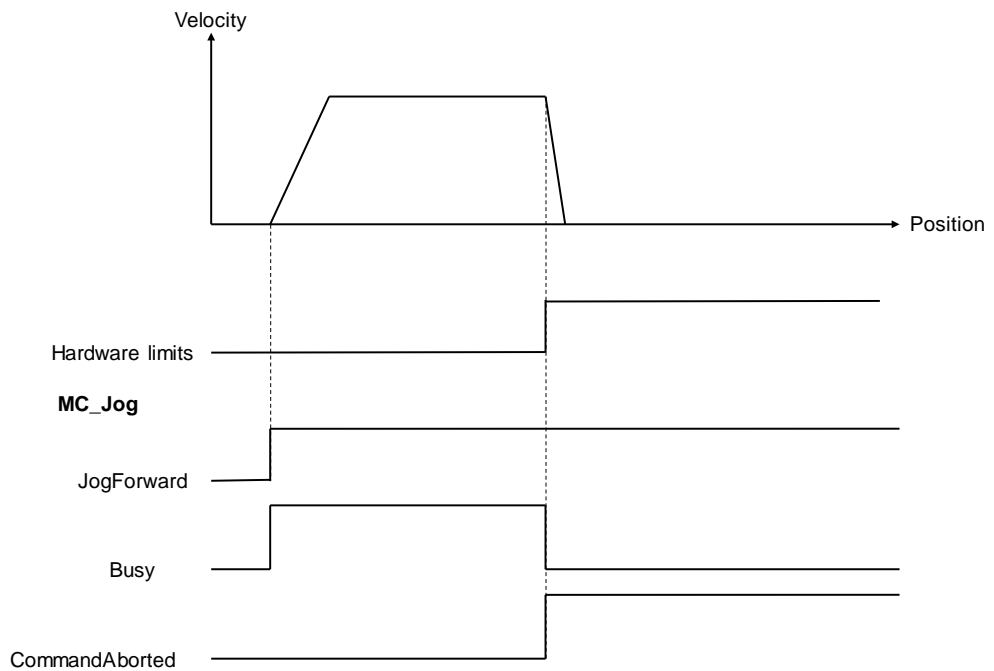

After using MC_Reset to clear errors for reaching software/ hardware limit, the system synchronizes the command position with the values of return position automatically and move away from the direction of limit so as to operate properly.

7.7.2.5 MC_GearIn

Use MC_GearIn instruction to control gear movement and cancel synchronization via MC_Gear Out instruction

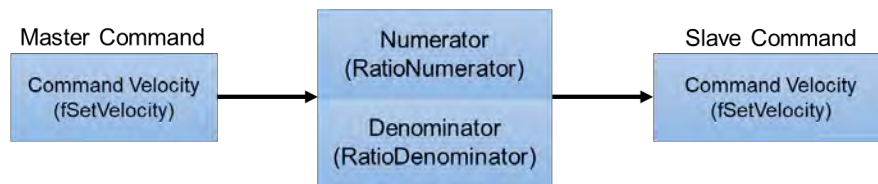

In MC_GearIn, the master and slave axes, gear ratio numerator and gear ratio denominator, acceleration, deceleration as well as jerk are specified.

■ The following diagram shows the execution steps of instructions for electronic gears:

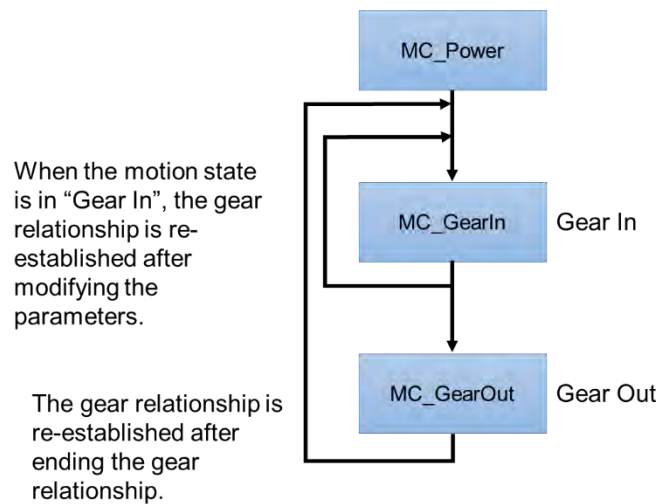

- When executing MC_GearIn, the slave axis enters the state of synchronized motion, while for MC_GearOut execution, the slave axis shifts away from sync state and maintains instant velocity to continue the movement and enters the state of continuous motion.
- During synchronized motion, when executing MC_Stop on the slave axis, MC_GearIn is aborted while master axis maintains the state of continuous motion and the slave axis enters to stopping state that will return to standstill once MC_Stop is Done.
- When slave axis is in synchronized motion state, its velocity may alter according to the master axis velocity and gear ratio.
- When both master and slave axes enters state of synchronization, use MC_SetPosition to prevent motors from generating accidents due to high speed operation.

Using RatioNumerator, RatioDenominator in MC_GearIn to setup the gear ratio between master and slave axes.

- When gear ratio is positive, the master and slave axes are moving in the same direction.

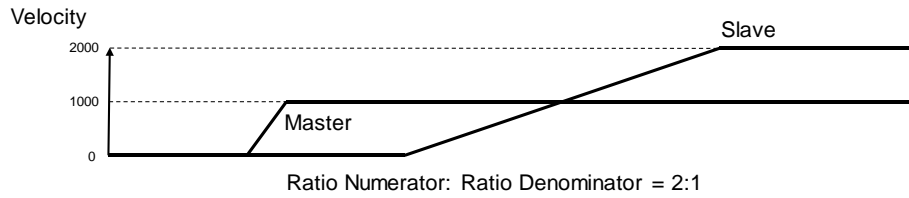

- When gear ratio is negative, the master and slave axes are moving in the opposite direction.

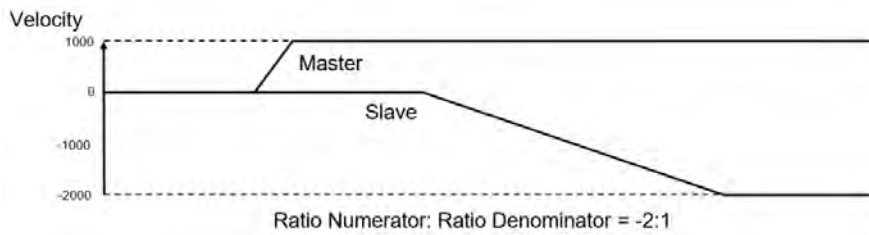

- Synchronization of master and slave axes is completed once slave velocity reaches the setting in the instruction.

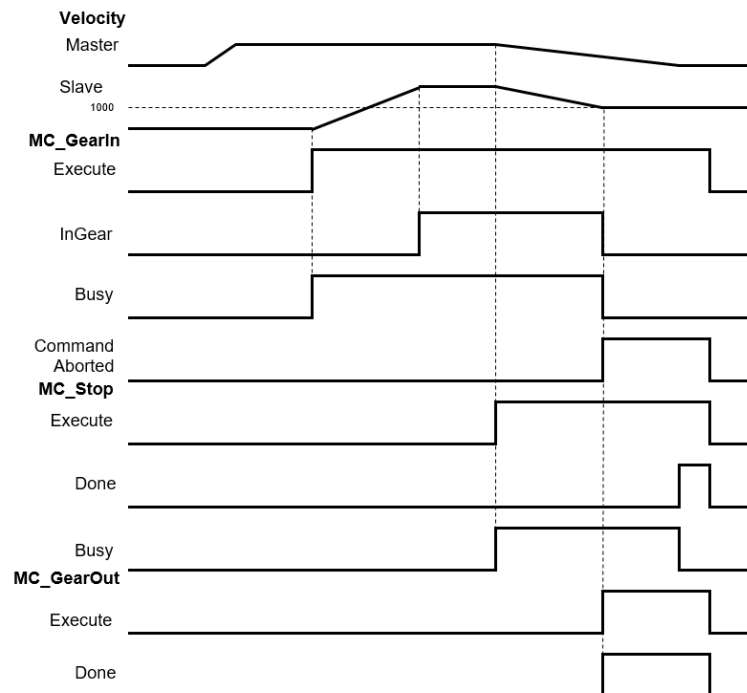

1. When MC_GearIn is enabled, the slave starts to engage with the master axis and the slave velocity is twice the speed of the master velocity (RatioNumerator : RatioDenominator = 2:1).
2. When InGear is True, synchronization of master and slave axes are completed and slave axis is in synchronized motion state.
3. When MC_Stop is enabled, the master axis starts decelerating and the slave axis in sync also decelerates based on the gear ratio.
4. When MC_Stop is operating, MC_GearOut is enabled, the sync between master and slave axes is aborted but maintains that velocity and is in continuous motion state.

7.7.2.6 MC_GearInPos

You can adopt MC_GearInPos to assign the synchronous starting positions of master and slave axis.

MC_GearInPos sequence

The assigned master and slave, gear ratio numerator and denominator, synchronous starting positions of master and slave axis in MC_GearInPos executes the master start distance in sync as well as whether or not to permit reversal. The function block engages both master and slave axis in the assigned position based on the curve of the slave axis.

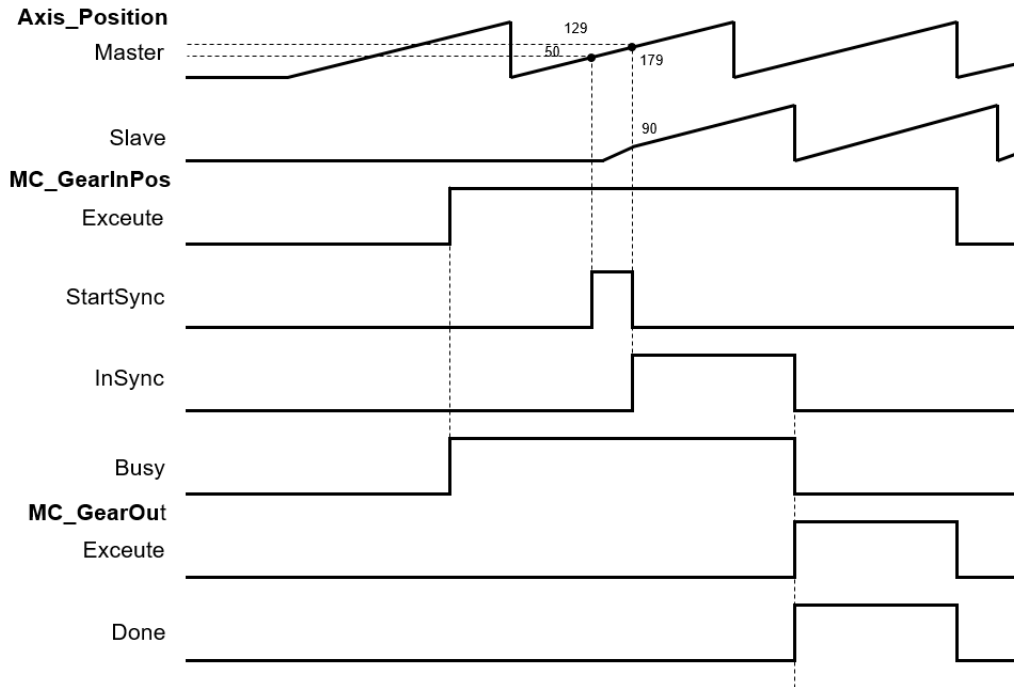

- The master axis starts to execute sync position as $\text{MasterSyncPosition}(180) - \text{MasterStartDistance}(50)$; When the axis reaches to that position, StartSync is True.
- The slave axis generates a motion curve based on other parameters; When the master reaches MasterSyncPosition(180) and the slave axis also reaches SlaveSyncPosition(90), the StartSync is False and InSync is True.
- When $\text{MasterStartDistance} \leq 0$, the function block executes and synchronization is completed; Meanwhile, the slave axis position will move up and down to the assigned sync position.
- When slave reversal is not permitted, you need to set AvoidReversal to True.

7.7.2.7 MC_CamIn

The slave axis follows the master axis for synchronized motion based on CAM table. The master and slave axes are assigned via the pre-assigned CAM table (MC_CamTableSelect). Use MC_CamIn for CAM engagement, and MC_CamOut to remove gear engagement.

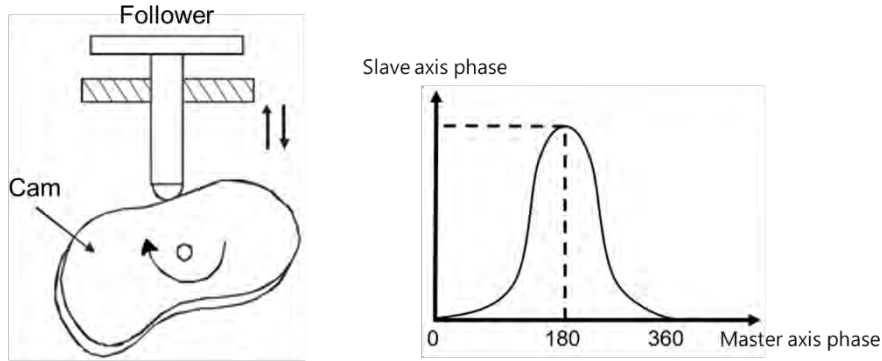

After the engagement, synchronization between master and slave axis is completed successfully and the state of slave axis is Synchronized Motion. The following is the information about creating E-CAM:

- **Initial setting**

- Create E-CAM data

The following two methods can create E-CAM curve data:

Method 1: Master and slave positions are determined base on standard functions.

Method 2: The corresponding relationship between master and slave base on actual measurement.

- **E-CAM master and slave setting and operation**

By using MC_CamIn and MC_CamTableSelect, E-CAM slave and master as well as basic operation setups can be completed.

- Master and slave source setting

In MC_CamTableSelect and MC_CamIn function blocks, the master input pins determines the master source while slave input pin determines the slave source.

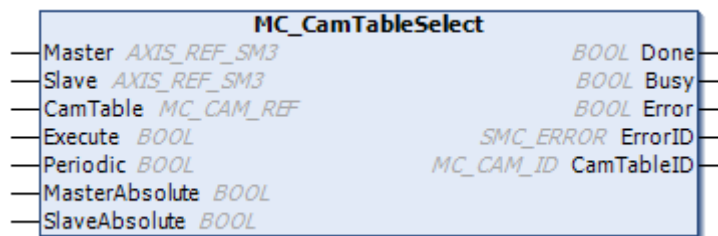

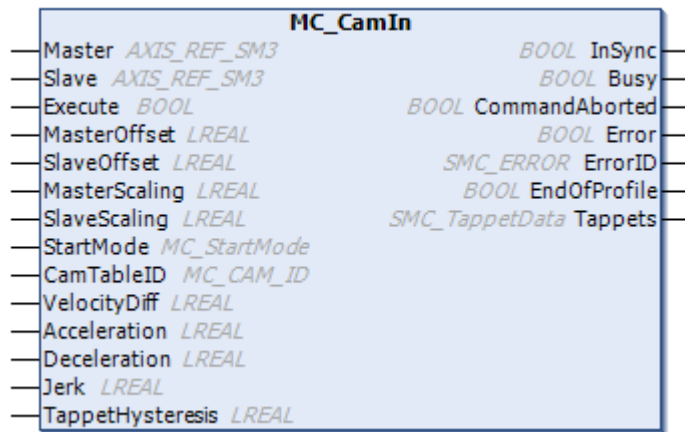

***Note:** For more details of pins definition, please refer to **AX Series Motion Controller Manual**.

- Master as external pulse counter

The sources of E-CAM master include actual and virtual axes as well as the counter. When using the external counter as master's source, use DMC_HCnt function block.

- System structure and DMC_HCnt

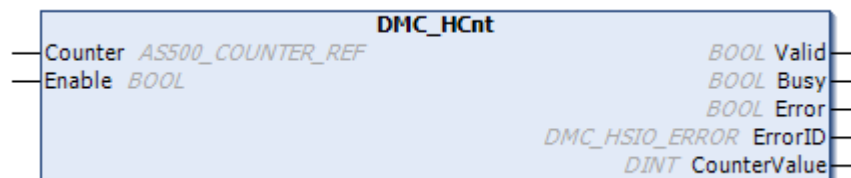
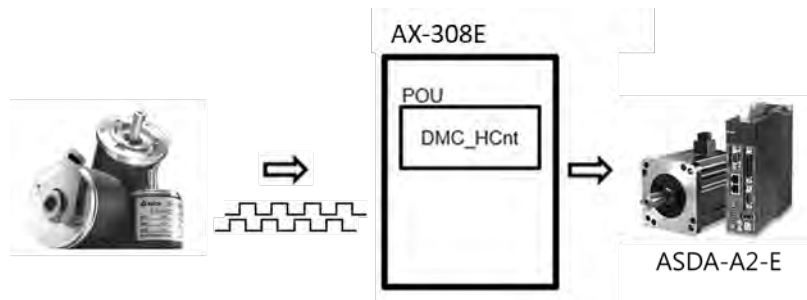

- Relationship between master and slave positions

By using the software to pre-define the relationship between CAM master and slave positions, the positions in the CAM table rather than actual axis positions define the phase of the master and slave axes. When the pre-planned CAM mechanism defined as CAM function, the input is the CAM master phase and the output is the CAM slave phase. For example:

x: CAM master phase ; y: CAM slave phase

$$y = \text{CAM}(x)$$

The CAM phase derives from the axis position and conversion may take place. The conversion between axis position and CAM phase is related to parameters including MasterAbsolute, SlaveAbsolute, MasterOffset, SlaveOffset, MasterScaling and SlaveScaling. The slave follows the master axis to perform synchronized motion under MC_CamIn instruction. The relationship between master and slave positions should be based on the pre-planned CAM relationship (relation curve or CAM table). The process of calculating slave position from the master position is shown below:

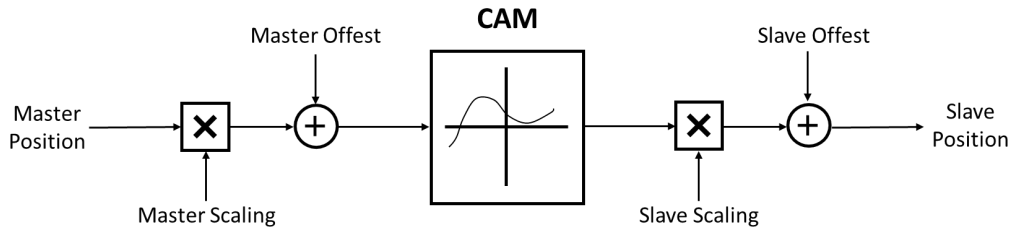

The above diagram resulted in the following calculation method:

$$\text{Position_Slave} = \text{SlaveScaling} \times \text{CAM} (\text{MasterScaling} \times \text{MasterPosition} + \text{MasterOffset}) + \text{SlaveOffset}$$

When master is in absolute mode, the current master position is the arithmetic result of the rotating axis; when in relative mode, the master position is the starting point (usually 0) in corresponsence to CAM.

- Relationship between Startmode and MasterAbsolute, SlaveAbsolute in CamTableSelect
 - Absolute mode (StartMode=0): When E-CAM synchronization starts, the CAM calculation and current slave position is irrelevant. When current slave position is different from the starting position that is calculated, then Jump is generated.
 - Relative mode (StartMode=1): CAM changes based on current slave positions; the slave positions are added from its current position. When the engaging position of the slave is different from the starting position plus the current position that is calculated, then Jump is generated.
 - Ramp mode (StartMode = 2, 3, 4): Add a curve of motion compensation based on VelocityDiff, Acceleration, Deceleration, Jerk to prevent the Jump during CAM engagement.

MC_CamTableSelect.MasterAbsolute	Master mode
absolute	Absolute mode
relative	Relative mode

MC_CamIn.StartMode	MC_CamTableSelect.SlaveAbsolute	Slave mode
absolute	True	Absolute mode
absolute	False	Relative mode
relative	True	Relative mode
relative	False	Relative mode
ramp_in	True	Ramp in absolute mode
ramp_in	False	Ramp in relative mode
ramp_in_pos	True	Positive ramp in absolute mode
ramp_in_pos	False	Positive ramp in relative mode
ramp_in_neg	True	Negative ramp in absolute mode
ramp_in_neg	False	Negative ramp in relative mode

- Offset and scaling (MasterOffset/MasterScaling/SlaveOffset/Slavescaling)

Since the CAM mechanism between master and slave are pre-planned, when executing CAM, you can adopt Offset and Scaling parameters to pre-plane position offset or scaling. For example, the processing product has different dimensions, but only one CAM mechanism is required for programming, therefore, by changing offset and scaling parameters, the switching of processing products amongst different dimensions can be adjusted. You can input specific scaling values for master scaling of CAM and slave offset. The master and slave can setup offset and scaling values accordingly.

The master and slave offset and scaling both determine the actual CAM in relation to the effect that is described in the following example. The diagram below demonstrates pre-planned CAM mechanism:

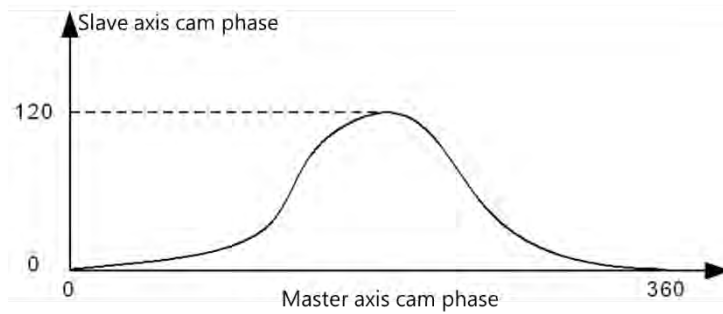

When master and slave are both in absolute mode and executes engagement, both master and slave positions are 0; when not using offset and scaling (default value), the following diagram shows the actual corresponding relationship between master and slave during the process of executing CAM:

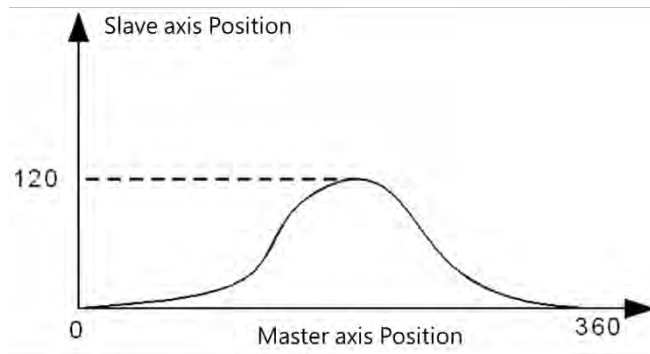

When position offset or scaling is not in default value, the following diagrams show the effects of the corresponding relationship between master and slave actual positions during CAM execution:

For master and slave offset as 0, the effects from scaling of master and slave for actual CAM execution

Situations:

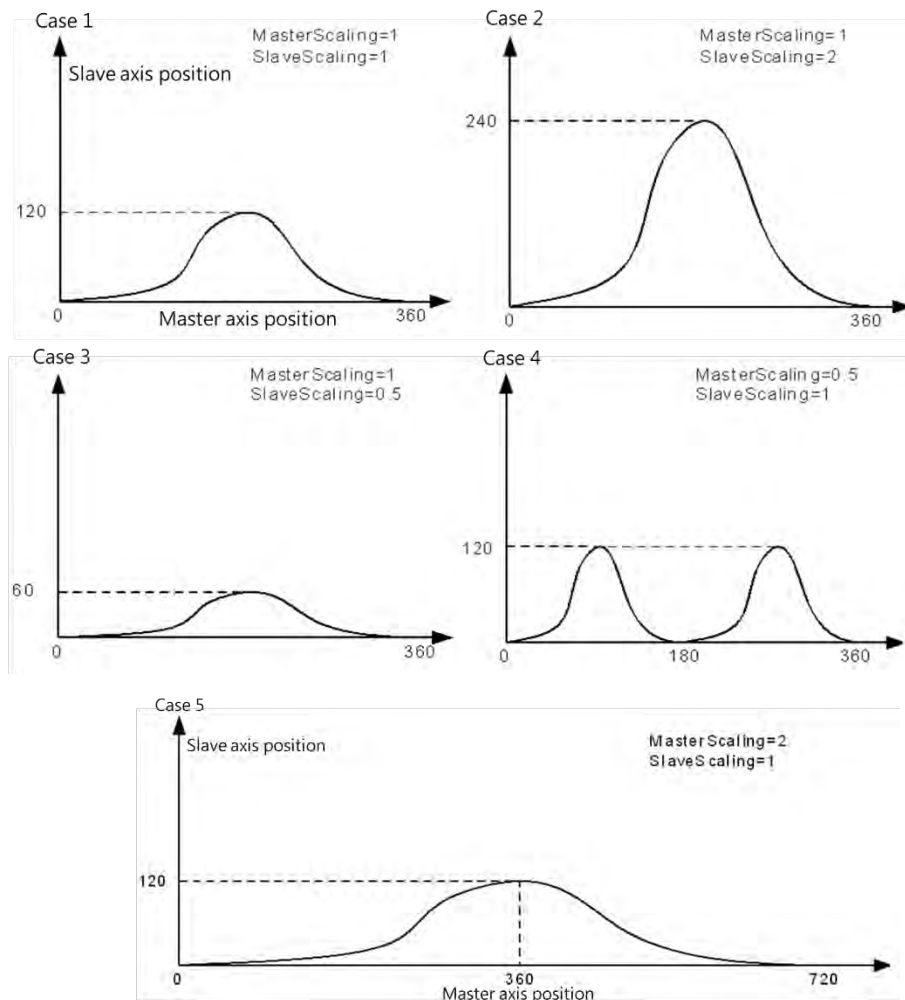

- Situation 1: When scaling ratio for master and slave is 1, offset is 0, the actual CAM mechanism is the same as pre-planned.
- Situation 2: When master scaling ratio is 1, slave scaling ratio is 2 and offset for both axes is 0, the slave position that corresponds to the master position is twice the amount of pre-planned measurement.
- Situation 3: When master scaling ratio is 1, slave scaling ratio is 0.5 and offset for both axes is 0, the slave position that corresponds to the master position is half the amount of pre-planned measurement.
- Situation 4: When master scaling ratio is 2, slave scaling ratio is 1 and offset for both axes is 0, the master position that corresponds to the slave position is twice the amount of pre-planned measurement. From CAM phase perspective, the Master CAM is twice the amount of pre-planned measurement, meaning the Master CAM changes from 360 to 180, while Slave CAM phase remains the same.

Situation 5: When master scaling ratio is 0.5, slave scaling ratio is 1 and offset for both axes is 0, the master position that corresponds to the slave position is half the amount of pre-planned measurement. From CAM phase perspective, the Master CAM is half the amount of pre-planned measurement, meaning the Master CAM changes from 360 to 720, while Slave CAM phase remains the same.

The scaling ratio for master and slave is 1 and the CAM effect when executing actual master and slave offset. The master offset means that the position curve of actual axis position moves horizontally during CAM execution; the slave offset means that the position curve moves vertically during CAM execution.

Situations:

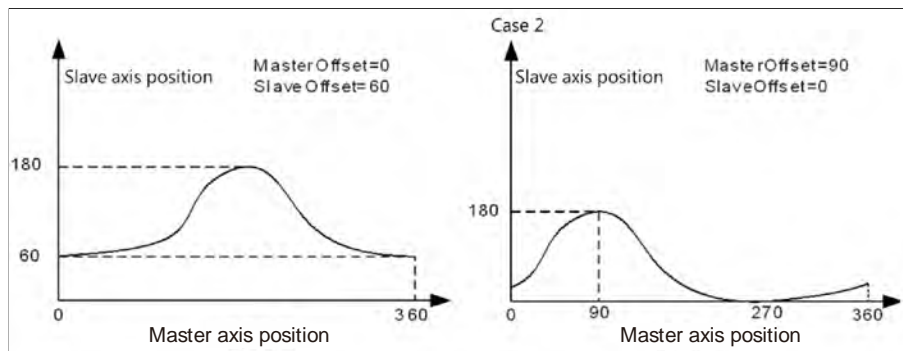

Situation 1: When the scaling ratio of master and slave is 1, the master offset is 0 and the slave offset is 60, the slave position that corresponds to the master position need to add 60 based on the pre-planned measurement. For instance, the master position is 180 and corresponds to the slave position that is 180 in CAM mechanism, but the slave position is 240 ($240=180+60$) during actual execution.

Situation 2: When the scaling ratio of master and slave is 1, the master offset is 90 and the slave offset is 0, the master position that corresponds to the slave position offsets by 90 (adding offset value) based on the pre-planned measurement. For instance, the master position is 180 and corresponds to the slave position that is 180 in CAM mechanism. However, during actual execution, the master position is 90 and corresponds to the slave position of 180, meaning the slave position corresponds to the master position that is 180 ($180=90+90$) in pre-planned CAM mechanism.

- **CAM table**

By selecting CAM in **DIADesigner-AX** project tree, you can edit the CAM curve that determines the operating characteristics of CAM.

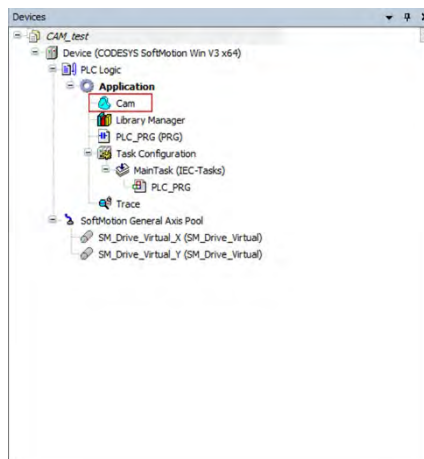

- **Features of CAM table**

- ◆ Direct observation on the changes of CAM curves in corresponds to the slave motion range, velocity, acceleration, and jerk at any time.
- ◆ The master starting coordinate by default begins from 0 and ends at 360. You can make modifications based on real physical range

- **Editing method for CAM curves**

◆ **Graph editing on DIADesigner-AX**

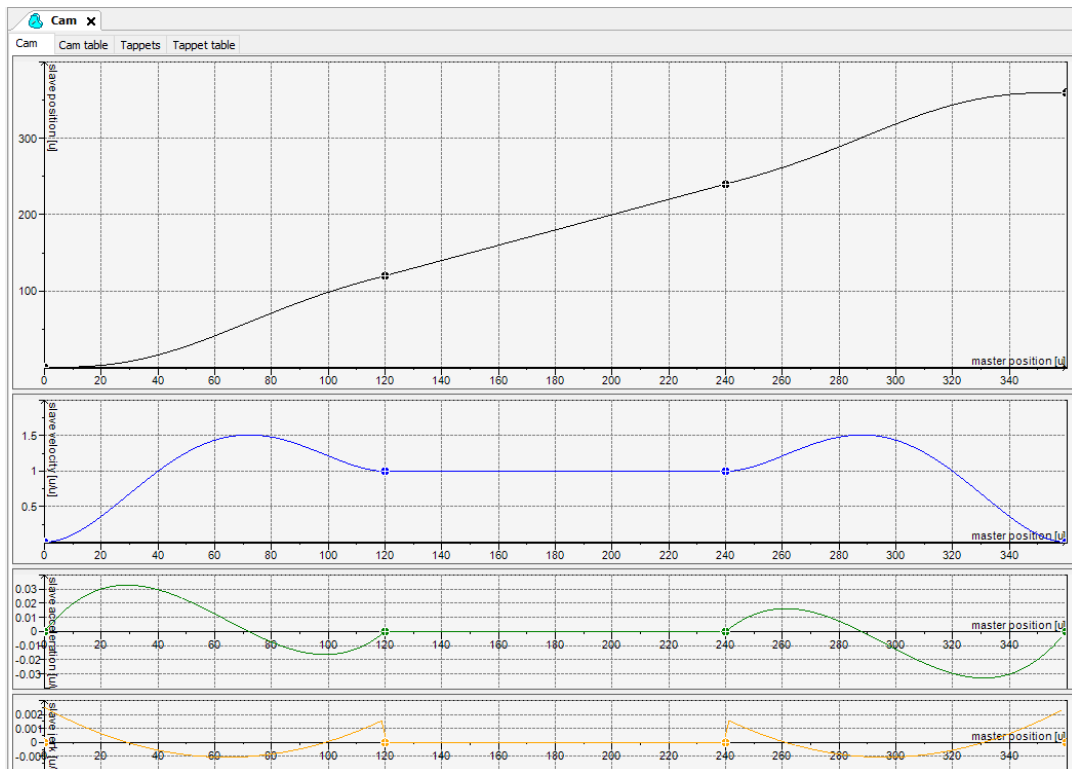

You adopt graphs to edit CAM table, horizontal coordinates as master position and master axis length to determine CAM operating range. The four kinds of curves shown in the page (see below) represents position, speed, acceleration and jerk. When designing CAM, position and speed curve can be used to make motion range adjustment, while adjusting acceleration curve allows stabilization in movement.

◆ **CAM table editing on DIADesigner-AX**

Besides using graphs for editing, the CAM table is also used to modify any increase or decrease on critical points and positions directly on the CAM table page

Cam X											
Cam	Cam table		Tappets	Tappet table			Segm...	min(P...	max(P...	max(V...	max(A...
	X	Y	V	A	J						
	0	0	0	0	0						
+							Poly5	0	120	1.5120...	0.0328...
+	120	120	1	0	0		Poly5	120	240	1	0
+	240	240	1	0	0		Poly5	240	360	1.512	0.0328...
+	360	360	0	0	0						

◆ **Programming editing**

You can also adopt programming to make modifications regarding critical points on the CAM table. To modify a program (see below), the starting position (master, slave) of CAM table moves from (0,0) to (0, 30), but image displayed in the software will not be changed.

For using DMC_CamWritePoint function block to modify CAM table in programming, descriptions are as follows:

- ①Assigned CAM table
- ①Execute function blocks
- ②Choose the CAM point number to read
- ③Position of the CAM master axis
- ④ Position of the CAM slave axis
- ⑤Velocity of the CAM slave axis
- ⑥Acceleration of the CAM slave axis

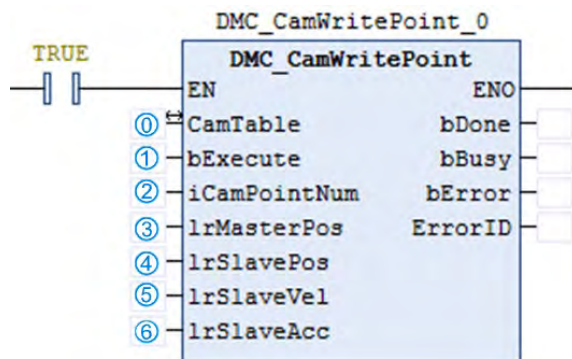

***Note:** For more details of function blocks, please refer to **AX Series Motion Controller Manual**.

• **CAM table properties:**

In Properties window, you can adjust the properties regarding CAM table. For example, the starting and ending position of master and slave, periodic parameters setups, required curve continuation and editing formats.

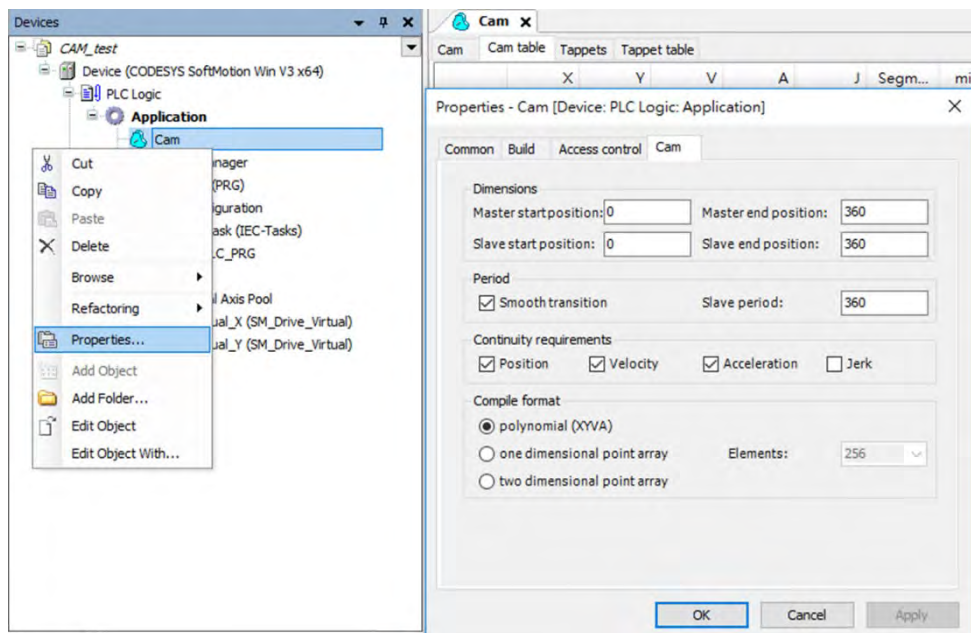

- **Steps on using E-CAM:**

1. CAM table configuration: setup master range, slave range, create starting point, ending point and other critical points as well as curve type adjustments.
2. Use instruction MC_CamTableSelect to connect configured CAM table with the actual one and receive CAM ID to be used for later instructions.
3. After receiving CAM ID, use instruction MC_CamIn to execute engagement for assigned master and slave.
4. Use instruction MC_Camout for the master and slave relationship disengagement. For synchronous movement, use instruction MC_Stop and MC_Halt on slave axis for disengaging synchronous relation between master and slave.

- **Switching of CAM tables:**

When CAM table is operating, please refer to MC_CAM_REF for switching the CAM table of MC_CamTableSelect.

- Declaring variables

```
P : MC_CAM_REF; //CamTable reference
CamTableID : INT; //CamTable Switch
```

- Switching of CAM tables

```
CASE CamTableID OF
  0: P:=Cam;
  1: P:=Cam_1;
END_CASE
```

In the programming examples shown above, use the switching of CamTableID to change MC_CAM_REF to achieve switching of multiple CAM tables.

Below are the two CAM tables:

- The first Cam table

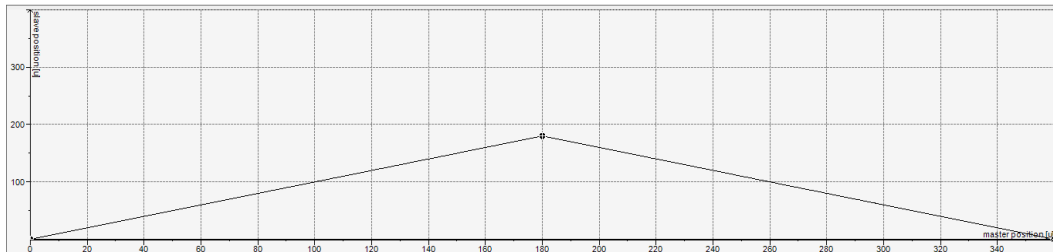

- The second Cam table (Cam_1)

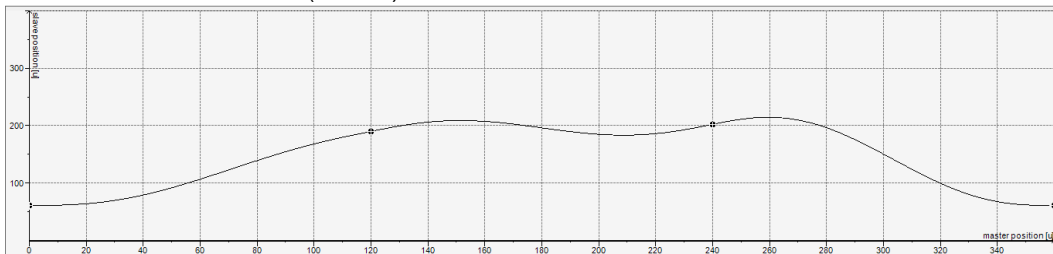

- Timing diagram for switching of Cam table

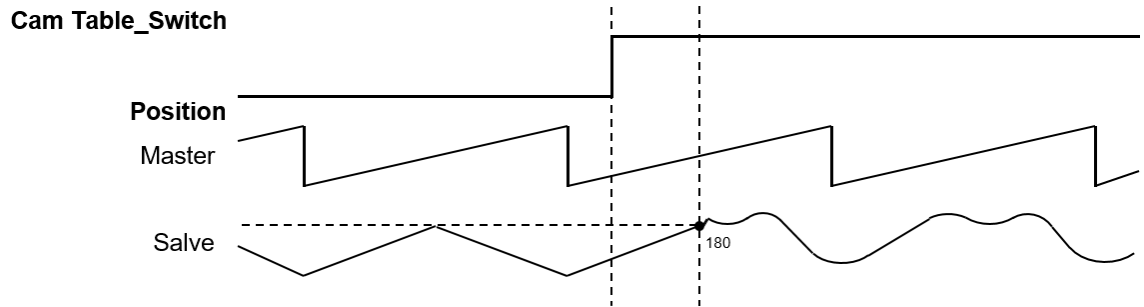

When switching Cam tables, the slave moves along the motion path based on the first CAM table until the master position reaches to the next critical point and then start to follow th motion path based on the second.

7.7.3 Velocity Control

There are three kinds of motion control modes, the Cyclic Synchronous Position (CSP), the Cyclic Synchronous Velocity mode (CSV), and Profile Velocity mode (PV).

7.7.3.1 CSP Mode

The CSP mode is described as cyclic synchronous position in section 7.7.2.1. Under this mode, the controller can calculate the position of a command per cycle based on assigned velocity (including acceleration, deceleration and jerk) then send this command to the servo for execution.

In CSP mode, when external interference causes the current servo position to lag behind the position command of the controller, vibrations may appear as a result to compensate these position errors.

The use of motion instruction MC_MoveVelocity can execute velocity and motion control in CSP mode. When executing, the axis state enters continuous_motion state. The assigned acceleration, deceleration and jerk can be set during velocity adjustment (before reaching assigned velocity or during buffering). MC_Stop and MC_Halt or other motion instructions can be used to stop the control mode when needed.

The following diagram uses MC_MoveVelocity to proceed velocity and motion control, as well as MC_Halt for discontinue in the timing diagram:

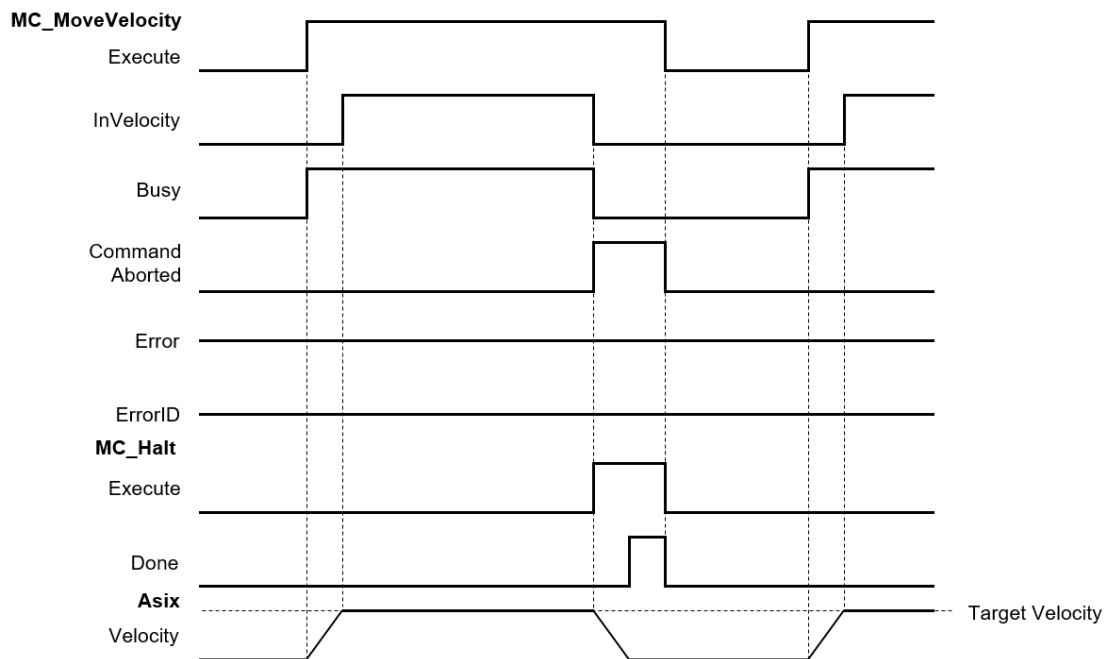

Assign velocity to 0, though the current movement is static but the system will be in continuous_motion status.

In AX series, use instruction MC_MoveVelocity to execute velocity control for single axis in CSP mode. Please refer to **AX Series Motion Controller Manual** for more function block details.

7.7.3.2 CSV Mode

The CSV mode is the cyclic synchronous velocity mode (CSV). Under this mode, the controller can calculate the velocity for per cycle based on the assigned velocity (including acceleration, deceleration and jerk) then send this command to the servo for execution.

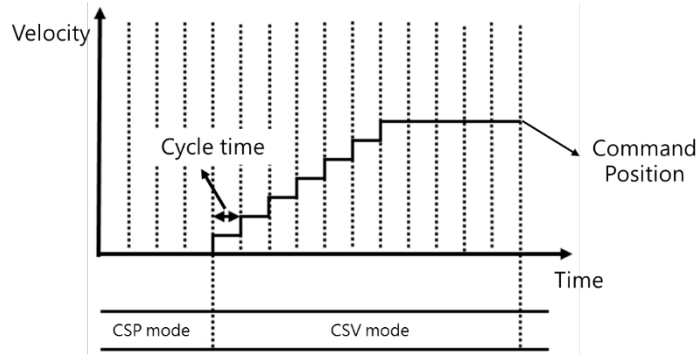

Despite external interference, cyclic velocity commands in CSV mode are send to servos that are unlikely to cause vibrations due to compensating positions found in CSP mode.

In AX series, use instruction MC_VelocityControl to execute velocity control for single axis in CSV mode. Please refer to **AX Series Motion Controller Manual** for more function block details.

7.7.3.3 Profile Velocity Mode

Under this mode, velocity trajectory generator performs motion path planning based on conditions assigned by master devices, such as velocity command and acceleration as well as deceleration.

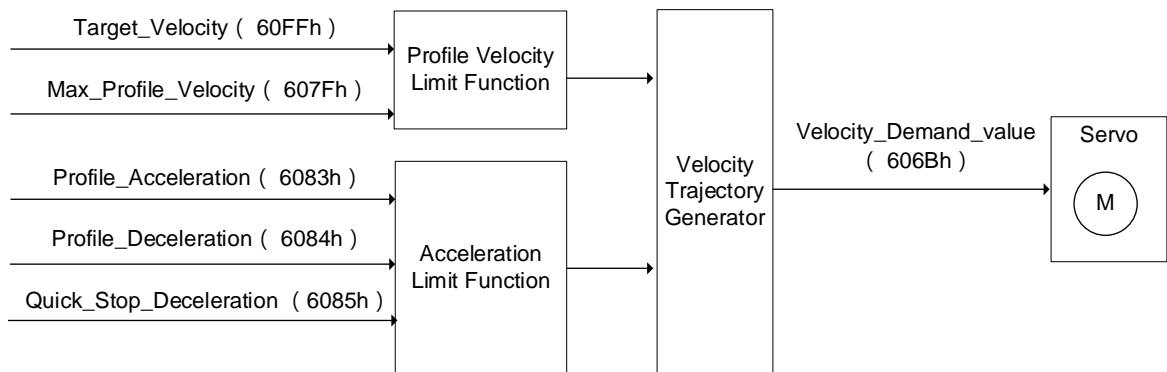

***Note:** Profile Velocity mode is used for positioning axes.

7.7.4 Torque control

Torque control can be categorized into Cyclic Synchronous Torque mode (CST) and Profile Torque mode (PT).

- Profile Torque mode* (PT)
 - Use DMC_TorqueControl to generate assigned torque output continuously through single axes.
 - Notification
 - When using DMC_TorqueControl, switch the control mode to cyclic synchronous torque mode.
 - When using MC_TorqueControl, the control mode switches to torque mode and cannot use function blocks regarding shifts or velocity. Use MC_TorqueControl Enable instead of MC_Stop to stop motors.
 - Do not set Torque to 0, when setting is 0, MC_TorqueControl is reported as error.
 - Use the velocity of DMC_TorqueControl to set the maximum velocity limit for servo motors which avoids high speed rotation as motor load declines in torque mode.
 - Adopt TorqueRamp to achieve the target torque value.
 - When Torque is bigger than 0 (Torque > 0), the motor operates in positive direction.

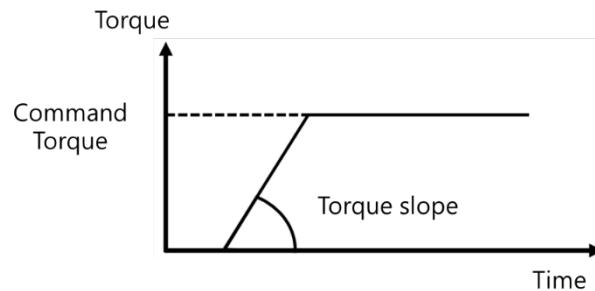

- When Torque is smaller than 0 (Torque < 0), the motor operates in negative direction.

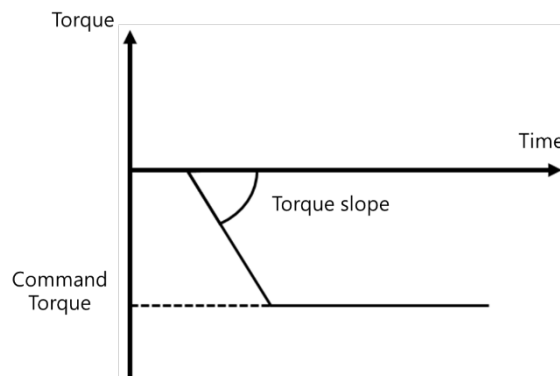

Note:

*1: ASDA-A3-E Series V1.1165 or later supports Profile Torque Mode.

*2: ASDA-B3-E Series V1.0665 or later supports Profile Torque Mode.

7.7.5 Common Functions for Single-axis Control

The common functions for single-axis control are described in the following section.

7.7.5.1 Command Position

- Types of positions

The axis motion function modules adopt the following two types of positions.

Type of position	Meaning
Command position	The position that MC function modules outputs to control an axis.
Actual position	The position as feedback from the servo drive*

***Note:** For virtual axis, there is no position feedback from the servo drive, so the command position will replace the actual position.

The following figure shows the relationship between the command position and actual position:

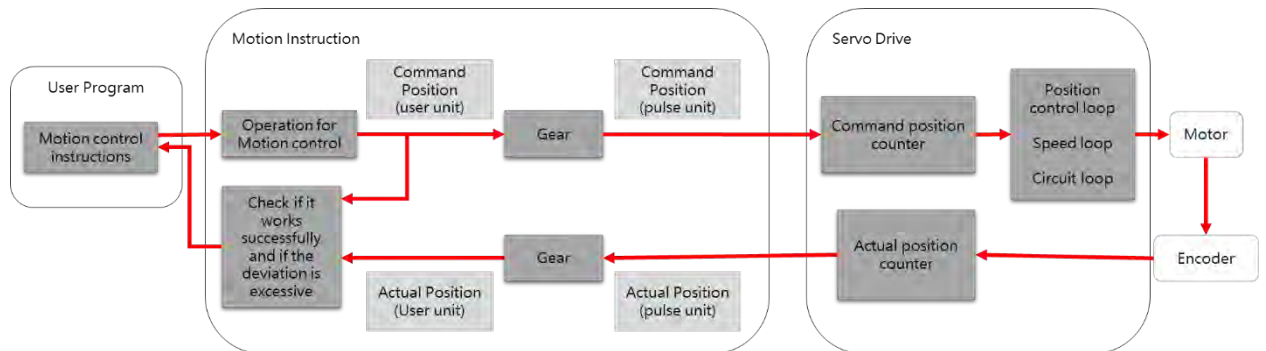

A comparison between the command position and actual position:

Item	Command position	Actual position
Count mode	Linear axis / rotary axis	The same count mode setting as in command position
Command unit	Length unit (m, mm, inch...) / angle unit (degree) / ...	The same unit setting as in command position
Software limits	Set the range limit for MC function modules	The same range limit setting as in command position
Positioning	Change to any desire position within the range limit	The same position setting as in command position, but position lag may appear*

***Note:** Due to the settings of servomechanism, the so-called position lag may be generated between command and actual positions. As motion velocity increases, position lag also increases slightly. When limiting the lag, you can adjust axis setting to monitor the position lag and set operation for position lag being too large. For virtual axis, actual position equals to command position and position lag does not exist.

Descriptions for the relevant parameters are as follows:

● **Position unit**

The unit refers to “command unit”.

● **Position lag**

Setting	Value	Meaning
Position lag supervision	Deactivated	Position lag not checked
	Disable drive	When position lag exceeds the limit, the axis is in servo off.
	Do quick stop	When position lag exceeds the limit, the axis is in quick stop.
	Stay enabled	When position lag exceeds the limit, the axis maintains servo on.
Lag limit [u]	LREAL	Allowable lag limit

Besides deactivated setting value, when other settings exceeds lag limits, the axis reports error as in SMC_ERROR.SMC_DI_POSITIONLAGERROR.

● **Software limits**

Setting	Value	Meaning
Software limits Activated	Checked / Unchecked	Whether or not software limits is activated.
Negative [u]	LREAL	Negative software limit
Positive [u]	LREAL	Positive software limit

● **Description of positions in MC function modules**

Please take note of the following input variables with two different interpretations that are related to positions in MC function modules:

Item	Meaning
Position	Target position (absolute position)
Distance	Moving distance (relative position)

● **Monitoring positions**

To observe change in position, you can focus on the following two axis variables (AXIS_REF_SM3 type) for monitoring:

Variable name	Position type	Data type
.fSetPosition	Command position	LREAL
.fActPosition	Actual position	LREAL

7.7.5.2 Velocity Command

● Types of velocity

The following two types of velocity are used in MC function modules.

Position type	Meaning
Command velocity	The velocity in which MC function module outputs for axis control
Actual velocity	The velocity based on the actual feedback position of servo drives at each point in time*

***Note:** For virtual axis, there is no position feedback from the servo drive, so the command position will replace the actual position.

● Velocity unit

The velocity unit is “command unit/s”.

● Velocity ramp type

Setting	Value	Meaning
Velocity ramp type	Trapezoid	A trapezoidal velocity ramp (Each section is constant acceleration)
	Sin ²	The velocity ramp equals to sin ² function (acceleration ramp is fixed)
	Quadratic	Acceleration ramp with trapezoidal profile (jerk limited)
	Quadratic (smooth)	Adopts the same meaning as in Quadratic, but with continuous S-curve velocity (jerk limited).

● Description of velocity in MC function modules

The following input variable that is related to velocity in MC function modules:

Item	Meaning
Velocity	Target velocity*

***Note:** Due to inadequate trajectory length, small acceleration and jerk as well as other factors, it is not possible to obtain the target velocity.

● Monitoring velocity

To observe change in velocity, you can focus on the following two axis variables (AXIS_REF_SM3 type) for monitoring:

Variable name	Position type	Data type
.fSetVelocity	Command velocity	LREAL
.fActVelocity	Actual velocity	LREAL

7.7.5.3 Acceleration and Deceleration Command

● **Types of acceleration**

The following two types of acceleration are used in the MC function modules.

Position type	Meaning
Acceleration command	The outputs of MC function modules to control axis acceleration
Actual acceleration	The acceleration calculated based on actual velocity

● **Acceleration unit**

The acceleration rates are in “command units/ s²”.

● **Axis settings related to acceleration**

(1) Types of acceleration waveform

Please refer to “7.7.5.2 Velocity Command- Velocity ramp type” for more information.

● **Description of acceleration in MC function modules**

The following input variables that are related to acceleration/deceleration in MC function modules:

Item	Meaning
Acceleration	Target acceleration*
Deceleration	Target deceleration*

***Note:** Due to inadequate trajectory length, small jerk and other factors, it is not possible to obtain target acceleration or target deceleration.

According to standard acceleration and deceleration rates, if demand for absolute value of current velocity decreases, deceleration rate is performed; if the demand for absolute value of current velocity increases, acceleration rate is performed.

For instance, when the current axis velocity is 500, the motion control instructions during execution is in reverse direction (Velocity = 1000, Acceleration = 1200, Deceleration = 600). The following diagram shows the velocity and acceleration waveform:

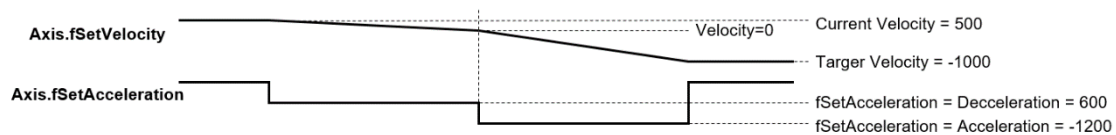

● **Monitoring acceleration**

To observe change in acceleration, you can focus on the following two axis variables (AXIS_REF_SM3 type) for monitoring:

Variable name	Position type	Data type
.fSetAcceleration	Command acceleration	LREAL
.fActAcceleration	Actual acceleration	LREAL

7.7.5.4 Jerk Command

The jerk assigns the changes in acceleration or deceleration rate. When the jerk is specified, the velocity waveform is in S-curve (the ramp of acceleration increases or decreases, no jerk) can reduce the shock on machines.

● Types of jerk

The following two types of jerk are used in the MC function modules.

Position type	Meaning
Command jerk	The outputs of MC function modules to control axis
Actual jerk	The jerk that is calculated based on actual acceleration

● Jerk unit

The jerk is in "command units/s³".

● Axis settings related to jerk

(1) Types of jerk waveform

Please refer to "7.7.5.2 Velocity Command- Velocity ramp type" for more information.

● Description of jerk in MC function modules

The following input variable that is related to jerk in MC function modules:

Item	Meaning
Jerk	Target jerk*

***Note:** When velocity ramp type is trapezoid or in Sin², the setting values of jerk are not applied in the movement; when velocity ramp type is quadratic or quadratic (smooth), the jerk does affect the velocity ramp.

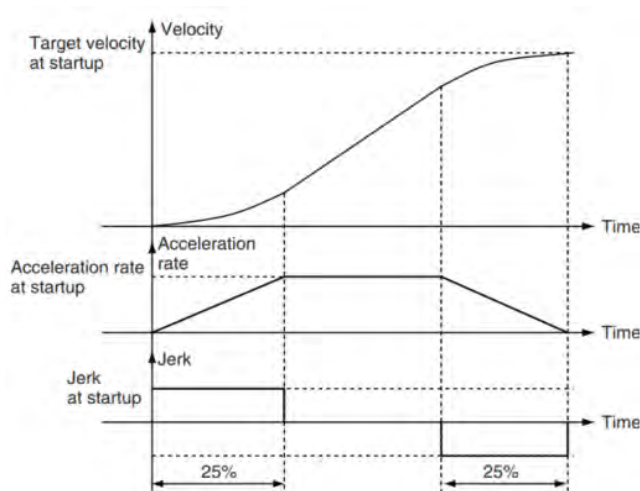

● Monitoring jerk

To observe change in jerk, you can focus on the following two axis variables (AXIS_REF_SM3 type) for monitoring:

Variable name	Position type	Data type
.fSetJerk	Command jerk	LREAL
.fActJerk	Actual jerk	LREAL

7.7.5.5 Axis Direction

The following situation requires specified operation directions:

- When input value of absolute during constant velocity, specified direction is required.
- When setting rotation axis, movement towards either positive or negative direction can reach the target position, therefore, operation direction is required.
- Description of directions in MC function modules

The following input variable that is related to direction in MC function modules:

Item	Setting	Meaning
Direction	negative	Motion operates in a negative direction
	shortest	Motion operates the shortest way (Only for rotation axis)*
	positive	Motion operates in a positive direction
	current	Motion operates based on the current direction (Only for rotation axis)
	fastest	Motion operates in the fastest way (Only for rotation axis)*

***Note:** The concept of shortest (moving distance) and fastest (moving time) are similar but not completely the same, please refer to the following example:

- Setup:
 - Set axis as rotation axis, range 360
 - Set velocity ramp type of axis as Trapezoid.
- Procedure:
 - Use MC_MoveVelocity to execute constant velocity motion. (Velocity=1000)
 - When motor reaches 350 and velocity reaches 1000, execute MC_MoveAbsolute with 2 different direction settings
 - (1) Execute MC_MoveAbsolute (Position=180, Velocity = Acceleration = Deceleration = 1000, Direction = fastest)

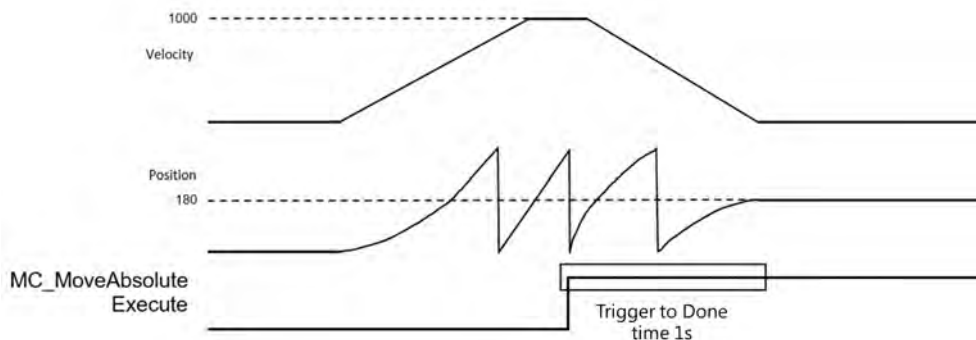

When MC_MoveAbsolute.Execute triggers, the system determines the shortest way to reach position 180 is to move in positive direction and decrease velocity to 0. The process takes about 1 sec.

- (2) Execute MC_MoveAbsolute (Position = 180, Velocity = Acceleration = Deceleration = 1000, Direction = shortest)

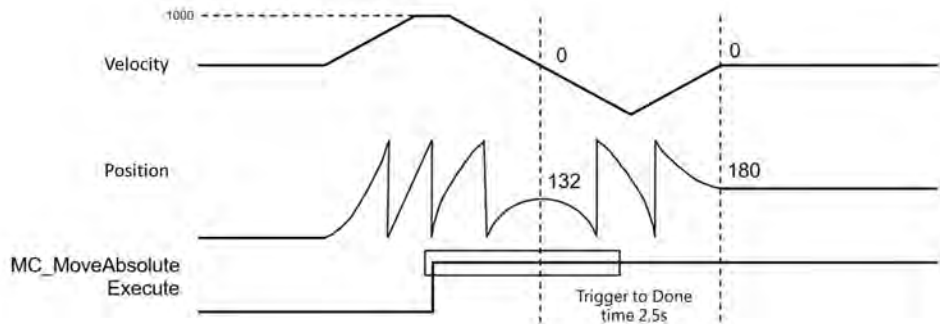

When MC_MoveAbsolute.Execute triggers, the system determines the shortest way to reach position 180 is to move in negative direction ($350 - 180 = 170$). However, since the process requires velocity to be in reverse, therefore, more turns are included. The process takes about 2.5 sec.

7.7.6 Axis Group Control

An axis group must consists of at least one axis configured via DIADesigner-AX. Up to six axes can be supported for linear axes, while three axes are supported by rotary type with three extra axes as the follow axes.

7.7.6.1 Linear Interpolation

TransitionMode: The resulting noises and vibration of machines may occur if the trajectory of interpolation changes while in motion. By using the input variable "TransitionMode", the chances of the above situation will be minimized.

- **Available transition modes**

Mode	Description
None	No effects (default)
Overlap	Continued by combinig the deceleration of the previous motion and the acceleration of the current motion.
SingleAxis	Continues according to the settings in Blending Mode, specifically for the single axis in a group

- **Supported buffer modes**

Mode	Aborting	Buffered	Blending Low	Blending Previous	Blending Next	Blending High
None	A	A	N	N	N	N
Overlap	A	A	D	D	D	D
SingleAxis	A	A	A	A	A	A

A = Supported

N = Not supported

D = Continued but different from the effects of settings set in Blending Mode for the single axis in a group

- TransitionMode:** For the below situation, set the mode to be None or Overlap, then choose buffered.

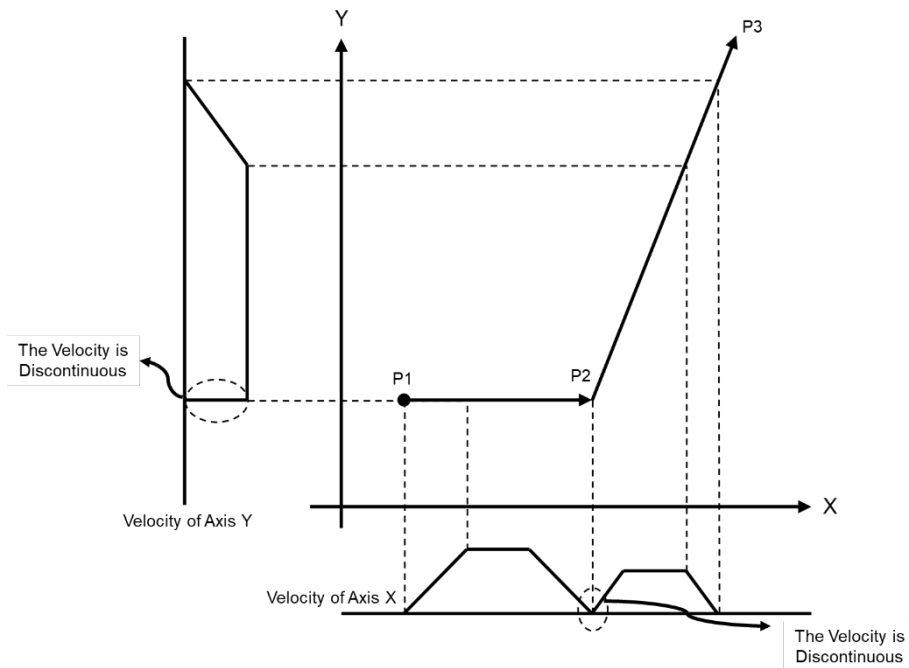

- TransitionMode:** For the below situation, set the mode to be Overlap, then choose Blending. Plan with reference to acceleration and deceleration given to the motion function block of each axis group.

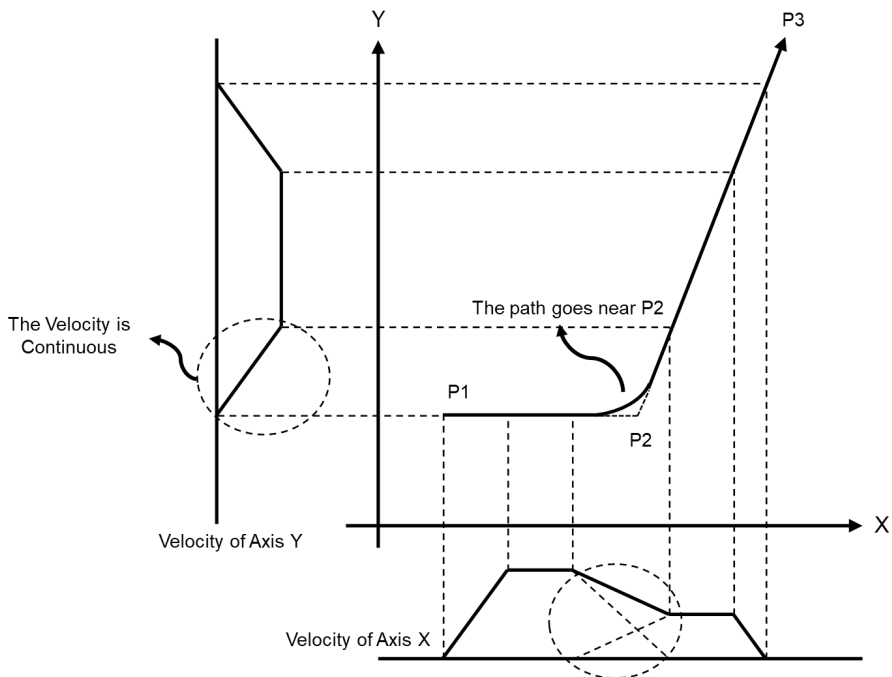

- **TransitionMode:** For the below situation, set the mode to SingleAxis, then choose Blending.

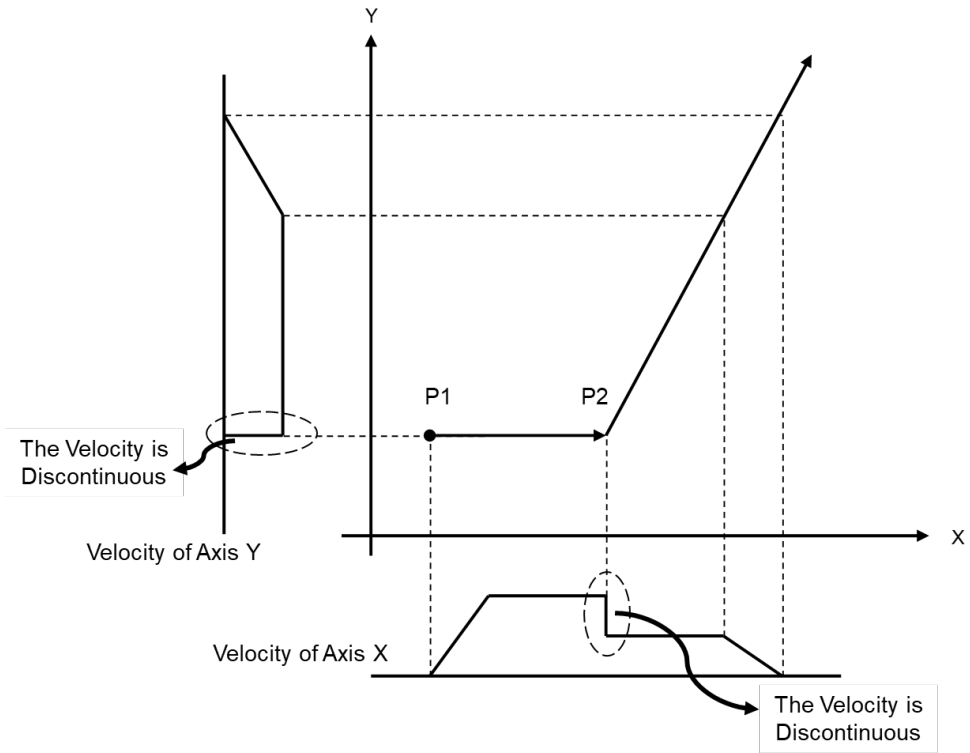

7.7.6.2 Circular Interpolation

Circular movements can be run in the three main planes of the spatial coordinate system, only using X, Y, Z axis and three additional follower axes.

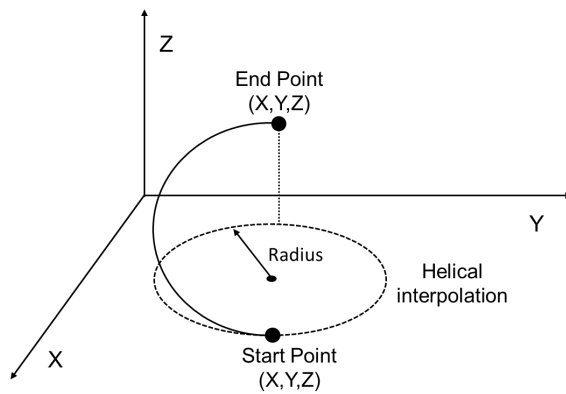

- **Concept of follower axes:**

Follower axes A, B, C move in a proportional and synchronized motion as axes X, Y, Z moving.

The axis group moves to position (30, 40, 0) with the start point of 0, which the combined moving distance is 50, while follower axes moving to position (100, 200, 300). The synchronized movement between axis group and follower axes is shown as following figures.

- Follower A

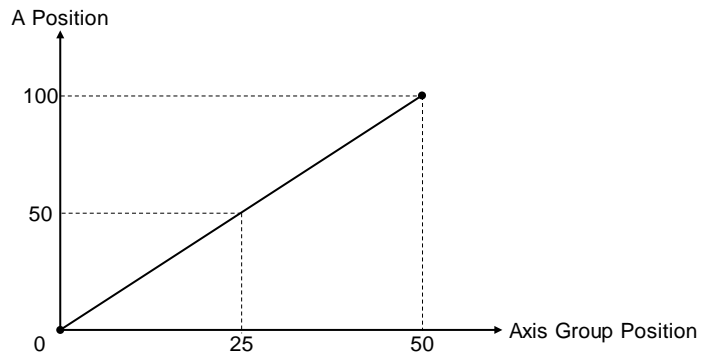

- Follower B

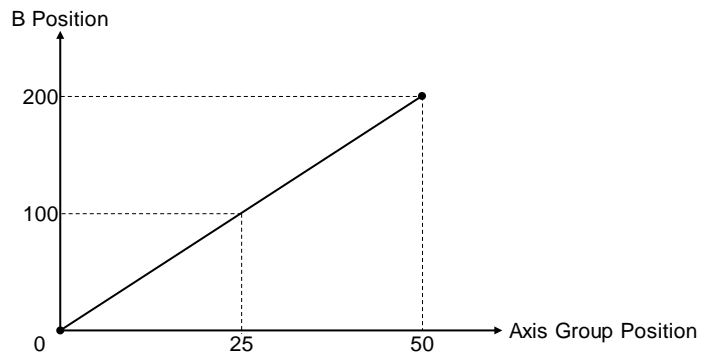

- Follower C

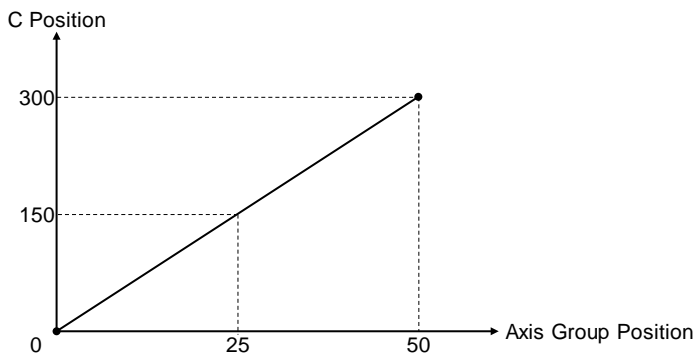

***Note:** When the axis group is not in motion, the input velocity given to axis group function block is used for the follower axis whichever the distance is the longest. At the same time, other follower axes move in synchronized motion based on the proportion of distances.

7.7.6.3 Group Stop Command

There're two different ways to stop axis group motion:

- Programming stop

Use DMC_GroupStop in the programming to decelerate the moving axis group to a stop. Then the group state switches to GroupStopping, which no motion instruction can be executed under this status.

The velocity for a deceleration stop must be set to the IrDeceleration pin.

- Error stop

As soon as an error occurs in group motion, the axis group stops operating.

For example, Hardware Limit is reached while the axis group is moving. The velocity drops to zero as a result of the output CommandAborted.

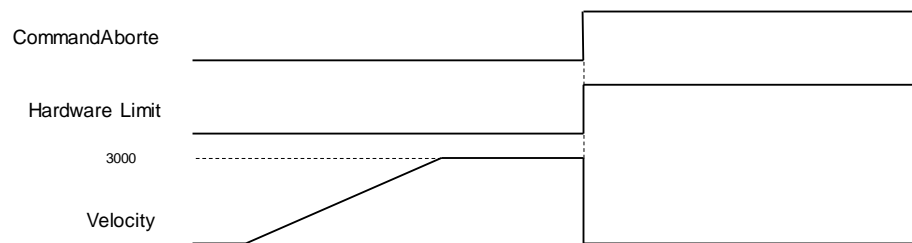

7.7.7 High-speed IO

The chapter contains information regarding CPU with IOs for configuration and parameter settings.

7.7.7.1 IO Configurations

For all AX-3 Series PLC CPU (except AX-332E)

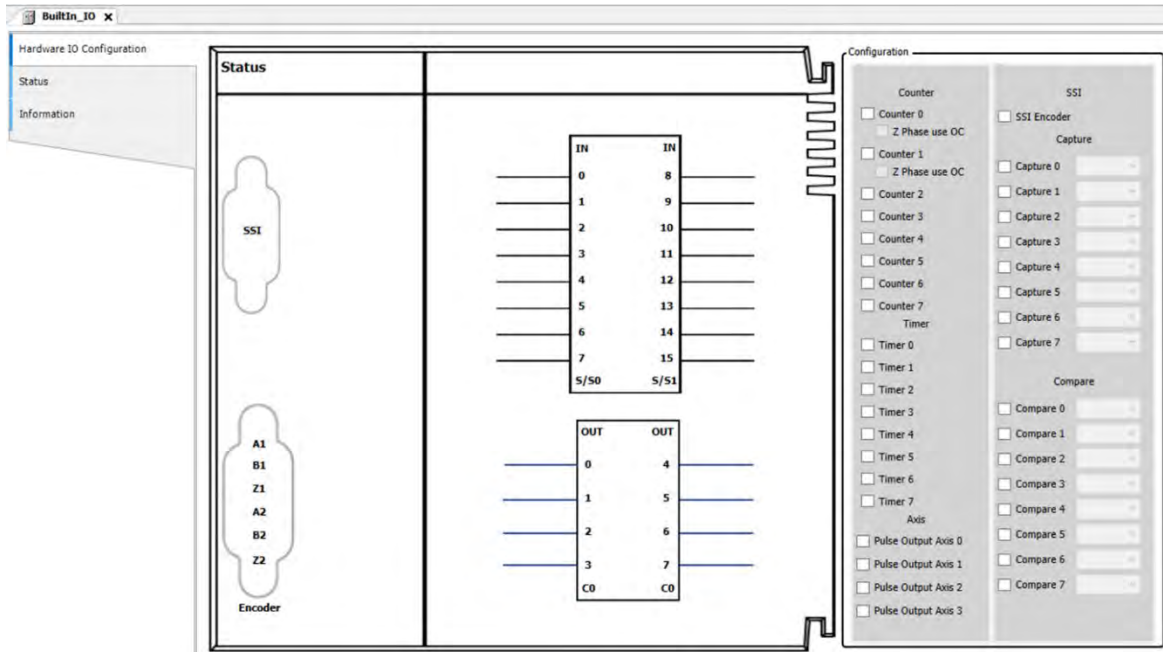

For AX-332E Series PLC CPU

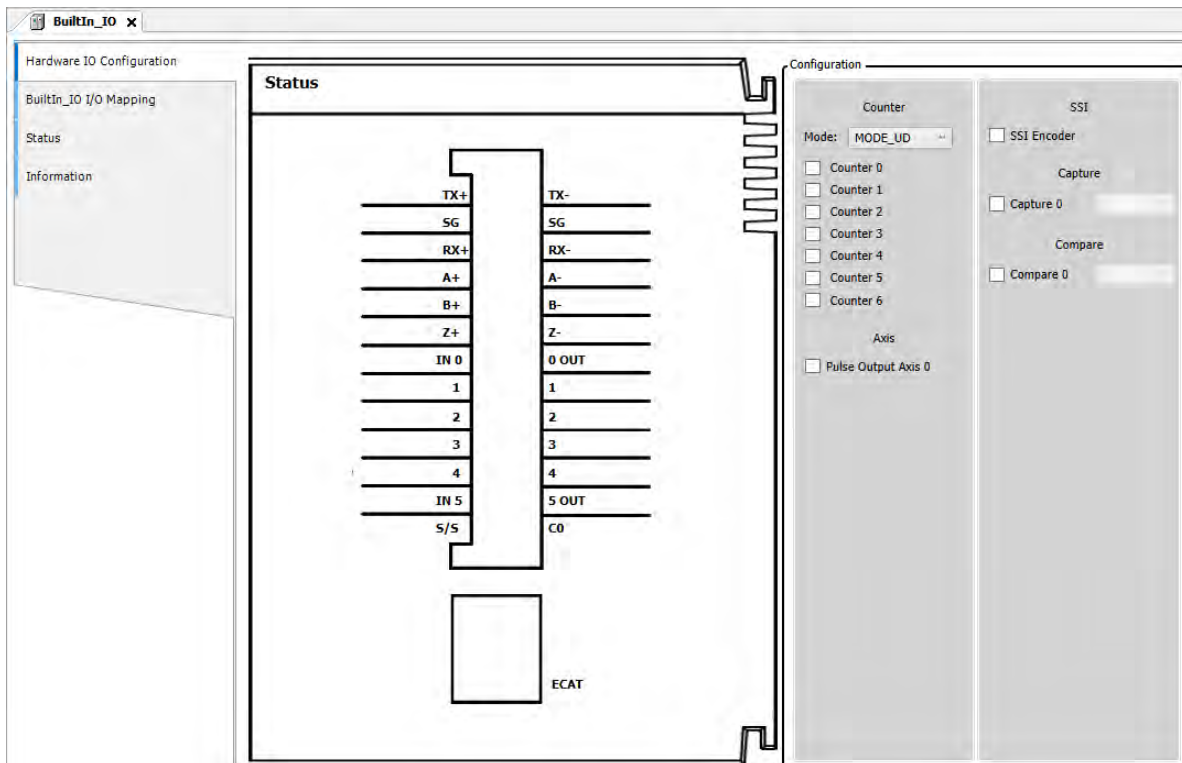

DIO: Set functions including interrupt, filter and polarity. Refer to section 7.7.7.2 for more information.

SSI Encoder: Set functions such as SSI coding type, clock frequency and SSI data length. Refer to section 7.7.7.3 for more information.

Pulse Encoder: Set functions including high speed counter variables, count modes, enable or disable Z phase signal as well as declare high speed timer variables. Refer to section 7.7.7.4 for more information.

Capture/ Compare: Declares variables regarding high speed capture and compare. Refer to section 7.7.7.5 for more information.

Pulse Output: Set functions including pulse output, direction and homing mode. Refer to section 7.7.7.6 for more information.

7.7.7.2 DIO Settings

The section describes setting functions including interrupt, filter and polarity of IOs in DIO device.

Double-click on “DIO” to enter the configuration page.



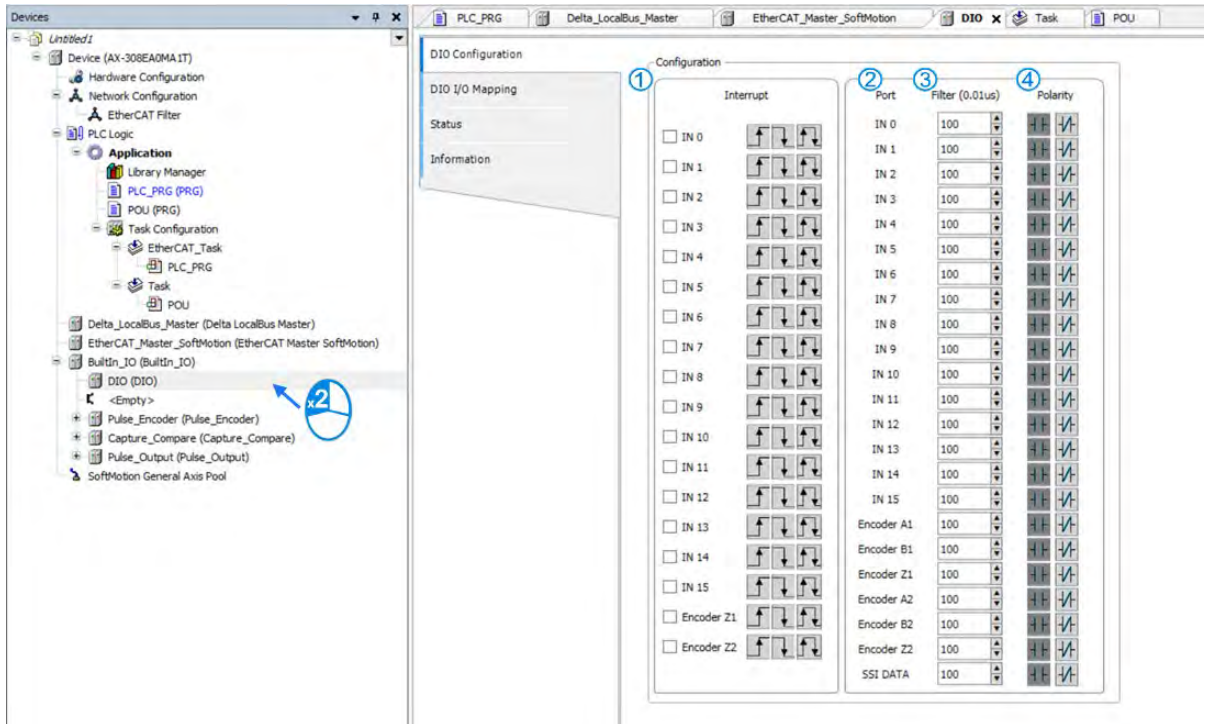

For all AX-3 Series PLC CPU (except AX-332E)

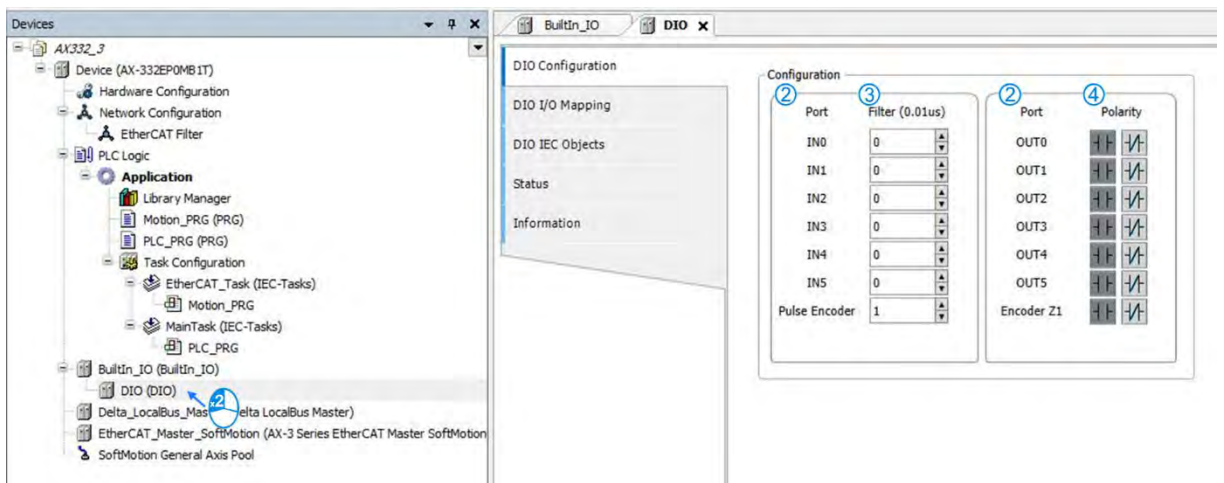

For AX-332E Series PLC CPU



● **Configuration**

Function	Description
① External Interrupt Setting*	<input type="checkbox"/> Default value
	<input checked="" type="checkbox"/> Activate external interrupt
	 When external interrupt is activated, set input signals as rising edge.
	 When external interrupt is activated, set input signals as falling edge.
	 When external interrupt is activated, set input signals as rising and falling edge.
② Port	Port number
③ Filter	<input type="text" value="100"/> Set filter time (us), setting range is from 0 to 100000000. The default is 100us.
④ Polarity	 Set input polarity. The default is contact A .
	 Set input polarity, The default is contact B.

Note: External Interrupt Setting is not available for AX-332E Series PLC CPU.

● **IO interrupt mode setting**

- After activate the interrupt function on DIO setting page, click on “Task” to proceed.

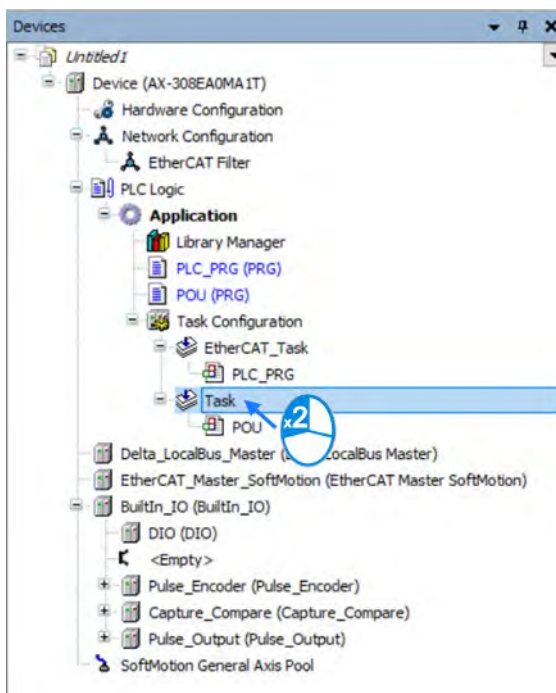

- Enter Task configuration page and choose “External” from the drop down list for Type.

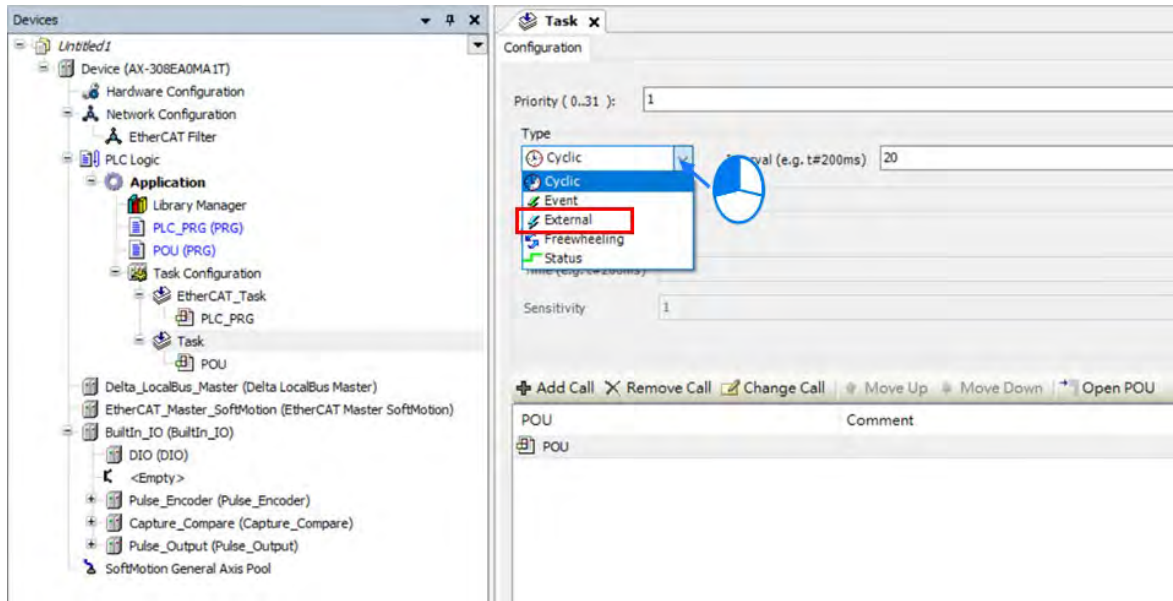

- Then choose the corresponding interrupt contact from the drop down list of External event.

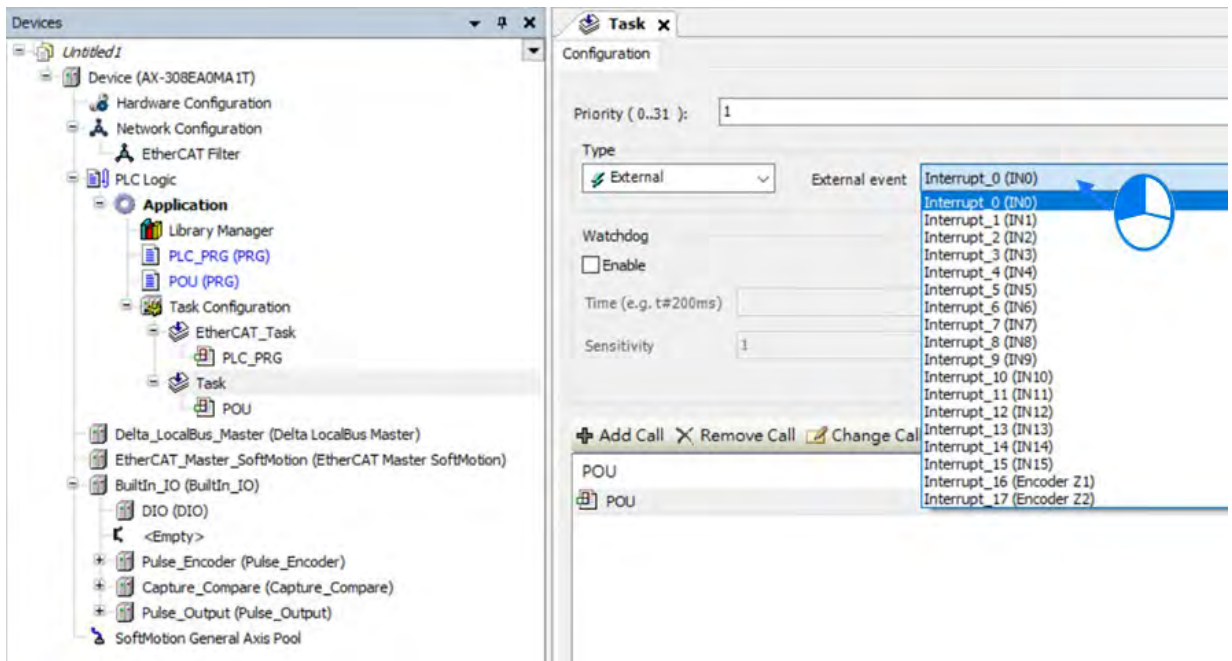

- The setting value for hardware filter time is smaller than IN input duty on time as shown below:

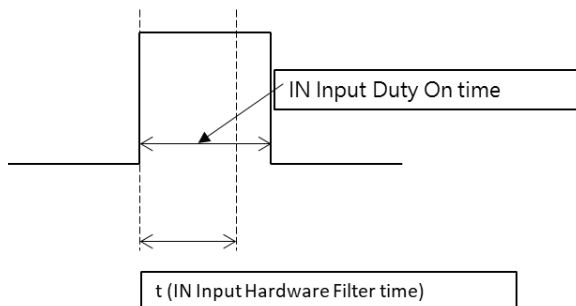

- For AX-3 Series PLC CPU: The input range for hardware filter is from 1 to 50,000,000, unit as 0.1 μ s (except for AX-332E).
- For AX-332E: The input range for hardware filter is from 1 to 50,000,000, unit as 0.1 μ s.

Four ranges are as shown below.

Input range	Effective value
$0 \leq \text{input value} < 1000$	0 μ s
$1000 \leq \text{input value} < 5000$	100 μ s
$5000 \leq \text{input value} < 10000$	500 μ s
$10000 \leq \text{input value}$	1000 μ s

Example 1: Input a value of 900, the effective value will be 0 μ s.

Example 2: Input a value of 12000, the effective value will be 1000 μ s.

- The relation between filter frequency and filter time:

Filter frequency*1 (Hz): Filter frequency= $1 / (2*t)$; t is the filter time setting value (unit: 0.01 μ s). When input frequency is higher than the filter frequency range, signals are filtered.

The function focuses on the X input point used in DFB_Capture, DFB_Hcnt, DFB_HTmr, DFB_Compare and IO interrupt.

7.7.7.3 SSI Encoder Settings

For AX-3 Series PLC CPU (except AX-332E): Through connecting D-SUB port and PLC, the port provides 5V encoder power output.

For AX-332E: Connects through European style terminal block

You can click and enable SSI encoder function to setup the required parameters as well as receive data via hardware configuration channels.

- **SSI encoder structure**

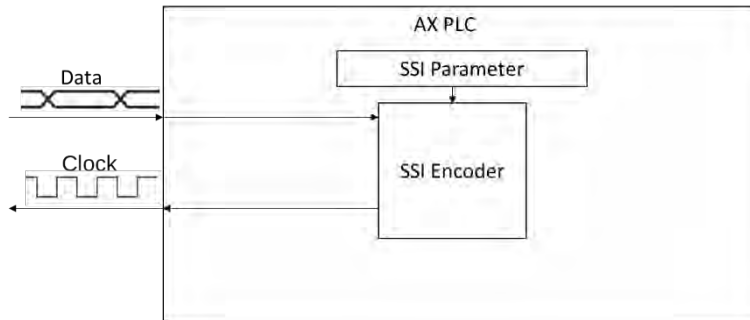

- Enable SSI encoder
 - Click SSI Encoder and choose SSI Encoder Configuration on BuiltIn_IO page.

For all AX-3 Series PLC CPU (except AX-332E)

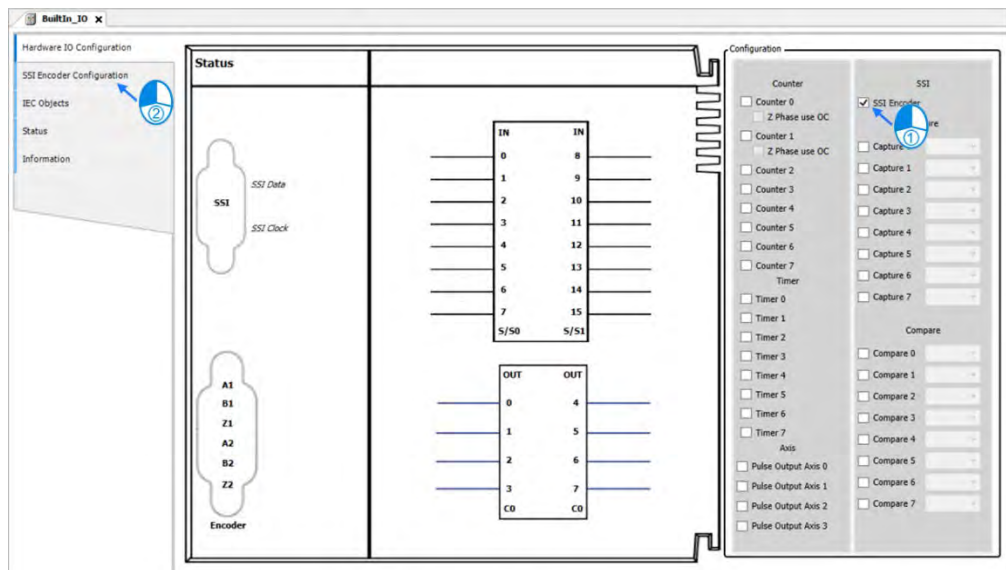

For AX-332E

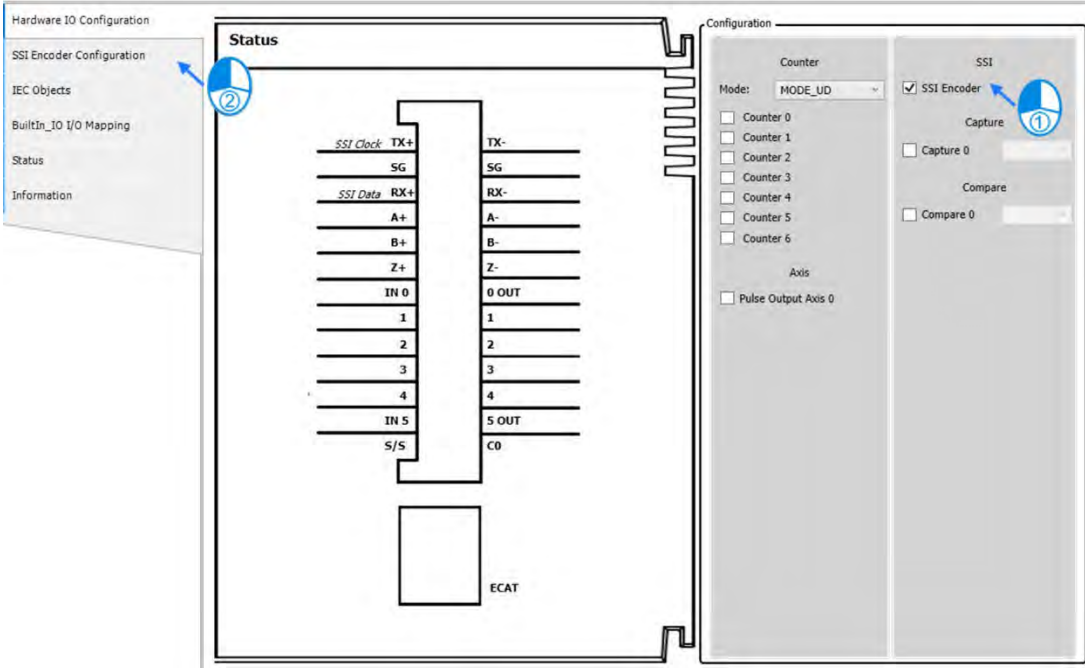

- The SSI related configuration can be set on the SSI Encoder Configuration page. Refer to below descriptions for settings respectively.

For all AX-3 Series PLC CPU (except AX-332E)

① General

Item	Function	Setting value (Default value)
EncoderType	Set SSI encoder type	Gray code / Binary code (Gray code)
Clock Frequency	Set SSI clock frequencies (Need SSI encoder datasheet as reference) AX-3 Series PLC CPU (except AX-332E): you can input any value in the range of 0-10000; AX-332E: 5 available options to choose from, 100, 200, 500, 1000 and 2000	(500)

Item	Function	Setting value (Default value)
MultiTurnsSetup	Set SSI encoder multiturn setup (Need SSI encoder datasheet as reference)	(12)
SingleTurnsSetup	Set SSI encoder singleturn setup (Need SSI encoder datasheet as reference)	(13)
Clock Pause Time	After the last falling edge of clock, the data line keeps at a low level for a while before the line rises. (Need SSI encoder datasheet as reference)	(80)

② Axis Standard

Item	Function	Setting value (Default value)
Encoder Type	Display encoder type	-

③ Axis Type

Item	Function	Setting value (Default value)
Linear Axis / Rotary Axis	Set the axis type to be Linear Axis or Rotary Axis.	Linear Axis Rotary Axis (Linear Axis)
Modulo	Choose the axis type to be rotary axis first and set the value for the rotation area for a turn.	(360)

④ Positive / Negative Command

Item	Function
Reverse OFF / ON	Decide on the rotation direction for positive and negative commands.

⑤ Transmission Mechanism

Different structures are presented in the following descriptions:

◆ Ball Screw

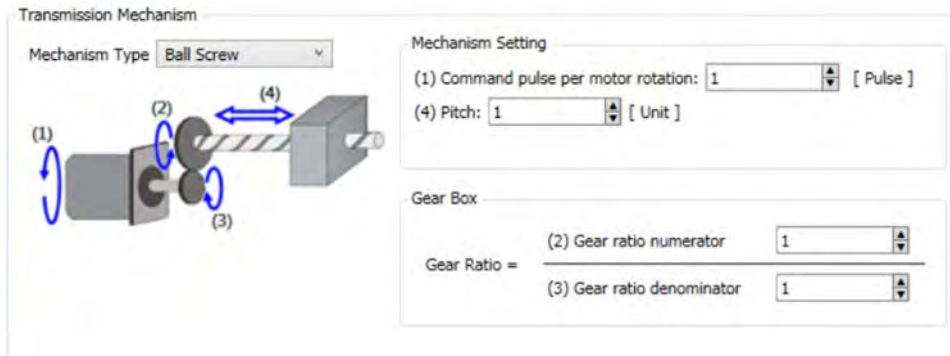

Item	Description
(1) Command Pulse per motor rotation	Amount of pulses that the encoder counts per revolution of the motor
(4) Pitch	Pitch of screw
(2) Gear ratio numerator	The numerator of gear ratio
(3) Gear ratio denominator	The denominator of gear ratio

◆ Round Table

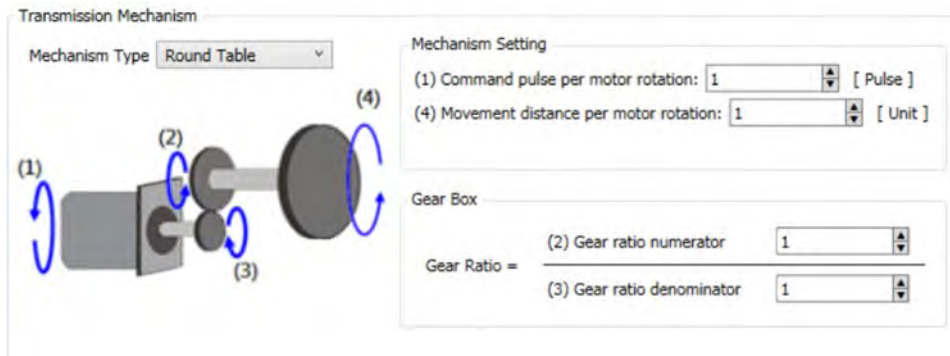

Item	Description
(1) Command Pulse per motor rotation	Amount of pulses that the encoder counts per revolution of the motor
(4) Movement distance per motor rotation	Distance of movement per revolution of the motor.
(2) Gear ratio numerator	The numerator of gear ratio
(3) Gear ratio denominator	The denominator of gear ratio

◆ Belt Pulley

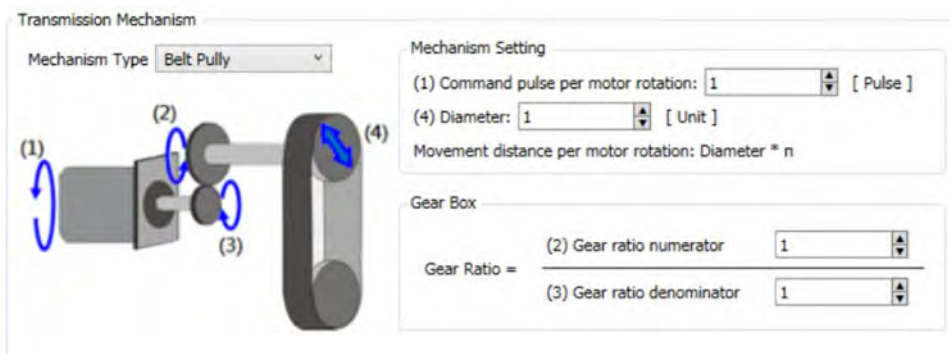

Item	Description
(1) Command Pulse per motor rotation	Amount of pulses that the encoder counts per revolution of the motor
(4) Diameter (Movement distance motor rotation : Diameter *π)	Distance of movement per revolution of the motor. (Movement distance per rotation : Diameter *π)
(2) Gear ratio numerator	The numerator of gear ratio
(3) Gear ratio denominator	The denominator of gear ratio

● SSI Encoder mapping variable setting

- The actual position and ErrorID can be read by SSI Encoder via the following parameters.

Parameter	Description
EncoderPosition	Actual position of SSI Encoder
ErrorID	Status of SSI Encoder Communication. 0 : No Error 1 : Error Communication 2 : Wrong Parameter Setting

***Note:**

ErrorID:

1. When SSI encoder is not connected or SSI encoder and CPU is disconnected, then ErrorID=1.
2. When MultiTurns + SingleTurns is bigger than 32, then ErrorID=2.

The error situations mentioned above allows BusCycle to stop updating EncoderPosition and the EncoderPosition will keep the last value, the purpose is to avoid jump from other slave axis when main axis encoder is in synchronized motion.

ErrorID Clear:

1. When SSI encoder is not connected or SSI encoder and CPU is disconnected, then Status Data=1, the BusCycle stops to update and the EncoderPosition keeps the last value, the purpose is to avoid jump from other slave axis when main axis encoder is in synchronized motion.

Ans: Check the connection between SSI encoder and CPU. The modified firmware will make sure the communication channel is properly connected to restore EncoderPosition updates of BusCycle. There are many reasons for cause of errors, for example: SSI encoder not properly connected, broken SSI encoder and abnormal drive board.

2. When MultiTurns + SingleTurns is bigger than 32, then Status Data =2:

Ans: When the parameter setting value of MultiTurns + SingleTurns does not exceed 32, then download again.

● **Use SSI Encoder in program**

The SSI encoder device contains variables of axis encoder that can be used for MC function blocks in POU. (Ex. MC_CamIn).

- Click "IEC Objects" on BuiltIn_IO page.

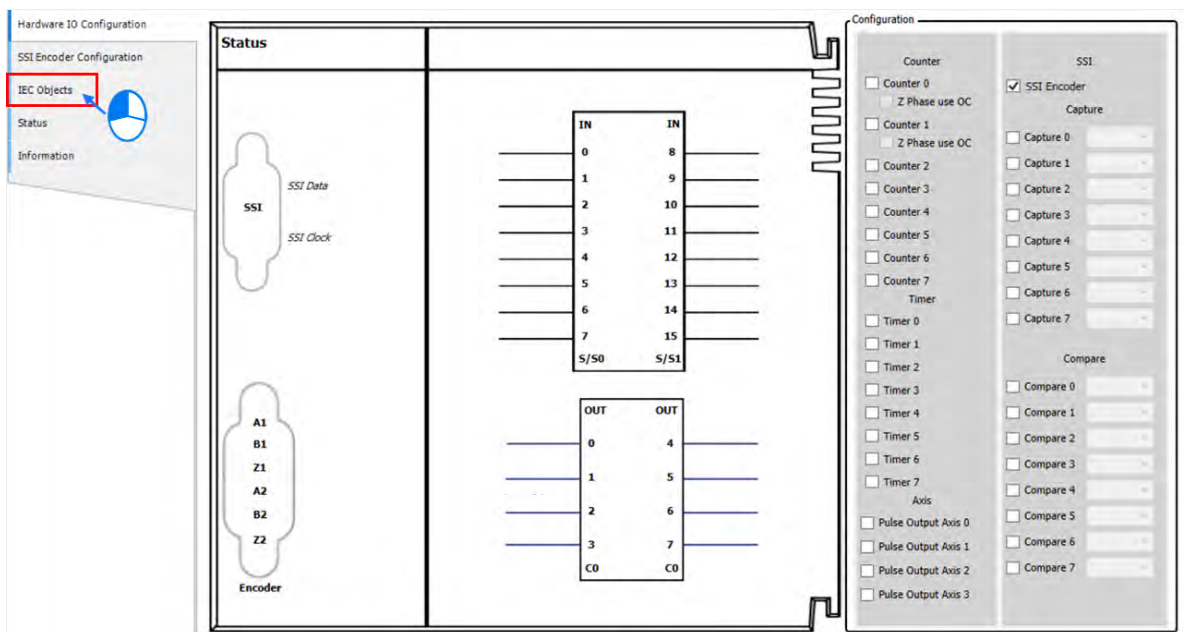

- Example of variable reading

Hardware IO Configuration	Variable	Type	Configuration Function
SSI Encoder Configuration	SSI_Encoder	DFB_SSI_ENCODER_REF	SSI Encoder
	Encoder_Axis_1	DMC_ENCODER_AXIS_REF	SSI Encoder/FreeEncoder_Axis

The actual position and ErrorID can be accessed via the variable with red border, such as "SSI_Encoder.EncoderPosition" and "SSI_Encoder.ErrorID".

- The column marked ① on the IEC Objects tab is the configuration function for each variable. For the axis used in POU, the axis name should be set as Encoder_Axis.

	Variable	Type	Configuration Function
SSI Encoder Configuration	SSI_Encoder	DFB_SSI_ENCODER_REF	SSI Encoder
	Encoder_Axis	DMC_ENCODER_AXIS_REF	SSI Encoder/FreeEncoder_Axis

- For MC_CamIn function block in POU, SSI can be used for master source, while the input name of Master axis is Encoder_Axis.

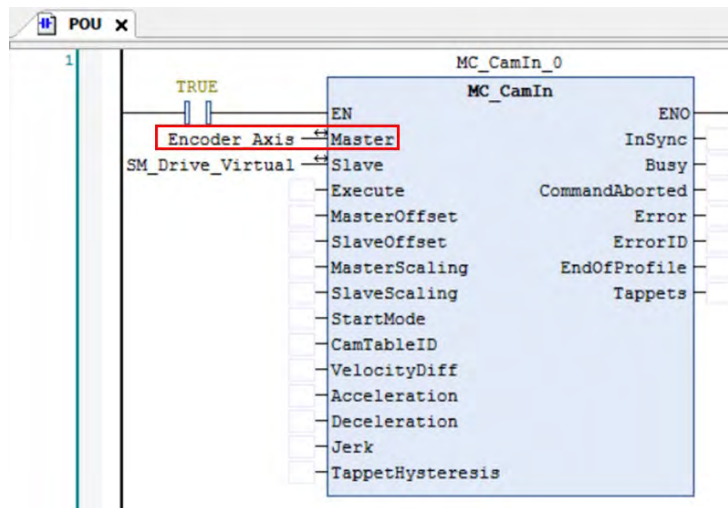

7.7.7.4 Pulse Encoder Settings

- **AX-3 Series PLC CPU (except AX332E) provides two connecting interfaces for the pulse encoder**
 - AX-3 Series PLC CPU supports two differential inputs:
Connecting through D-SUB15 port, up to 2 sets of high speed counters / timers can be used to count or time the pulse values or the frequencies of the encoder.
 - AX-3 Series PLC CPU supports six sets of open collector typed pulse inputs:
Connecting through the euroblock installed on the IO board; up to 6 sets of high speed counters / timers can be used to count or time the pulse values or the frequencies of the encoder.

- **AX332E Series PLC CPU (except AX332E) provides two connecting interfaces for the pulse encoder**
 - AX332E supports one differential input:
Connecting through differential input as designed from the euroblock installed on the IO board, one set of high speed counter / timer can be used to count or time the pulse values or the frequencies of the encoder.
 - AX332E supports six sets of open collector typed pulse inputs:
Connecting through the open connector typed pulse inputs as designed from the euroblock installed on the IO board; up to 6 sets of high speed counters / timers can be used to count or time the pulse values or the frequencies of the encoder.

You need to select to enable pulse-type encoder function and set up the required parameters and then through the configured hardware channel to receive the encoder data.

This section below describes the pulse-type encoder (see below), the maximum amount of high speed counters and high speed timers supported for AS308E is 8 sets. While for AS332E, it supports 7 sets of high speed counter, but no high speed timers.

- **High speed counter (Cnt)**

When selecting Cnt function in Hardware IO Configuration, you can also setup the high speed counter and encoder sections.

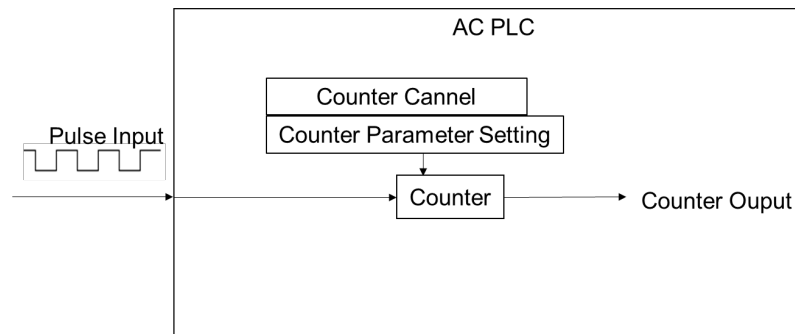

- **Enable high speed IO function**
AX-3 Series PLC CPU (except AX-332E)

- A number of 8 counters are displayed on BuiltIn_IO page. Select Counter 0, then click “Counter Configuration” tag.

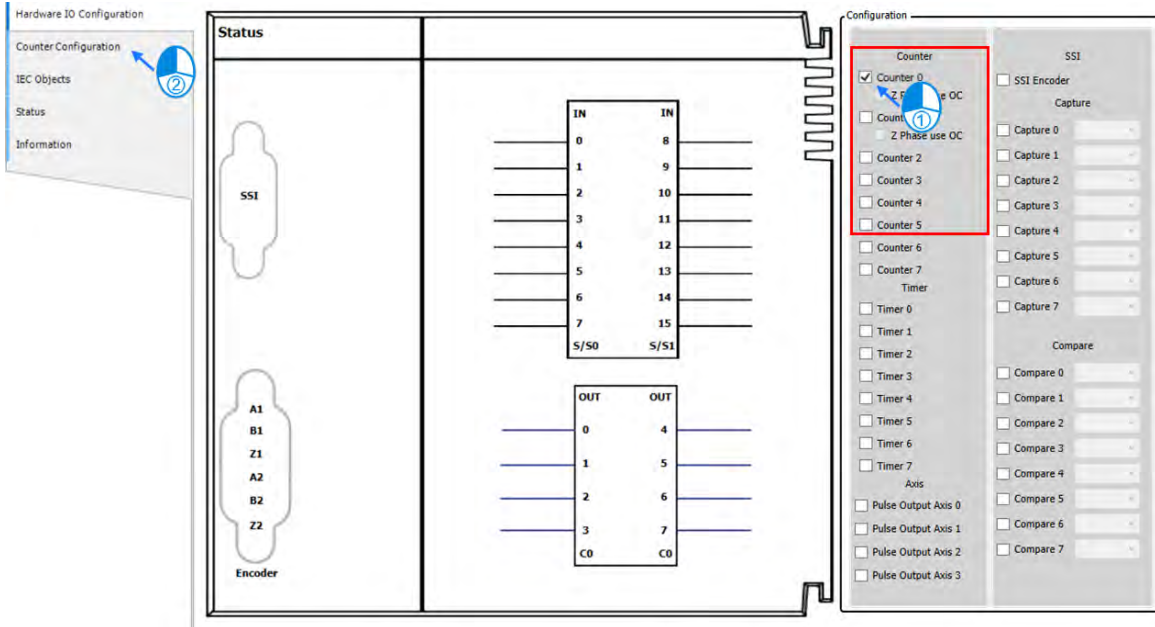

- On Counter Configuration page, choose Counter.

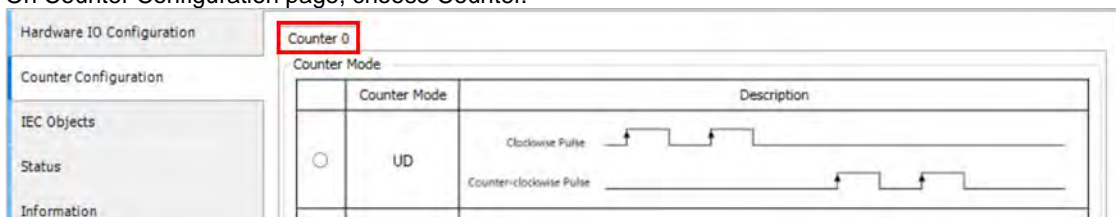

- Configure Counter-related settings on Counter Configuration page. Descriptions are as follows.

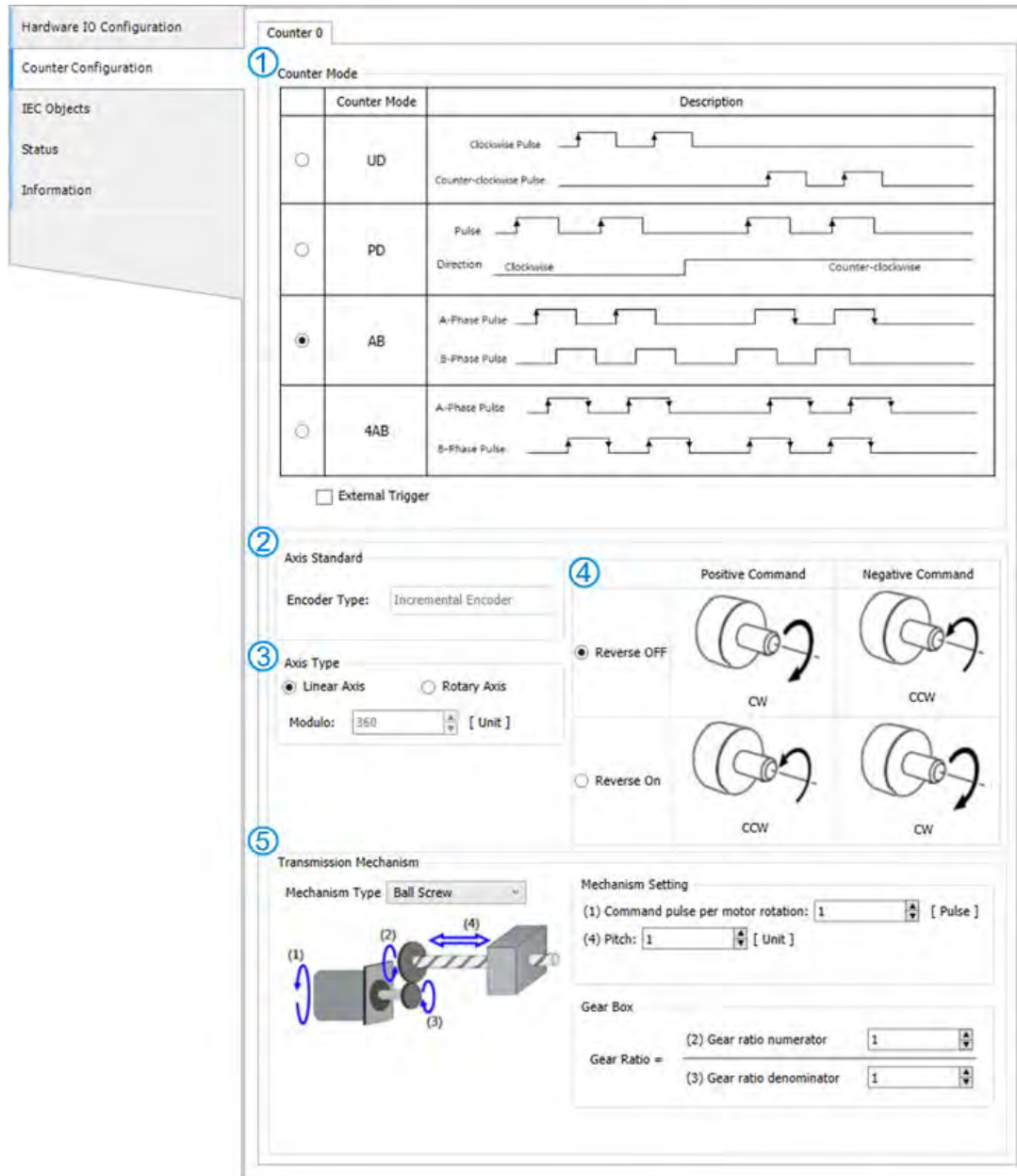

① Counter Mode

Pulse Counter Mode	Description
UD	Forward rotation pulse train and reverse rotation pulse train
PD	Pulse and direction
AB	A-phase and B-phase pulse
4AB	A-phase and B-phase pulse (4x)
External Trigger*	Activate Z-phase signals

Note: Refer to section 3.5 DFB Preset Value from AX Series Standard Instruction Manual for more information on function blocks.

Refer to section 7.7.7.3 SSI Encoder Setting for ② ③ ④ ⑤ on configuration page.

● **AX332E**

- A number of 7 counters are displayed on BuiltIn_IO page. Counter 0 is fixed to correspond to differential inputs A, B, Z. For the rest counters, you can set to other modes. Here are explanations for Counter 0, and Counter 1 to 7.

Counter 0:

- A number of 7 counters, counter 0 to 6, are displayed on BuiltIn_IO page. Select Counter 0, then click “Counter Configuration” tag.

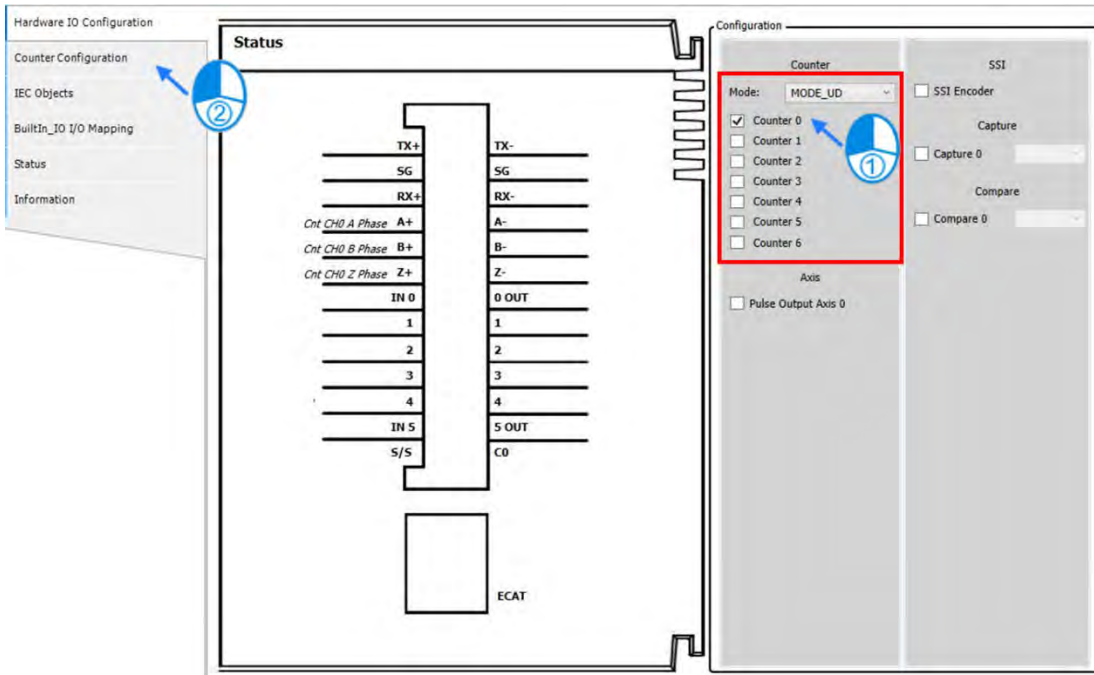

- On Counter Configuration page, choose Counter.

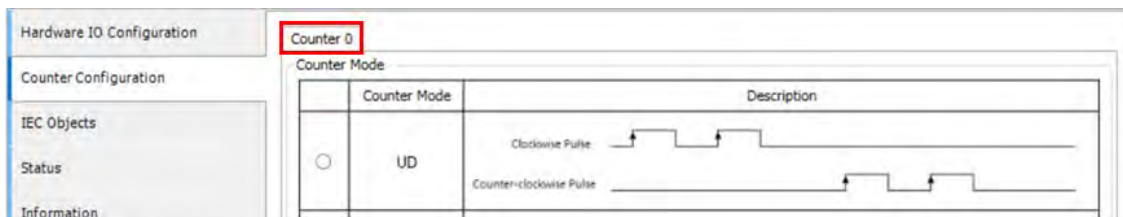

- Configure Counter-related settings on Counter Configuration page. Descriptions are as follows.

Counter 0

Counter Mode

Counter Mode	Description
<input checked="" type="radio"/> UD	Clockwise Pulse Counter-clockwise Pulse
<input type="radio"/> 4AB	A-Phase Pulse B-Phase Pulse

Axis Standard
Encoder Type: Incremental Encoder

Axis Type
 Finite Modulo
Modulo: 360 [Unit]

Transmission Mechanism
Mechanism Type: Ball Screw

Mechanism Settings
(1) Command pulse per motor rotation: 1 [Pulse]
(4) Pitch: 1 [Unit]

Gear Box
Gear Ratio = (2) Gear ratio numerator: 1 / (3) Gear ratio denominator: 1

① Counter Mode

Pulse Counter Mode	Description
UD	Forward rotation pulse train and reverse rotation pulse train
4AB	A-phase and B-phase pulse (4x)

Refer to section 7.7.7.3 SSI Encoder Setting for ② ③ ④ ⑤ on configuration page.

Counter 1 to 7:

- Counter 0 to 6 are displayed on BuiltIn_IO page. You can select various modes from the drop-down list. Different mode corresponds to its specific counters.

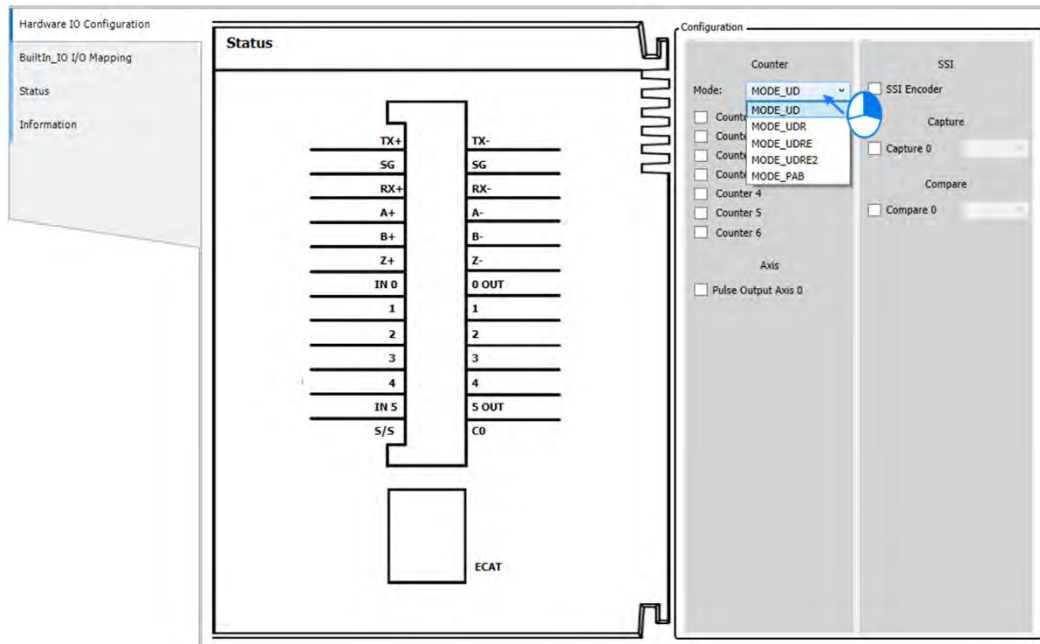

● **Descriptions for modes and their corresponding counters**

Mode	Corresponding Counter	Description
MODE_UD	Counter1~Counter6	1. Use the pins of UP or DOWN for input signals and the counter can count up or count down.
MODE_UDR	Counter1/Counter3/Counter5	1. Use the pins of UP or DOWN for input signals and the counter can count up or count down. 2. Use the pin of RESET to clear the counter.
MODE_UDRE	Counter1/Counter4	1. Use the pins of UP or DOWN for input signals and the counter can count up or count down. 2. Use the pin of RESET to clear the counter. 3. Use the pin of ENABLE to activate the counter.
MODE_UDRE2	Counter1	1. Use the pin of UP for input signals and the counter can count up. 2. Use the pin of DOWN for input signals and the counter can count down. 3. Use the pin of RESET to clear the counter. 4. Use the pin of ENABLE to activate the counter.

Mode	Corresponding Counter	Description
MODE_PAB	Counter1	<ol style="list-style-type: none"> 1. Use the pin of PA (pulse A phase) for input signals and Phase A signal is single-wired (counter). 2. Use the pin of PB (pulse B phase) for input signals and Phase B signal is single-wired (counter). 3. Use the pin of RESET to clear the counter. 4. Use the pin of ENABLE to activate the counter.

- Different hardware layouts are designed for various modes. DIADesigner-AX shows the corresponding counters and their pins.

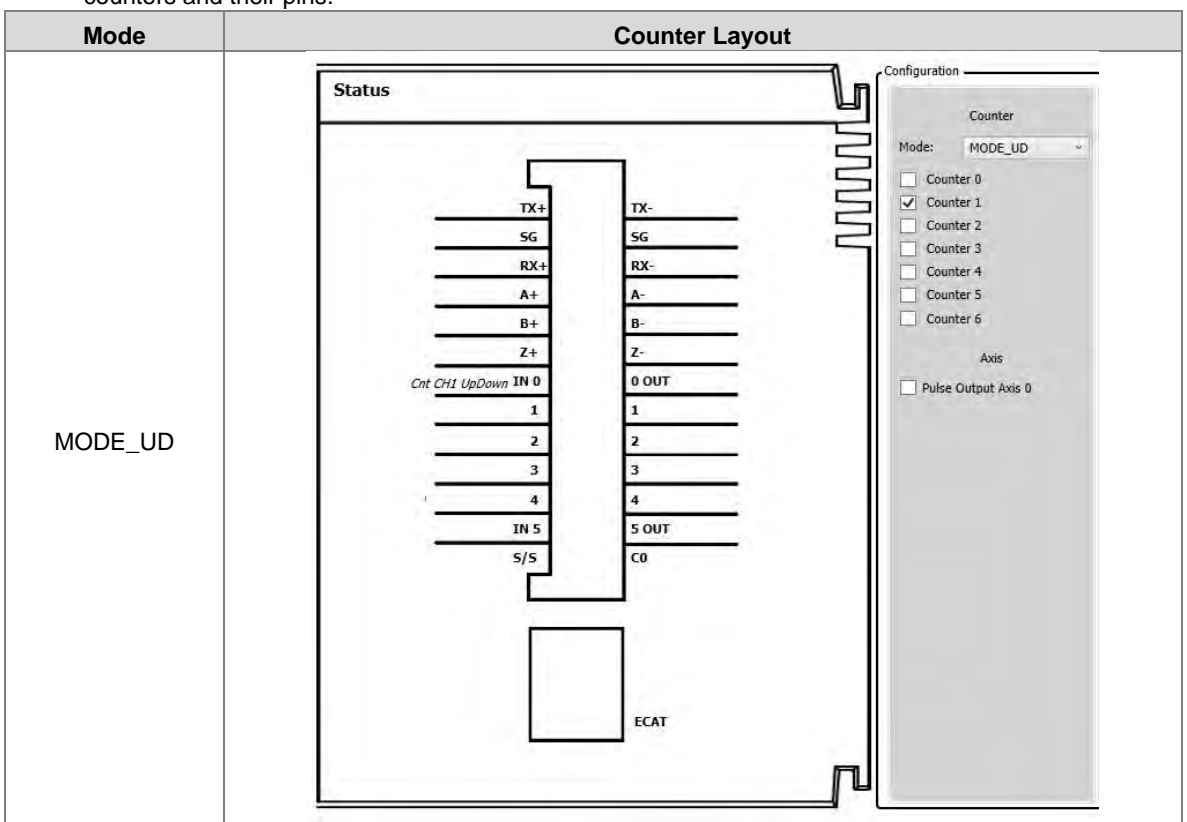

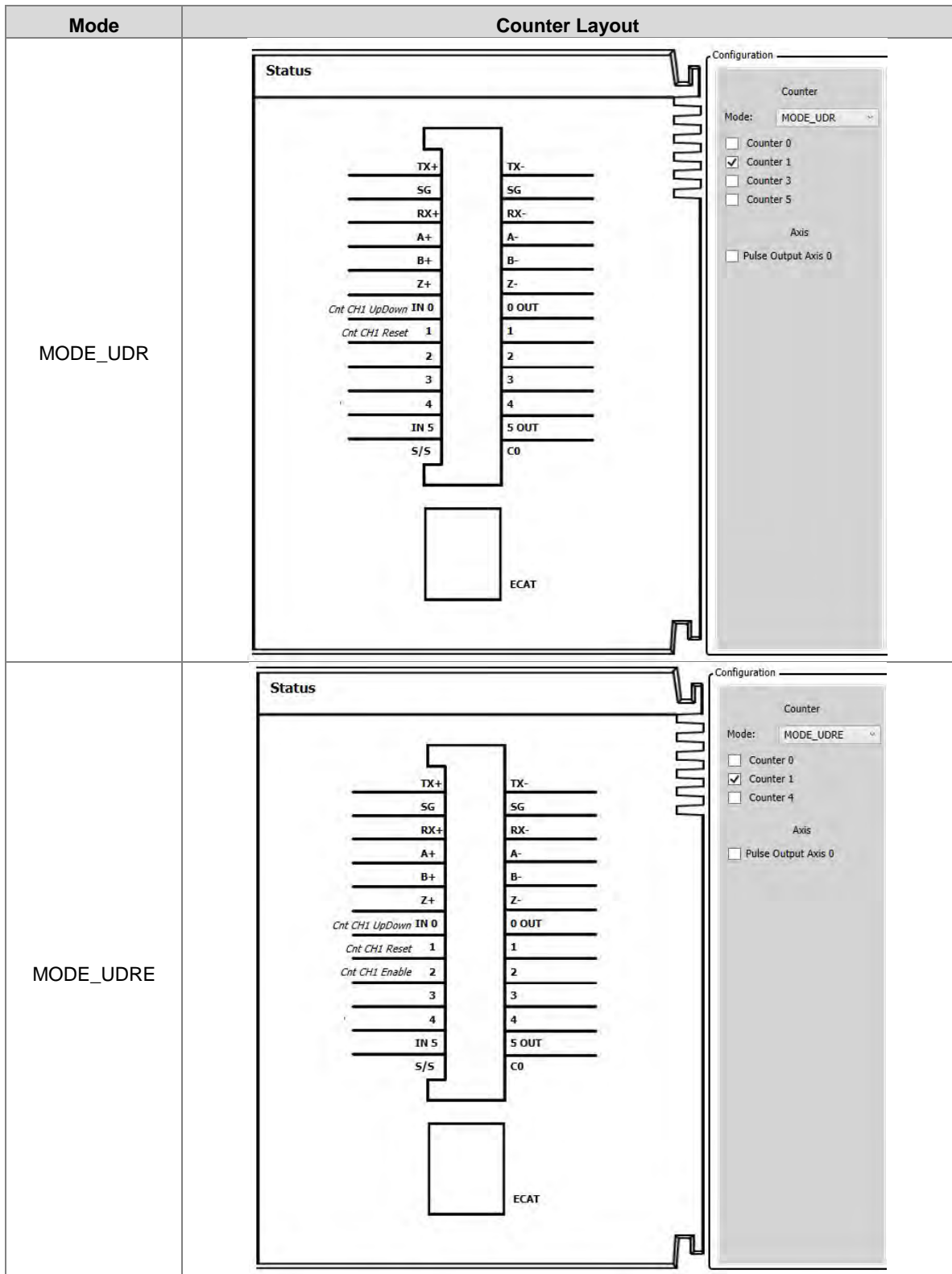

7

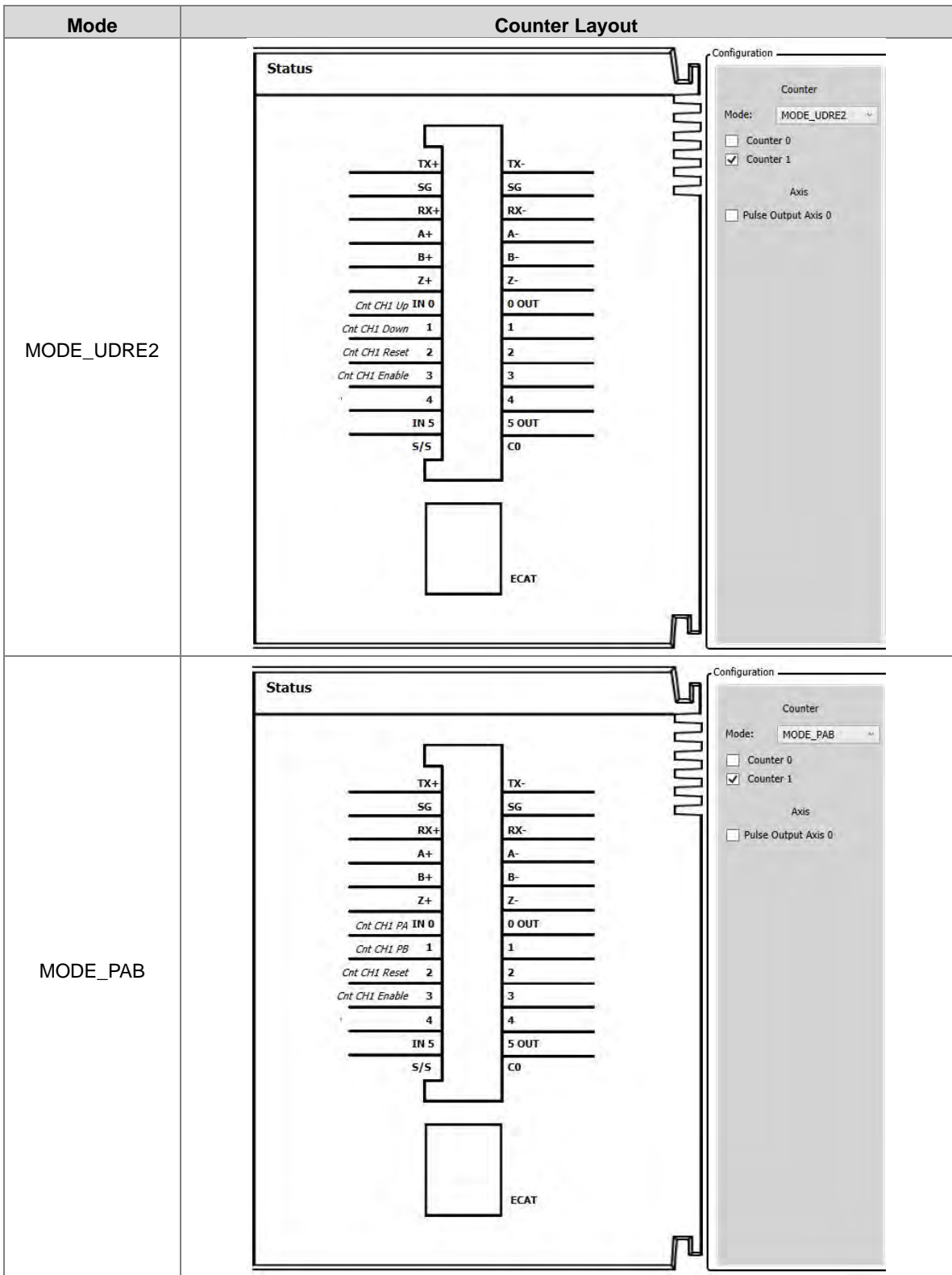

- Configure Counter-related settings on Counter Configuration page. Descriptions are as follows.

The screenshot shows the 'Counter 1' configuration page. On the left is a navigation menu with options: Hardware IO Configuration, Counter Configuration (selected), IEC Objects, BuiltIn_IO I/O Mapping, Status, and Information.

The main configuration area is titled 'Counter 1' and contains the following sections:

- Axis Standard (2):** Encoder Type: Incremental Encoder.
- Axis Type (3):** Finite (selected), Modulo (360) [Unit].
- Reverse Command (4):** A 2x2 grid of diagrams showing motor rotation for Positive and Negative commands.
 - Reverse OFF: Positive Command is CW, Negative Command is CCW.
 - Reverse On: Positive Command is CCW, Negative Command is CW.
- Transmission Mechanism (5):** Mechanism Type: Ball Screw. Includes a diagram of a gear train with callouts (1) for motor rotation, (2) for gear ratio numerator, (3) for gear ratio denominator, and (4) for pitch.
 - Mechanism Settings: (1) Command pulse per motor rotation: 1 [Pulse]; (4) Pitch: 1 [Unit].
 - Gear Box: (2) Gear ratio numerator: 1; (3) Gear ratio denominator: 1.

Refer to section 7.7.7.3 SSI Encoder Setting for ② ③ ④ ⑤ on configuration page.

● Use Counter in program

The high speed counter contains variables of axis encoder that can be used for MC function blocks in POU.

- Click on “IEC Objects” tab on BuiltIn_IO page.

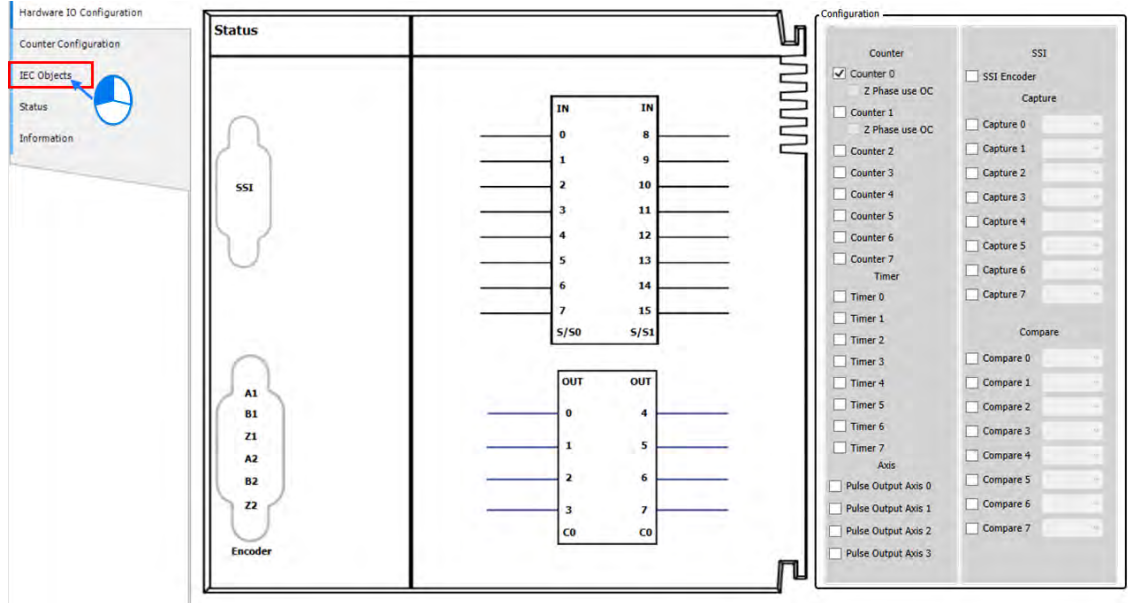

- The column marked ① on the IEC Objects tab is the configuration function of each variable. To enable counter function, the variable Counter_0 needs to be input to the Counter pin of DFB_HCnt.

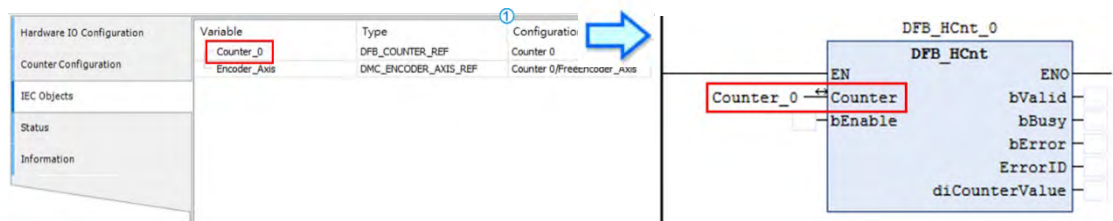

- For MC_CamIn function block in POU, the input variable corresponding to Master should be Encoder_Axis while using variable Counter_0 SSI as the source of the master axis.

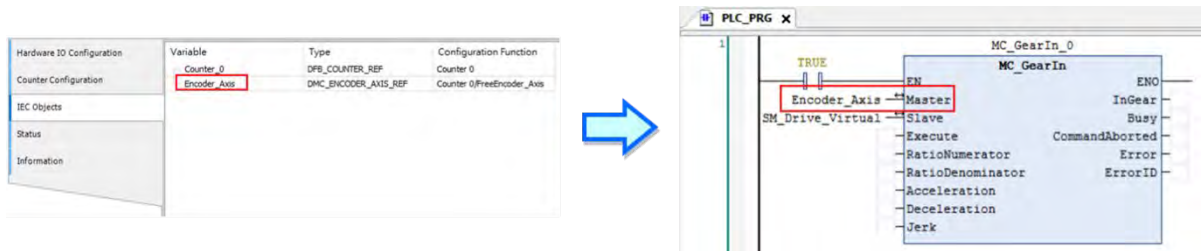

● **High speed timer (Tmr)**

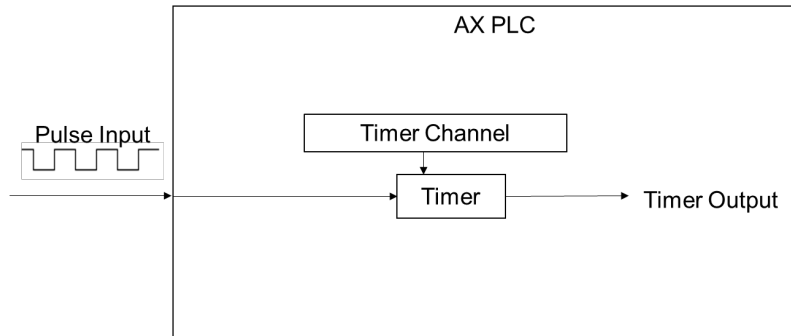

● **Enable high speed timer function**

For AX-3 Series PLC CPU:

When selecting Tmr function in Hardware IO Configuration, the high speed timer in AX series is set as 0.1μs. To enable timer function, select Timer 0 to 7 on BuiltIn_IO page to activate.

For AX332E:

This functionality is not supported.

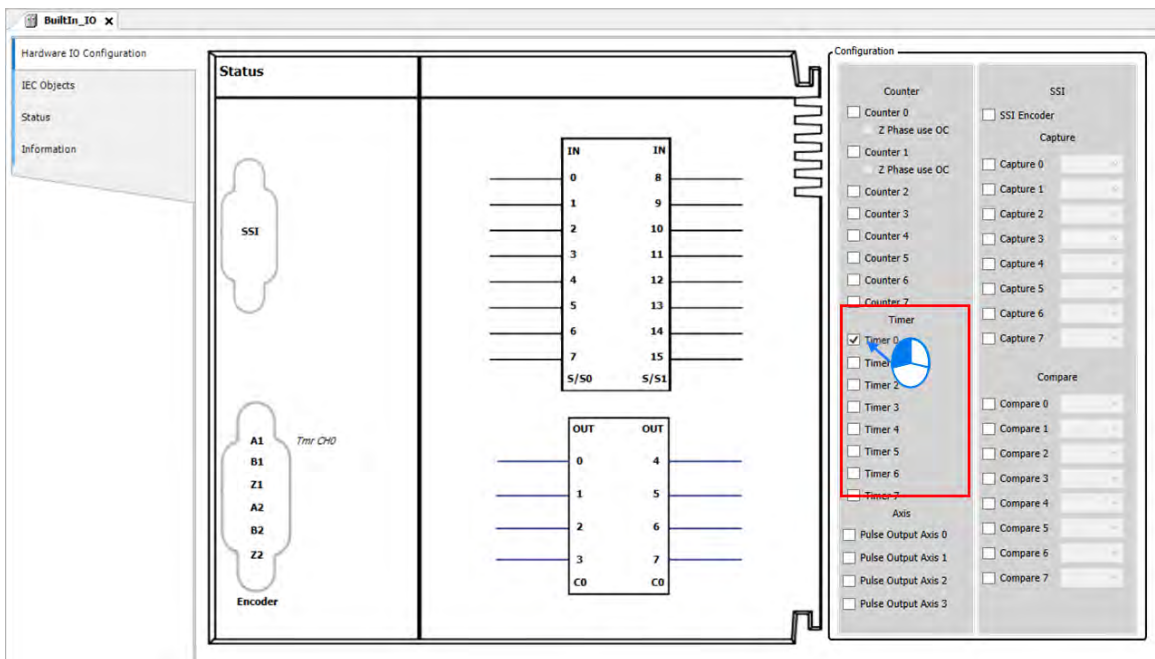

- **Timer mapping variable setting**
 - Right click “BuiltIn_IO” and choose Edit IO Mapping.

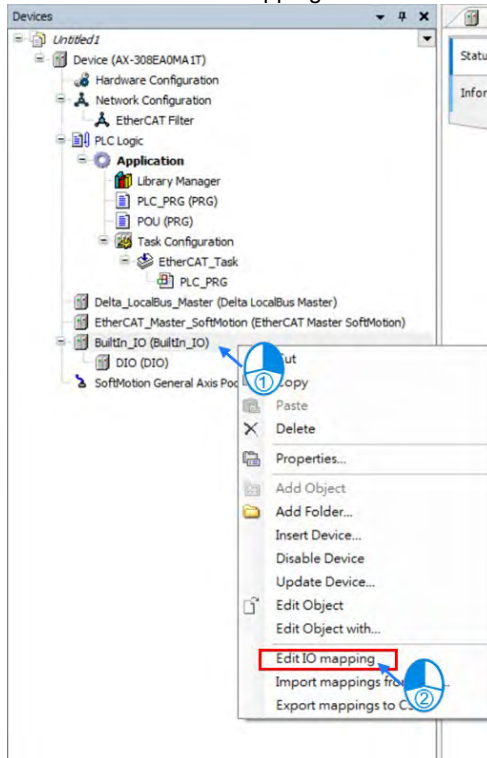

- Click  to add new variables on Edit IO Mapping page.

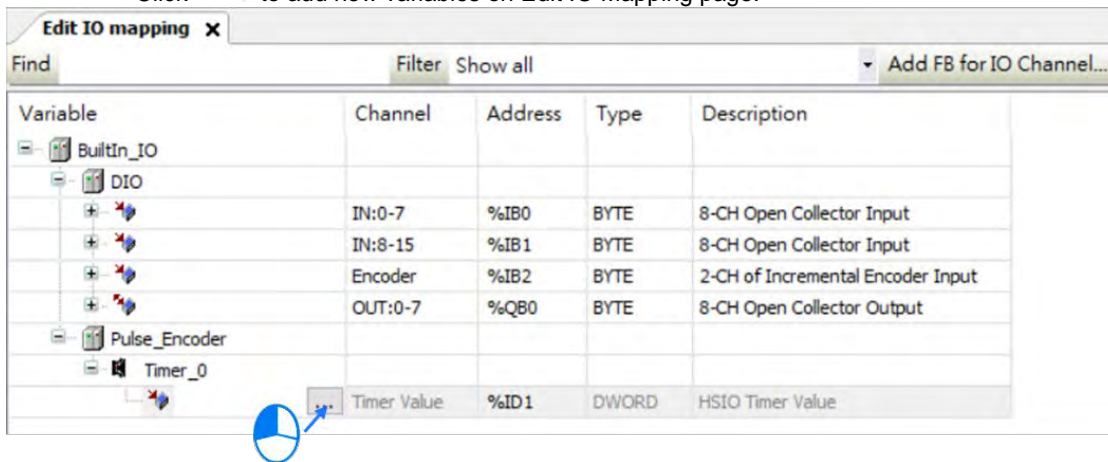

• **Use Timer in program**

The Timer variables can be used for MC function blocks in POU.

- Click "IEC Objects" on BuiltIn_IO page.

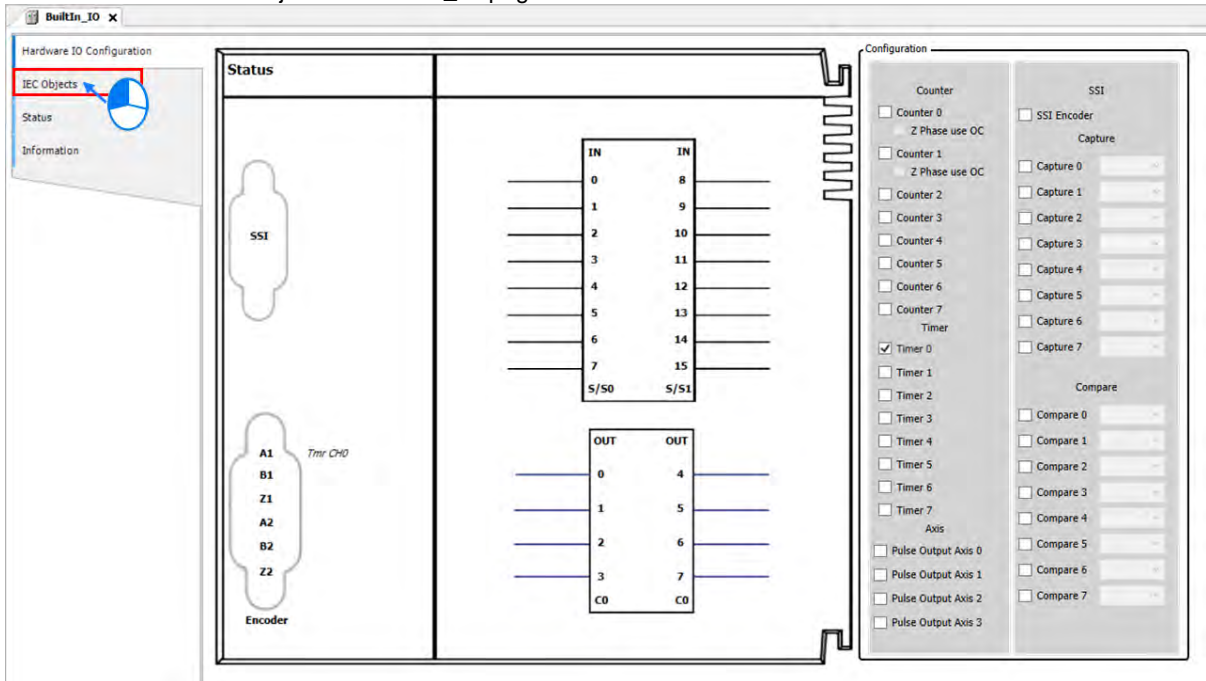

- The column marked ① on the IEC Objects tab is the configuration function of each variable. For the axis used in POU, the axis name should be set as Timer_0.

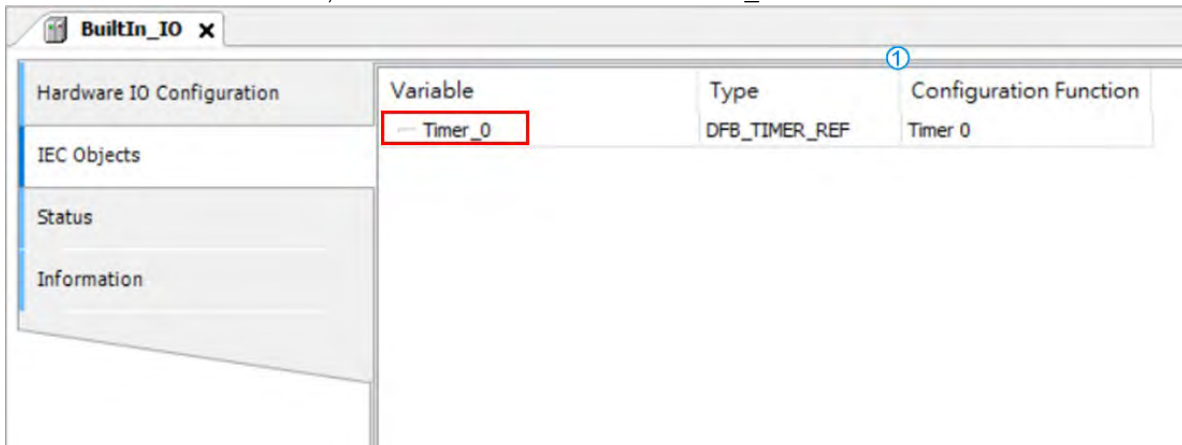

- To enable Timer function, DFB_HTmr_0 is required to use. For DFB_HTmr_0 function block in POU, enter Timer_0 as the axis name.

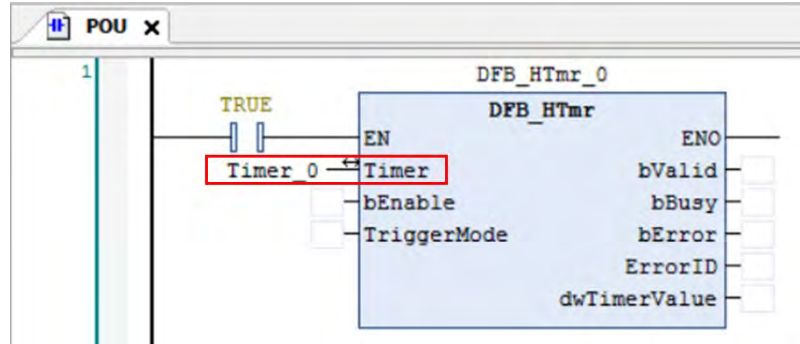

7.7.7.5 Capture/Compare Function Settings

This section introduces the Capture and Compare function modules with built-in high-speed counters. A maximum of 8 groups of high-speed captures and compares can be supported by AX series motion controllers.

- **Capture**

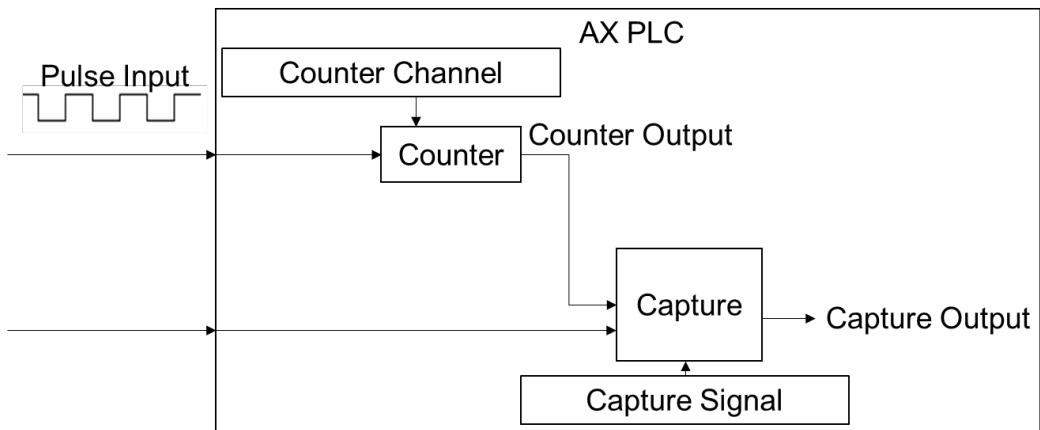

- **Enable Capture function**

- Select one of the 8 Capture groups to activate on the BuiltIn_IO page.

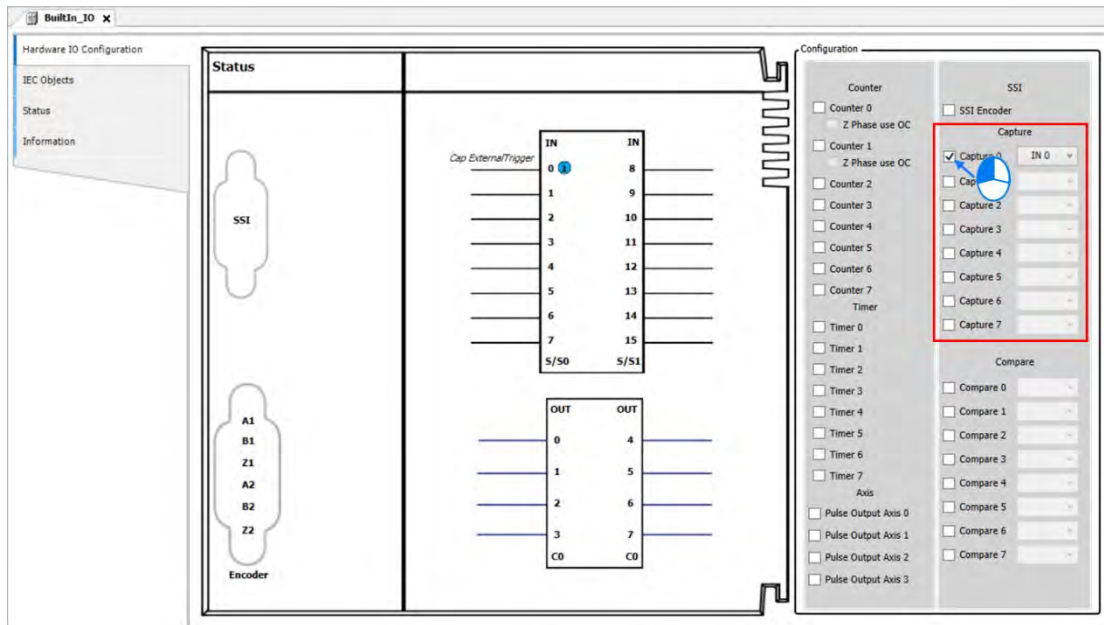

- Then choose the external trigger input from the drop-down list after activating Capture.

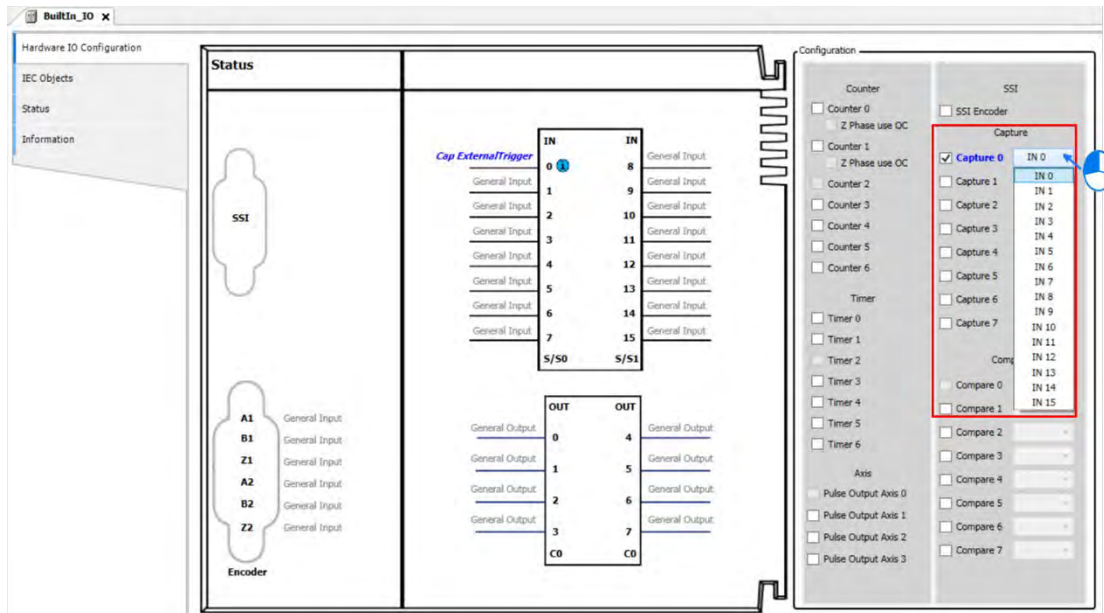

- **Use Capture in program**

The Capture variables can be used for MC function blocks in POU.

- Click "IEC Objects" on BuiltIn_IO page.

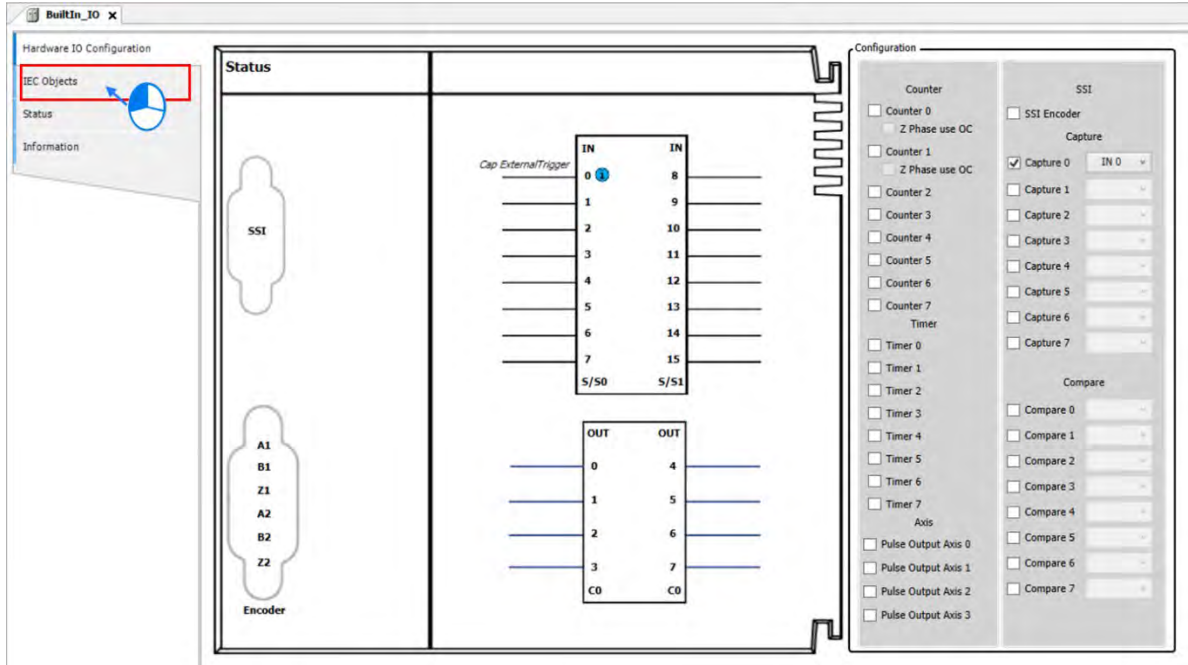

- The column marked ① on the IEC Objects tab is the configuration function of each variable. For the axis used in POU, the axis name should be set as Capture_0.

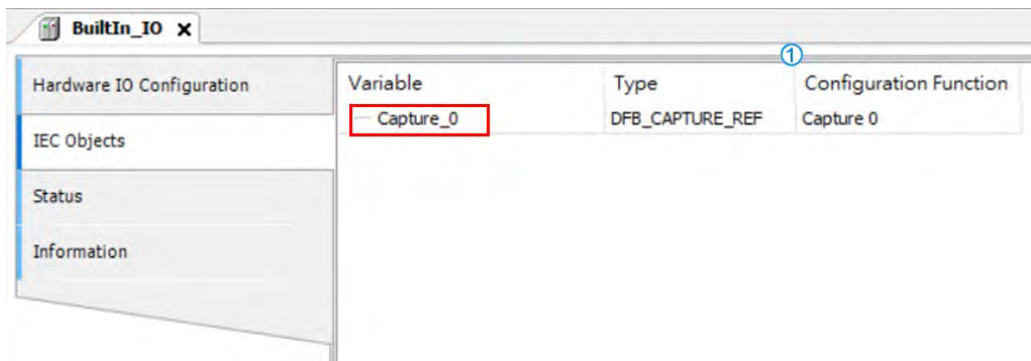

- For DFB_Capture function block in POU, enter Capture_0 as the axis name.

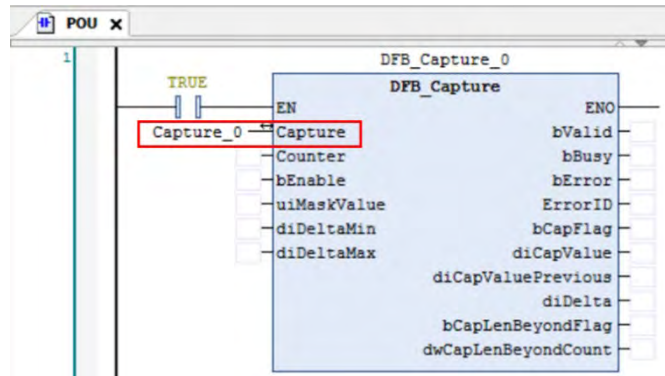

- **Compare**

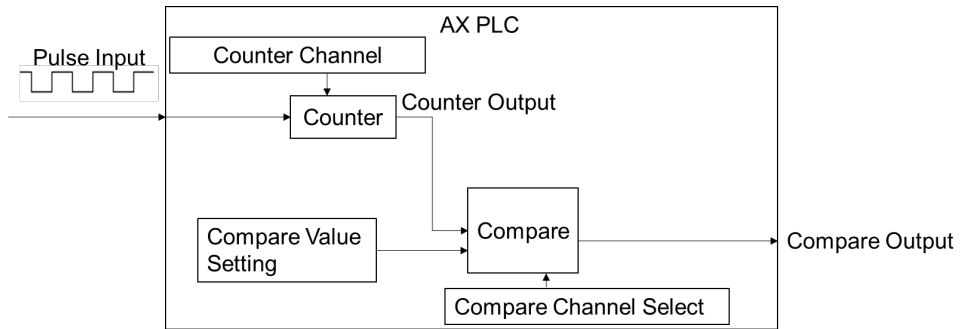

- **Enable Compare function**

- Select one of the 8 Compare groups to activate on the BuiltIn_IO page.

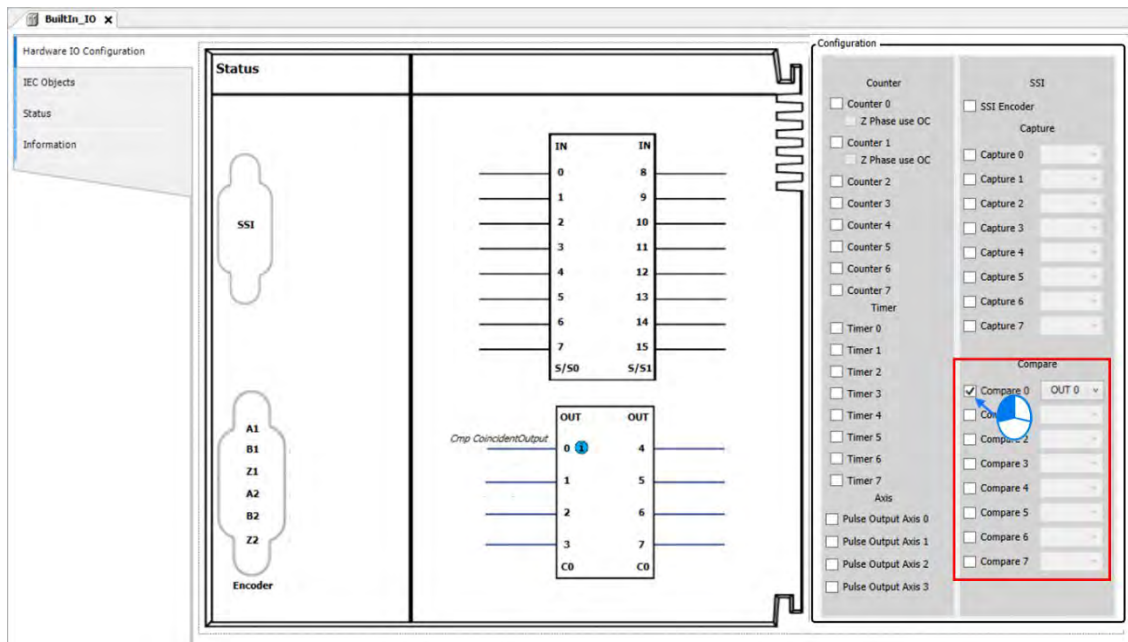

- Then choose the external trigger output from the drop-down list after activating Compare.

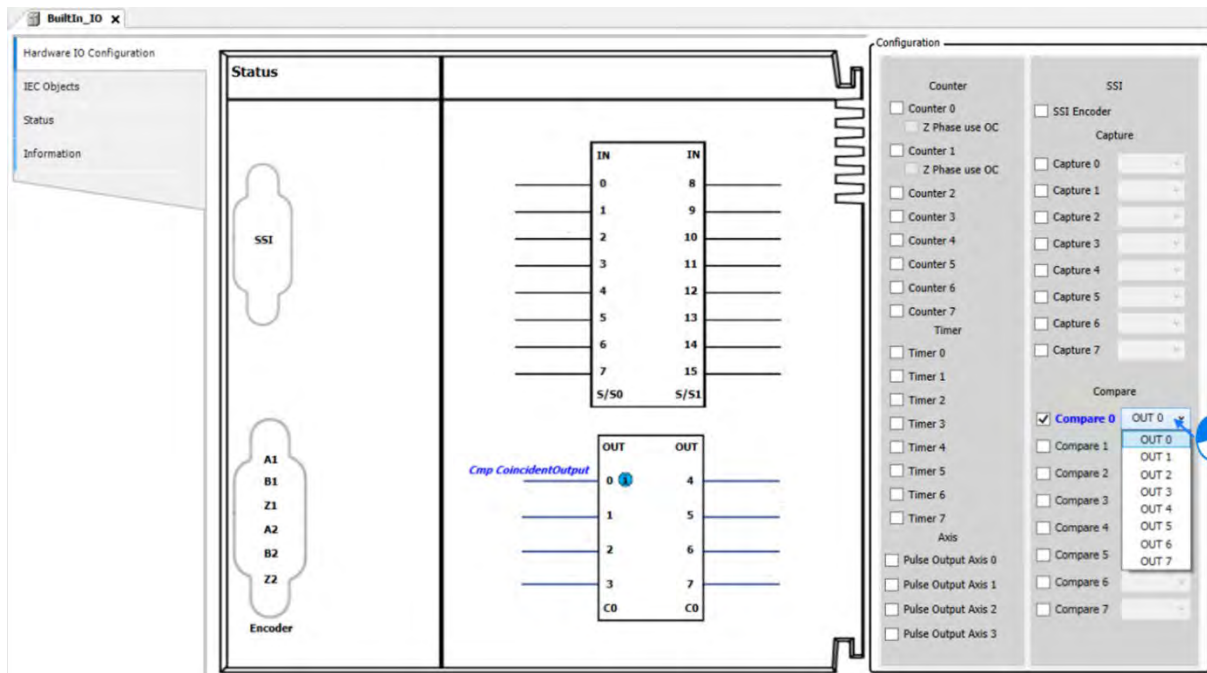

- Use Compare in program**

The Compare variables can be used for MC function blocks in POU.

- Click "IEC Objects" on BuiltIn_IO page.

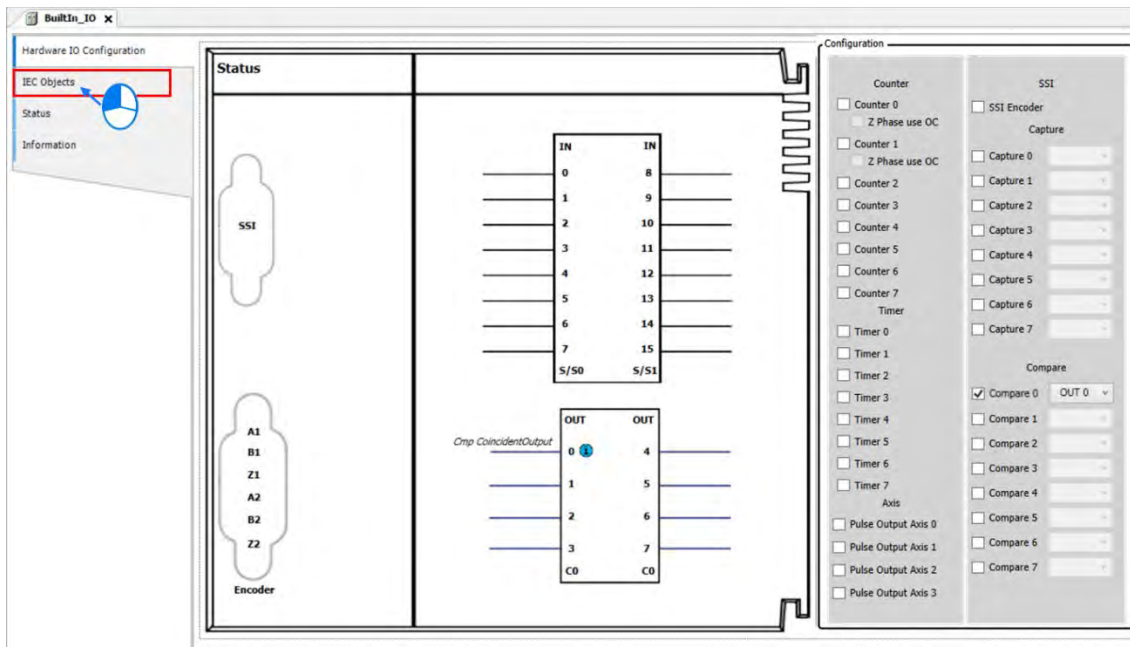

- The column marked ① on the IEC Objects tab is the configuration function of each variable. For the axis used in POU, the axis name should be set as Compare _0.

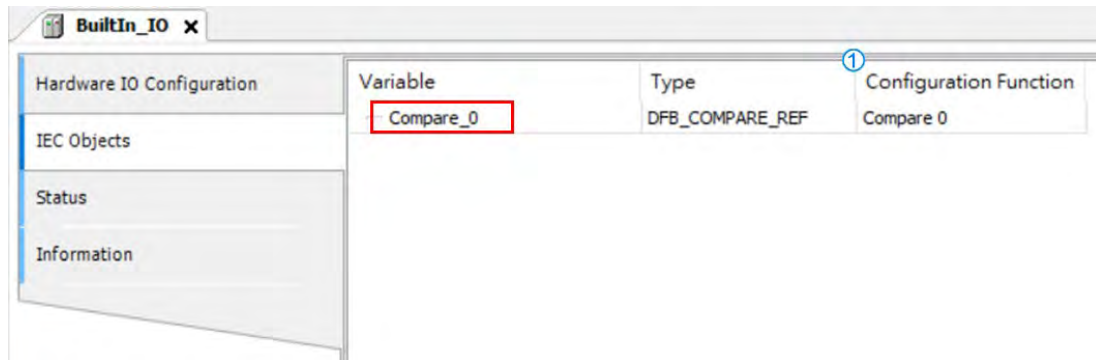

- For DFB_Compare function block in POU, enter Compare _0 as the axis name.

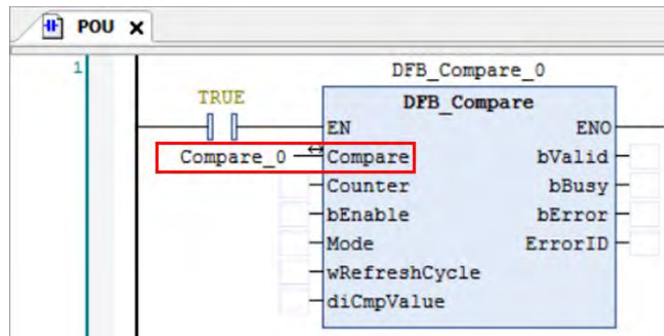

7.7.7.6 Pulse Output Function Settings

This section introduces pulse output function modules with built in IO shown as follows

For AX-3 Series PLC CPU: A maximum of 4 groups pulse-output units can be used with AX-308E series motion controllers.

For AX332E: Only one group of pulse-output unit can be used with AX332E.

- **Activate axis function**

- Choose one of the four pulse output axes to activate on BuiltIn_IO page.

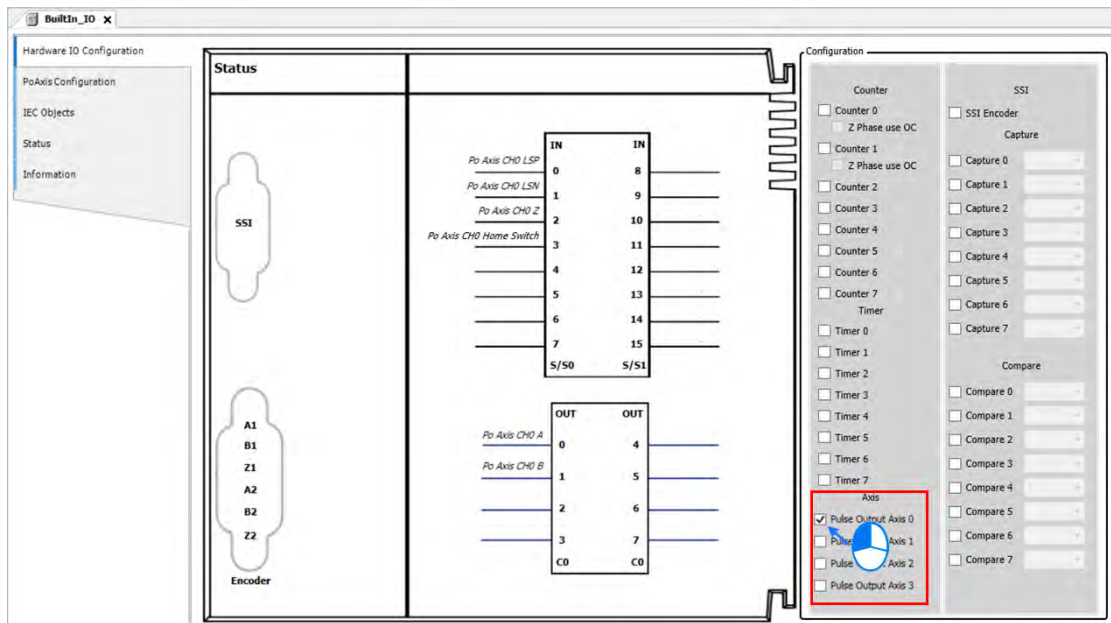

- Click "PoAxis Configuration" after activating Axis.

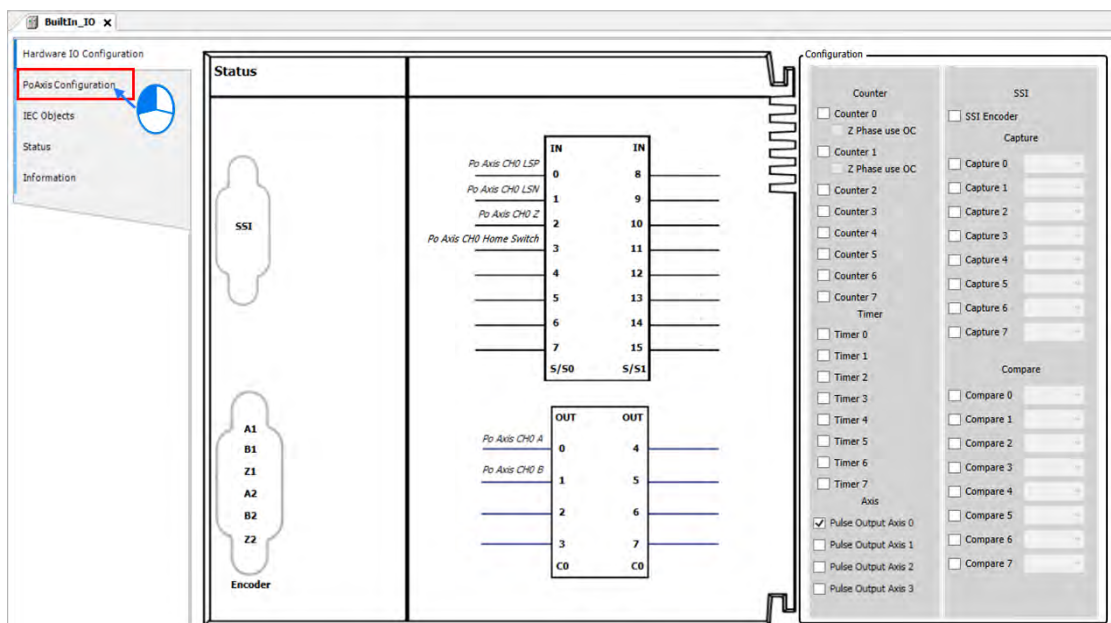

- Click to enter Axis 0 tab on PoAxis Configuration page.

Axis 0

Pulse Output Mode Setting

Mode: A/B

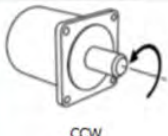
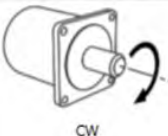
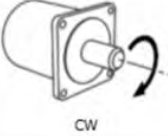
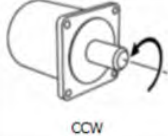
	Positive Command	Negative Command
<input checked="" type="radio"/> Reverse OFF		
<input type="radio"/> Reverse On		

Axis Type and Limits

Virtual mode

Linear Axis

Rotary Axis

Linear Axis Software Limits

Activated

Negative [u]:

Positive [u]:

Rotary Axis Modulo Setting

Modulo value [u]:

Motion Parameter

Error Reaction

Quick Stop Deceleration [u/s²]:

Velocity Ramp Type

Trapezoid Sin² Quadratic Quadratic(smooth)

Transmission Mechanism

Mechanism Type: Ball Screw

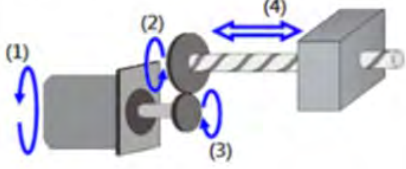

Mechanism Setting

(1) Command pulse per motor rotation: [Pulse]

(4) Pitch: [Unit]

Gear Box

Gear Ratio = $\frac{(2) \text{ Gear ratio numerator } \input{type="text" value="1"}{(3) \text{ Gear ratio denominator } \input{type="text" value="1"}}$

- Axis-related settings can be configured on Pulse Output Setting page, which is described in the following information.

1 Pulse Output Setting
Mode Setting
Mode: A/B

Reverse OFF (CCW, CW)
Reverse ON (CW, CCW)

2 Axis Type and Limits
Virtual mode:
Linear Axis:
Rotary Axis:
Linear Axis Software Limits: Activated
Negative [u]: 0
Positive [u]: 1000
Rotary Axis Modulo Setting: Modulo value [u]: 360

Motion Parameter
5 Error Reaction: Quick Stop Deceleration [u/s²]: 1000
6 Velocity Ramp Type: Trapezoid Sin² Quadratic Quadratic(smooth)

7 Transmission Mechanism
Mechanism Type: Ball Screw
Mechanism Setting:
(1) Command pulse per motor rotation: 10000 [Pulse]
(4) Pitch: 10000 [Unit]
Gear Box:
Gear Ratio = (2) Gear ratio numerator: 1 / (3) Gear ratio denominator: 1

8 Homing Setting
Homing Mode: Mode 35
Homing speed during search for switch: 100 [Unit/s]
Homing speed during search for z phase pulse: 50 [Unit/s]
Homing Acceleration: 1000 [Unit/s²]
Description:
Mode 35 : Depending on the current position
In mode 35, The homing instruction is executed, the axis does not move and its current position is regarded as the home position.

① Mode setting

Item	Funtion	Setting Value (Default)
Mode	Set the type of pulse output.	CW/CCW Pulse and Direction (A/B)
Reverse ONn/ Reverse OFF	Set the pulse axis to rotate in positive or negative direction.	Reverse ONn Reverse OFF (Reverse OFF)

② Axis Type and Limits

Item	Funtion	Setting Value (Default)
Virtual	Activate virtual axes.	TRUE FALSE (FALSE)
Linear Axis / Rotary Axis	Set the axis type to be linear axis or rotary axis.	Linear Axis Rotary Axis (Linear Axis)

③ Linear Axis Software Limits

Item	Funtion	Setting Value (Default)
Activated	Activate software limit (only supports linear axis)	TRUE/FALSE (FALSE)
Negative[u]	Set the negative software limit.	(0)
Positive[u]	Set the positive software limit.	(10000)

④ Rotary Axis Modulo Setting

Item	Funtion	Setting Value (Default)
Modulo Value[u]	Set the area of rotation for a turn. (only supports rotary axes)	(360)

⑤ Error Reaction

Item	Funtion	Setting Value (Default)
Quick Stop	Stop the axis immediately.	(360)
Deceleration[u/s ²]	The axis will perform a deceleration stop. (functional only when Quick Stop is not activated)	(10000)

⑥ Velocity Ramp Type

Item	Funtion	Setting Value (Default)
Trapezoid/Sin ² /Quadratic/ Quadratic (Smooth)	Set the ramp type for axis motion.	(Trapezoid)

⑦ Software Configuration Page: Please refer to 7.7.7.3 SSI Encoder Setting

⑧ Homing Setting

Item	Function	Setting Value (Default)
Homing Mode	Set the homing mode.	(Mode 351)
Homing speed during search for switch	Set the homing speed during search for switch.	(1000)
Homing speed during search for z phase pulse	Set the homing speed during search for z phase pulse.	(50)
Homing Acceleration	Set the homing acceleration.	(10000)

• Use Pulse Axis in program

To use Pulse Axis in POU, Pulse Output Axis variables are required for MC function blocks in POU.

- Click “IEC Objects” on BuiltIn_IO page.

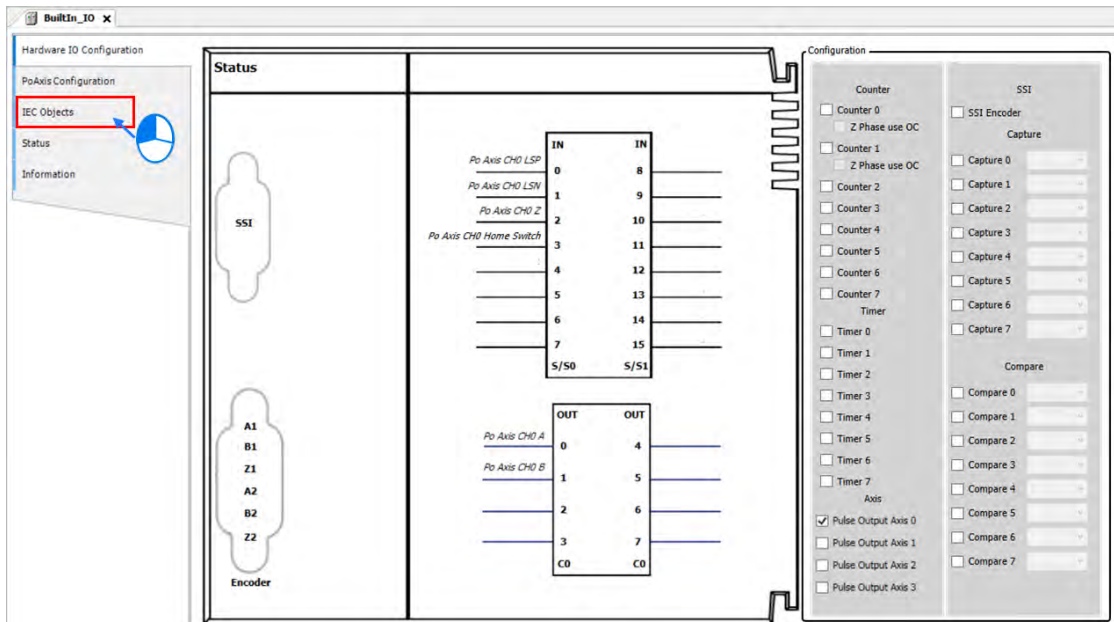

- The column marked ① on the IEC Objects tab is the configuration function of each variable. For the axis used in POU, the axis name should be set as Pulse_Output_Axis_0.

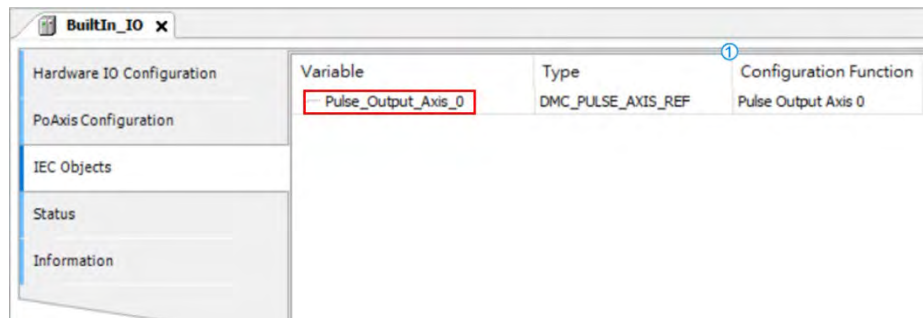

- For MC_Power function block in POU, enter Pulse_Output_Axis_0 as the axis name.

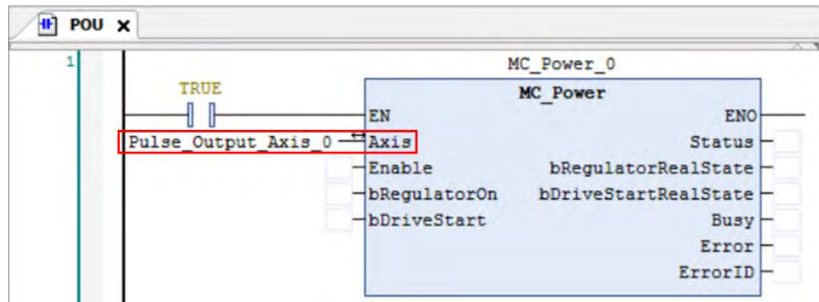

7.7.7.7 Confirm High-Speed IO Errors

Errors in Pulse Output Axis are displayed on Status tab under BuiltIn_IO page with messages notifying you of which pulse axis has error.

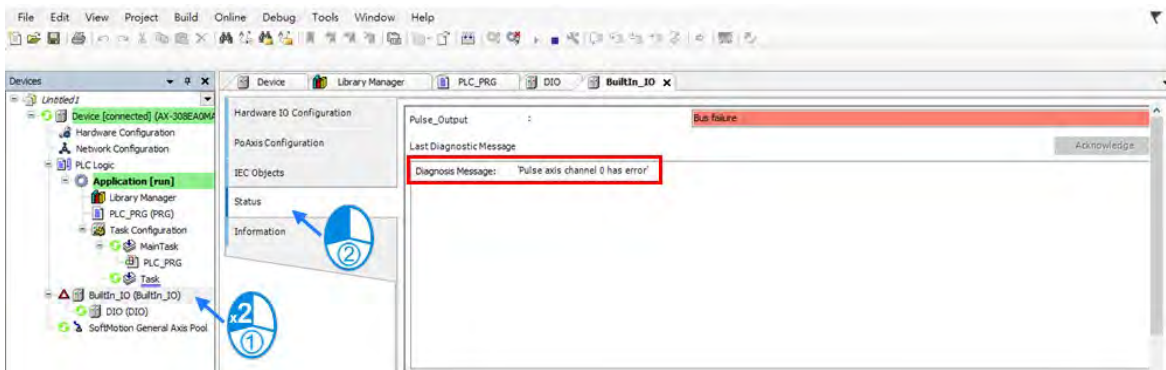

You can continue to check and monitor the error information on PoAxis Configuration tab page.

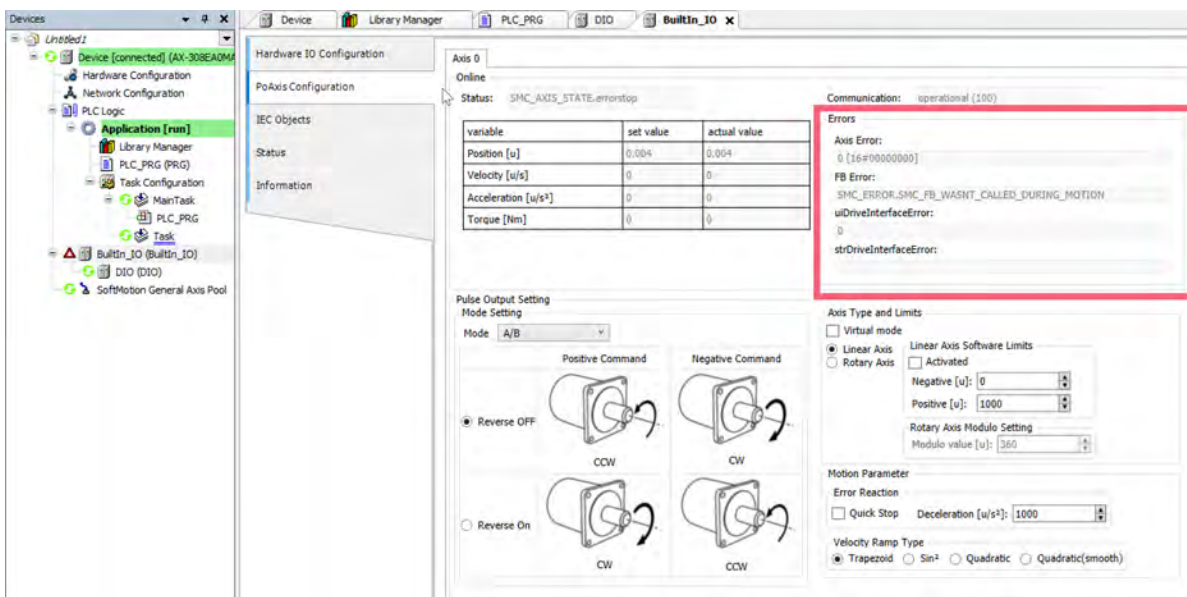

7.7.8 Other Features

7.7.8.1 Change Current Position

■ MC_SetPosition

This function block is to change the current position by shifting the coordinate system of an axis.

The changing of the coordinate system is made by modifying both the current position of the instruction (command position) and the actual position from the feedback signals with the same value.

The following error between command position and actual position remains the same value.

The function block is used to change the coordinate system and does not lead to servo drive and motor movement. And the current position of the encoder axis can be edited by this function block.

■ Timing diagram

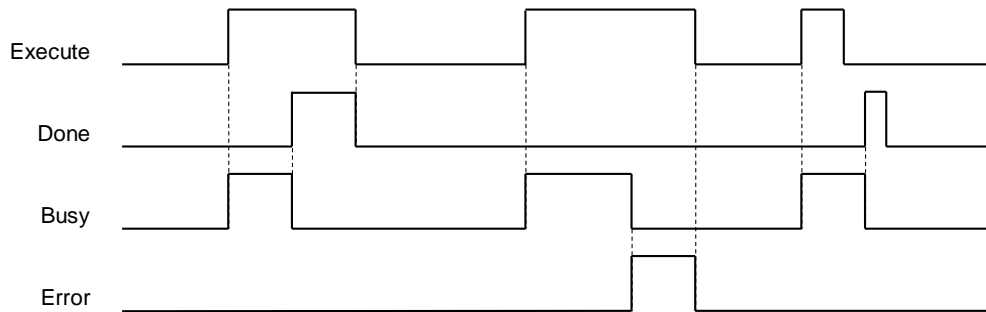

7.7.8.2 Software Limit

In addition to hardware limit, the range of axis motion can also be limited by software limit.

Values for forward and reverse limit range need to be set before activating software limit. Software limit is set to be not activated as default so as to prevent any damage to the device when an operator error occurs.

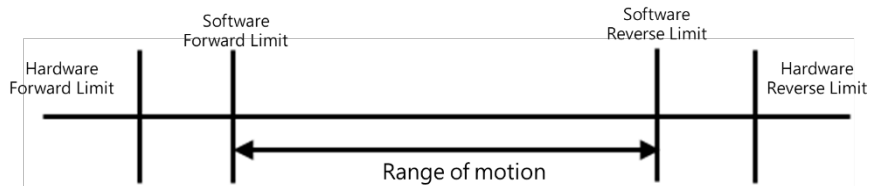

Note: Refer to section 7.7.2.4 for example on Stop Method.

- **Software display**

Can be configured via DIADesigner-AX software.

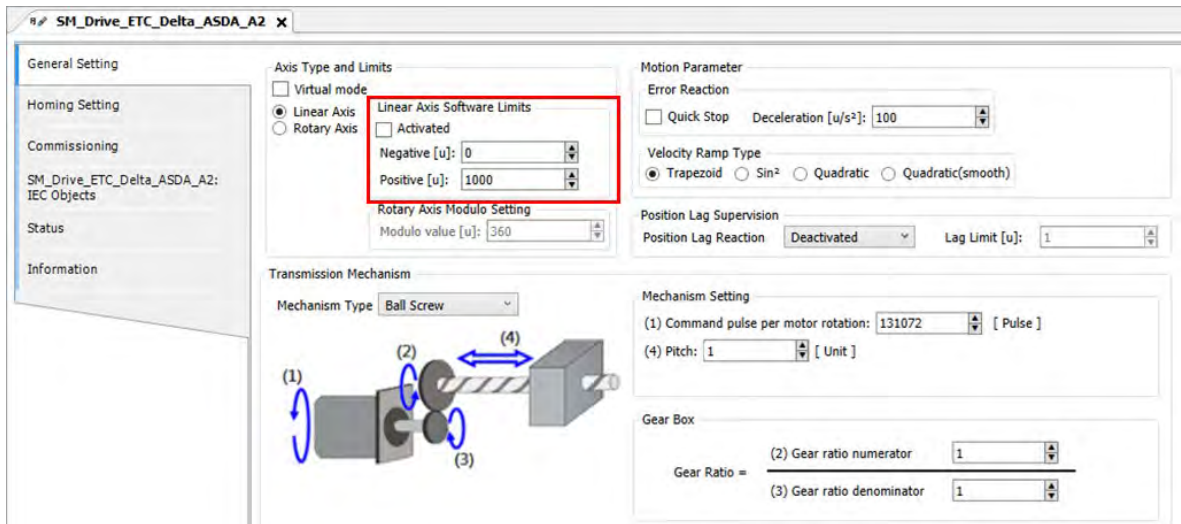

The positive and negative position are able to be resized on the configuration page:

Item	Data Type	Default Setting
Negative	LREAL	0.0
Position	LREAL	10000.0

7.7.8.3 Position Lag Setting

The command position as well as feedback position are located at zero while the axis is in motion. If there's a great difference between command position and feedback position, an error will be reported.

The position lag reaction is set to be "Stay Enabled" as default.

Setting mode	Function
Deactivated	Not activated.
Disable drive	When position lag exceeds limit setting, axis will shift to servo off.
Do quickstop	When position lag exceeds limit setting, axis will shift to quick stop.
Stay enabled	When position lag exceeds limit setting, axis will remain as servo on.

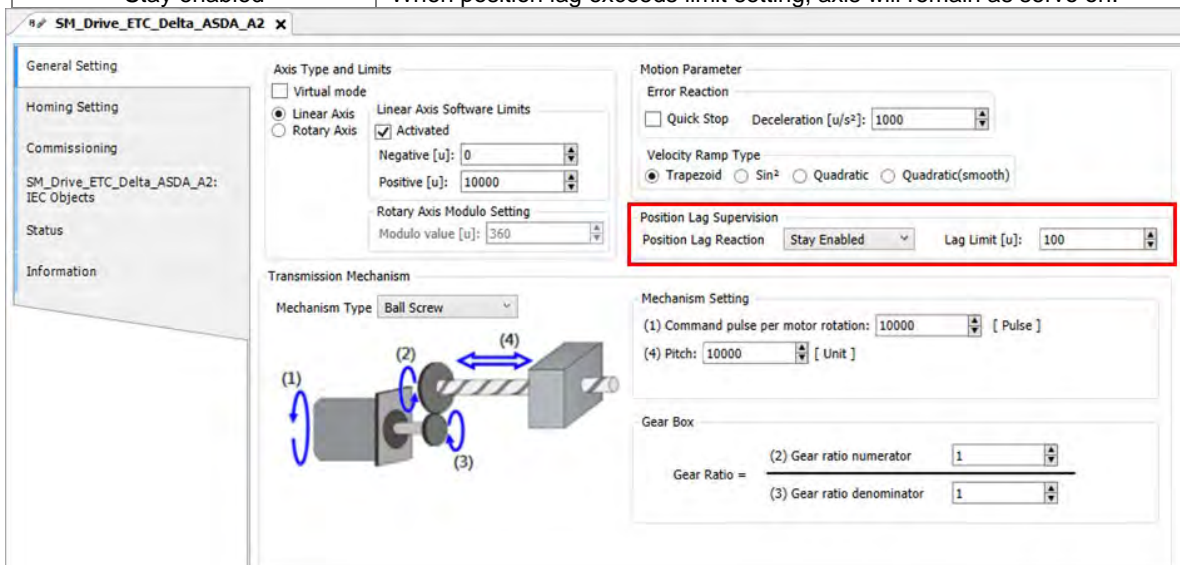

7.7.8.4 Cam Switch Function

MC_DigitalCamSwitch

Specify the tappet position. True when the moving axis reaches the specified position, then turn to False when passing it. The following example regards to configuration settings.

- Example: Use two switches in the same track with MC_DigitalCamSwitch instruction.

- Parameter setting

Parameter	Type	Switch1	Switch2
TrackNumber	INT	1	1
FirstOnPosition [u]	REAL	200	400
LastOnPosition [u]	REAL	300	-
AxisDirection	INT	0=Both	0=Both
CamSwitchMode	INT	0=Position	1=TIME
Duration	TIME	-	2500ms

- Trigger and timing

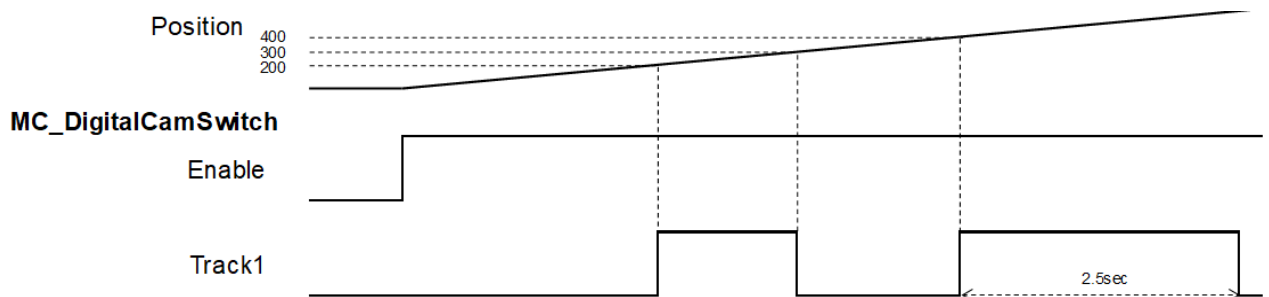

- Switch 1 on Track 1 is ON when the position reaches 200 and turns to OFF once the axis position reaches 300.
- When the position reaches 400, Switch 1 turns to ON again for 2500ms and then shifts to OFF.

7.7.8.5 Position Capture

MC_TouchProbe captures and records an axis position when a trigger event occurs.

A total of two trigger signals can be configured for each axis. MC_AbortTrigger is used to abort capture function.

Function description:

- The touch probe operation activates for only one time for recording the very first trigger signal after Execute is set as True. When a valid position is captured and recorded, the following trigger signals will be ignored.
- One function block instance should relate to only one MC_TouchProbe instruction.
- If there were multiple function block instances on the same capture and axis, the members of MC_TRIGGER_REF should be added with TouchProbeID, which identifies different TouchProbe actions. The definition of TouchProbeID can be associated to MC_AbortTrigger.
- The operation of MC_TouchProbe with window mask function is demonstrated as below:

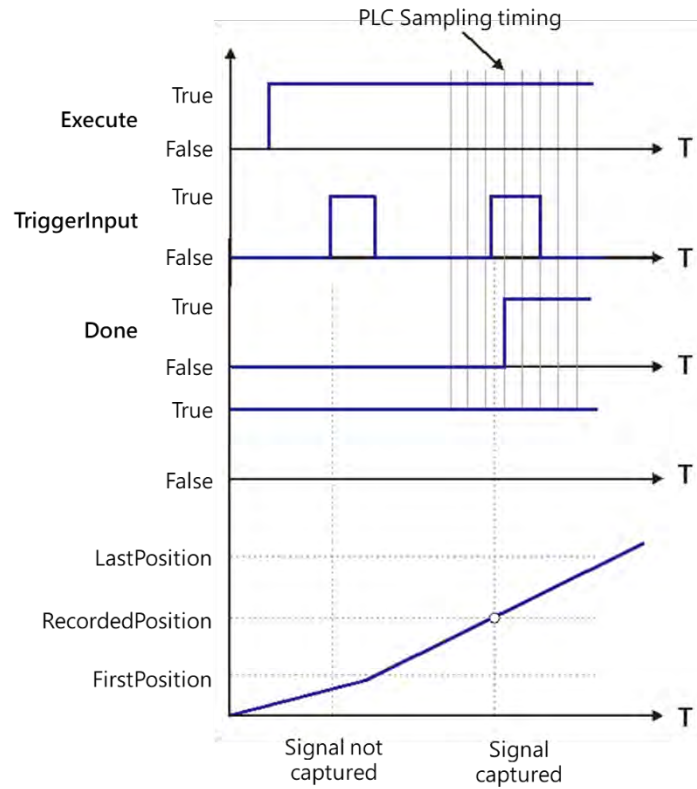

- At the first activation of the trigger input signal, the signal is not accepted because the axis position hasn't reach the specified window mask section.
- - When the axis position enters the window mask section, the second activation of the trigger input signal is accepted, and after a period Done chnages to True.

7.8 Programming Example

The following section explains on the basis of the programming example.

7.8.1 Device Framework

The following devices are used in the example.

Device	Model Name
CPU	AX-308E
Power	DVP-PS02
Servo driver	Delta ASDA-A2-E
Servo motor	Delta ECMA-C

7.8.1.1 Utilization

Please refer to the following manuals for information regarding device configuration and wiring.

Device	Reference
CPU and Power	Chapter 2 in this manual
Servo driver	Related configuration description in Delta servo drive user manuals
Wiring for EtherCAT slave device	Delta ASDA A2-E EtherCAT Interface Servo Drive User Manual

7.8.1.2 Configurations

The following configuration is applied in the example in the next section.

Device	Configuration setting
Controller	Chapter 2 in this manual
Motion control settings	Chapter 7 in this manual
Servo parameters	Use the default settings of ASDA-A2-E slave, gear ratio=10000 : 10000

7.8.2 Examples

The following example uses the same POU in EtherCAT task to explain. Also, the required variables will be declared and used in this POU Task. (The POU naming in LD and ST languages will be different for illustration purpose.)

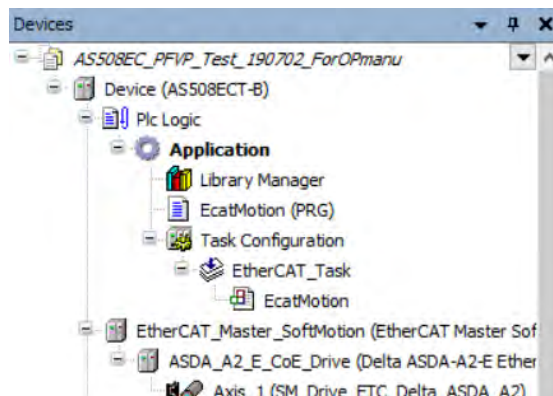

The Interval time for ECAT synchronization is set to be 4 ms.

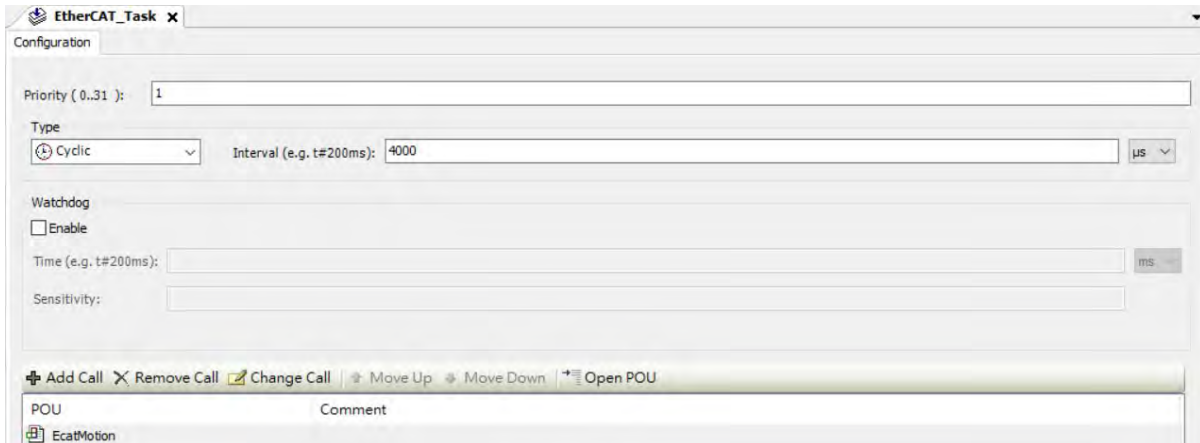

Set the gear ratio as 10000:10000 for mechanism setting.

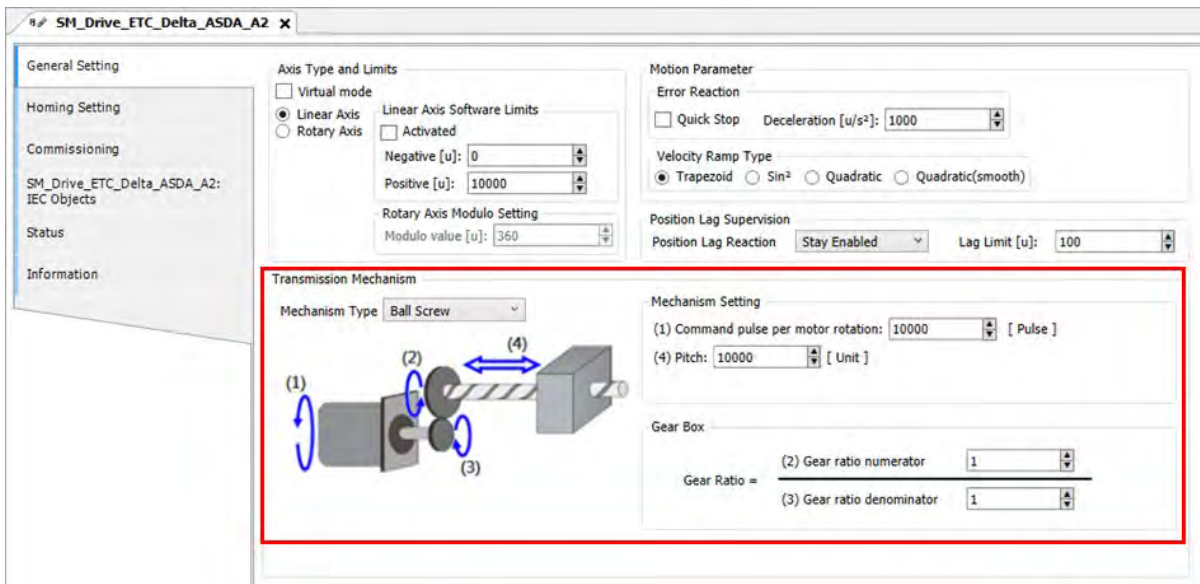

7.8.2.1 Servo On

Execute MC_Power (Servo on) instruction to activate the servo driver after the EtherCAT communication is built in the following example with LD and ST programming languages supported.

■ **Main variables used in programming**

Variable	Data Type	Default	Note
SM_Drive_Virtual	AXIS_REF_SM3	-	Virtual axis variable
Start	BOOL	FALSE	Shift to True when start the server and enable Servo On

■ **LD language**

Check for the successful EtherCAT communication when Start is True so as to enable MC_Power via ServoOn output, which the status should be True.

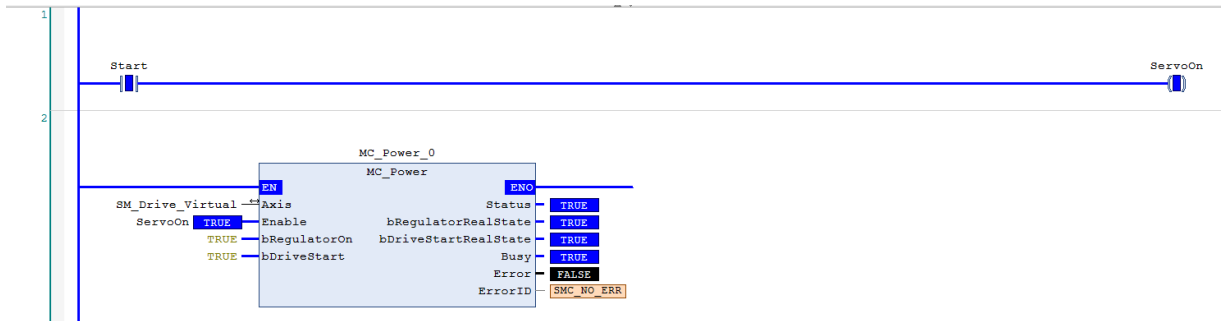

■ **ST language**

Check for the successful EtherCAT communication when Start is True so as to enable MC_Power via ServoOn output, which the status should be True.

Monitoring window can also be used to observe the variable output status with no need for naming the output variables.

```
IF Start THEN
    ServoOn :=TRUE;
ELSE
    ServoOn :=FALSE;
END_IF
```

```
//MC_Power
MC_Power_0(
    Axis:= SM_Drive_Virtual,
    Enable:= ServoOn,
    bRegulatorOn:= TRUE,
    bDriveStart:= TRUE,
    Status=> ,
    bRegulatorRealState=> ,
    bDriveStartRealState=> ,
    Busy=> ,
    Error=> ,
    ErrorID=> );
```

7.8.2.2 Reset and Control Single-axis Error

You can view the error information of variable status through Watch table. Take MC_MoveVelocity input as example, when acceleration value is set as 0 and Execute is True, an error will occur in the function block and the ErrorID displays Row Data 301. You can find the complete error message in the Watch table, which is SMC_MV_INVALID_ACCDEC_VALUES. After troubleshooting with manual's help, MC_MoveVelocity can function normally by shifting the Execute status from False to True. As for MC_Reset, it is used for clearing servo errors.

The following example supports with LD and ST programming languages.

- **Main variables used in programming**

Variable	Data Type	Default	Note
SM_Drive_Virtual	AXIS_REF_SM3	-	Virtual axis variables
ServoOn	BOOL	FALSE	To enable MC_Power
MC_MoveVelocity0_Execute	BOOL	FALSE	Execute input of velocity instruction
MC_MoveVelocity0_Acceleration	LREAL	0	Acceleration input of velocity instruction, for setting acceleration.
MC_DIRECTION.positive	MC_Direction	-	Assigned moving direction-positive
FBErrorOccured	MC_ReadStatus	FALSE	True when an error occurs in the function block
ClearErr	BOOL	FALSE	When FBErrorOccured is True, FB errors can be clear by triggering SMC_ClearFBError

- **Timing Diagram**

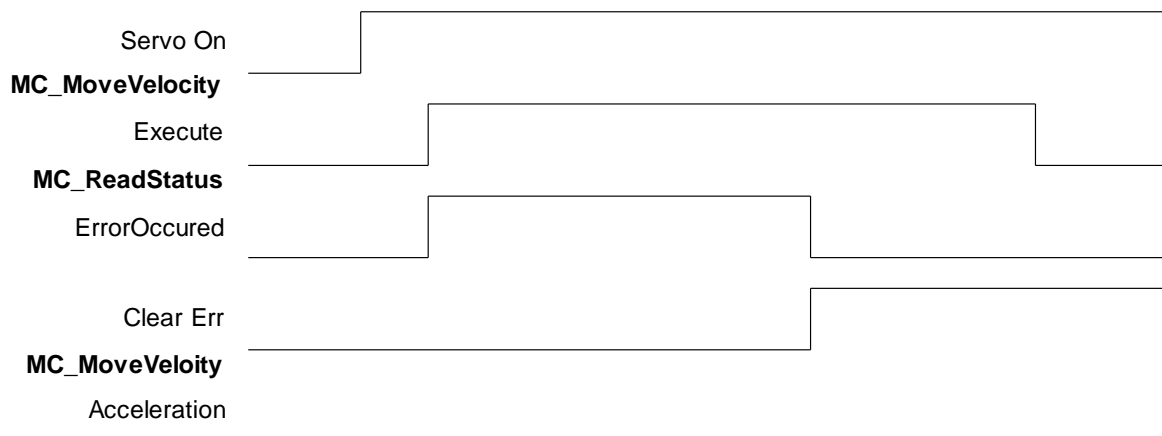

● LD Language

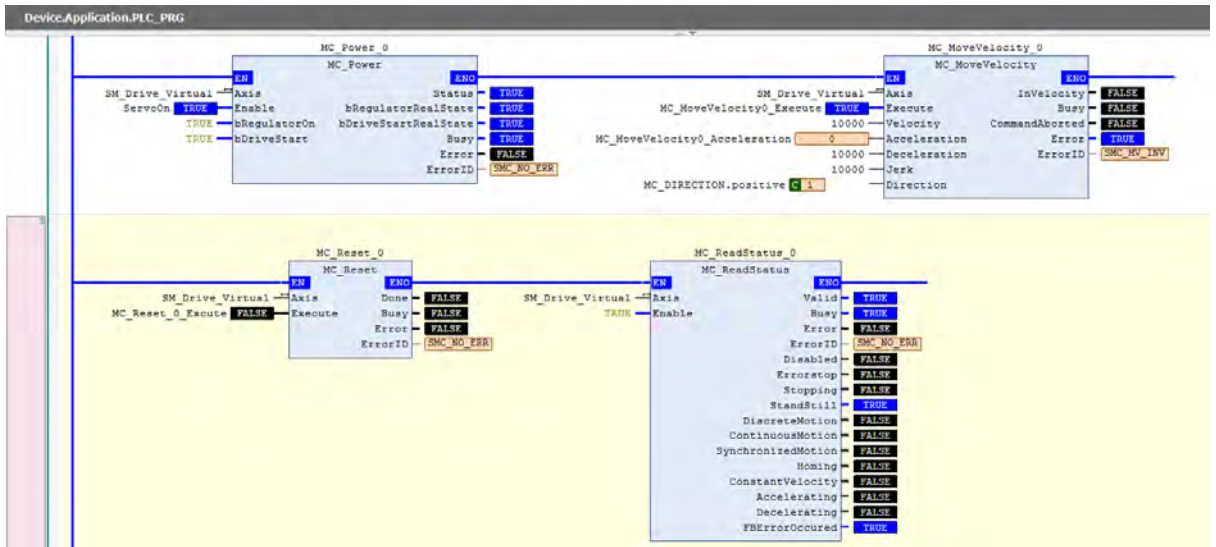

Via function SMC_ClearFBError that error can be deleted and output FBErrorOccurred of MC_ReadStatus would shift to False, once an error occurs in the function block. In addition, since input of SMC_ClearFBError need to be transferred via pointers, ADR(input) must be fed and use bool to clear FB error flag.

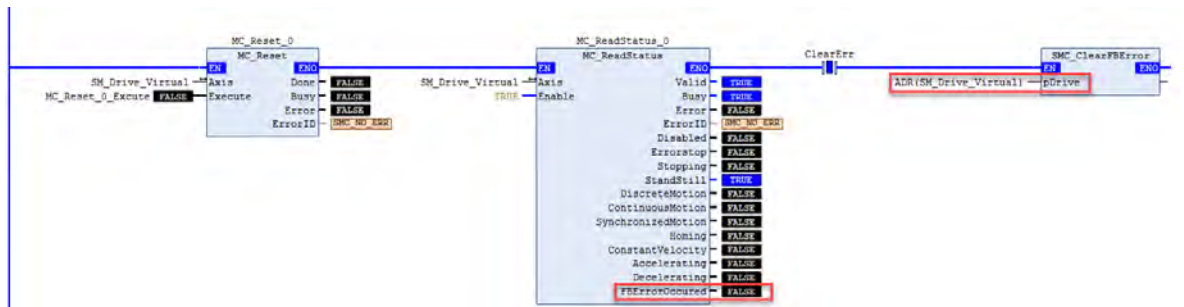

Watch 1

Expression	Application	Type	Value	Prepared v..	Executionpoint	Address	Comment
PLC_PRG.MC_MoveVelocity_0...	Device.Application	SMC_ERROR	SMC_MV_INVALID_ACCDEC_VALUES		Cyclic Monitoring		Error identification

'SMC_ERROR.SMC_MV_INVALID_ACCDEC_VALUES' represents raw value '301'

Disable Execute input of MC_MoveVelocity to update the status of Error output.



Set acceleration of MC_MoveVelocity to be 10000 and restart (Execute is True). The output of MC_MoveVelocity would be Busy with values of fSetVelocity and fSetPosition shown on the Watch table under normal operation.

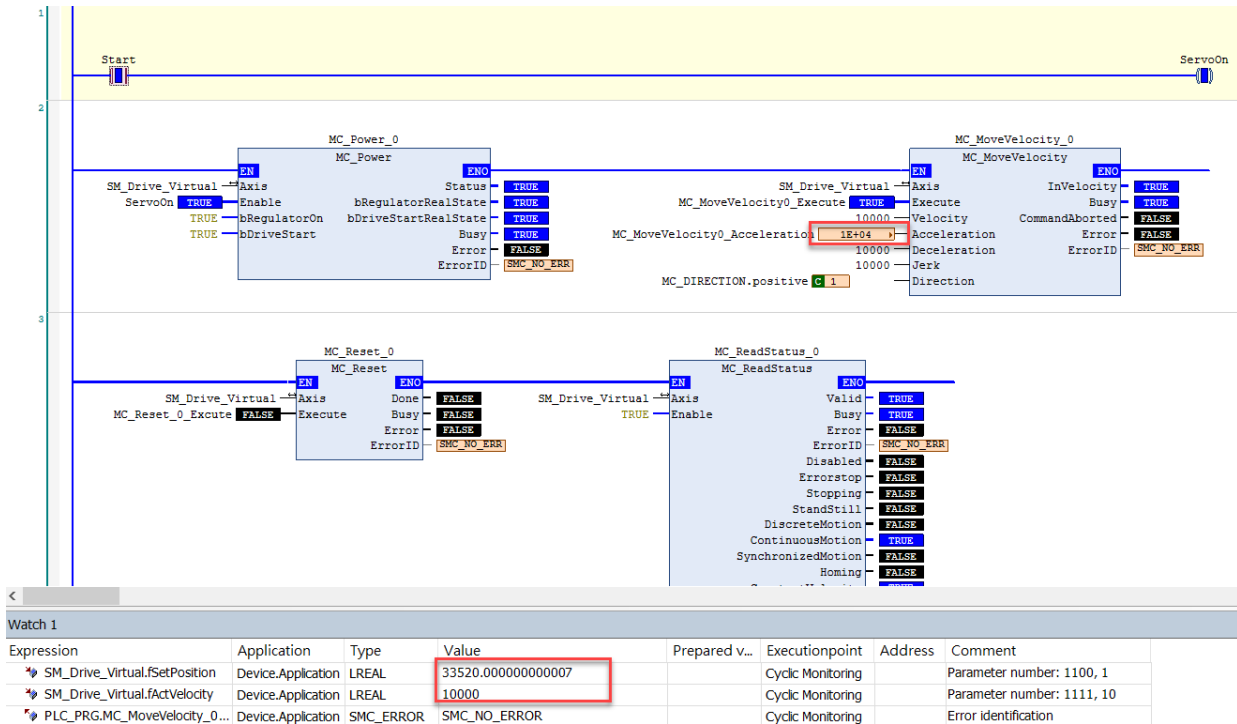

● **ST Language**

```

MC_MoveVelocity_0(
  Axis:= SM_Drive_Virtual,
  Execute:= MC_MoveVelocity0_Execute,
  Velocity:= 10000,
  Acceleration:= MC_MoveVelocity0_Acceleration,
  Deceleration:= 10000,
  Jerk:= 10000,
  Direction:= MC_DIRECTION.positive,
  InVelocity=> ,
  Busy=> ,
  CommandAborted=> ,
  Error=> ,
  ErrorID=>);
    
```

```

MC_ReadStatus_0(
  Axis:= SM_Drive_Virtual,
  Enable:= TRUE);
    
```

Set acceleration of MC_MoveVelocity to be 10000 and restart (Execute is True). The output of MC_MoveVelocity would be Busy with values of fSetVelocity and fSetPosition shown on the Watch table under normal operation.

```

MC_MoveVelocity_0(
  Axis:= SM_Drive_Virtual,
  Execute:= MC_MoveVelocity0_Execute,
  Velocity:= 10000,
  Acceleration:= MC_MoveVelocity0_Acceleration := 10000,
  Deceleration:= 10000,
  Jerk:= 10000,
  Direction:= MC_DIRECTION.positive,
    
```

```
InVelocity=> ,
Busy=> ,
CommandAborted=> ,
Error=> ,
ErrorID=> );
```

```
MC_ReadStatus_0(
  Axis:= SM_Drive_Virtual,
  Enable:= TRUE );
```

7.8.2.3 Control on Instruction Errors

If an error occurs while executing instruction MC_Power (Servo On), no further action will be taken, while ProgNext indicates whether execution can be moved on. The following example supports with LD and ST programming languages.

- **Main variables used in programming**

Variable	Data Type	Default	Note
SM_Drive_Virtual	AXIS_REF_SM3	-	Virtual axis variables
ServoOn	BOOL	FALSE	To enable MC_Power
ProgNext	BOOL	FALSE	ProgNext indicator shows whether to take further action
MC_Power_0.Status	BOOL	FALSE	Axis is ready to move when the status is True.
MC_Power_0.Busy	BOOL	FALSE	Execution of FB has not been completed when the status is True.

- **Timing Diagram**



● **LD Language**

Check if any errors have occurred in MC_Power before moving onto the next step.

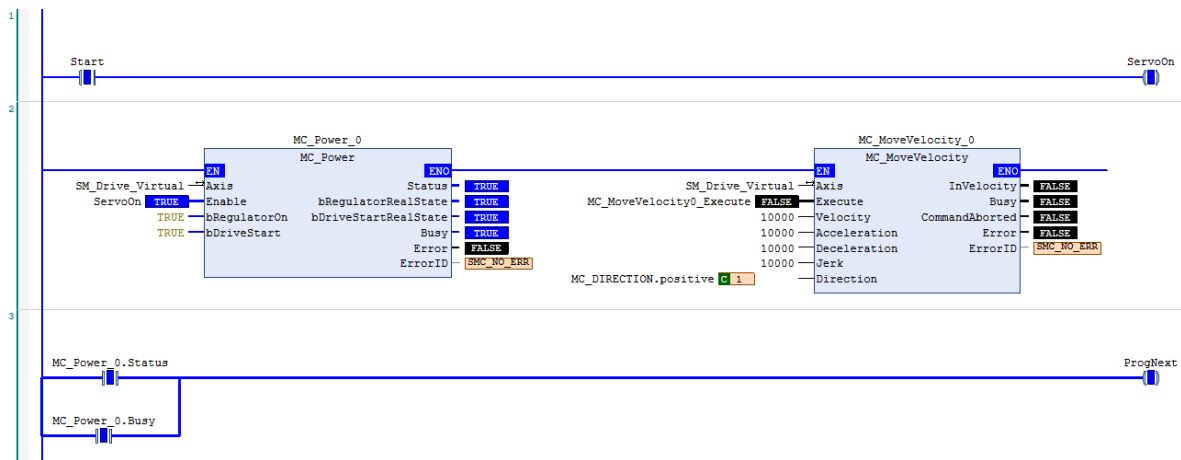

● **ST Language**

IF Start THEN

 ServoOn :=TRUE;

ELSE

 ServoOn :=FALSE;

END_IF

IF (MC_Power_0.Status=TRUE) OR (MC_Power_0.Busy=TRUE) THEN

 ProgNext :=TRUE;

ELSE

 ProgNext :=FALSE;

END_IF

//MC_Power

MC_Power_0(

 Axis:= SM_Drive_Virtual,

 Enable:= ServoOn,

 bRegulatorOn:= TRUE,

 bDriveStart:= TRUE,

 Status=> ,

 bRegulatorRealState=> ,

 bDriveStartRealState=> ,

 Busy=> ,

 Error=> ,

 ErrorID=>);

7.8.2.4 Quick Stop for Single Axes

MC_Stop can be used to stop the moving axis when an error occurs during execution of MC_MoveAbsolute instruction. The following example supports with LD and ST programming languages.

- **Main variables used in programming**

Variable	Data Type	Default	Note
SM_Drive_Virtual	AXIS_REF_SM3	-	Virtual axis variables
ServoOn	BOOL	FALSE	To enable MC_Power
MC_MoveAbsolute0_Execute	BOOL	FALSE	Execute input of MC_MoveAbsolute
MC_DIRECTION.positive	MC_Direction	-	Assigned moving direction-positive (valid for rotary axes)
StopOn	BOOL	FALSE	Activate MC_Stop when the status is True
MC_Stop_0.Done	BOOL	FALSE	Execution of MC_Stop is done when the status is True

- **Timing Diagram**

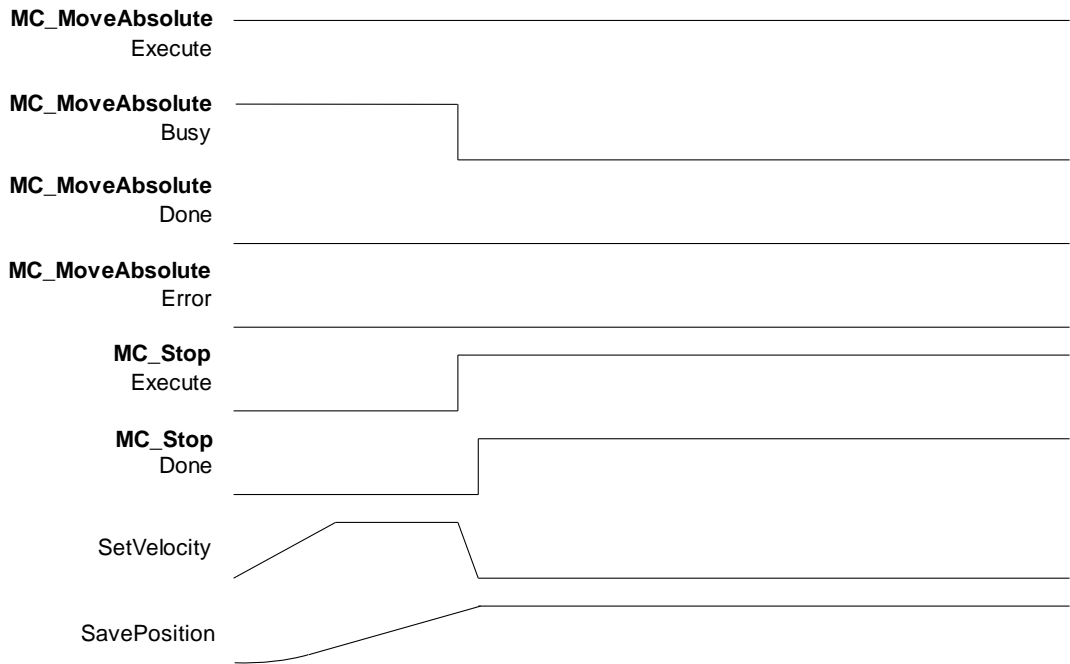

● **LD Language**

Execute homing under normal output status of MC_Power. Once homing is completed, execute MC_MoveAbsolute. At the same time, MC_Stop can be executed for a quick stop if needed, which would abort MC_MoveAbsolute with state True of CommandAborted output so as to command a deceleration stop for axis based on the setting of deceleration, then the Done output of MC_Stop shifts to True after the stop command completed.

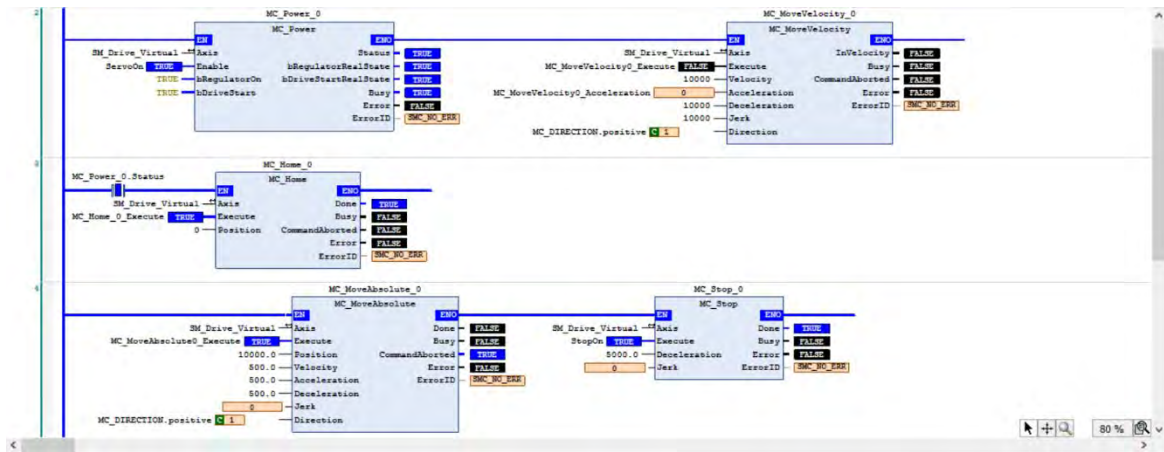

● **ST Language**

The process is same as LD. After MC_Home is done, the state would be Standstill.

```
//MC_Power
MC_Power_0(
    Axis:= SM_Drive_Virtual,
    Enable:= ServoOn,
    bRegulatorOn:= TRUE,
    bDriveStart:= TRUE,
    Status=> ,
    bRegulatorRealState=> ,
    bDriveStartRealState=> ,
    Busy=> ,
    Error=> ,
    ErrorID=> );

//MC_Home
IF MC_Power_0.Status THEN
    MC_Home_0(
        Axis:= SM_Drive_Virtual,
        Execute:= MC_Home_0_Execute,
        Position:= 0,
        Done=> ,
        Busy=> ,
        CommandAborted=> ,
        Error=> ,
        ErrorID=>);
END_IF
```

If a quick stop is performed by MC_Stop during execution of MC_MoveAbsolute, MC_MoveAbsolute would be aborted and be in Stopping state.

```
//MC_MoveAbsolute & MC_Stop
MC_MoveAbsolute_0(
    Axis:= SM_Drive_Virtual,
    Execute:= MC_MoveAbsolute0_Execute,
    Position:= 10000.0,
    Velocity:= 500.0,
    Acceleration:= 500.0,
    Deceleration:= 500.0,
    Jerk:= ,
    Direction:= MC_DIRECTION.positive,
    Done=> ,
    Busy=> ,
    CommandAborted=> ,
    Error=> ,
    ErrorID=>);

MC_Stop_0(
    Axis:= SM_Drive_Virtual,
    Execute:= StopOn,
    Deceleration:= 5000.0,
    Jerk:= ,
    Done=> ,
    Busy=> ,
    Error=> ,
    ErrorID=>);
```

7.8.2.5 Home Positioning

Use homing instruction in the the following example to let you understand how to perform the homing operation. Currently, a total of 36 homing modes (0~35) are supported and the OD is 6098(Homing method) /6099sub1(Speed during search for switch) /6099sub2(Speed during search for zero). For more details, please refer to Delta High Resolution AC Servo Drive ASDA-A2 Series User Manual.

For the following example, specify the parameters of OD as mentioned above after adding A2-E servo in EtherCAT Slave.

Choose mode 33 for Homing Method (Perform homing operation once meet the first Z pulse.)

Speed during search for switch =1000 (Unit: 0.1rpm) (Search for limit switch at the speed of 100rpm.)

Speed during search for zero =100 (Unit: 0.1rpm) (Search for zero at the speed of 10rpm.)

After settings are completed, the homing method for executing MC_Home with LD/ ST language would be corresponding to the one specified as above.

The screenshot shows the configuration interface for the SM_Drive_ETC_Delta_ASDA_A2. The 'Homing Mode' is set to 'Mode 33'. The 'Homing speed during search for switch' is 1000 [0.1 rpm], the 'Homing speed during search for z phase pulse' is 100 [0.1 rpm], and the 'Homing Acceleration' is 100 [ms].

Mode 33 : Depending on Z pulse in the negative direction

In mode 33, The homing instruction is executed and the axis moves at the second-phase speed (Homing speed during search for Z phase pulse) in the negative direction. And the place where the axis stands is the home position once the first Z pulse is met.

The diagram illustrates the homing process on a horizontal axis. The axis starts at a 'Start point' on the right and moves to the left in the 'Negative direction'. A 'Stop point' is marked with a circle containing '33' at the location of the first Z pulse. Below the axis, a 'Z pulse' signal is shown as a series of vertical pulses. The first pulse occurs at the stop point.

● Main variables used in programming

Variable	Data Type	Default	Note
Axis_1	AXIS_REF_SM3	-	Real axis variables
ServoOn	BOOL	FALSE	To enable MC_Power

● Timing diagram

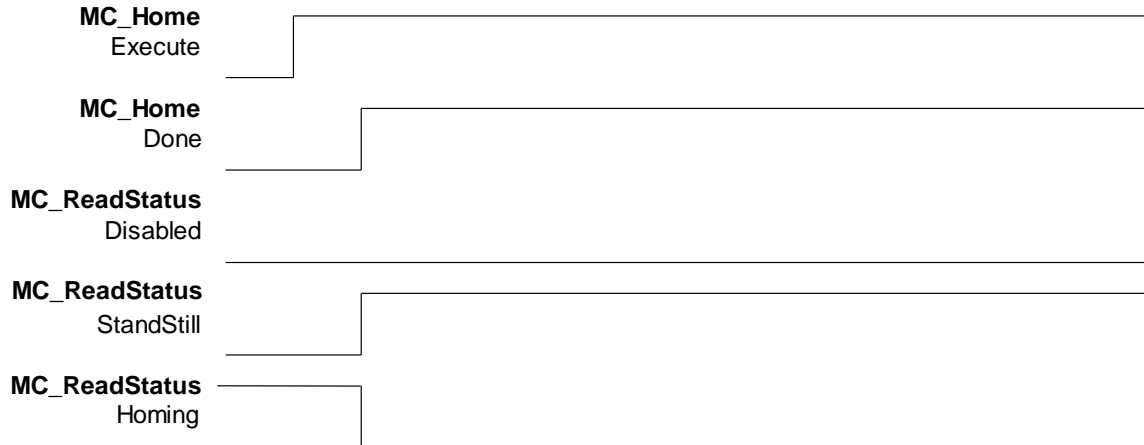

- **LD language**

The state would be Standstill when the outputs of MC_Power are under normal status. Shift to state Homing when execute MC_Home, then back to Standstill after home positioning is completed.

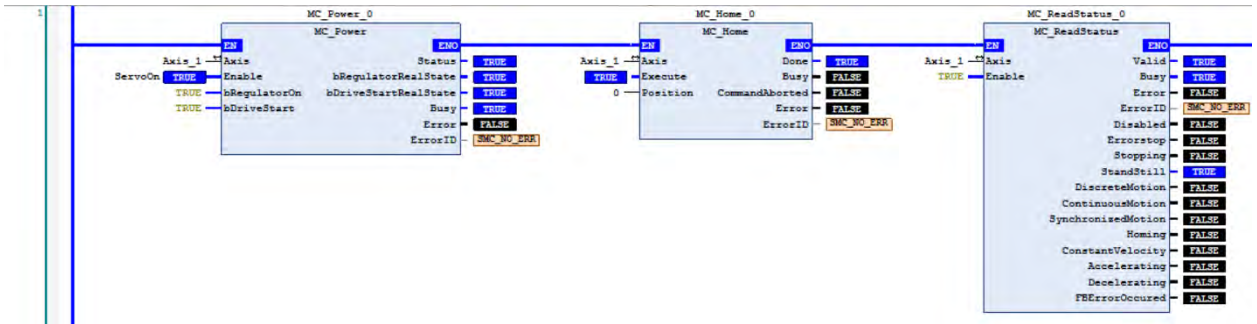

- **ST language**

Process is same as LD. The state is Standstill after execution of MC_Home is completed, which the output status can be checked via variables and Watch tables.

MC_Home_0(

```
Axis:= Axis_1,
Execute:= ,
Position:= 0,
Done=> ,
Busy=> ,
CommandAborted=> ,
Error=> ,
ErrorID=> );
```

MC_ReadStatus_0(

```
Axis:= Axis_1,
Enable:= TRUE,
Valid=> ,
Busy=> ,
Error=> ,
ErrorID=> ,
Disabled=> ,
Errorstop=> ,
Stopping=> ,
StandStill=> ,
DiscreteMotion=> ,
ContinuousMotion=> ,
SynchronizedMotion=> ,
Homing=> ,
ConstantVelocity=> ,
Accelerating=> ,
Decelerating=> ,
FBErrorOccurred=>);
```

7.8.2.6 Absolute Positioning

Via MC_MoveAbsolute instruction used in the following example that you are able to understand how to perform displacement at one speed. The following example supports with LD and ST programming languages.

- Main variables used in programming

Variable	Data Type	Default	Note
Axis_1	AXIS_REF_SM3	-	Real axis variables
ServoOn	BOOL	FALSE	To enable MC_Power
MC_MoveAbsolute0_Execute	BOOL	FALSE	Execute input of MC_MoveAbsolute
MC_DIRECTION.positive	MC_Direction	-	Assigned moving direction-positive (valid for rotary axes)

- Timing diagram

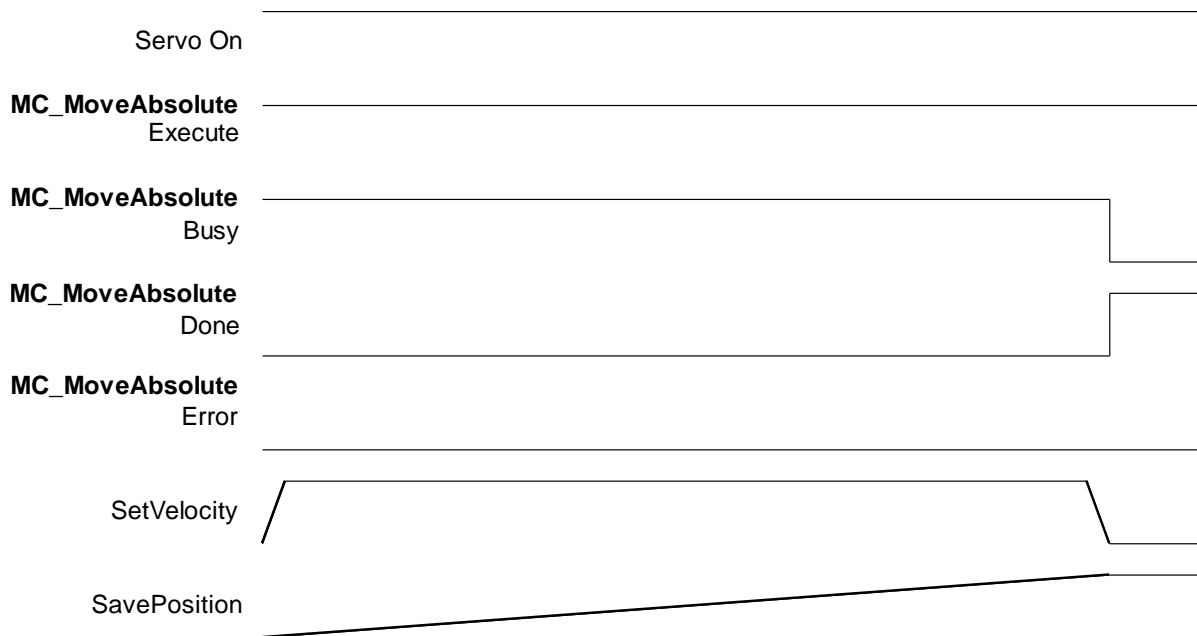

- LD language

Check if the outputs of MC_Power is under normal status, then execute MC_MoveAbsolute to move from the start position 0 to the assigned position 50000.

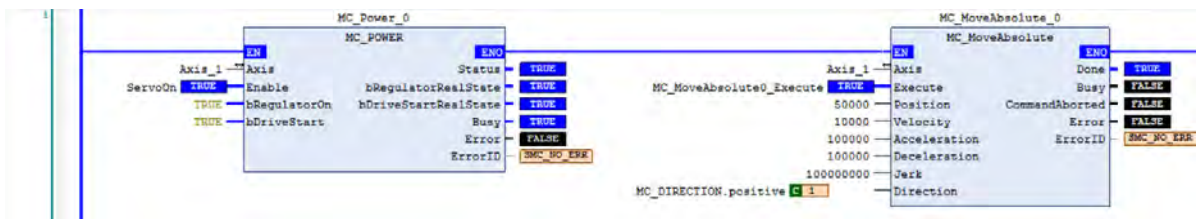

- **ST language**

```
MC_Home_0(
  Axis:= Axis_1,
  Execute:= ,
  Position:= 0,
  Done=> ,
  Busy=> ,
  CommandAborted=> ,
  Error=> ,
  ErrorID=> );
```

```
MC_MoveAbsolute_0(
  Axis:= Axis_1,
  Execute:= MC_MoveAbsolute0_Execute,
  Position:= 50000,
  Velocity:= 10000,
  Acceleration:= 100000,
  Deceleration:= 100000,
  Jerk:= 100000,
  Direction:= SM3_Basic.MC_DIRECTION.positive,
  Done=> ,
  Busy=> ,
  CommandAborted=> ,
  Error=> ,
  ErrorID=> );
```

7.8.2.7 Switch CAM Table during CAM Operation

The following example illustrates that CAM table can be switched while executing MC_CamIn.

Perform switching between two CAM tables configured with different output parameters by adding master and slave axes as well as using two MC_CamIn instructions. Use CamTable 1 when the instruction position of master axis is below 3000. Once the position is over 3000, it will switch to CamTable 2.

- Main variables used in programming

Variable	Data Type	Default	Note
Axis_Master	AXIS_REF_VIRTUAL_SM3	-	Master-related axis variables
Axis_Slave	AXIS_REF_VIRTUAL_SM3	-	Slave-related axis variables
CamTable1	MC_CAM_REF	-	Relating variables for Cam table1
CamTable2	MC_CAM_REF	-	Relating variables for Cam table2
StartFlag	BOOL	FALSE	If this variable is TRUE and the communication with axes is normal, Servo ON will be activated and continue on further actions.
MC_Power0_Status	BOOL	FALSE	Status output variables of MC_Power for master, TRUE when Servo On
MC_Power1_Status	BOOL	FALSE	Status output variables of MC_Power for slave, TRUE when Servo On

Variable	Data Type	Default	Note
MC_Home0_Done	BOOL	FALSE	Output Done variables of MC_Home for master, TRUE when homing completed.
MC_Home1_Done	BOOL	FALSE	Output Done variables of MC_Home for slave, TRUE when homing completed.
MC_MoveAbs_Busy	BOOL	FALSE	Output Bust variables of MC_MoveAbsolute for master, TRUE when the FB is executed.
CamTableSelect	MC_CAM_REF	-	Specify the corresponding Cam table.
CamTable1_En	BOOL	FALSE	TRUE when CamTable1 is chosen to be used.
CamTable2_En	BOOL	FALSE	TRUE when CamTable2 is chosen to be used.
CamTableID	MC_CAM_ID	-	The internal data structure of the selectedCam table, which is from MC_CamTableSelect and used as input of MC_CamIn.
MC_CamIn1_InSync	BOOL	FALSE	Output InSync variables of CamTable1, TRUE when master and slave axis are synchronized with cam.
MC_CamIn2_InSync	BOOL	FALSE	Output InSync variables of CamTable2, TRUE when master and slave axis are synchronized with cam.

CamTable1 :

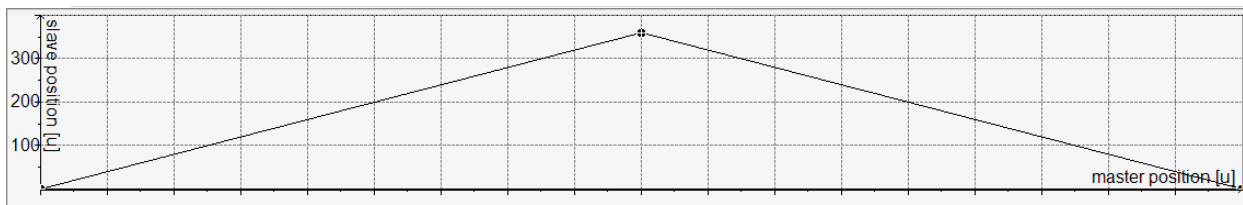

CamTable2 :

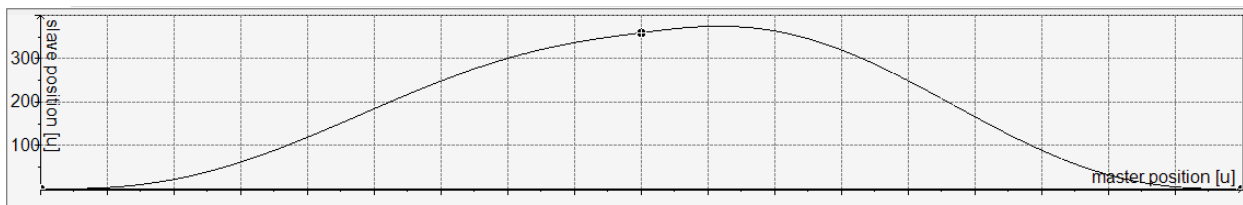

● **Timing diagram**

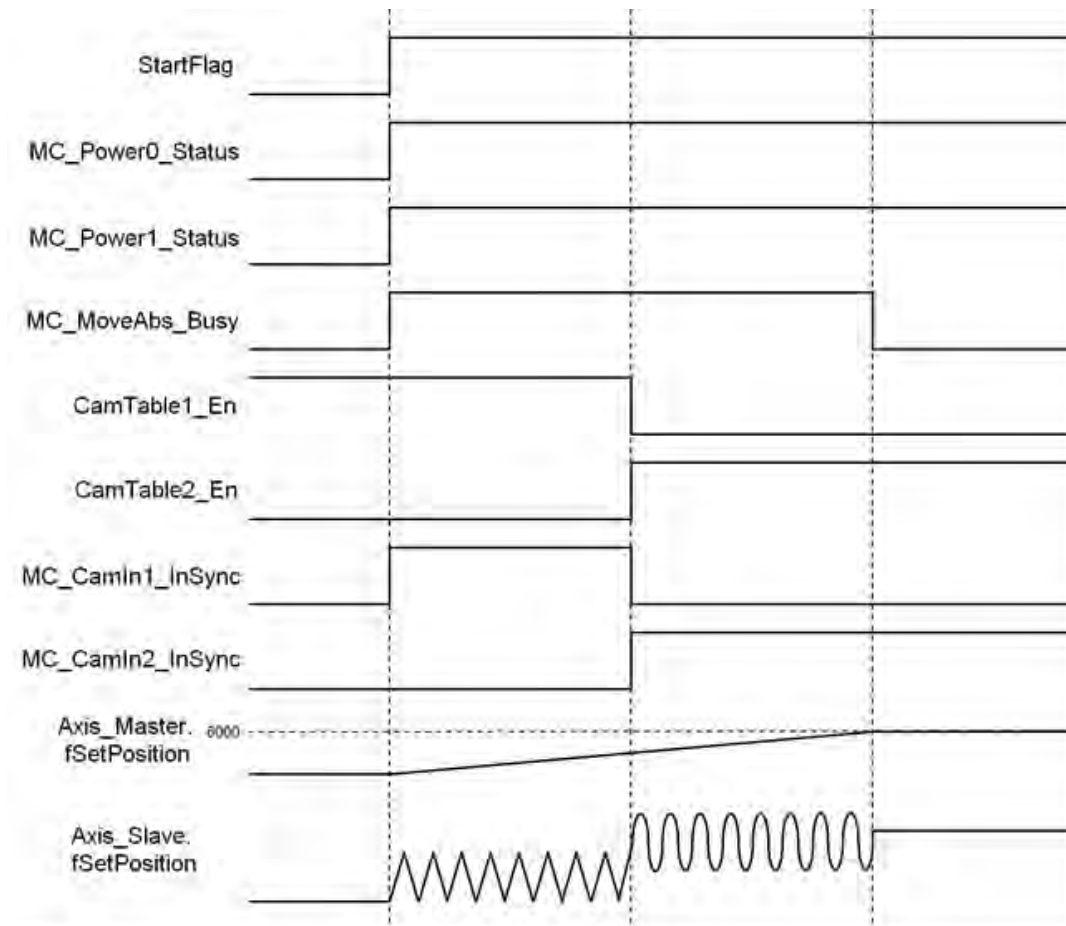

● **LD language**

Set StartFlag to be TRUE, then the normal operation of communications for both master and slave axis would be checked respectively



Under normal condition, Servo ON state will be set to master and slave axis.

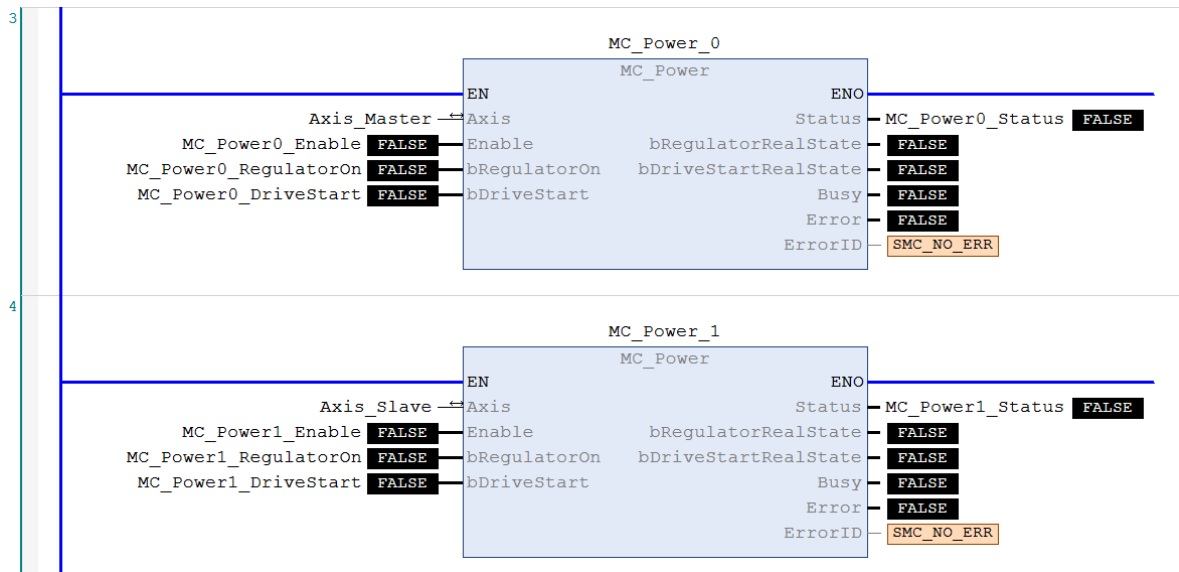

Under Servo On state and unsure of the start position, home positioning will be operated first.



After the homing operation of master axis is completed, execute MC_MoveAbsolute instruction.

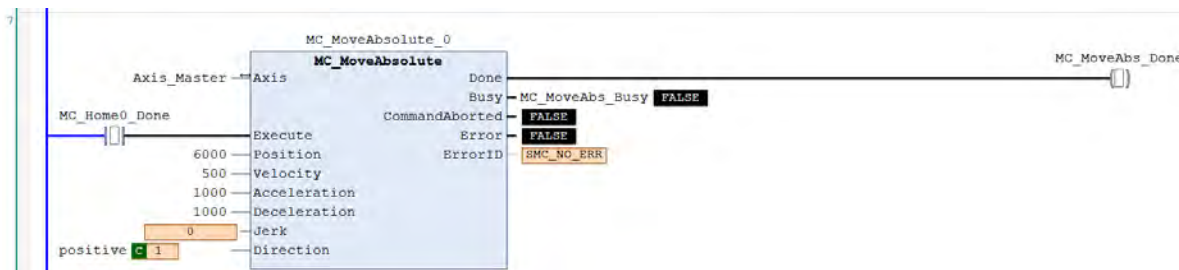

When the instruction position of master axis is below 3000, use CamTable1 (CamTable1_En=True, CamTable2_En=False). Conversely, when position is over 3000, use CamTable2 (CamTable1_En=False, CamTable2_En=True). Under both conditions, set the corresponding Cam table with MC_CamTableSelect instruction.

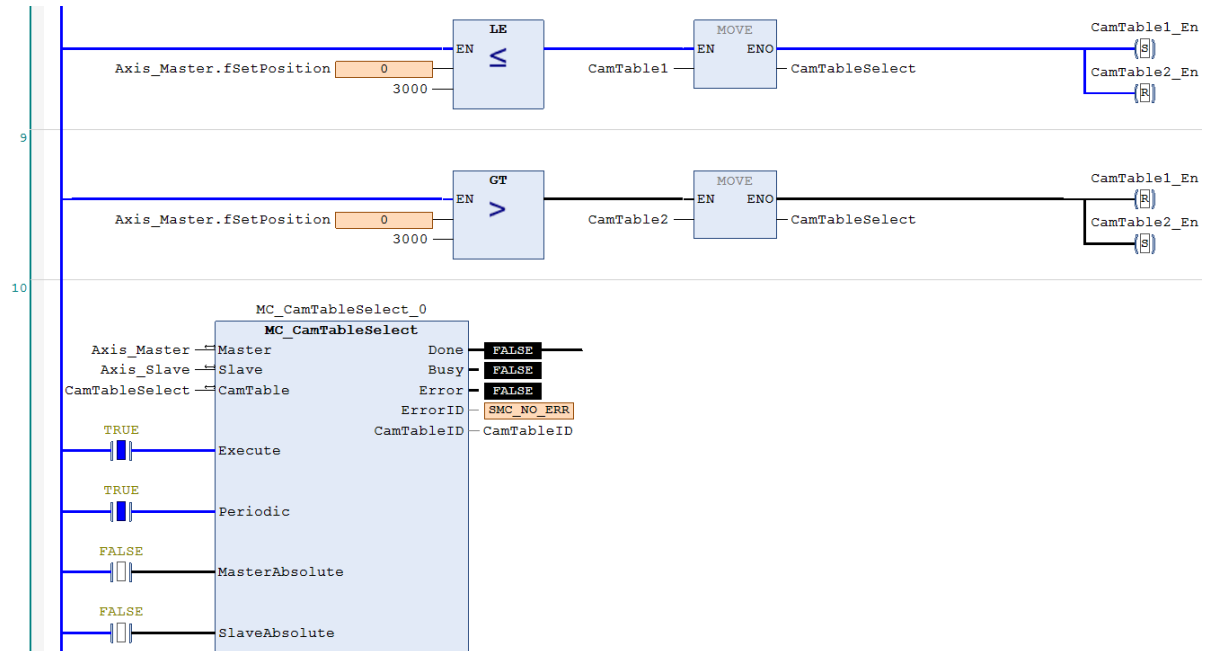

When absolute positioning is operated for master axis and CamTable1_En is True, execute with CamTable1.

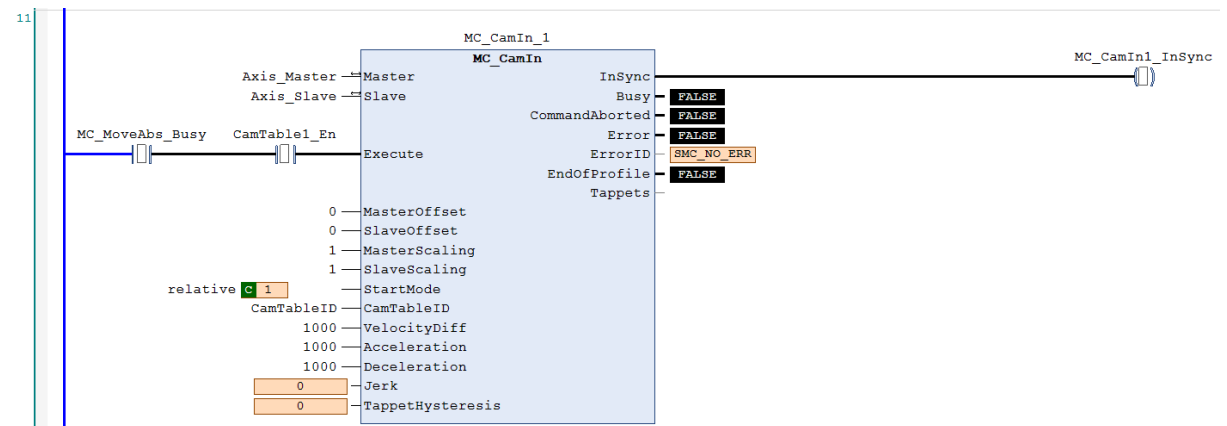

When absolute positioning is operated for master axis and CamTable2_En is True, execute with CamTable2.

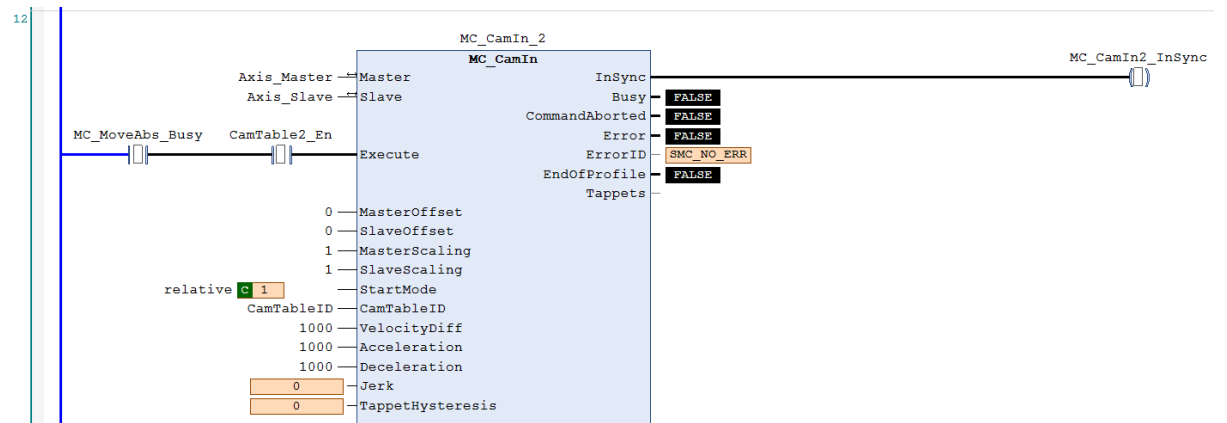

- **ST language**

// Set StartFlag to be TRUE, then the normal operation of communications for both master and slave axis would be //checked respectively

```
IF StartFlag = TRUE THEN
  IF Axis_Master.bCommunication = TRUE THEN
    MC_Power0_Enable := TRUE;
    MC_Power0_RegulatorOn := TRUE;
    MC_Power0_DriveStart := TRUE;
  END_IF

  IF Axis_Slave.bCommunication = TRUE THEN
    MC_Power1_Enable := TRUE;
    MC_Power1_RegulatorOn := TRUE;
    MC_Power1_DriveStart := TRUE;
  END_IF
END_IF
```

//Under normal condition, Servo ON state will be set to master and slave axis.

```
MC_Power_0(
  Axis:= Axis_Master,
  Enable:= MC_Power0_Enable,
  bRegulatorOn:= MC_Power0_RegulatorOn,
  bDriveStart:= MC_Power0_DriveStart,
  Status=> MC_Power0_Status,
  bRegulatorRealState=> ,
  bDriveStartRealState=> ,
  Busy=> ,
  Error=> ,
  ErrorID=> );
```

```
MC_Power_1(
  Axis:= Axis_Slave,
  Enable:= MC_Power1_Enable,
  bRegulatorOn:= MC_Power1_RegulatorOn,
  bDriveStart:= MC_Power1_DriveStart,
  Status=> MC_Power1_Status,
  bRegulatorRealState=> ,
  bDriveStartRealState=> ,
  Busy=> ,
  Error=> ,
  ErrorID=> );
```

// Under Servo On state and unsure of the start position, home positioning will be operated first.

```
IF MC_Power0_Status = TRUE THEN
  MC_Home0_Execute := TRUE;
END_IF
```

```
IF MC_Power1_Status = TRUE THEN
  MC_Home1_Execute := TRUE;
END_IF
```

```
MC_Home_0(
  Axis:= Axis_Master,
```



```

Execute:= MC_Home0_Execute,
Position:= 0,
Done=> MC_Home0_Done,
Busy=> ,
CommandAborted=> ,
Error=> ,
ErrorID=>);

MC_Home_1(
Axis:= Axis_Slave,
Execute:= MC_Home1_Execute,
Position:= 0,
Done=> MC_Home1_Done,
Busy=> ,
CommandAborted=> ,
Error=> ,
ErrorID=> );

// After the homing operation of master axis is completed, execute MC_MoveAbsolute instruction.

//MC_MoveAbsolute(
Axis:= Axis_Master,
Execute:= MC_Home1_Done,
Position:= 6000,
Velocity:= 500,
Acceleration:= 1000,
Deceleration:= 1000,
Jerk:= ,
Direction:= positive,
Done=> MC_MoveAbs_Done,
Busy=> MC_MoveAbs_Busy,
CommandAborted=> ,
Error=> ,
ErrorID=> );

// When the instruction position of master axis is below 3000, use CamTable1 (CamTable1_En=True,
//CamTable2_En=False).

//When position is over 3000, use CamTable2 (CamTable1_En=False, CamTable2_En=True).

//Under both conditions, set the corresponding Cam table with MC_CamTableSelect instruction.
IF Axis_Master.fSetPosition > 3000 THEN
    CamTableSelect := CamTable2;
    CamTable1_En := FALSE;
    CamTable2_En := TRUE;
ELSE
    CamTableSelect := CamTable1;
    CamTable1_En := TRUE;
    CamTable2_En := FALSE;
END_IF

IF (CamTable1_En = TRUE) OR (CamTable2_En = TRUE) THEN
    CamTable_En := TRUE;
END_IF

```

```
MC_CamTableSelect(
  Master:= Axis_Master,
  Slave:= Axis_Slave,
  CamTable:= CamTableSelect,
  Execute:= CamTable_En,
  Periodic:= TRUE,
  MasterAbsolute:= FALSE,
  SlaveAbsolute:= FALSE,
  Done=> MC_CamTableSelect_Done,
  Busy=> ,
  Error=> ,
  ErrorID=> ,
  CamTableID=> CamTableID);
```

// When absolute positioning is operated for master axis and CamTable1_En is True, execute with //CamTable1.

```
IF (MC_MoveAbs_Busy = TRUE) AND (CamTable1_En = TRUE) THEN
  MC_CamIn_1(
    Master:= Axis_Master,
    Slave:= Axis_Slave,
    Execute:= TRUE,
    MasterOffset:= 0,
    SlaveOffset:= 0,
    MasterScaling:= 1,
    SlaveScaling:= 1,
    StartMode:= relative,
    CamTableID:= CamTableID,
    VelocityDiff:= 1000,
    Acceleration:= 1000,
    Deceleration:= 1000,
    Jerk:= ,
    TappetHysteresis:= ,
    InSync=> MC_CamIn1_Insync,
    Busy=> ,
    CommandAborted=> ,
    Error=> ,
    ErrorID=> ,
    EndOfProfile=> ,
    Tappets=> );
END_IF
```

// When absolute positioning is operated for master axis and CamTable2_En is True, execute with //CamTable2

```
IF (MC_MoveAbs_Busy = TRUE) AND (CamTable2_En = TRUE) THEN
  MC_CamIn_2(
    Master:= Axis_Master,
    Slave:= Axis_Slave,
    Execute:= TRUE,
    MasterOffset:= 0,
    SlaveOffset:= 0,
    MasterScaling:= 1,
    SlaveScaling:= 1,
    StartMode:= relative,
    CamTableID:= CamTableID,
    VelocityDiff:= 1000,
    Acceleration:= 1000,
```

```

Deceleration:= 1000,
Jerk:= ,
TappetHysteresis:= ,
InSync=> MC_CamIn2_Insync,
Busy=> ,
CommandAborted=> ,
Error=> ,
ErrorID=> ,
EndOfProfile=> ,
Tappets=> );
END_IF

```

Based on the above settings to perform switching Cam tables. Switch the table when the position of master axis is over 3000.

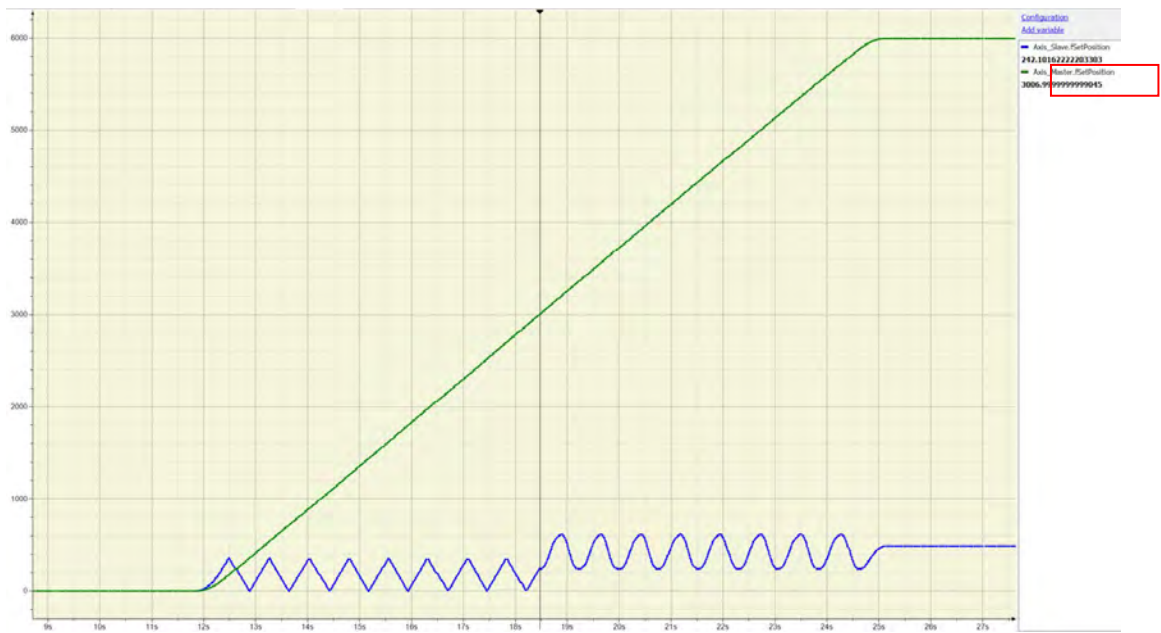

7.8.2.8 Perform Master PhaseOffset for CAM

After the motion of slave axis being aborted during original CAM operation, it starts to synchronize with the controlled master axis. Phase offset of the master axis is operated by executing MC_Phasing when PhasingActive is TRUE.and the slave axis synchronizes with the phase after offset completed. The following example supports with LD and ST programming languages.

● **Main variables used in programming**

Variable	Data Type	Default	Note
Axis_Master	AXIS_REF_VIRTUAL_SM3	-	Master-related axis variables.
Axis_Slave	AXIS_REF_VIRTUAL_SM3	-	Slave-related axis variables.
CamTable	MC_CAM_REF	-	Variables relating to Cam table.
StartFlag	BOOL	FALSE	If this variable is TRUE and the communication with axes is normal, Servo ON will be activated and continue on further actions.
MC_Power0_Status	BOOL	FALSE	Status output variables of MC_Power for master, TRUE when Servo On.
MC_Power1_Status	BOOL	FALSE	Status output variables of MC_Power for slave, TRUE when Servo On.
MC_Home0_Done	BOOL	FALSE	Output Done variables of MC_Home for master, TRUE when homing completed.
MC_Home1_Done	BOOL	FALSE	Output Done variables of MC_Home for slave, TRUE when homing completed.
MC_MoveVelocity_Velocity	LREAL	500	The target velocity for master axis to move in constant velocity motion.
MC_MoveVelocity_InVelocity	BOOL	FALSE	The InVelocity output variables of MC_MoveVelocity, TRUE when the target velocity is reached.
CamTableID	MC_CAM_ID	-	The internal data structure of the selectedCam table, which is from MC_CamTableSelect and used as input of MC_CamIn.
MC_CamIn1_InSync	BOOL	FALSE	Output InSync variables of CamTable1, TRUE when master and slave axis are synchronized with cam.
PhasingActive	BOOL	FALSE	If the variable is TRUE and Cam is InSync, MC_Phasing will starts to be executed.
MC_Phasing_PhaseShift	LREAL	500	Specify the phaseshift values for the master and slave axis.
MC_Phasing_Velocity	LREAL	300	Specify the relative velocity for phasing operating between the master and slave axis.
MC_Phasing_Done	BOOL	FALSE	The Done output variables of MC_Phasing. TRUE when phase offset is completed.

CamTable :

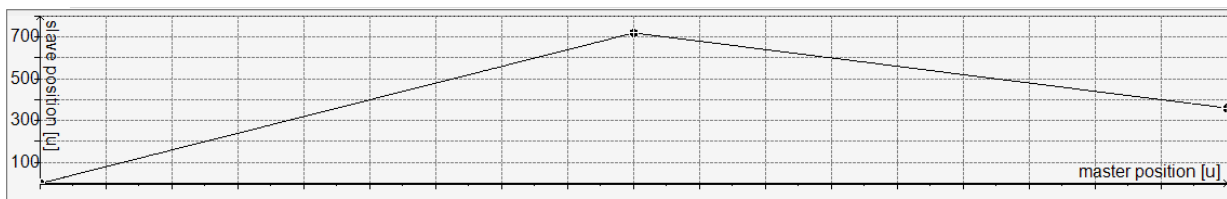

● **Timing diagram**

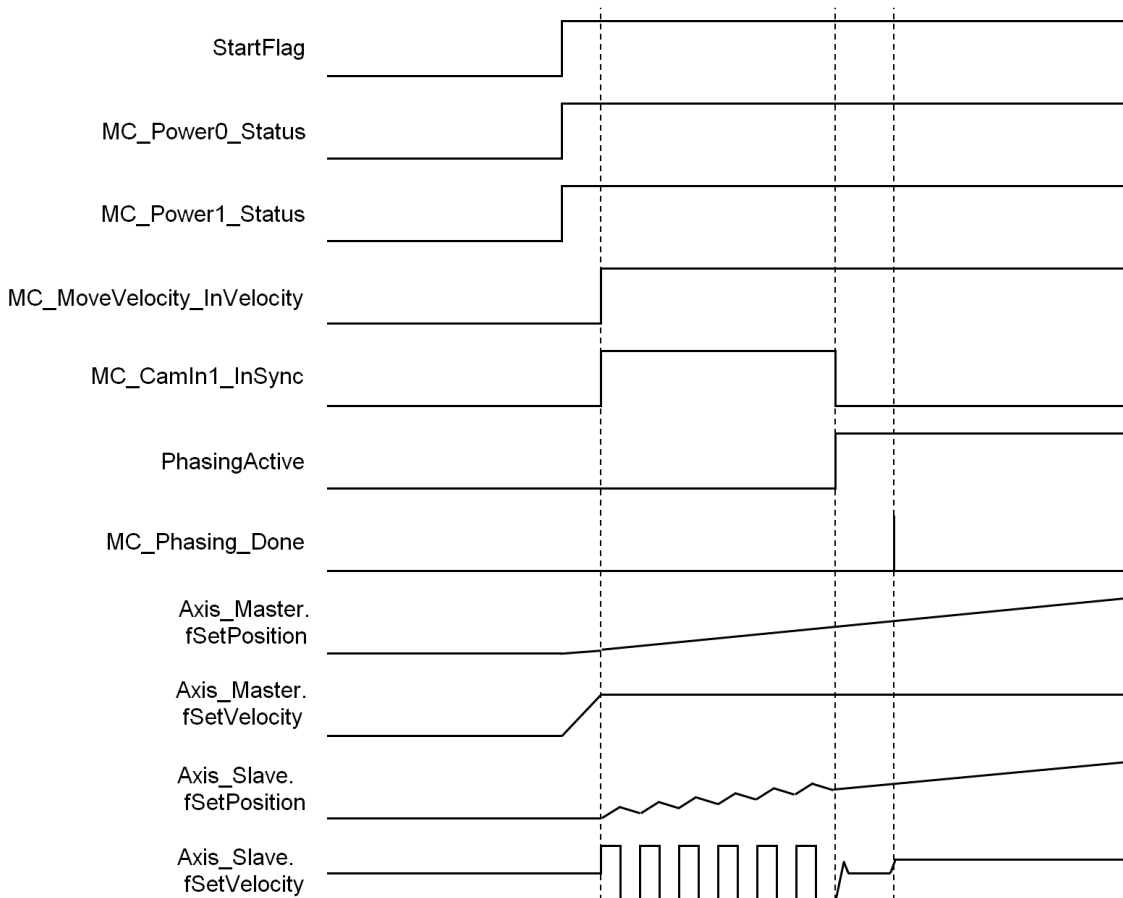

● **LD language**

Set StartFlag to be TRUE, then the normal operation of communications for both master and slave axis would be checked respectively.



Under normal condition, Servo ON state will be set to master and slave axis.

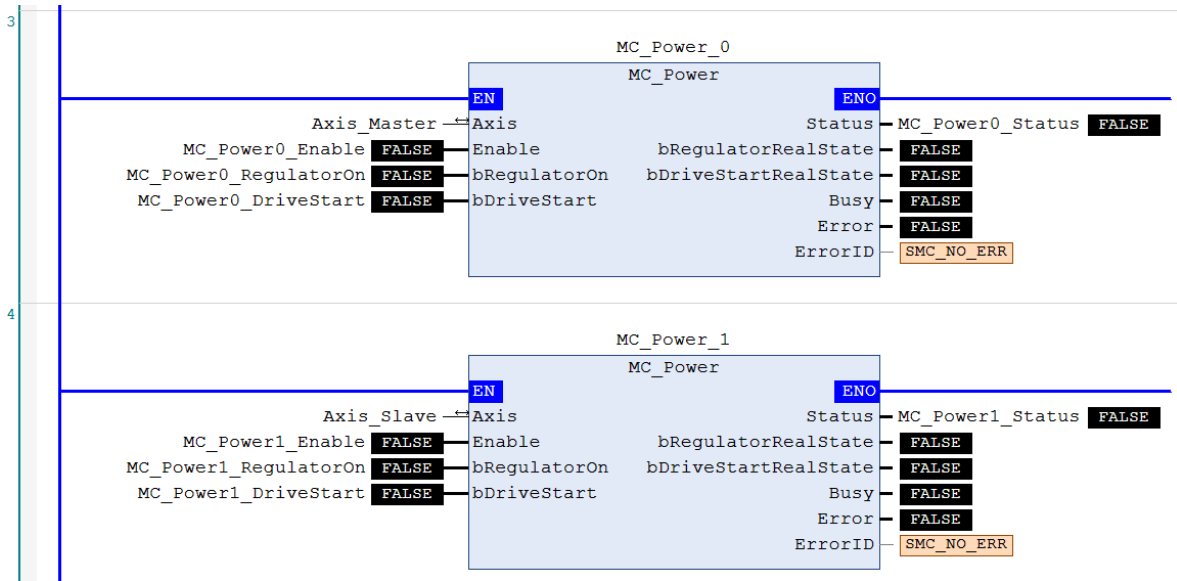

Under Servo On state and unsure of the start position, home positioning will be operated first.

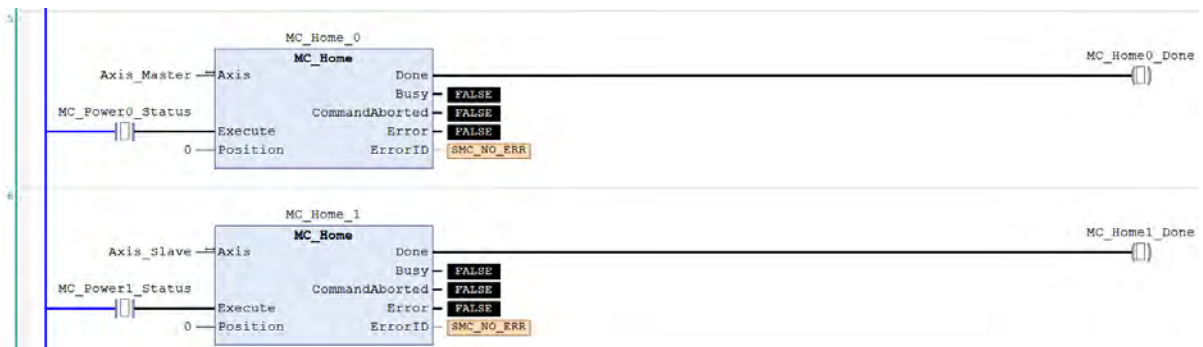

After the homing operation of master axis is completed, execute MC_MoveVelocity.

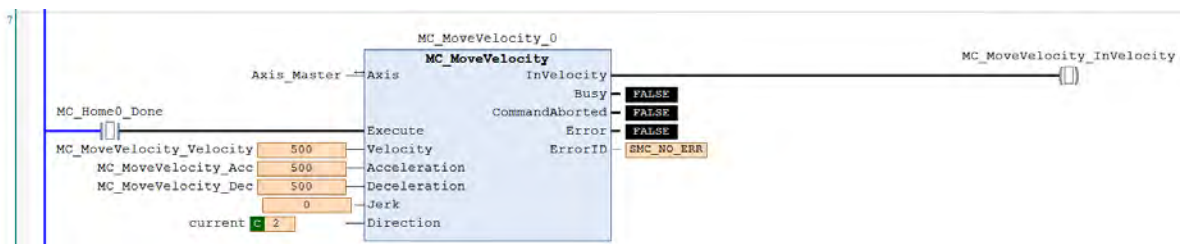

After the master axis reaches the target velocity, execute MC_CamIn with the Cam table specified by MC_CamTableSelect.

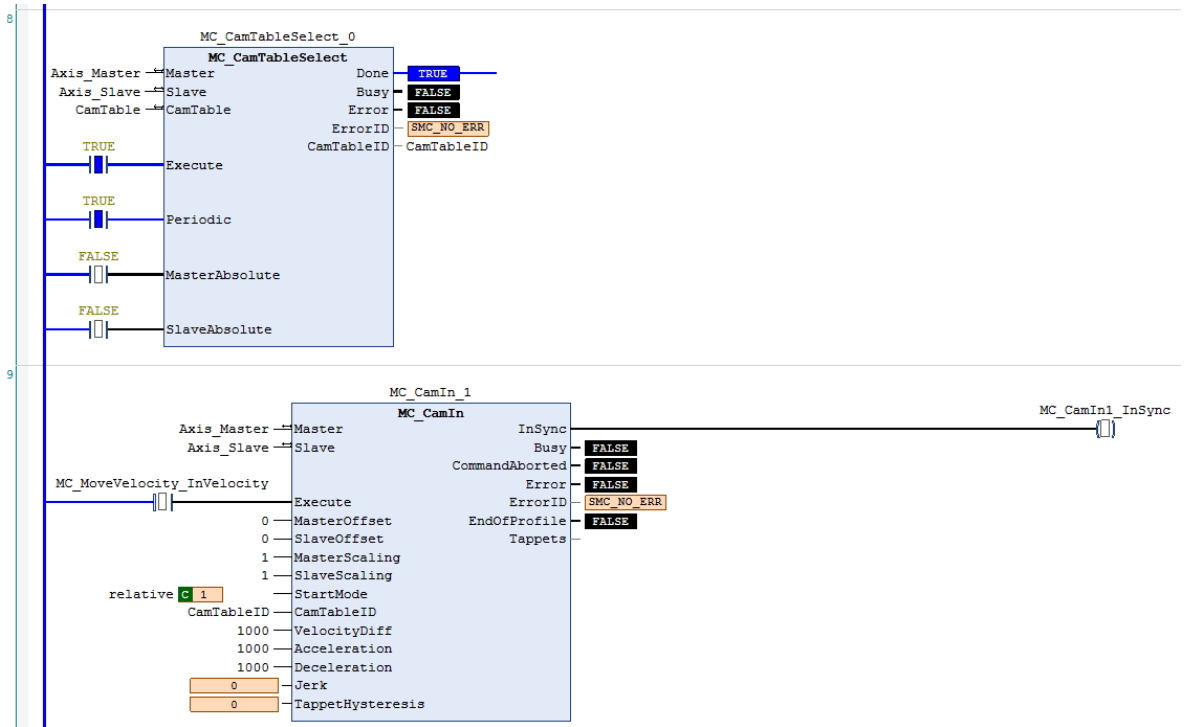

If PhasingActive is TRUE and the slave axis is in synchronized with the master axis based on the setting of MC_Phasing, master and slave axis start performing phase offset, which breaks the original master-slave relationship in Cam.

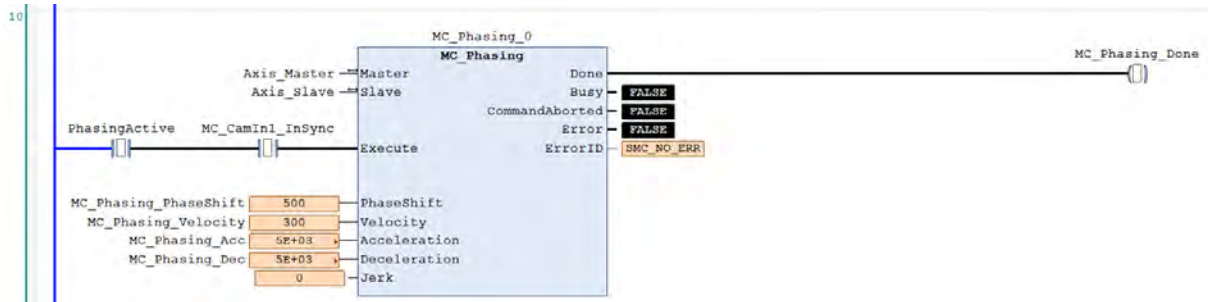

According to above setting to perform phase offset of the master axis, the slave axis synchronizes with the phase after offset completed and the PhaseShift would be fixed, which the PhaseShift between master and slave would be 500, taking the cursor timing 3500-3000 as example, and the velocity of slave axis would be 200 while performing phase offset (velocity of master axis 500 minus velocity 300).

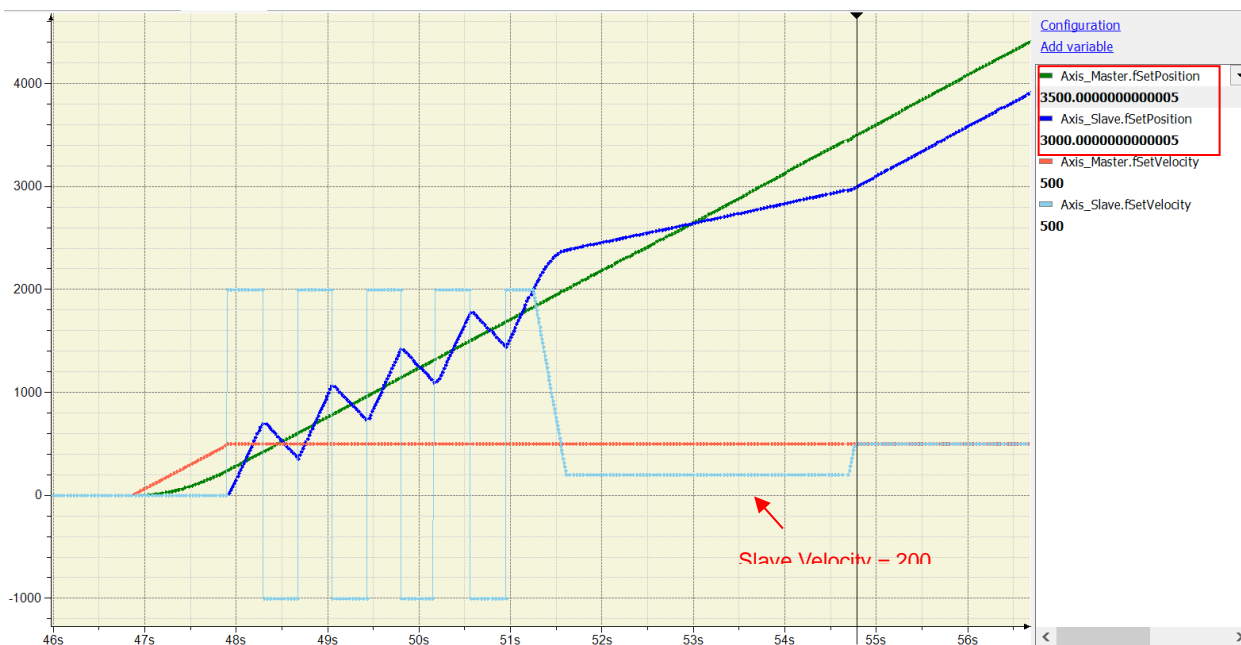

● **ST language**

//Set StartFlag to be TRUE, then the normal operation of communication for both master and slave axis //would be checked respectively.

```

IF StartFlag = TRUE THEN
  IF Axis_Master.bCommunication = TRUE THEN
    MC_Power0_Enable := TRUE;
    MC_Power0_RegulatorOn := TRUE;
    MC_Power0_DriveStart := TRUE;
  END_IF

  IF Axis_Slave.bCommunication = TRUE THEN
    MC_Power1_Enable := TRUE;
    MC_Power1_RegulatorOn := TRUE;
    MC_Power1_DriveStart := TRUE;
  END_IF
END_IF
    
```

//Under normal condition, Servo ON state will be set to master and slave axis.

```

MC_Power_0(
  Axis:= Axis_Master,
  Enable:= MC_Power0_Enable,
  bRegulatorOn:= MC_Power0_RegulatorOn,
  bDriveStart:= MC_Power0_DriveStart,
  Status=> MC_Power0_Status,
  bRegulatorRealState=> ,
    
```



```

bDriveStartRealState=> ,
Busy=> ,
Error=> ,
ErrorID=> );

```

```

MC_Power_1(
Axis:= Axis_Slave,
Enable:= MC_Power1_Enable,
bRegulatorOn:= MC_Power1_RegulatorOn,
bDriveStart:= MC_Power1_DriveStart,
Status=> MC_Power1_Status,
bRegulatorRealState=> ,
bDriveStartRealState=> ,
Busy=> ,
Error=> ,
ErrorID=> );

```

```

//Under Servo On state and unsure of the start position, home positioning will be operated first
IF MC_Power0_Status = TRUE THEN
MC_Home0_Execute := TRUE;
END_IF

```

```

IF MC_Power1_Status = TRUE THEN
MC_Home1_Execute := TRUE;
END_IF

```

```

MC_Home_0(
Axis:= Axis_Master,
Execute:= MC_Home0_Execute,
Position:= 0,
Done=> MC_Home0_Done,
Busy=> ,
CommandAborted=> ,
Error=> ,
ErrorID=> );

```

```

MC_Home_1(
Axis:= Axis_Slave,
Execute:= MC_Home1_Execute,
Position:= 0,
Done=> MC_Home1_Done,
Busy=> ,
CommandAborted=> ,
Error=> ,
ErrorID=> );

```

//After the homing operation of master axis is completed, execute MC_MoveVelocity.

```

MC_MoveVelocity(
Axis:= Axis_Master,
Execute:= MC_Home0_Done,
Velocity:= MC_MoveVelocity_Velocity,
Acceleration:= MC_MoveVelocity_Acc,
Deceleration:= MC_MoveVelocity_Dec,
Jerk:= ,
Direction:= current,

```

```

InVelocity=> MC_MoveVelocity_InVelocity,
Busy=> ,
CommandAborted=> ,
Error=> ,
ErrorID=> );

```

```

// After the master axis reaches the target velocity, execute MC_CamIn with the Cam table specified by
//MC_CamTableSelect.

```

```

MC_CamTableSelect(
  Master:= Axis_Master,
  Slave:= Axis_Slave,
  CamTable:= CamTable,
  Execute:= TRUE,
  Periodic:= TRUE,
  MasterAbsolute:= FALSE,
  SlaveAbsolute:= FALSE,
  Done=> MC_CamTableSelect_Done,
  Busy=> ,
  Error=> ,
  ErrorID=> ,
  CamTableID=> CamTableID);

```

```

IF MC_MoveVelocity_InVelocity = TRUE THEN

```

```

  MC_CamIn_1(
    Master:= Axis_Master,
    Slave:= Axis_Slave,
    Execute:= TRUE,
    MasterOffset:= 0,
    SlaveOffset:= 0,
    MasterScaling:= 1,
    SlaveScaling:= 1,
    StartMode:= relative,
    CamTableID:= CamTableID,
    VelocityDiff:= 1000,
    Acceleration:= 1000,
    Deceleration:= 1000,
    Jerk:= ,
    TappetHysteresis:= ,
    InSync=> MC_CamIn1_Insync,
    Busy=> ,
    CommandAborted=> ,
    Error=> ,
    ErrorID=> ,
    EndOfProfile=> ,
    Tappets=> );

```

```

END_IF

```

```

//If PhasingActive is TRUE and the slave axis is in synchronized with the master axis based on the setting of
//MC_Phasing, master and slave axis start performing phase offset, which breaks the original master-slave
//relationship in Cam.

```

```

IF (PhasingActive = TRUE) AND (MC_CamIn1_Insync = TRUE) THEN

```

```

  MC_Phasing_Execute := TRUE;

```

```

END_IF

```

```

MC_Phasing(
  Master:= Axis_Master,
  Slave:= Axis_Slave,
  Execute:= MC_Phasing_Execute,
  PhaseShift:= MC_Phasing_PhaseShift,
  Velocity:= MC_Phasing_Velocity,
  Acceleration:= MC_Phasing_Acc,
  Deceleration:= MC_Phasing_Dec,
  Jerk:= ,
  Done=> MC_Phasing_Done,
  Busy=> ,
  CommandAborted=> ,
  Error=> ,
  ErrorID=> );

```

7.8.2.9 Change Current Position in Movement

Change the current position of axis to the target position in the coordinate system with the feedback of the current position. The interacting effects between MC_MoveRelative and MC_SetPosition are explained in the below example. The following example supports with LD and ST programming languages.

- **Main variables used in programming**

Variable	Data Type	Default	Note
Axis_Virtual	AXIS_REF_VIRTUAL_SM3	-	Associate variables of axis.
StartFlag	BOOL	FALSE	If this variable is TRUE and the communication with axes is normal, Servo ON will be activated and continue on further actions.
MC_Power0_Status	BOOL	FALSE	Status output variables of MC_Power for master, TRUE when Servo On.
MC_Home0_Done	BOOL	FALSE	Output Done variables of MC_Home for master, TRUE when homing completed.
MC_MoveRel_Distance	LREAL	8000	The target relative positions of MC_MoveRelative.
MC_MoveRel_Done	BOOL	FALSE	The output Done variables of MC_MoveRelative. TRUE when the relative positioning is completed.
MC_MoveRel_Busy	BOOL	FALSE	The output Busy variables of MC_MoveRelative TRUE when the instruction is triggered and executed.
MC_SetPosition_Execute	BOOL	FALSE	If TRUE, MC_SetPosition starts to be executed.
MC_SetPosition_Position	LREAL	3000	The absolute position and relative distance changed by MC_SetPosition.
MC_SetPosition_Mode	BOOL	TRUE	MC_SetPosition is to set the axis position to be absolute position or relative position.
MC_SetPosition_Done	BOOL	FALSE	The output Done variables of MC_SetPosition TRUE when the position is changed.

● **Timing diagram**

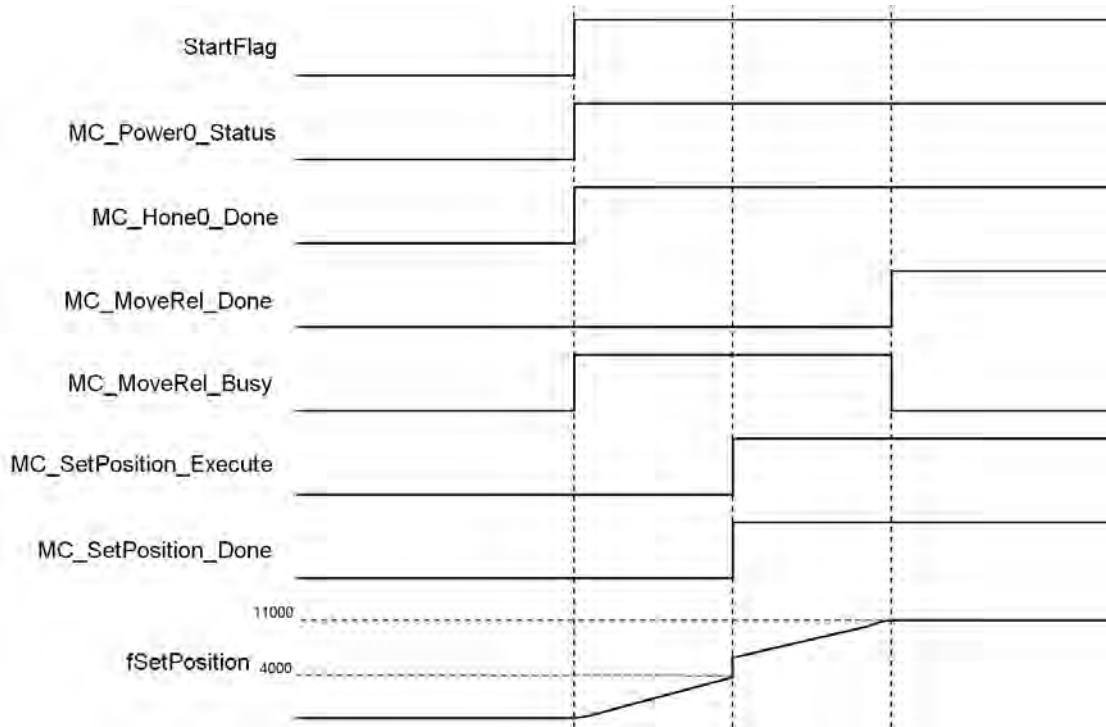

● **LD language**

Set StartFlag to be TRUE, then the normal operation of communication for axis would be checked.

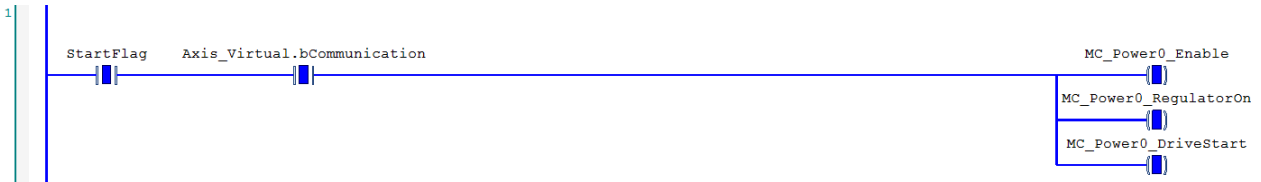

Under normal condition, set the axis to be in state Servo On.

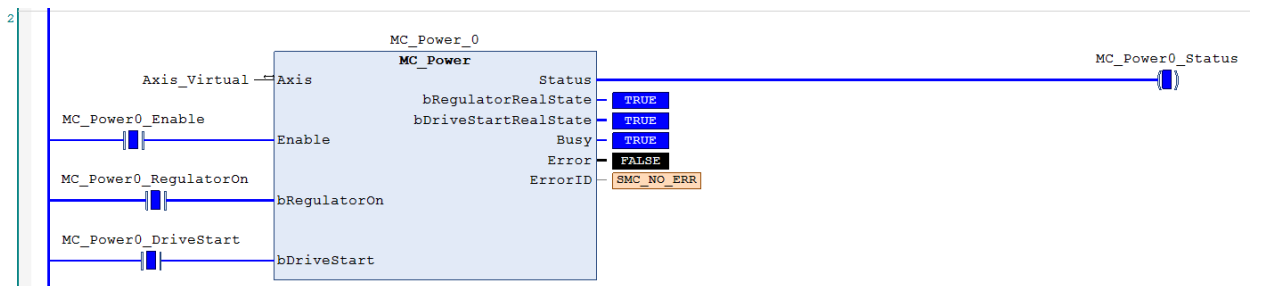

Under Servo On state and unsure of the start position, home positioning operation will be required.

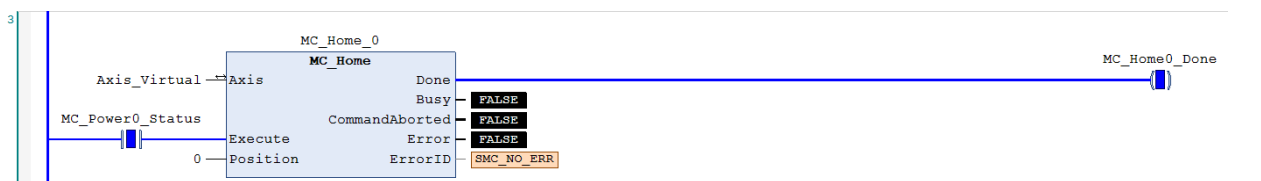

After the homing operation of axis is completed, execute MC_MoveRelative.

The target position of relative displacement = 8000

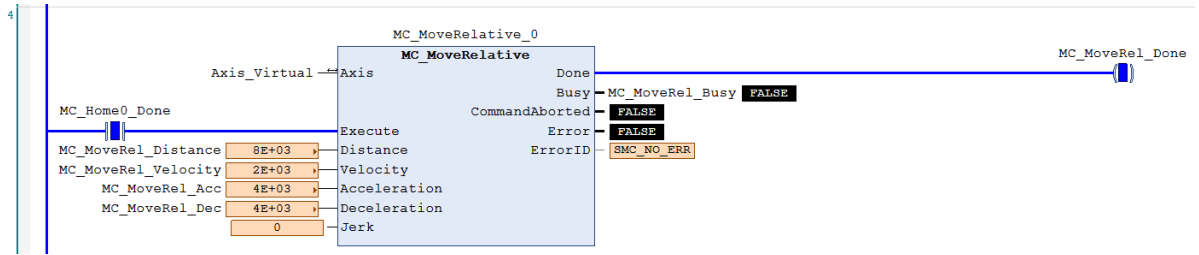

When the current position of axis passes 4000, execute MC_SetPosition (Mode = Relative · Distance = 3000) so as to change the current position to be the assigned target position.

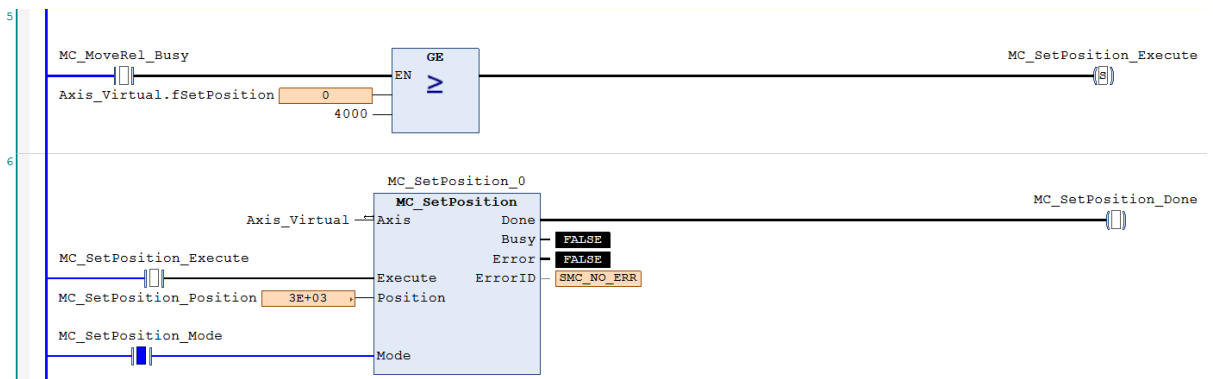

Start a relative positioning procedure based on the current set position in coordinate system according to the above settings, which the position would finally reach 11000 ($11000 = 4000 + 3000 + (8000 - 4000)$) without influencing the displacement of motion body controlled by MC_MoveRelative. The displacement is 8000 ($8000 = (4000 - 0) + (11000 - 7000)$) same as the original setting.

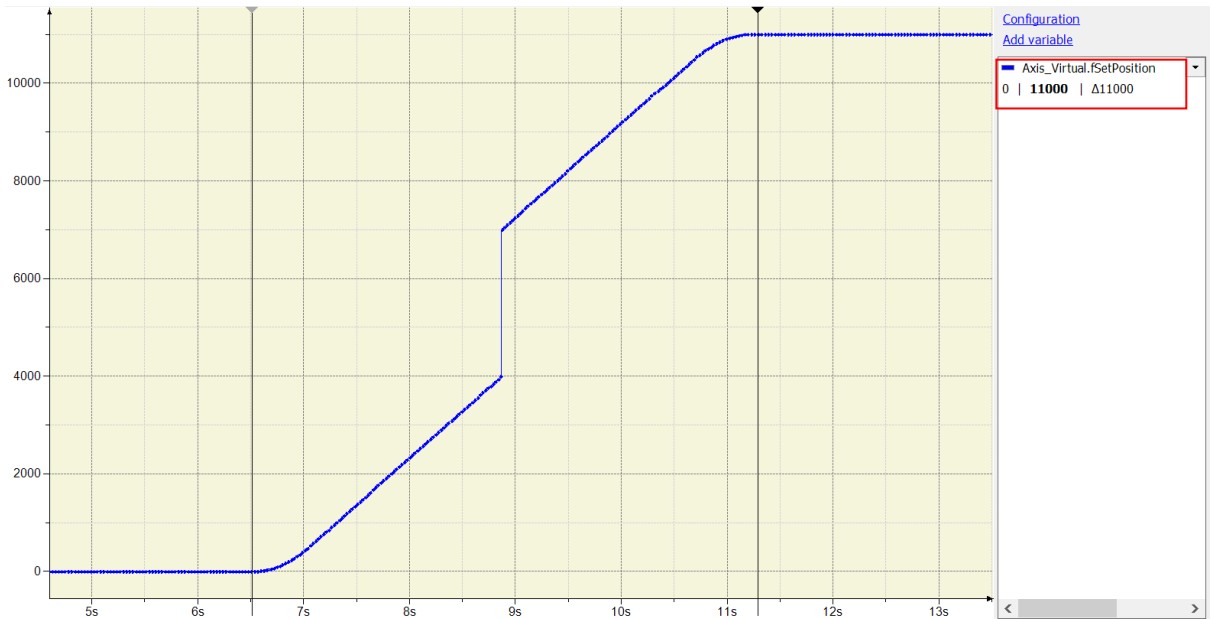

The difference between the above and the picture below is that the mode of MC_SetPosition is changed to Absolute (Position = 3000). The actual position is set to the parameterized absolute target Position value, and the position would finally reach 7000 (7000 = 3000+(8000 – 4000)) without influencing the displacement of motion body controlled by MC_MoveRelative. The displacement would be 8000 (8000=(4000 – 0)+(7000 – 3000))same as the original setting.

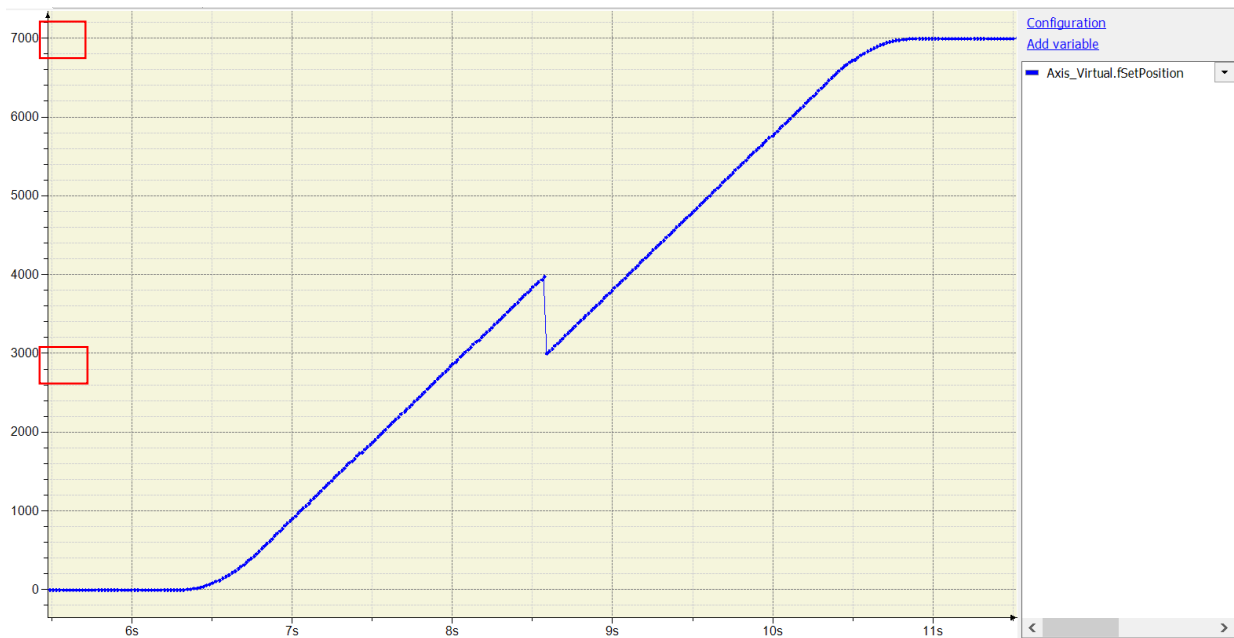

- **ST language**

Set StartFlag to be TRUE, then the normal operation of communication for axis would be checked.

```

IF StartFlag = TRUE THEN
IF Axis_Virtual.bCommunication = TRUE THEN
    MC_Power0_Enable := TRUE;
    MC_Power0_RegulatorOn := TRUE;
    MC_Power0_DriveStart := TRUE;
END_IF
END_IF
    
```

// Under normal condition, set the axis to be in state Servo On.

```

MC_Power_0(
    Axis:= Axis_Virtual,
    Enable:= MC_Power0_Enable,
    bRegulatorOn:= MC_Power0_RegulatorOn,
    bDriveStart:= MC_Power0_DriveStart,
    Status=> MC_Power0_Status,
    bRegulatorRealState=> ,
    bDriveStartRealState=> ,
    Busy=> ,
    Error=> ,
    ErrorID=> );
    
```

//Under Servo On state and unsure of the start position, home positioning operation will be required.

```
IF MC_Power0_Status = TRUE THEN
  MC_Home0_Execute := TRUE;
END_IF
```

```
MC_Home_0(
  Axis:= Axis_Virtual,
  Execute:= MC_Home0_Execute,
  Position:= 0,
  Done=> MC_Home0_Done,
  Busy=> ,
  CommandAborted=> ,
  Error=> ,
  ErrorID=> );
```

//After the homing operation of axis is completed, execute MC_MoveRelative.

//The target position of relative displacement = 8000

```
MC_MoveRelative(
  Axis:= Axis_Virtual,
  Execute:= MC_Home0_Done,
  Distance:= MC_MoveRel_Distance,
  Velocity:= MC_MoveRel_Velocity,
  Acceleration:= MC_MoveRel_Acc,
  Deceleration:= MC_MoveRel_Dec,
  Jerk:= ,
  Done=> MC_MoveRel_Done,
  Busy=> MC_MoveRel_Busy,
  CommandAborted=> ,
  Error=> ,
  ErrorID=> );
```

//When the current position of axis passes 4000, execute MC_SetPosition (Mode = Relative · Distance = 3000) so as to //change the current position to be the assigned target position.

```
IF (MC_MoveRel_Busy = TRUE) AND (Axis_Virtual.fSetPosition >= 4000) THEN
  MC_SetPosition_Execute := TRUE;
END_IF
```

```
MC_SetPosition(
  Axis:= Axis_Virtual,
  Execute:= MC_SetPosition_Execute,
  Position:= MC_SetPosition_Position,
  Mode:= MC_SetPosition_Mode,
  Done=> MC_SetPosition_Done,
  Busy=> ,
  Error=> ,
  ErrorID=> );
```

7.8.2.10 Perform Superimposed during Gear Engagment

Perform MC_MoveSuperImposed on the particular slave axis while the gear has been engaged in the following example. The final position of slave axis would be the displacement of gear ratio relative to master axis and plus the specific distance superimposed in motion. The following example supports with LD and ST programming languages.

- **Main variables used in programming**

Variable	Data Type	Default	Note
Axis_Master	AXIS_REF_VIRTUAL_SM3	-	Master-related axis variables.
Axis_Slave	AXIS_REF_VIRTUAL_SM3	-	Slave-related axis variables.
StartFlag	BOOL	FALSE	If this variable is TRUE and the communication with axes is normal, Servo ON will be activated and continue on further actions.
MC_Power0_Status	BOOL	FALSE	Status output variables of MC_Power for master, TRUE when Servo On.
MC_Power1_Status	BOOL	FALSE	Status output variables of MC_Power for slave, TRUE when Servo On.
MC_Home0_Done	BOOL	FALSE	Output Done variables of MC_Home for master, TRUE when homing operation completed.
MC_Home1_Done	BOOL	FALSE	Output Done variables of MC_Home for slave, TRUE when homing operation completed.
MC_GearIn_InGear	BOOL	FALSE	Output InGear variables of MC_GearIn. TRUE when the engage operation is completed.
MC_GearIn_RatioNumerator	DINT	2	Numerator of the gear ratio between master and slave axis.
MC_GearIn_RatioDenominator	UDINT	1	Denominator of the gear ratio between master and slave axis.
MC_MoveAbs_Execute	BOOL	FALSE	When the variable is TRUE, MC_MoveAbsolute is executed.
MC_MoveAbs_Position	LREAL	3000	Absolute target position of assigned master axis.
MC_MoveAbs_Velocity	LREAL	1000	Target velocity of assigned master axis.
MC_MoveAbs_Done	BOOL	FALSE	Output Done variables of MC_MoveAbsolute for master, TRUE when absolute positioning completed.
MC_MoveAbs_Busy	BOOL	FALSE	Output Busy variables of MC_MoveAbsolute for master axis. TRUE when the instruction is executed.
MC_MoveSuperImposed_Execute	BOOL	FALSE	When the variable is TRUE, MC_MoveSuperImposed is executed.

Variable	Data Type	Default	Note
MC_MoveSuperImposed_Done	BOOL	FALSE	Output Done variables of MC_MoveSuperImposed for slave axis. TRUE when the superimposed movement is completed.
MC_MoveSuperImposed_Distance	LREAL	1000	Superimposed displacement of the assigned slave axis.
MC_MoveSuperImposed_VelocityDiff	LREAL	1500	Specify the relative velocity to the master axis while the superimposed movement operating on the slave axis.

● Timing diagram

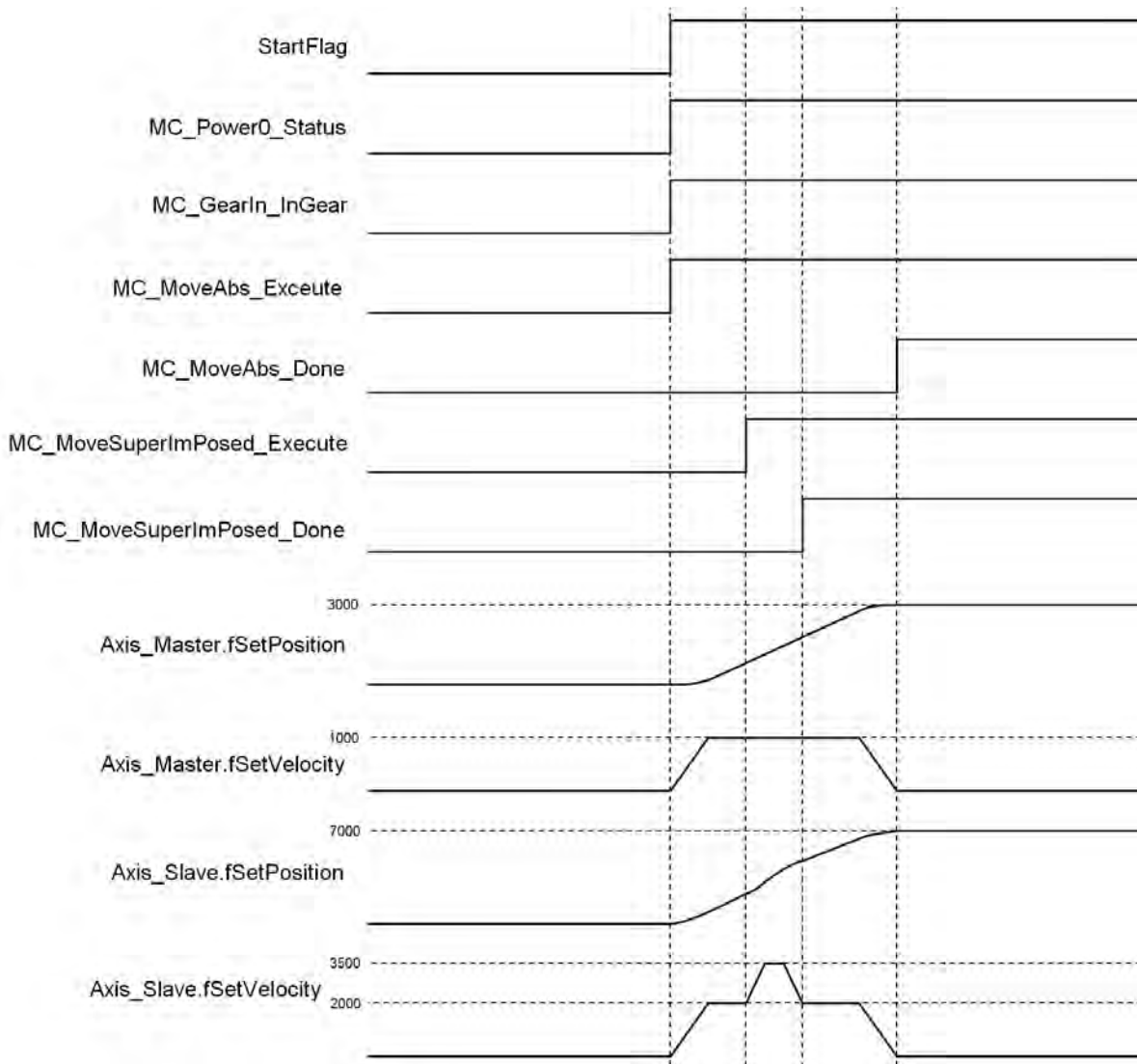

● LD language

Set StartFlag to be TRUE, then the normal operation of communications for both master and slave axis would be checked respectively.

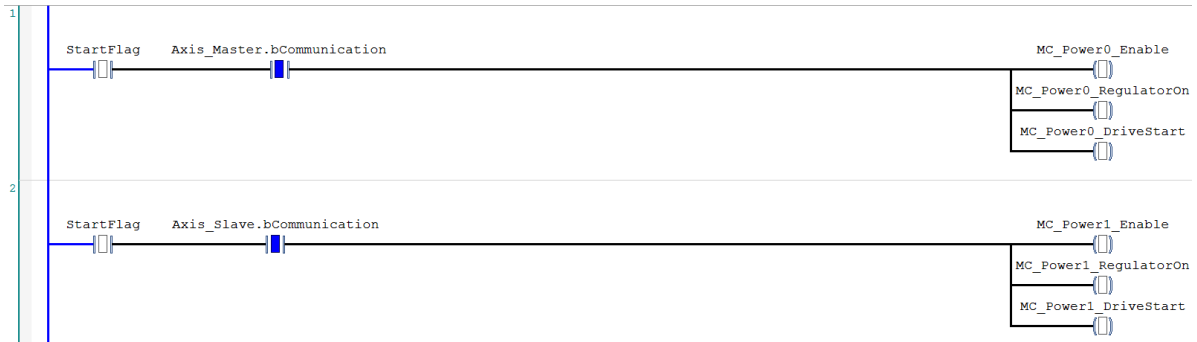

Under normal condition, Servo ON state will be set to master and slave axis.

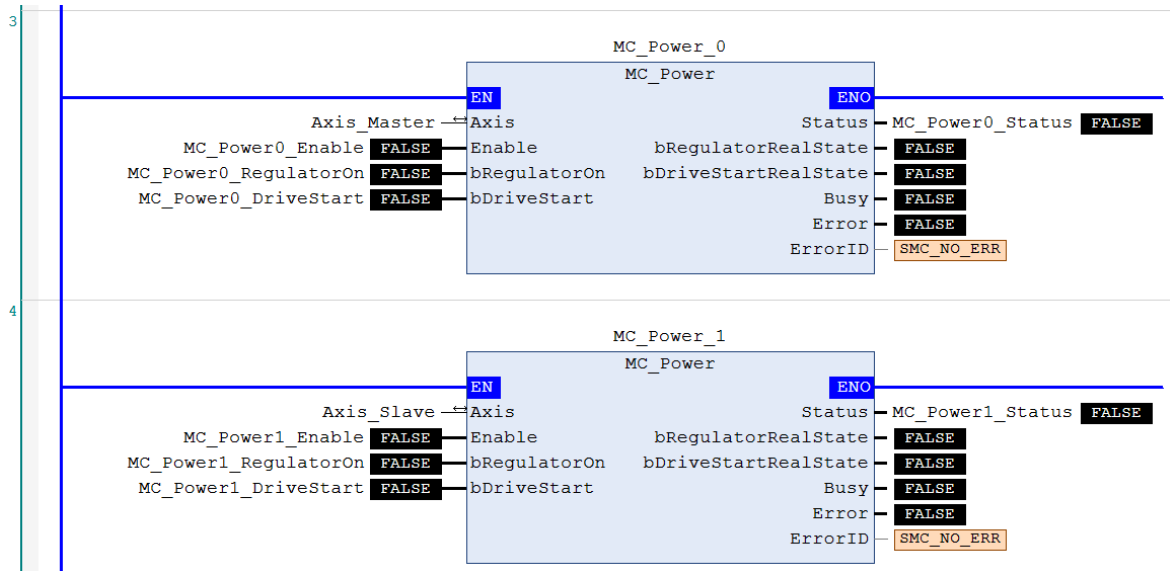

When the master and slave axis are in Servo On state and unsure of the start position, home positioning operation will be required.



After the homing operation is completed, execute MC_GearIn to activate a master-slave coupling (gear coupling).

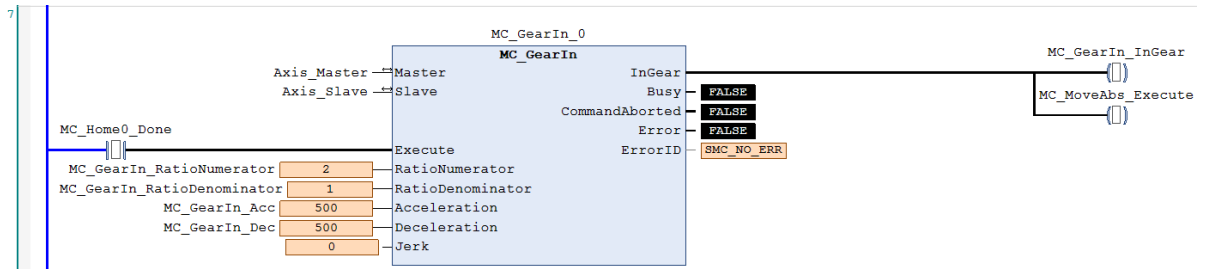

Right after the engage action completed with output InGear, execute MC_MoveAbsolute to the master axis.

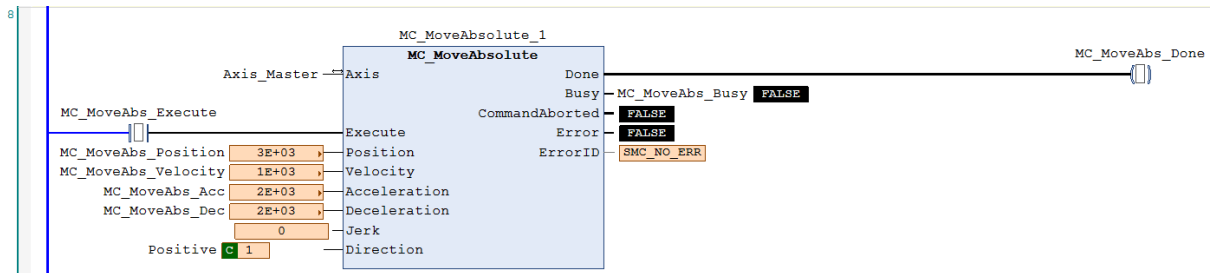

At the same time, when the slave axis moves to the preset triggering position=2000 based on the coupling relationship, MC_MoveSuperImposed would be executed which the slave axis would move a superimposed distance of specific displacement on the original preset target position.

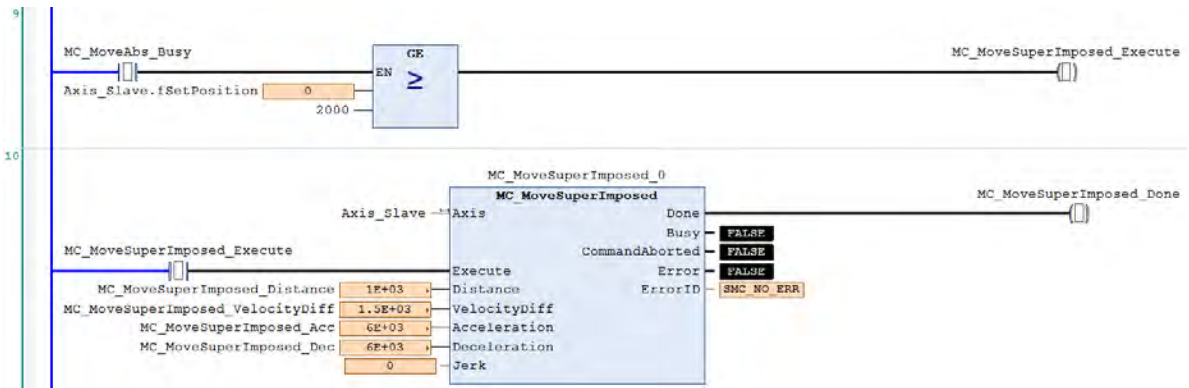

According to the above settings, slave axis would move a displacement according to the gear ratio relative to the master axis and also the specific distance superimposed while in motion to reach the final target position.

The moving distance of master axis is 3000 and the original target position of slave axis would be 6000 calculated with the gear ratio 1:2. Therefore, the final target position of slave axis will changes to be 7000 (6000+1000) with an extra superimposed distance=1000. While coupling, the velocities of master and slave axis are respectively 1000 and 2000. Yet the velocity of slave axis changes to 3500 while superimposing (the original velocity 2000+ VelocityDiff 1500).

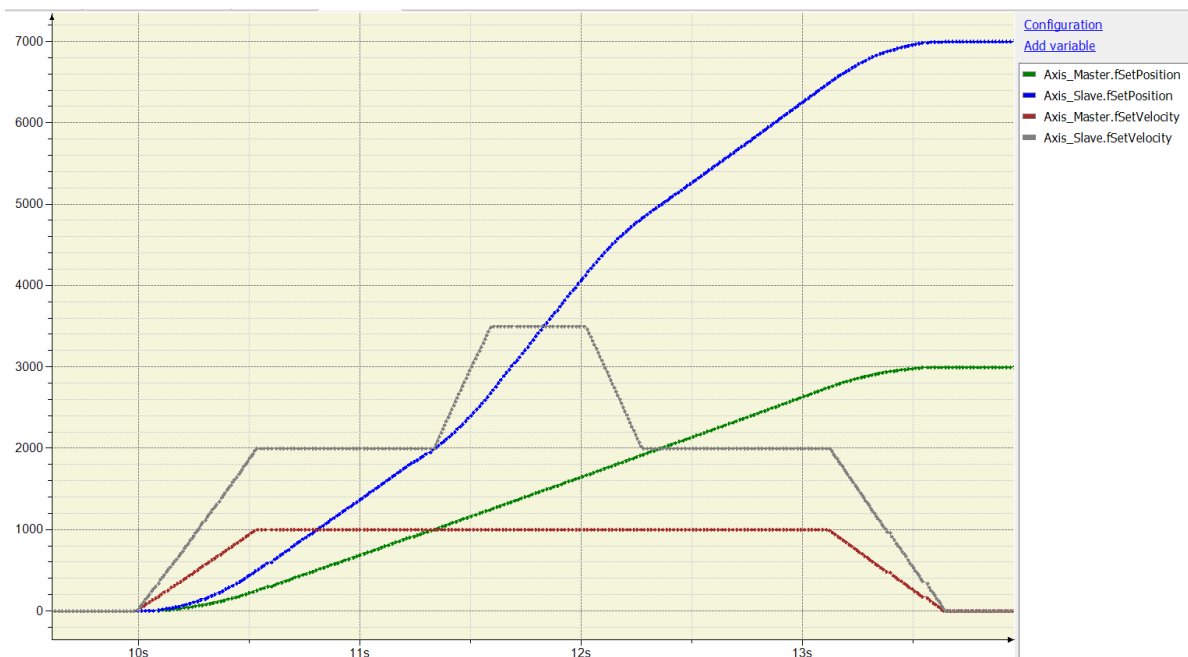

● **ST language**

Set StartFlag to be TRUE, then the normal operation of communications for both master and slave axis would be checked respectively.

IF StartFlag = TRUE THEN

```

    IF Axis_Master.bCommunication = TRUE THEN
        MC_Power0_Enable := TRUE;
        MC_Power0_RegulatorOn := TRUE;
        MC_Power0_DriveStart := TRUE;
    END_IF

```

```

    IF Axis_Slave.bCommunication = TRUE THEN
        MC_Power1_Enable := TRUE;
        MC_Power1_RegulatorOn := TRUE;
        MC_Power1_DriveStart := TRUE;
    END_IF

```

END_IF

Under normal condition, Servo ON state will be set to master and slave axis.

```

MC_Power_0(
    Axis:= Axis_Master,
    Enable:= MC_Power0_Enable,
    bRegulatorOn:= MC_Power0_RegulatorOn,
    bDriveStart:= MC_Power0_DriveStart,
    Status=> MC_Power0_Status,
    bRegulatorRealState=> ,
    bDriveStartRealState=> ,
    Busy=> ,
    Error=> ,
    ErrorID=> );

```

```

MC_Power_1(
  Axis:= Axis_Slave,
  Enable:= MC_Power1_Enable,
  bRegulatorOn:= MC_Power1_RegulatorOn,
  bDriveStart:= MC_Power1_DriveStart,
  Status=> MC_Power1_Status,
  bRegulatorRealState=> ,
  bDriveStartRealState=> ,
  Busy=> ,
  Error=> ,
  ErrorID=> );

```

When the master and slave axis are in Servo On state and unsure of the start position, home positioning operation will be required.

```

IF MC_Power0_Status = TRUE THEN
  MC_Home0_Execute := TRUE;
END_IF

```

```

IF MC_Power1_Status = TRUE THEN
  MC_Home1_Execute := TRUE;
END_IF

```

```

MC_Home_0(
  Axis:= Axis_Master,
  Execute:= MC_Home0_Execute,
  Position:= 0,
  Done=> MC_Home0_Done,
  Busy=> ,
  CommandAborted=> ,
  Error=> ,
  ErrorID=> );

```

```

MC_Home_1(
  Axis:= Axis_Slave,
  Execute:= MC_Home1_Execute,
  Position:= 0,
  Done=> MC_Home1_Done,
  Busy=> ,
  CommandAborted=> ,
  Error=> ,
  ErrorID=> );

```

After the homing operation is completed, execute MC_GearIn to activate a master-slave coupling (gear coupling).

```

MC_GearIn(
  Master:= Axis_Master,
  Slave:= Axis_Slave,
  Execute:= MC_Home0_Done,

```

```

RatioNumerator:= MC_GearIn_RatioNumerator,
RatioDenominator:= MC_GearIn_RatioDenominator,
Acceleration:= MC_GearIn_Acc,
Deceleration:= MC_GearIn_Dec,
Jerk:= ,
InGear=> MC_GearIn_InGear,
Busy=> ,
CommandAborted=> ,
Error=> ,
ErrorID=> );

```

```

IF MC_GearIn_InGear = TRUE THEN
    MC_MoveAbs_Execute := TRUE;
END_IF

```

Right after the engage action completed with output InGear, execute MC_MoveAbsolute to the master axis.

```

MC_MoveAbsolute(
    Axis:= Axis_Master,
    Execute:= MC_MoveAbs_Execute,
    Position:= MC_MoveAbs_Position,
    Velocity:= MC_MoveAbs_Velocity,
    Acceleration:= MC_MoveAbs_Acc,
    Deceleration:= MC_MoveAbs_Dec,
    Jerk:= ,
    Direction:= Positive,
    Done=> MC_MoveAbs_Done,
    Busy=> MC_MoveAbs_Busy,
    CommandAborted=> ,
    Error=> ,
    ErrorID=> );

```

At the same time, when the slave axis moves to the preset triggering position=2000 based on the coupling relationship, MC_MoveSuperImposed would be executed which the slave axis would move a superimposed distance of specific displacement on the original preset target position.

```

IF MC_MoveAbs_Busy = TRUE THEN
    IF Axis_Slave.fSetPosition >= 2000 THEN
        MC_MoveSuperImposed_Execute := TRUE;
    END_IF
END_IF

```

```

MC_MoveSuperImposed(
    Axis:= Axis_Slave,
    Execute:= MC_MoveSuperImposed_Execute,
    Distance:= MC_MoveSuperImposed_Distance,
    VelocityDiff:= MC_MoveSuperImposed_VelocityDiff,
    Acceleration:= MC_MoveSuperImposed_Acc,
    Deceleration:= MC_MoveSuperImposed_Dec,
    Jerk:= ,

```

```
Done=> MC_MoveSuperImposed_Done,  
Busy=> ,  
CommandAborted=> ,  
Error=> ,  
ErrorID=> );
```

Chapter 8 OPC UA Server

Table of Contents

- 8.1 OPC UA Server 8-2**
 - 8.1.1 Creating a Project for OPC UA Access 8-2
- 8.2 Setting up a Connection with the “UaExpert” Client..... 8-4**
- 8.3 Setting up an Encrypted Connection 8-8**
 - 8.3.1 Setting up User Account and Password 8-8
 - 8.3.2 CODESYS Security Agent..... 8-9
 - 8.3.3 Setting up an Encrypted Connection with the “Prosys OPC UA Client” 8-12
 - 8.3.4 Setting up an Encrypted Connection with the “UaExpert” 8-15

8.1 OPC UA Server

The standard installation of DIADesigner-AX includes an OPC UA server. You can use it to access the variable interface of the controller via a client. The OPC UA server communicates with connected OPC UA clients over a separate TCP connection. Therefore, these connections have to be examined again separately with regard to security.

The OPC UA server can now be safeguarded by using encrypted communication to the client and OPC UA user management. See the following sections for these settings.

- Browsing of data types and variables
- Standard read/write services
- Notification for value changes: subscription and monitored item services
- Encrypted communication according to “OPC UA standard (profile: Basic256SHA256)”

8.1.1 Creating a Project for OPC UA Access

You need to create a project for OPC UA access before using OPC UA Server. Follow the steps below.

1. Create a new DIADesigner-AX project.
2. Declare some variables of different types in the PLC_PRG program.

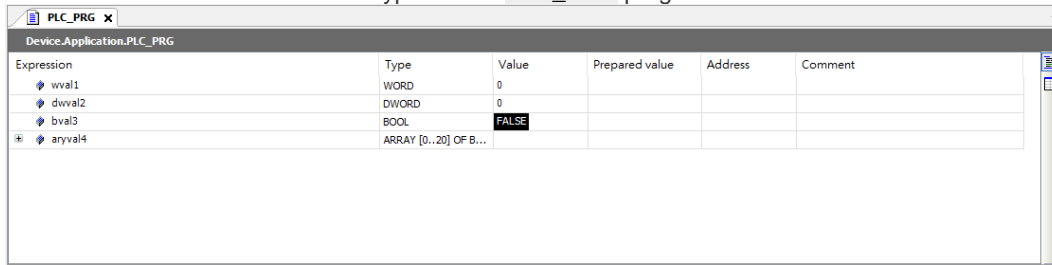

3. Go to *Application -> Add Object -> Symbol Configuration* to add a Symbol Configuration object.

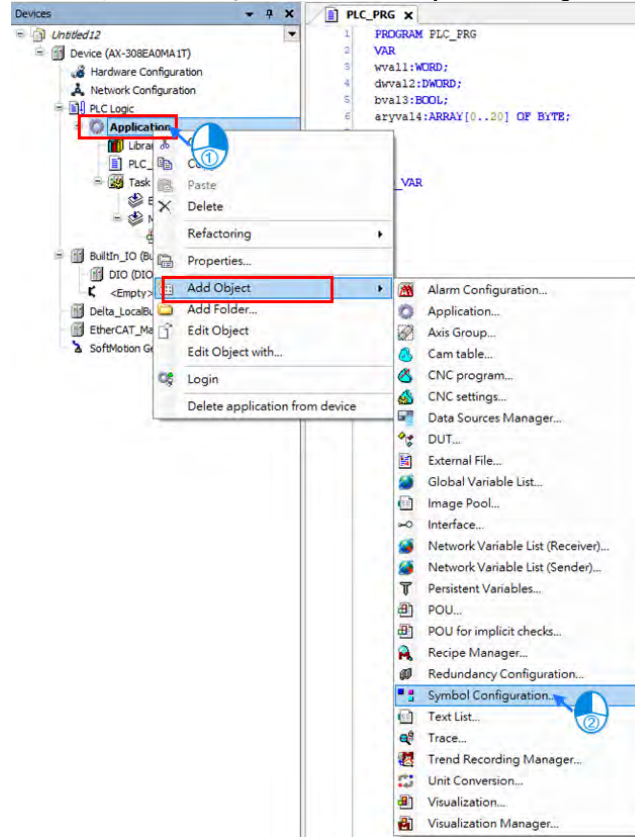

4. Select **Support OPC UA feature** and click **Add** on the setting page of Add Symbol Configuration. After that Symbol Configuration setting page shows up automatically.

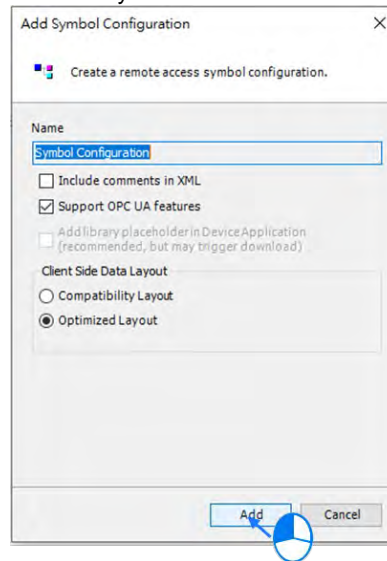

5. Click **Build** on the Symbol Configuration setting page. The variables are shown in a tree structure.

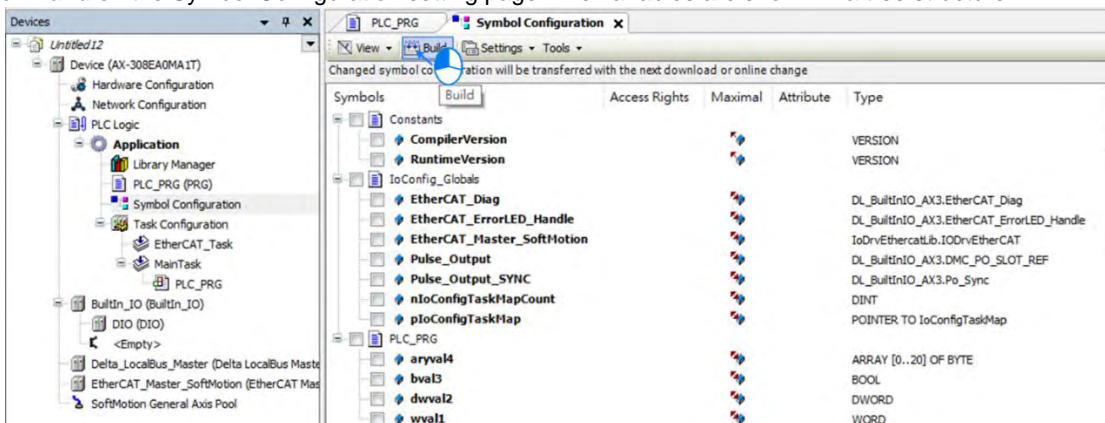

6. Select the variables that you want to change with an OPC UA client. Specify the access rights. After setting, click **Build** again.

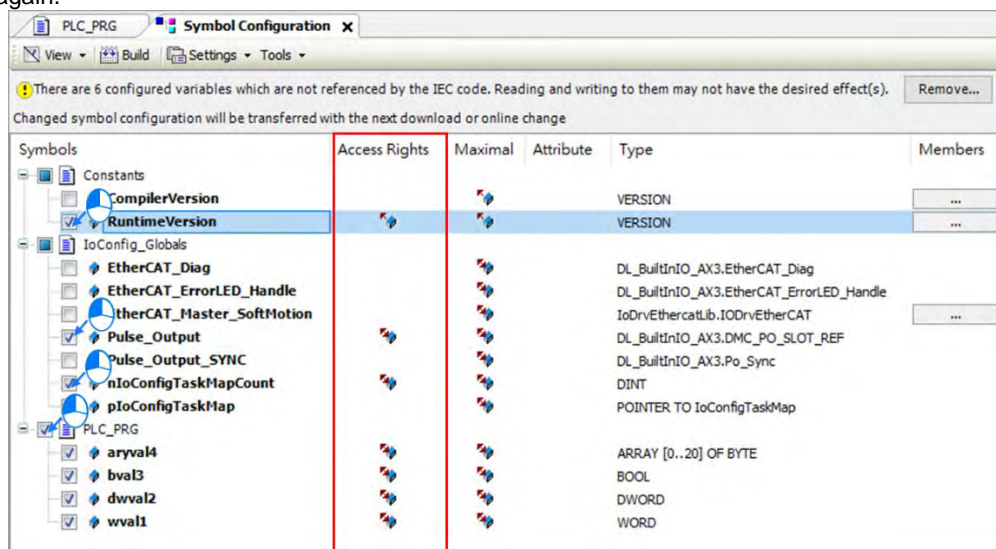

7. Download the project to the AX-3 Series PLC.

8.2 Setting up a Connection with the “UaExpert” Client

The OPC UA client “UaExpert” is freely accessible software. You can download the software here: <https://www.unified-automation.com/downloads/opc-ua-clients.html> Using this client, you can connect to the OPC UA server. The following description refers to this program. Other OPC UA clients work in a similar way. After download UaExpert, follow the following steps to set up a connection.

- (1) Double-click the UaExpert  to start the UaExpert.
- (2) Right-click **Server** and then click **Add** to open Add Server window.

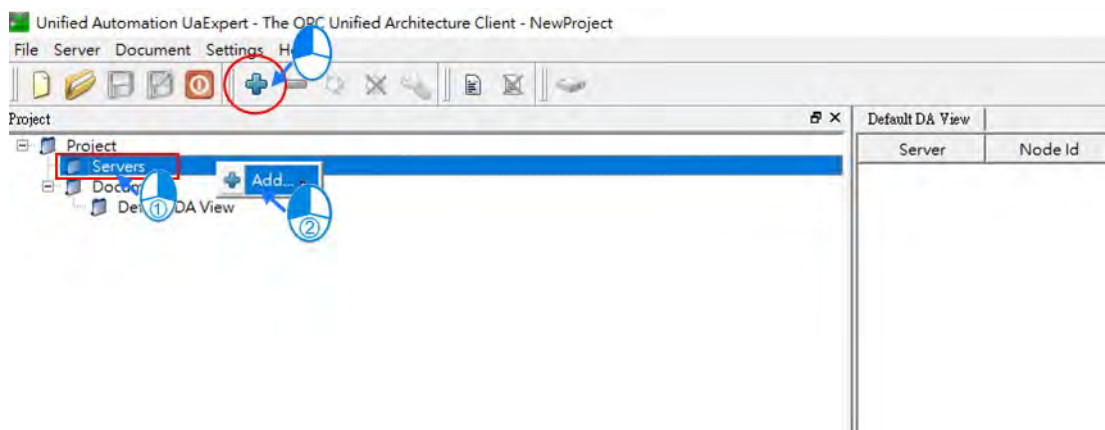

- (3) Go to **Custom Discovery** -> **Double click to Add Server...>** and then type in “**opc.tcp://192.168.1.5**” in the Enter URL dialog.

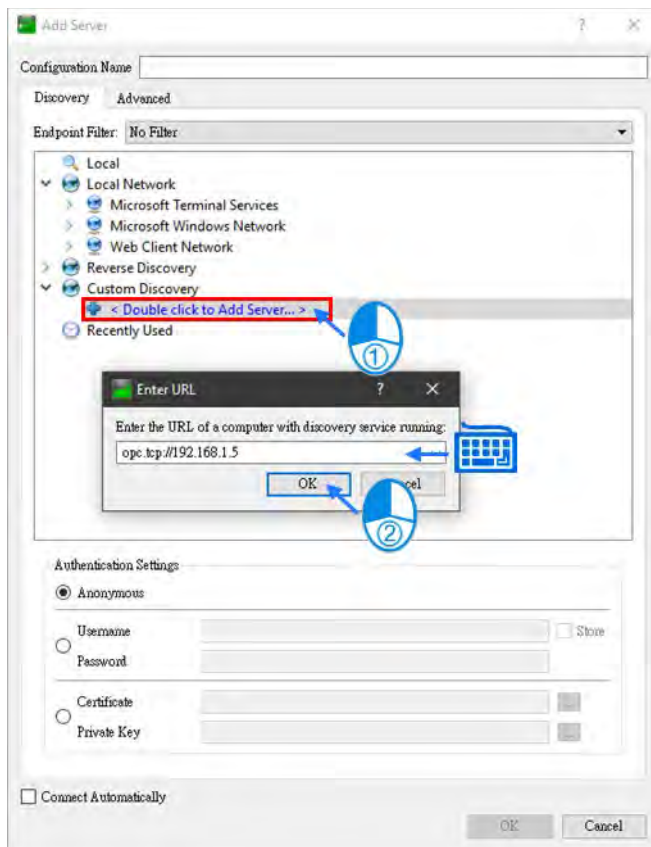

- (4) After that you can find **AX308E** under the **opc.tcp://192.168.1.5**. Select **OPCUAServer@AX-308EA0MA1T** and click **OK** to close the window. If the connection type is NOT an encrypted one, the node **None-None** appears under the added server.

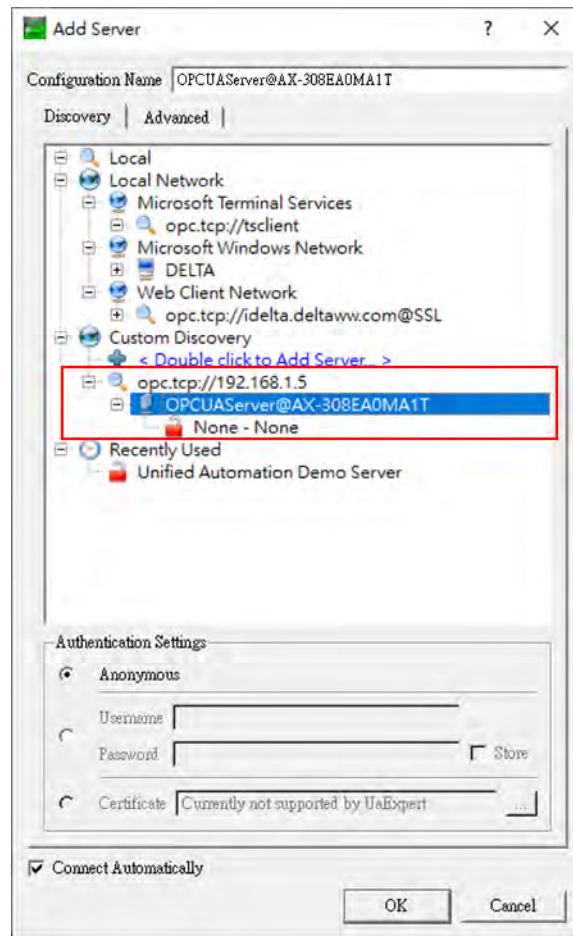

- (5) If you need to edit the server properties, go back to the starting window. Expand the option **Servers** under **Project** and then right-click **AX308** to open a context menu. Click **Properties** to open the Server Settings page.

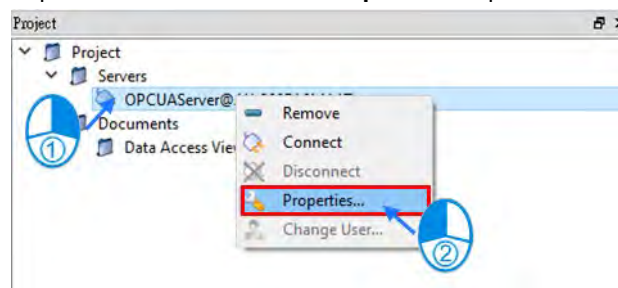

- (6) Change the Endpoint Url from OPCUAServer@AX-308EA0MA1T:4840 to **opc.tcp://192.168.1.5:4840** and click **OK** to close the window.

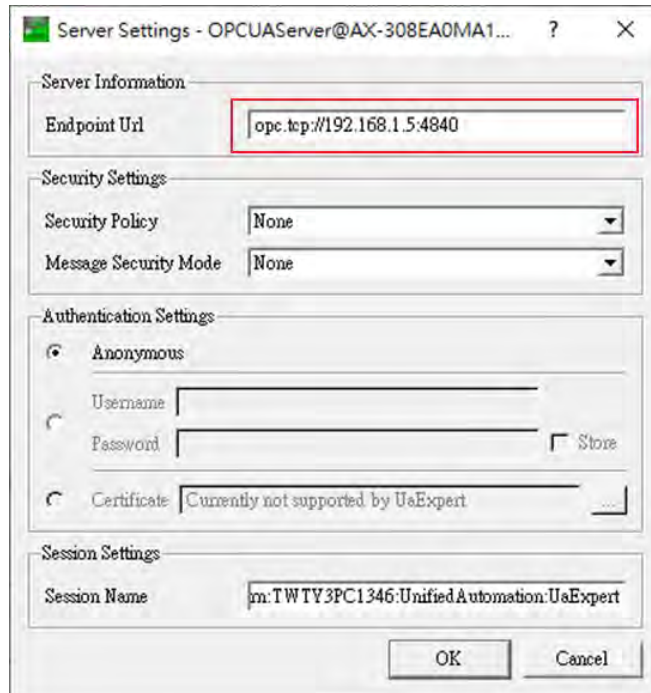

- (7) Right-click **AX308** to open a context menu. Click **Connect** to AX308E.

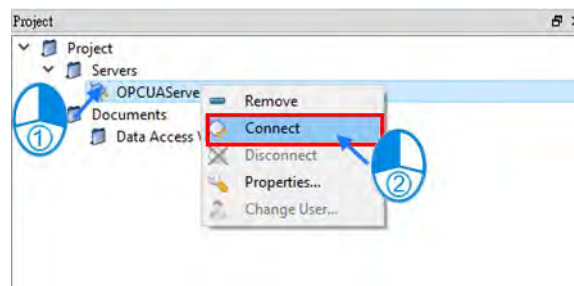

- (8) After establishing the connection, you can change the variables in AX308E through the OPC UA client UaExpert. Select and drag the variables you'd like to modify from the left view "Address Space" to the right view "Default DA View" and then double-click the item to be modified to edit.

The screenshot displays the UaExpert interface. The 'Default DA View' panel on the right shows a table of variables from the AX308E server. The 'Address Space' panel on the left shows a tree view of the device's address space, with 'vival1' selected under the 'Programs' folder.

Server	Node id	Display Name	Value	Datatype	Source Timestamp	Server Timestamp	Statuscode
AX308E	NS4:String[vari]Delta-ARM-VWWorks...	aryval4	0,0,0,0,0,0,0,0,0,0,0,0,0,0,0,0,0,0	Byte	08.25.51.428	08.25.51.428	Good
AX308E	NS4:String[vari]Delta-ARM-VWWorks...	bval3	false	Boolean	08.25.52.825	08.25.52.825	Good
AX308E	NS4:String[vari]Delta-ARM-VWWorks...	dval2	0	UInt32	08.25.54.211	08.25.54.211	Good
AX308E	NS4:String[vari]Delta-ARM-VWWorks...	vival1	0	UInt16	08.25.55.622	08.25.55.622	Good

8.3 Setting up an Encrypted Connection

To have a successful encrypted connection, you need to follow the sections below to create certificates for OPC UA server and OPC UA client.

8.3.1 Setting up User Account and Password

Setting up an account and password for OPC UA Server is the same as setting up the account for AX-3 Series PLC. Refer to section 4.2.1.8 of AX-3 Series Operation Manual for more information.

Below is an example for setting up a new account as guest. The default account is Administrator. And here you can see two accounts on the example image.

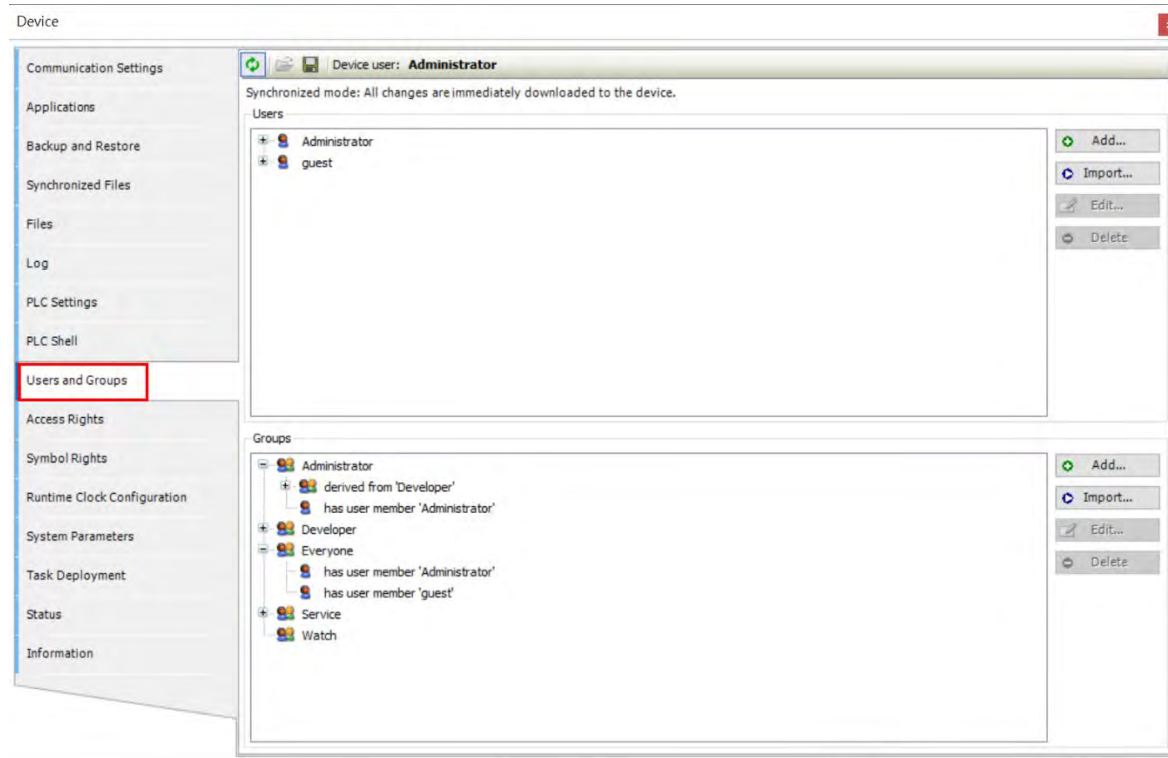

8.3.2 CODESYS Security Agent

In order to encrypt data and exchange it with the client safely, the server needs a certificate that the client must classify as trusted when a connection is established for the first time. You will need **CODESYS Security Agent** for creating a certificate for the DIADesigner-AX. Go to CoDeSys Store to download the software: https://store.codesys.com/matrikon-flex-opc-ua-editor.html?_SID=U

- (1) Install the add-on  **CODESYS Security Agent**. After installing, you need to restart DIADesigner-AX.

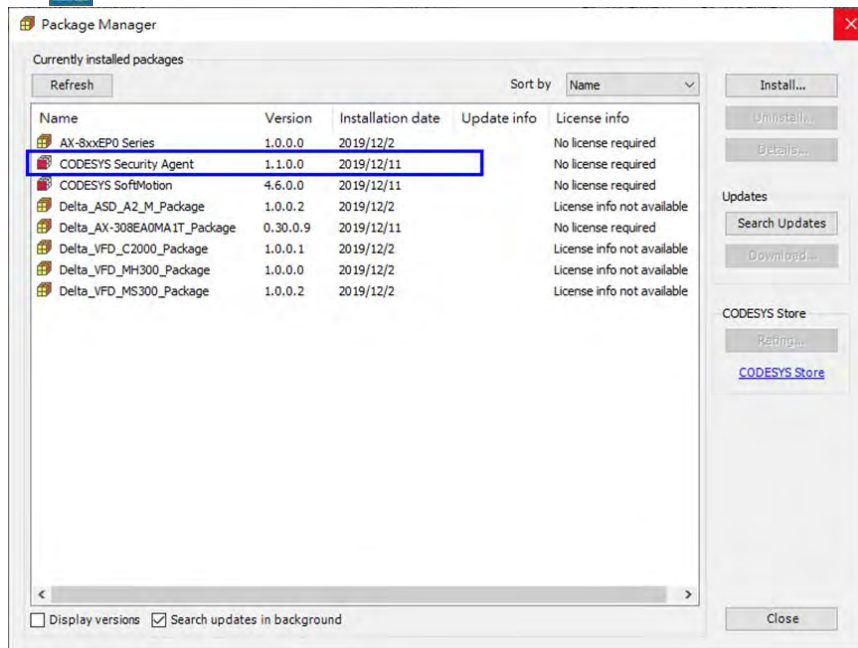

- (2) Open DIADesigner-AX to create a project. Click **View** on the toolbar and then click the option **Security Screen** to open the setting page.

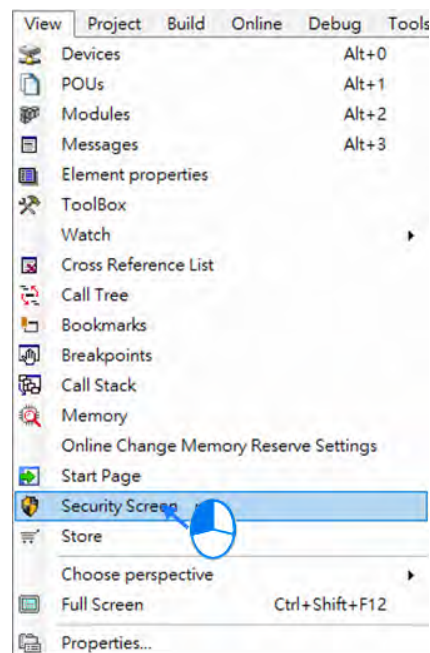

(3) Select the **Devices** tab.

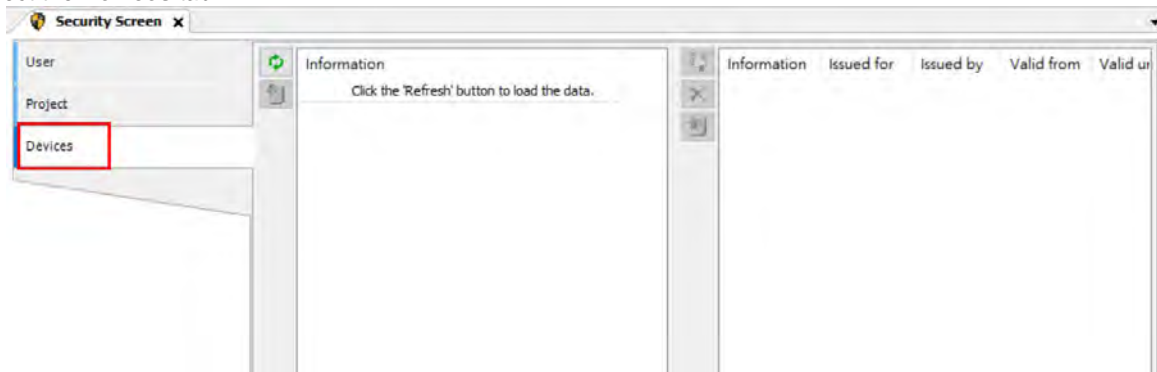

(4) Click  to refresh and all services of the controller that require a certificate are displayed in the right view.

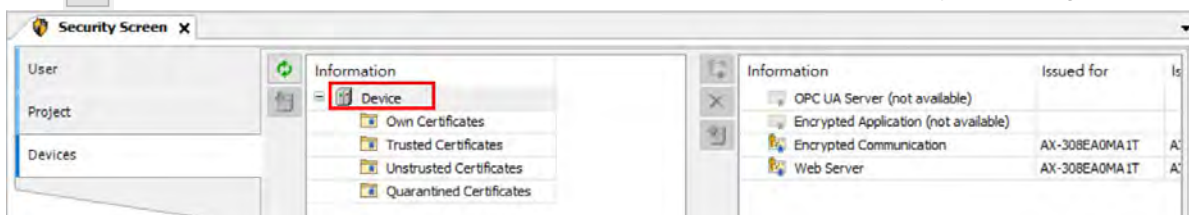

(5) Select the service **OPC UA Server** and then click  to open the **Certificate Settings** page for the creation of a new certificate for the device. After setting up the certificate parameters, click OK. And the certificate is created on the controller.

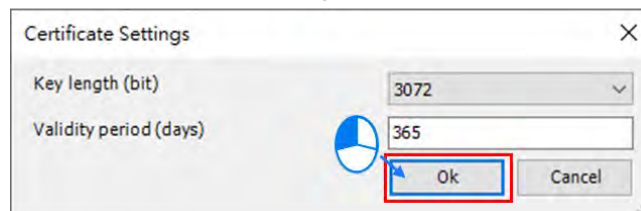
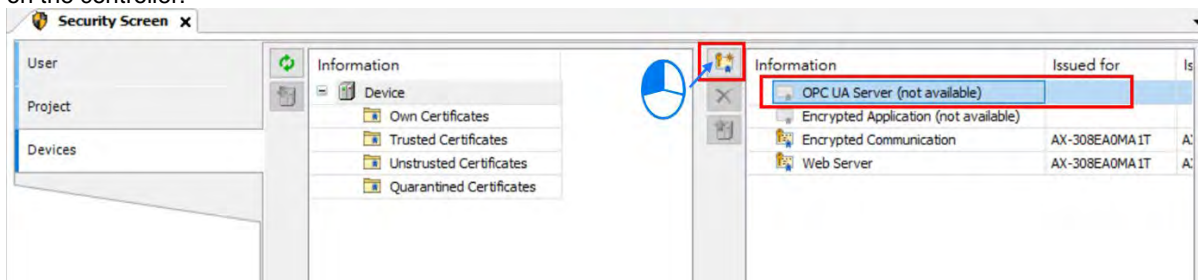

- (6) Again select the service **Encrypted Application** and then click  to open the **Certificate Settings** page for the creation of a new certificate for the device. After setting up the certificate parameters, click OK. And the certificate is created on the controller.

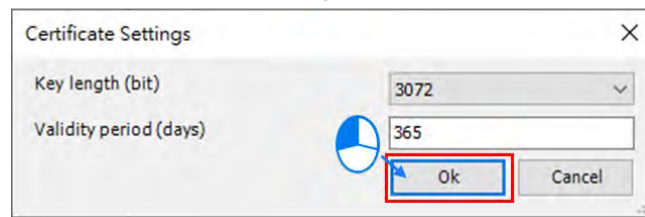
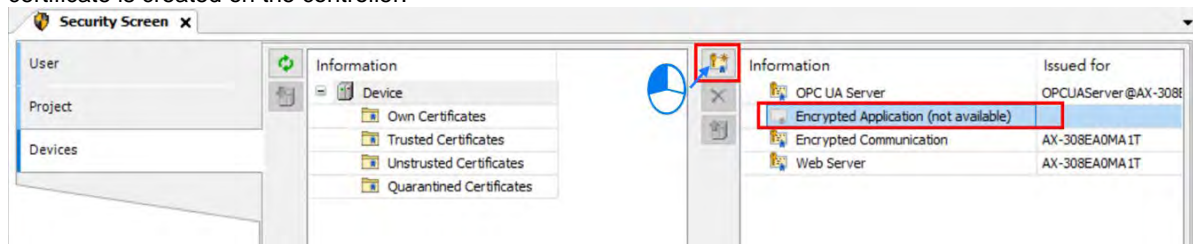

- (7) And you have created two certificates **OPC UA Server** and **Encrypted Application** on the controller.*

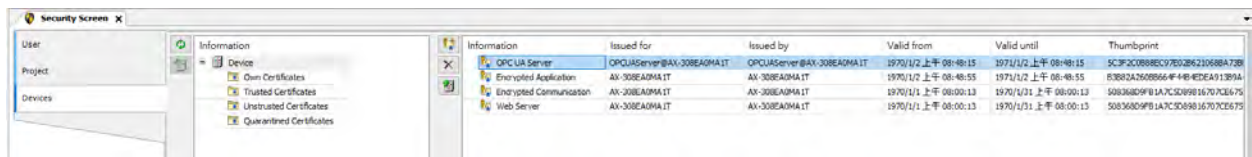

* Note: You need to power-on and then power-off the PLC to have the two certificates become effective.

8.3.3 Setting up an Encrypted Connection with the “Proslys OPC UA Client”

The OPC UA client “Proslys OPC UA Client” is freely accessible software. You can download the software here:

<https://downloads.prosysopc.com/opc-ua-client-downloads.php>

Using this client, you can connect to the OPC UA server. The following description uses Proslys OPC UA Client V3.2.0 as an example. Other OPC UA clients work in a similar way. After download Proslys OPC UA Client, follow the following steps to set up a connection.

- (1) Double-click the Proslys OPC UA Client  to start the Proslys OPC UA Client.

- (2) Type in the OPC UA Server IP address “**opc.tcp://192.168.1.5:4840**” in the field of Disconnected as shown in ①.

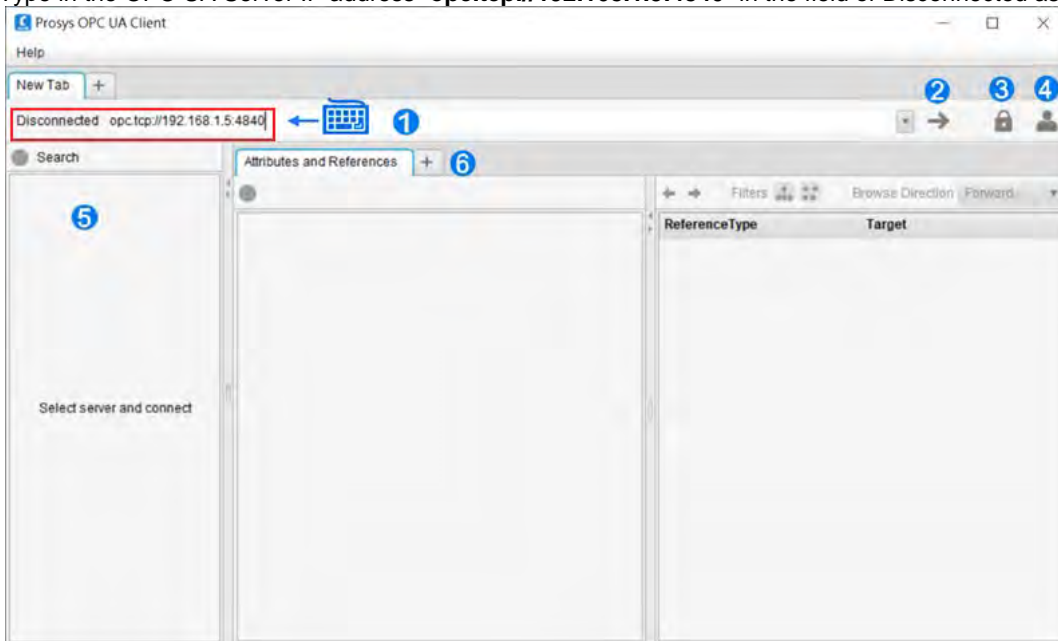

- (3) Click  as shown in ③ to open the **Security Settings** window. Only the connection type **Basic256SHA256** is supported. Select “**Show only modes that are supported by the server**”. Click **OK**.

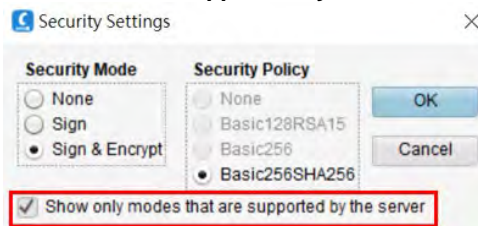

- (4) Click  as shown in ④ to open the User Authentication setting window. Set up the username and password and click **Apply** to apply the settings.

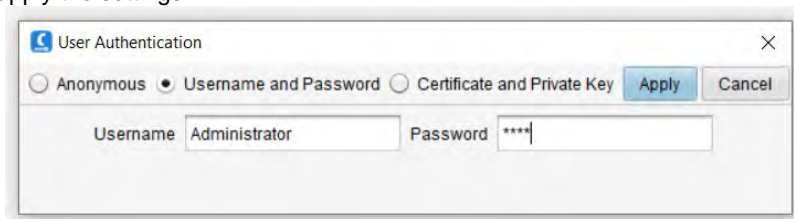

- (5) If you click  as shown in (2) to connect to the AX-3 Series PLC. You will see a warning, stating the server does not accept this application's certificate. That is because ProsysOpcUaClient is not a trusted certificate for AX-3Series PLC. You need to go back to DIADesigner-AX to approve this service.

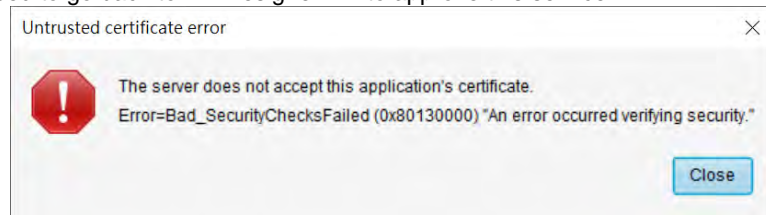

- (6) Go back to DIADesigner-AX. Click **View** on the toolbar and then click the option **Security Screen** to open the setting page. Select the **Devices** tab.

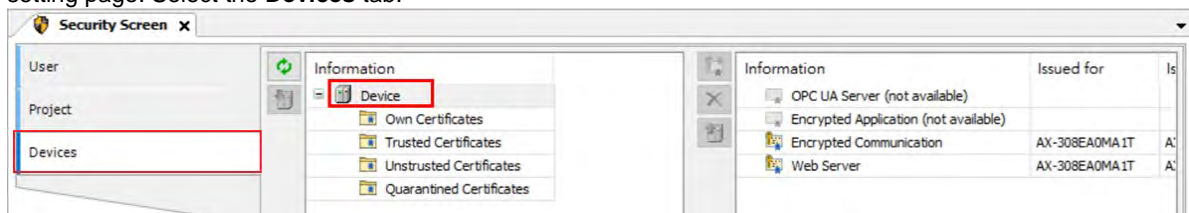

- (7) Click  to refresh and all services of the controller that require a certificate are displayed in the right view. Find **ProsysOpcUaClient** in the folder of **Quarantined Certificates**. Drag it to the folder of **Trusted Certificates**.

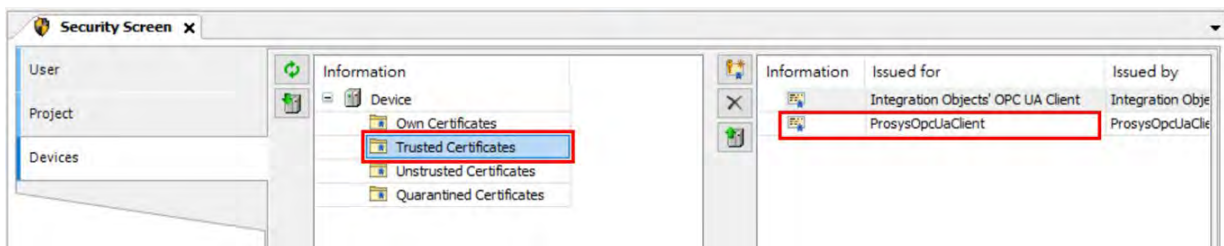
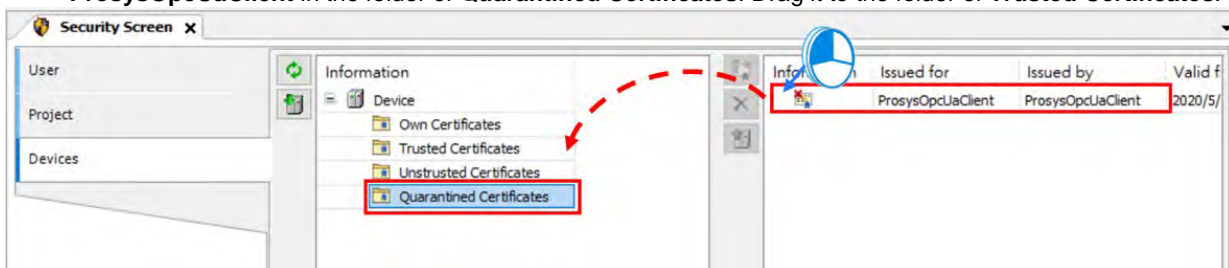

(8) Go back to ProsysOpcUaClient. Click  as shown in (2) to connect to the AX-3 Series PLC as an Administrator.

After establishing the connection, you can edit the settings in AX308E through ProsysOpcUaClient.

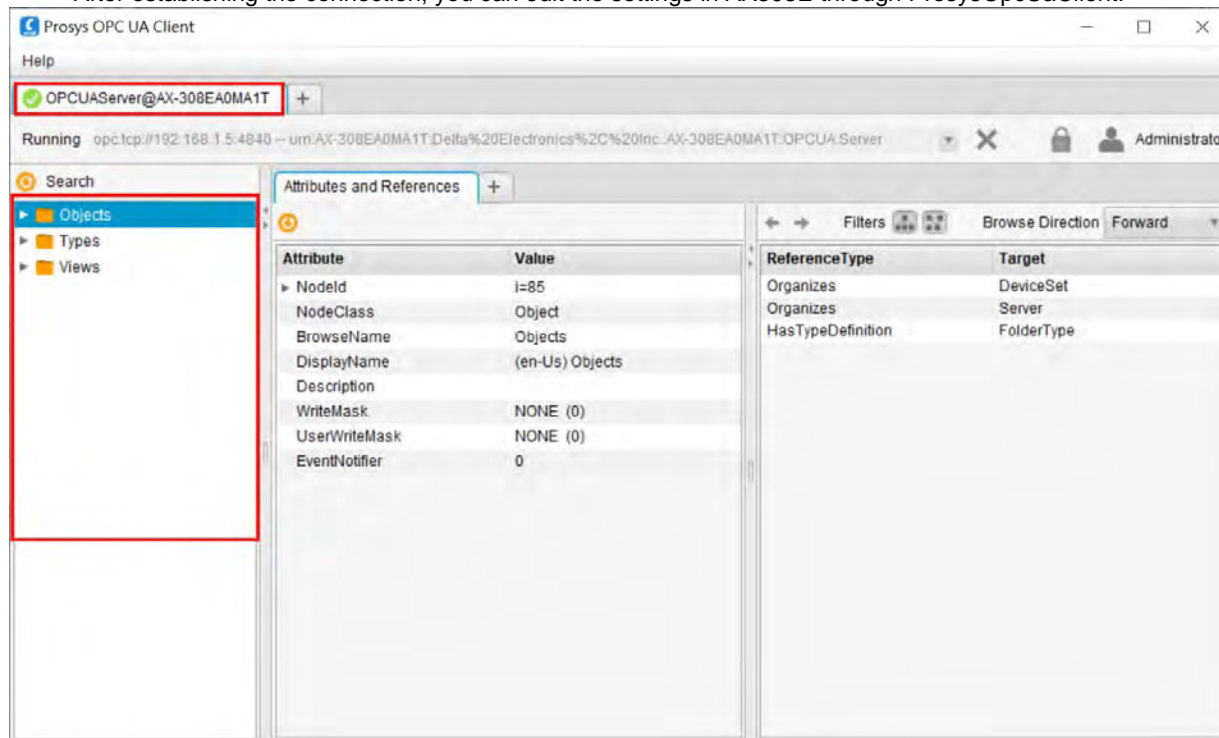

If you connect to the AX-3 Series PLC as a guest. You do not have permission to make any change on the settings.

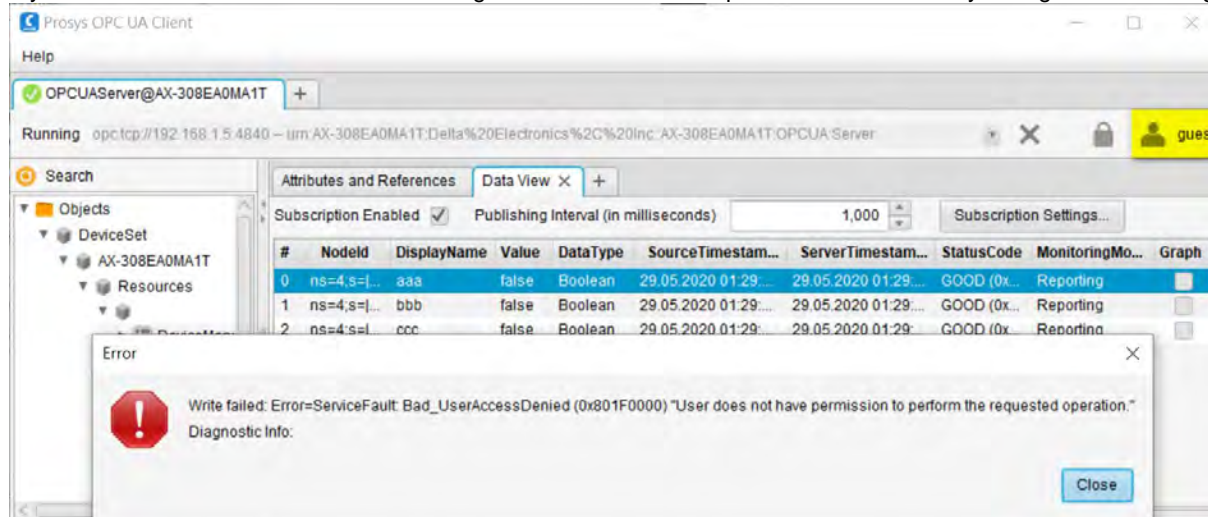

8

8.3.4 Setting up an Encrypted Connection with the “UaExpert”

The OPC UA client “UaExpert” is freely accessible software. You can download the software here: <https://www.unified-automation.com/downloads/opc-ua-clients.html> Using this client, you can connect to the OPC UA server. The following description uses UaExpert V1.5 as an example. Other OPC UA clients work in a similar way. After download UaExpert, follow the following steps to set up a connection.

- (1) Double-click the UaExpert  to start the UaExpert.
- (2) Right-click **Server** and then click **Add** to open Add Server window.

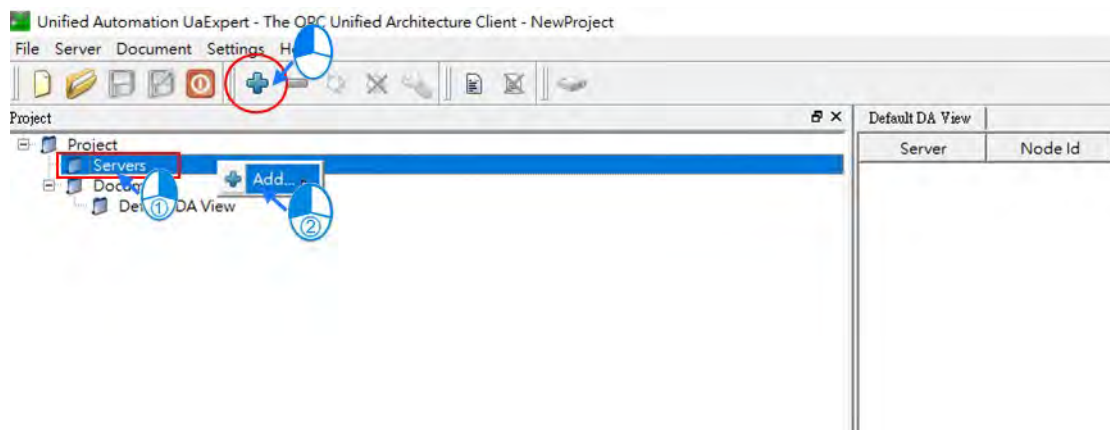

- (3) Go to **Custom Discovery** -> **Double click to Add Server...>** and then type in “opc.tcp://192.168.1.5” in the Enter URL dialog.

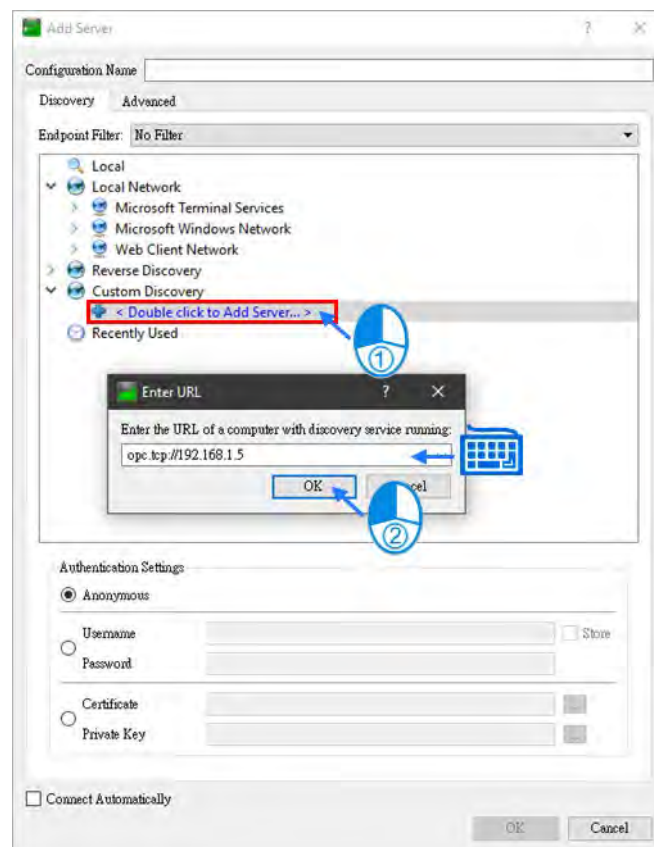

- (4) After that you can find **opc.tcp://192.168.1.5** under **Custom Discovery**. Select **Basic256SHA256** under the **OPCUAServer@AX-308EA0MA1T (opc.tcp)** and click **OK** after inputting the **Username** and **Password** in the **Authentication Settings** to create an encrypted connection.

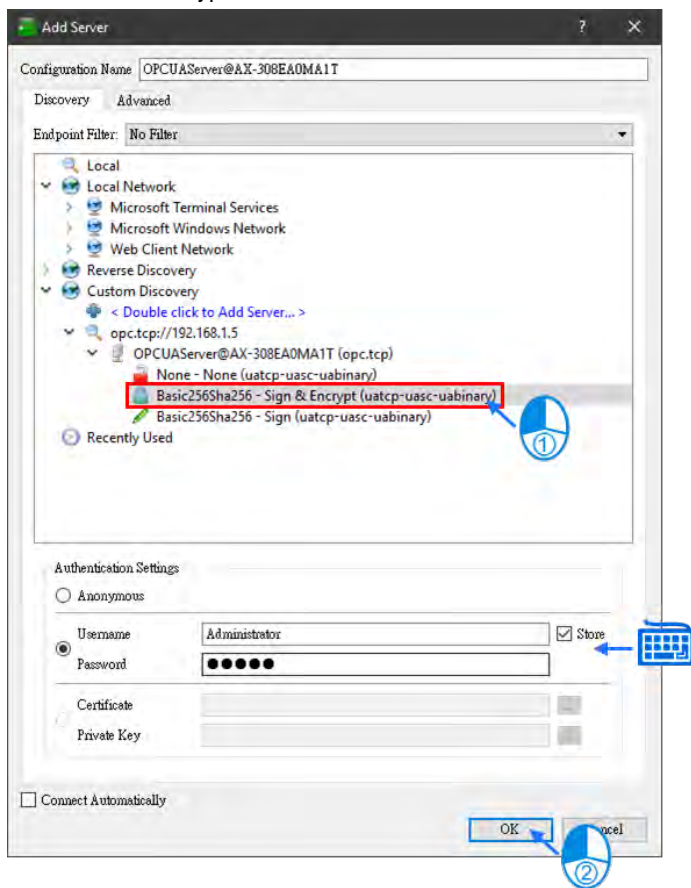

- (5) If you need to edit the server properties, go back to the starting window. Expand the option **Servers** under **Project** and then right-click **AX308** to open a context menu. Click **Properties** to open the Server Settings page.

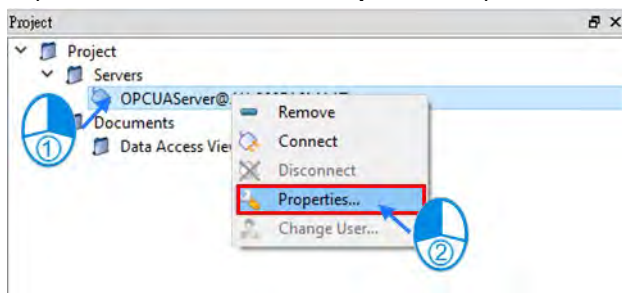

- (6) Change the Endpoint Url from OPCUAServer@AX-308EA0MA1T:4840 to **opc.tcp://192.168.1.5:4840** and click **OK** to close the window.

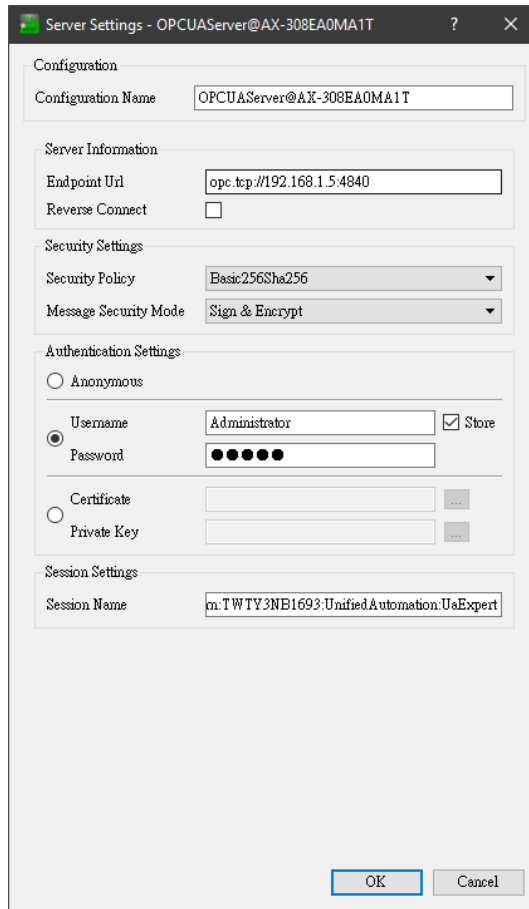

- (7) Right-click **AX308** to open a context menu. Click **Connect** to AX308E.

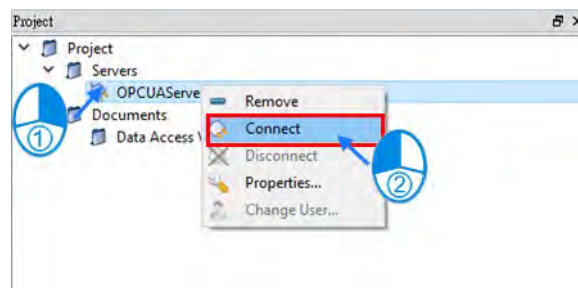

- (8) After clicking **Connect**, you will see an error. That is because UaExpert is not a trusted certificate for AX-3Series PLC. You need to go back to DIADesigner-AX to approve this service.

Timestamp	Source	Server	Message
1/18/2021 6:25:10.622 PM	Server Node	OPCUAServer@AX-308EA0MA1T	Endpoint: 'opc.tcp://AX-308EA0MA1T:4840'
1/18/2021 6:25:10.622 PM	Server Node	OPCUAServer@AX-308EA0MA1T	Security policy: 'http://opcfoundation.org/UA/SecurityPolicy#Basic256Sha256'
1/18/2021 6:25:10.622 PM	Server Node	OPCUAServer@AX-308EA0MA1T	ApplicationUri: 'urn:AX-308EA0MA1T:Delta%20Electronics%2C%20Inc.:AX-308EA0MA1T:OPCUA-Server'
1/18/2021 6:25:10.622 PM	Server Node	OPCUAServer@AX-308EA0MA1T	Used UserTokenType: UserName
1/18/2021 6:25:10.737 PM	Server Node	OPCUAServer@AX-308EA0MA1T	Error 'BadSecurityChecksFailed' was returned during OpenSecureChannel.
1/18/2021 6:25:10.737 PM	Server Node	OPCUAServer@AX-308EA0MA1T	Connection status of server 'OPCUAServer@AX-308EA0MA1T' changed to 'Disconnected'.

- (9) Go back to DIADesigner-AX. Click **View** on the toolbar and then click the option **Security Screen** to open the setting page. Select the **Devices** tab. Click  to refresh and all services of the controller that require a certificate are displayed in the right view. Find **UaExpert** in the folder of **Quarantined Certificates**. Drag it to the folder of **Trusted Certificates**.

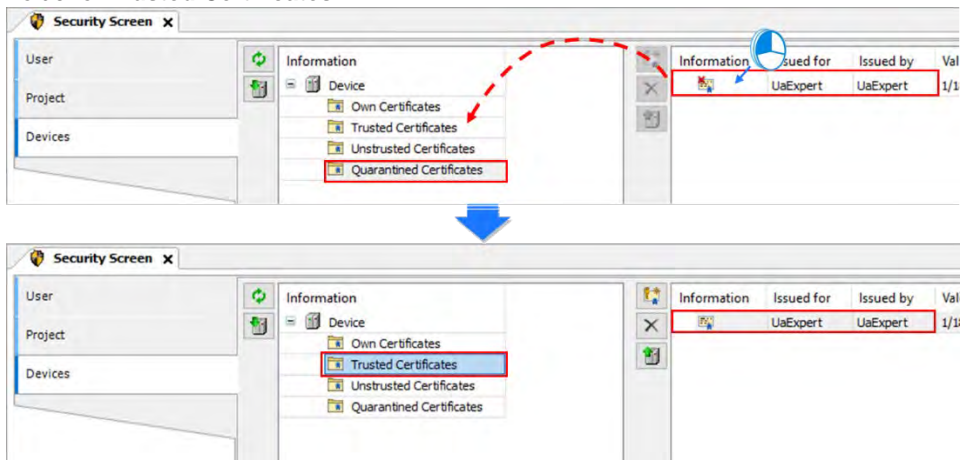

- (10) Repeat step 7 to connect to OPC UA Server again. After the connection is established, you can see the tree node on the left side and you can edit the settings in AX308E through UaExpert.

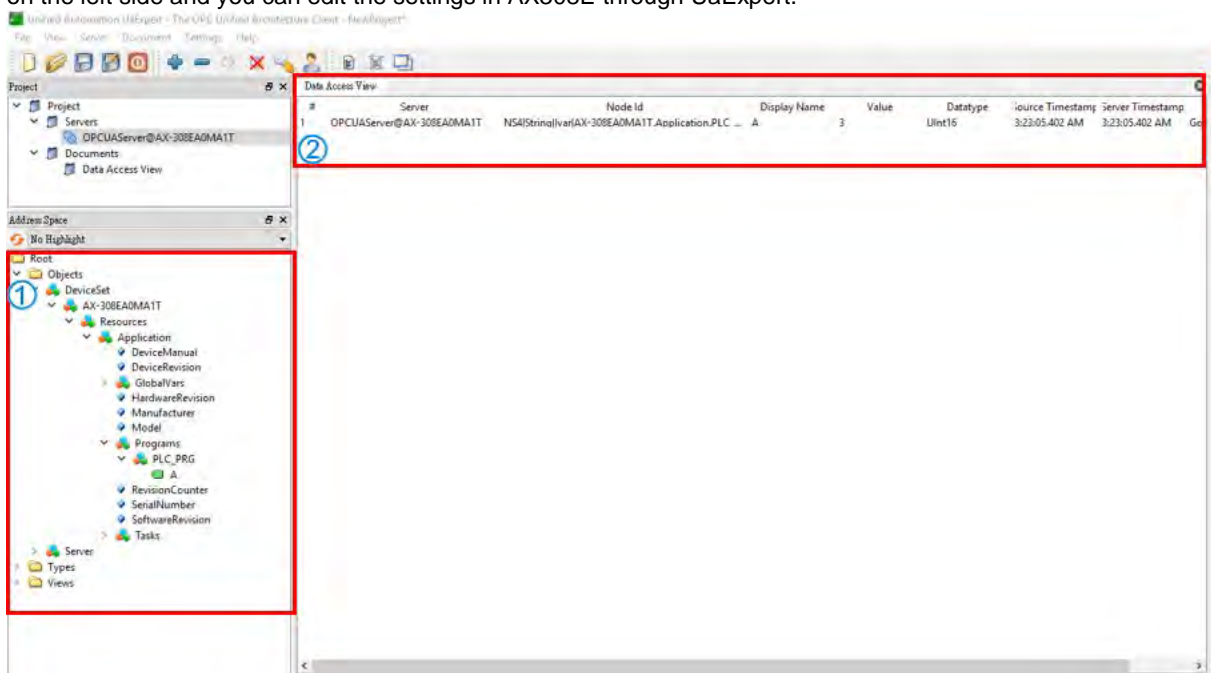

8

Chapter 9 Communication

Table of Contents

9.1 Introduction to EtherCAT Communication	9-3
9.1.1 Features of EtherCAT Fieldbus.....	9-3
9.1.2 Settings up EtherCAT Master.....	9-4
9.1.3 Setting up the EtherCAT Slave	9-6
9.1.4 Backup Parameters for EtherCAT Slaves	9-9
9.1.4.1 Data Backup Procedure	9-9
9.1.4.2 Introduction to Backup and Restore	9-10
9.1.4.2.1 Operation for the Backup Function.....	9-12
9.1.4.2.2 Operation for the Restore Function	9-14
9.2 Introduction to Modbus Serial Communication.....	9-16
9.2.1 Modbus Serial Port.....	9-16
9.2.1.1 Adding Delta Modbus COM.....	9-16
9.2.1.2 Setting up Delta Modbus COM.....	9-17
9.2.2 Modbus Serial Master	9-19
9.2.2.1 Adding Delta Modbus Master/Slave COM	9-19
9.2.2.2 Setting up Delta Modbus Master COM	9-21
9.2.2.3 Setting up Delta Modbus Slave COM	9-23
9.2.3 Modbus Serial Slave.....	9-29
9.2.3.1 Adding a Modbus Serial Device.....	9-29
9.2.3.2 Setting up the Modbus Serial Device	9-30
9.3 Introduction to Ethernet Communication	9-32
9.3.1 Network Security.....	9-32
9.3.2 Ethernet	9-32
9.3.2.1 Adding an Ethernet Adapter Device.....	9-32
9.3.2.2 Setting up the Ethernet	9-33
9.3.3 Modbus TCP Master (Client)	9-37
9.3.3.1 Adding a Modbus TCP Master/Slave	9-37
9.3.3.2 Setting up the Modbus TCP Master.....	9-40
9.3.3.3 Setting up the Modbus TCP Slave	9-41
9.3.4 Modbus TCP Slave (Server).....	9-47
9.3.4.1 Adding a Modbus TCP Slave Device.....	9-47
9.3.4.2 Setting up the Modbus TCP Slave Device	9-49
9.3.5 PROFINET IO	9-51
9.3.5.1 PROFINET Device	9-51
9.3.5.1.1 Add a PROFINET Device	9-51
9.3.5.1.2 Settings of PROFINET Device	9-55
9.3.5.1.3 Export GSDML File.....	9-57

9.4 EtherNet/IP	9-58
9.4.1 Introduction to EtherNet/IP	9-58
9.4.1.1 EtherNet/IP Overview	9-58
9.4.1.2 Definition	9-58
9.4.1.3 Features of Ethernet	9-59
9.4.1.3.1 Delta EIP Architecture.....	9-59
9.4.1.3.2 Features of EIP	9-60
9.4.2 EtherNet/IP Scanner Function	9-61
9.4.2.1 Setting up Compact Drive MS300	9-61
9.4.2.1.1 Hardware Configuration	9-61
9.4.2.1.2 Read-Write Setting for Implicit Messages	9-61
9.4.2.1.3 CIP Object Read-Write Setting for Explicit Messages	9-67
9.4.2.2 Read-Write to AS00SCM-A (AS-FEN02 Communication Card)	9-68
9.4.2.2.1 Setup IO modules on AS00SCM-RTU.....	9-68
9.4.2.2.2 Download the EDS File of AS00SCM-RTU.....	9-70
9.4.2.2.3 Configure EtherNet/IP Parameters of AS00SCM-RTU	9-77
9.4.2.2.4 Operate IO modules on AS00SCM-RTU.....	9-80
9.4.2.2.5 Parameter Information of AS00SCM-RTU Module.....	9-82
9.4.3 EtherNet/IP Adapter Function.....	9-83
9.4.3.1 EtherNet/IP Adapter	9-83
9.4.3.3.1 Add an EtherNet/IP Adapter	9-83
9.4.3.1.2 Setting up EtherNet/IP Adapter.....	9-91
9.4.3.1.3 Export an EDS File	9-92
9.4.3.2 Example of Connecting to a Third Party (Allen Bradley Controllogix 1756-L71).....	9-92
9.4.3.2.1 Structure	9-92
9.4.3.2.2 Create a Project	9-93
9.4.3.2.3 Create a Scanner	9-93
9.4.3.2.4 Create a New Module.....	9-93
9.4.3.2.5 Import an EDS File.....	9-93
9.4.3.2.6 Create a New Adapter.....	9-93
9.4.3.2.7 Projects Download.....	9-94
9.4.3.2.8 Data Mapping	9-94
9.4.4 CIP Object.....	9-95
9.4.4.1 Object List.....	9-95
9.4.4.2 Data Type.....	9-96
9.4.4.3 Identity Object (Class ID: 01 Hex)	9-98
9.4.4.5 TCP/IP Interface Object (Class ID: F5 Hex).....	9-101
9.4.4.6 Ethernet Link Object (Class ID: F6 Hex)	9-103
9.4.5 Delta EIP Product List	9-105
9.4.5.1 Delta EIP Product List (Adapters Supported)	9-105
9.4.5.2 Delta EIP Product List (Scanners Supported).....	9-105

9.1 Introduction to EtherCAT Communication

The compatibility of the firmware version of AX-3 Series PLC CPU and the version of the EtherCAT function library:

Firmware Version	IODrvEtherCAT 3.5.15.30	IODrvEtherCAT 4.4.0.0
V1.0.4.2 or previous	Compatible	Incompatible
V1.0.5.0 or later	Compatible	Compatible

9.1.1 Features of EtherCAT Fieldbus

The EtherCAT bus is the Ethernet-based fieldbus. The communication rate of the EtherCAT network is 100Mbps and the distance between two adjacent nodes is within 50 metres. The EtherCAT network is noticeably very different from the general Ethernet network. One EtherCAT network has just one EtherCAT master and EtherCAT slaves contain ESC chips (EtherCAT Slave Controller) specially used for processing EtherCAT communication data and inserting the data which slaves need to transmit to the master into the EtherCAT frame. The last EtherCAT slave in the network will return the data which have been handled to the master in chronological order. See the illustration of data transmission shown below.

Thanks to the ESC chips in slaves, the master can make a communication with all slaves in an EtherCAT data frame and thus the communication efficiency is enhanced.

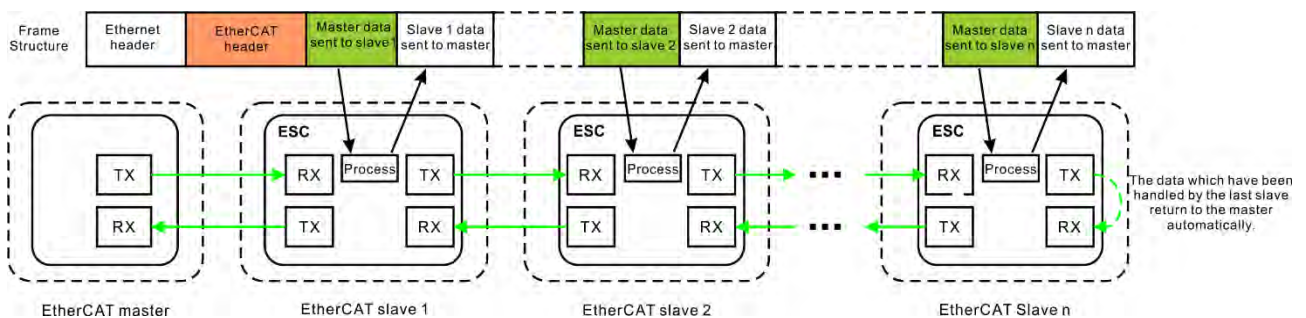

- **EtherCAT Communication between the Controller and Slaves**

Since the EtherCAT bus is the EtherNet-based fieldbus, the EtherCAT data frame still adopts the UDP/IP Ethernet data frame structure.

EtherCAT data field includes 2 bytes of EtherCAT data header and 44~1498 bytes of EtherCAT data. EtherCAT Data field consists of one or more EtherCAT datagrams. EtherCAT Data can be defined and analyzed in a protocol as long as the master and slaves comply with the protocol. Currently the mostly used two protocols are COE (CANopen Over EtherCAT) and SOE (Sercos Over EtherCAT). EtherCAT data frame structure is as displayed below.

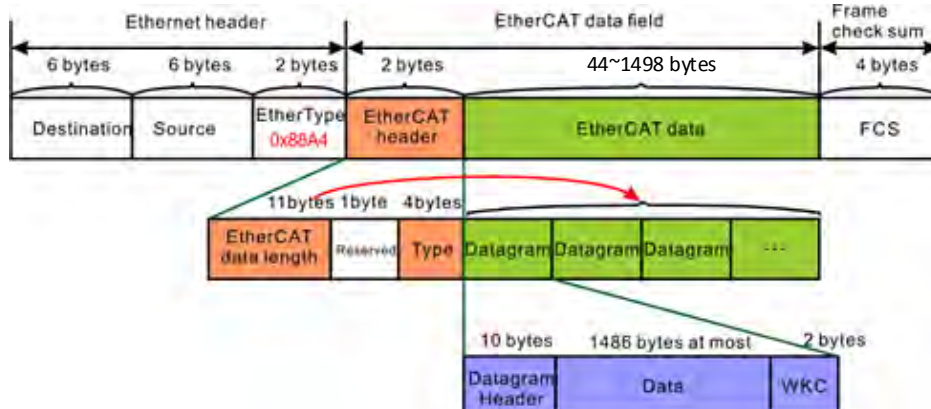

9.1.2 Settings up EtherCAT Master

This section introduces functions in the tab of AX_308_Series_EtherCAT_Master_SoftMotion. Refer to Chapter 6 for Network Configuration and how to create an EtherCAT connection.

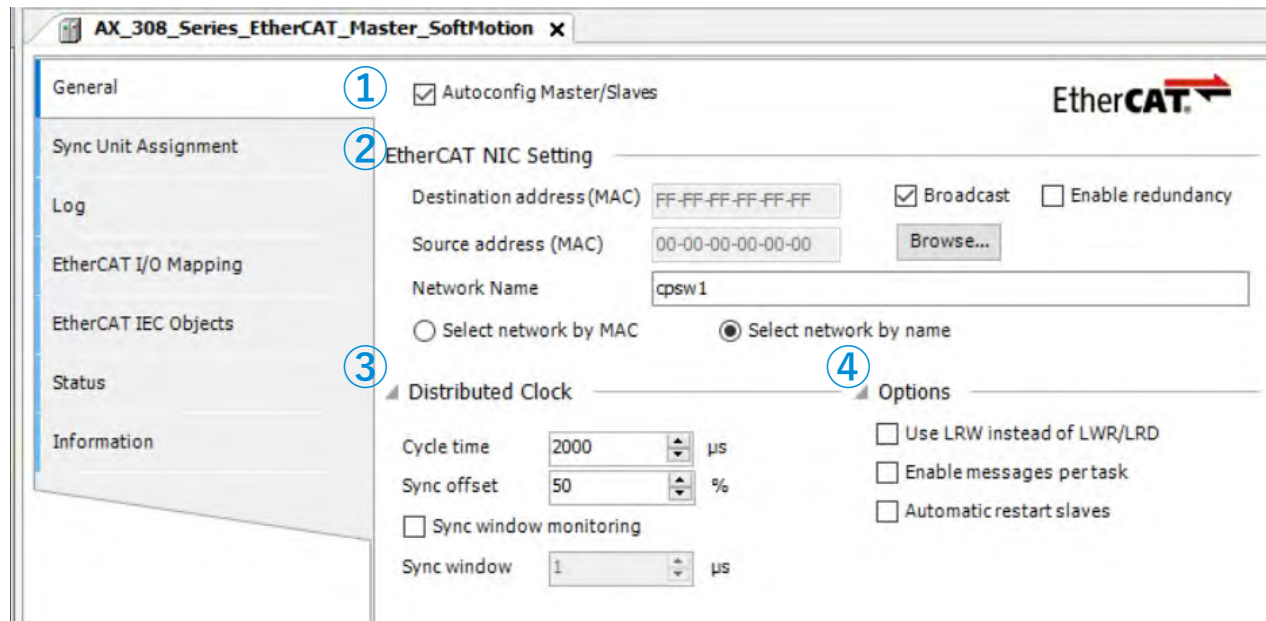

- **General**

- ① Autoconfig Master/Slaves: Enable this option to have basic configurations done. Suggested to use this option.

- ② EtherCAT NIC Setting

- Destination address (MAC): MAC address of the device in the EtherCAT network that is to receive the telegrams.
 - Source address (MAC): MAC address of the controller (Select CPSW1 when you use Browse... to find Slave)
 - Network Name: Name or MAC of the network, depending on which of the following options is activated:
 - Select Network by MAC: The network is specified by the MAC ID. (default: CPSW*1)
 - Select network by Name: Network is identified by the network name and the project is device-independent.

- ③ Distributed Clock

- Cycle time: Master sends out corresponding data to the Slaves in a cycle time specified here.
 - Sync offset: Parameter for setting the delay time between the Distributed Clock time base of the EtherCAT slave and the cycle start of the PLC. With the default value of 20%, the PLC cycle starts 20% of the bus cycle time after the sync interrupt of the slave. For the controller program, 80% of the cycle is always available. Here the Sync offset determines only when the EtherCAT data of the master is exchanged to and from the slaves relative to the time base of the EtherCAT slave.
 - Sync window monitoring: Enabled to monitor the synchronization of the slaves.
 - Sync window: Time for Sync window monitoring.

- ④ Options

- Use LRW instead of LWR/LRD: Use combined read/write commands/PDO (LRW) instead of separating read (LRD) and write commands (LWR).
 - Enabled messages per task: Read and write commands, i.e. the handling of the input and output messages, can be controlled with various tasks.
 - Automatic restart slaves: In the case of a communication breakdown, the master immediately attempts to restart the slaves.

- **Log**

Here you can view the PLC log. It lists the events that were recorded on the target system. Refer to section 4.2.1.5 Log for more information.

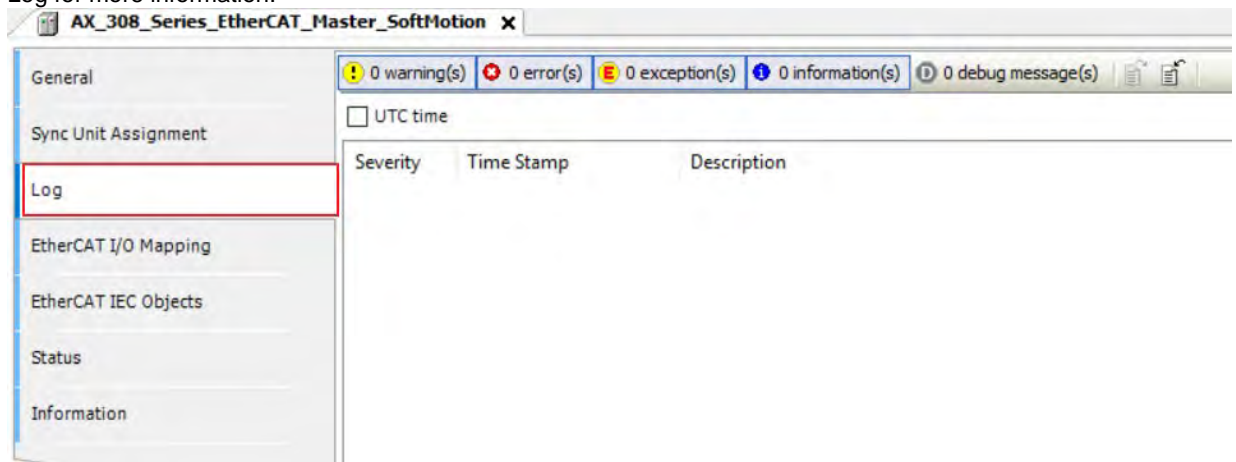

- **EtherCAT I/O Mapping**

Here you can select the bus cycle task for EtherCAT communication. The bus cycle task selected will be synchronized with the specified EtherCAT_Master cycle time.

- **Bus cycle task:** Select a bus cycle task to synchronize with the EtherCAT communication time. When the option "Use parent bus cycle setting is selected", the system use the shortest cycle time as the EtherCAT cycle time.

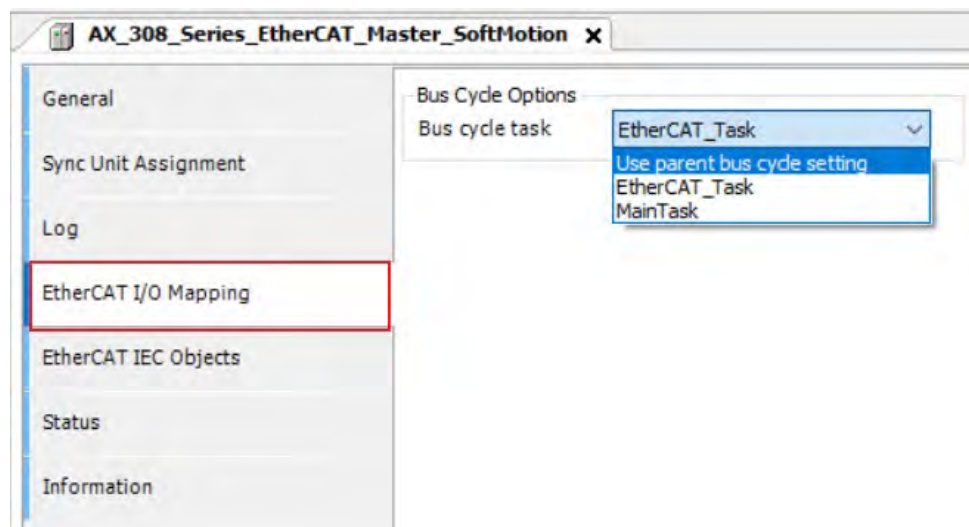

9.1.3 Setting up the EtherCAT Slave

This section introduces functions in the tab of Slaves. You can either scan the network to add the slaves in or add slaves from the Product list. Refer to section 6.1.3 for more information.

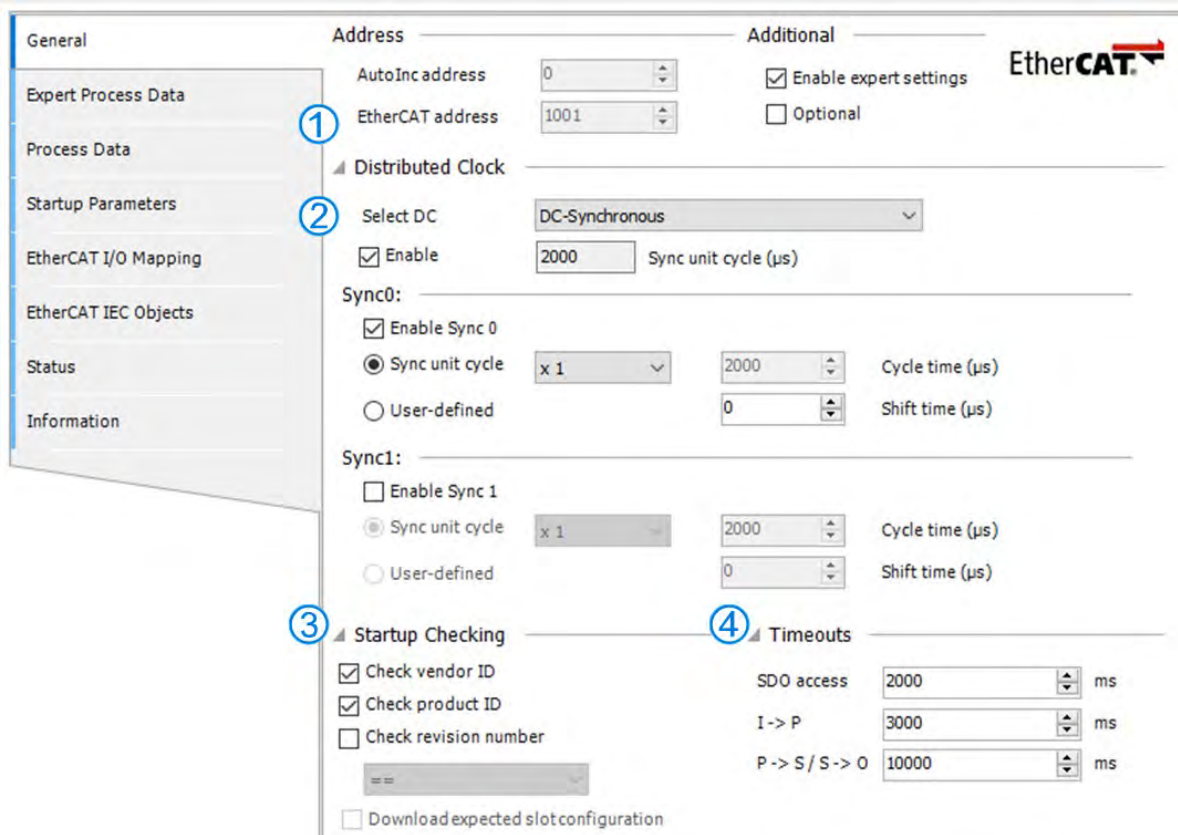

- **General**

- **Address**

- ① EtherCAT address: Final address of the slaves, assigned by the master during bootup. The address is independent of the position of the slave in the network.

- **Distributed Clocks**

- ② Select DC: Cycle time for the data exchange.
 - ③ Startup Checking

Function	Description
Check vendor ID	Once the system starts, it checks if the vendor ID and product ID are the same as the configured. If not, the system stops without any further operation.
Check product ID	
Check revision number	Once the system starts, it checks if the revision number is the same as the drop-down list showed.

- ④ Timeouts

Function	Description
SDO access	Once the system starts, the SDO also starts transmitting. Unit: ms
I -> P	Switching form Init mode to Pre operational mode. Unit: ms
P -> S / S -> O	Switching from Pre operational mode to Safe Operational mode. Or switching from Safe-Op mode to Operational modd. Unit: ms

- **Process Data**

The data mapping of the EtherCAT network is a cyclic data exchange between the master and slave through the CoE-based PDO mapping. The data that a slave sends to the master are packed in TxPDO and the data that the slave reads from the master are packed in RxPDO. The inputs and outputs on the pages of Select the Outputs and Select the Inputs contain the lists of PDOs which are available for data exchange and can be edited. For ESI file of a device, the PDOs and PDO contents for option have been defined and some PDO contents are allowed to be edited by users themselves as defined in ESI.

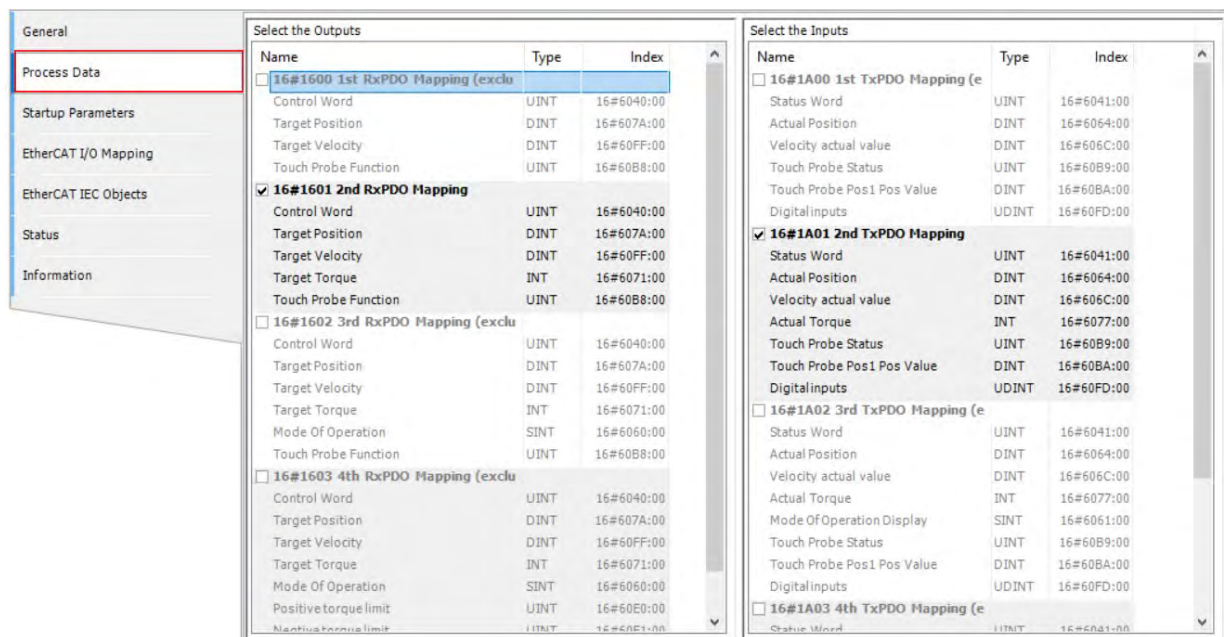

If outputs of the device are activated here (for writing), these outputs can be assigned to project variables in the EtherCAT I/O Mapping window. And if inputs of the device are activated here (for reading), these inputs can be assigned to project variables in the EtherCAT I/O Mapping window. It takes more PLC system resources, if you use more PDOs.

- **Startup Parameters**

The table shows the commands which have been defined by default in ESI file when the master will read and write values to the slave in the specific status of EtherCAT network operation. Users can add or reduce or modify commands in the table.

Function Button	Description
Add	By specifying new index/subindex entries, a new object can be added to the SDO that is not yet described in the EDS file. This is useful if only an incomplete object directory or none at all is present.
Edit	In this window you can change the parameters of the SDO before the SDO is added to the configuration.
Move Up	Moves the selected line upwards by one line
Move Down	Moves the selected line downwards by one line

Line	Index:Subindex	Name	Value	Bit Length	Abort on Error	Jump to Line on Error	Next Line	Comment
1	16#0000:16#00	16#0000:16#00	0	8	<input type="checkbox"/>	<input type="checkbox"/>	0	
2	16#6060:16#00	Op mode	8	8	<input type="checkbox"/>	<input type="checkbox"/>	0	Op mode
3	16#2119:16#00	DRV's Parameter P1-25	0	16	<input type="checkbox"/>	<input type="checkbox"/>	0	
4	16#1603:16#00	4th Receive PDO Mapping	0	8	<input type="checkbox"/>	<input type="checkbox"/>	0	
5	16#1A02:16#00	3rd Transmit PDO Mapping	0	8	<input type="checkbox"/>	<input type="checkbox"/>	0	
6	16#2104:16#00	DRV's Parameter P1-04	0	16	<input type="checkbox"/>	<input type="checkbox"/>	0	
7	16#2006:16#00	DRV's Parameter P0-06	0	32	<input type="checkbox"/>	<input type="checkbox"/>	0	Interpolati
8	16#6098:16#00	Homing method	35	32	<input type="checkbox"/>	<input type="checkbox"/>	0	
9	16#60C2:16#01	Interpolation time period	2	8	<input type="checkbox"/>	<input type="checkbox"/>	0	Interpolati
10	16#609A:16#00	Homing acceleration	100	32	<input type="checkbox"/>	<input type="checkbox"/>	0	
11	16#6099:16#01	Speed during search for switch	100	32	<input type="checkbox"/>	<input type="checkbox"/>	0	
12	16#1C13:16#00	TxPDO assign	0	8	<input type="checkbox"/>	<input type="checkbox"/>	0	
13	16#6099:16#02	Speed during search for zero	20	32	<input type="checkbox"/>	<input type="checkbox"/>	0	

Click **Add** button to open the **Select Item Object Directory** window. And select the parameter that you'd like to add and then click **OK** to add the item in.

Select Item from Object Directory

Index:Subindex	Name	Flags	Type	Default
16#1A01:16#00	2nd Transmit PDO Mapping			
16#1A02:16#00	3rd Transmit PDO Mapping			
16#1A03:16#00	4th Transmit PDO Mapping			
16#1C12:16#00	RxPDO assign			
16#1C13:16#00	TxPDO assign			
16#1C32:16#00	SM output parameter			
16#1C33:16#00	SM input parameter			
16#2001:16#00	DRV's Parameter P0-01	RW	UINT	
16#2002:16#00	DRV's Parameter P0-02	RW	UINT	
16#2003:16#00	DRV's Parameter P0-03	RW	UINT	
16#2004:16#00	DRV's Parameter P0-04	RW	UDINT	
16#2005:16#00	DRV's Parameter P0-05	RW	UDINT	
16#2006:16#00	DRV's Parameter P0-06	RW	UDINT	
16#2007:16#00	DRV's Parameter P0-07	RW	UDINT	
16#2011:16#00	DRV's Parameter P0-17	RW	UINT	
16#2012:16#00	DRV's Parameter P0-18	RW	UINT	

Name:

Index: 16# Bit length:

SubIndex: 16# Value:

Byte array

9.1.4 Backup Parameters for EtherCAT Slaves

While using EtherCAT communication, we provide custom parameter storage feature for ASDA series servo drives with the backup feature to backup and recover parameters of all slave stations.

9.1.4.1 Data Backup Procedure

- Backup procedure

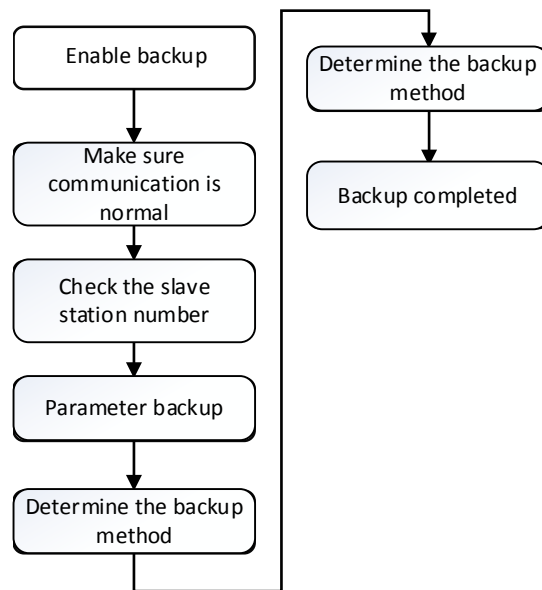

- Recover procedure

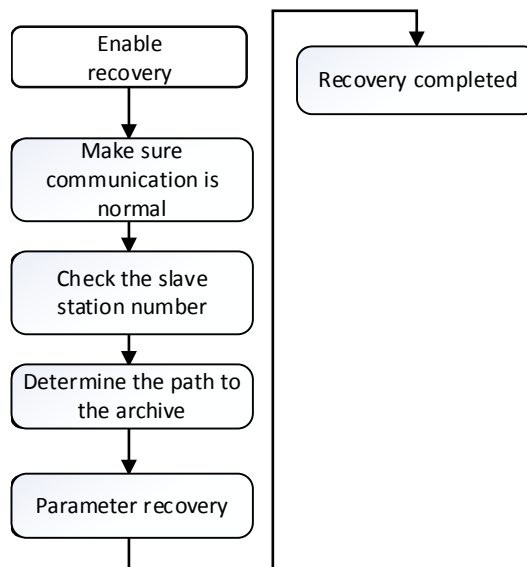

***Note:** If there's any existing axis error while executing parameter backup or recovery, the corresponding slave station would be skipped in the backup/ recovery procedure. After the backup/ recovery of all the rest of slave stations are completed, all the related messages of axis errors would be displayed.

9.1.4.2 Introduction to Backup and Restore

- Supported version for backup and recovery
 - AX-3 series firmware version: V1.0.2.0 and above
 - DIADesigner-AX version: V1.2 and above
 - Only models ASDA-A3-E and ASDA-B3-E are supported for parameter backup and recovery.
 - ◆ ASDA-A3-E firmware version: V11165 sub 92 and above
 - ◆ ASDA-B3-E firmware version: V10665 sub 75 and above
- Data that is backed up

Servo parameters P0~P4 (Not including P0.001 and P4.000), P5.0003, P5.0008~P5.0009, P5.0020~P5.0030 and P6.0000~P6.0001.
- Enter the parameter backup page
 - Method 1

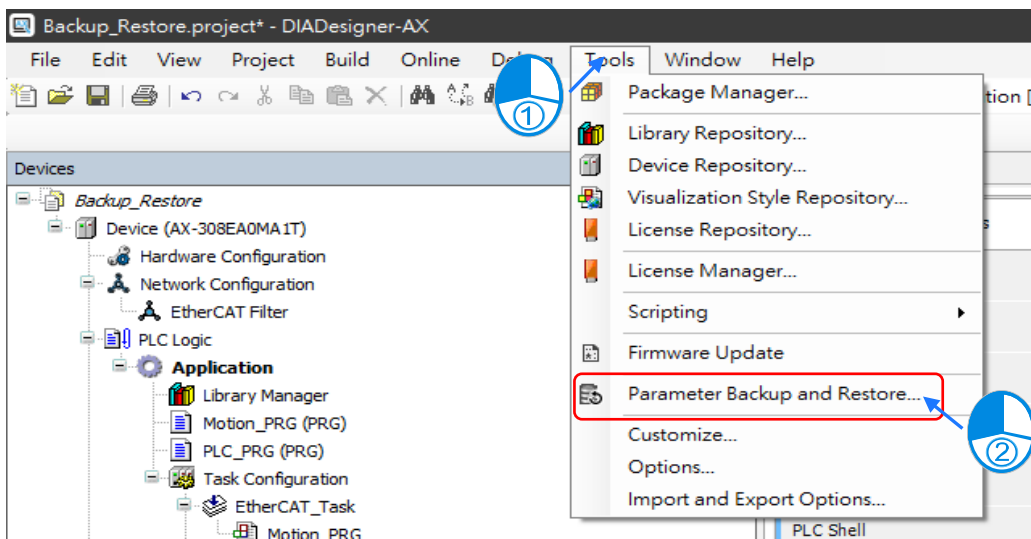

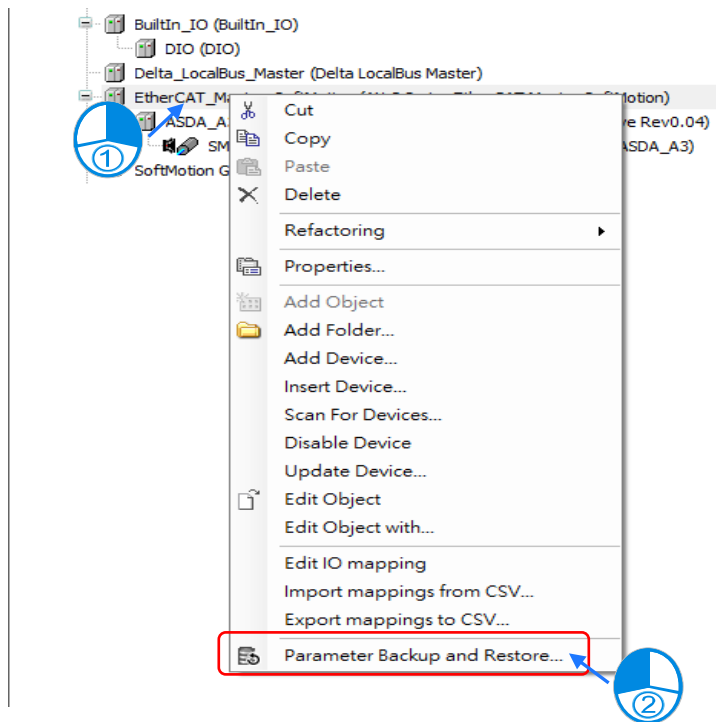

***Note:** By using this method, the option “Current Project” would not able to be chosen for the setting of “Generate Target Device List from”.

Method 2

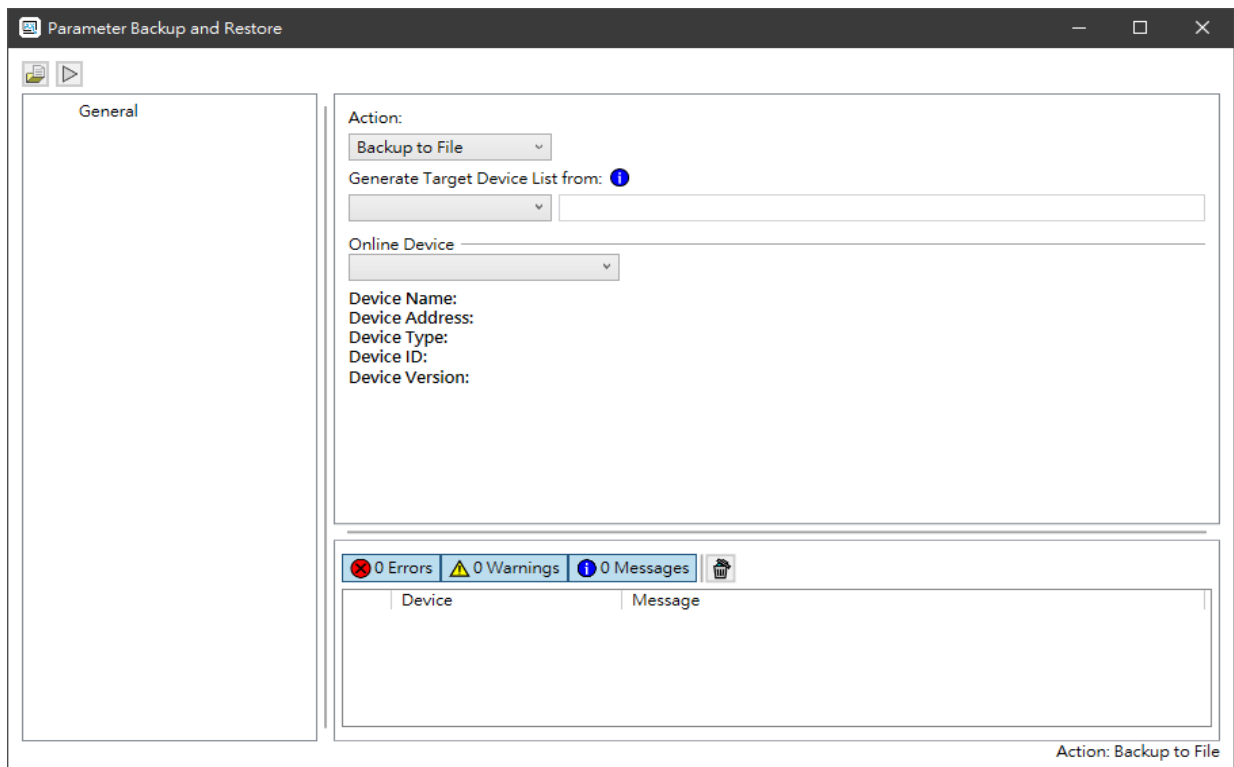

- Enter the Parameter Backup and Restore page



Name	Function
Online Device	Select the target device to connect.
Generate Target Device List from	Select EtherCAT project tree - Archive File → EtherCAT topology file - Current Project → EtherCAT topology in the current project - Online Topology → Online EtherCAT topology
Action	Select the target action - Backup to File → Backup parameters to files. - Backup to SD Card → Backup parameters to external SD cards. - Restore from File → Restore parameters from files. - Restore from SD Card → Restore parameters from SD cards.
	Save the current EtherCAT topology (Archive File)
	Execute the backup/ restore feature.

- External SD card backup path

External SD card path: /PLC CARD/AX_/SysDup/ECAT/BackupRestore/ (The “_” in the path represents model types. For example, model AX-3 would be defined as AX3 here.)

9.1.4.2.1 Operation for the Backup Function

- Parameter backup

- ① Select Device.
- ② Configure EtherCAT topology for the current project.
- ③ Set Action to “Backup to File”.
- ④ Execute backup.

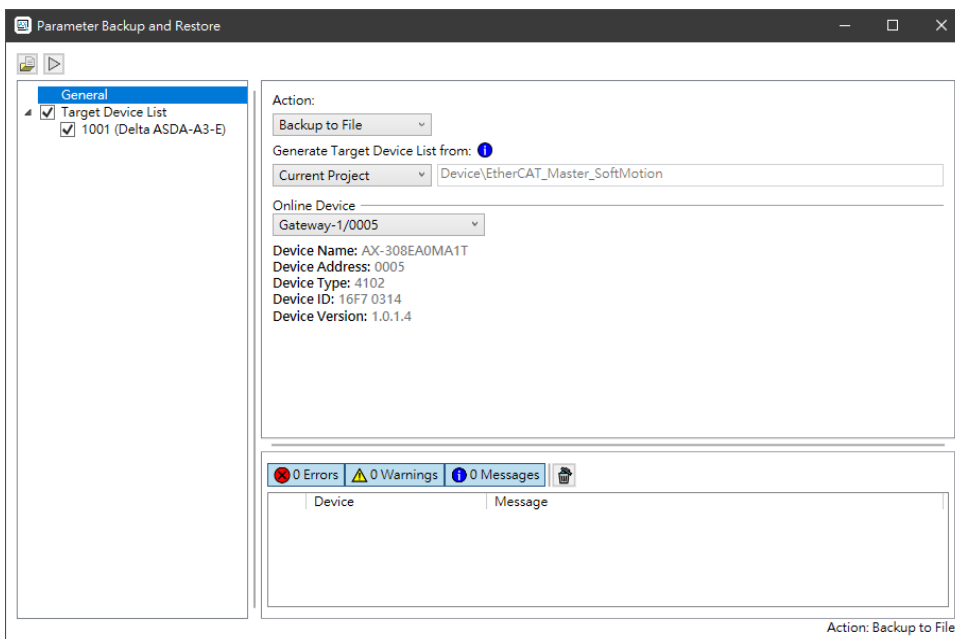

- Change the PLC state to Stop.

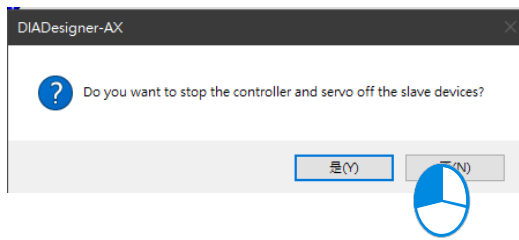

- Click "Close" after the parameter backup is complete.

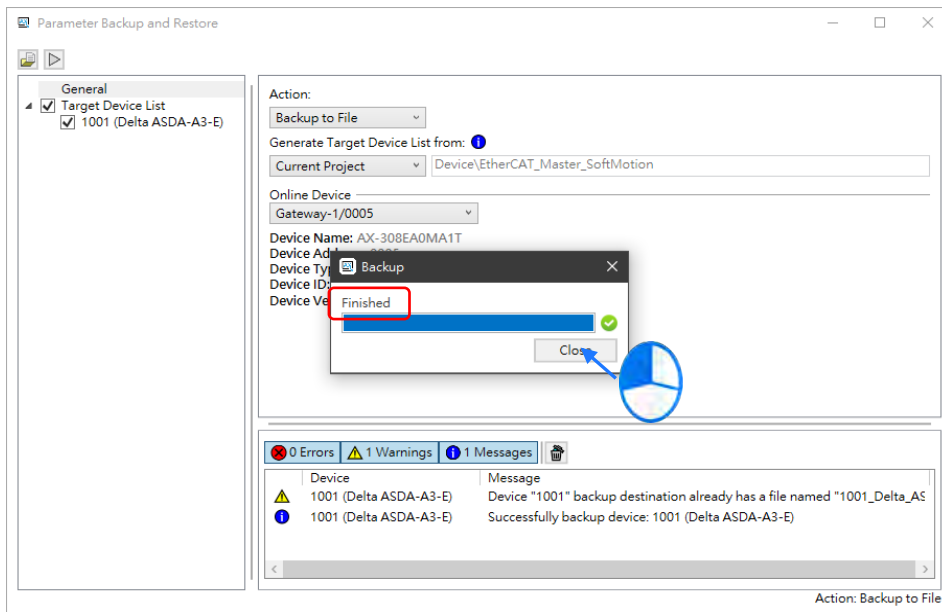

- Backup directory

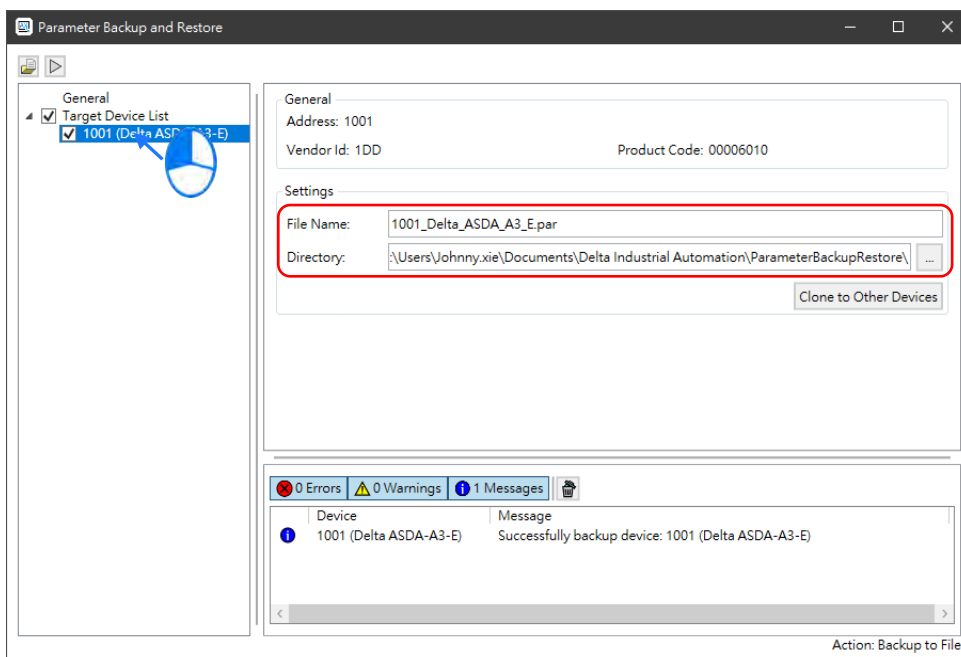

Name	Function
File Name	Set the name for parameter backup file.
Directory	Set the backup directory.
Clone to Other Devices	Change all the backup directory of other devices.

9.1.4.2.2 Operation for the Restore Function

- Parameter restoration
 - ① Select Device.
 - ② Configure EtherCAT topology for the current project.
 - ③ Set Action to "Backup to File".

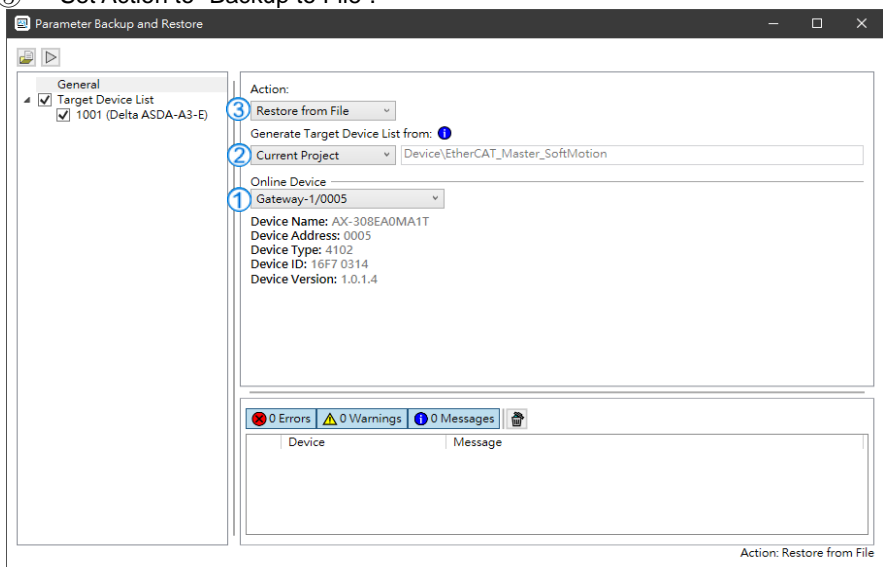

- Click on the target device and set the path to the file to restore.

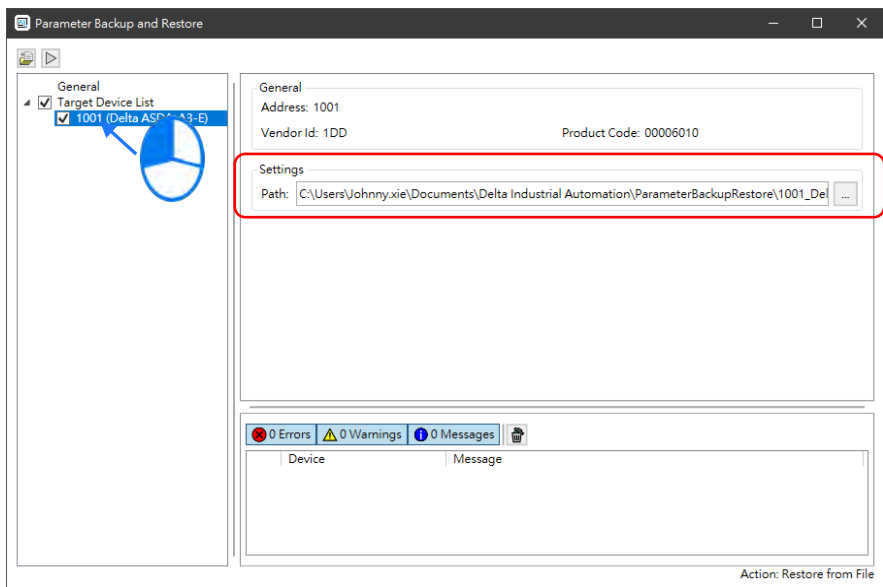

- Activate the restore function.

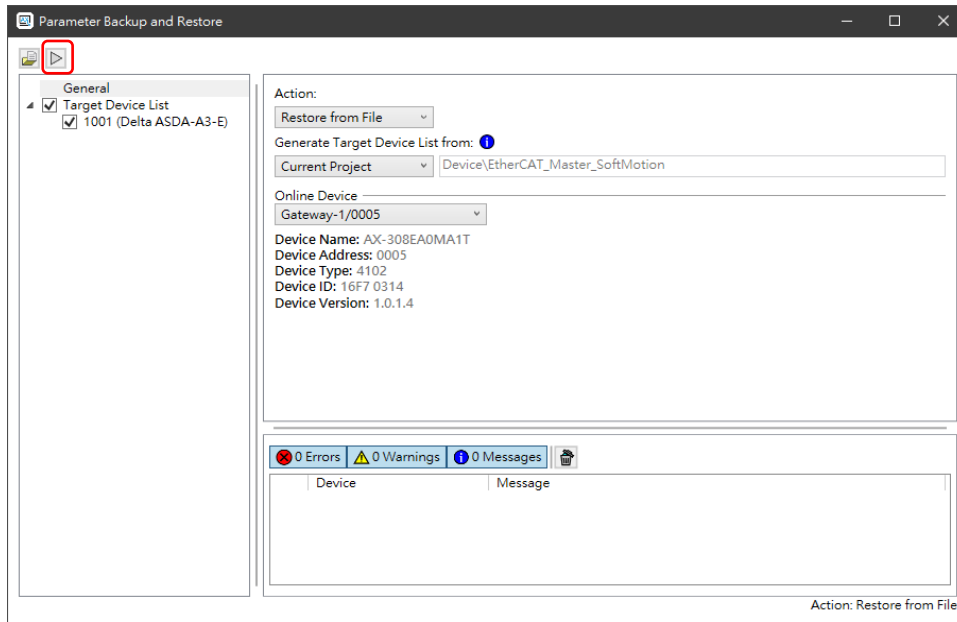

- Change the PLC state to Stop.

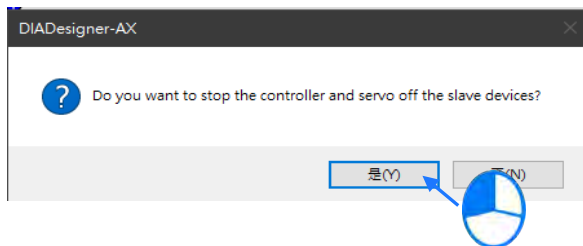

- Click Yes after the restoration is complete, then reboot the device.

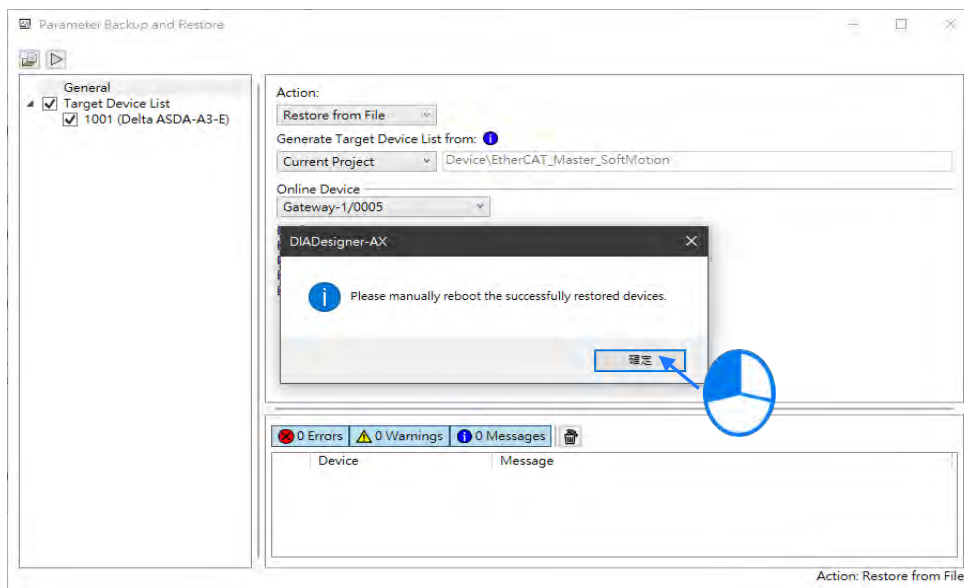

9.2 Introduction to Modbus Serial Communication

9.2.1 Modbus Serial Port

DIADesigner-AX supports the following Modbus network types, including one RS-232 and one RS-485. Each Modbus Serial Port allows one master. A maximum of 32 slaves can be attached to a master. But since RS-232 has no multipoint capability, only point-to-point connection is possible. And only the FIRST slave can communicate with the master. Since RS-485 has multipoint capability, RS-485 does NOT have such limitations. Follow the below section to set up the basic settings for communication via the serial port for the Modbus serial port.

9.2.1.1 Adding Delta Modbus COM

1. Right-click the PLC in the tree view to open up a context menu. And click **Add Device...** to open the Add Device setting window.

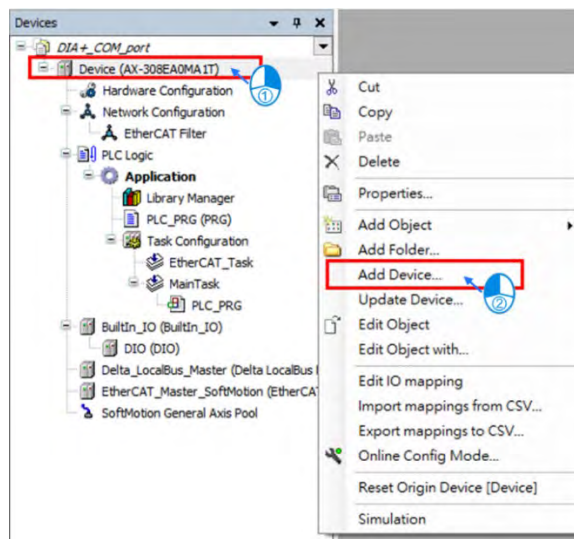

2. Find **Delta Modbus COM** (Fieldbuses -> Modbus -> Modbus Serial Port -> Delta Modbus COM) and then double-click it or click **Add Device** to add this port in.

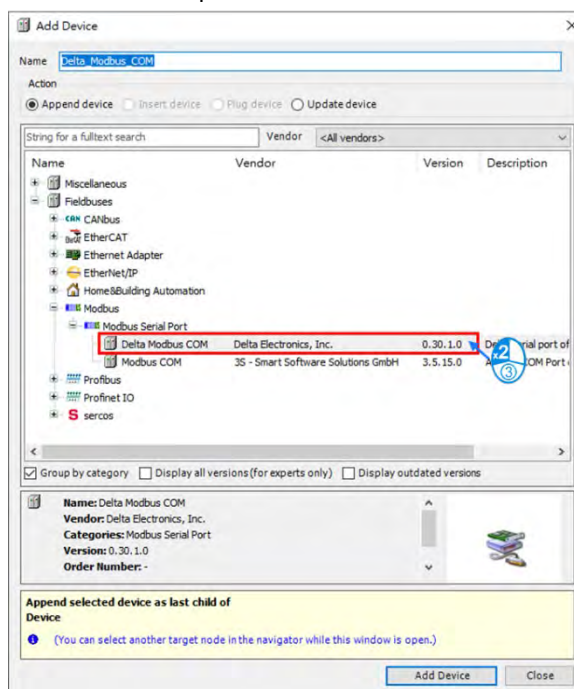

- Find the added port **Delta_Modbus_COM (Delta Modbus COM)** in the tree view and double-click it to open the setting window to set up.

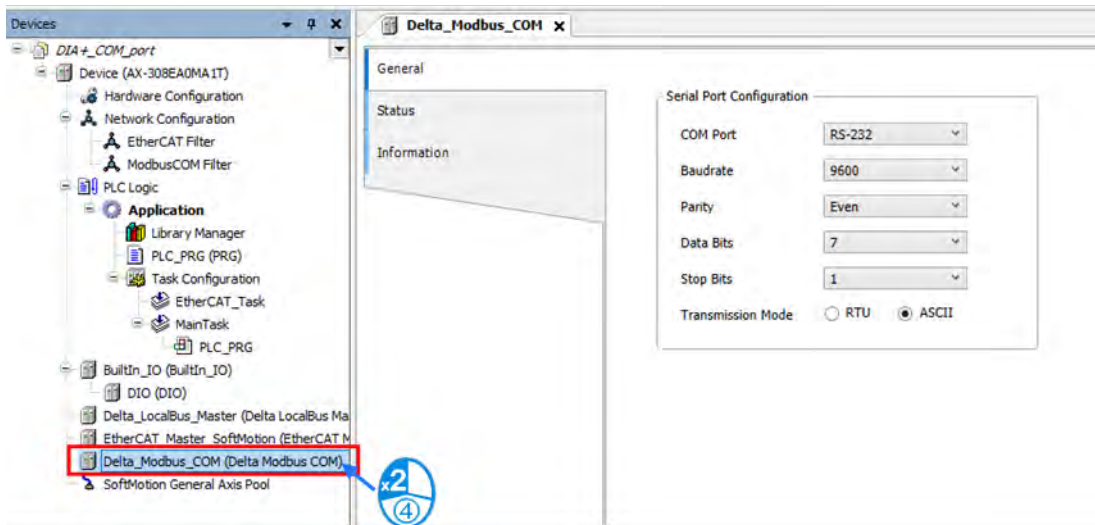

9.2.1.2 Setting up Delta Modbus COM

■ General

Here you can configure Serial Port Parameters. Settings include COM Port (RS-232 /RS-485), Baudrate, Parity, Data Bits, Stop Bits and Transmission Mode can be set here.

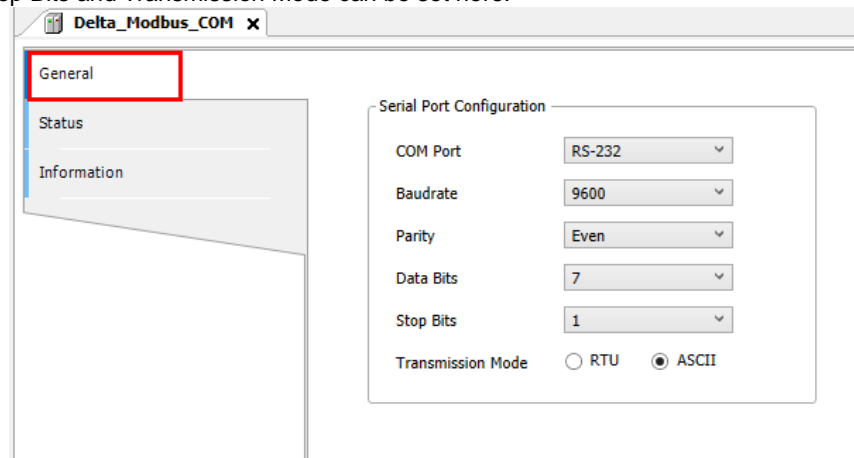

Item	Description
COM Port	Communication interface: RS-232/RS-485
Baudrate	The communications speed in bits per second (bps): 9600/19200/38400/57600/115200
Parity	None/Odd/Event
Data Bits	7/8 (when the transmission mode is RTU, you need to set the data bits to 8)
Stop Bits	1 bit/2bits
Transmission Mode	RTU/ASCII

■ **Status**

Here you can find the device status information, for example 'Running' or 'Stopped', and specific diagnostic messages from the respective device, also information about the card used and the internal bus system.

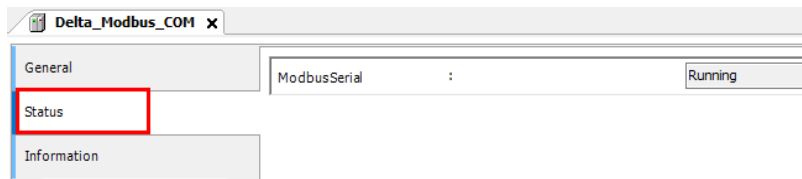

Item	Description
Modbus Serial	The status of Modbus Serial Communication

■ **Information**

Here you can find general information that originates from the device description file: name, vendor, categories, version, order number, description, and other relevant information.

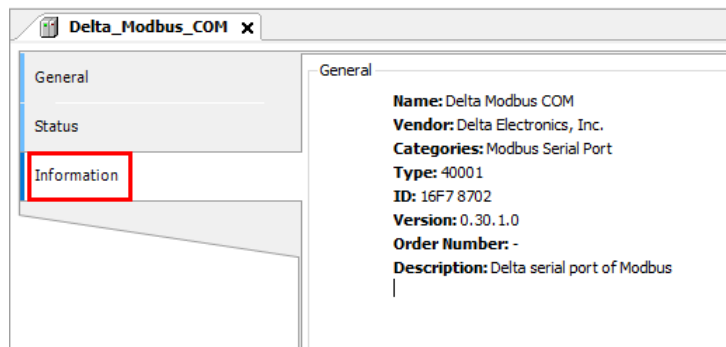

9.2.2 Modbus Serial Master

AX-3 Series PLC can act as a Modbus Serial Master, after you have created Modbus Master COM port and Modbus Slave COM port. Follow the below section to set up the Modbus Serial Master.

9.2.2.1 Adding Delta Modbus Master/Slave COM

1. Right-click the created Delta_Modbus_COM (Delta Modbus COM) in the tree view to open up a context menu. And click **Add Device...** to open the Add Device setting window.

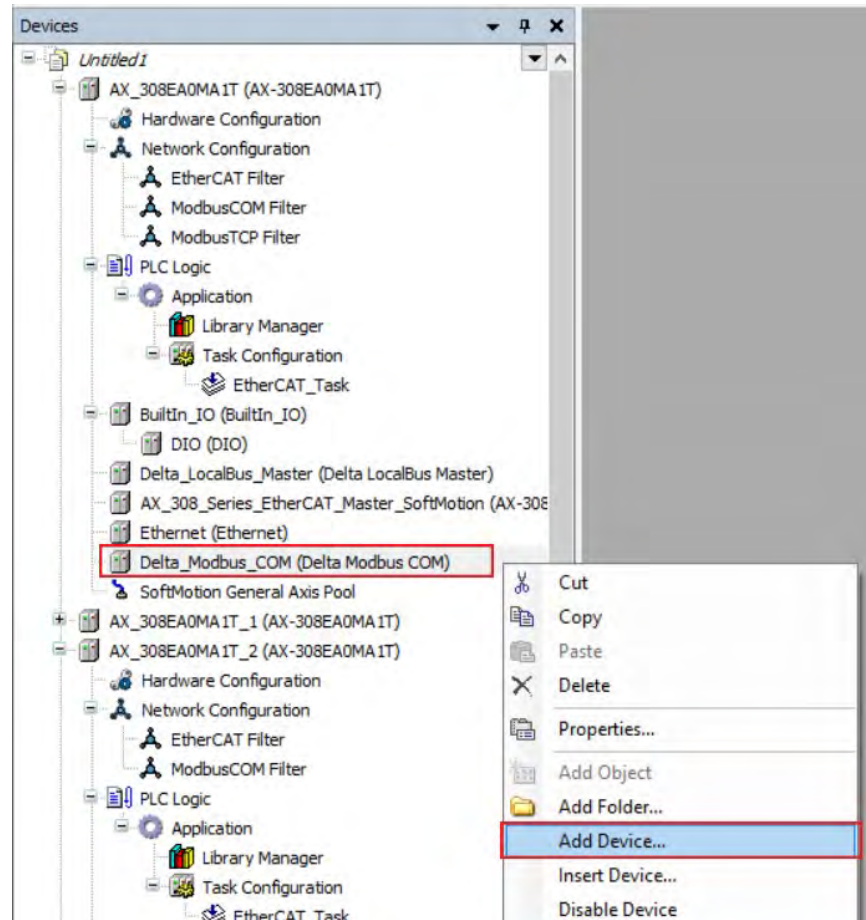

- Find and double-click **Delta Modbus Master COM Port** (Fieldbuses -> Modbus -> Modbus Serial Master -> Delta Modbus Master COM Port) or click **Add Device** to add this port in. You can only add one Master COM Port. After you added one master, the other added devices are slave ports: Delta_Modbus_Master_COM_Port, the Delta_Modbus_Slave_COM_Port.

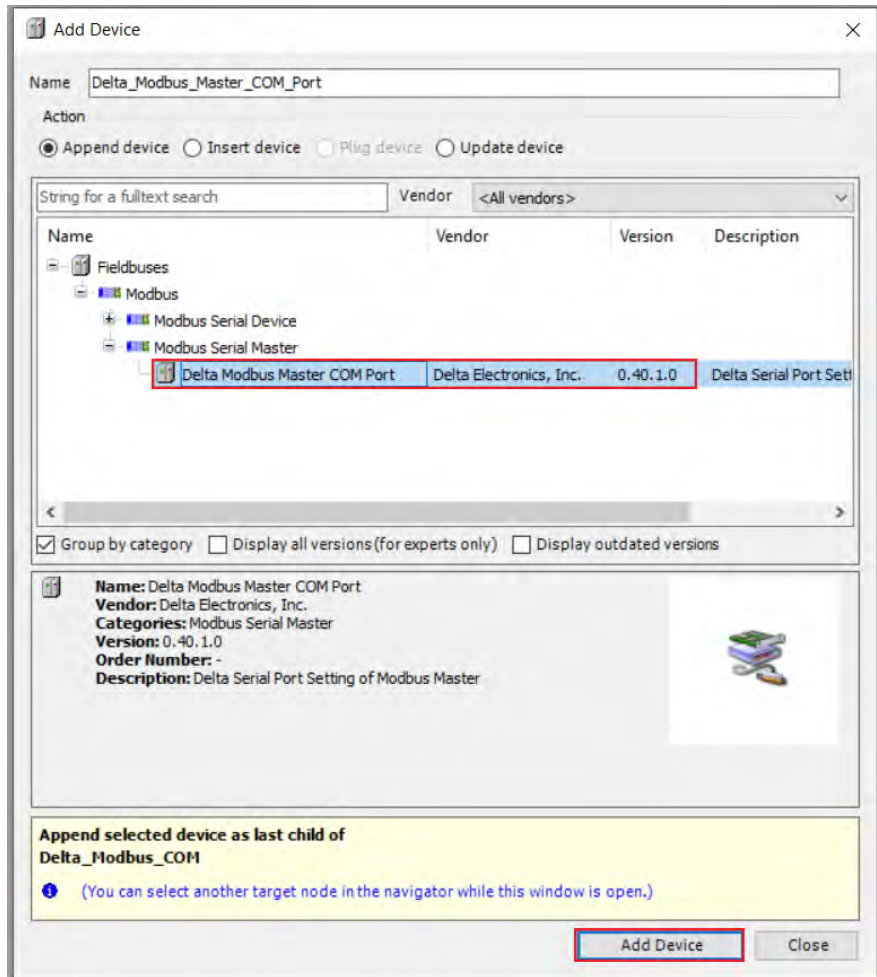

- Find the added port **Delta_Modbus_Master_COM_Port** (Delta Modbus Master COM Port) in the tree view and double-click it to open the setting window to set up.

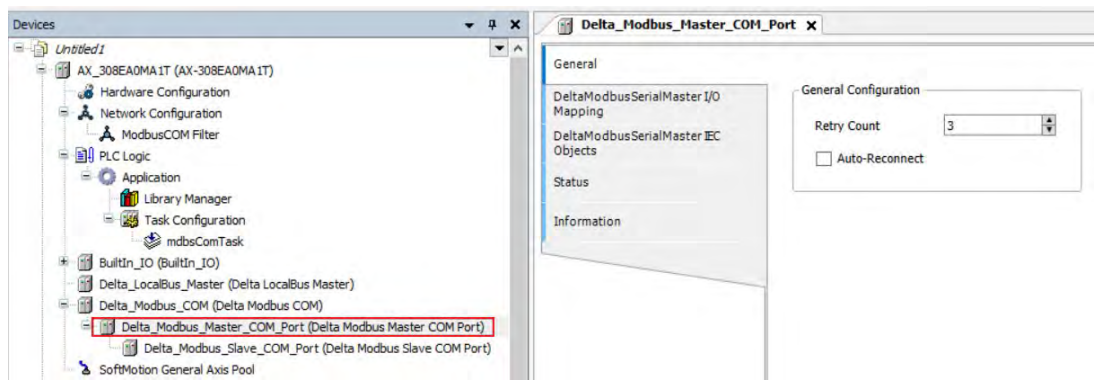

9.2.2.2 Setting up Delta Modbus Master COM

■ General

Here you can configure the basic settings for Modbus Serial Master.

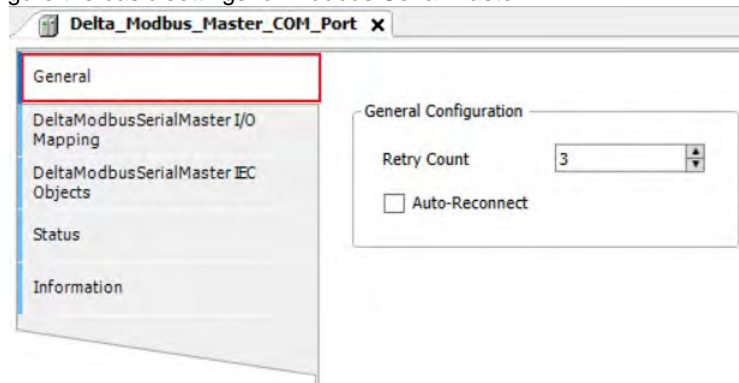

Item	Description
Retry Count	Set up the number of times for the COM port to reconnect if the connection is lost.
Auto-Reconnect	Enable this option to have this port to reconnect automatically if an error occurs or connection timeout occurs.

■ Delta Modbus Serial Master I/O Mapping

Bus cycle task: Select a bus cycle task to synchronize with the Modbus communication time. When the option "Use parent bus cycle setting is selected", the system use the shortest cycle time as the bus cycle time. Refer to section 4.2.1.6 PLC Settings for more information.

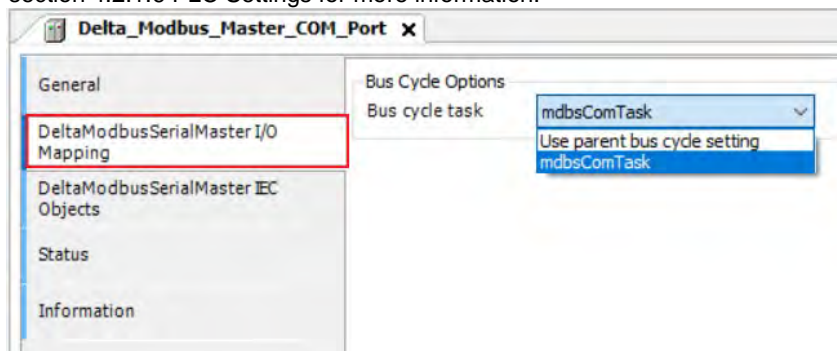

Delta Modbus Serial Master IEC Objects

Here is the correspondings of the DFB_ModbusCOMMaster function block. You can check the status of Modbus Serial Master under this tab.

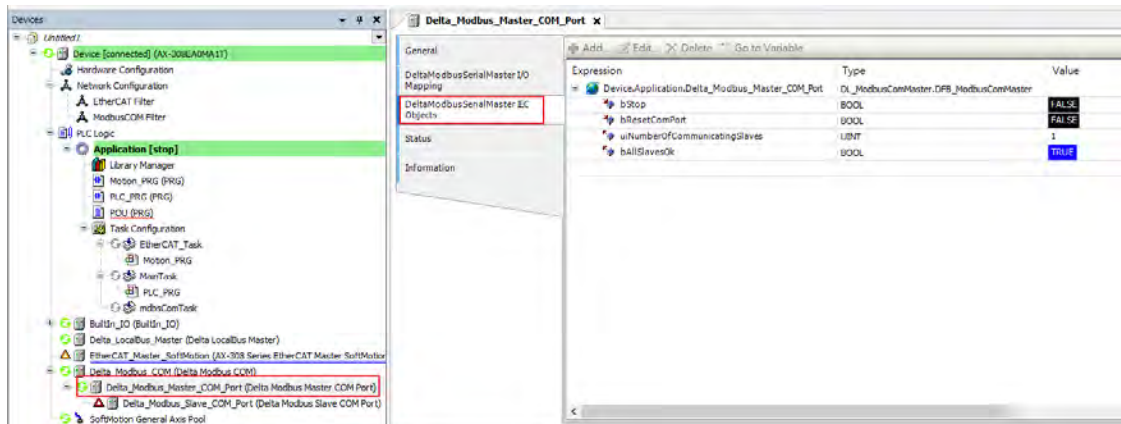

Expression	Description
bStop	Stop sending the Slave any new request
bResetComPort	Reset the COM port
uiNumberOfCommunicatingSlaves	The number of the Slaves that are in communication
bAllSlavesOk	The communication status of the Slave

Status

Here you can find the device status information, for example 'Running' or 'Stopped', and specific diagnostic messages from the respective device, also information about the card used and the internal bus system.

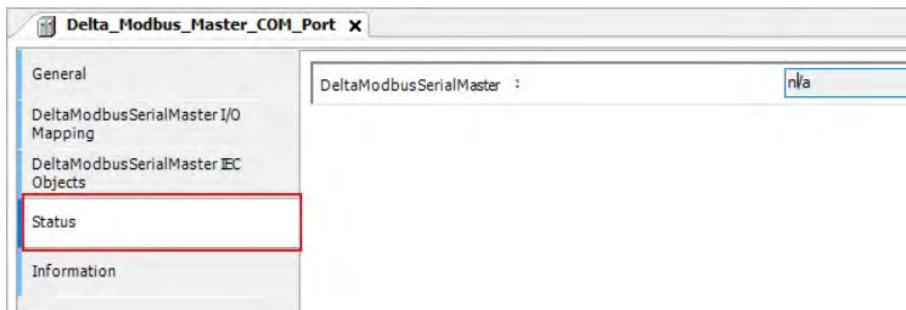

Information

Here you can find general information that originates from the device description file: name, vendor, categories, version, order number, description, and other relevant information.

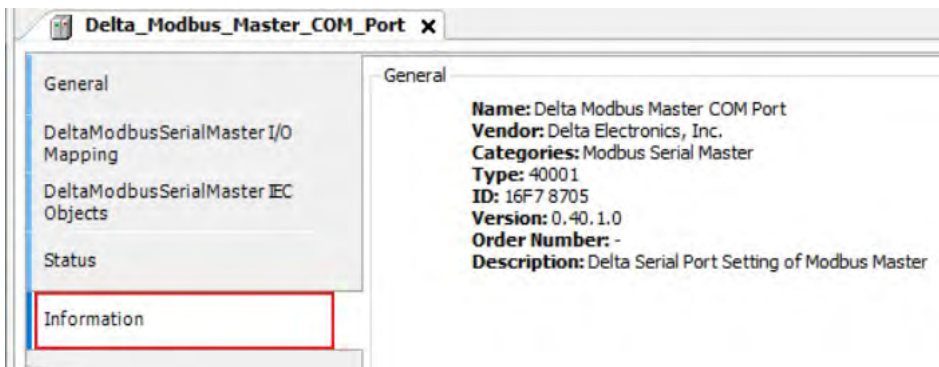

9.2.2.3 Setting up Delta Modbus Slave COM

In the tree view, find the added port **Delta_Modbus_Slave_COM_Port (Delta Modbus Slave COM Port)**. Double-click it to open the setting window to set up.

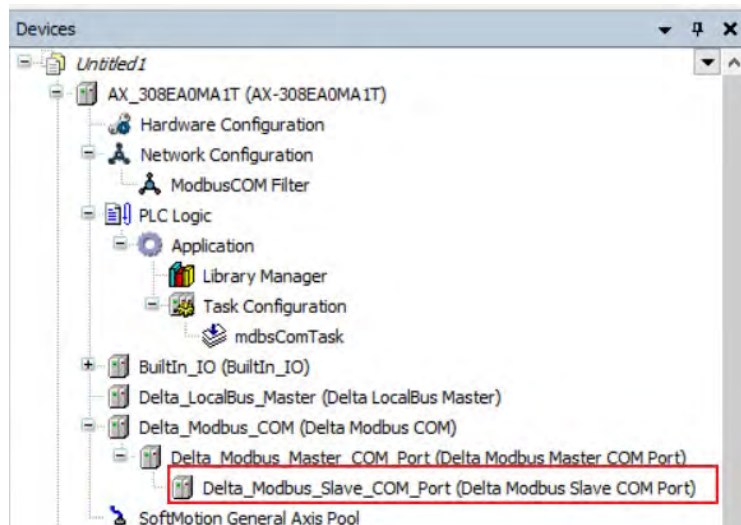

■ General

Here you can configure the basic settings for Modbus Serial Slave, such as Slave Address, Response Timeout and Device Type.

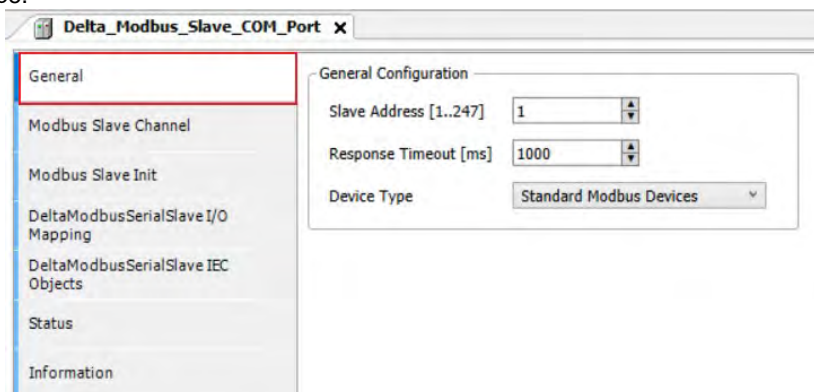

Item	Description
Slave Address	Address of a serial Modbus device (value between 1 and 247)
Response Timeout	Time interval for the master to wait for the response from the slave. This is especially configured for this slave node and overwrites the general response timeout setting of the respective master.
Device Type	You can select standard Modbus devices or Delta devices. If you select Delta devices, the system converts the protocol used into Modbus protocol automatically so that you do NOT need to refer to the register map for the conversion.

Modbus Slave Channel

Here you can define slave channels. Each channel represents a single Modbus request. You can create up to 10 channels for each slave. AX-3 Series PLC will send out Modbus request packets in chronological order. All channels share the same Modbus connection.

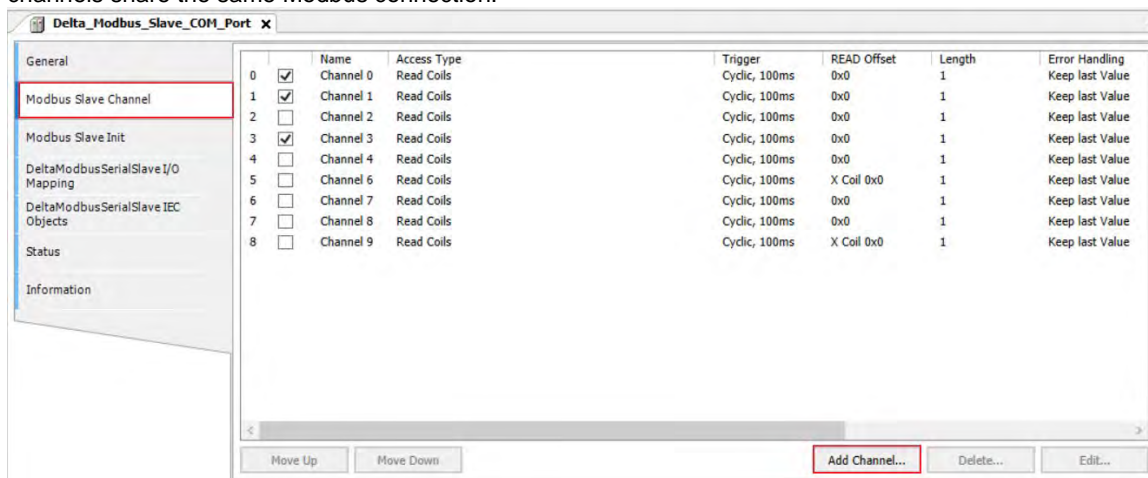

Click **Add Channel**, you can edit the channel before adding it in. The **Device Address** shows the Modbus protocol address whether the device type you selected is **Standard Modbus Device** or **Delta Devices** under the **General** tap. Since the system converts the protocol used into Modbus protocol automatically, you do NOT need to refer to the register map for the conversion.

Device Type : Standard Modbus Device

Device Type : Delta AH Series

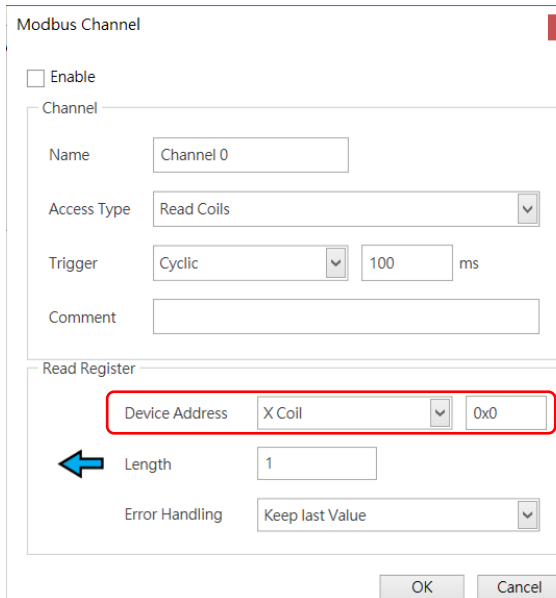
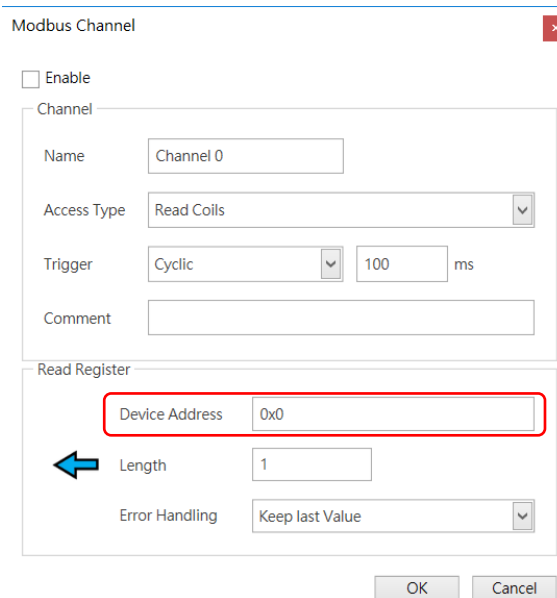

Item	Description	
Device Type	Standard Modbus Device	Delta Series Device
Enable	Activates this channel	
Name	Defines this channel name	
Access Type	Modbus function code <ul style="list-style-type: none"> ● Read coils (0x01) ● Read discrete inputs (0x02) ● Read holding registers (0x03) ● Read input registers (0x04) ● Read single coil (0x05) ● Write single register (0x06) ● Write multiple coils (0x0F) ● Write multiple registers (0x10) ● Read/Write multiple registers (0x17) 	Read/Write Registers <ul style="list-style-type: none"> ● Read coils ● Read registers ● Write coils ● Write registers <p>Note: PLC uses the corresponding Modbus function code according to the read/write register of the device type.</p>
Trigger	<ul style="list-style-type: none"> ● Cyclic: The request occurs periodically. ● Rising edge: The request occurs as a reaction to a rising edge of the Boolean trigger variables. The trigger variable is defined in the tab I/O Mapping. ● Application: The Modbus request is triggered by DFB_ModbusComChannel 	<ul style="list-style-type: none"> ● Cyclic: The request occurs periodically. ● Rising edge: The request occurs as a reaction to a rising edge of the Boolean trigger variables. The trigger variable is defined in the tab I/O Mapping. ● Application: The Modbus request is triggered by DFB_ModbusComChannel
Comment	Description of the channel	
Device Address	Modbus protocol address	Delta register address (will be converted into Modbus protocol in the background)
Length	Number of the register to be read/written to. (up to 100 coils and 100 registers)	Number of the register to be read/written to. (up to 256 coils and 100 registers)
Error Handling	What to do with the data in case of a communication error: <ul style="list-style-type: none"> ● Set To ZERO ● Keep last value 	

Modbus Slave Init

After the Modbus connection between AX-3 Series PLC and the slaves is established, you can use **Add Channel** button to edit the Initialization Value of the Coil/Register.

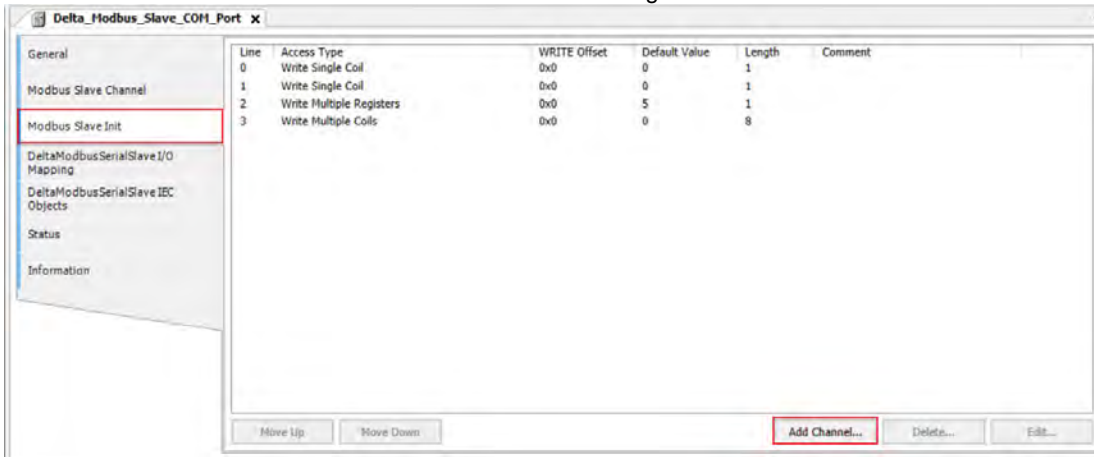

Click **Add Channel**, you can edit the Access Type, Device Address, Length, Initialization Value and Comment. Click OK to confirm the settings.

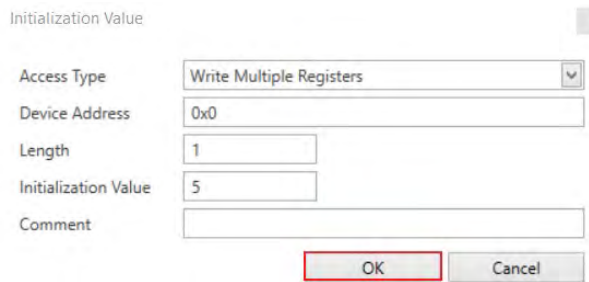

Modbus Generic Serial Slave I/O Mapping

After you have added channels under the tab of Modbus Slave Channel, you can find the variables and the set access types under this tab. Here you can define the variables for mapping. The descriptions here reflect what you have set for the **Access Type** in Modbus Slave Channel tab. When the **Trigger type** is set to **Rising edge** in Modbus Slave Channel, the description here adds one more condition, **Trigger variable**.

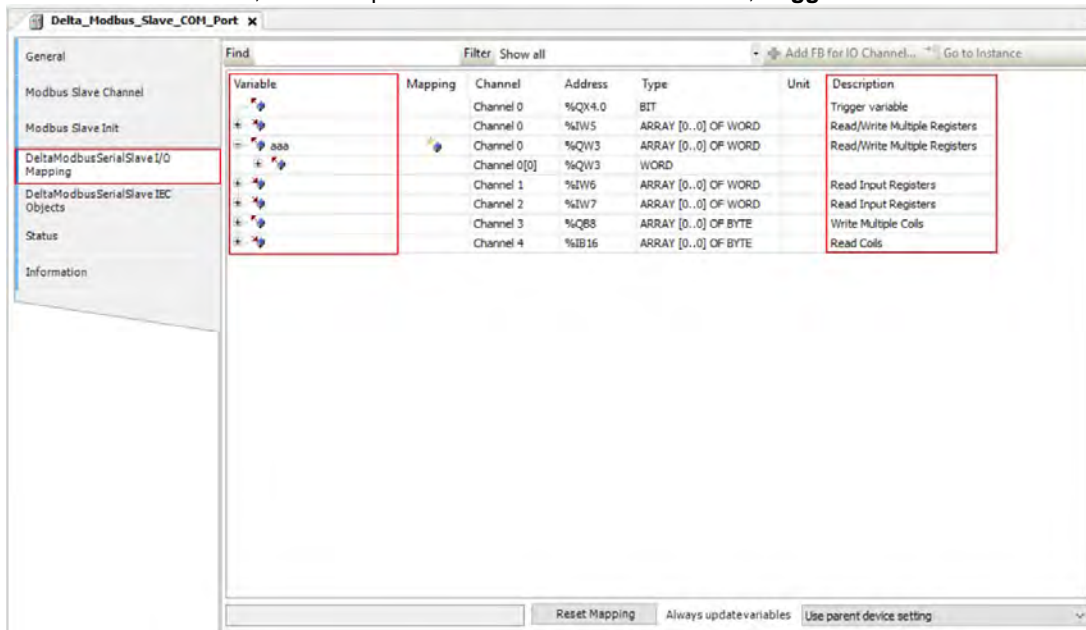

■ Delta Modbus Serial Slave IEC Objects

Here is the correspondings of the DFB_ModbusCOMMaster function block. You can check the status of Modbus Serial Slave under this tab.

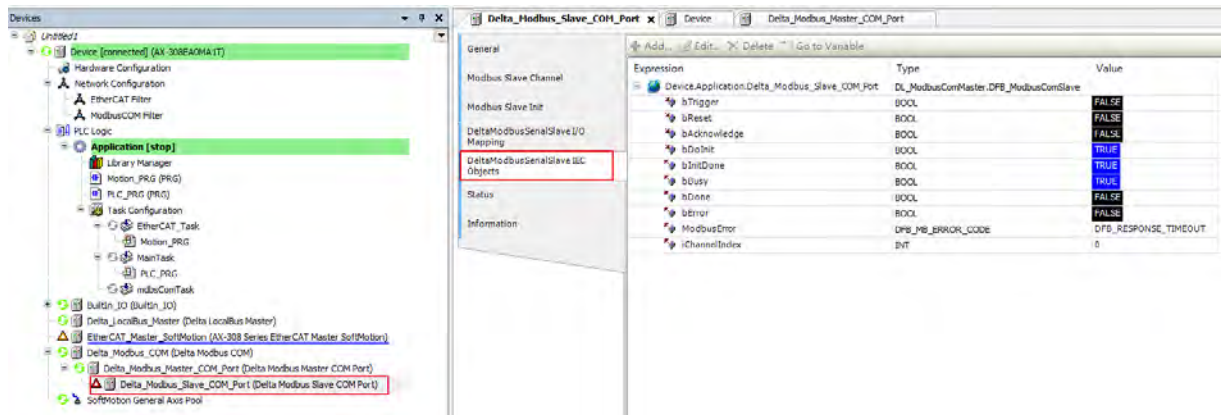

Expression	Description
bTrigger	Trigger all Modbus channels at one time.
bReset	Re-establish the connection and reset bError and ModbusError when the connection status shows error. And this function is only available when the option “Auto-Reconnect” is NOT enabled.
bAcknowledge	Re-establish the connection and the Modbus channel that showed error previously continues to execute the data transmission. And this function is only available when the option “Auto-Reconnect” is NOT enabled.
bDoInit	Initialized the Slave
bInitDone	The initialization of the Slave is complete.
bBusy	This channel is in data transmission.
bDone	The data transmission via this channle is complete.
bError	Error occurs when this channels is in data transmission.
ModbusError	Record of the Modbus error
iChannelIndex	The number of the channel that is in execution.

■ Status

Here you can find the Modbus Slave COM Port status information, for example ‘Running’ or ‘Stopped’, and specific diagnostic messages from the respective device, also information about the card used and the internal bus system.

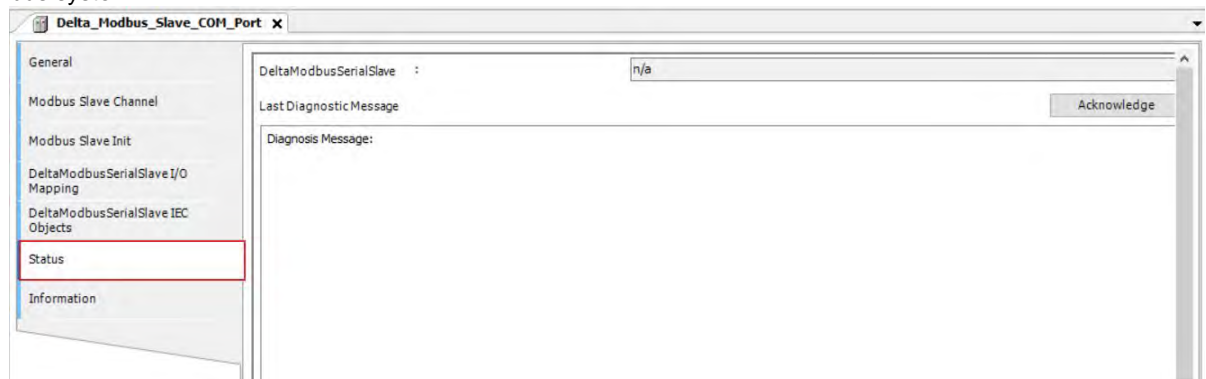

■ **Information**

Here you can find general information that originates from the device description file: name, vendor, categories, version, order number, description, and other relevant information.

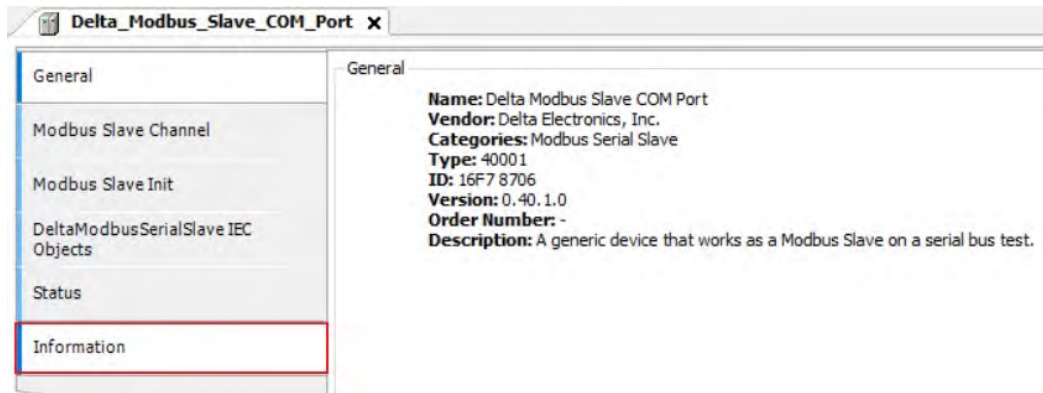

9.2.3 Modbus Serial Slave

AX-3 Series PLC can act as a Modbus Serial Slave, after you add Modbus Serial Device in and set up the allowable areas for Coils/Register. If Modbus Serial Master uses Delta device communication protocol, there is no access restrictions. Follow the below section to set up the Modbus Serial Slave.

9.2.3.1 Adding a Modbus Serial Device

1. Right-click the created Delta_Modbus_COM (Delta Modbus COM) in the tree view to open up a context menu. And click **Add Device...** to open the Add Device setting window.

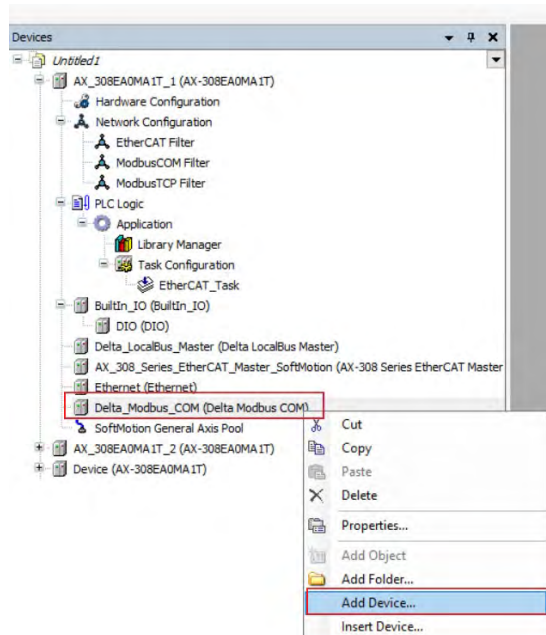

2. Find and double-click **Delta Modbus Serial Devie** (Fieldbuses -> Modbus -> Modbus Serial Master -> Delta Modbus Serial Device) or click **Add Device** to add this port in.

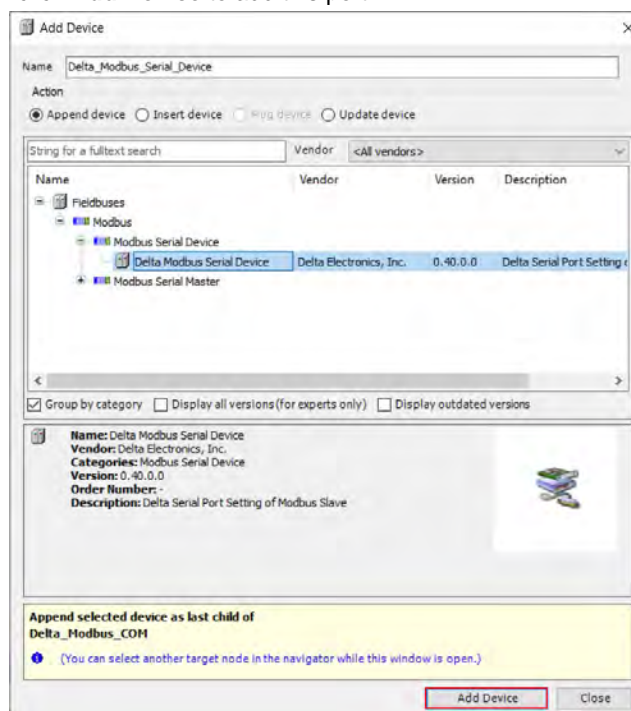

- Find the added port **Delta_Modbus_Serial_Device (Delta Modbus Serial Device)** in the tree view and double-click it to open the setting window to set up.

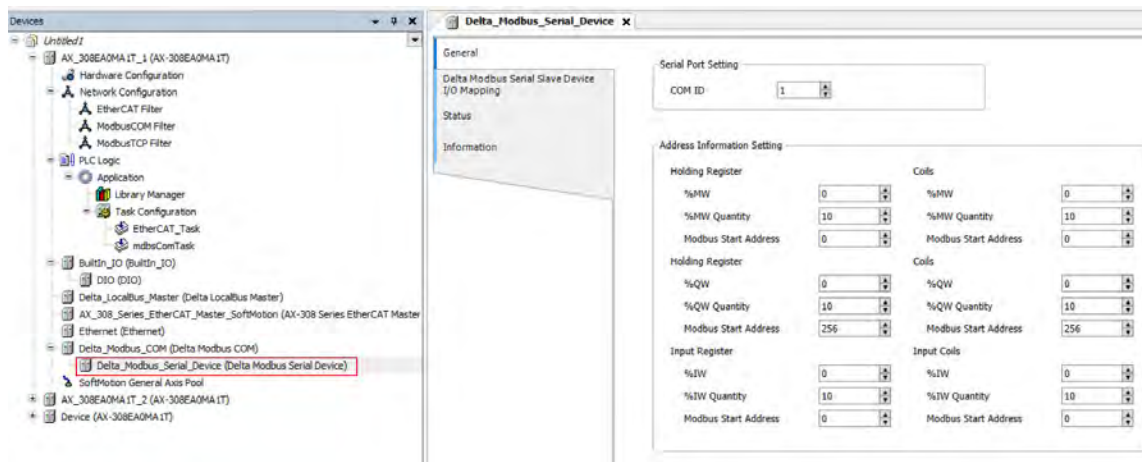

9.2.3.2 Setting up the Modbus Serial Device

■ **General**

Here you can configure the basic settings for Modbus Serial Device. Set up the allowable areas for Coils/Register. If Modbus Serial Master uses Delta device communication protocol, there is no access restrictions.

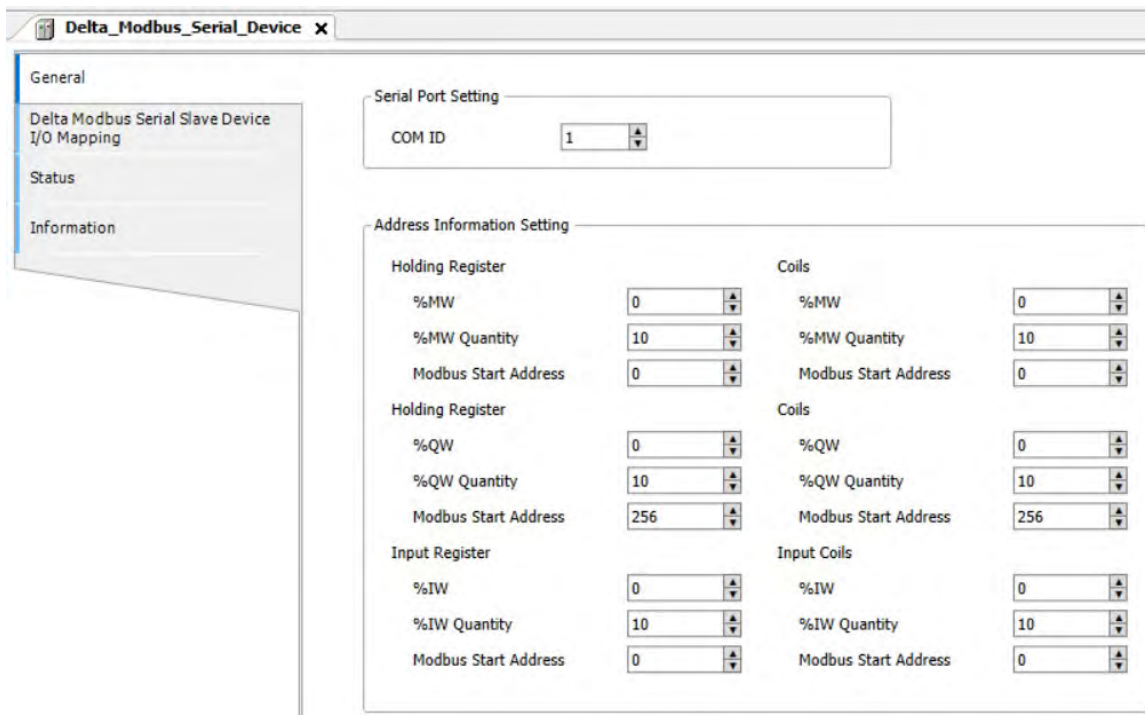

■ Delta Modbus Serial Slave/I/O Mapping

Bus cycle task: Select a bus cycle task to synchronize with the Modbus communication time. When the option “Use parent bus cycle setting is selected”, the system use the shortest cycle time as the bus cycle time. Refer to section 4.2.1.6 PLC Settings for more information.

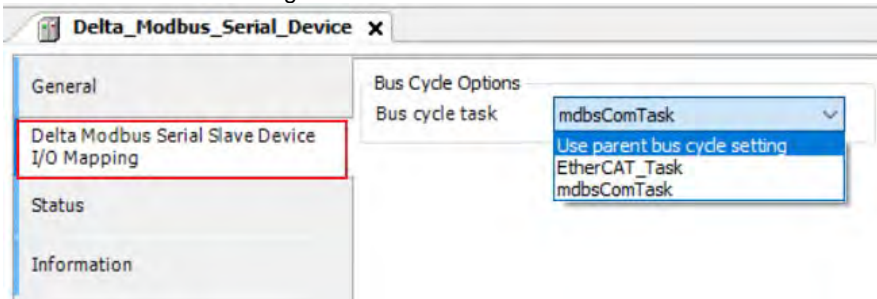

■ Status

Here you can find the Modbus Serial Slave Device status information, for example 'Running' or 'Stopped', and specific diagnostic messages from the respective device, also information about the card used and the internal bus system.

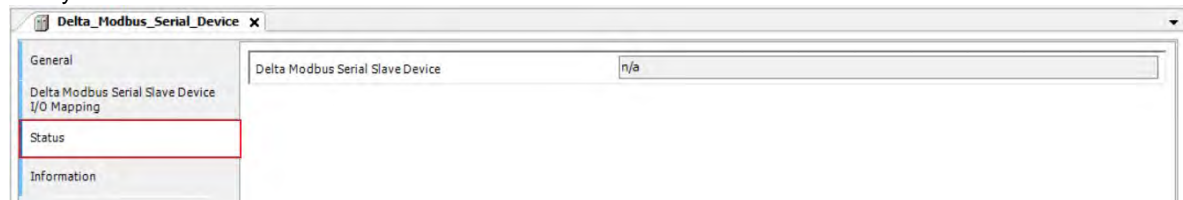

■ Information

Here you can find general information that originates from the device description file: name, vendor, categories, version, order number, description, and other relevant information.

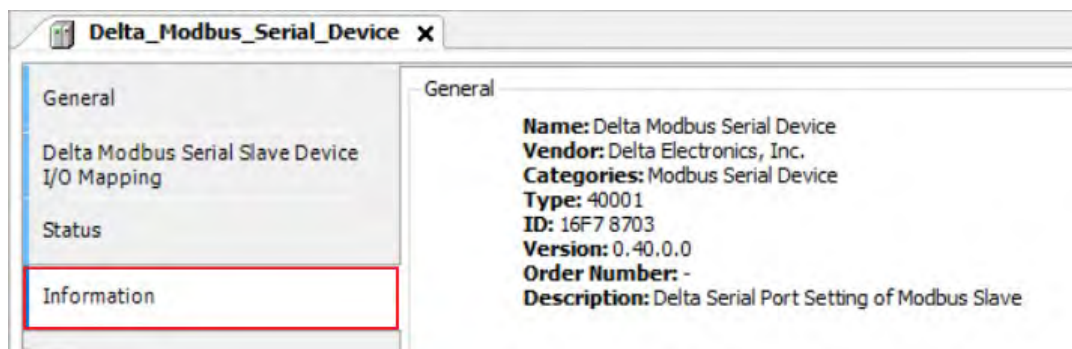

9.3 Introduction to Ethernet Communication

DIADesigner-AX supports the following Modbus network types, including Modbus TCP and EtherNet/IP. Follow the below section to set up the basic settings for communication via the Ethernet Adapter.

9.3.1 Network Security

We suggest you to use closed network or use local network with a firewall to secure and prevent the Ethernet network as well as our products from any unwanted attack.

9.3.2 Ethernet

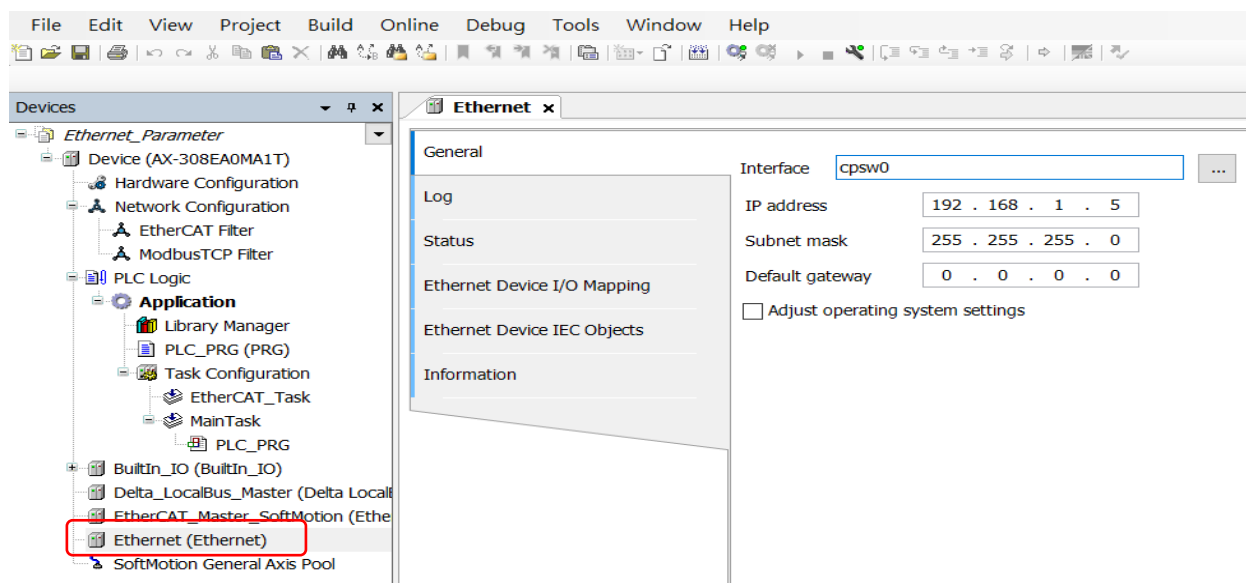

9.3.2.1 Adding an Ethernet Adapter Device

1. Right-click the PLC in the tree view to see a context menu. Click **Add Device...** to open the setting window.

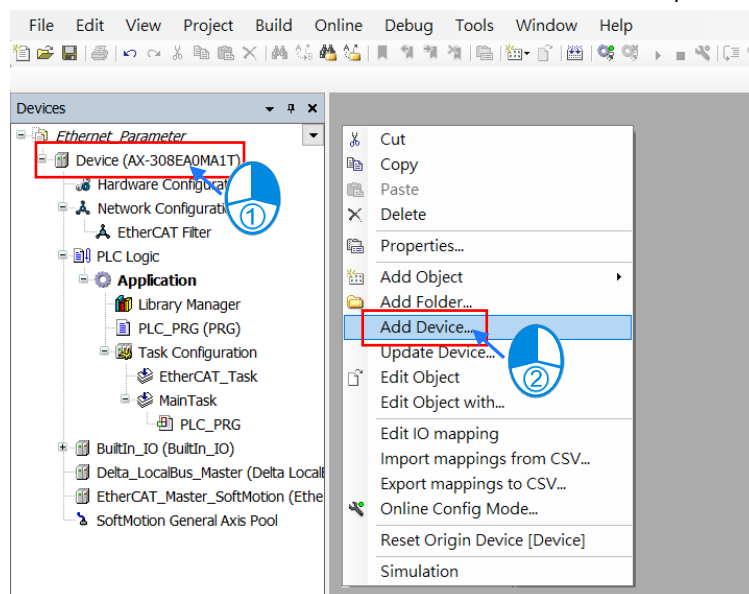

- Find and double-click **Ethernet** (Fieldbuses -> Ethernet Adapter -> Ethernet) or click **Add Device** to add it in.

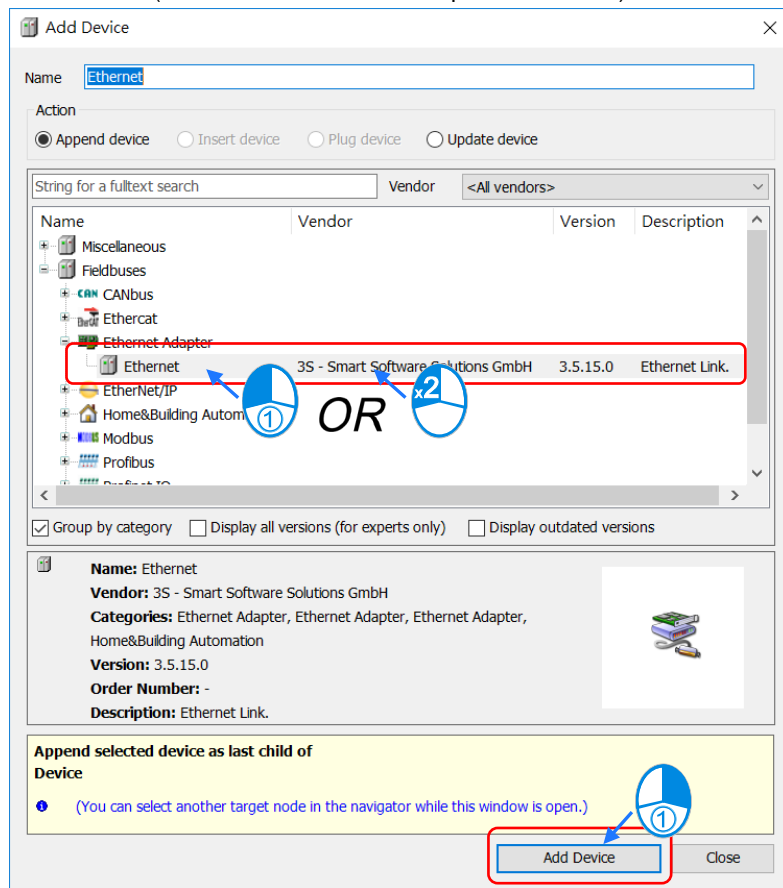

9.3.2.2 Setting up the Ethernet

Find the added **Ethernet** in the tree view and double-click it to open the setting window for setup.

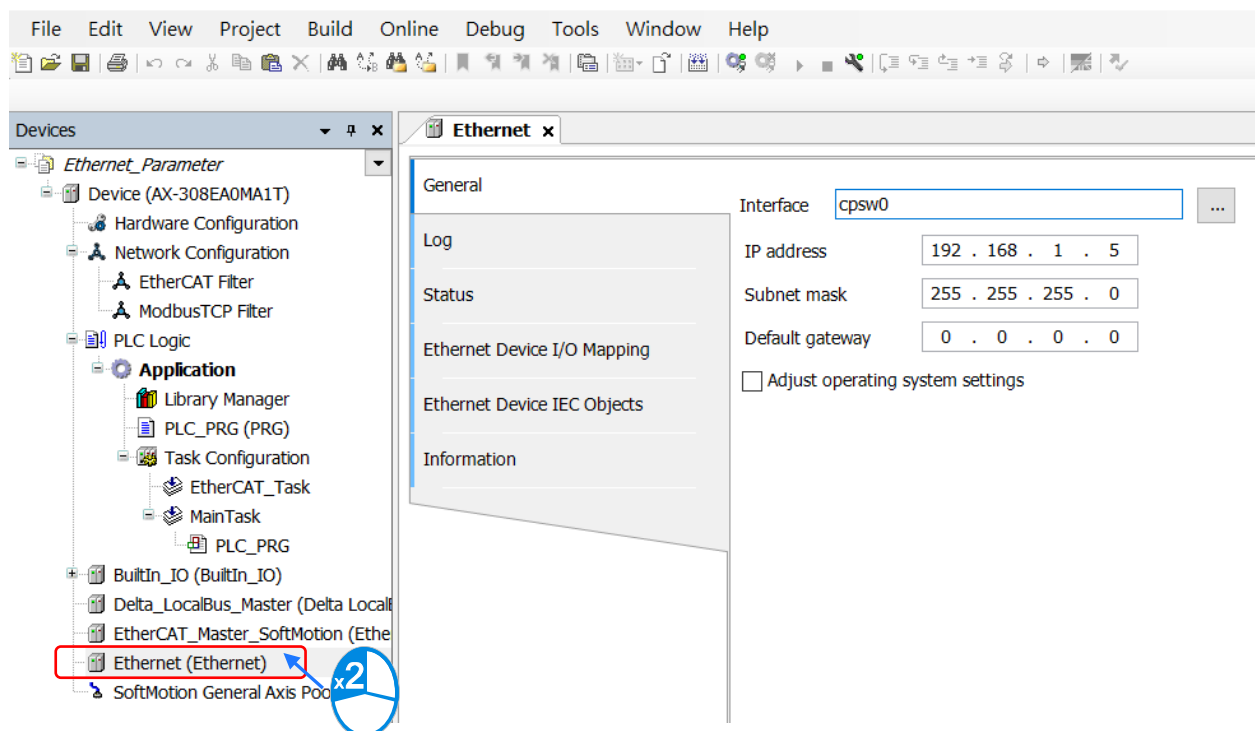

■ **General**

Here you can configure Ethernet Parameters. Settings include Interface, IP address, Subnet mask, Default gateway and Adjust operating system settings can be set here.

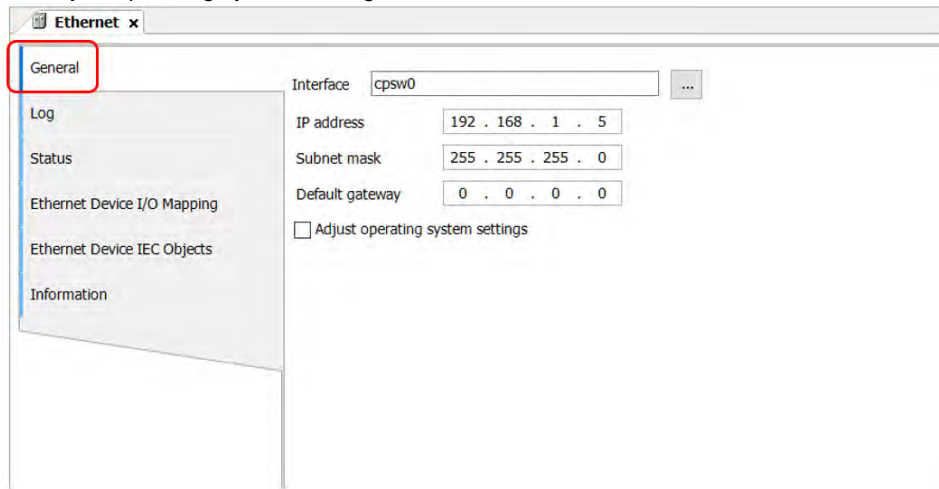

Item	Description
Interface	Current communication interface
IP address	Settings of the selected network interface
Subnet mask	
Default gateway	
Adjust operating system settings*	The settings on the target system will be overwritten by the values above.

Note: For FW V1.0.1.0 or later, you can find the DDF of AX-3 Series PLC on the setting page. Go to Device -> System Setting. Refer to section 4.2.1.11 for more information.

■ **Status**

Here you can find the device status information, for example 'Running' or 'Stopped', and specific diagnostic messages from the respective device.

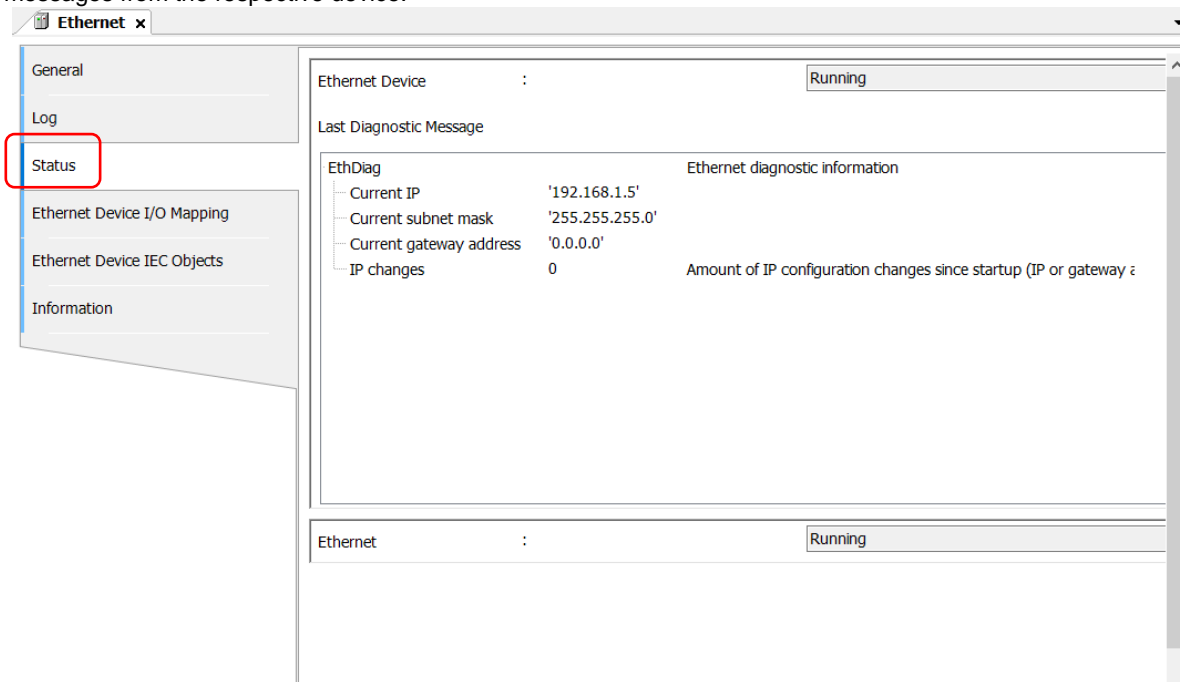

Item	Description
Ethenet Device	The status of Ethenet Communication
Last Diagnostic Message	Network diagnosis

■ **Ethernet Device I/O Mapping**

Bus cycle task: Select a bus cycle task to synchronize with the communication time. When the option "Use parent bus cycle setting is selected", the system use the shortest cycle time as the bus cycle time. Refer to section 4.2.1.6 PLC Settings for more information

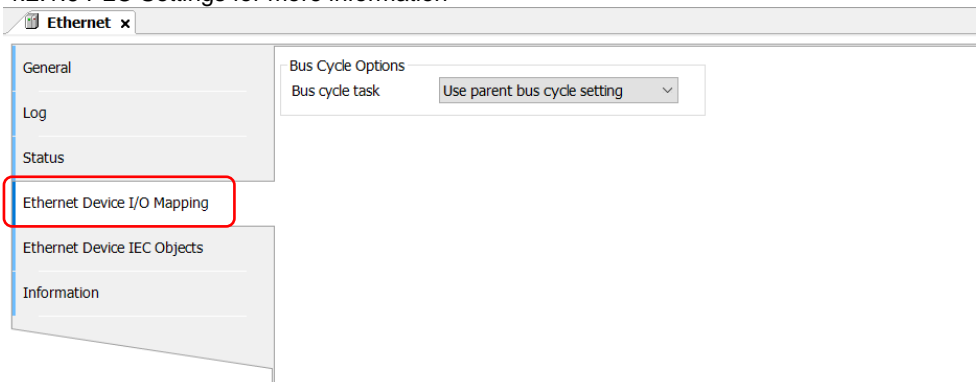

■ Ethernet Device IEC Objects

Here you can find the objects defined by Ethernet Adapter Device. “Objects” are listed that allow for access to the device from the IEC application. In online mode, you can use the table of IEC objects as a monitoring view.

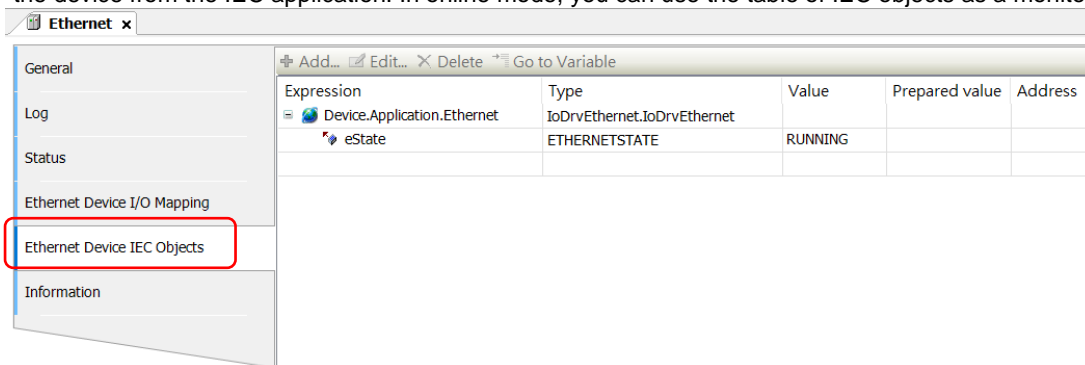

■ Information

Here you can find general information that originates from the device description file: name, vendor, categories, version, order number, description, and other relevant information.



9.3.3 Modbus TCP Master (Client)

In addition to providing the standard Modbus communication protocol, the AX-3 Series PLC further executes the Delta controller internal device conversion (X, M, D devices, etc.), eliminating the need for you to check the conversion table. AX-3 Series PLC can act as a Modbus TCP Master, after you have created Modbus TCP Master and Modbus TCP Slave. Follow the below section to set up the Modbus TCP Master.

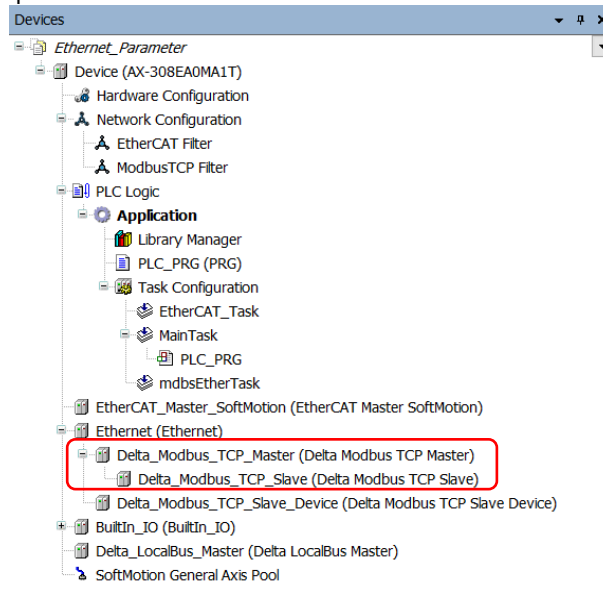

9.3.3.1 Adding a Modbus TCP Master/Slave

1. Right-click the **Ethernet (Ethernet)** node in the tree view to open up a context menu. And click **Add Device...** to open the Add Device setting window.

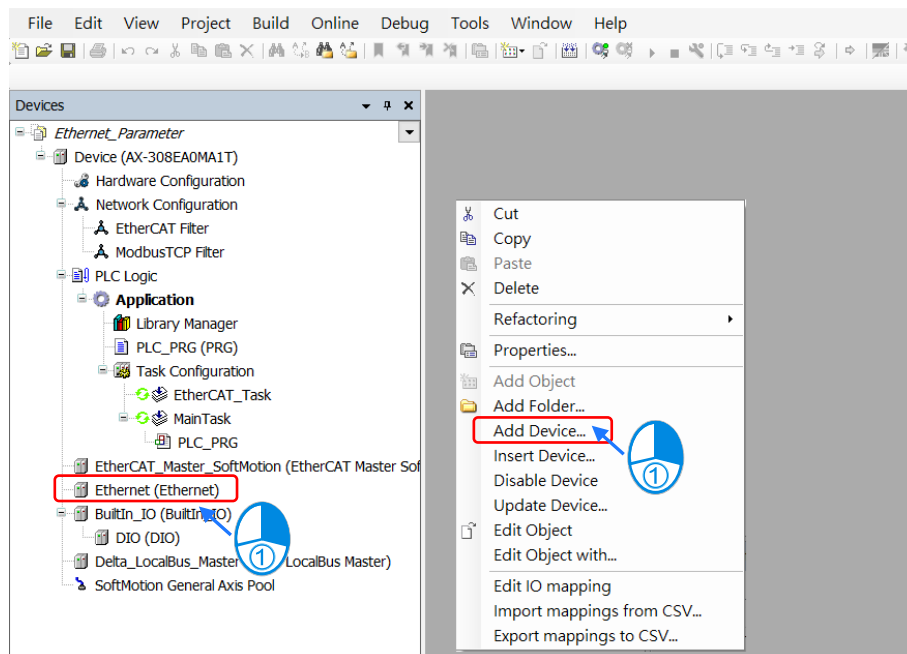

- Find and double-click **Delta Modbus TCP Master** (Fieldbuses -> Modbus -> Modbus TCP Master -> Delta Modbus TCP Master) or click **Add Device** to add this port in. After that you can find **Delta_Modbus_TCP_Master** under the Ethernet node in the tree view.

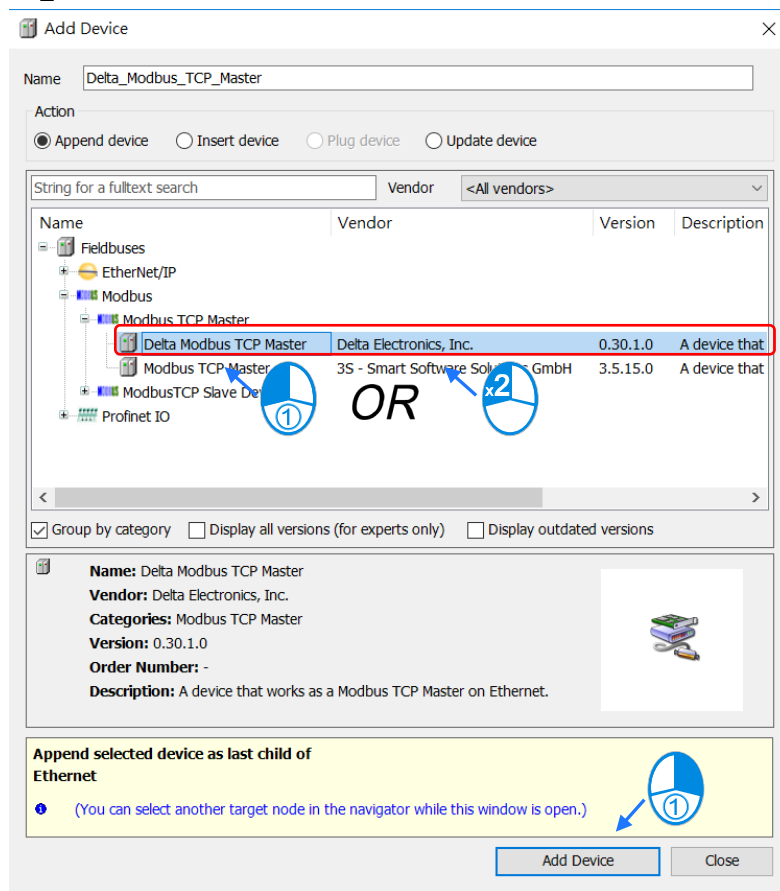

- Right-click **Delta_Modbus_TCP_Master** under the **Ethernet** node in the tree view to open up a context menu. And click **Add Device...** to open the Add Device setting window.

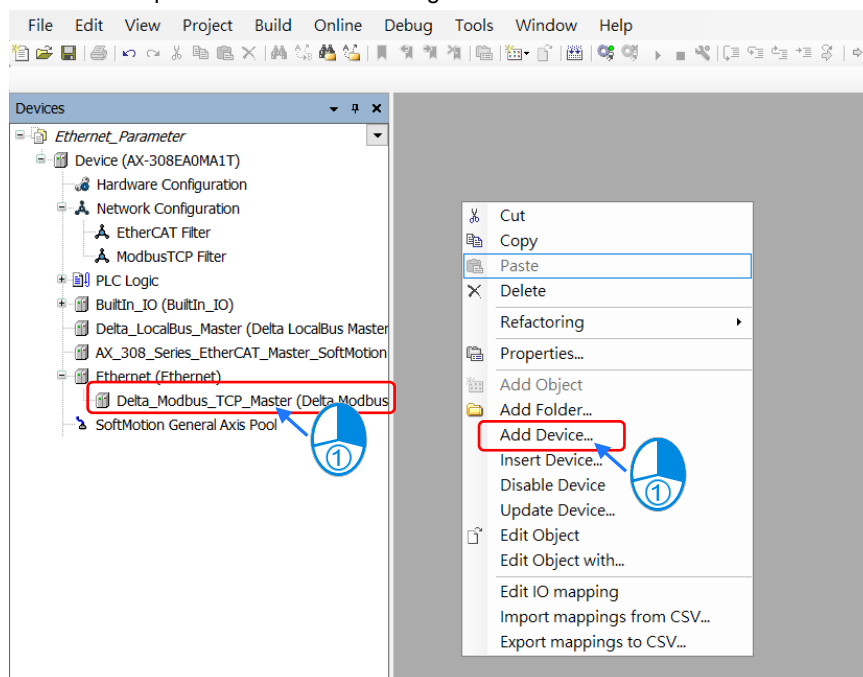

4. Find and double-click **Delta Modbus TCP Slave** (Fieldbuses -> Modbus -> Modbus TCP Slave -> Delta Modbus TCP Slave) or click **Add Device** to add it in.

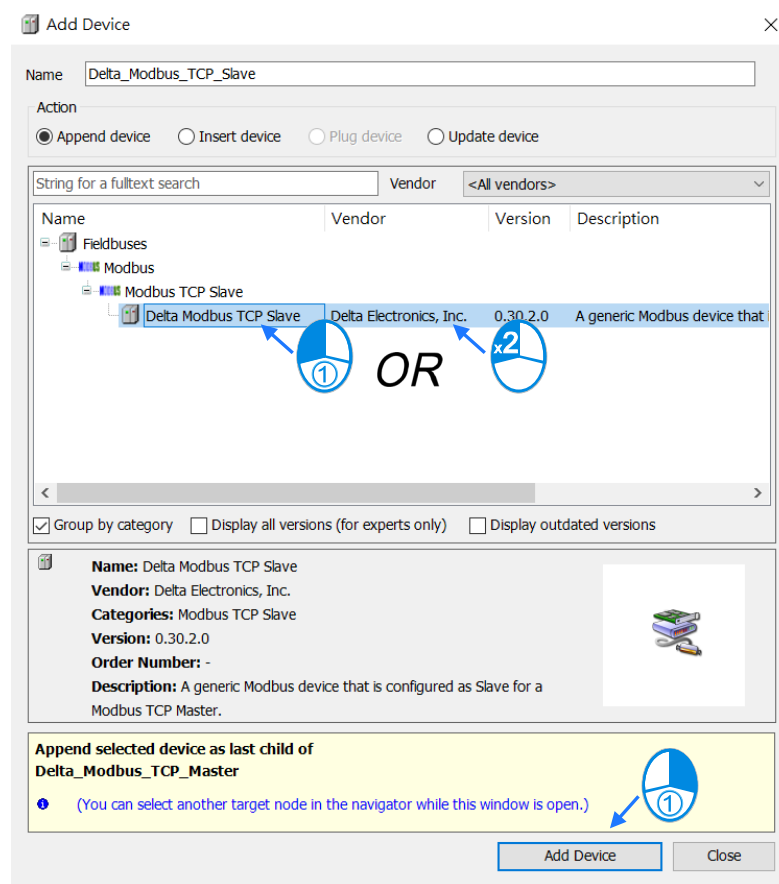

After that you can find **Delta_Modbus_TCP_Slave** under the **Delta_Modbus_TCP_Master** node in the tree view.

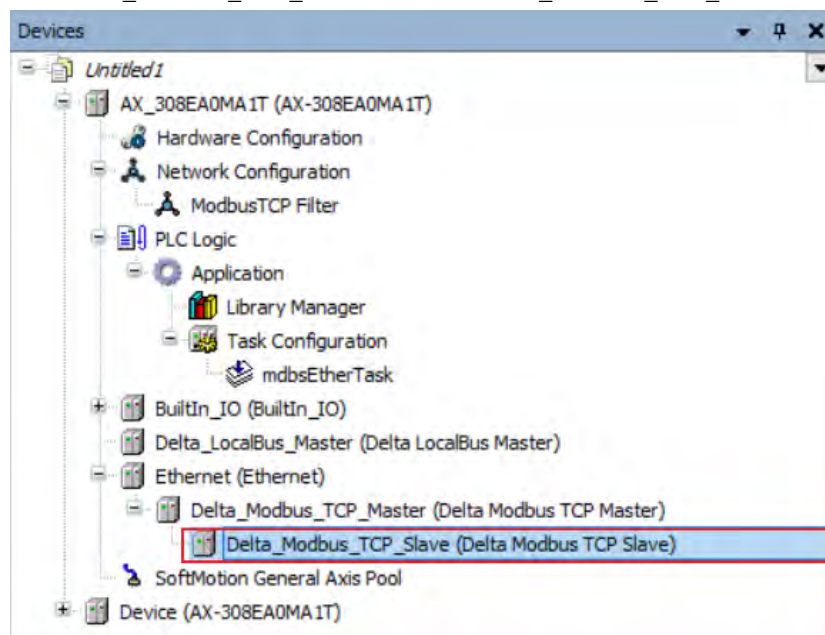

9.3.3.2 Setting up the Modbus TCP Master

Delta Modbus TCP Master I/O Mapping

Bus cycle task: Select a bus cycle task to synchronize with the Modbus communication time. When the option “Use parent bus cycle setting is selected”, the system use the shortest cycle time as the bus cycle time. Refer to 4.2.1.6 section “PLC Settings” for more information.

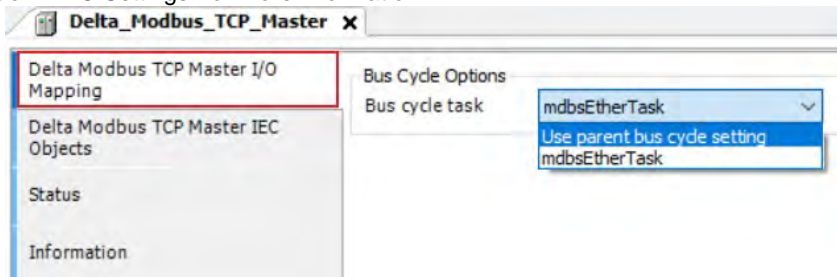

Delta Modbus TCP Master IEC Objects

You can check the status of Modbus TCP Master under this tab.

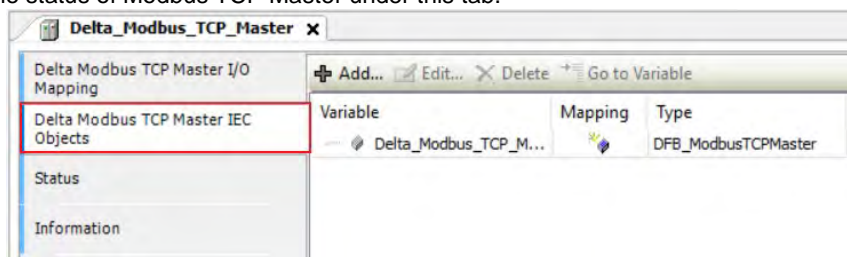

- bStop: TRUE => Stop sending Modbus TCP packets.
 - bSlaveError: TRUE => connection/communication with the Slave is abnormal
 - uiConnectedSlaves: the number of the connected Slaves
- EX: (ST programming language): Delta Modbus TCP Master.bStop:= TRUE;

Status

Here you can find the device status information, for example ‘Running’ or ‘Stopped’, and specific diagnostic messages from the respective device, also information about the card used and the internal bus system.

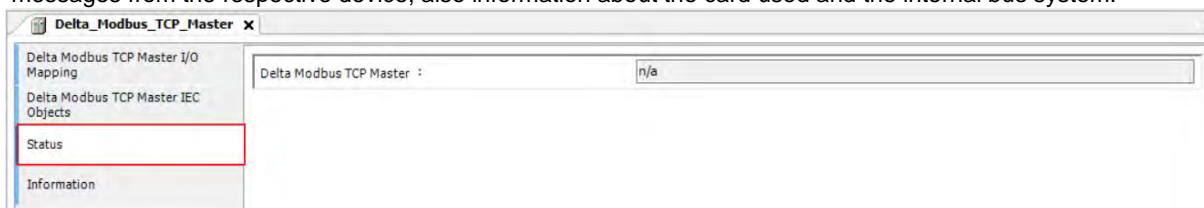

Information

Here you can find general information that originates from the device description file: name, vendor, categories, version, order number, description, and other relevant information.

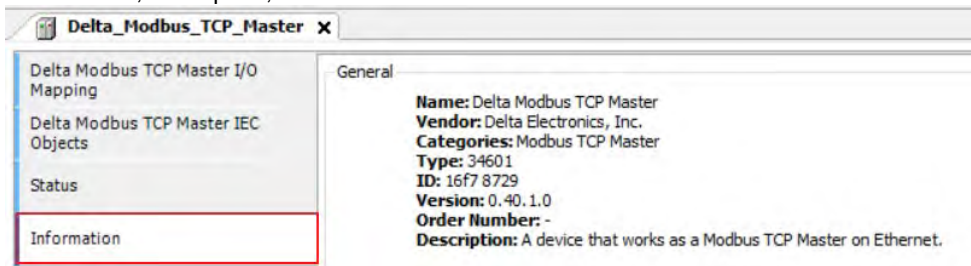

9.3.3.3 Setting up the Modbus TCP Slave

1. In the tree view, find the **Delta_Modbus_TCP_Slave (Delta Modbus TCP Slave)** and double-click it to open the setting window to set up.

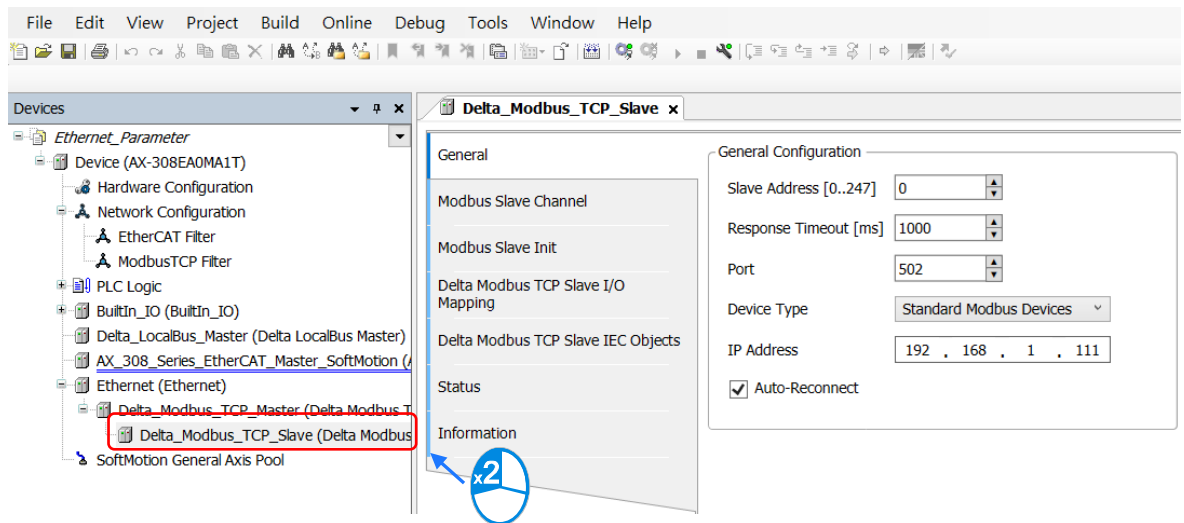

■ General

Here you can configure the basic settings for Modbus TCP Slave, such as Slave Address, Response Timeout and Device Type.

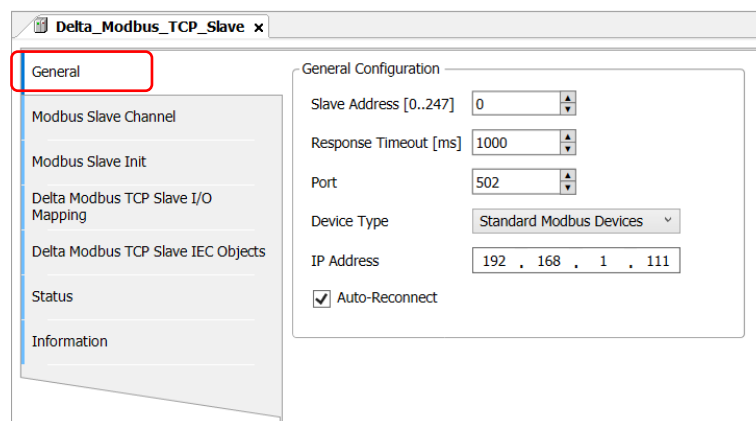

Item	Description
Slave Address	Address of a serial Modbus device
Response Timeout	Time interval for the master to wait for the response from the slave. This is especially configured for this slave node and overwrites the general response timeout setting of the respective master.
Port	Port number
Device Type	You can select standard Modbus devices or Delta devices. If you select Delta devices, the system converts the protocol used into Modbus protocol automatically so that you do NOT need to refer to the register map for the conversion.
IP Address	Slave IP address
Auto-Reconnect	Enable this option to have this port to reconnect automatically if an error occurs or connection timeout occurs.

Modbus Slave Channel

Here you can define slave channels. Each channel represents a single Modbus request. You can create up to 10 channels for each slave. AX-3 Series PLC will send out Modbus request packets in chronological order. All channels share the same Modbus TCP connection.

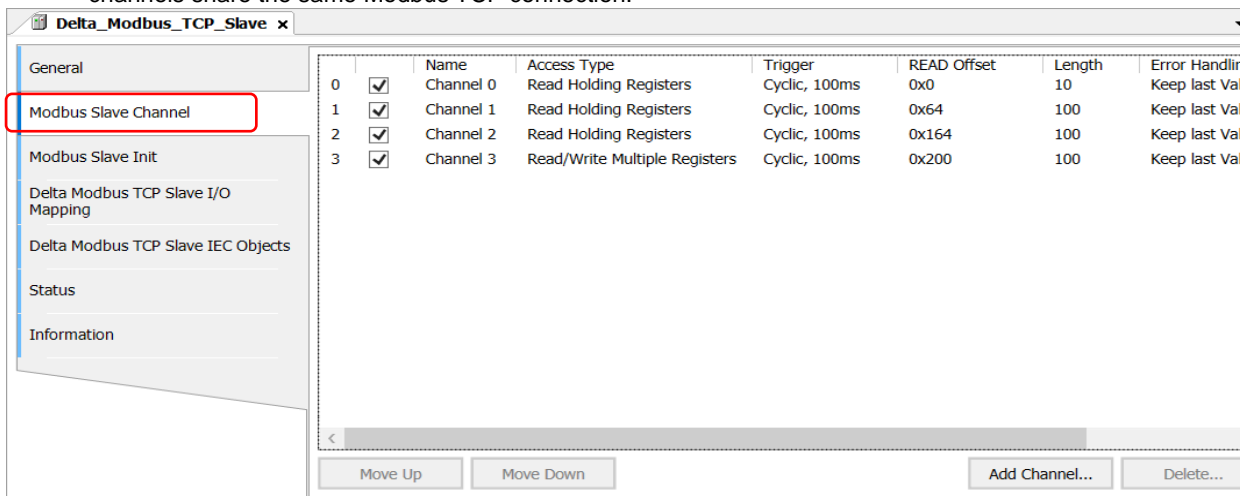

Click **Add Channel**, you can edit the channel before adding it in. The **Device Address** shows the Modbus protocol address whether the device type you selected is **Standard Modbus Device** or **Delta Devices** under the **General** tap. Since the system converts the protocol used into Modbus protocol automatically, you do NOT need to refer to the register map for the conversion.

Device Type : Standard Modbus Device

Device Type : Delta AH Series

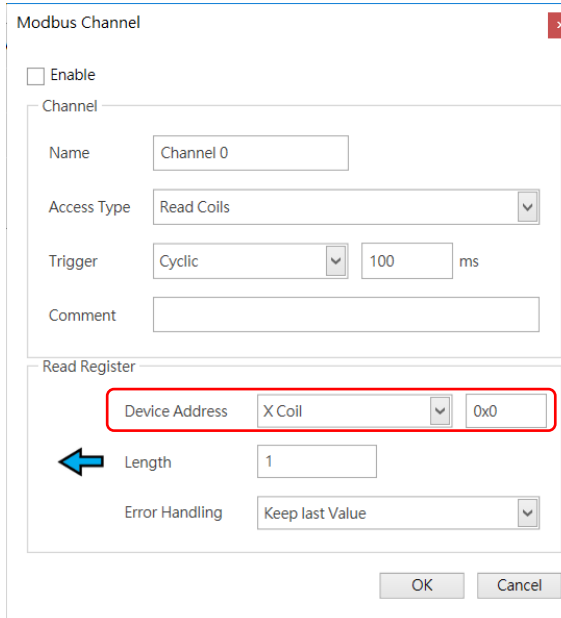
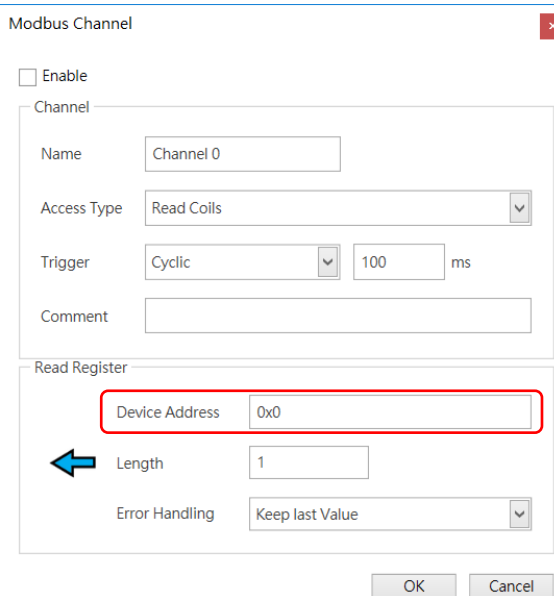

Item	Description	
Device Type	Standard Modbus Device	Delta Series Device
Enable	Activates this channel	
Name	Defines this channel name	
Access Type	Modbus function code <ul style="list-style-type: none"> ● Read coils (0x01) ● Read discrete inputs (0x02) ● Read holding registers (0x03) ● Read input registers (0x04) ● Read single coil (0x05) ● Write single register (0x06) ● Write multiple coils (0x0F) ● Write multiple registers (0x10) ● Read/Write multiple registers (0x17) 	Read/Write Registers <ul style="list-style-type: none"> ● Read coils ● Read registers ● Write coils ● Write registers <p>Note: PLC uses the corresponding Modbus function code according to the read/write register of the device type.</p>
Trigger	<ul style="list-style-type: none"> ● Cyclic: The request occurs periodically. ● Rising edge: The request occurs as a reaction to a rising edge of the Boolean trigger variables. The trigger variable is defined in the tab I/O Mapping. ● Application: The Modbus request is triggered by DFB_ModbusTCPChannel 	<ul style="list-style-type: none"> ● Cyclic: The request occurs periodically. ● Rising edge: The request occurs as a reaction to a rising edge of the Boolean trigger variables. The trigger variable is defined in the tab I/O Mapping. ● Application: The Modbus request is triggered by DFB_ModbusTCPChannel
Comment	Description of the channel	
Device Address	Modbus protocol address	Delta register address (will be converted into Modbus protocol in the background)
Length	Number of the register to be read/written to.	Number of the register to be read/written to. (up to 256 coils and 100 registers)
Error Handling	What to do with the data in case of a communication error: <ul style="list-style-type: none"> ● Set To ZERO ● Keep last value 	

■ **Modbus Slave Init**

After the Modbus connection between AX-3 Series PLC and the slaves is established, you can use **Add Channel** button to edit the Initialization Value of the Coil/Register.

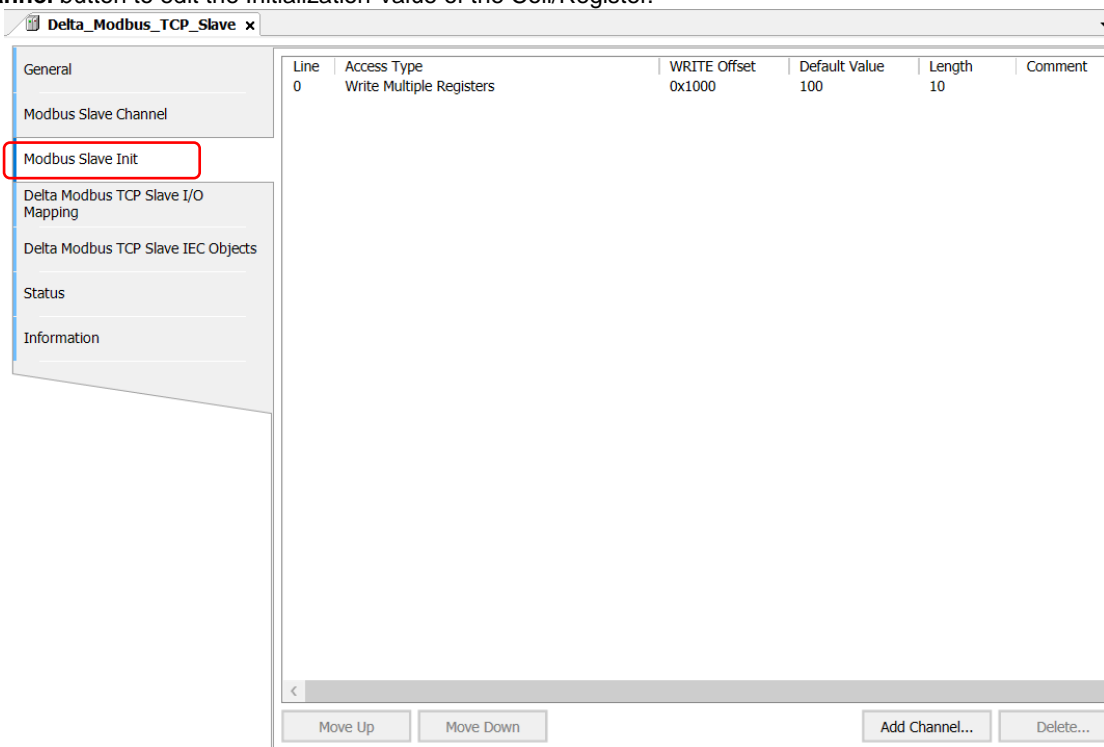

Click **Add Channel**, you can edit the Access Type, Device Address, Length, Initialization Value and Comment. Click OK to confirm the settings.



■ **Modbus Generic Serial Slave I/O Mapping**

After you have added channels under the tab of Modbus Slave Channel, you can find the variables and the set access types under this tab. Here you can define the variables for mapping. The descriptions here reflect what you have set for the **Access Type** in Modbus Slave Channel tab. When the **Trigger type** is set to **Rising edge** in Modbus Slave Channel, the description here adds one more condition, **Trigger variable**.

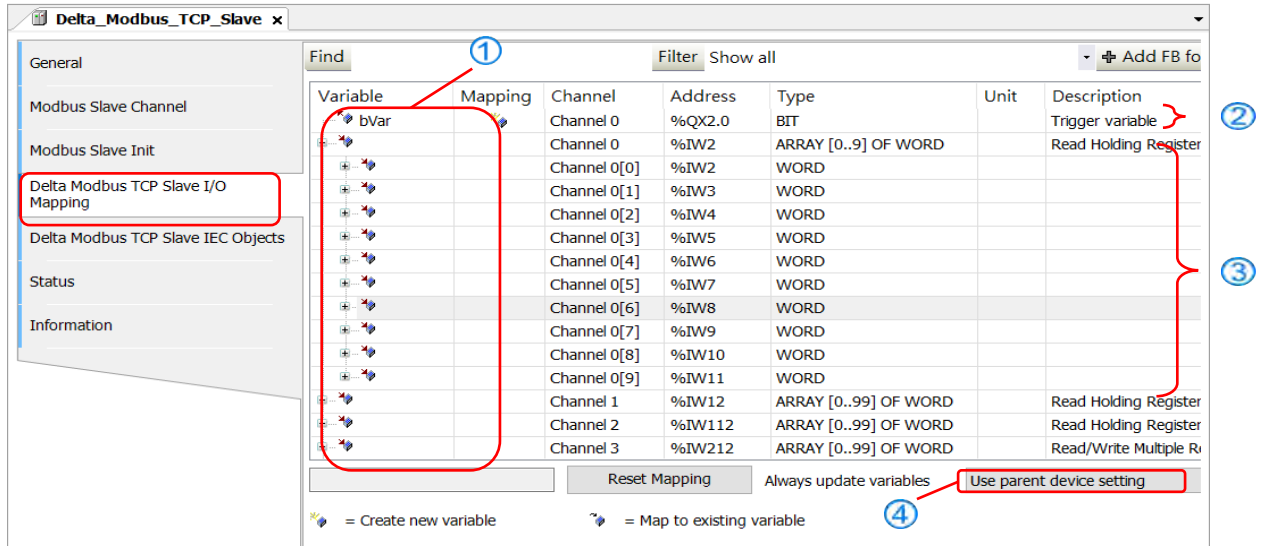

- ① The descriptions here reflect what you have set for the **Access Type** in Modbus Slave Channel tab.
- ② The triggered Boolean variable for this channel.
- ③ The controller registers that are read/written by this channel.
- ④ Timing for the data refreshing; refer to section 4.2.1.6 PLC Settings for more information.

■ **Delta Modbus TCP Slave IEC Objects**

You can check the status of Modbus TCP Slave under this tab.

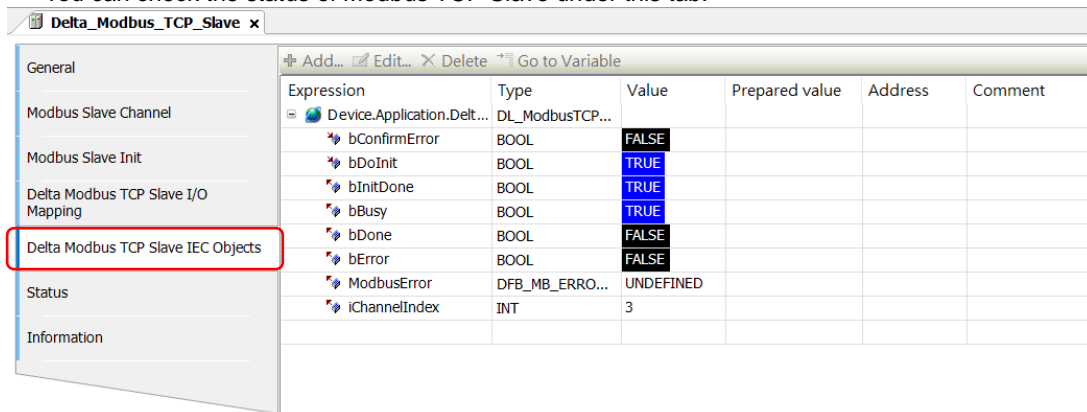

Expression	Description
bConfirmError	If the option “Auto-Reconnect” is NOT enabled, during the data transmission, any channel that showed error stops. After the bConfirmError shows “TRUE”, the channel that showed error previously continues to execute.
bDoInit	Initialized the Slave
bInitDone	The initialization of the Slave is complete.
bBusy	This channel is in data transmission.
bDone	The data transmission via this channle is complete.
bError	Error occurs when this channels is in data transmission.

Expression	Description
ModbusError	Record of the Modbus error
iChannellIndex	The number of the channel that is in execution.

■ **Status**

Here you can find the Modbus TCP Slave status information, for example 'Running' or 'Stopped', and specific diagnostic messages from the respective device, also information about the card used and the internal bus system.

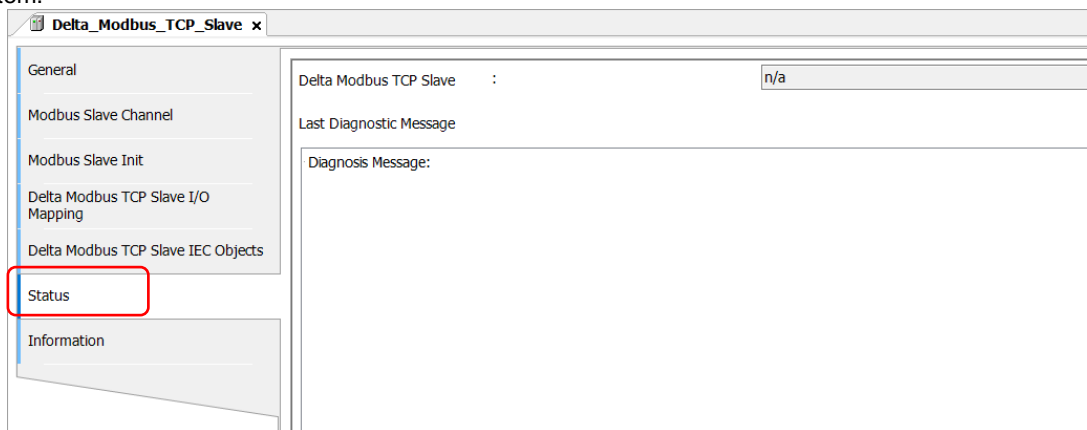

■ **Information**

Here you can find general information that originates from the device description file: name, vendor, categories, version, order number, description, and other relevant information.

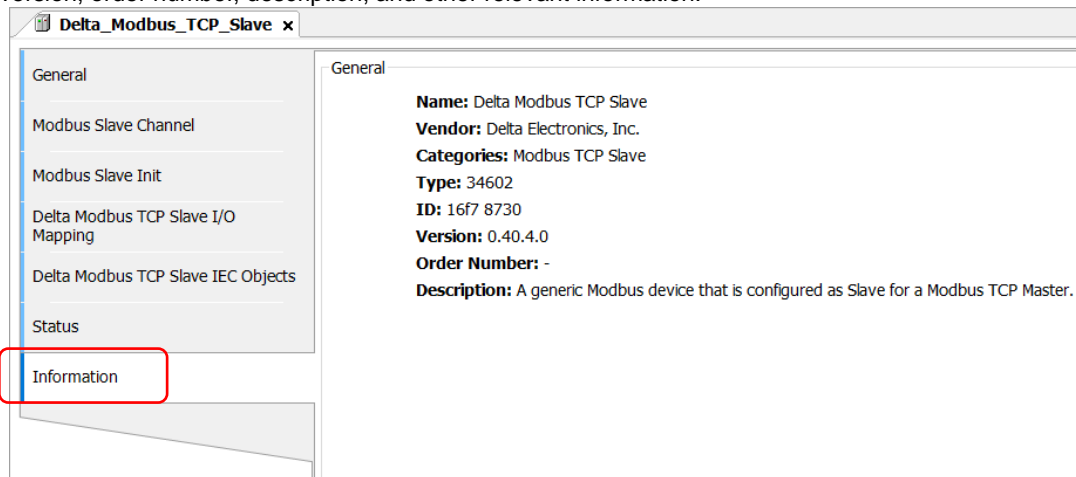

9.3.4 Modbus TCP Slave (Server)

AX-3 Series PLC can act as a Modbus TCP Slave, after you add Modbus TCP Slave Device in and set up the allowable areas for Coils/Register. If Modbus TCP Master uses Delta device communication protocol, there is no access restrictions. Follow the below section to set up the Modbus TCP Slave.

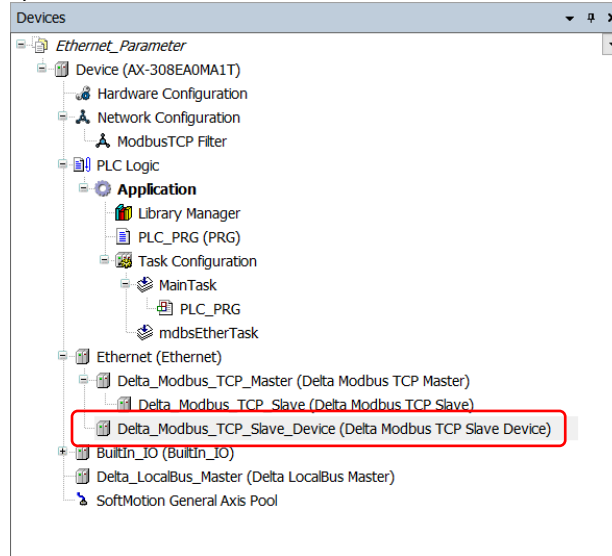

9.3.4.1 Adding a Modbus TCP Slave Device

1. Right-click the **Ethernet (Ethernet)** node in the tree view to open up a context menu. And click **Add Device...** to open the Add Device setting window.

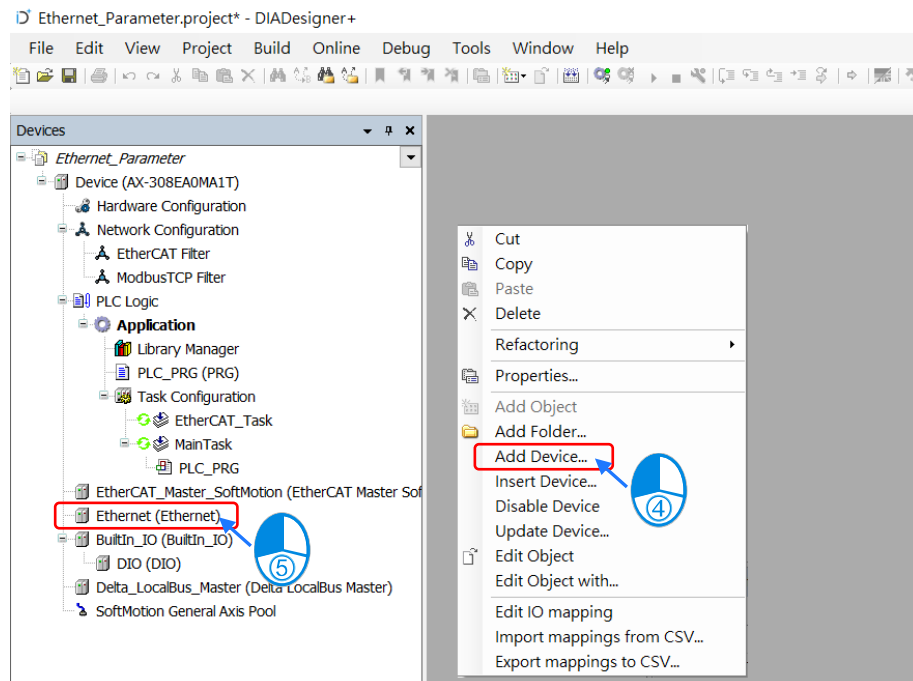

- Find and double-click **Delta Modbus TCP Slave Device** (Fieldbuses -> Modbus -> Modbus TCP Slave Device -> Delta Modbus TCP Slave Device) or click **Add Device** to add this port in.

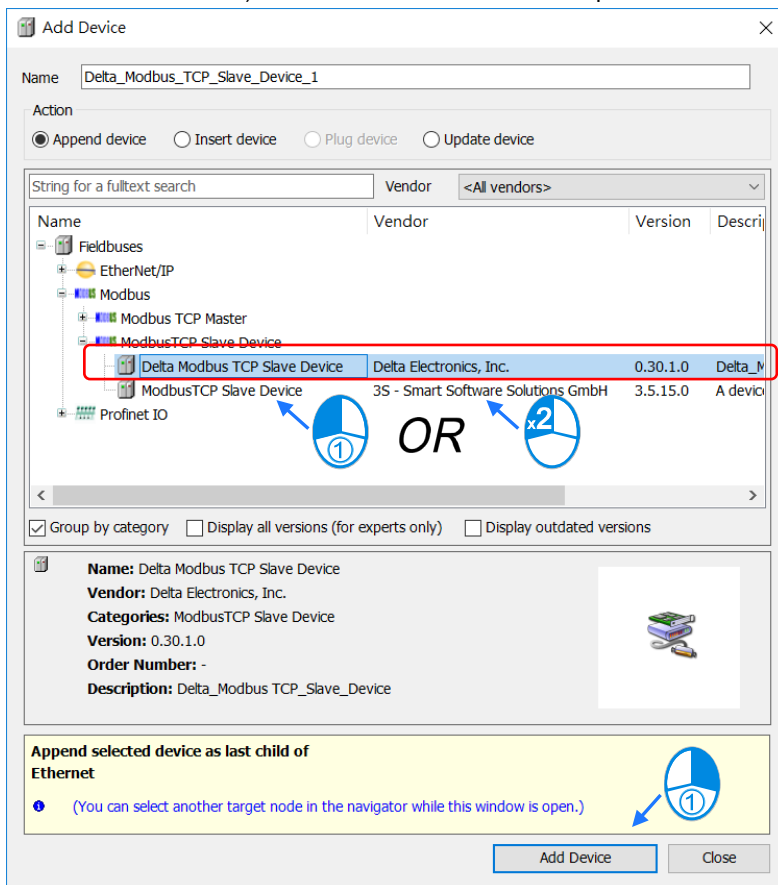

- Find the added port **Delta_Modbus_TCP_Slave_Device** (**Delta Modbus TCP Slave Device**) in the tree view and double-click it to open the setting window to set up.

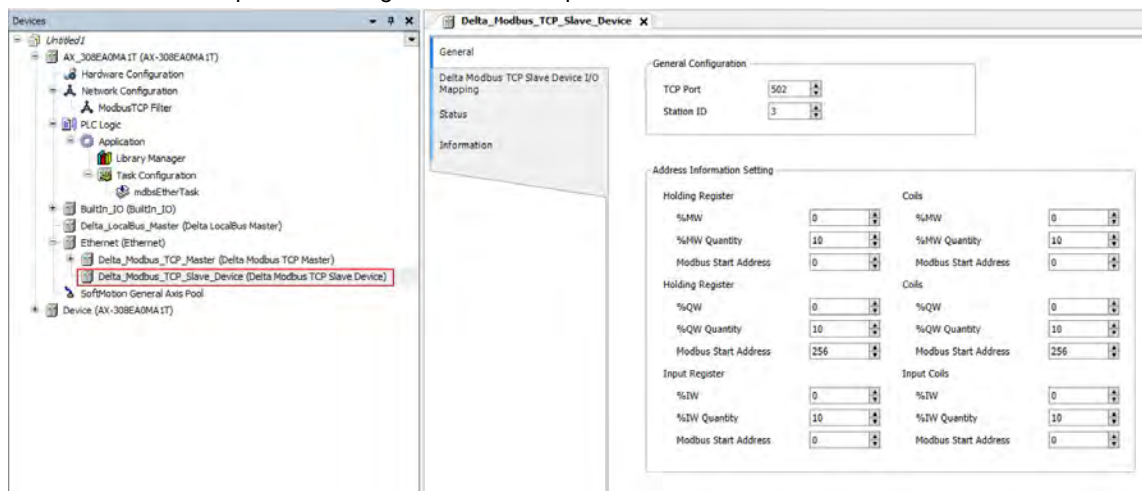

9.3.4.2 Setting up the Modbus TCP Slave Device

■ General

Here you can configure the basic settings for Modbus TCP Slave Device. Set up the allowable areas for Coils/Register. If Modbus TCP Slave uses Delta device communication protocol, there is no access restrictions.

The screenshot shows the 'Delta Modbus TCP Slave Device' configuration window with the 'General' tab selected. The window is divided into two main sections: 'General Configuration' and 'Address Information Setting'.

General Configuration:

- TCP Port: 502
- Station ID: 3

Address Information Setting:

Register Type	Address	Quantity	Start Address
Holding Register	%MW	0	0
	%MW Quantity	10	
	Modbus Start Address		0
Holding Register	%QW	0	256
	%QW Quantity	10	
	Modbus Start Address		256
Input Register	%IW	0	0
	%IW Quantity	10	
	Modbus Start Address		0
Coils	%MW	0	0
	%MW Quantity	10	
	Modbus Start Address		0
Coils	%QW	0	256
	%QW Quantity	10	
	Modbus Start Address		256
Input Coils	%IW	0	0
	%IW Quantity	10	
	Modbus Start Address		0

■ Delta Modbus TCP Slave Device I/O Mapping

Bus cycle task: Select a bus cycle task to synchronize with the Modbus communication time. When the option "Use parent bus cycle setting is selected", the system use the shortest cycle time as the bus cycle time. Refer to section 4.2.1.6 PLC Settings for more information.

The screenshot shows the 'Delta Modbus TCP Slave Device' configuration window with the 'Delta Modbus TCP Slave Device I/O Mapping' tab selected. The window displays the 'Bus Cycle Options' section.

Bus Cycle Options:

- Bus cycle task: mdbusEtherTask

■ **Status**

Here you can find the Modbus TCP Slave Device status information, for example 'Running' or 'Stopped', and specific diagnostic messages from the respective device, also information about the card used and the internal bus system.

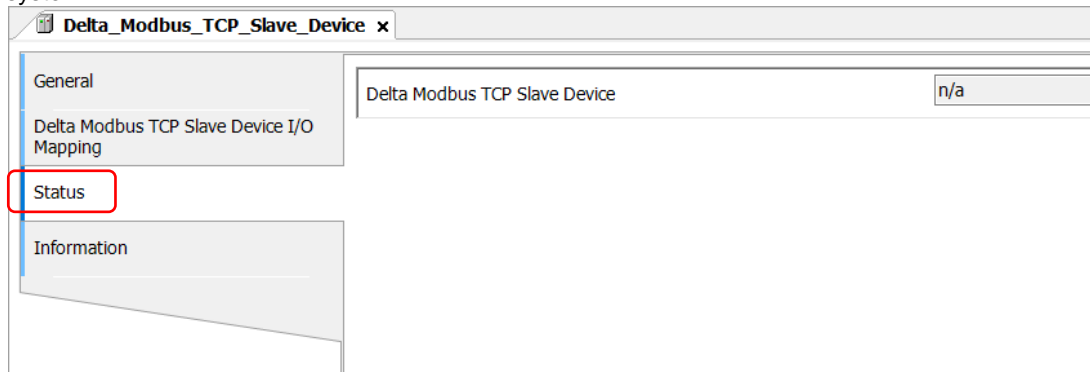

■ **Information**

Here you can find general information that originates from the device description file: name, vendor, categories, version, order number, description, and other relevant information.

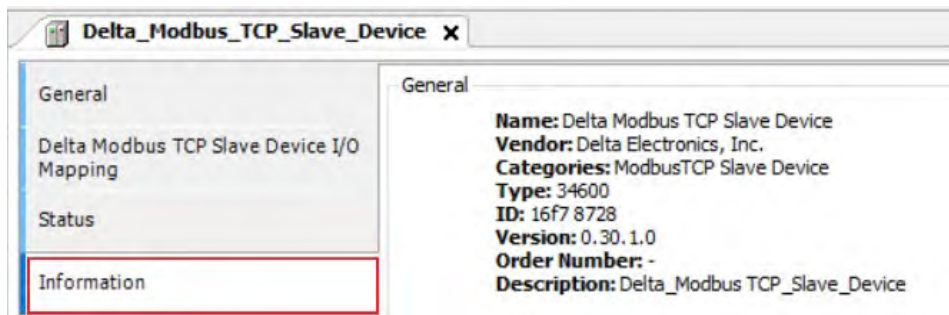

9.3.5 PROFINET IO

PROFINET IO is a fieldbus protocol that enables communication between programmable controllers and distributed field devices in Ethernet. With specific service sets, devices are classified into IO Controllers, IO Supervisors, and IO Devices. PROFINET IO uses three different communication channels to exchange data: Standard UDP/IP and TCP/IP channels, Real-time (RT) channels and Instant Real-time channels.

The standard UDP/IP and TCP/IP channels are used for parameterization and configuration of devices and non-cyclical operations; the Real-Time (RT) channel is used for cyclic data transmission and alarms; while the Instant Real-Time (IRT) channel is used for motion control applications.

Note: This function is only available for the following devices and software versions.

- DIADesigner-AX: V1.4.0 or later
- AX-3 Series PLC CPU: V1.0.5.0 or later
- Library "IoDrvProfinetDevice": V4.3.0.0 or later

9.3.5.1 PROFINET Device

9.5.3.1.1 Add a PROFINET Device

This section will explain how to add a PROFINET device. Refer to the following steps for configuration.

- Adding a PROFINET Device :

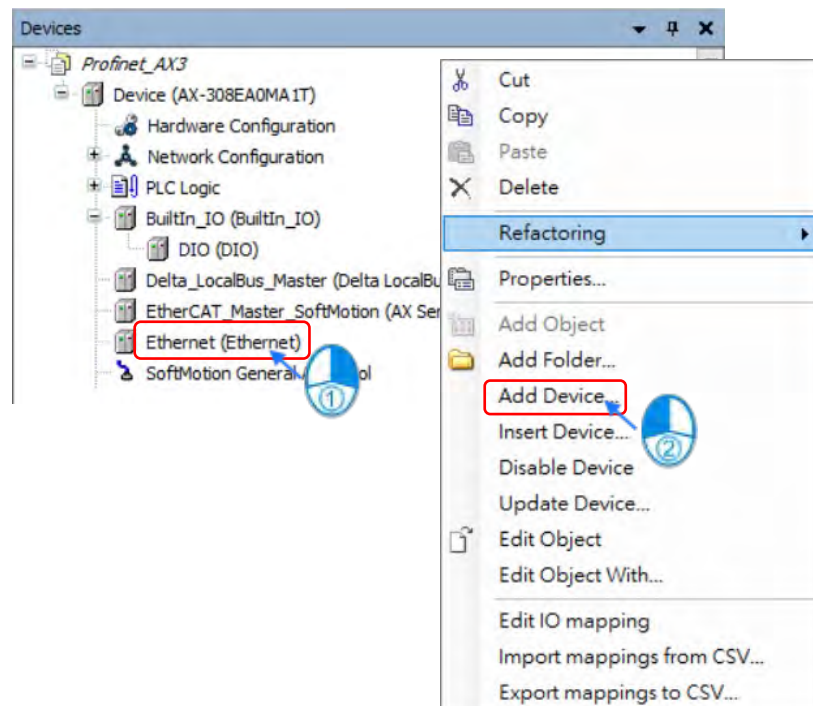

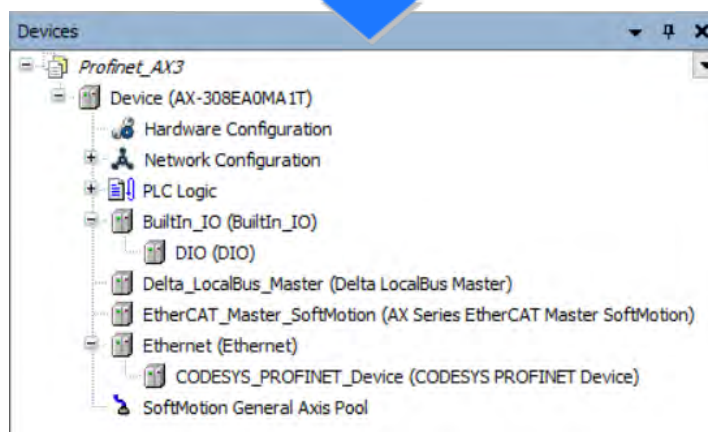
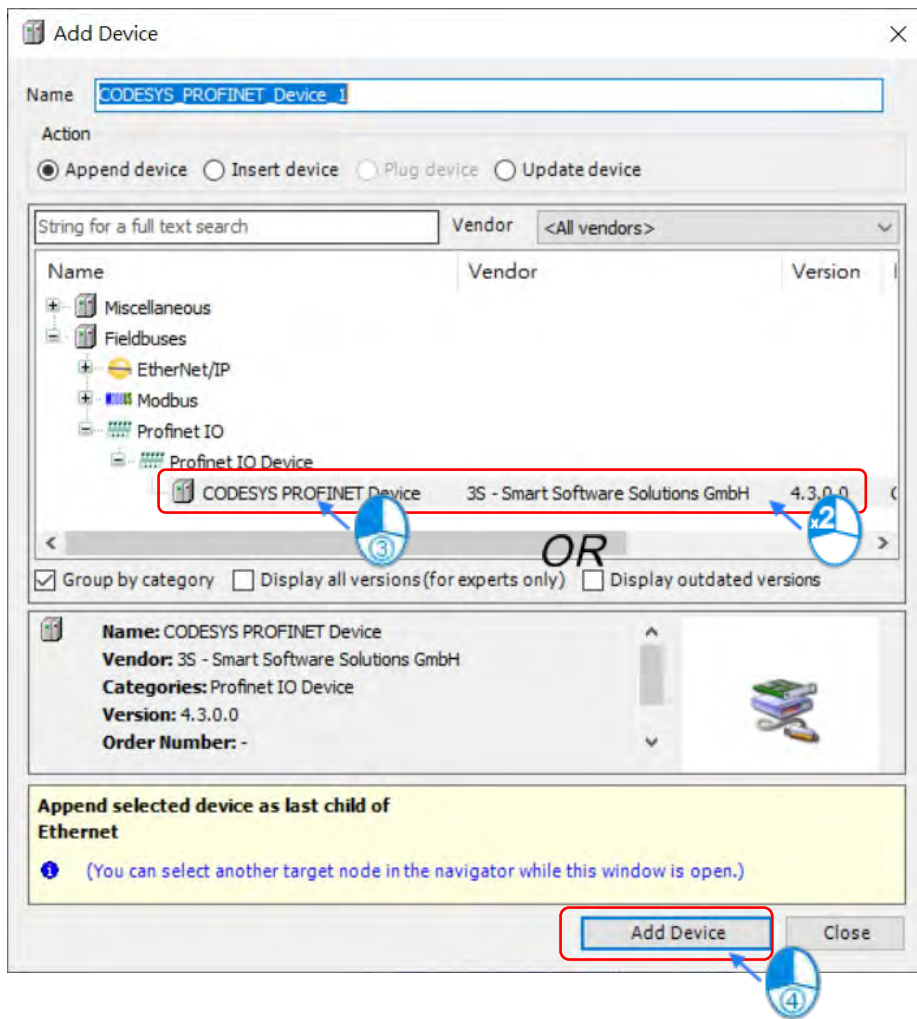

- Setting up the data structure for PROFINET Device:

You can set up the data structure according to your preference.

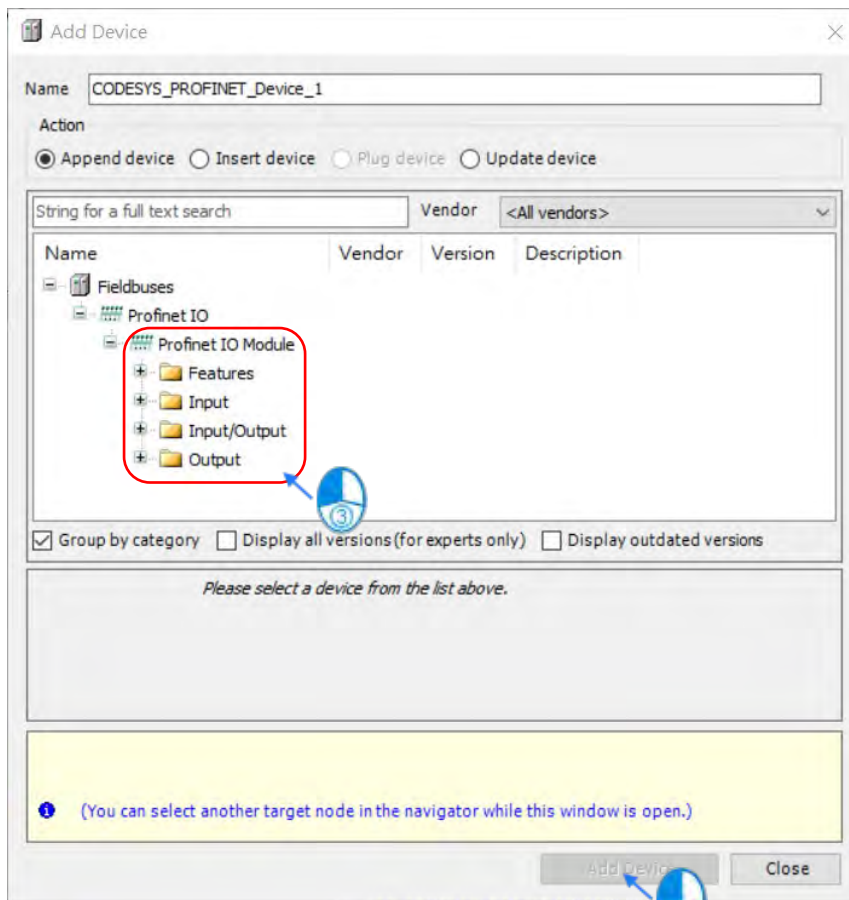
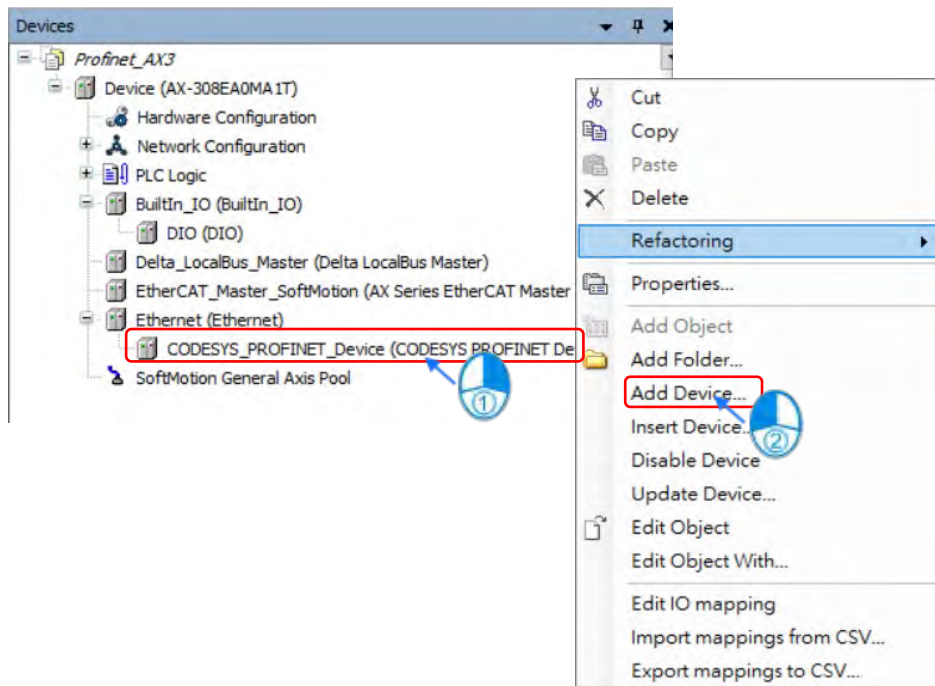

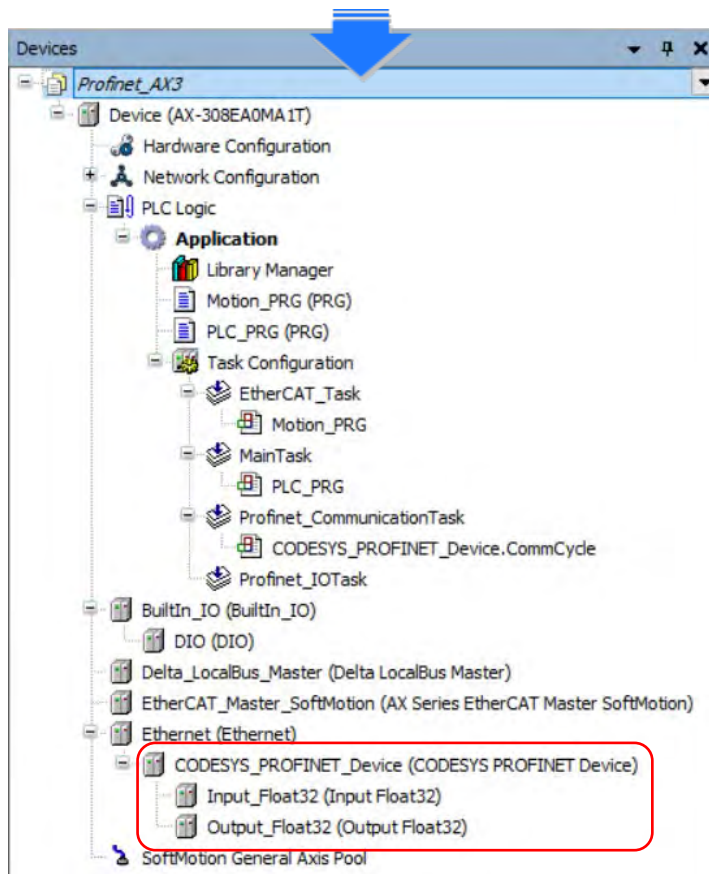

9.3.5.1.2 Settings of PROFINET Device

This section introduces the PROFINET Device setting pages.

- **General :**

Define the IP address and station name for the PROFINET Device here.

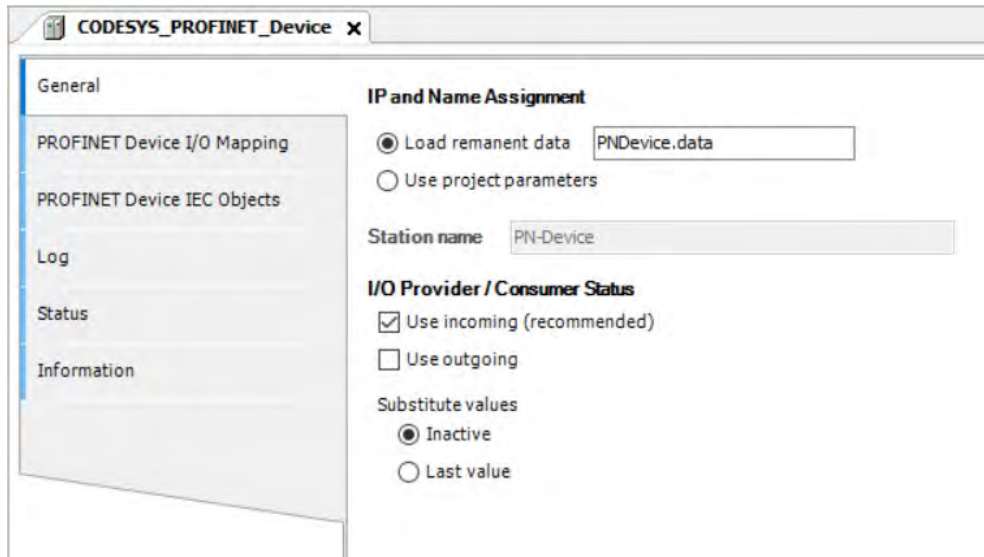

- **IP and Name Assignment**

Setting Item	Description
Load remanent data	The IP Address and Station Name of PROFINET Device are determined by the "PNDDDevice.data" from the controller. Defaults: <ul style="list-style-type: none"> ● IP: 0.0.0.0 ● Station name: Leave it blank.
Use project parameters	The IP address of the PROFINET Device is the same as the controllers IP address, and the Station Name can be set through this page. (Do not use this option.)

- **PROFINET Device IEC Objects**

This page displays the current status and number of connections of the PROFINET Device.

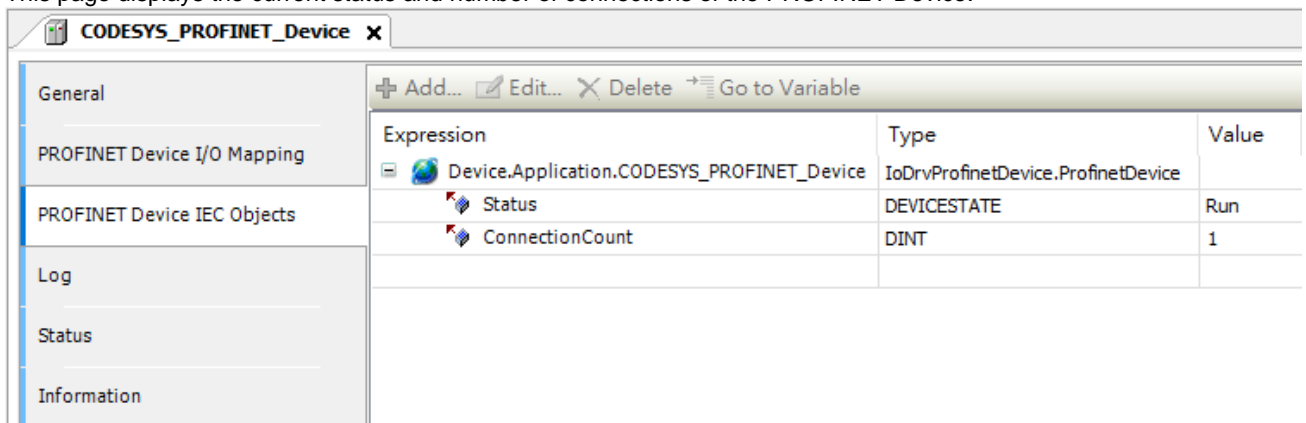

● **Status**

You can check the running status of the PROFINET Device on this page, including IP address, Station Name, time intervals for packet transmission, and many more to help you get to know the current operation.

The screenshot shows the CODESYS_PROFINET_Device interface. On the left is a navigation menu with options: General, PROFINET Device I/O Mapping, PROFINET Device IEC Objects, Log, Status, and Information. The main area is divided into two sections. The top section, 'Diagnosis data', shows a 'Module' list with three entries: (Subslot 0x0001), (Subslot 0x8000), and (Subslot 0x8001). The bottom section, 'PROFINET-Ethernet', shows a status of 'Running'. Below this is a 'Last diagnostic message' table with two columns: 'Driver Diag' and 'PROFINET IO Device Driver diagnostic information'. The table lists various parameters such as PN-Device Status, Connections, Online, IP Active, Stationname, IPParameter (IP, Netmask, Gateway), Ethernet Statistic (Received Frames, Received RT-Frames, Invalid Cyclic Frames, Send Errors, Recv Time, Send Time), Link Status, and MAUType.

Driver Diag	PROFINET IO Device Driver diagnostic information
PN-Device Status	Run
Connections	1
Online	TRUE
IP Active	TRUE
Stationname	'device1'
IPParameter	currently active IP-Settings
IP	[192,168,1,6]
Netmask	[255,255,255,0]
Gateway	[192,168,1,6]
Ethernet Statistic	
Received Frames	947192
Received RT-Frames	919175
Invalid Cyclic Frames	0
Send Errors	0
Recv Time (Avg)	LTIME#22us893ns
Recv Time (Max)	LTIME#234us124ns
Send Time (Avg)	LTIME#19us620ns
Send Time (Max)	LTIME#191us208ns
Link Status	Up
MAUType	1000BASE-T full duplex mode

9.3.5.1.3 Export GSDML File

This section introduces how to export a GSDML file.

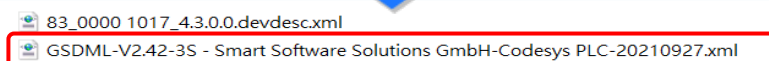
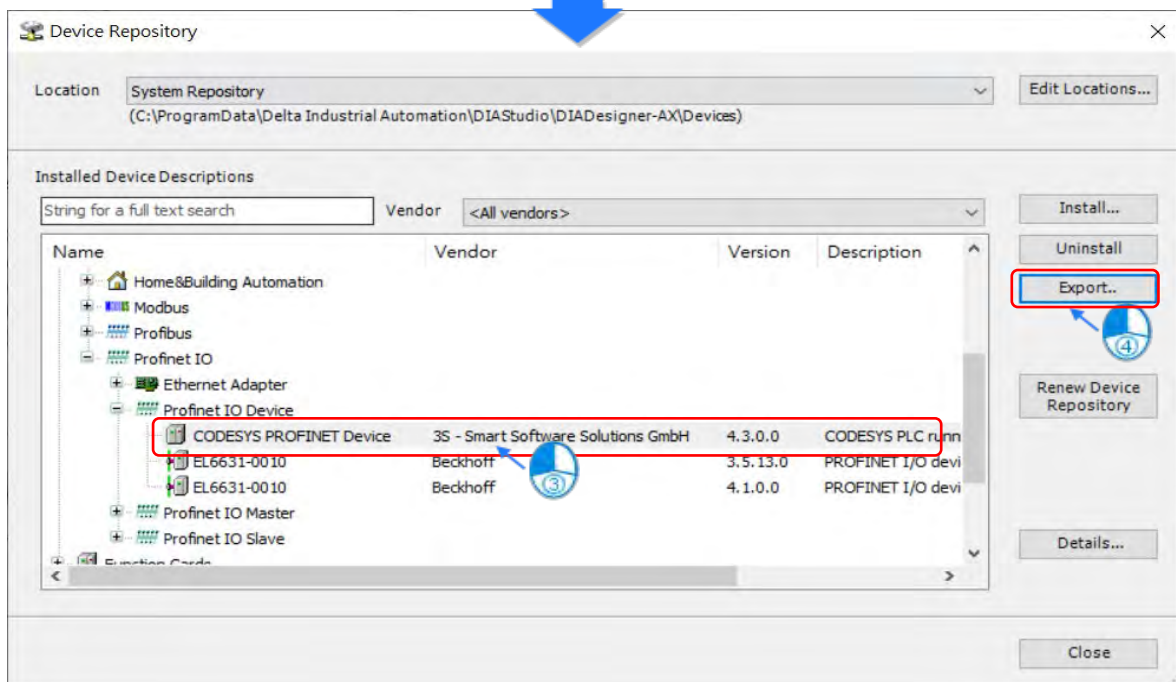
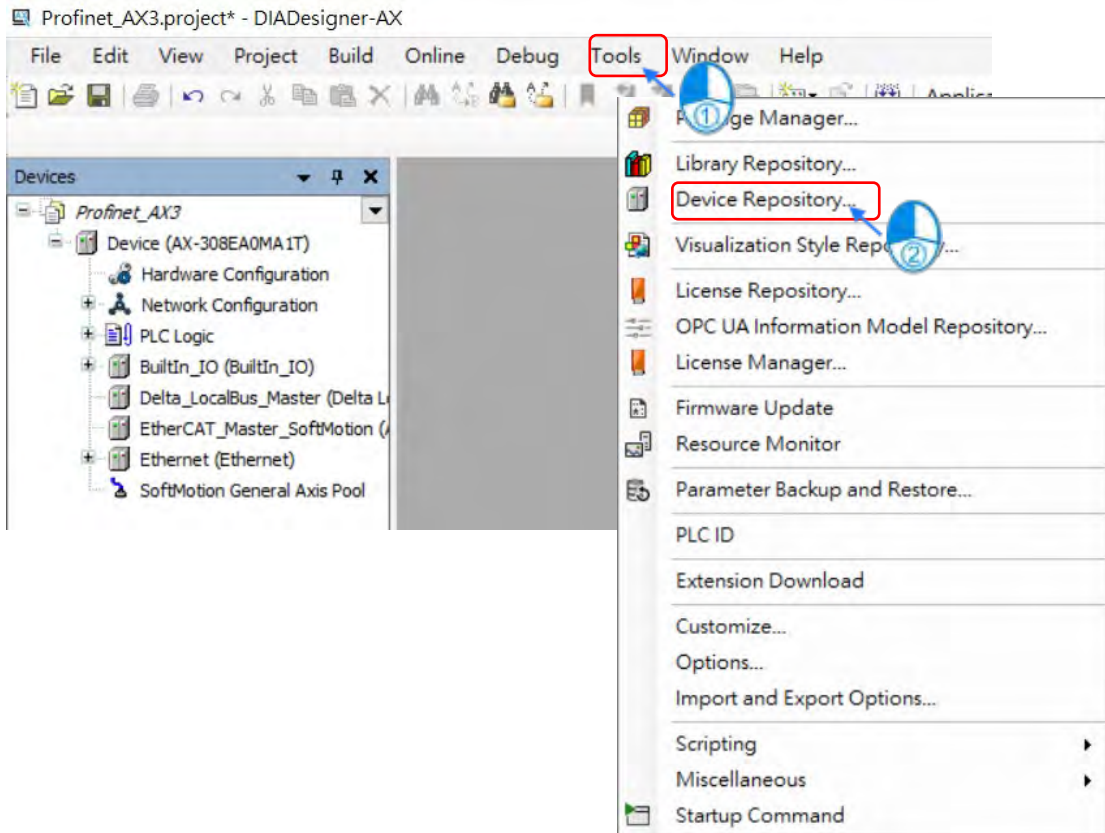

9.4 EtherNet/IP

DIADesigner-AX supports the following Modbus network types, including Modbus TCP and EtherNet/IP. Follow the below section to set up the basic settings for communication via the Ethernet Adapter.

The compatibility of the firmware version of AX-3 Series PLC CPU and the version of the EtherCAT function library:

Firmware Version	IODrvEtherCAT 3.5.15.30	IODrvEtherCAT 4.4.0.0
V1.0.4.2 or previous	Compatible	Incompatible
V1.0.5.0 or later	Compatible	Compatible

9.4.1 Introduction to EtherNet/IP

9.4.1.1 EtherNet/IP Overview

Ethernet Industrial Protocol (EtherNet/IP) is an open industrial networking standard, managed by ODVA (Open DeviceNet Vendors Association).

EtherNet/IP works on a TCP/UDP/IP based Ethernet network and uses most widely deployed collections of Ethernet standards to provide a broad range of applications in different industries that require high-speed and stability including Factory Automation (FA), Building Automation (BA), Process Automation (PA) and many more.

Delta covers a full range of controller and drive products supported by EtherNet/IP, including Programmable Logic Controllers (PLC), inverters, Human Machine Interfaces (HMI) and so on. Refer to section 9.4.5 for a full product list supported by EtherNet/IP. In addition, users can also use the EDS file to connect to the EtherNet/IP devices of other brands.

9.4.1.2 Definition

Term	Definition
ODVA	Open DeviceNet Vendor Association for EtherNet/IP
EIP	EtherNet/IP, an industrial Ethernet network, provides interoperability for system providers. IP stands for Industrial Protocol. The term "EIP" (EtherNet/IP) will be used throughout this manual.
I/O Connection	Via the I/O connection to connect to EtherNet/IP and to exchange data cyclically
Explicit Message	Connect to EtherNet/IP and to exchange data non-cyclically. Data will be exchanged piece by piece via instructions.
RPI	Requested Packet Interval, via the I/O connection to connect to EtherNet/IP to exchange data at regular time intervals
ACD	Address Conflict Detection to detect IP address duplications.
P/C TAG	Produced / Consumed TAG. A produced TAG sends its data to consumed TAGs (consumers) without using logic. TAGs are the methods used for assigning and referencing memory locations for Rockwell PLCs, the same as the registers for Delta PLCs.
EDS	Electronic Data Sheets; EDS files are simple text files used by EtherNet/IP network configuration

	tools to help you identify EtherNet/IP products and easily commission them on a network.
Data Mapping	Exchange data between devices.
EIP Scanner	The master station is called Scanner in EtherNet/IP.
EIP Adapter	The slave station is called Adapter in EtherNet/IP.
MODBUS TCP	MODBUS TCP is a MODBUS communication protocol, widely used on Ethernet.

9.4.1.3 Features of Ethernet

9.4.1.3.1 Delta EIP Architecture

This typical Delta EIP architecture includes EIP Scanner and Adapter; data mapping can be achieved between devices via an I/O connection and explicit message.

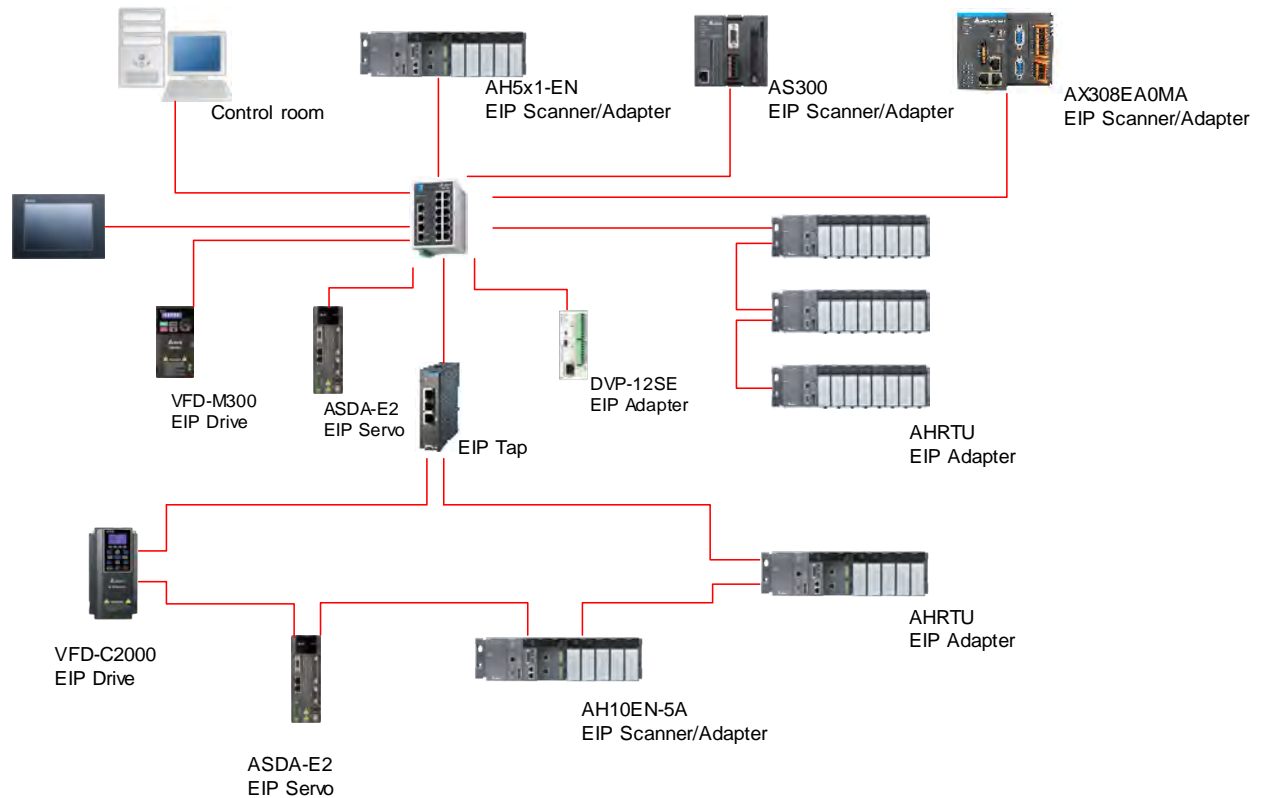

9.4.1.3.2 Features of EIP

- Flexibility
 - Flexible topology: EIP devices may include an Ethernet single port as well as Ethernet dual port, and provide applicable networks such as linear topology, ring topology and ring topology for faster expansion and easier management.
 - Network compatible: IT specialists are not required for Internet connection setup, while the Wi-Fi connection is provided.

- Simplicity
 - Via a connector: Delta provides a full range of product line, including human machine interfaces (HMI), programmable logic controllers (PLC) and inverter drives, for application in an industrial operation. Simply via a RJ-45 connector, a network can be built up, saving costs on cables and other connecting tools.
 - Single network: In replace with the 3-tier industrial architecture, single network architecture provides 100Mbps high-speed cyclical and non-cyclical data mapping function, ensuring a complete network diagnosis and effectively shortening debugging time.

9.4.2 EtherNet/IP Scanner Function

9.4.2.1 Setting up Compact Drive MS300

9.4.2.1.1 Hardware Configuration

This application example is to connect AX-308E to compact drive MS300 and CMM-EIP communication card via Ethernet.

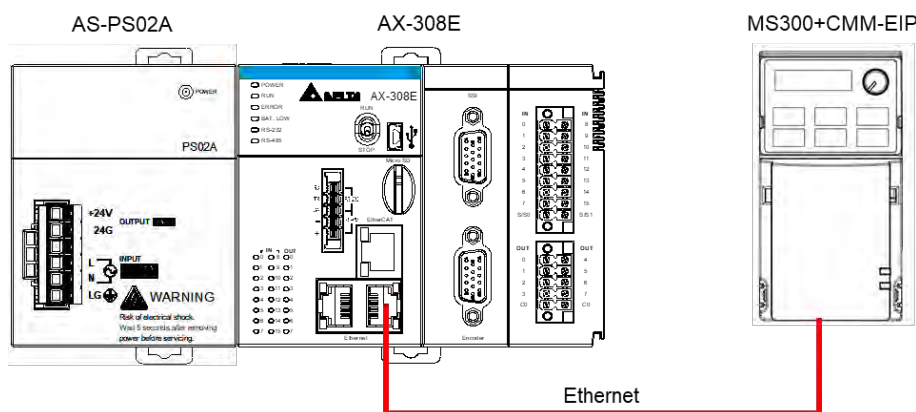

Note: The version of CMM-EIP communication card should be V2.04.01 or above.

9.4.2.1.2 Read-Write Setting for Implicit Messages

Map the read/write address to the register in option card via the master station (Scanner) to exchange data cyclically and one-time read/write data via the register for implicit messages in EtherNet/IP.

- To use compact drives with EIP communication card

- Drive's settings

Make sure you've changed the control settings of the drive to option cards before operating compact drives via internet by using option cards. Refer to the following steps to configure the settings.

1. When the option card is attached, check if parameters 09 to 60 are null, which the value should be displayed as 5 (EtherNet/IP).
2. Set parameter 09-75=0 (static IP) and the IP address is user-defined.
3. Change the IP address of option card to 192.168.1.30 (default is 192.168.1.5) from parameter 09-76 to parameter 09-79. Then set parameter 09-91 to 2.
4. Set parameter 00-20 to 8 (Set the source for AUTO frequency command to communication card.).
5. Set parameter 00-21 to 5 (Set the source for AUTO control to communication card.).

6. Set parameter 09-30 to 1 (Set communication decoding method to 60xx or 20xx, which the decoding methods are detailed in section 4.2 EtherNet/IP Control Method Standard of VFD EtherNet/IP Application Manual.)

- Example for creating EIP

The IP address of the devices applied in this example are shown as follows:

Devices	AX-308E	192.168.1.5 (default)
	MS300* CMM-EIP02	192.168.1.30

1. Create Ethernet Device

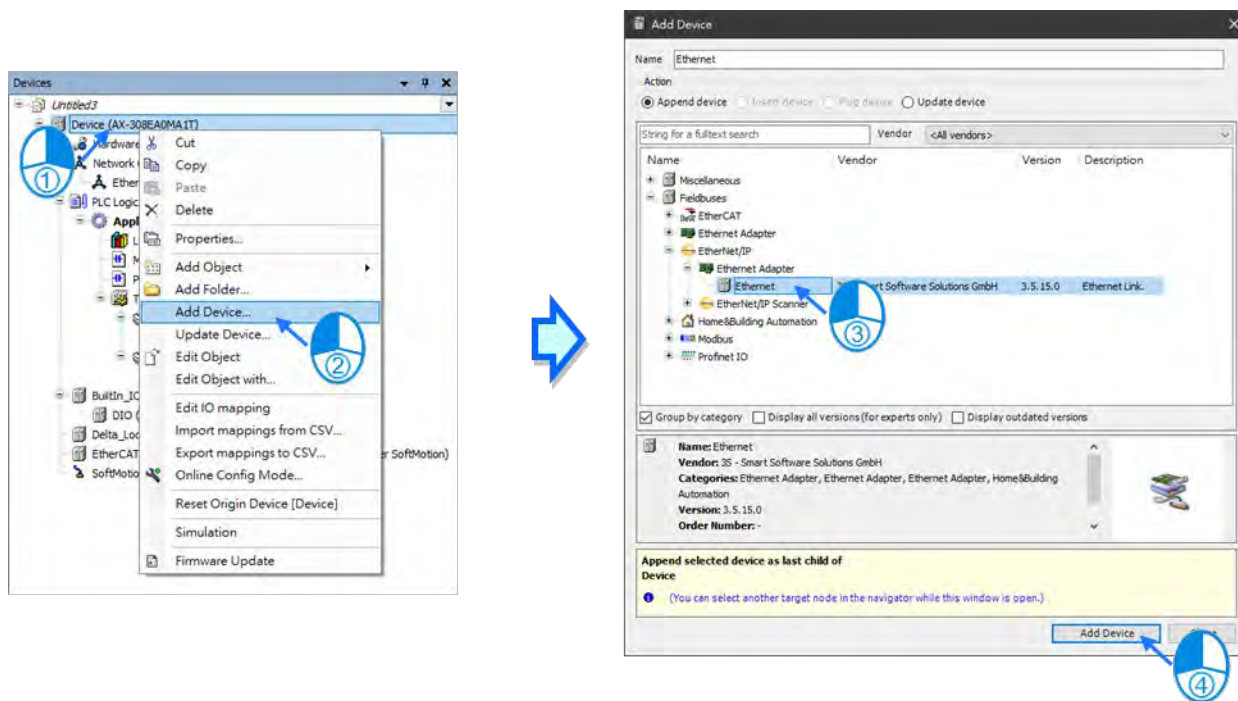

2. Create Interface. Go to Ethernet -> General.

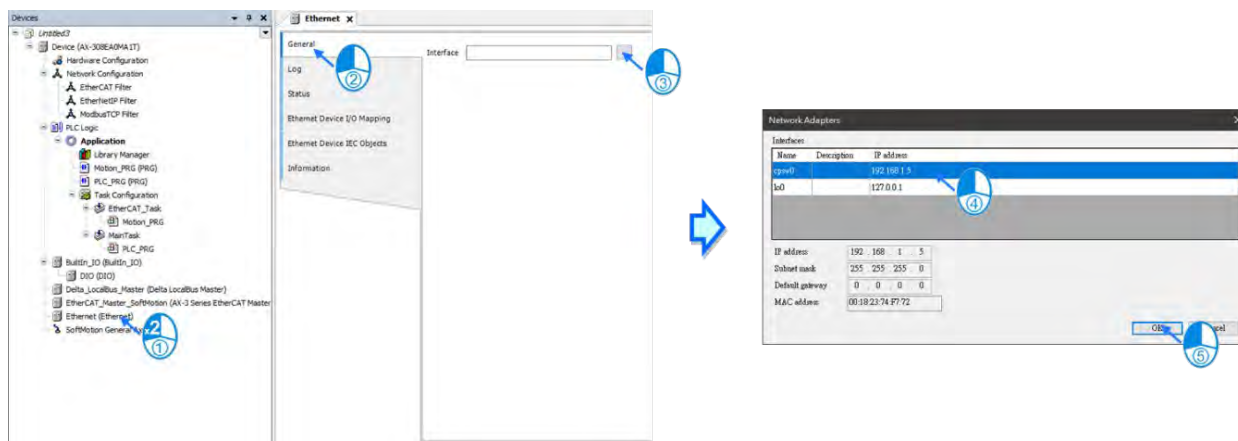

3. Create EtherNet/IP Scanner.

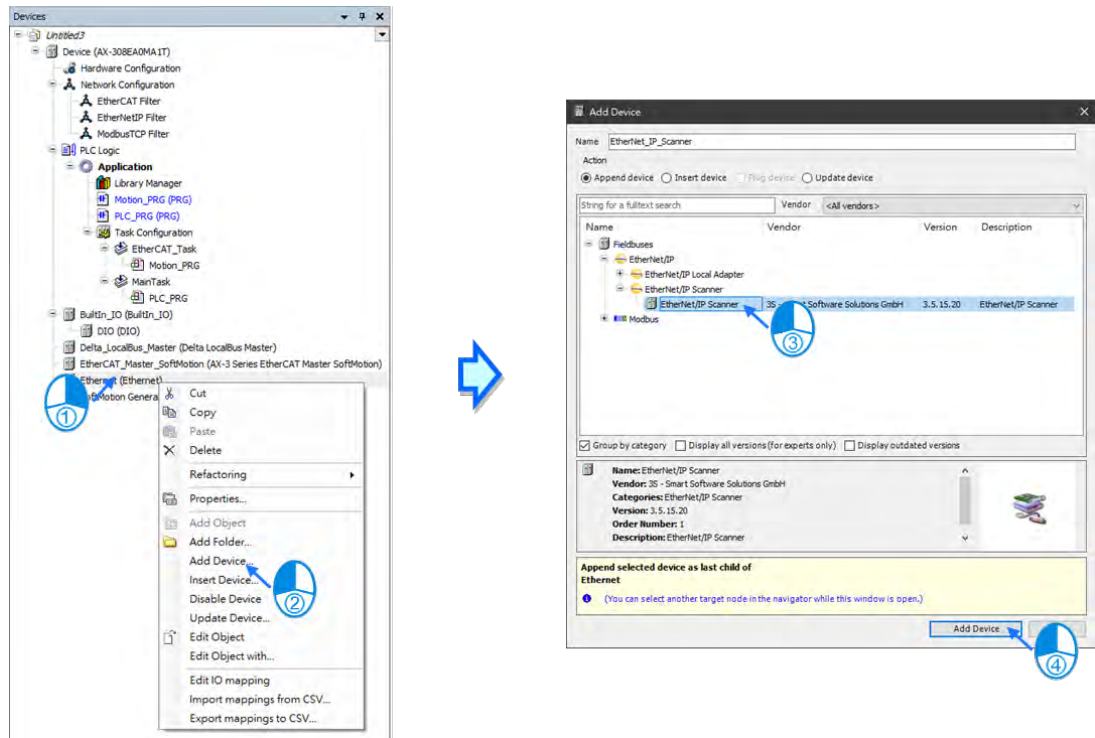

4. Create CMM-EIP0102. Right click on Ethernet and select Add Device to choose the relevant adapter.

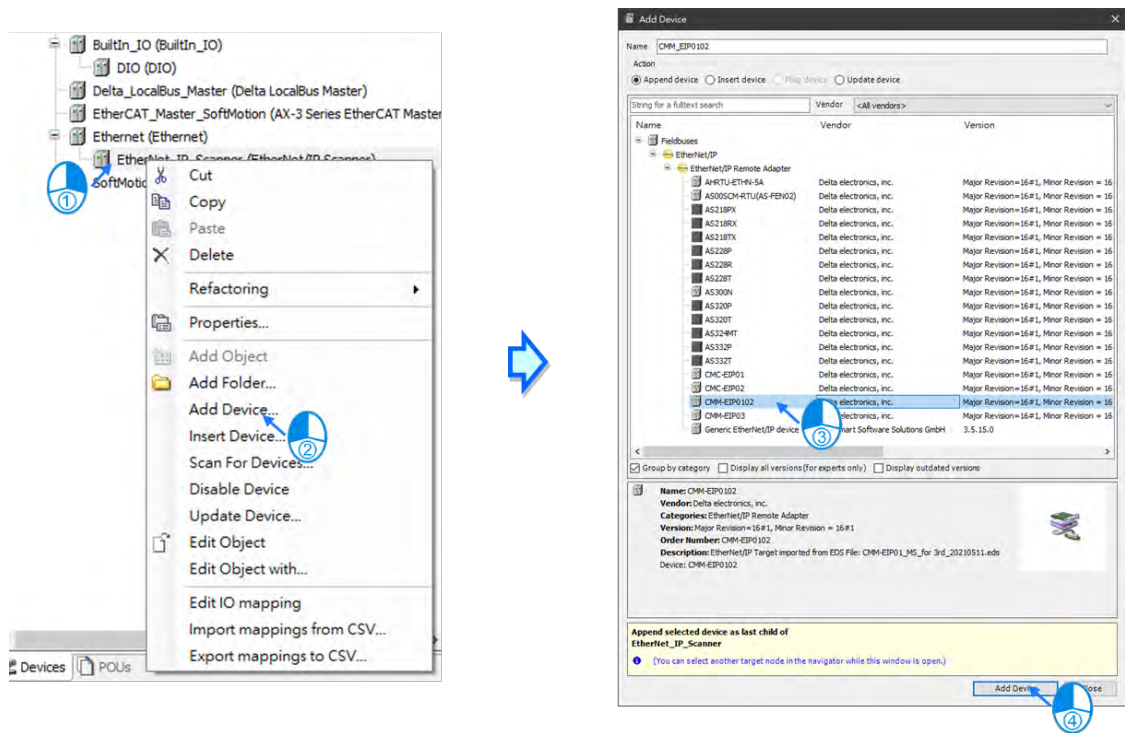

*Note: Adapters can be created via "Scan For Device".

- Click on CMM_EIP0102.

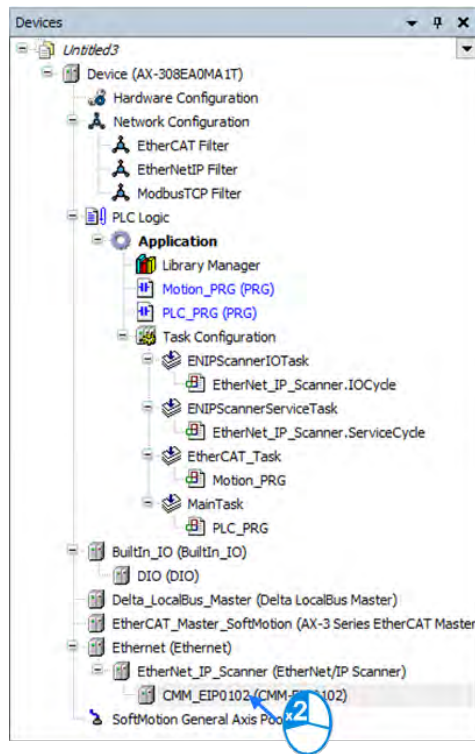

- Go to General and set IP Address to 192.168.1.30.

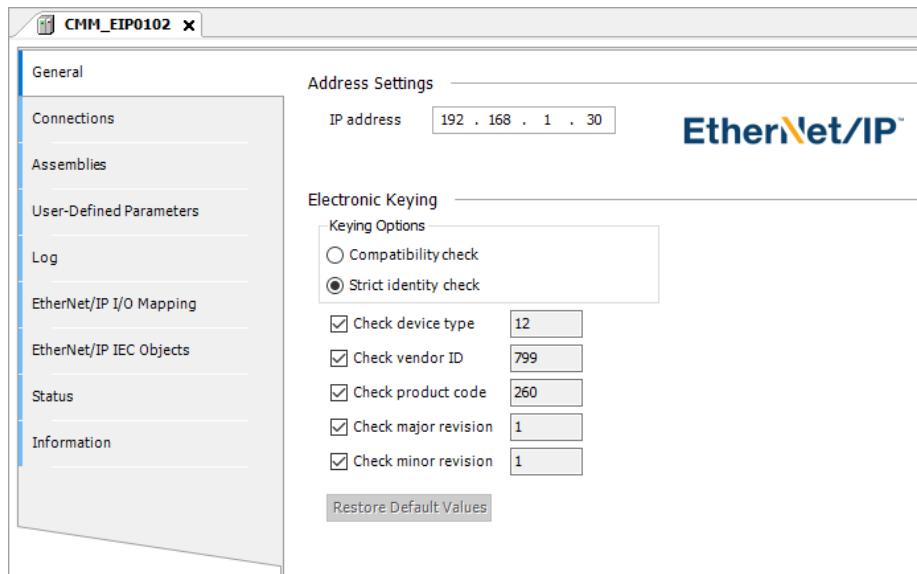

Item	Description
IP address	The IP address of the target device.
Compatibility check	Check the compatibility between the target device and information of EDS files.
Strict identity check	Strickly check the information of the target device and EDS files. Inspection information is user-defined.
Check Device type	Check the device type.
Check Vendor ID	Vendor ID
Check Product code*	Product code*
Check Major revision	Major revision
Check Minor revision	Minor revision

*Note: If Adapter and Scanner are required at the same time, please unselect Check Product code.

7. Go to EtherNet/IP I/O Mapping and add variable name for channels of Operation Command 2, Control Mode 2 and Frequency command 2.

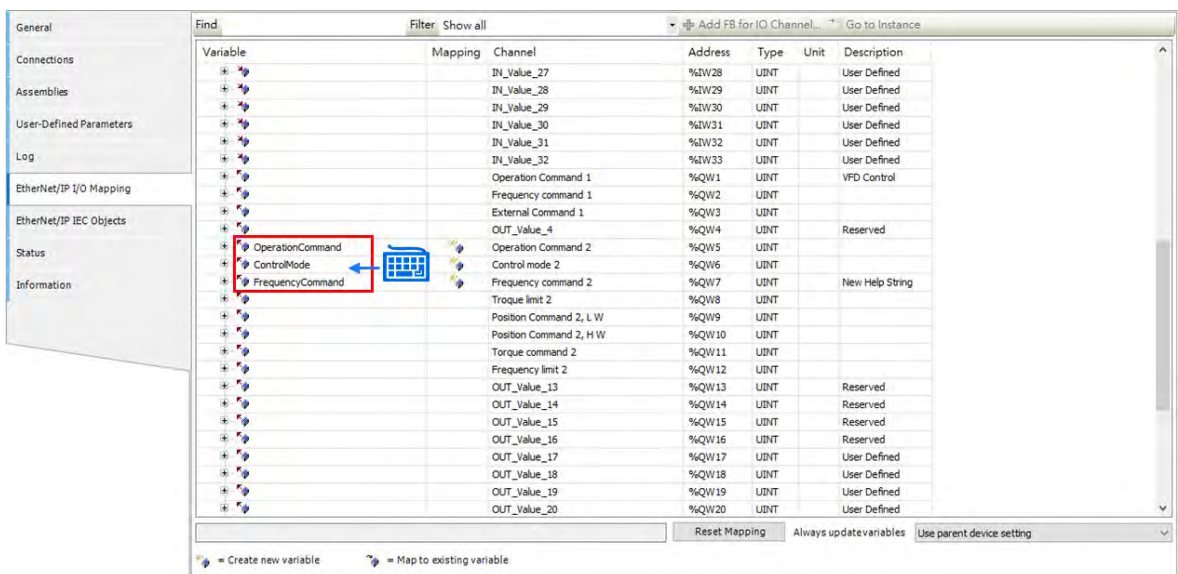

8. Select Motion_PRG to add programs as shown below.

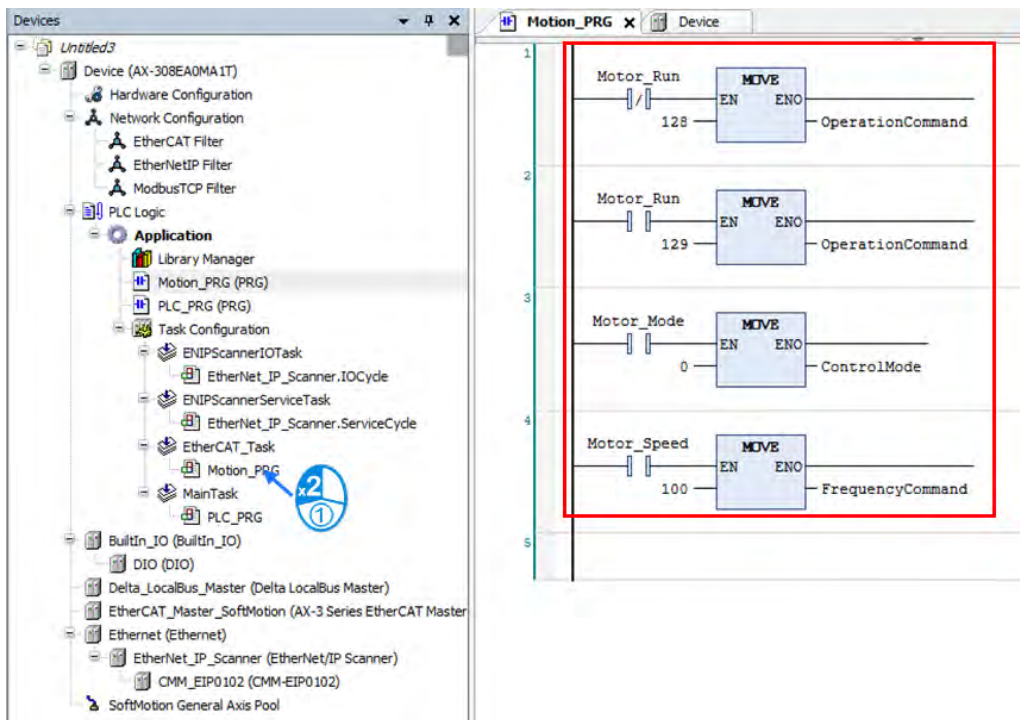

9. Implement the following procedure with online monitoring:

- ① Turn on Motor_Mode.
- ② Execute Motor_Speed and write 100 to the speed. (The unit is Hz; value is in two decimal places. For example, write 100 to get 1.00 Hz.)
- ③ Write in 129 to execute Motor_Run, while value 128 is for excitation.

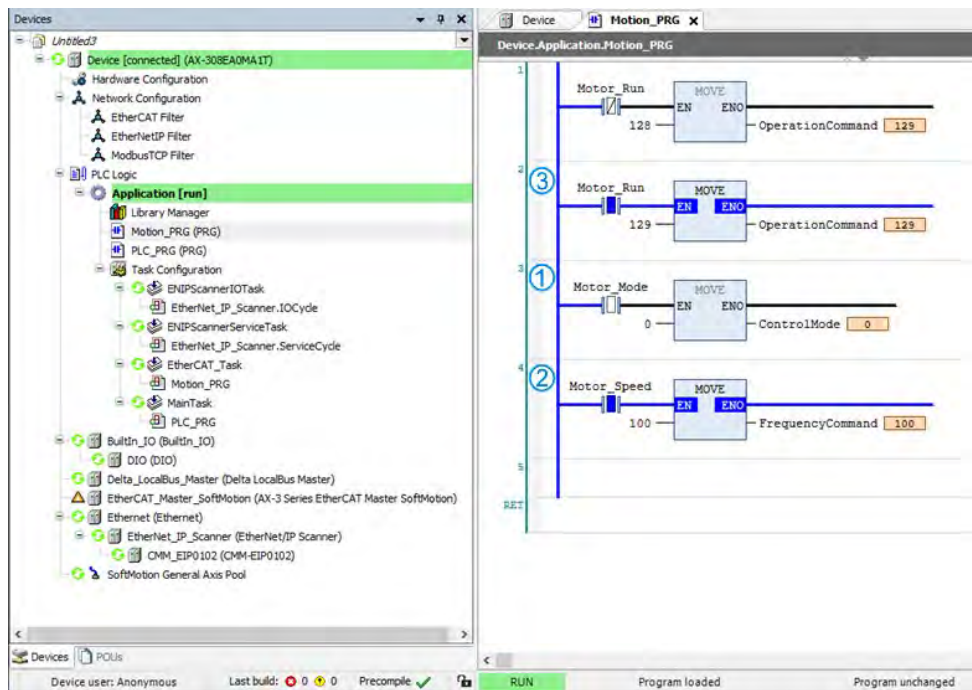

*Note: Information concerning CMM-EIP parameters are detailed in VFD EtherNet/IP Application Manual.

9.4.2.1.3 CIP Object Read-Write Setting for Explicit Messages

Please refer to Appendix A <EtherNet/IP Service and Object> in VFD EtherNet/IP Application Manual to check the objects supported by the option card and make sure to understand read-write methods for explicit messages before using this function. The master is allowed to configure the setting values of drives directly with the relevant Object Class address. The object class code is 0x300 for drives and the address is formatted as the following shown.

● EIP communication data format

Object class Instance Attribute
 0x300 + Pr. Group + Pr. Number

● Read-write example

To read and write parameter 09-30 (Decoding with Ethernet/IP)

- Declare function blocks and variables

```
PROGRAM PLC_PRG
VAR
    Get_Attribute_Single_0: ENIP.Get_Attribute_Single;
    Set_Attribute_Single_0: ENIP.Set_Attribute_Single;
    getsingledata: ARRAY[0..999] OF BYTE;
    setsingledata: ARRAY[0..999] OF BYTE;
END_VAR
```

- Read parameter 9-30 via the function block as shown below.

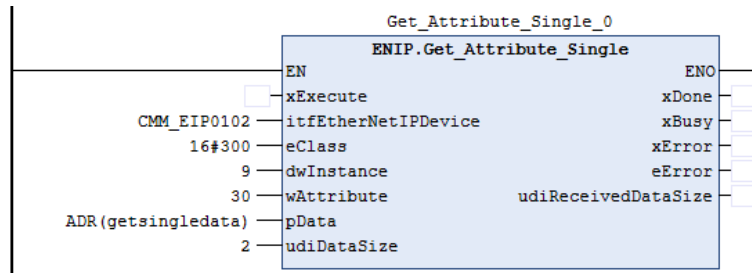

- Write 1 to parameter 9-30 via the function block as shown below.

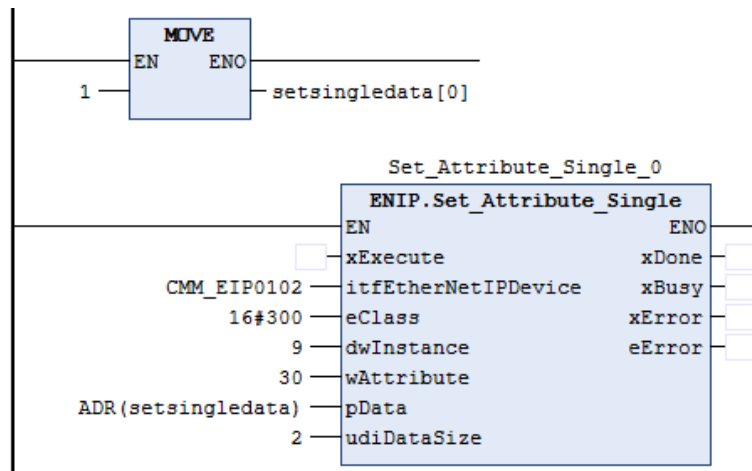

9.4.2.2 Read-Write to AS00SCM-A (AS-FEN02 Communication Card)

The way to connect AS00SCM-RTU (AS-FEN02) via EtherNet/IP would be explained in this section. Please do read chapter 9 “Serial Communication Module AS00SCM” in AS Series Module Manual to understand the related settings and application of this module before actual operation.

Setup Steps:

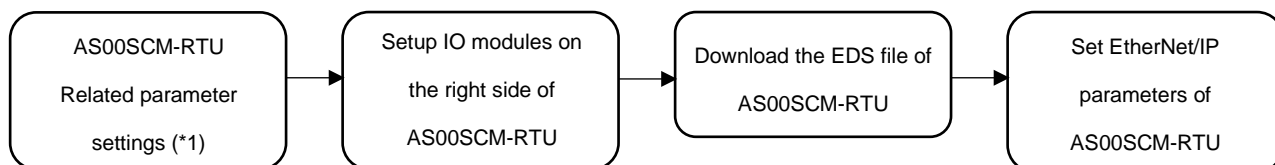

*1: Please refer to chapter 9 “Serial Communication Module AS00SCM” in AS Series Module Manual for more details concerning setups of AS00SCM-A IP address and RTU mode.

9.4.2.2.1 Setup IO modules on AS00SCM-RTU

Before connecting to AS00SCM-RTU (AS-FEN02), it is necessary to setup the IO modules on the right side of AS00SCM-RTU (AS-FEN02) by using EIP Builder software on your PC.

- Steps to operate the software EIP Builder are shown below.
- Add the remote module to the hardware configuration manually or via Scan for Devices. Click on the remote module to open HWCONFIG so as to scan and download the IO module on the right side.

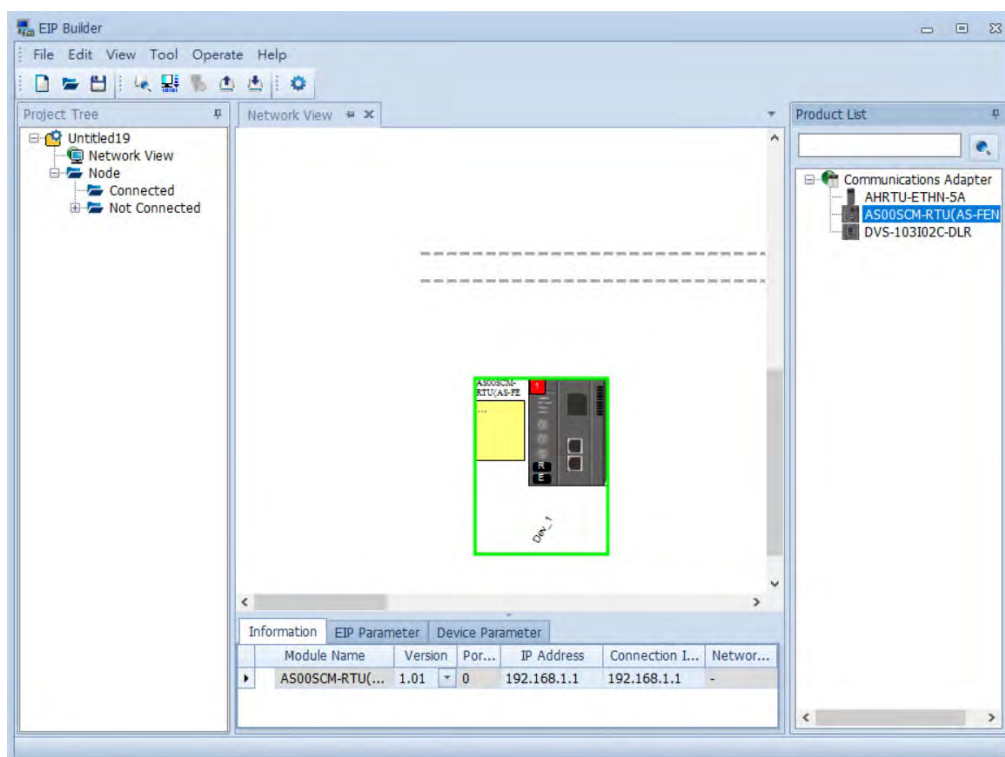

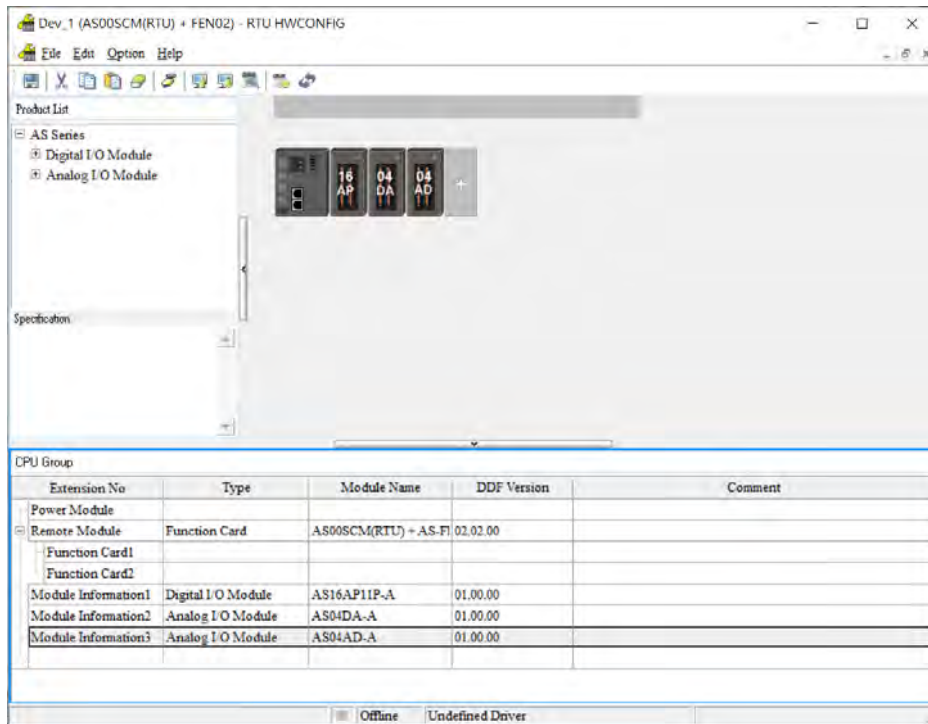

- Data would be exchanged according to the sequence in the Normal Exchange Area on the third-party device. Take AS04DA-A for example, the first input value is an error code (All the error codes of the module are input values, which are defined to be transmitted from the remote module to the scanner). The data type of the first to the fourth value output from channel 1 to 4 are REAL.

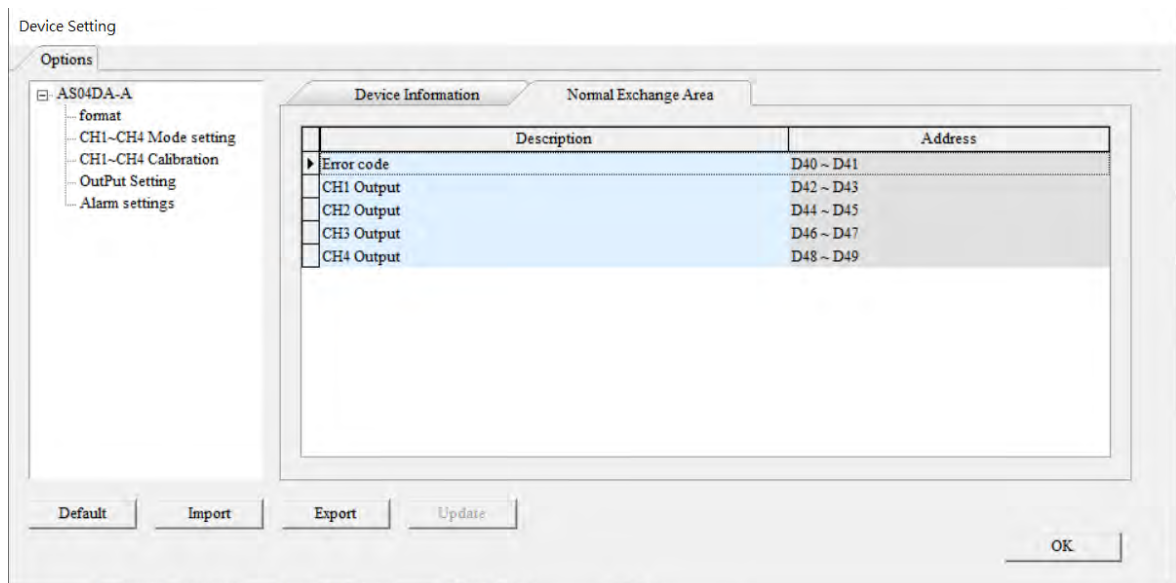

9.4.2.2.2 Download the EDS File of AS00SCM-RTU

Please download the EDS file of AS00SCM-RTU module from Delta's official website.

1. Download the EDS file.
 - 1.1 Open Device Repository.

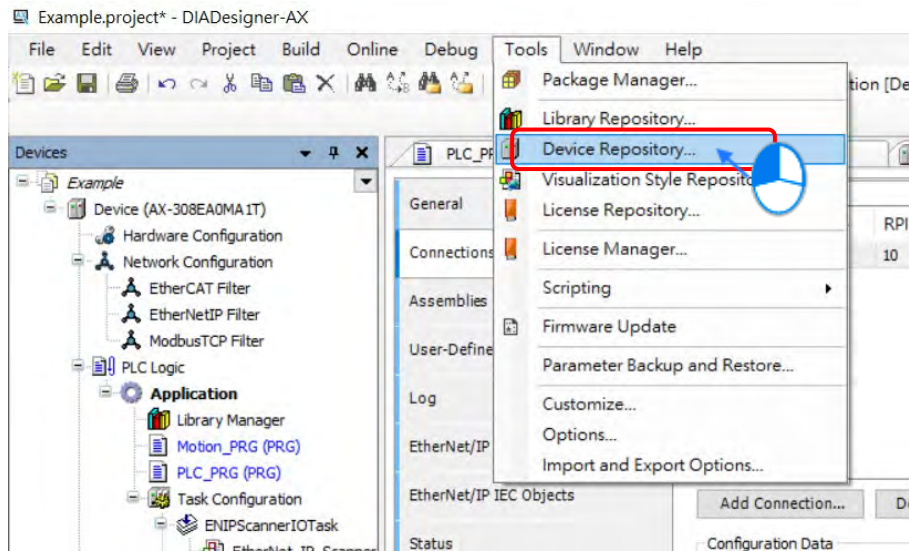

- 1.2 Choose the target EDS file.

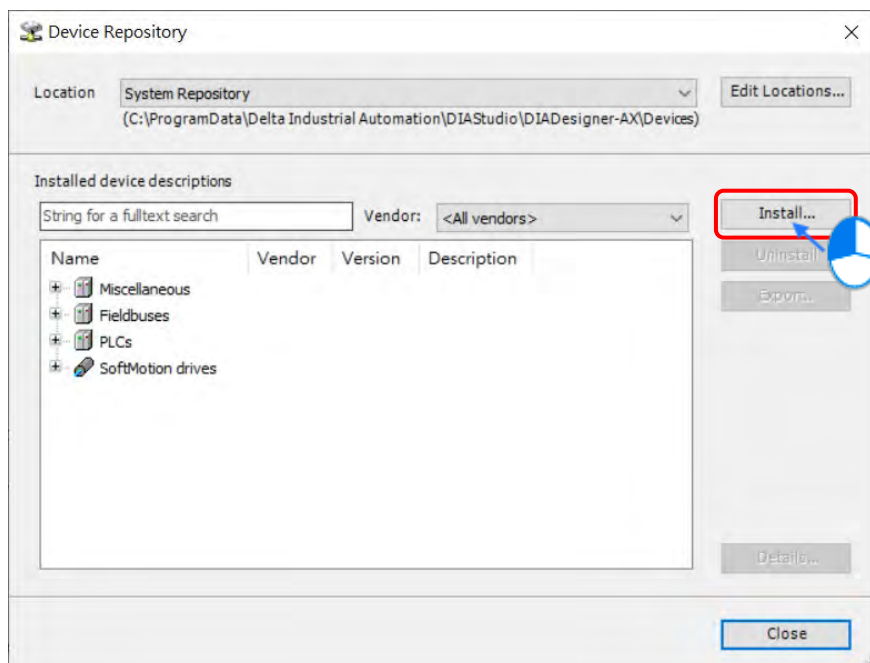

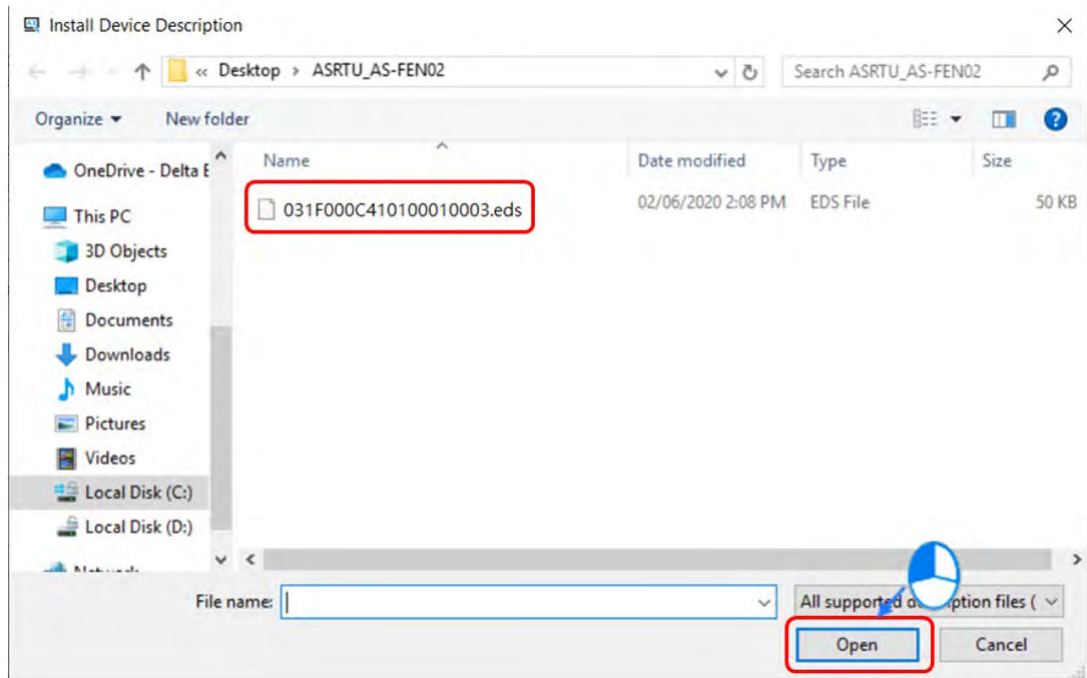

1.3 The download is complete.

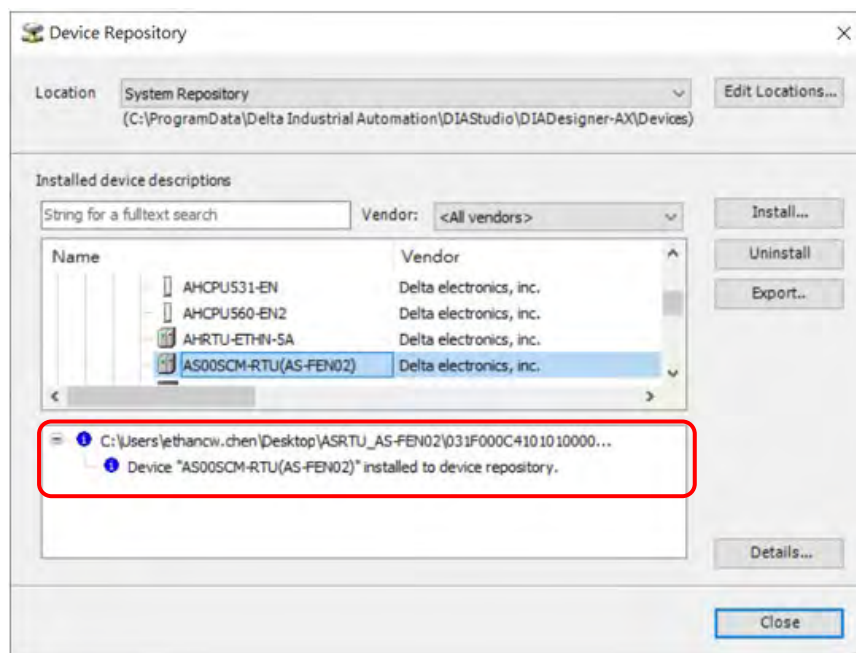

2. After the download is complete, you are allowed to add the AS00SCM-RTU device.

2.1 Add Ethernet device

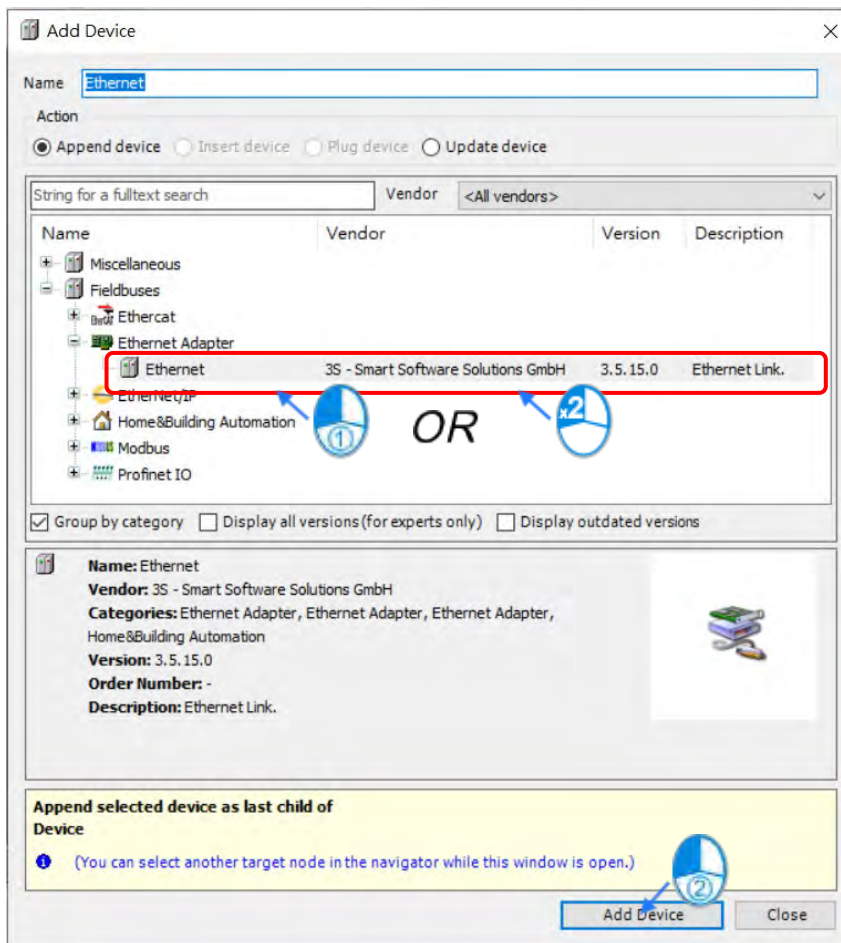
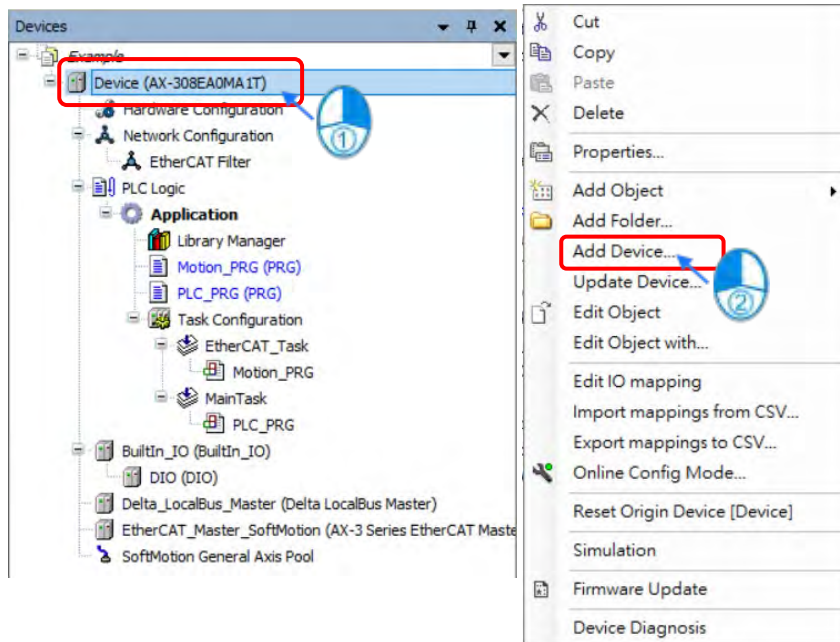

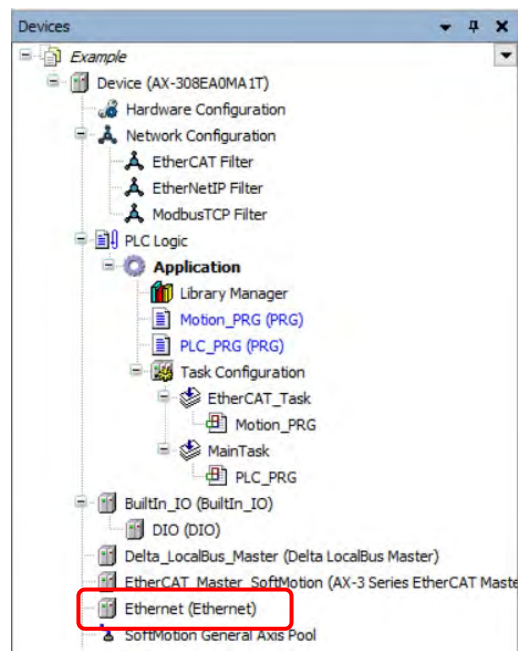

2.2 Select the desired network interface.

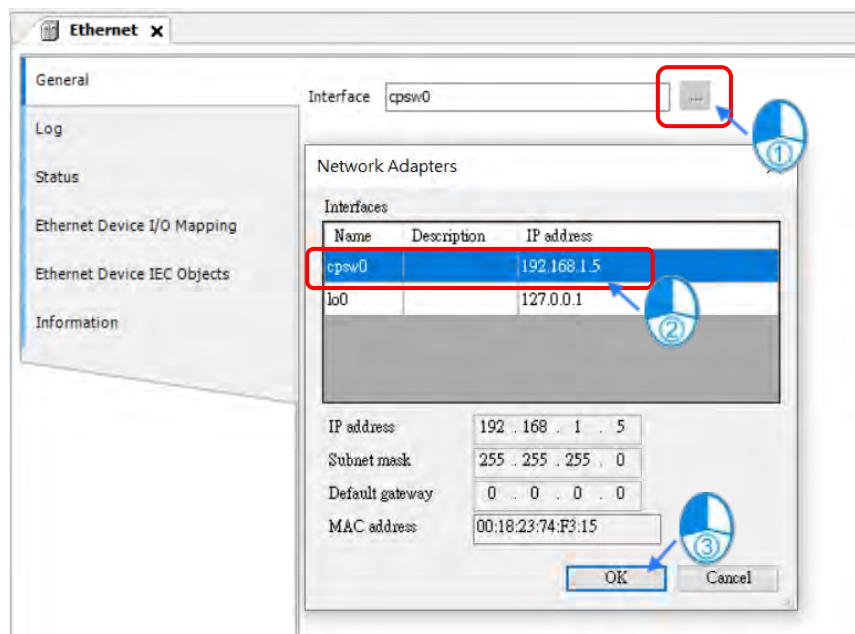

2.3 Add EtherNet/IP Scanner device.

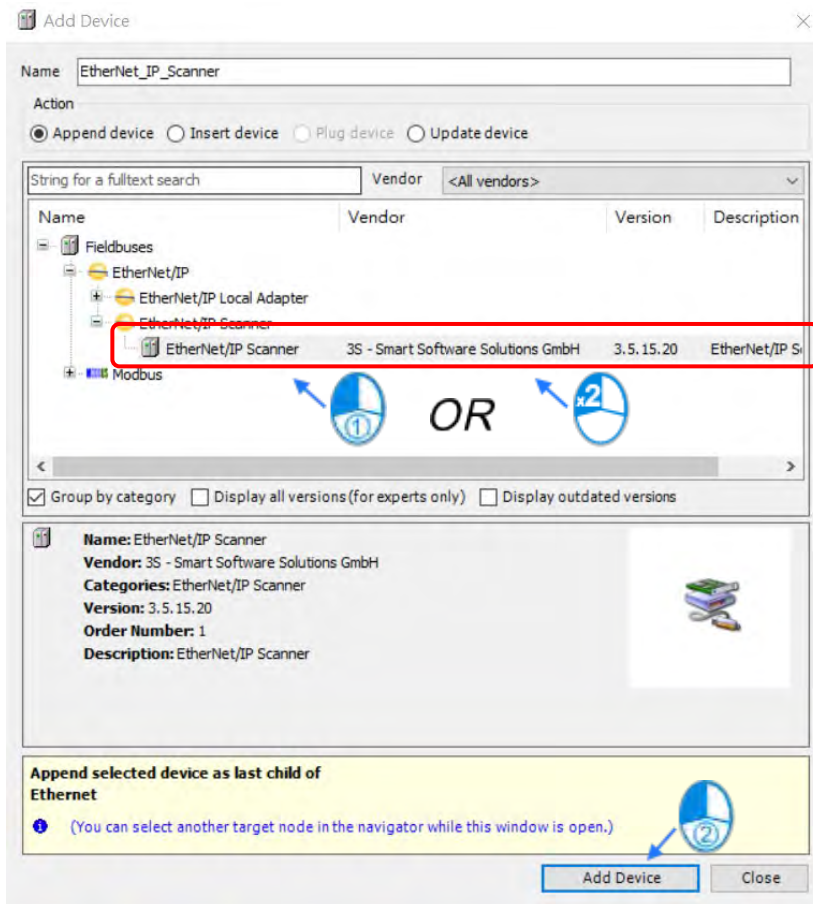
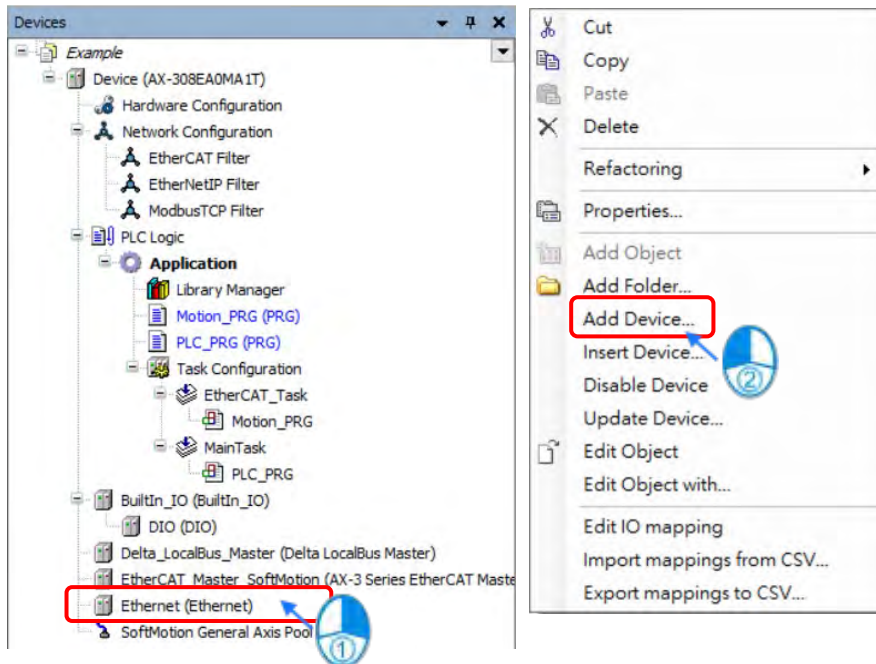

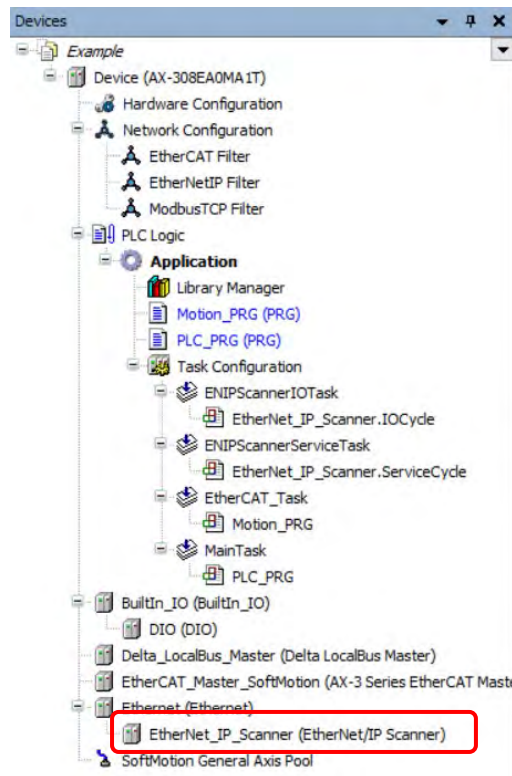

2.4 Add EtherNet/IP Adapter (AS00SCM-RTU).

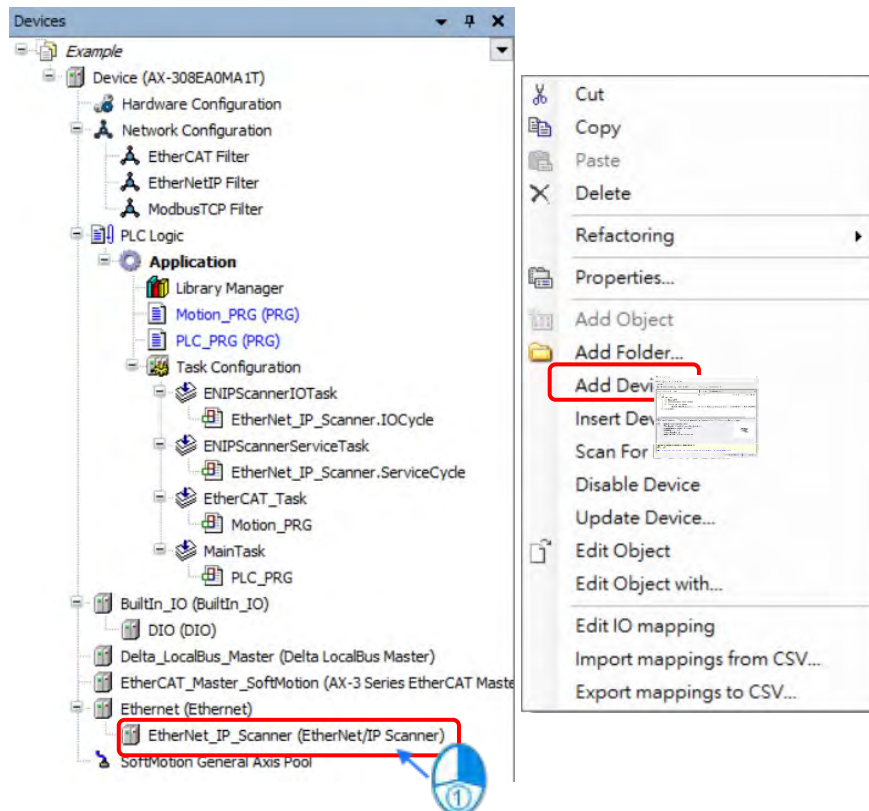

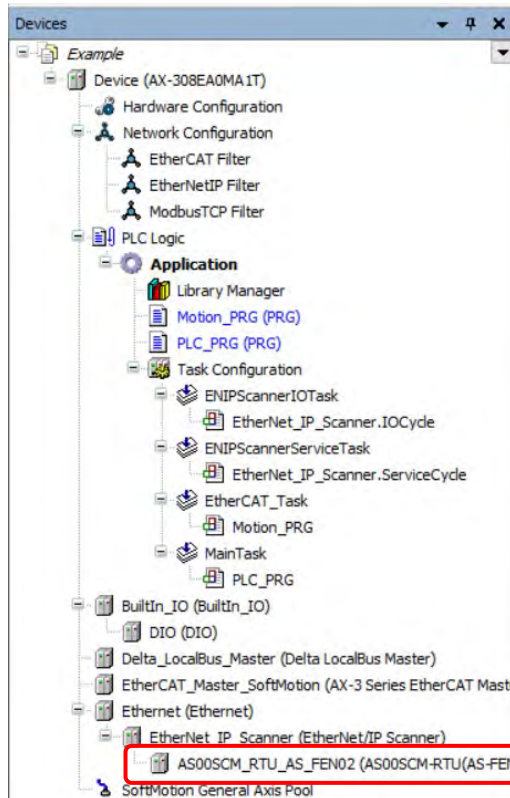
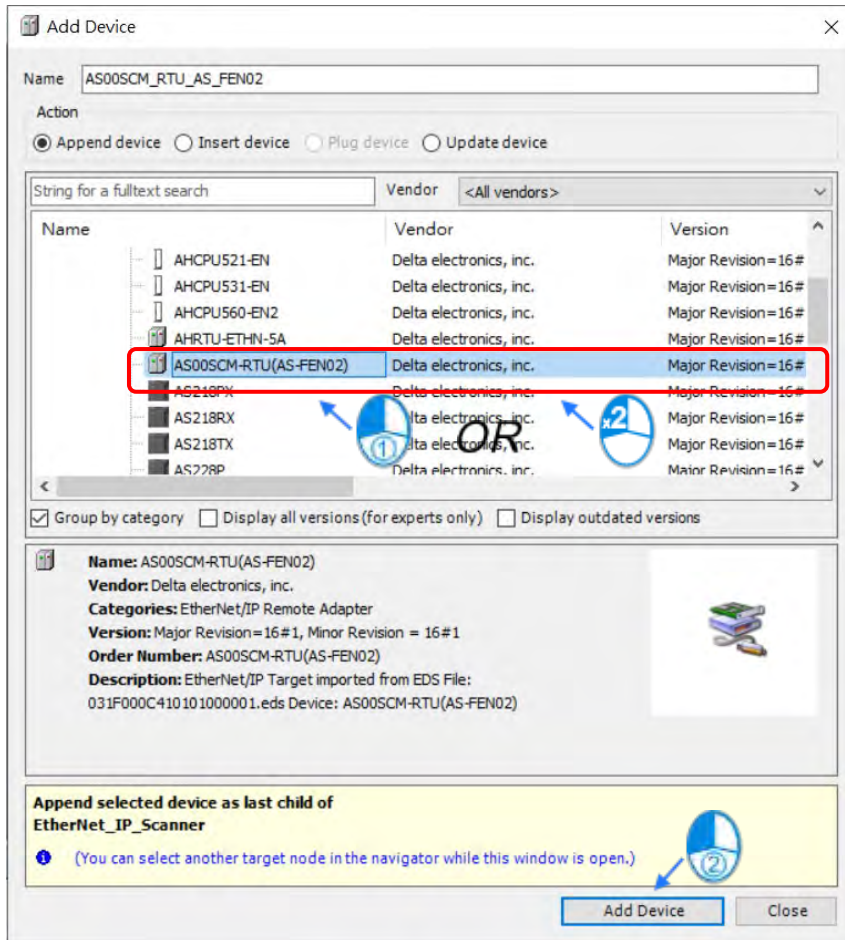

9.4.2.2.3 Configure EtherNet/IP Parameters of AS00SCM-RTU

You are allowed to open the parameter setting page or download the settings from AS00SCM-RTU device so as to start the operation with the IO module.

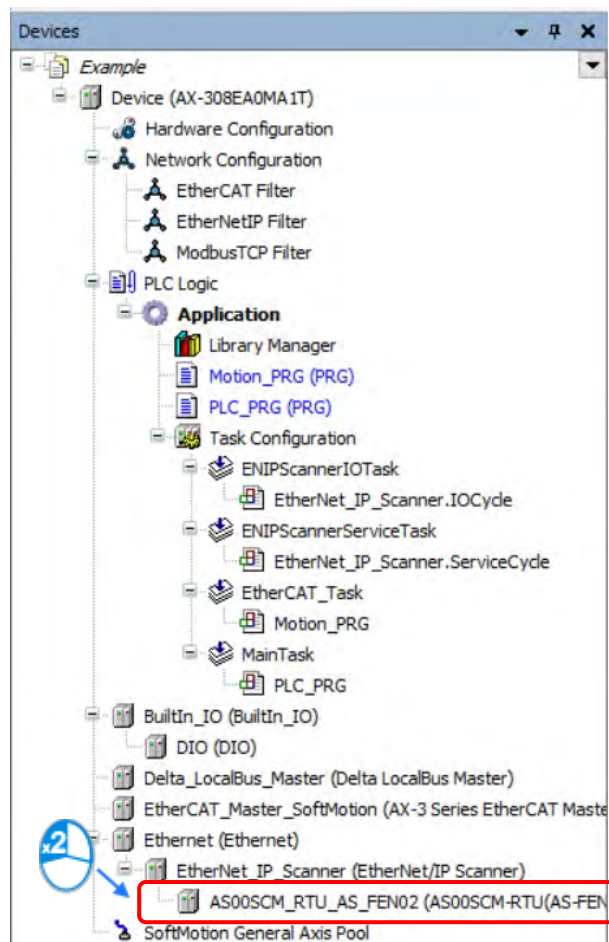

1. Set the IP address of AS00SCM-RTU.

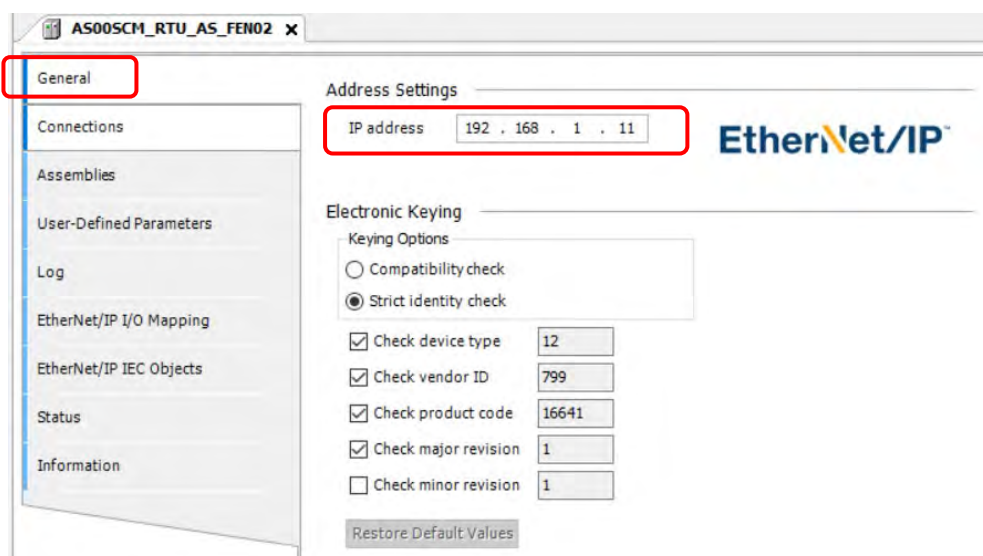

- Set Connection parameters for EtherNet/IP, which should be configured according to the actual IO module. (Refer to section 9.4.2.2.1 for more details of parameter settings.)

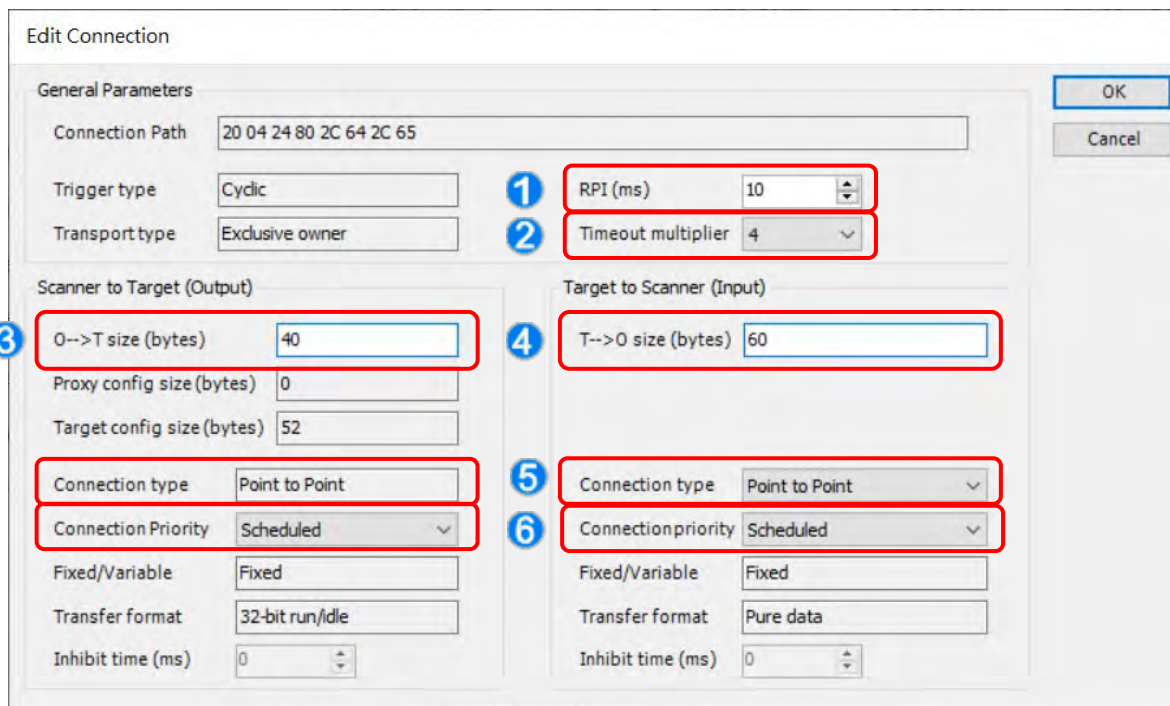
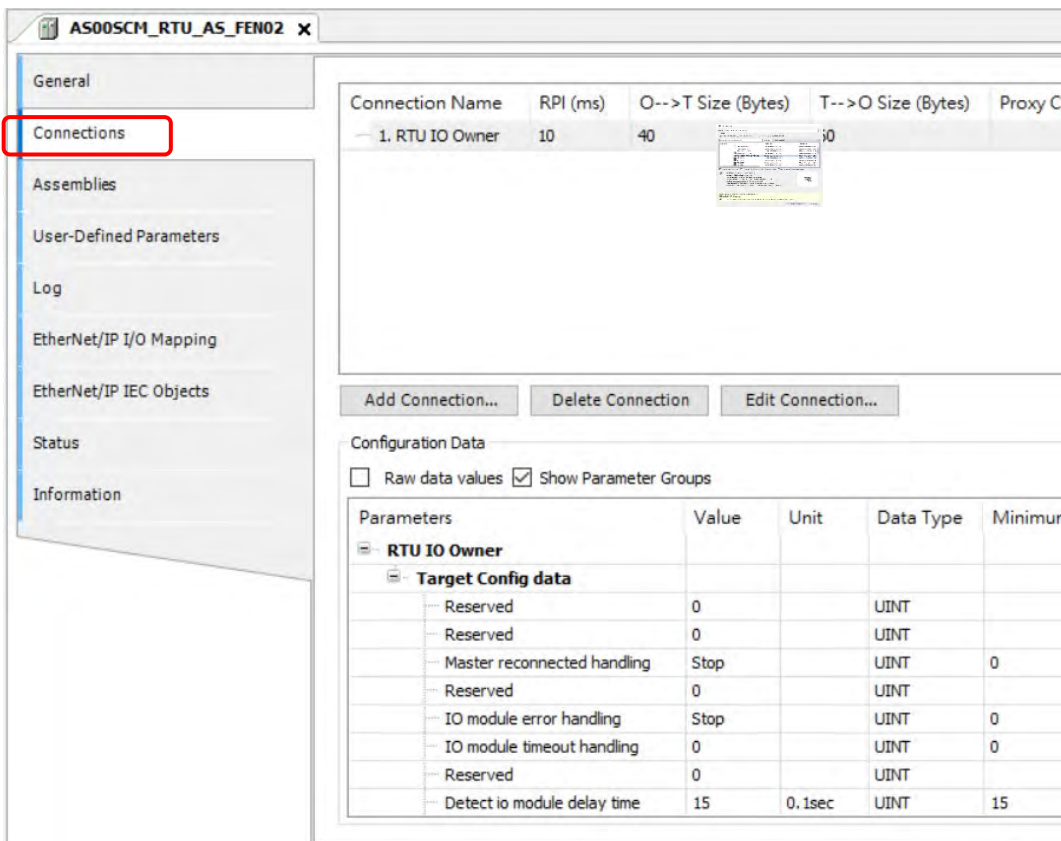

- ①: RPI: Requested Packet Interval. Connect to EtherNet/IP to exchange data at regular time intervals via the IO connection.
- ②: Timeout multiplier: Set up the timeout time according to the RPI or the multiple of RPI.
- ③: O → T size (bytes): The length of the data transmitted from the scanner to the adapter, which is considered to be the output data for the scanner.
- ④: T → O size (bytes): The length of the data transmitted from the adapter to the scanner, which is considered to be the input data for the scanner.
- ⑤: Connection type: There are “Point to Point” and “Multicast” modes.
- ⑥: Connection Priority: The priority of connection. AS00SCM-RTU only supports “Scheduled” mode”.

Note 1: Configure settings of T → O size and O → T size according to the IO module configured in section 9.4.2.2.1. The following table shows the relevant data length of each model type of modules.

- The input/output data length of different DIO modules

Digital I/O Module	T → O size bytes (Input)	O → T size bytes (Output)
AS08AM10N-A	2	0
AS08AN01T-A	0	2
AS08AN01P-A	0	2
AS08AN01R-A	0	2
AS16AM10N-A	2	0
AS16AP11T-A	2	2
AS16AP11P-A	2	2
AS16AP11R-A	2	2
AS16AN01T-A	0	2
AS16AN01P-A	0	2
AS16AN01R-A	0	2
AS32AM10N-A	4	0
AS32AN02T-A	0	4
AS64AM10N-A	8	0
AS64AN02T-A	0	8

- The input/output data length of different AIO modules

Analog I/O Module	T → O size bytes(Input)	O → T size bytes(Output)
AS02ADH-A	40	0
AS04AD-A	40	0
AS08AD-B	40	0
AS08AD-C	40	0
AS04DA-A	4	36
AS06XA-A	20	20
AS04RTD-A	40	0
AS06RTD-A	40	0
AS04TC-A	40	0
AS08TC-A	40	0

9.4.2.2.4 Operate IO modules on AS00SCM-RTU

After the EtherNet/IP connection setting is complete, input and output data can be found on EtherNet/IP IO Mapping tab. Then you would be allowed to operate the IO module on the right side of AS00SCM-RTU. The following configuration shows that AS16AP11T-A (T → O: 2 Bytes; O → T: 2 Bytes) and AS04AD-A module (T → O: 40 Bytes; O → T: 0 Bytes) are connected to the right side of AS00SCM-RTU, which the total data length of T → O and O → T respectively are 102 Bytes and 42 Bytes.

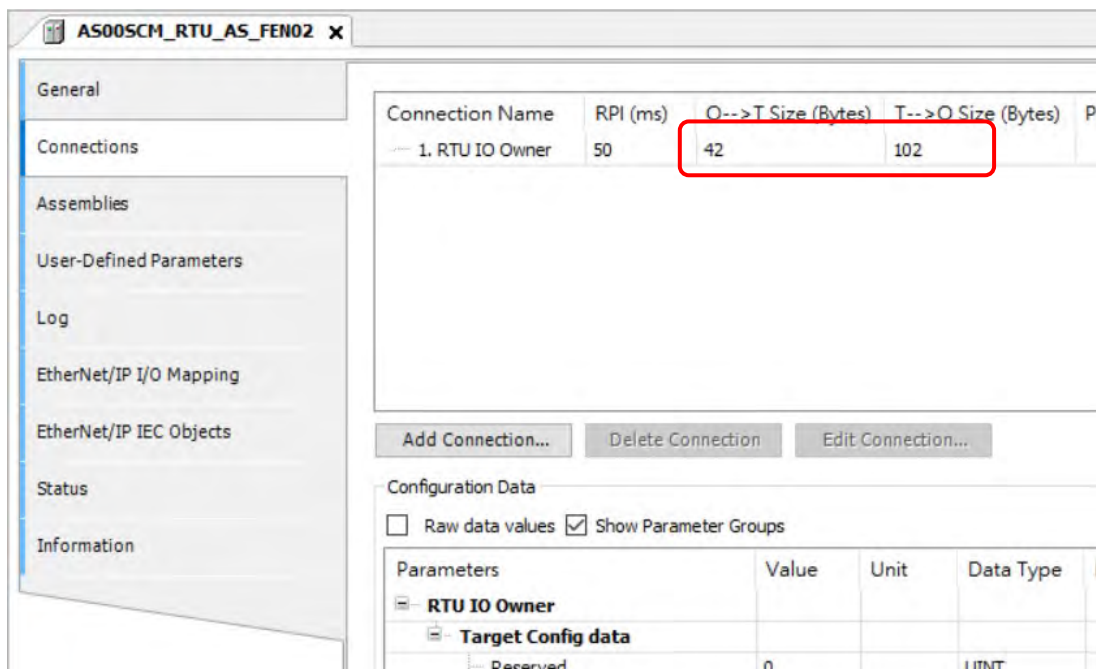
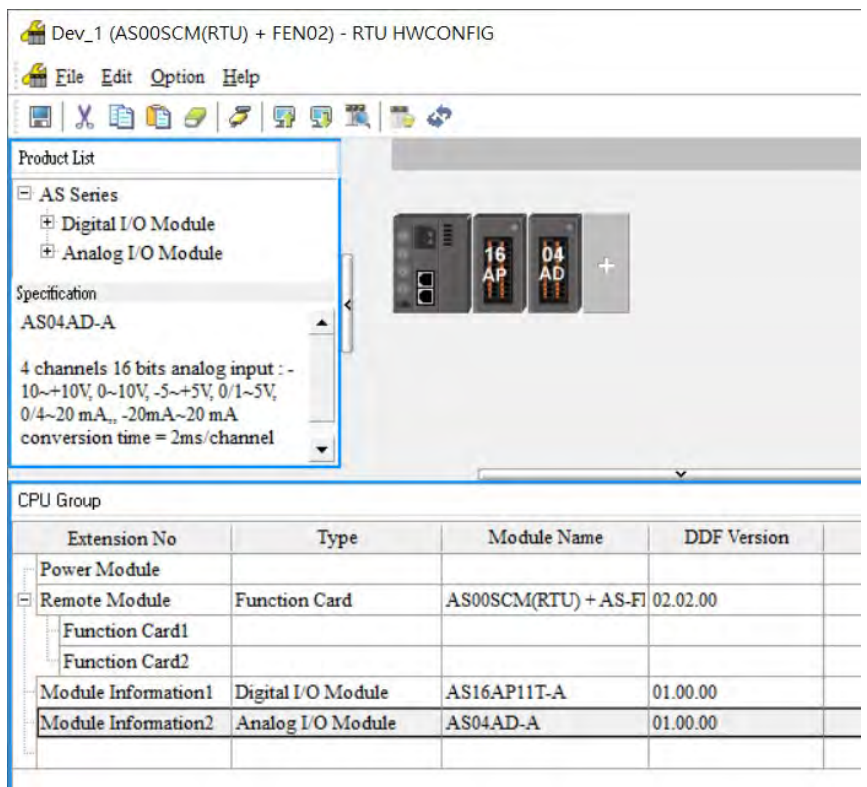

Note 1: Please be noticed that channel mode and other related parameters of AIO modules should be configured first as detailed in section 9.4.2.2.1. Only reading and operating with IO channels would be explained in this section.

Note 2: If the data type of values to read or write is floating point, you would need to exchange the high word and low word so as to display the correct values.

The screenshot shows the configuration tool for AS005CM_RTU_AS_FEN02. The 'EtherNet/IP I/O Mapping' tab is selected. The table below shows the mapping of input data variables to channels and addresses.

Variable	Mapping	Channel	Address	Type
+	+	Reserved	%IW31	UINT
+	+	Input_data30	%IW32	UINT
+	+	Input_data31	%IW33	UINT
+	+	Input_data32	%IW34	UINT
+	+	Input_data33	%IW35	UINT
+	+	Input_data34	%IW36	UINT
+	+	Input_data35	%IW37	UINT
+	+	Input_data36	%IW38	UINT
+	+	Input_data37	%IW39	UINT
+	+	Input_data38	%IW40	UINT
+	+	Input_data39	%IW41	UINT
+	+	Input_data40	%IW42	UINT
+	+	Input_data41	%IW43	UINT
+	+	Input_data42	%IW44	UINT
+	+	Input_data43	%IW45	UINT
+	+	Input_data44	%IW46	UINT
+	+	Input_data45	%IW47	UINT
+	+	Input_data46	%IW48	UINT
+	+	Input_data47	%IW49	UINT
+	+	Input_data48	%IW50	UINT
+	+	Input_data49	%IW51	UINT
+	+	Reserved	%QW1	UINT

The screenshot shows the configuration tool for AS005CM_RTU_AS_FEN02. The 'EtherNet/IP I/O Mapping' tab is selected. The table below shows the mapping of reserved variables and one output data variable to channels and addresses.

Variable	Mapping	Channel	Address	Type
+	+	Reserved	%QW 1	UINT
+	+	Reserved	%QW 2	UINT
+	+	Reserved	%QW 3	UINT
+	+	Reserved	%QW 4	UINT
+	+	Reserved	%QW 5	UINT
+	+	Reserved	%QW 6	UINT
+	+	Reserved	%QW 7	UINT
+	+	Reserved	%QW 8	UINT
+	+	Reserved	%QW 9	UINT
+	+	Reserved	%QW 10	UINT
+	+	Reserved	%QW 11	UINT
+	+	Reserved	%QW 12	UINT
+	+	Reserved	%QW 13	UINT
+	+	Reserved	%QW 14	UINT
+	+	Reserved	%QW 15	UINT
+	+	Reserved	%QW 16	UINT
+	+	Reserved	%QW 17	UINT
+	+	Reserved	%QW 18	UINT
+	+	Reserved	%QW 19	UINT
+	+	Reserved	%QW 20	UINT
+	+	Output_data20	%QW21	UINT

9.4.2.2.5 Parameter Information of AS00SCM-RTU Module

The AS00SCM-RTU status can be diagnosed via the parameter information displayed on EtherNet/IP IO Mapping tab.

Variable	Mapping	Channel	Address	Type
RTU IO Owner				
RTU state	②	RTU state	%IW2	UINT
RTU error code	③	RTU error code	%IW3	UINT
Reserved		Reserved	%IW4	UINT
Reserved		Reserved	%IW5	UINT
Reserved		Reserved	%IW6	UINT
Reserved		Reserved	%IW7	UINT
Reserved		Reserved	%IW8	UINT
Reserved		Reserved	%IW9	UINT
Reserved		Reserved	%IW10	UINT
Reserved		Reserved	%IW11	UINT
Power State	④	Power State	%IW12	UINT
module [0..15] state		module [0..15] state	%IW13	UINT
module [16..31] state		module [16..31] state	%IW14	UINT
module [32..47] state		module [32..47] state	%IW15	UINT
module [48..63] state	④	module [48..63] state	%IW16	UINT
module [64..67] state		module [64..67] state	%IW17	UINT
Module 1 error code		Module 1 error code	%IW18	UINT
Module 2 error code		Module 2 error code	%IW19	UINT
Module 3 error code		Module 3 error code	%IW20	UINT
Module 4 error code		Module 4 error code	%IW21	UINT
Module 5 error code	⑤	Module 5 error code	%IW22	UINT
Module 6 error code		Module 6 error code	%IW23	UINT
Module 7 error code		Module 7 error code	%IW24	UINT
Module 8 error code		Module 8 error code	%IW25	UINT
Reserved		Reserved	%IW26	UINT
Reserved		Reserved	%IW27	UINT

- ①: RTU state: Communication module status (0 = Normal; 1 = Error)
- ②: RTU error code: Please refer to section 9.7 Error Codes in AS Series Module Manual.
- ③: Power State: The power status of communication module. (0 = Normal; 1 = Error)
- ④: Module state [0..67]: I/O module status, expressed with bits. (0 = Operate normally; 1 = Operate improperly)
- ⑤: Module error code: I/O module error codes. For more details of error codes, please refer to the manual of each module.

9.4.3 EtherNet/IP Adapter Function

9.4.3.1 EtherNet/IP Adapter

This section will explain how to add an EtherNet/IP adapter and set up its data structure. Refer to the following steps for configuration.

9.4.3.3.1 Add an EtherNet/IP Adapter

- Add an Ethernet device.

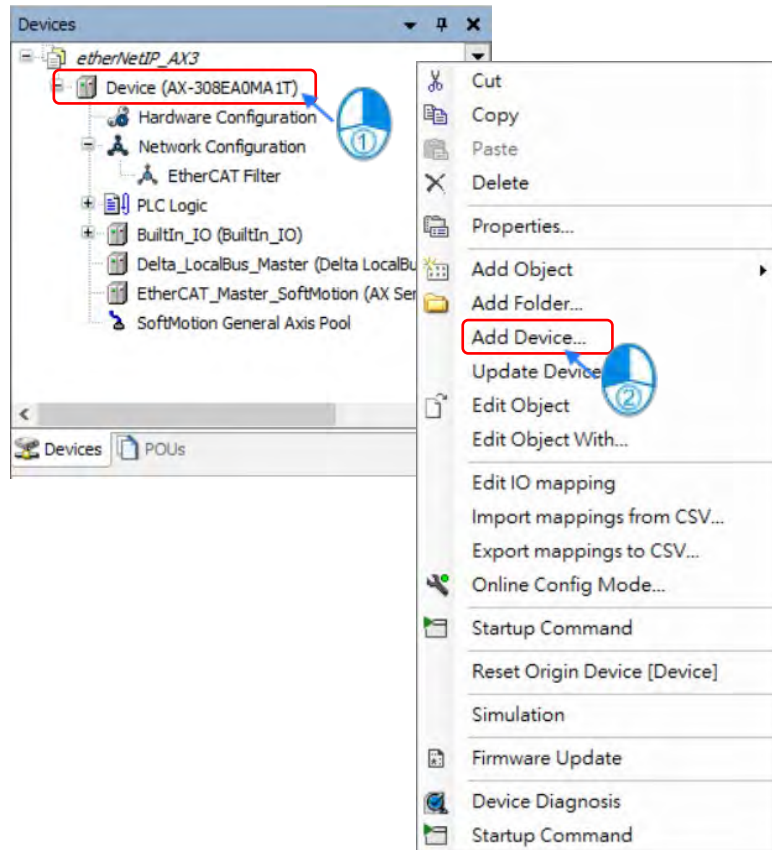

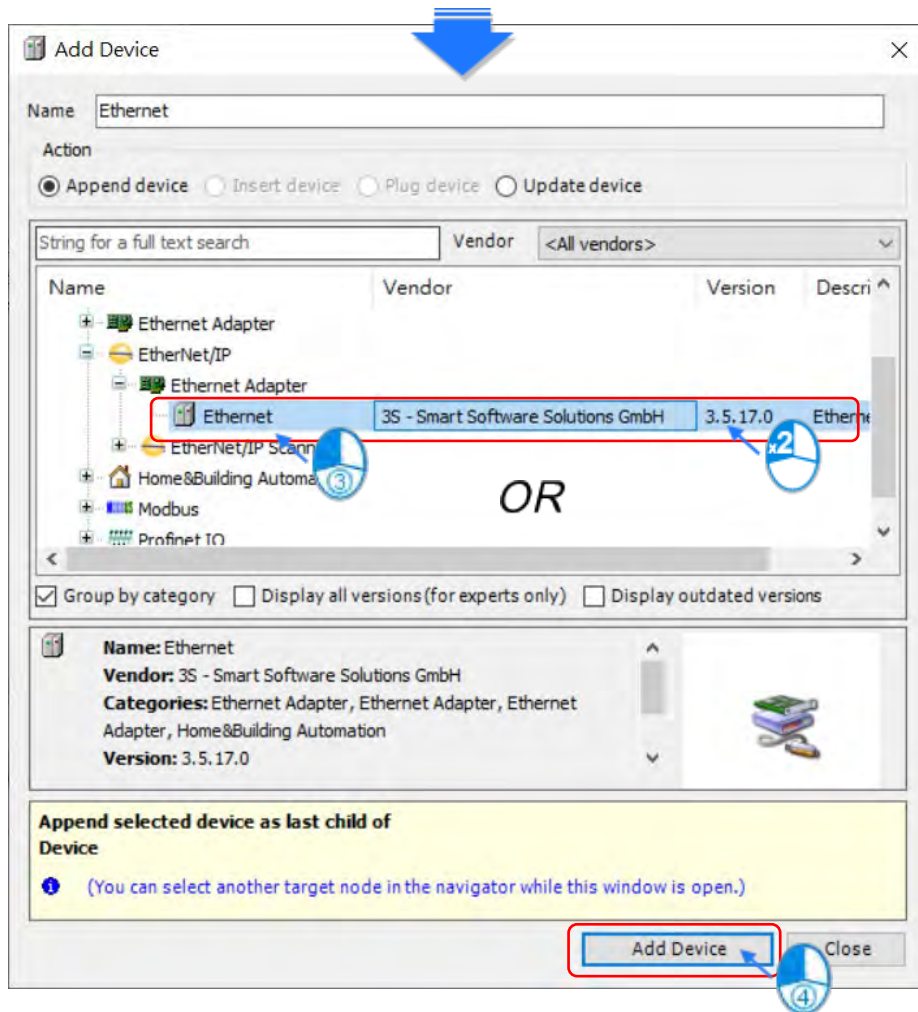

- Add Delta_EtherNet_IP_Adapter device.

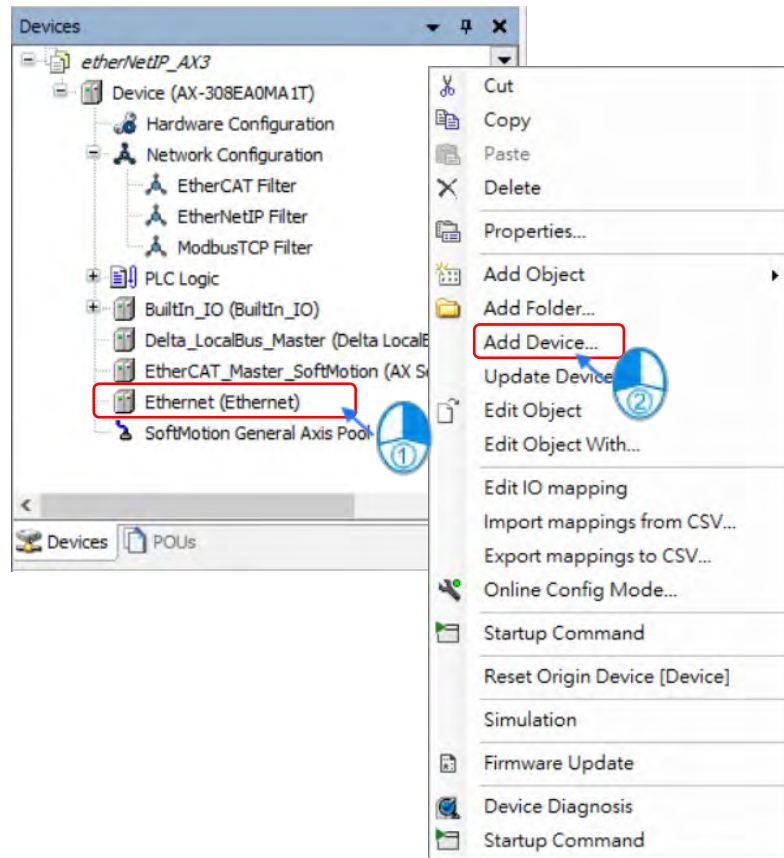

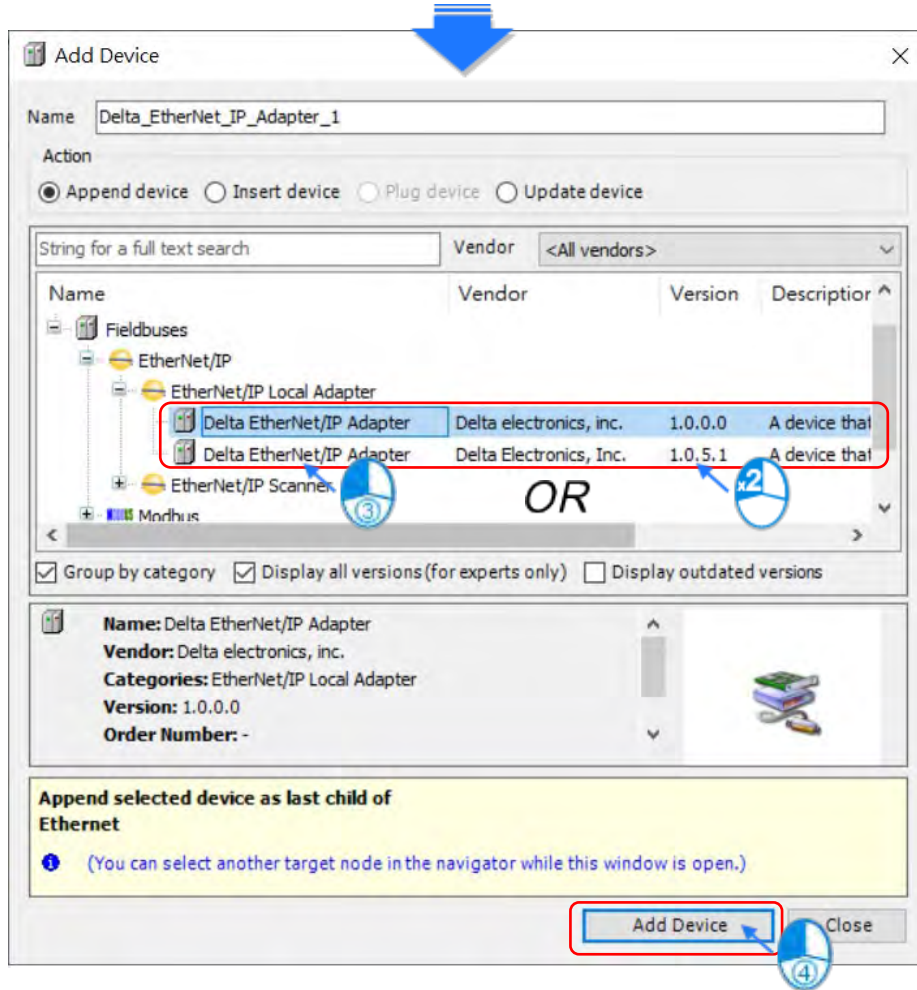

- Set up the data structure for EtherNet/IP Adapter.

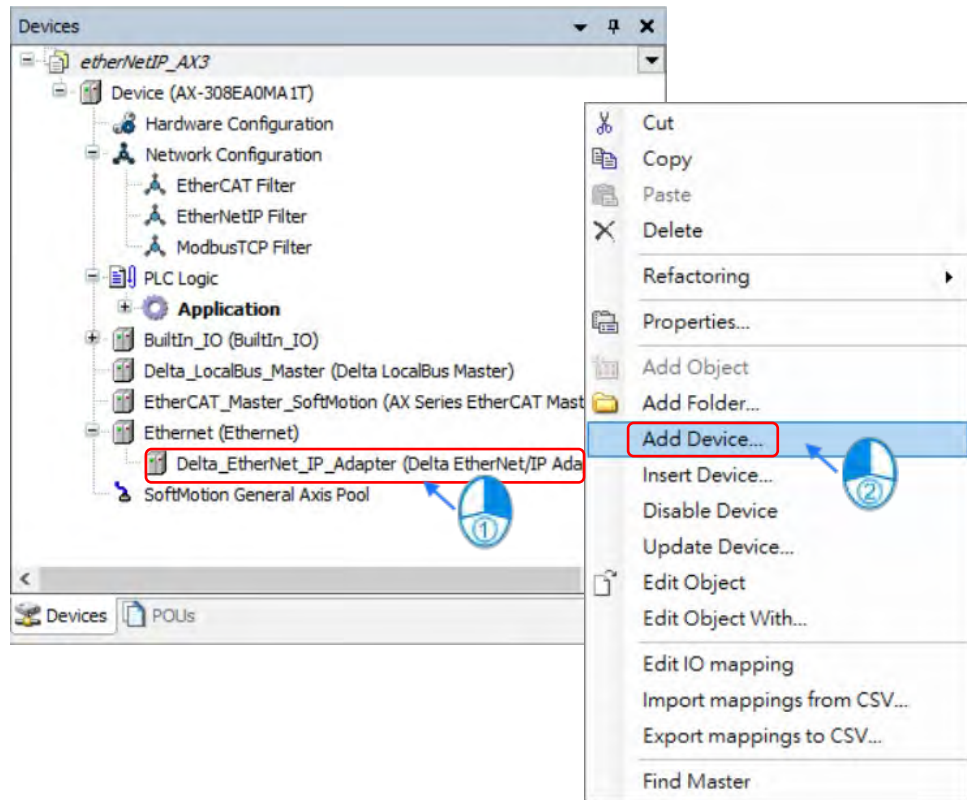

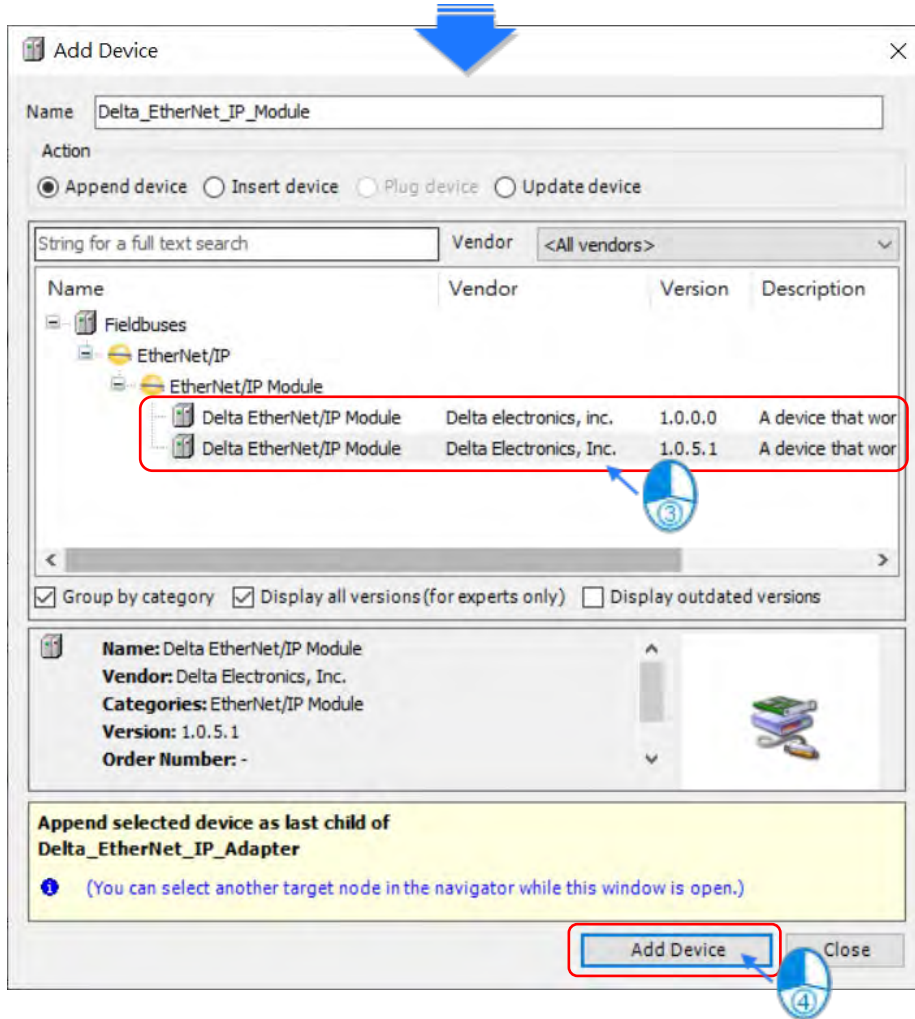

- Setting up the Delta_EtherNet_IP_Module

You can set up the data structure of EtherNet/IP Adapter by adding or setting up Delta EtherNet/IP module.

Example of Delta EtherNet/IP Module (V1.0.0.0)

The screenshot shows the configuration interface for a Delta EtherNet/IP Module. The 'Module' dropdown menu is highlighted with a red box and is set to 'Byte Input Module'. Other fields include Vendor name: Delta electronics, inc., Vendor ID: 799, Product name: Byte Input Module, Product code: 20224, Major revision: 1, and Minor revision: 1.

Item	Description
Byte Input Module	1 Byte input
Byte Output Module	1 Byte output
Word Input Module	1 Word input
Word Output Module	1 Word output
DWord Input Module	1 DWord input
DWord Output Module	1 DWord output
Real Input Module	1 Real input
Real Output Module	1 Real output
100 words Input Module	100 Words input
100 words Output Module	100 Words output

Example of Delta EtherNet/IP Module (V1.0.5.1) works with DIADesigner-AX V1.4

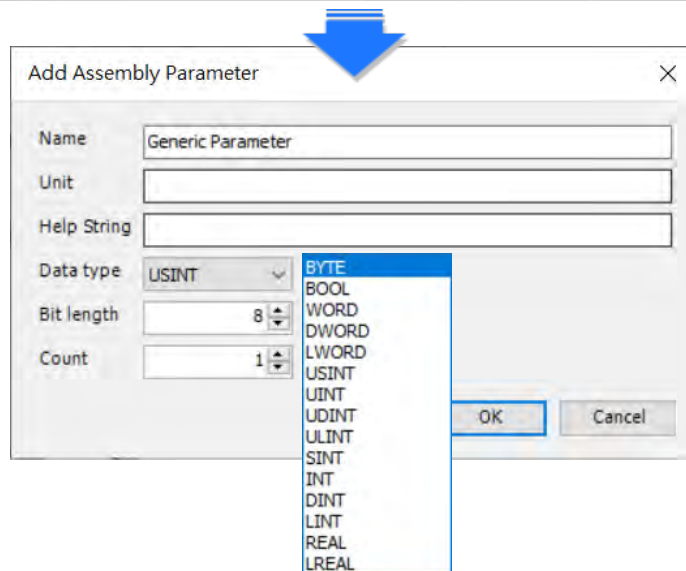
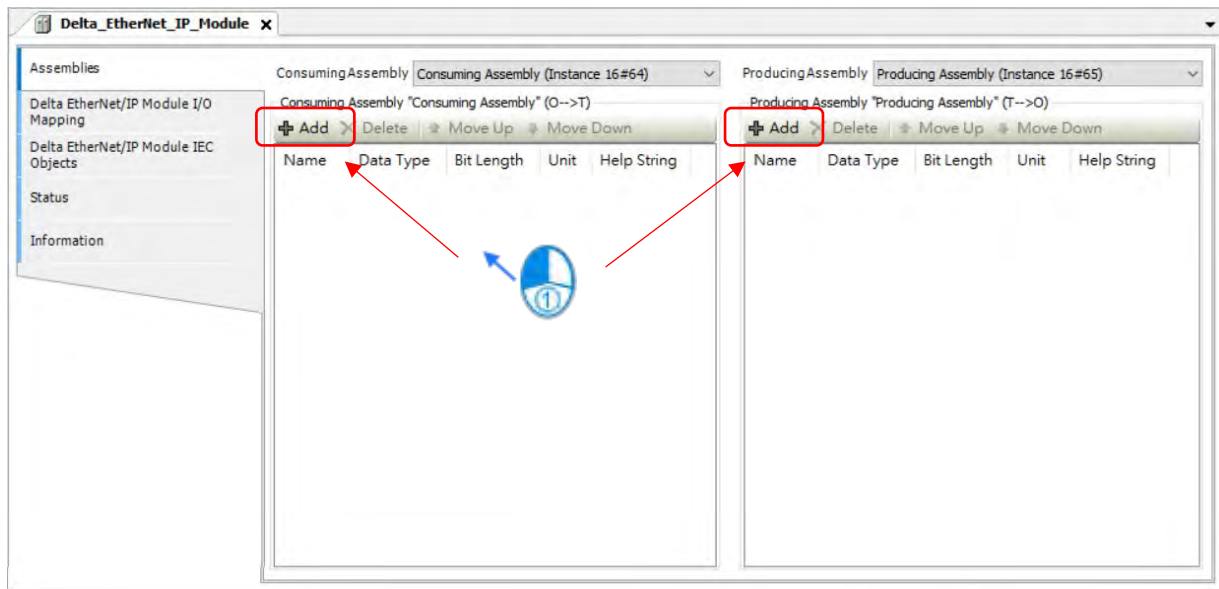

9.4.3.1.2 Setting up EtherNet/IP Adapter

- Delta EtherNet/IP Adapter
 - General – Setup EDS File

The screenshot shows the configuration interface for the Delta EtherNet/IP Adapter. The 'General' tab is active, displaying the 'Setup EDS File' section. The fields are populated with the following values:

- Vendor name: Delta electronics, inc.
- Vendor ID: 799
- Product name: AX-308EA0MA1T
- Product code: 16386
- Major revision: 1
- Minor revision: 1
- Enable ACD:

Buttons for 'Install to Device Repository...' and 'Export EDS File...' are located at the bottom of the configuration area.

Item	Description	Default
Vendor name	The name of the supplier	Delta electronics, inc.
Vendor ID	Supplier ID	799
Product name	The name of the product	AX-308EA0MA1T
Product code	Product code	16386
Major revision	Major revision	1
Minor revision	Minor revision	1
Enable ACD	Ethernet/IP Adapter IP conflict detection. (This function is supported only in Delta EtherNet/IP Adapter V1.0.5.1 or later and must be used with DIADesigner-AX V1.4 or later.)	Disable
Install to Device Repository	In case that a device with the same device identification has already been installed, you would be asked whether the device should be overwritten. If the device is taken as the remote adapter inserted directly below the EtherNet/IP scanner, you would be asked to update the device automatically.	
Export EDS File	The EDS file is created and stored on the local computer. In this way, the EDS file can be used in an external configuration file.	

9.4.3.1.3 Export an EDS File

- Export EDS File

After the configuration is complete, export the EDS file and store the EDS file – AX-308EA0MA1T.eds in the PC.

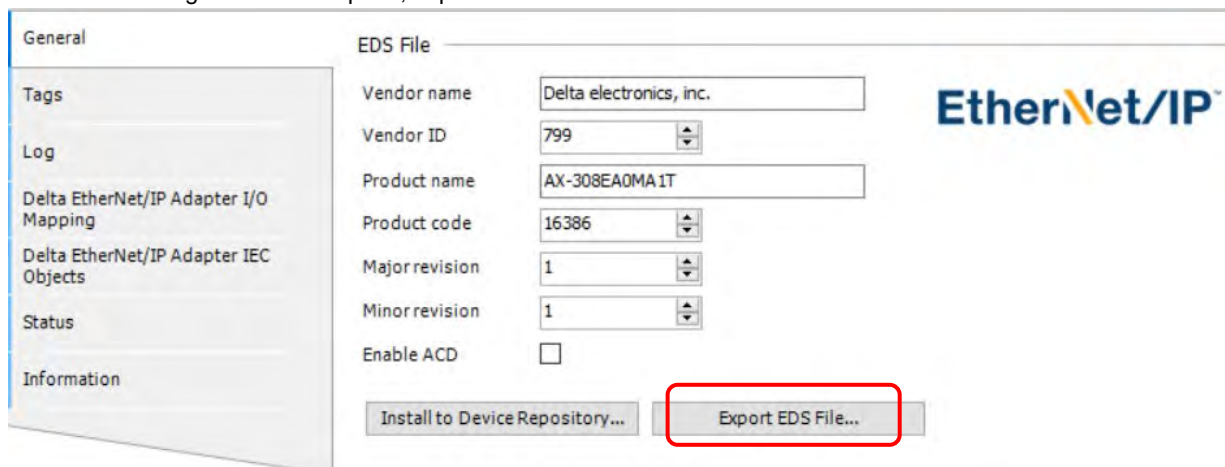

9.4.3.2 Example of Connecting to a Third Party (Allen Bradley ControlLogix 1756-L71)

This section introduces how to connect Delta’s EtherNet/IP adapter via EtherNet/IP by using other brands’ software. The Rockwell’s software is used as an example in the following section.

9.4.3.2.1 Structure

RA EIP scanner connects to Delta’s adapter via Ethernet, while connecting to PC via Ethernet or USB.

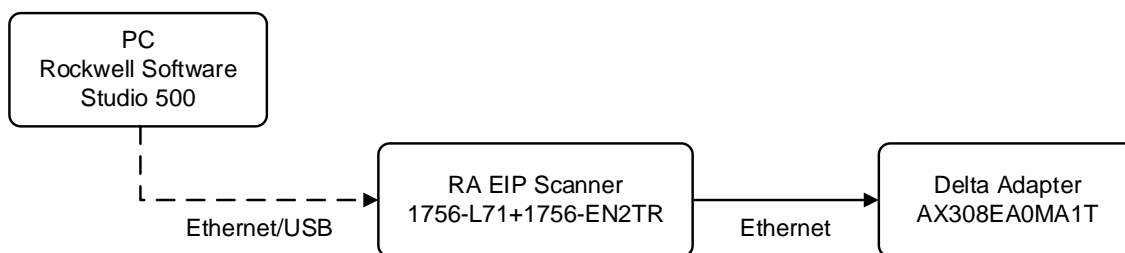

※ Rockwell Software Studio 5000, ControlLogix, RSLogix are the trademark of Rockwell Automation.

The operation process is shown as follows:

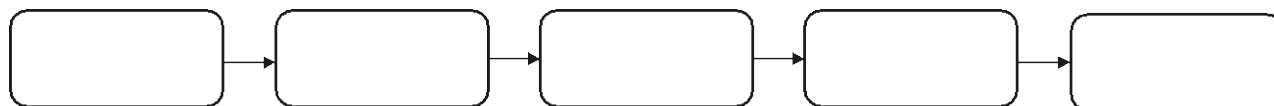

9.4.3.2.2 Create a Project

- Open Studio 5000 and click “New Project” from “Create”.
- Select the model type of PLC. Model 1756-L71 is used in the following example.
- Click “Finish” to finish creating projects.
- The configuration page would be opened automatically after the project has been successfully added.

9.4.3.2.3 Create a Scanner

After the project being created, add the EtherNet/IP module (1756-EN2TR) on the PLC backplane, then setup the EtherNet/IP device to connect via the EtherNet/IP module.

9.4.3.2.4 Create a New Module

- Right click on 1756 Backplane 1756-A7 and select “New Module”.
- Enter “1756-EN2TR” in the Filter field and select “Create”.
- Enter the information of Name and IP address, then click “OK” to complete the task of creating EtherNet/IP modules.
- Expand project tree on the 1756-EN2TR module.

9.4.3.2.5 Import an EDS File

- Choose EDS Hardware Installation Tool from Tools
- Select “Register an EDS file (s)”.
- Select Browse from Register a single file and find the target EDS file to download: AX-308EA0MA1T.ed5
- Follow the instructions to click “Next” until the EDS file is successfully created.

9.4.3.2.6 Create a New Adapter

- Right click “Ethernet” and select “New Module” under EtherNet/IP Scanner module in the project tree.
- Enter the module number of the imported EDS file and select the target model type (such as AX-308EA0MA1T), then click “Create”.
- Enter the product name and IP address, which should be same as the information shown in the Module Definition section.
- To change Connections information, click “Change” in Module Definition to open the modification page.
- Change Connections information
 - (1) Name: Tap the arrow next to Name to list all the available connections supported by the device.
 - (2) Size: the value indicates the length of the input/ output data for data exchange.
- ※ For general purposes, there is no need to change the parameters from the imported EDS files which often can be used directly for connection.
- On Connection tab page, settings of RPI and input type can be modified, which the former is set as the interval time of periodic data exchange with scanners (unit: ms). Select the input type between Unicast and Multicast according to the feature supported by each product.
- Click OK after the Delta adapter has been successfully added and the model name would be displayed in the project tree.

9.4.3.2.7 Projects Download

After the creation of the Delta Adapter device is done, download the project to the PLC and go online.

- Click the “Communications” tab to and then select the option “Who Active”. For establishing a connection, select the PC connected Scanner model number and then go to Communications > Download.
- After the connection is successfully established, the I/O status will show OK.

9.4.3.2.8 Data Mapping

Click the “Program TAGs” under the “Tasks” node for data mapping setups, including Configure, Input and Output. After the device is created in the I/O Configuration, the TAG will be added automatically.

- Click the “Program TAGs”.
- You will see the tags corresponding to each product name on the right-hand side of the window.

TAG: C contains information from Adapter EDS file, including Input and Output parameters. Users can edit the parameters of Input and Output here.

TAG: I1, the mapping starts from TAG: I1[0], and will be mapped to the first parameters of the Adapter Output. The length is the output length provided by the Adapter.

TAG: O1, the mapping starts from TAG: O1[0], and will be mapped to the first parameters of the Adapter Input. The length is the input length provided by the Adapter.

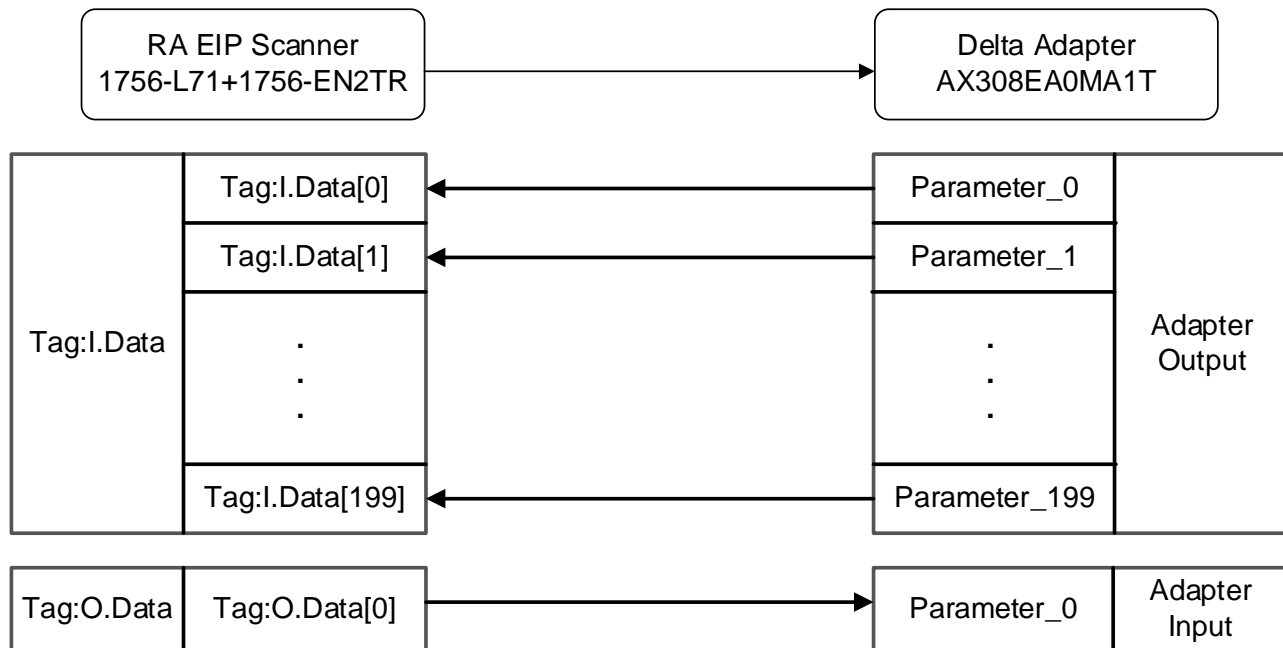

9.4.4 CIP Object

9.4.4.1 Object List

In EtherNet/IP, object is referred to as a set of parameter that is structured accordingly by Class, Instance and Attribute. For example, Instance 0 contains basic information of every object, e.g. version and length. While Instance 1~N creates connection or status of required parameters for each product. Users can obtain product parameters from the supported service code via objects (see diagram below).

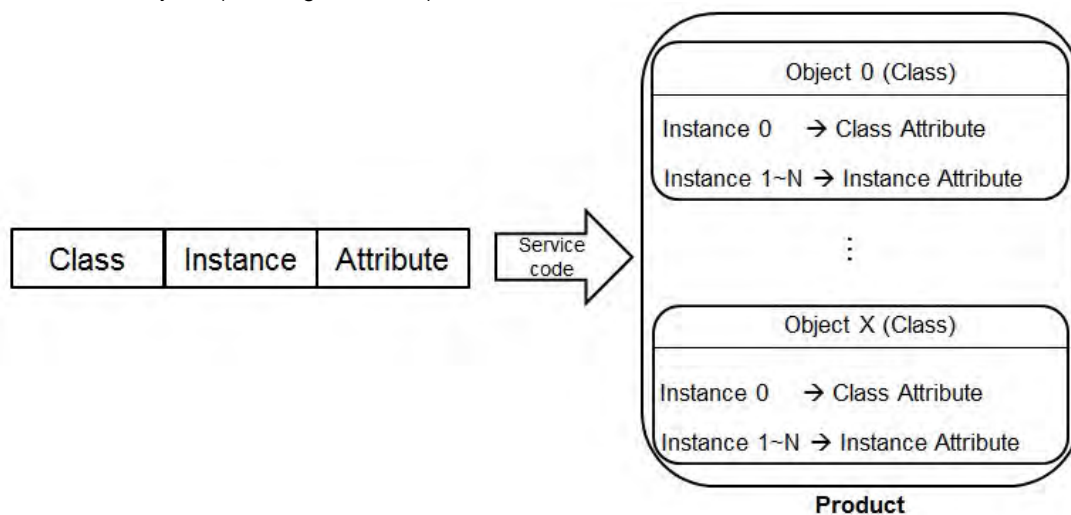

Read or write objects by using EtherNet/IP Services.library or explicit message tool. The supported EtherNet/IP objects are listed below. Refer to the section 9.4.4.2 for the data type definition. Refer to the section 9.4.4.3~9.4.4.6 for object contents.

Object Name	Function	Class ID
Identity Object	Provides information including manufacturer, device types and versions.	1(H'01)
Assembly Object	Defines parameter of I/O connection data exchange	4(H'04)
TCP/IP Interface Object	Displays methods of IP configuration and interface	245(H'F5)
Ethernet Link Object	Shows the connection status of each Ethernet port on the device.	246(H'F6)

9.4.4.2 Data Type

This section will provide an overview of the supported data types by objects.

Data Type	Description																																																							
BOOL	False(H'00)or True(H'01)																																																							
SIGNED INTEGER	<p>SINT(1 byte), INT(2 bytes), DINT(4 bytes), LINT(8 bytes)</p> <table border="1"> <thead> <tr> <th>Number</th> <th>1st</th> <th>2nd</th> <th>3rd</th> <th>4th</th> <th>5th</th> <th>6th</th> <th>7th</th> <th>8th</th> </tr> </thead> <tbody> <tr> <td>SINT</td> <td>0LSB</td> <td>--</td> <td>--</td> <td>--</td> <td>--</td> <td>--</td> <td>--</td> <td>--</td> </tr> <tr> <td>INT</td> <td>0LSB</td> <td>1LSB</td> <td>--</td> <td>--</td> <td>--</td> <td>--</td> <td>--</td> <td>--</td> </tr> <tr> <td>DINT</td> <td>0LSB</td> <td>1LSB</td> <td>2LSB</td> <td>3LSB</td> <td>--</td> <td>--</td> <td>--</td> <td>--</td> </tr> <tr> <td>LINT</td> <td>0LSB</td> <td>1LSB</td> <td>2LSB</td> <td>3LSB</td> <td>4LSB</td> <td>5LSB</td> <td>6LSB</td> <td>7LSB</td> </tr> </tbody> </table> <p>Ex: DINT value = H'12345678</p> <table border="1"> <thead> <tr> <th>Number</th> <th>1st</th> <th>2nd</th> <th>3rd</th> <th>4th</th> </tr> </thead> <tbody> <tr> <td>DINT</td> <td>78</td> <td>56</td> <td>34</td> <td>12</td> </tr> </tbody> </table>	Number	1st	2nd	3rd	4th	5th	6th	7th	8th	SINT	0LSB	--	--	--	--	--	--	--	INT	0LSB	1LSB	--	--	--	--	--	--	DINT	0LSB	1LSB	2LSB	3LSB	--	--	--	--	LINT	0LSB	1LSB	2LSB	3LSB	4LSB	5LSB	6LSB	7LSB	Number	1st	2nd	3rd	4th	DINT	78	56	34	12
Number	1st	2nd	3rd	4th	5th	6th	7th	8th																																																
SINT	0LSB	--	--	--	--	--	--	--																																																
INT	0LSB	1LSB	--	--	--	--	--	--																																																
DINT	0LSB	1LSB	2LSB	3LSB	--	--	--	--																																																
LINT	0LSB	1LSB	2LSB	3LSB	4LSB	5LSB	6LSB	7LSB																																																
Number	1st	2nd	3rd	4th																																																				
DINT	78	56	34	12																																																				
UNSIGNED INTEGER	<p>USINT(1 byte), UINT(2 bytes), UDINT(4 bytes), ULINT(8 bytes)</p> <p>Ex: UDINT value = H'AABBCCDD</p> <table border="1"> <thead> <tr> <th>Number</th> <th>1st</th> <th>2nd</th> <th>3rd</th> <th>4th</th> </tr> </thead> <tbody> <tr> <td>UDINT</td> <td>DD</td> <td>CC</td> <td>BB</td> <td>AA</td> </tr> </tbody> </table>	Number	1st	2nd	3rd	4th	UDINT	DD	CC	BB	AA																																													
Number	1st	2nd	3rd	4th																																																				
UDINT	DD	CC	BB	AA																																																				
STRING	<p>ASCII, 1 or 2 bytes</p> <p>STRING: 2 bytes character count + 1 byte character</p> <table border="1"> <thead> <tr> <th></th> <th colspan="2">Contents(Charcount)</th> <th colspan="4">Contents(String contents)</th> </tr> </thead> <tbody> <tr> <td>STRING</td> <td>04</td> <td>00</td> <td>4D</td> <td>69</td> <td>6C</td> <td>6C</td> </tr> </tbody> </table> <p>STRING2: 2 bytes character count + 2 byte character</p> <table border="1"> <thead> <tr> <th></th> <th colspan="2">Contents(Charcount)</th> <th colspan="6">Contents(String contents)</th> </tr> </thead> <tbody> <tr> <td>STRING2</td> <td>04</td> <td>00</td> <td>4D</td> <td>00</td> <td>69</td> <td>00</td> <td>6C</td> <td>00</td> <td>6C</td> <td>00</td> </tr> </tbody> </table> <p>SHORT_STRING: 1 bytes character count + 1 byte character</p> <table border="1"> <thead> <tr> <th></th> <th colspan="2">Contents(Charcount)</th> <th colspan="3">Contents(String contents)</th> </tr> </thead> <tbody> <tr> <td>STRING</td> <td>04</td> <td></td> <td>4D</td> <td>69</td> <td>6C</td> <td>6C</td> </tr> </tbody> </table>		Contents(Charcount)		Contents(String contents)				STRING	04	00	4D	69	6C	6C		Contents(Charcount)		Contents(String contents)						STRING2	04	00	4D	00	69	00	6C	00	6C	00		Contents(Charcount)		Contents(String contents)			STRING	04		4D	69	6C	6C								
	Contents(Charcount)		Contents(String contents)																																																					
STRING	04	00	4D	69	6C	6C																																																		
	Contents(Charcount)		Contents(String contents)																																																					
STRING2	04	00	4D	00	69	00	6C	00	6C	00																																														
	Contents(Charcount)		Contents(String contents)																																																					
STRING	04		4D	69	6C	6C																																																		
Fixed LENGTH BIT STRING	<p>BYTE(1 byte), WORD(2 bytes), DWORD(4 bytes), LWORD(8 bytes)</p> <table border="1"> <thead> <tr> <th></th> <th>1st</th> <th>2nd</th> <th>3rd</th> <th>4th</th> <th>5th</th> <th>6th</th> <th>7th</th> <th>8th</th> </tr> </thead> <tbody> <tr> <td>Byte</td> <td>7...0</td> <td>--</td> <td>--</td> <td>--</td> <td>--</td> <td>--</td> <td>--</td> <td>--</td> </tr> <tr> <td>WORD</td> <td>7...0</td> <td>15...8</td> <td>--</td> <td>--</td> <td>--</td> <td>--</td> <td>--</td> <td>--</td> </tr> <tr> <td>DWORD</td> <td>7...0</td> <td>15...8</td> <td>23...16</td> <td>31...24</td> <td>--</td> <td>--</td> <td>--</td> <td>--</td> </tr> <tr> <td>LWORD</td> <td>7...0</td> <td>15...8</td> <td>23...16</td> <td>31...24</td> <td>39...32</td> <td>47...40</td> <td>55...48</td> <td>63...56</td> </tr> </tbody> </table>		1st	2nd	3rd	4th	5th	6th	7th	8th	Byte	7...0	--	--	--	--	--	--	--	WORD	7...0	15...8	--	--	--	--	--	--	DWORD	7...0	15...8	23...16	31...24	--	--	--	--	LWORD	7...0	15...8	23...16	31...24	39...32	47...40	55...48	63...56										
	1st	2nd	3rd	4th	5th	6th	7th	8th																																																
Byte	7...0	--	--	--	--	--	--	--																																																
WORD	7...0	15...8	--	--	--	--	--	--																																																
DWORD	7...0	15...8	23...16	31...24	--	--	--	--																																																
LWORD	7...0	15...8	23...16	31...24	39...32	47...40	55...48	63...56																																																

Data Type	Description							
STRINGI	A single string consists multiple language representation.							
	Name		Data Type		Meaning			
	Number		USINT		The number of internationalized character strings			
	Strings		Array of: Struct of:		Array of individual internationalized character strings			
	LanguageChar1		USINT		The first ASCII character of the ISO 639-2/T language			
	LanguageChar2		USINT		The second ASCII character of the ISO 639-2/T language			
	LanguageChar3		USINT		The third ASCII character of the ISO 639-2/T language			
	CharStringStruct		USINT		The structure of the character string, limited to the Elementary Data type value 0xD0(String), 0xD5(String2), 0xD9(StringN)and 0xDA(SHORT_STRING)			
	CharSet		UINT		The character set which the character string is based on which comes from IANA MIB Printer Code (RFC 1759).			
	InternationalString		Defined in CharStringStruct		An array of 8-bit octet elements which is the actual international character string			
ISO 639-2/T language:								
Language		First Character		Second Character		Third Character		
English		e		n		G		
French		f		r		e		
Spanish		s		p		a		
Italian		i		t		a		
STRUCT	STRUCT of: Any Data Type composes the structure.							
	Ex.: STRUCT of { BOOL, UINT, DINT } = { TRUE, H'1234, H'56789ABC }							
		1st	2nd	3rd	4th	5th	6th	7th
Byte	01	34	12	BC	9A	78	56	
ARRAY	Array of: Any Data Type composes the array.							
	Ex.: ARRAY of UINTs = { 1, 2, 3 }							
	Number	1st	2nd	3rd	4th	5th	6th	
Array	01	00	02	00	03	00		
EPATH	It's a path that consists of multiple segments and references the class, instance and attribute of another object.							
Ex.: Identity Object, Instance attribute 5 = " 20 01 24 01 30 05 "								

9.4.4.3 Identity Object (Class ID: 01 Hex)

Identity information is stored in the Identity Object and consists of the Vendor ID, Device Type, Product Code and Major Revision for your device.

- Service Code

Service code	Service Name	Attribute		Description
		Class Attribute	Instance Attribute	
H'01	Get_Attributes_All	X	V	Read all attributes.
H'05	Reset	X	V	Reset.
H'0E	Get_Attribute_Single	X	V	Read one attribute.

- Class

- Class ID: H'01

- Instance

- H'01: Instance Attribute
- When Instance =1, the Instance attributes are listed below:

Instance Attribute	Name	Access Rule	Data Type	Values	Description
H'01	Vendor ID	Get	UINT	H'31F	Delta Electronics, inc.
H'02	Device Type	Get	UINT	H'0C	Data Type: Communication Adatper
H'03	Product Code	Get	UINT	H'4002	Product code
H'04	Revision	Get	STRUCT	--	Revision of this device: Major.Minor
	Major Revision		USINT	H'01	Major Revision Range: H'01~H'7F
	Minor Revision		USINT	H'01	Minor Revision Range: H'01~H'FF
H'05	Status	Get	WORD	H'64	Status, refer to the following※1
H'06	Serial Number	Get	UDINT	H'2374F75C	The last 8 characters of the MAC address 23: 74: f7: 5C
H'07	Product Name	Get	SHORT_STRING	The maximum number of a product name is 32 words. (Data length+Product Name) (H'0D) AX-308EA0MA1T	

※1 Status Description (H'05)

Bit (s)	Name	Description
0	Owned	Display if the device has an owner connection. 0: No 1: Yes
1	Reserved	0: Always OFF
2	Configured	Display if the device is configured or not. 0: No 1: Yes
3	Reserved	0: Always OFF
4-7	Extended Device Status	0: Self-Testing 1: Firmware Update 2: At least one faulted I/O connection 3: No I/O connections established 4: Non-Volatile Configuration bad 5: Major Fault 6: At least one I/O connection in run mode 7: At least one I/O connection established, all in idle mode 8-15: Reserved
8	Minor Recoverable Fault	0: No minor recoverable fault detected 1: Minor recoverable fault detected
9	Minor Unrecoverable Fault	0: No minor unrecoverable fault detected 1: Minor unrecoverable fault detected
10	Major Recoverable Fault	0: No major recoverable fault detected 1: Major recoverable fault detected
11	Major Unrecoverable Fault	0: No major unrecoverable fault detected 1: Major unrecoverable fault detected

9.4.4.4 Assembly Object (Class ID: 04 Hex)

Assembly Objects are used to aggregate data for the input data and output data associated with I/O connections.

- Service Code

Service Code	Service Name	Support		Description
		Class Attribute	Instance Attribute	
H'0E	Get_Attribute_Single	X	V	Read a single attribute

- Class

- Class ID: H'04

- Instance

- H'64: Output assembly
- H'65: Input assembly
- H'66: Dummy (needed for compatibility)
- When Instance = 64-66, the Instance Attributes are listed below:

Instance Attribute	Name	Access Rule	Data Type	Values	Description
H'03	Data	Get	ARRAY of BYTE	H'2	IO Connection Data

- Examples of reading and writing objects

(1) To read output assembly data, write the data as shown below:

Service code: H' 0E

Class ID: H' 04

Instance ID: H' 64

Attribute ID: H' 03

(2) To read input assembly data, write the data as shown below:

Service code: H' 0E

Class ID: H' 04

Instance ID: H' 65

Attribute ID: H' 03

9.4.4.5 TCP/IP Interface Object (Class ID: F5 Hex)

- Service Code

Service Code	Service Name	Support		Description
		Class Attribute	Instance Attribute	
H'0E	Get_Attribute_Single	V	V	Read a single attribute
H'10	Set_Attribute_Single	X	V	Set values of a single attribute

- Class

- Class ID = H'F5

- Instance

- H'00 : Class Attribute
- H'01 : Instance Attribute
- When Instance = 0, the class attributes are listed below:

Class Attribute	Name	Access Rule	Data Type	Values	Description
H'01	Revision	Get	UINT	H'4	Object revision

- When Instance =1, the Instance attributes are listed below:

Instance Attribute	Name	Access Rule	Data Type	Values	Description
H'01	Status	Get	DWORD	H'2	IP status ※1
H'02	Configuration Capability	Get	DWORD	H'20	Configuration capability, refer to the following ※2
H'03	Configuration Control	Get/Set	DWORD	H'0	Configuration Control, refer to the following ※3
H'04	Physical Link Object :	Get	STRUCT of	--	Path to physical link object
	Path Size		UINT	H'0	Size of Path
	Path		EPATH	--	Logical segments identifying the physical link object
H'05	Interface Configuration :	Get/Set	STRUCT of	--	TCP/IP network interface configuration.
	IP Address		UDINT	192.168.1.5	The device's IP address
	Network Mask		UDINT	255.255.255.0	The device's network mask:
	Gateway Address		UDINT	0	Default gateway address
	Name Server		UDINT	0	Primary name server
	Name Server 2		UDINT	0	Secondary name server
	Domain Name		STRING	00 00	Default domain name
H'06	Host Name	Get	STRING	AX-308EA0MA1T	Device name
H'13	Encapsulation Inactivity Timeout	Get/Set	UINT	120	EIP equipment connection time; unit: seconds; range of

Instance Attribute	Name	Access Rule	Data Type	Values	Description
					values: 0~3600

※ When the master is communicating, the instance attribute H'03 and H'05 cannot be written.

● Examples of reading and writing objects

(1) To read Instance Attribute H'03, write the data as shown below:

Service code : H'0E

Class ID : H'F5

Instance ID : H'01

Attribute ID : H'03

(2) To write Instance Attribute H'05, write the data as shown below:

Service code : H'10

Class ID : H'F5

Instance ID : H'01

Attribute ID : H'05

Data Byte[0~3] : IP Address=192.168.1.5

Byte[4~7] : Network Mask=255.255.255.0

Byte[8~11] : Gateway Mask=0.0.0.0

Byte[12~15] : Name Server =0

Byte[16~19] : Name Server2 =0

※1 Interface status

Status	Description
0	Interface Configuration attribute has not been configured.
1	The Interface Configuration attribute contains valid configuration obtained from BOOTP, DHCP or non-volatile memory.
2	The Interface Configuration attribute contains valid configuration obtained from hardware.

※2 Interface capability flags

Bit	Description
0	BOOTP Client
1	DNS Client
2	DHCP Client
3	DHCP-DNS Update
4	Configuration Settable
5	Hardware Configurable
6	Interface Configuration Change Requires Reset

※3 Interface Configuration Control

Status	Description
0	The device shall use the interface configuration values previously stored (for example, in non-volatile memory or via hardware switches).

Status	Description
1	The device shall obtain its interface configuration values via BOOTP.
2	The device shall obtain its interface configuration values via DHCP upon start-up.

9.4.4.6 Ethernet Link Object (Class ID: F6 Hex)

- Service Code

Service Code	Service Name	Support		Description
		Class Attribute	Instance Attribute	
H'0E	Get_Attribute_Single	V	V	Read a single attribute

- Class

- Class ID : H'F6

- Instance

- H'00 : Class Attribute
- H'01 : Instance Attribute

- When Instance =0, the Instance attributes are listed below:

Class Attribute	Name	Access Rule	Data Type	Values	Description
H'01	Revision	Get	UINT	H'04	Object revision

- When Instance =1, the Instance attributes are listed below:

Instance Attribute	Name	Access Rule	Data Type	Values	Description
H'01	Interface Speed	Get	DWORD	0	Interface speed (indeterminate)
H'02	Interface Flags	Get	DWORD	H'0F	Ethernet port status, refer to the following※1
H'03	Physical Address	Get	ARRAY of 6 USINTs	By Product	MAC address
H'0B	Interface Capability	Get	STRUCT of :	--	Capabilities of Ethernet interface ※2
	Capability Bits		DWORD	H'02000000	The definition of Ethernet interface capability
	Speed/Duplex Options		STRUCT of :	--	The definition of speed and duplex options of Ethernet interface.
	Speed/Duplex Array Count		USINT	H'00	The count of speed/ duplex options.
	Speed/Duplex Array		ARRAY of STRUCT of :	--	Speed and duplex settings

Instance Attribute	Name	Access Rule	Data Type	Values	Description
	Interface Speed		UINT	H'00	Ethernet interface speed. For example, 10 bps and 100 bps would be H'0A and H'64 accordingly.
	Interface Duplex Mode		USINT	H'00	Duplex mode capability of Ethernet interface. For example, half and full duplex would be H'00 and H'01 accordingly.

※1 Interface Flag Table

Bit (s)	Name	Description
0	Link Status	0 indicates an inactive link 1 indicates an active link
1	Half/Full Duplex	0 indicates half duplex 1 indicates full duplex
2-4	Negotiation Status	0 : Auto-negotiation in progress 1 : Auto-negotiation and speed detection failed 2 : Auto negotiation failed but detected speed 3 : Successfully negotiated speed and duplex 4 : Auto-negotiation not attempted. Forced speed and duplex.
5	Manual Setting Requires Reset	shall be set zero
6	Local Hardware Fault	0 indicates the interface detects no local hardware fault 1 indicates a local hardware fault is detected
7-31	Reserved	0

※2 Interface Capability Bits

Bit (s)	Name	Description
0	Manual Setting Requires Reset	Indicates whether or not the device requires a reset when instance attribute #6 (Interface Control attribute) changes. 0 indicates the device does not require a reset 1 indicates the device requires a rest
1	Auto-negotiate	0 indicates the interface does not support auto-negotiaton 1 indicates the interface supports auto-negotiation
2	Auto-MDIX	0 indicates the interface does not support auto MDIX operation 1 indicates the interface supports auto MDIX operation
3	Manual Speed/Duplex	0 indicates the interface does not support to set speed/duplex. (Instance attribute #6, Interface Control attribute) 1 indicates the interface supports to set speed/duplex
4-31	Reserved	shall be set 0

9.4.5 Delta EIP Product List

9.4.5.1 Delta EIP Product List (Adapters Supported)

Positioning	Product	Version
Mid-range PLC	AHCPU501-EN、AHCPU511-EN、AHCPU521-EN、AHCPU531-EN	V2.00
	AHCPU560-EN2	V1.00
	AH10EN-5A	V2.00
	AHRTU-ETHN-5A	V1.00
	AH10EMC-5A	V1.00
	AS300 Series	V1.00
	AS200 Series	V1.00
	AS300Series (AS-FEN02 communication card)	V1.06 (V1.00)
	AS00SCM-A (AS-FEN02 communication card)	V2.02 (V1.00)
	AX-3 Series	V1.01
Small PLC	DVPES2-E Series	V3.60
	DVP26SE	V1.00
	DVP-ES3 Series	V1.00
Inverter	VFD-MS300 Series (CMM-EIP01/02 Communication Card)	V1.00
	VFD-C2000 Series (CMM-EIP01 Communication Card)	V1.06
	VFD-MS300 Series (CMM-EIP03 Communication Card)	V1.00
	VFD-C2000 Series (CMM-EIP02 Communication Card)	V1.00

9.4.5.2 Delta EIP Product List (Scanners Supported)

Positioning	Product	Version
Mid-range PLC	AHCPU501-EN、AHCPU511-EN、AHCPU521-EN、AHCPU531-EN	V2.00
	AHCPU560-EN2	V1.00
	AH10EN-5A	V2.00
	AS300 Series/ AS200 Series	V1.00
	AX-3 Series	V1.01
Small PLC	DVP-ES3 Series	V1.00

MEMO

Chapter 10 Convenience Functions

Table of Contents

10.1	SD Card Functions	10-2
10.1.1	Instructions for Reading/Writing from/to an SD Card	10-2
10.1.2	Startup Command	10-6
10.1.3	Backup and Restore EtherCAT Slave Parameters	10-14

10.1 SD Card Functions

This chapter introduces the functions related to the AX-3 Series PLC and SD card.

10.1.1 Instructions for Reading/Writing from/to an SD Card

If the user wants to write controller data to the SD card or read data from the SD card to the controller, it can be achieved through the "DFB_MemoryRead" and "DFB_MemoryWrite" instructions in the "DL_MemRW_AX3.Library" library.

Note: For detailed information, please refer to Chapter 9 "instructions for Reading and Writing a Memory Card" in the AX Series Standard Instruction Manual.

10.1.1.1 DFB_MemoryRead

FB/FC	Instruction	Graphic Expression	ST Language
FB	DFB_MemoryRead		<pre>DFB_MemoryRead(bExecute:= , FileInfo:= , bDone=> , bBusy=> , bError=> , ErrorID=>);</pre>

● **Input**

Name	Function	Data Type	Setting Value (Default value)
bExecute	Execute the function block. (Rising-edge triggered)	BOOL	True/False (False)
FileInfo	Parameter setting for reading a file.	DFB_READ_FILE_INFO	

■ **DFB_READ_FILE_INFO**

Name	Function	Data Type	Setting Value (Default value)
sFilePath	The name of the file to read.	STRING	(")
wDataMode	ASCII CODE / BINARY mode	DFB_DATA_MODE	DFB_DATA_MODE.ASCII_MODE DFB_DATA_MODE.BINARY_MODE (DFB_DATA_MODE.ASCII_MODE)
wAsciiShowMode	The display mode of data to be read. (Deximal / Hexadecimal)	DFB_ASCII_SHOW_MODE	DFB_ASCII_SHOW_MODE.DECIMAL DFB_ASCII_SHOW_MODE.HEX (DFB_ASCII_SHOW_MODE.DECIMAL)

Name	Function	Data Type	Setting Value (Default value)
wAsciiDec DataType	Data type of the variables to be read.	DFB_DEC_DATATYPE	DFB_DEC_DATATYPE.BYTE_SIZE DFB_DEC_DATATYPE.WORD_SIZE DFB_DEC_DATATYPE.DWORD_SIZE DFB_DEC_DATATYPE.LWORD_SIZE DFB_DEC_DATATYPE.SINT_SIZE DFB_DEC_DATATYPE.USINT_SIZE DFB_DEC_DATATYPE.INT_SIZE DFB_DEC_DATATYPE.UINT_SIZE DFB_DEC_DATATYPE.DINT_SIZE DFB_DEC_DATATYPE.UDINT_SIZE DFB_DEC_DATATYPE.LINT_SIZE DFB_DEC_DATATYPE.ULINT_SIZE DFB_DEC_DATATYPE.REAL_SIZE DFB_DEC_DATATYPE.LREAL_SIZE (DFB_DEC_DATATYPE.BYTE_SIZE)
dwRead StartPos	The starting position of the address to read the memory card's data.*	DWORD	(0)
dwElement Length	The length of the data in the controller's memory card.*	DWORD	1 ~ 25,000 (0)
pDestination	The address of the destination to store the controller's memory data.	POINTER TO BYTE	NULL

*Note: The unit is defined in DFB_READ_FILE_INFO.wAsciiDecDataType.

● Output

Name	Function	Data Type	Output Range (Default value)
bDone	The FB instruction execution is completed.	BOOL	True/False (False)
bBusy	The FB instruction is being executed.	BOOL	True/False (False)
bError	FB instruction error flags.	BOOL	True/False (False)
ErrorID	Error codes	DL_MEMRW_ERROR	DL_MEMRW_ERROR (DFB_NO_ERR)

10.1.1.2 DFB_MemoryWrite

FB/FC	Instruction	Graphic Expression	ST Language
FB	DFB_MemoryWrite		<pre>DFB_MemoryWrite (bExecute:= , FileInfo:= , bDone=> , bBusy=> , bError=> , ErrorID=>);</pre>

● Input

Name	Function	Data Type	Setting Value (Default value)
bExecute	Execute the function block. (Rising-edge triggered)	BOOL	True/False (False)
FileInfo	Parameter setting for writing a file.	DFB_WRITE_FILE_INFO	

■ DFB_WRITE_FILE_INFO

Name	Function	Data Type	Setting Value (Default value)
sFilePath	The name of the file to create.	STRING	(“)
wDataMode	ASCII CODE / BINARY mode	DFB_DATA_MODE	DFB_DATA_MODE.ASCII_MODE DFB_DATA_MODE.BINARY_MODE (DFB_DATA_MODE.ASCII_MODE)
wAsciiShowMode	The display mode of data to be written. (Deximal/ Hexadecimal)	DFB_ASCIISHOW_MODE	DFB_ASCIISHOW_MODE.DECIMAL DFB_ASCIISHOW_MODE.HEX (DFB_ASCIISHOW_MODE.DECIMAL)
wAsciiDecData Type	Data type of the variables to be written.	DFB_DEC_DATA TYPE	DFB_DEC_DATATYPE.BYTE_SIZE DFB_DEC_DATATYPE.WORD_SIZE DFB_DEC_DATATYPE.DWORD_SIZE DFB_DEC_DATATYPE.LWORD_SIZE DFB_DEC_DATATYPE.SINT_SIZE DFB_DEC_DATATYPE.USINT_SIZE DFB_DEC_DATATYPE.INT_SIZE DFB_DEC_DATATYPE.UINT_SIZE DFB_DEC_DATATYPE.DINT_SIZE DFB_DEC_DATATYPE.UDINT_SIZE DFB_DEC_DATATYPE.LINT_SIZE DFB_DEC_DATATYPE.ULINT_SIZE DFB_DEC_DATATYPE.REAL_SIZE DFB_DEC_DATATYPE.LREAL_SIZE (DFB_DEC_DATATYPE.BYTE_SIZE)
wAccessMode	Ways to create files on a memory card	DFB_ACCESS_MODE	DFB_ACCESS_MODE.NEW DFB_ACCESS_MODE.APPEND DFB_ACCESS_MODE.OVERWRITE DFB_ACCESS_MODE.INSERT (DFB_ACCESS_MODE.NEW)
wCarriageReturn	CRLF character*	WORD	(0)

Name	Function	Data Type	Setting Value (Default value)
dwWriteStartPos	The starting position of the address to write data to the memory card.*	DWORD	(0)
dwElementLength	The data length of the file to be written to the memory card.*	DWORD	1 ~ 25,000 (0)
pSource	The address of the memory card to store data.	POINTER TO BYTE	NULL

*Note: The unit is defined DFB_WRITE_FILE_INFO.wAsciiDecDataType.

● Output

Name	Function	Data Type	Setting Value (Default value)
bDone	The FB instruction execution is completed.	BOOL	True/False (False)
bBusy	The FB instruction is being executed.	BOOL	True/False (False)
bError	FB instruction error flags.	BOOL	True/False (False)
ErrorID	Error codes	DL_MEMRW_ERROR	DL_MEMRW_ERROR (DFB_NO_ERR)

10.1.2 Startup Command

The Startup Command provides several different commands for users to execute functions, including project backup, project restore, and firmware update. With these commands, a quick mass replication can be applied on controllers, saving time on individual controller setup.

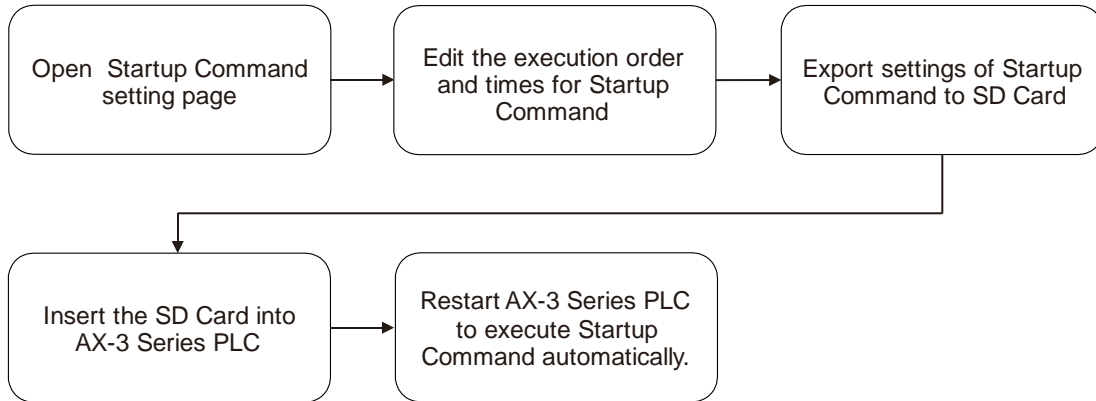

- **Startup Commands**
 - Restore Application from Selected Device
 - Restore Application from Portable Device
 - Restore Source from Current Project
 - Restore Source from Portable Device
 - Restore to Factory Settings
 - Backup Application
 - Backup Source
 - Firmware Update

- **The followings support Startup Commands**
 - AX-3 Series PLC with firmware version V1.0.5.8 or later
 - DIADesigner-AX version V1.4 or later

10.1.2.1 Operation of Startup Command

- **Open Startup Command Setting Page**

You can open the setting page of Startup Command with a specific controller or without. If you open Startup Command Setting Page without selecting a specific controller, you can edit the startup commands, but the applications or project archive cannot be generated.

- Open Startup Command setting page without selecting a specific controller.

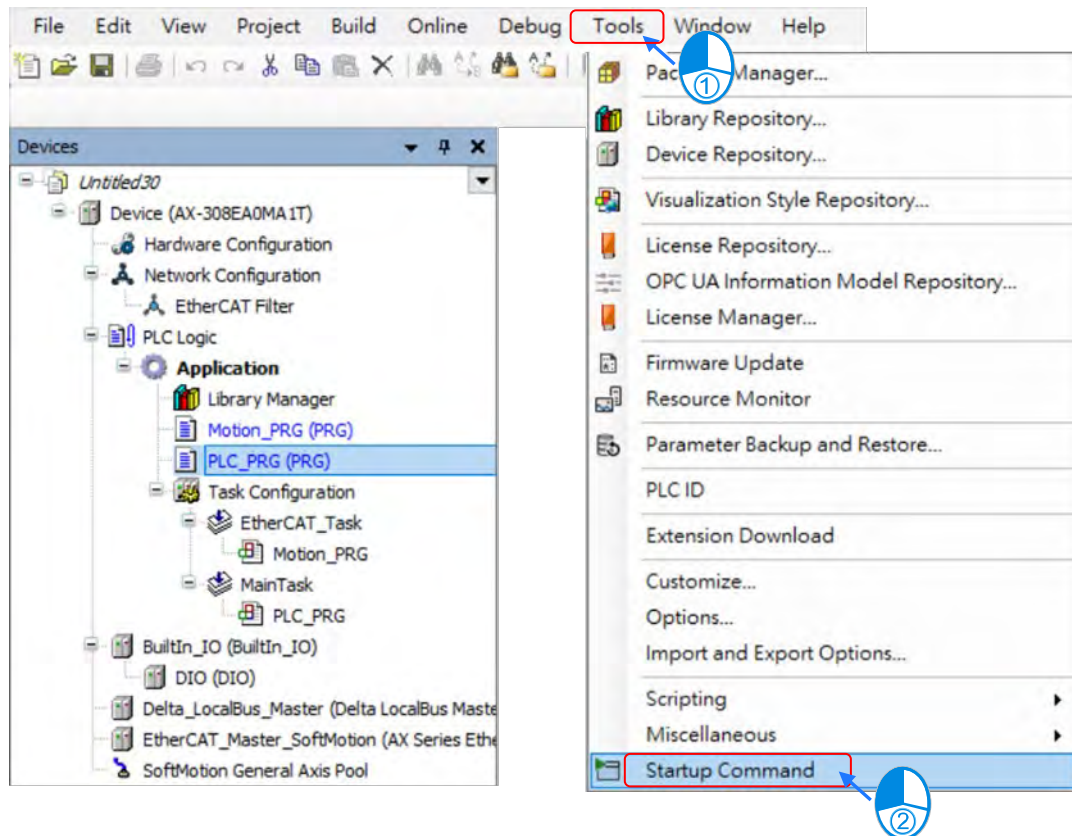



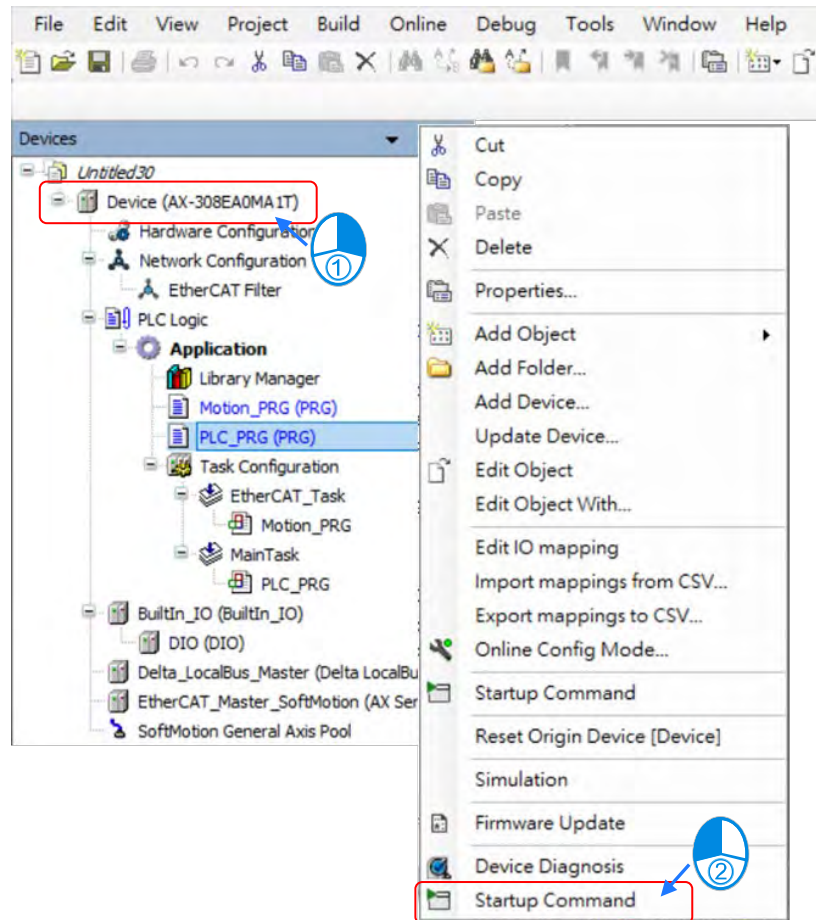



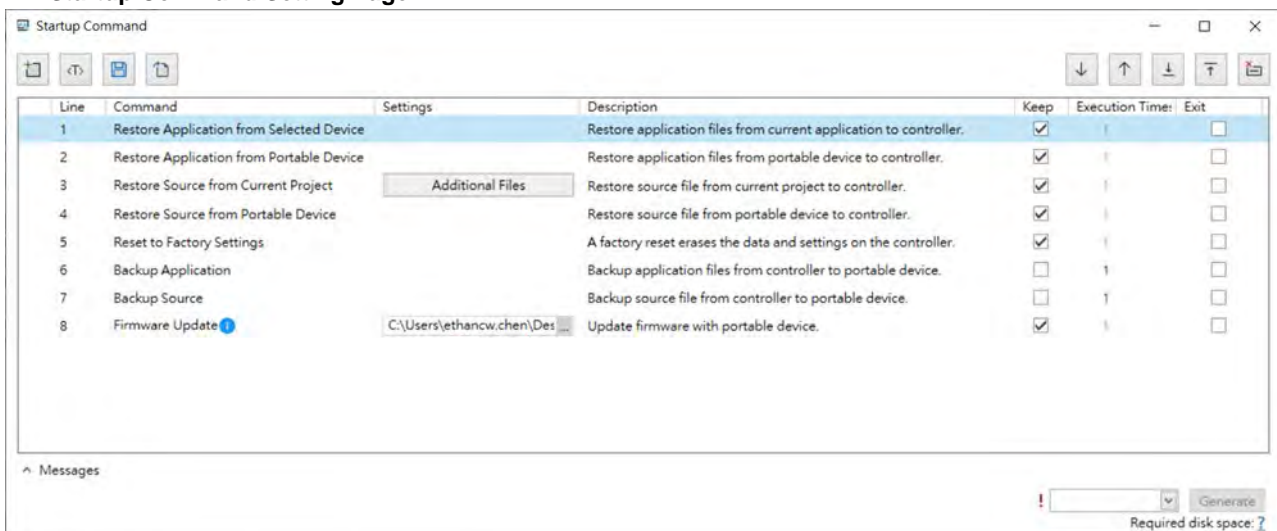

- Open Startup Command setting page with a specific controller



● Startup Command Setting Page



Function Button	Description
	Add or insert Startup Command
	Startup Command template
	Save Startup Command setting file
	Import Startup Command setting file
	Move the selected command downward
	Move the selected command upward
	Move the selected command to the last row
	Move the selected command to the first row
	Delete the selected command
Keep	Ticked: always keep the command Unticked: unselected, after the set execution time has met, the unselected command will be deleted.
Execution Times	The number of times that a command to be executed.
Exit	After this selected command is executed, exit from the startup command. And the rest of the commands are not executed.

● Startup Commands

Startup Command	Description
Restore Application from Selected Device (*1)	Copy the applications from the selected device and save them in a designed folder of a SD card for restoration.
Restore Application from Portable Device	The applications are already stored in a SD card for restoration.
Restore Source from Current Project (*1) (*2)	Copy the project archive from the current project and save it in a designed folder of a SD card for restoration.
Restore Source from Portable Device	The project archive of configuration files is already stored in a SD card for restoration.
Restore to Factory Settings	Restore to factory settings
Backup Application	Backup the applications
Backup Source	Backup the project archive
Firmware Update (*3) (*4)	Firmware update

*1 : Open the Startup Command settings page from the Device tree view to use this command.

*2 : This command allows you to select which types of files need to be imported from the Project Archive.

*3 : To use this command, you need to have the firmware file ready and be able to provide the file path.

*4 : After the firmware update is complete, you need to restart the AX-3 Series PLC and after that the controller can run on the new version of the firmware.

● **Export Startup Command**

After adding and arranging the startup commands on DIADesigner-AX, click **Generate** to export the commands to the SD card. After that you can insert this SD card to AX-3 Series PLC and after power off and then power on, the generated Startup Commands will be executed automatically.

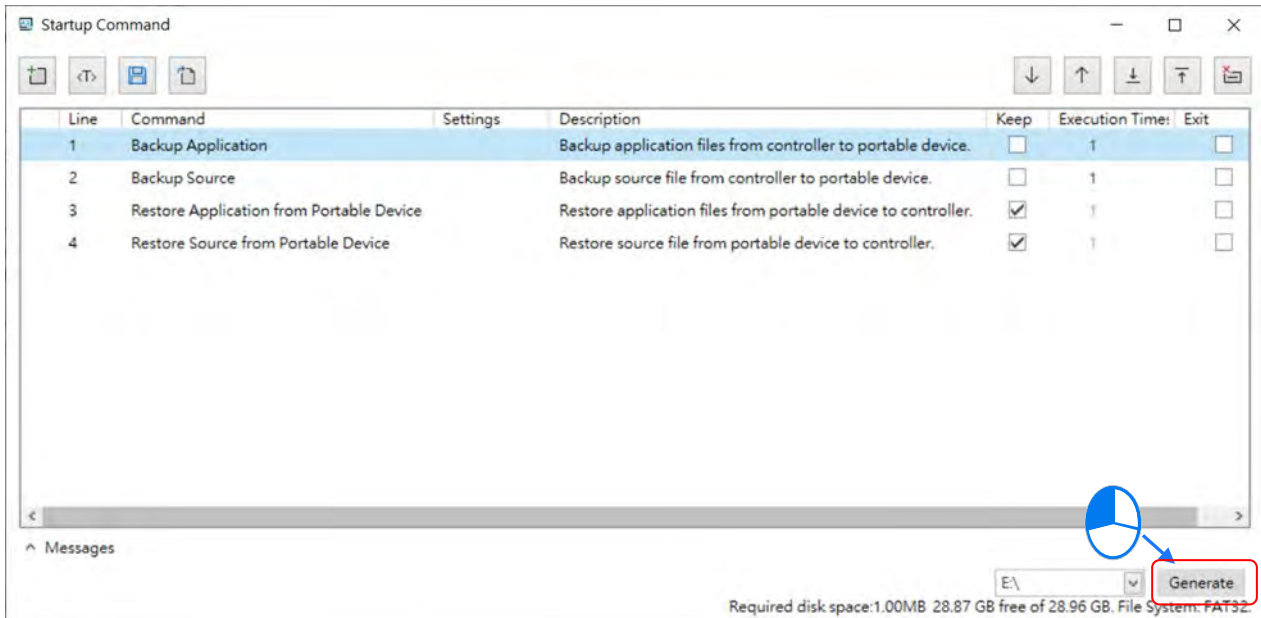

10.1.2.2 Usage Example

- **Example 1: Copying the startup commands of one AX-3 Series PLC (A) to another AX-3 Series PLC (B).**
 - Operation steps:
 1. Click  to open **Startup Command Template** selection page. Select and add “Backup & Restore Application” for your startup commands. Click **Generate** to export the command to the SD card inserted on your PC.
 2. Insert the SD card to the AX-3 Series PLC (A) and then turn the power off and on again to copy the startup commands for backup. Wait for the RUN LED stops blinking to complete the task. And then take out this SD card.
 3. Insert this SD card to the other AX-3 Series PLC (B). Turn the power off and then power on this AX-3 Series PLC (B) and the backup startup commands will be copied to this AX-3 Series PLC (B). Wait for the RUN LED stops blinking to complete the task. And then AX3- Series PLC (B) is loaded with applications from AX3- Series PLC (A).

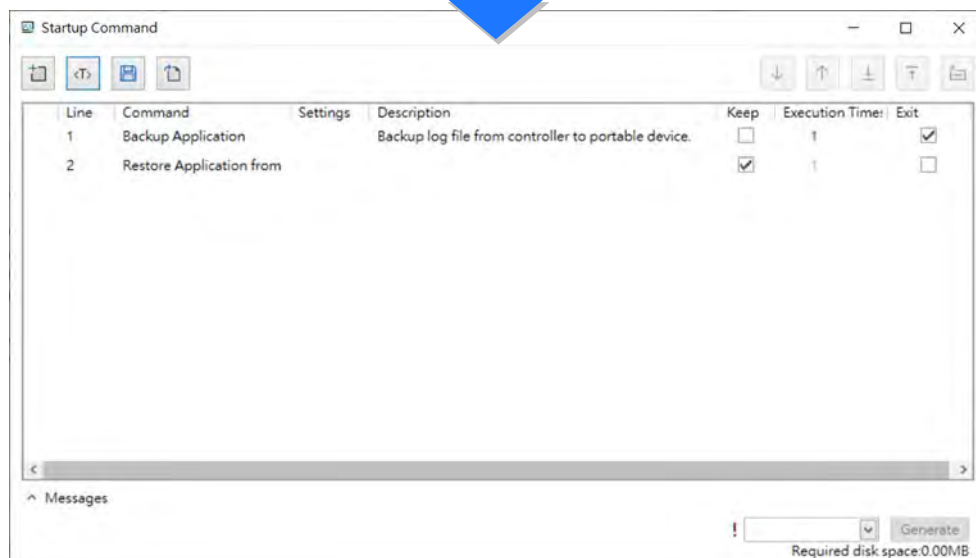
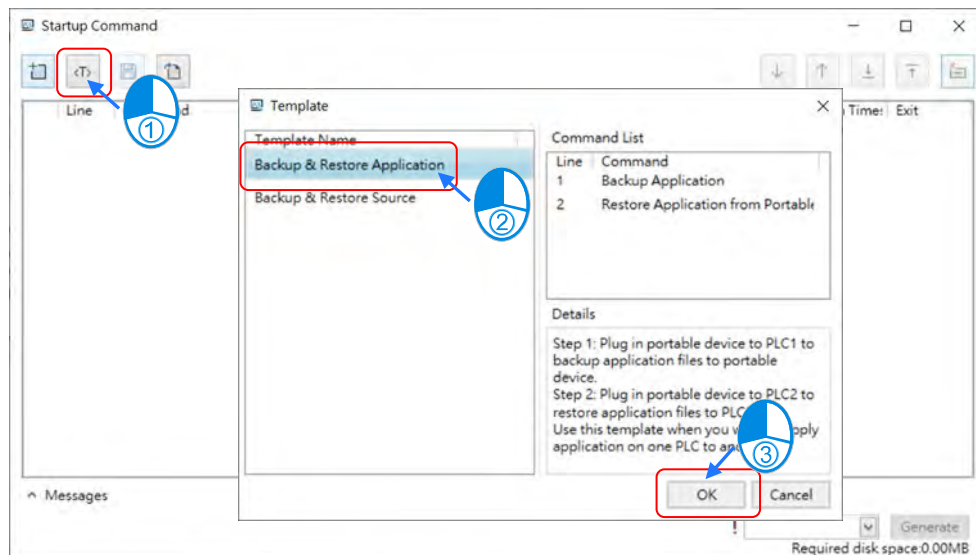

● **Example 2: Firmware update on AX-3 Series PLC.**

■ Operation steps:

1. Click  and add "Firmware Update" for your startup commands. Click **Generate** to export the command to the SD card inserted on your PC.
2. Insert the SD card to the AX-3 Series PLC and then turn the power off and on again to update firmware. Wait for the RUN LED stops blinking to complete the task.
3. Take out this SD card and turn the power off and on again. After that the controller can run on the new version of the firmware. (If you did not restart the controller, it will run on the old version of the firmware.)

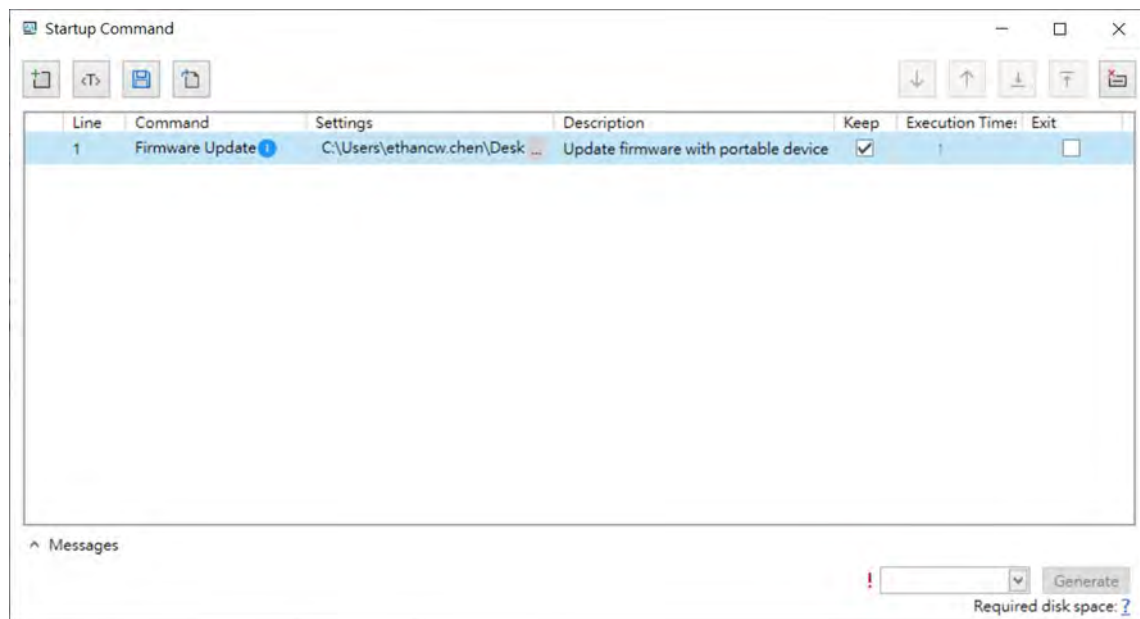

- **Example 3: If the login account and password of the AX-3 Series PLC are lost, it is necessary to restore it to its factory settings and restore the applications as well as the project archive.**

- Operation steps:

1. Click  and add “Reset to Factory Settings”, “Restore Application from Portable Device” and “Restore Source from Portable Device” for your startup commands. Click **Generate** to export the commands to the SD card inserted on your PC.
2. Insert the SD card to the AX-3 Series PLC and then turn the power off and on again to execute the startup commands. Wait for the RUN LED stops blinking to complete the task.
3. Take out this SD card. The AX-3 Series PLC is now reset to factory settings and with applications and project archive from the SD card.

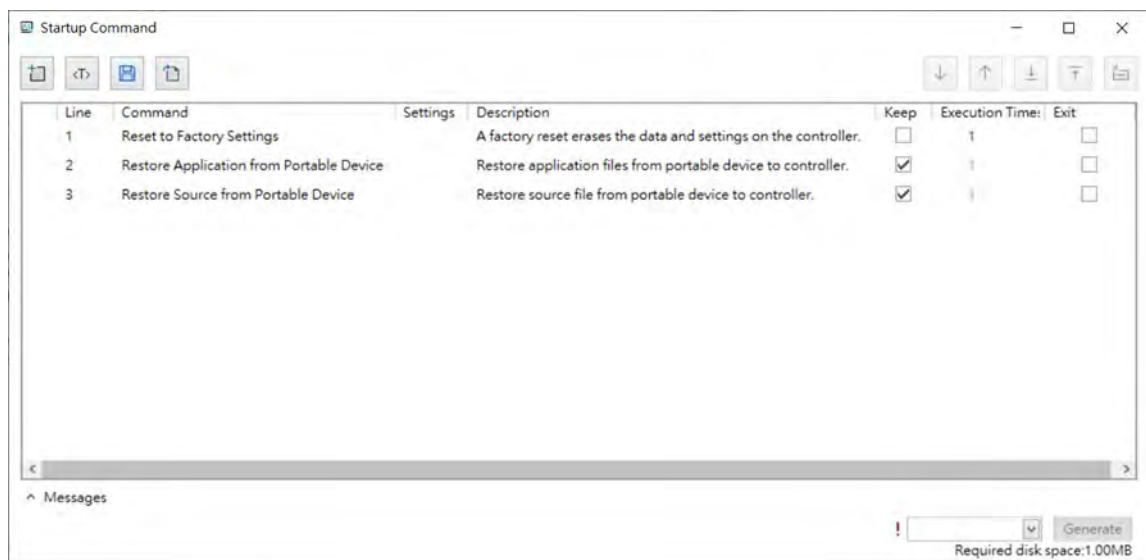

10.1.3 Backup and Restore EtherCAT Slave Parameters

- **Supported version for backup and recovery**
 - AX-3 series firmware version: V1.0.2.0 and above
 - DIADesigner-AX version: V1.2 and above
 - Only models ASDA-A3-E and ASDA-B3-E are supported for parameter backup and recovery.
 - ◆ ASDA-A3-E firmware version: V11165 sub 92 and above
 - ◆ ASDA-B3-E firmware version: V10665 sub 75 and above

- **Data that is backed up**

Servo parameters P0~P4 (Not including P0.001 and P4.000), P5.0003, P5.0008~P5.0009, P5.0020~P5.0030 and P6.0000~P6.0001.

Note: For more details, please refer to section 9.1.4 "Backup Parameters for EtherCAT Slaves" in the AX-3 series operating manual.

- **Parameter Backup and Restore page**

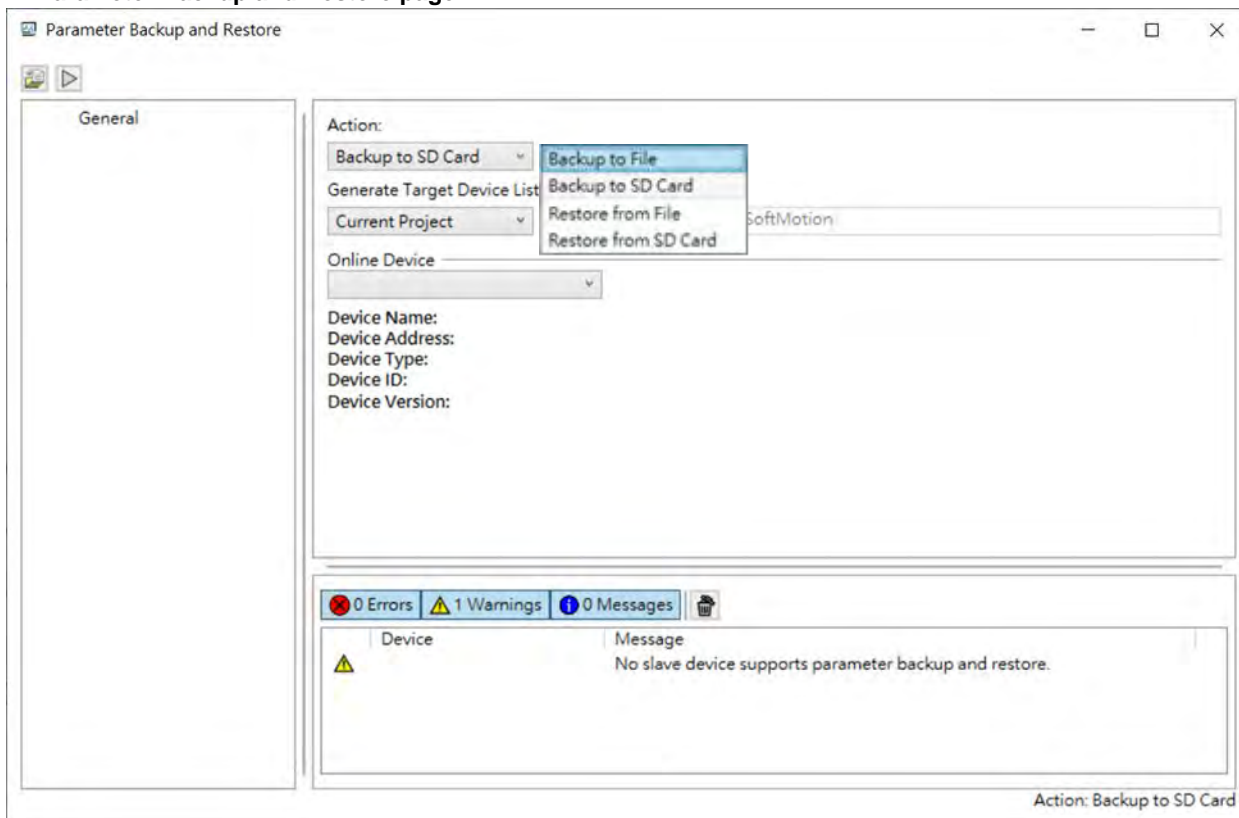

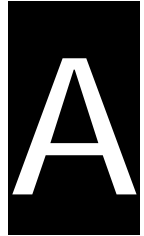

Appendix A Troubleshooting

Table of Contents

- A.1 Troubleshooting A-2**
 - A.1.1 Basic Troubleshooting Steps..... A-2
 - A.1.2 Clear the Error States..... A-2
 - A.1.3 Troubleshooting SOP A-3
 - A.1.4 Viewing Log A-3

- A.2 Troubleshooting of CPU Modules A-6**
 - A.2.1 ERROR LED Indicators Blinking Every 0.5 Seconds A-6
 - A.2.2 ERROR LED Indicators Blinking Rapidly Every 0.2 Seconds..... A-8
 - A.2.3 ERROR LED Indicators Slow Blinking Every 3 Seconds and Lighting up
for 1 Second A-8
 - A.2.4 BAT. LOW LED Indicators Are ON..... A-8
 - A.2.5 BAT. LOW LED Indicators Blinking Every 0.5 Seconds..... A-9
 - A.2.6 Others..... A-9

- A.3 Troubleshooting of the Function Blocks..... A-10**
 - A.3.1 DL_BuiltInIO_AX3..... A-10
 - A.3.2 Motion Control Related Instructions..... A-13

- A.4 Troubleshooting of I/O Modules..... A-14**
 - A.4.1 Troubleshooting of Analog Modules (AD/DA/XA) and Temperature Modules
(RTD/TC) A-14
 - A.4.2 Troubleshooting of Loadcell Modules AS02LC..... A-16

- A.5 Error Codes and LED Indicators for CPU Modules A-17**
 - A.5.1 Error Codes and LED Indicators for CPU Modules A-18
 - A.5.2 Error Codes and LED Indicators for Analog and Temperature Module .. A-20

A.1 Troubleshooting

A.1.1 Basic Troubleshooting Steps

This chapter includes the possible errors that can occur during operation, their causes, and corrective actions.

(1) Check the following:

- The PLC should be operated in a safe environment (consider environmental, electronic, and vibration safety).
- Connect power supply correctly to the PLC.
- Secure the module, terminal, and cable installations.
- All LED indicators show correctly.
- Set all switches correctly.

(2) Check the following operational functions:

- Switch the RUN/STOP state
- Check the settings for the AX-3 Series to RUN/STOP
- Check and eliminate errors from external devices
- Use the System Log function in DIADesigner-AX to check system operation and logs

(3) Identify possible causes:

- AX-3 Series or external device
- CPU or extension modules
- Parameters or program settings

A.1.2 Clear the Error States

Use the following methods to clear the error states. If the error source is not corrected, the system continues to show errors.

(1) Switch the CPU model state to STOP and then to RUN.

(2) Turn off the CPU and turn it on again.

(3) Use DIADesigner-AX to perform **Reset Warn** to clear the error logs.

(4) Use DIADesigner-AX to perform **Reset Origin** to reset the CPU to default settings and then redownload the program to start again.

A.1.3 Troubleshooting SOP

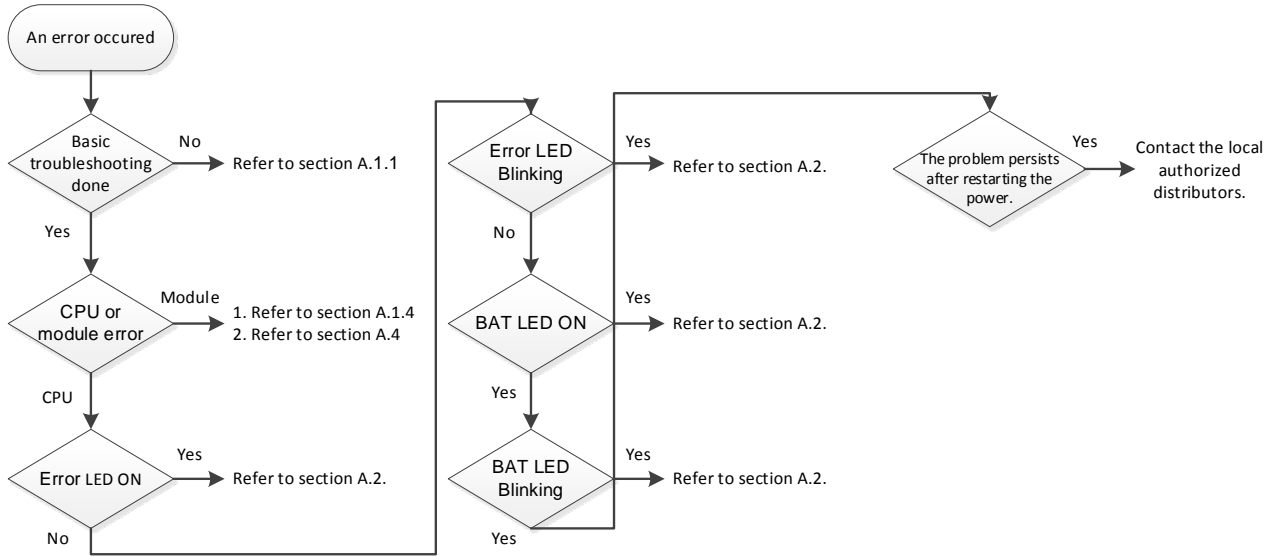

A.1.4 Viewing Log

When an error occurs, the system generates corresponding error codes and stores the error messages in the PLC. You can find events during the startup and shutdown of the system, application download and loading of the boot application, custom entries, log entries from I/O drivers, and log entries from data sources on the Log tab of the Device setting page. Refer to section 4.2.1.5 for more information on Log.

1. Log Tab

Double-click the **Device** in the tree view to open the Device setting page and then you can find Log tab on the left section.

Severity	Time Stamp	Description	Component
Information	01.01.1970 08:05:31	[CAN]EVT_StartDone!!	IoDrvDelta
Information	01.01.1970 08:05:31	[MTCPSlave]EVT_StartDone!!	IODrvDeltaModbusTCPS
Information	01.01.1970 08:05:31	[CAN]EVT_PrepareStart!!	IoDrvDelta
Information	01.01.1970 08:05:31	[MTCPSlave]EVT_PrepareStart!!	IODrvDeltaModbusTCPS
Information	01.01.1970 08:00:13	CODESYS Control ready	CM
Information	01.01.1970 08:00:13	CH_INIT_FINISHED	CmpDeltaConnHandler
Information	01.01.1970 08:00:13	Application [Application] not started	CmpApp
Information	01.01.1970 08:00:13	Application [Application] denied to start ev...	CmpApp
Information	01.01.1970 08:00:13	CH_INIT_COMM	CmpDeltaConnHandler
Information	01.01.1970 08:00:13	CH_INIT_COMM	IoDrvAX308_Counter_Timer
Information	01.01.1970 08:00:13	CH_INIT_COMM	IoDrvAX308_Capture_Compare
Information	01.01.1970 08:00:13	CH_INIT_TASKS	CmpDeltaConnHandler
Information	01.01.1970 08:00:13	CH_INIT_TASKS	IoDrvAX308_Counter_Timer
Information	01.01.1970 08:00:13	CH_INIT_TASKS	IoDrvAX308_Capture_Compare
Information	01.01.1970 08:00:13	Setting router 2 address to (2ddc:c0a8:0...	CmpRouter
Information	01.01.1970 08:00:13	Setting router 1 address to (0000)	CmpRouter
Information	01.01.1970 08:00:13	Setting router 0 address to (0005)	CmpRouter
Information	01.01.1970 08:00:13	IoDrvEthernetIP	IoDrvEtherNetIP
Warning	01.01.1970 08:00:13	Retain size in config changed, or retain are...	CmpRetain
Information	01.01.1970 08:00:13	Bootproject of application [Application] loa...	CmpApp



2. Files

The system generates log files (.csv) when the PLC is power-off or the log exceeds 64 KB. You can read the log file from the Files tab of the Device setting page.

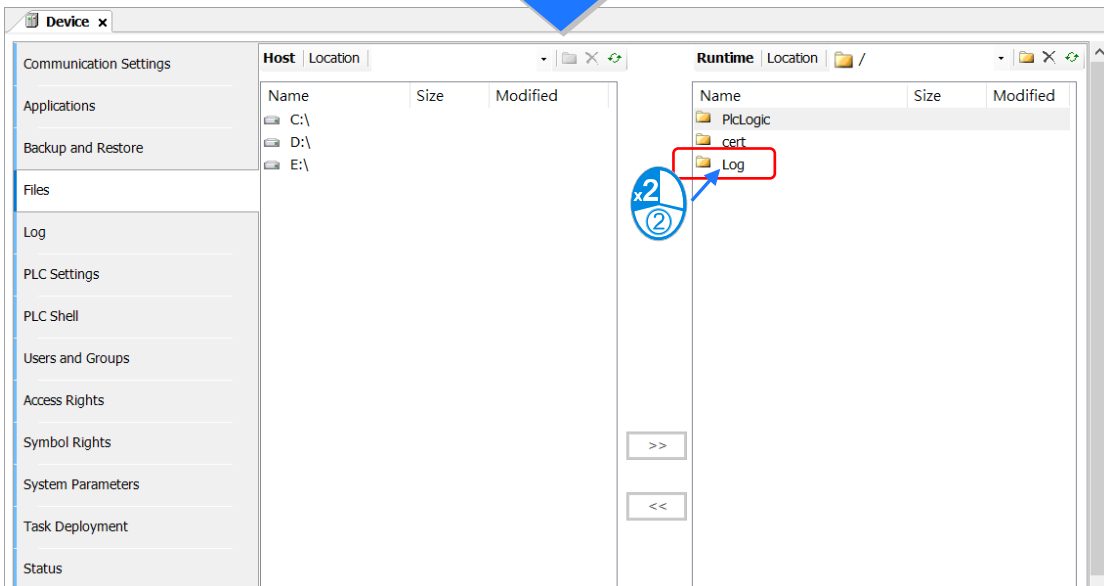
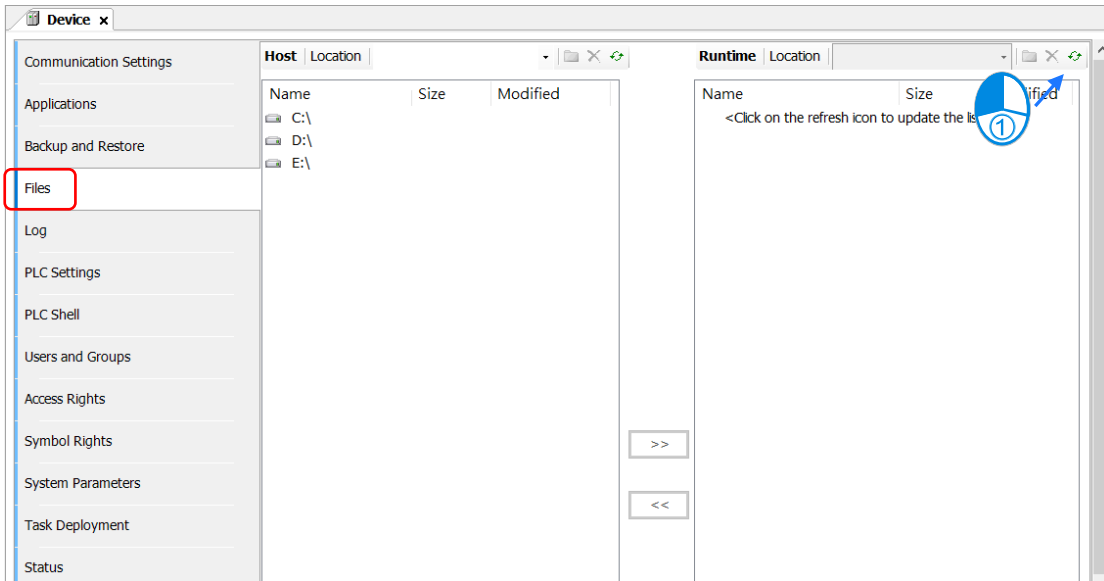



The screenshot shows a software window titled 'Device x'. On the left is a navigation pane with categories like 'Communication Settings', 'Applications', 'Backup and Restore', 'Files', 'Log', 'PLC Settings', 'PLC Shell', 'Users and Groups', 'Access Rights', 'Symbol Rights', 'System Parameters', 'Task Deployment', and 'Status'. The main area is split into two panes. The left pane is titled 'Host' and shows a file system view with columns 'Name', 'Size', and 'Modified', listing drives C:\, D:\, and E:\. The right pane is titled 'Runtime' and shows a file list with columns 'Name', 'Size', and 'Modified'. The file list contains ten entries, all named 'StdLogger52...' followed by a number and '_19700....', with a size of '64.50 K...' and a modified date of '1980/1/...'. Below the file list are two buttons: '>>' and '<<'.

Name	Size	Modified
StdLogger52276_19700....	64.50 K...	1980/1/ ...
StdLogger52277_19700....	64.50 K...	1980/1/ ...
StdLogger52278_19700....	64.50 K...	1980/1/ ...
StdLogger52279_19700....	64.50 K...	1980/1/ ...
StdLogger52..._19700....	64.50 K...	1980/1/ ...
StdLogger52..._19700....	64.50 K...	1980/1/ ...
StdLogger52..._19700....	64.50 K...	1980/1/ ...
StdLogger52..._19700....	64.50 K...	1980/1/ ...
StdLogger52..._19700....	64.50 K...	1980/1/ ...
StdLogger52..._19700....	64.50 K...	1980/1/ ...
StdLogger52..._19700....	64.50 K...	1980/1/ ...

A.2 Troubleshooting of CPU Modules

Check the LED indicators and the error codes from the CPU module and refer to the following table for troubleshooting.

A.2.1 ERROR LED Indicators Blinking Every 0.5 Seconds

- CPU ERROR

Error Code (16#)	Description	Solution
140E	More than eight remote modules on the right side of the CPU module.	Check the total number of remote modules on the right side of the CPU module (maximum is 8).
1600	The extension module ID exceeds the range.	1. Make sure the module is properly connected to the CPU module and turn the modules on again. 2. If the problem persists, contact the local authorized distributors.
1601	The extension module ID cannot be set.	1. Make sure the module is properly connected to the CPU module and turn the modules on again. 2. If the problem persists, contact the local authorized distributors.
1602	The extension module ID is duplicated.	1. Make sure the module is properly connected to the CPU module and turn the modules on again. 2. If the problem persists, contact the local authorized distributors.
1603	The extension module cannot be operated.	1. Make sure the module is properly connected to the CPU module and turn the modules on again. 2. If the problem persists, contact the local authorized distributors.
1604	Extension module communication timeout	1. Make sure the module is properly connected to the CPU module and turn the modules on again. 2. If the problem persists, contact the local authorized distributors.
2000	CPU memory access is denied.	If the problem persists, contact the local authorized distributors.
2001	CPU external memory access is denied.	If the problem persists, contact the local authorized distributors.
2100	The number of MODBUS TCP connections exceeds the range.	Check if the number of Modbus TCP connection (Server+Client) exceeds the maximum number 32.
2200	The arrangement of the I/O modules is not consistent with the settings.	Check whether the settings in Hardware Configuration are consistent with the arrangement of the I/O modules.
2201	The number of connected communication modules exceed the maximum number 4.	Check the total number of communication modules.
2202	The number of connected positioning modules exceed the maximum number 8.	Check the total number of positioning modules.
2203	The number of connected extension modules exceed the maximum number 32.	Check the total number of extension modules.

● EtherCAT ERROR

Error Code (16#)	Description	Solution
1	EtherCAT communication lost	Make sure the terminal and cable are properly connected to the CPU module. Execute the function block, DFB_ResetECATMaster, to reset the EtherCAT Master.
2	EtherCAT data mapping failed	Make sure the terminal and cable are properly connected to the CPU module. Execute the function block, DFB_ResetECATMaster, to reset the EtherCAT Master.
4	Incorrect EtherCAT network name	Make sure the Network Name/address is correctly set on the setting page of the EtherCAT Master.
5	EtherCAT Slave failed to initialize	Make sure the actual placement is the same as the settings in the Network Configuration.
6	Vendor ID of the Slave does NOT match.	<ul style="list-style-type: none"> ● Make sure the actual placement is the same as the settings in the Network Configuration. ● Make sure the ESI file of the Slave is matched. ● Disable the Startup Checking item to cancel checking Vendor ID on the EtherCAT Master setting page.
7	Product ID of the Slave does NOT match.	<ul style="list-style-type: none"> ● Make sure the actual placement is the same as the settings in the Network Configuration. ● Make sure the ESI file of the Slave is matched. ● Disable the Startup Checking item to cancel checking Product ID on the EtherCAT Master setting page.

Note: EtherCAT error LED is defined by the Library IODrvEtherCAT.

A.2.2 ERROR LED Indicators Blinking Rapidly Every 0.2 Seconds

The blinking happens when the power supply 24 VDC of the CPU module is disconnected, or the power supply is not sufficient, not stable or abnormal.

Error Code (16#)	Description	Solution
2004	The external voltage is abnormal.	Check whether the external 24 V power supply to the module is normal.

A.2.3 ERROR LED Indicators Slow Blinking Every 3 Seconds and Lighting up for 1 Second

Error Code (16#)	Description	Solution
7	The operation system file of the firmware is broken.	<ol style="list-style-type: none"> 1. Upgrade device firmware 2. After firmware is upgraded, if the problem persists, contact the local authorized distributors.
8	Parts of the firmware components are broken.	<ol style="list-style-type: none"> 1. Upgrade device firmware 2. After firmware is upgraded, if the problem persists, contact the local authorized distributors.
D	Checksum error occurs in the %M device.	<ol style="list-style-type: none"> 1. Make sure the external 24 V power supply to the module is functioning normally. 2. After firmware is upgraded, if the problem persists, contact the local authorized distributors.
1800 ~ 180F	Errors occurred in the extension modules	Refer to section A.4 for more information on the extension module error codes.

A.2.4 BAT. LOW LED Indicators Are ON

The blinking happens when there is no battery (CR1620) or the power is low. Turn this functionality off on the System Parameter setting page. (Device -> System Parameter -> Show Battery Low Voltage Error) when you don't need the RTC function to keep track of the current time (default is "enabled").

Error Code (16#)	Description	Solution
2003	Battery Low	Change battery or turn this option off

A.2.5 BAT. LOW LED Indicators Blinking Every 0.5 Seconds

The blinking happens when RTC cannot keep track of the current time.

Error Code (16#)	Description	Solution
2002	RTC cannot keep track of the current time	If the problem persists, contact the local authorized distributors.

A.2.6 Others

Error Code (16#)	Description	Solution
2500	The firmware version of the PLC is not in accordance with what stated on the DDF (Device Description File).	Check the firmware version of the PLC and the requirement on the DDF.
2501	SSI encoder is NOT connected to PLC.	Check the connection between SSI encoder and PLC.
2502	The setting value of the single turn and multiturn SSI encoders exceed the setting limit. (up to 32 bits).	The setting value of the single turn and multiturn SSI encoder should not exceed the maximum of 32 bits.
2503	An error occurs when the pulse outputs.	Check the log of the corresponding pulse on the ON-LINE monitoring page.

A.3 Troubleshooting of the Function Blocks

A.3.1 DL_BuiltInIO

The following errors are specified as warnings; however no error indicators will appear and the AX-3 Series CPU can still run.

Error Code (16#)	Item Name	Description	Solution
0	DFB_HSIO_NO_ERR	No error on the high speed IO function block	-
186A0	DMC_HP_INVALID_HOME_SPEED	The speed set in the homing motion on the pulse axis is invalid.	The setting value in the fields of Search for Switch and Search for Z Phase Pulse on the setting page of Pulse Axis cannot not be set to 0. Set a non-zero value.
186A1	DMC_HP_INVALID_HOME_ACC_DEC	The acceleration set or the deceleration set in the homing motion is invalid.	The setting value in the fields of acceleration and deceleration in the homing motion on the setting page of Pulse Axis cannot not be set to 0. Set a non-zero value.
186A2	DMC_HP_INVALID_HOME_POSITION	The position set in the homing motion is invalid.	Set the function block pin, IrPosiotion, in the range of [0 ~ PulseAxis.Modulo Value].
186A3	DMC_HP_AXIS_NOT_PULSE_AXIS	The variable of the function block pin is NOT a PulseAxis_REF type.	Make sure to select Pulse Axis on the IO Configuration setting page and import IEC Object to the pin "Axis" of the function block DMC_Home_P.
186A4	DMC_HP_HOMING_METHOD_RESERVED	This version does NOT support this type of homing mode.	Check if this type of homing mode is supported in this version. Refer to the specification and then change the mode accordingly.
186A5	DMC_HP_HOMING_MOMENT_HW_LIMIT	If the positive/negative limit is activated, the axis cannot move in this homing mode.	Make sure the hardware limit used is supported by this homing mode. Refer to the specification and then change the mode or the setting accordingly.
186A6	DMC_HP_HOMING_AXIS_STATE_NOT_STANDSTILL	The state of the pulse axis is not at standstill.	Make sure the function block DMC_Home_P is executed when the axis state is at standstill.
186AC	DFB_CAP_INVALID_CAPTURE_REF	The variable of the function block pin is NOT a Capture_REF type.	Make sure to select Capture on the IO Configuration setting page and import IEC Object to the pin "Capture" of the function block DMC_Capture.
186AD	DFB_CAP_INVALID_COUNTER_REF	The variable of the function block pin is NOT a Counter_REF type.	Make sure to select Counter on the IO Configuration setting page and import IEC Object to the pin "Counter" of the function block DMC_Capture.
186AE	DFB_CAP_INVALID_UI_MASK_SETTING	The mask setting value (uiMaskValue) in DFB_Capture exceeds the range of rotary axis.	Set the pin "uiMaskValue" of the function block DFB_Capture in the range of [0 ~ EncoderAxis.Modulo Value].
186AF	DFB_CAP_INVALID_DI_DELTA_RANGE	When the encoder of high-speed counter is a rotary axis and the pin of "diDeltaMax" or "diDeltaMin" exceeds the range of rotary axis.	Set the pin "diDeltaMax" or "diDeltaMin" of the function block DFB_Capture in the range of [0 ~ EncoderAxis.Modulo Value].
186B0	DFB_CAP_CAPTURE_ALREADY_ENABLED	The device for high-speed capture is already enabled.	Check if the device for high-speed capture is already enabled by other DFB_Capture.

Error Code (16#)	Item Name	Description	Solution
186B6	DFB_CMP_INVALID_COMPARE_REF	The variable of the function block pin is NOT a Compare_REF type.	Make sure to select Compare on the IO Configuration setting page and import IEC Object to the pin "Counter" of the function block DMC_Compare.
186B7	DFB_CMP_INVALID_COUNTER_REF	The variable of the function block pin is NOT a Counter_REF type.	Make sure to select Counter on the IO Configuration setting page and import IEC Object to the pin "Counter" of the function block DMC_Compare.
186B8	DFB_CMP_INVALID_CMP_PVALUE	When the encoder of high-speed counter is a rotary axis and the pin of "diCompareValue" exceeds the range.	Set the pin "diCompareValue" of the function block DFB_Compare in the range of [0 ~ EncoderAxis.Modulo Value].
186B9	DFB_CMP_INVALID_REFRESH_CYCLE	The setting value of input pin "wRefreshCycle" exceeds the range of [0-30000], unit 0.1us.	Set the pin "wRefreshCycle" of the function block DFB_Compare in the range of [0 ~ 30000].
186BA	DFB_CMP_COMPARE_ALREADY_ENABLED	The device for high-speed compare is already enabled.	Check if the device for high-speed compare is already enabled by other DFB_Compare.
186C0	DFB_HC_INVALID_COUNTER_REF	The variable of the function block pin is NOT a Counter_REF type.	Make sure to select Counter on the IO Configuration setting page and import IEC Object to the pin "Counter" of the function block DMC_HCnt.
186C1	DFB_HC_COUNTER_ALREADY_ENABLED	The device for high-speed counter is already enabled.	Check if the device for high-speed counter is already enabled by other DFB_HCnt.
186C2	DFB_HC_COUNTER_REF_CHANGED_DURING_OPERATION	The input pin "Counter" has been changed during the execution of the function block.	Check if the variable of the pin "Counter" has been changed after the execution of the DFB_HCnt.
186C8	DFB_HT_INVALID_TIMER_REF	The variable of the function block pin is NOT a Timer_REF type.	Make sure to select Timer on the IO Configuration setting page and import IEC Object to the pin "Timer" of the function block DFB_HTmr.
186C9	DFB_HT_TIMER_ALREADY_ENABLED	The device for high-speed timer is already enabled.	Check if the device for high-speed timer is already enabled by other DFB_HTmr.
186CA	DFB_HT_TIMER_REF_CHANGED_DURING_OPERATION	The input pin "Timer" has been changed during the execution of the function block.	Check if the variable of the pin "Timer" has been changed after the execution of the DFB_HTmr.
186D0	DFB_PV_INVALID_COUNTER_REF	The variable of the function block pin is NOT a Counter_REF type.	Make sure to select Counter on the IO Configuration setting page and import IEC Object to the pin "Counter" of the function block DFB_PresetValue.
186D1	DFB_PV_NOT_ENABLE_EXTERNAL_TRIGGER	The counter is not set as triggered externally but the mode of DFB_PresetValue is set to "EXTERNAL_TRIGGER".	Make sure to select External Trigger on the Counter Configuration page.
186D2	DFB_PV_PREVIOUS_RESET_NOT_DONE	The preset counting function of the counter has been enabled by other function block	Execute this function block after the execution of DFB_PresetValue of this counter completes.

Error Code (16#)	Item Name	Description	Solution
		DMC_PresetValue and is not done yet.	
186D3	DFB_PV_CANNOT_PRESET_WHEN_SAMPLING	The counter is executing DFB_Sample.	Disable the sample function of this counter. Disable DFB_Sample of this counter.
186D4	DFB_PV_SETRING_NOT_DONE	The counter is executing DFB_SetRing and is not done yet.	Execute this function block after the execution of DFB_SetRing of this counter completes.
186D5	DFB_PV_INVALID_PRESET_VALUE	When the encoder of high-speed counter is a rotary axis and the pin of "diPresetValue" exceeds the range.	Set the pin "diPresetValue" of the function block in the range of [0 ~ EncoderAxis.Modulo Value].
186D6	DFB_PV_COUNTER_REF_CHANGED_DURING_OPERATION	The input pin "Counter" has been changed during the execution of the function block.	Check if the variable of the pin "Counter" has been changed after the execution of the DFB_PresetValue.
186DC	DFB_SP_INVALID_COUNTER_REF	The variable of the function block pin is NOT a Counter_REF type.	Make sure to select Counter on the IO Configuration setting page and import IEC Object to the pin "Counter" of the function block DMC_Sample.
186DD	DFB_SP_COUNTER_NOT_ENABLE	The function block DFB_Counter is not enabled yet.	Execute DFB_Sample after making sure this counter is enabled by DFB_HCnt.
186DE	DFB_SP_ALREADY_SAMPLING	The counter is executing DFB_Sample.	Check if this counter is enabled by other DFB_Sample.
186DF	DFB_SP_PRESET_NOT_DONE	The counter is executing DFB_PresetValue and is not done yet.	Execute this function block after the execution of DFB_PresetValue of this counter completes.
186E0	DFB_SP_INVALID_SAMPLE_TIME	The setting value of input pin "wSampleTime" of the function block DFB_Sample exceeds the range of [10-65535].	Set the pin "wSampleTime" of the function block DFB_Sample in the range of [10-65535].
186E1	DFB_SP_COUNTER_REF_CHANGED_DURING_OPERATION	The input pin "Counter" has been changed during the execution of the function block.	Check if the variable of the pin "Counter" has been changed after the execution of the DFB_Sample.
186E7	DFB_SR_INVALID_COUNTER_REF	The variable of the function block pin is NOT a Counter_REF type.	Make sure to select Counter on the IO Configuration setting page and import IEC Object to the pin "Counter" of the function block DFB_SetRing.
186E8	DFB_SR_COUNTER_HAS_NO_CHILD_ENCODER_AXIS	No child node of the high-speed counter is connected to the encoder.	Insert EncoderAxis into the counter and set the encoder type to rotary axis and reexecute the function block.
186E9	DFB_SR_COUNTER_NOT_ROT_RING	The encoder of the high-speed counter is not a rotary axis type.	Select the encoder type to rotary axis on the Counter Configuration page.
186EA	DFB_SR_PREVIOUS_SETRING_NOT_DONE	The preset counting function of the counter has been enabled by other function block DMC_SetRing and is not done yet.	Execute this function block after the execution of DFB_SetRing of this counter completes.

Error Code (16#)	Item Name	Description	Solution
186EB	DFB_SR_PRESET_NOT_DONE	The counter is executing DFB_PresetValue and is not done yet.	Execute this function block after the execution of DFB_PresetValue of this counter completes.
186EC	DFB_SR_INVALID_RING_RANGE	When the encoder of high-speed counter is a rotary axis and the pin of "diPositionPeriod" is less than 0 and bigger than the setting value of bSetDown.	Set the pin "diPositionPeriod" of the function block bigger than 0 and less than the setting value of bSetDown.
186ED	DFB_SR_COUNTER_REF_CHANGED_DURING_OPERATION	The input pin "Counter" has been changed during the execution of the function block.	Check if the variable of the pin "Counter" has been changed after the execution of the DFB_SetRing.

Note: DL_BuiltInIO_AX3, the library name, has changed to DL_BuiltInIO for AX-3 Series PLC CPU with firmware version V1.0.5.0 or later.

A.3.2 Motion Control Related Instructions

The errors occurred in DL_MotionControl or DL_MotionControlLight are specified as warnings; however no error indicators will appear and the AX-3 Series CPU can still run. Refer to AX Series Motion Controller Manual for the troubleshooting of DL_MotionControl.

A.4 Troubleshooting of I/O Modules

- **Introduction to troubleshooting modules**

The following AS series modules can be installed in an AX-3 Series system. There are 2 types of error codes; error and warning. The CPU module and its modules stop operating when errors occur. The CPU modules and its modules do not stop operating when warnings are triggered.

A.4.1 Troubleshooting of Analog Modules (AD/DA/XA) and Temperature Modules (RTD/TC)

A.4.1.1 ERROR ERROR LED Indicators Are ON

You can set up the option to be **True** in **Module Alarm Setting** to have the following errors appear as warnings when they occur. Otherwise, when an error occurs, only an error message appears.

Error Code (16#)	Description	Solution
16#1605	Hardware failure	If the problem persists, contact the local authorized distributors.
16#1607	The external voltage is abnormal.	Check the power supply.
16#1608	The factory calibration or the CJC is abnormal.	If the problem persists, contact the local authorized distributors.

A.4.1.2 ERROR LED Indicators Blinking Every 0.2 Seconds

The following errors are specified as warnings to ensure that the AX-3 Series CPU can still run even when the warnings are triggered by its AIO modules. If you need the CPU STOP running immediately when the first 4 errors occur, you need to set the them as errors.

Error Code (16#)	Description	Solution
16#1801	The external voltage is abnormal.	Check the power supply.
16#1802	Hardware failure	If the problem persists, contact the local authorized distributors.
16#1804	The factory calibration is abnormal.	If the problem persists, contact the local authorized distributors.
16#1807	The CJC is abnormal.	If the problem persists, contact the local authorized distributors.
16#1808	The signal received by channel 1 exceeds the range of analog inputs (temperature).	Check the signal received by channel 1
16#1809	The signal received by channel 2 exceeds the range of analog inputs (temperature).	Check the signal received by channel 2
16#180A	The signal received by channel 3 exceeds the range of analog inputs (temperature).	Check the signal received by channel 3
16#180B	The signal received by channel 4 exceeds the range of analog inputs (temperature).	Check the signal received by channel 4

Error Code (16#)	Description	Solution
16#180C	The signal received by channel 5 exceeds the range of analog inputs (temperature).	Check the signal received by channel 5
16#180D	The signal received by channel 6 exceeds the range of analog inputs (temperature).	Check the signal received by channel 6
16#180E	The signal received by channel 7 exceeds the range of analog inputs (temperature).	Check the signal received by channel 7
16#180F	The signal received by channel 8 exceeds the range of analog inputs (temperature).	Check the signal received by channel 8
-	When power-on, the module is not detected by CPU module.	Check if the connection between module and CPU module is working. If not, connect again.

A.4.2 Troubleshooting of Loadcell Modules AS02LC

A.4.2.1 ERROR ERROR LED Indicators Are ON

You can set up the option to be **True** in **Module Alarm Setting** to have the following errors appear as warnings when they occur. Otherwise, when an error occurs, only an error message appears.

Error Code (16#)	Description	Solution
16#1605	Hardware failure	If the problem persists, contact the local authorized distributors.
16#1607	The external voltage is abnormal.	Check the power supply.

A.4.2.2 ERROR LED Indicators Blinking Every 0.2 Seconds

The following errors are specified as warnings to ensure that the AX-3 Series CPU can still run even when the warnings are triggered by its LC modules. If you need the CPU STOP running immediately when the first 4 errors occur, you need to set the them as errors.

Error Code (16#)	Description	Solution
16#1801	The external voltage is abnormal.	Check the power supply.
16#1802	Hardware failure	If the problem persists, contact the local authorized distributors.
16#1807	The CJC is abnormal.	If the problem persists, contact the local authorized distributors.
16#1808	The signal received by channel 1 exceeds the range of analog inputs (temperature).	Check the signal received by channel 1
16#1809	The signal received by channel 2 exceeds the range of analog inputs (temperature).	Check the signal received by channel 2
16#180A	The signal received by channel 3 exceeds the range of analog inputs (temperature).	Check the signal received by channel 3
16#180B	The signal received by channel 4 exceeds the range of analog inputs (temperature).	Check the signal received by channel 4
16#180C	The signal received by channel 5 exceeds the range of analog inputs (temperature).	Check the signal received by channel 5
16#180D	The signal received by channel 6 exceeds the range of analog inputs (temperature).	Check the signal received by channel 6
-	When power-on, the module is not detected by CPU module.	Check if the connection between module and CPU module is working. If not, connect again.

A.5 Error Codes and LED Indicators for CPU Modules

A. Columns

- a. Error code: If an error occurs in the system, an error code is generated.
- b. Description: The description of the error
- c. CPU status: If the error occurs, the CPU stops running, keeps running, or shows the status you defined for the error.
 - Stop: The CPU stops running when the error occurs.
 - Continue: The CPU keeps running when the error occurs.
- d. LED indicator status: If the error occurs, the LED indicator is ON, OFF, or blinks.
 - ERROR: System error

● Descriptions

Module Type	LED indicator	Descriptions
CPU	Error LED	<p>There are five types of indicators for of the CPU module errors, including LED indicator ON, OFF, blinking fast, blinking normally, and blinking slowly. When the LED indicator is ON, blinking fast/normally, clear the problems first for the CPU module to keep on running. When the LED indicator is blinking slowly, indicating a warning type of error codes, it does not require immediate action. Clear the problems when the module is powered off.</p> <p>Error type:</p> <p>ON: A serious error occurs in the module.</p> <p>Blinking fast (every 0.2 seconds): unstable power supply or hardware Failure.</p> <p>Blinking normally (every 0.5 second): system program errors or system cannot run.</p> <p>Warning type:</p> <p>Blinking slowly (every 1 second and off for 3 seconds): a warning is triggered, but the system can still run.</p> <p>OFF: a warning is triggered, but the system can still run. You can modify the rules and use DIADesigner-AX to show the warnings, instead of using indicators to show the errors.</p>

A.5.1 Error Codes and LED Indicators for CPU Modules

Refer to Section A.2 for the status descriptions of the Error LED indicators.

• CPU ERROR

Error Code (16#)	Description	CPU status	ERROR LED indicator				
			ON	Blinking fast	Blinking normally	Blinking slowly	OFF
7	The operation system file of the firmware is broken.	Stop				V	
8	Parts of the firmware components are broken.	Stop				V	
D	Checksum error occurs in the %M device.	Stop				V	
140E	Number of remote modules exceeds the limit of eight on the right side of the CPU module.	Stop			V		
1500	Connection lost in the remote modules	Continue				V	
1600	The ID of the extension module exceeds the range.	Stop			V		
1601	The ID of the extension module cannot be set.	Stop			V		
1602	The ID of the extension module is duplicated.	Stop			V		
1603	The extension module cannot be operated.	Stop			V		
1604	Extension module communication timeout	Stop			V		
2000	CPU memory access is denied.	Stop			V		
2001	CPU external memory access is denied.	Stop			V		
2002	RTC cannot keep track of the current time (the battery LED is blinking.)	Continue					V
2003	Battery low (the battery LED is ON.)	Continue					V
2004	24VDC power supply is not sufficient and then is recovered from low-voltage for less than 10 ms.	Continue		V			
2100	The number of MODBUS TCP connections exceeds the range.	Continue			V		
2200	The arrangement of the I/O modules is not consistent with the settings.	Stop			V		
2201	The number of connected communication modules exceed the maximum number 4.	Stop			V		
2202	The number of connected positioning modules exceed the maximum number 8.	Stop			V		
2203	The number of connected extension modules exceed the maximum number 32.	Stop			V		
2500	The firmware version of the PLC is not in accordance with what stated on the DDF (Device Description File).	Continue					V
2501	SSI encoder is NOT connected to PLC.	Continue					V
2502	The setting value of the single turn and multiturn SSI encoders exceed the setting limit. (up to 32 bits).	Continue					V
2503	An error occurs when the pulse outputs.	Continue					V

- **EtherCAT ERROR**

Error Code (16#)	Description	CPU status	ERROR LED indicator				
			ON	Blinking fast	Blinking normally	Blinking slowly	OFF
1	EtherCAT communication lost	Continue			V		
2	EtherCAT data mapping failed	Continue			V		
4	Incorrect EtherCAT network name	Continue			V		
5	EtherCAT Slave failed to initialize	Continue			V		
6	Vendor ID of the Slave does NOT match.	Continue			V		
7	Product ID of the Slave does NOT match.	Continue			V		

A.5.2 Error Codes and LED Indicators for Analog and Temperature Module

Error Code (16#)	Description	ERROR LED indicator	
		A → D / D → A / A ↔ D	ERROR
16#1605	Hardware failure (the diver board included)	OFF	ON
16#1607	The external voltage is abnormal.	OFF	ON
16#1608	The factory calibration or the CJC is abnormal.	OFF	ON
16#1801*1	The external voltage is abnormal.	OFF	Blinking
16#1802*1	Hardware failure	OFF	Blinking
16#1804*1	The factory calibration is abnormal.	RUN: Blinking STOP: OFF	Blinking
16#1807*1	The CJC is abnormal.	OFF	Blinking
16#1808	The signal received by channel 1 exceeds the range of analog inputs (temperature).	RUN: Blinking STOP: OFF	Blinking
16#1809	The signal received by channel 2 exceeds the range of analog inputs (temperature).		
16#180A	The signal received by channel 3 exceeds the range of analog inputs (temperature).		
16#180B	The signal received by channel 4 exceeds the range of analog inputs (temperature).		
16#180C	The signal received by channel 5 exceeds the range of analog inputs (temperature).		
16#180D	The signal received by channel 6 exceeds the range of analog inputs (temperature).		
16#180E	The signal received by channel 7 exceeds the range of analog inputs (temperature).		
16#180F	The signal received by channel 8 exceeds the range of analog inputs (temperature).		

*1 : The errors are specified as warnings to ensure that the AX-3 Series CPU can still run even when the warnings are triggered by its AIO modules. If you need the CPU STOP running immediately when the first 4 errors occur, you need to set the them as errors.