

Industrial Automation Headquarters

Taiwan: Delta Electronics, Inc.
Taoyuan Technology Center
No.18, Xinglong Rd., Taoyuan District,
Taoyuan City 33068, Taiwan
TEL: +886-3-362-6301 / FAX: +886-3-371-6301

Asia

China: Delta Electronics (Shanghai) Co., Ltd.
No.182 Minyu Rd., Pudong Shanghai, P.R.C.
Post code : 201209
TEL: +86-21-6872-3988 / FAX: +86-21-6872-3996
Customer Service: 400-820-9595

Japan: Delta Electronics (Japan), Inc.
Industrial Automation Sales Department
2-1-14 Shibadaimon, Minato-ku
Tokyo, Japan 105-0012
TEL: +81-3-5733-1155 / FAX: +81-3-5733-1255

Korea: Delta Electronics (Korea), Inc.
1511, 219, Gasan Digital 1-Ro., Geumcheon-gu,
Seoul, 08501 South Korea
TEL: +82-2-515-5305 / FAX: +82-2-515-5302

Singapore: Delta Energy Systems (Singapore) Pte Ltd.
4 Kaki Bukit Avenue 1, #05-04, Singapore 417939
TEL: +65-6747-5155 / FAX: +65-6744-9228

India: Delta Electronics (India) Pvt. Ltd.
Plot No.43, Sector 35, HSIIDC Gurgaon,
PIN 122001, Haryana, India
TEL: +91-124-4874900 / FAX: +91-124-4874945

Thailand: Delta Electronics (Thailand) PCL.
909 Soi 9, Moo 4, Bangpoo Industrial Estate (E.P.Z),
Pattana 1 Rd., T.Phraksa, A.Muang,
Samutprakarn 10280, Thailand
TEL: +66-2709-2800 / FAX: +66-2709-2827

Australia: Delta Electronics (Australia) Pty Ltd.
Unit 20-21/45 Normanby Rd., Notting Hill Vic 3168, Australia
TEL: +61-3-9543-3720

Americas

USA: Delta Electronics (Americas) Ltd.
5101 Davis Drive, Research Triangle Park, NC 27709, U.S.A.
TEL: +1-919-767-3813 / FAX: +1-919-767-3969

Brazil: Delta Electronics Brazil Ltd.
Estrada Velha Rio-São Paulo, 5300 Eugênio de
Melo - São José dos Campos CEP: 12247-004 - SP - Brazil
TEL: +55-12-3932-2300 / FAX: +55-12-3932-237

Mexico: Delta Electronics International Mexico S.A. de C.V.
Gustavo Baz No. 309 Edificio E PB 103
Colonia La Loma, CP 54060
Tlalnepantla, Estado de México
TEL: +52-55-3603-9200

EMEA

EMEA Headquarters: Delta Electronics (Netherlands) B.V.
Sales: Sales.IA.EMEA@deltaww.com
Marketing: Marketing.IA.EMEA@deltaww.com
Technical Support: iatechnicalsupport@deltaww.com
Customer Support: Customer-Support@deltaww.com
Service: Service.IA.emea@deltaww.com
TEL: +31(0)40 800 3900

BENELUX: Delta Electronics (Netherlands) B.V.
Automotive Campus 260, 5708 JZ Helmond, The Netherlands
Mail: Sales.IA.Benelux@deltaww.com
TEL: +31(0)40 800 3900

DACH: Delta Electronics (Netherlands) B.V.
Coesterweg 45, D-59494 Soest, Germany
Mail: Sales.IA.DACH@deltaww.com
TEL: +49(0)2921 987 0

France: Delta Electronics (France) S.A.
ZI du bois Challand 2, 15 rue des Pyrénées,
Lisses, 91090 Evry Cedex, France
Mail: Sales.IA.FR@deltaww.com
TEL: +33(0)1 69 77 82 60

Iberia: Delta Electronics Solutions (Spain) S.L.U
Ctra. De Villaverde a Vallecas, 265 1º Dcha Ed.
Hormigueras – P.I. de Vallecas 28031 Madrid
TEL: +34(0)91 223 74 20

Carrer Llacuna 166, 08018 Barcelona, Spain
Mail: Sales.IA.Iberia@deltaww.com

Italy: Delta Electronics (Italy) S.r.l.
Via Meda 2-22060 Novedrate(CO)
Piazza Grazioli 18 00186 Roma Italy
Mail: Sales.IA.Italy@deltaww.com
TEL: +39 039 8900365

Russia: Delta Energy System LLC
Vereyskaya Plaza II, office 112 Vereyskaya str.
17 121357 Moscow Russia
Mail: Sales.IA.RU@deltaww.com
TEL: +7 495 644 3240

Turkey: Delta Greentech Elektronik San. Ltd. Sti. (Turkey)
Şerifali Mah. Hendem Cad. Kule Sok. No:16-A
34775 Ümraniye – İstanbul
Mail: Sales.IA.Turkey@deltaww.com
TEL: + 90 216 499 9910

MEA: Eltek Dubai (Eltek MEA DMCC)
OFFICE 2504, 25th Floor, Saba Tower 1,
Jumeirah Lakes Towers, Dubai, UAE
Mail: Sales.IA.MEA@deltaww.com
TEL: +971(0)4 2690148

AS Series Module Manual



Digitized Automation for a Changing World

AS Series Module Manual

AS Series Module Manual

Revision History

Version	Revision	Date
1 st	The first version was published.	2016/11/30
2 nd	<ol style="list-style-type: none"> 1. Chapter 1: Added information concerning new models AS08AD-B and AS08AD-C. 2. Chapter 2: Added information concerning new models AS08AD-B and AS08AD-C. 3. Chapter 3: Updated information concerning CR#23-24 and software new screenshots. 4. Chapter 4: Updated information concerning CR#35-54/CR#210-225 and software new screenshots. 5. Chapter 5: Updated information concerning CR#1-4/CR#210-217 and software new screenshots. 6. Chapter 6: Updated information concerning CR#210-217 and software new screenshots. 7. Chapter 7: Updated information concerning theoretical calibration and software new screenshots 8. Chapter 8: Updated information concerning new FW2.0. 	2017/07/07
3 rd	<ol style="list-style-type: none"> 1. Chapter 1: Added information concerning new models AS06RTD-A and AS08TC-A and installation information updated in section 1.3.1. 2. Chapter 5: Added information concerning new model AS06RTD-A. 3. Chapter 6: Added information concerning new models AS08TC-A. 	2018/02/09
4 th	<ol style="list-style-type: none"> 1. Chapter 1: Added information concerning ambient air temperature-barometric pressure-altitude. 2. Chapter 2: Added information concerning filter average, cable length and resistance. Updated section 2.2.4 CR#23-38 and section 2.2.5 CR#43-74. 3. Chapter 3: Added information concerning cable length and resistance. Updated section 3.2.1 analog to digital conversion range, output impedance and section 3.2.4 CR17-20 and CR#21-36. 4. Chapter 4: Added information concerning filter average, cable length and resistance. Updated section 4.2.1 analog to digital conversion range, output impedance and 4.2.4 CR#31-21. 5. Chapter 5: Updated section 5.2.1 JPt100 range, section 5.2.4-5.2.5 added notes on CR, updated section 5.2.6 PID information, revised section 5.2.7 control mode. 6. Chapter 6: Section 6.2.1 revised type B range, added a note, section 6.2.4-6.2.5 added notes on CR, revised CR# for the records, updated section 6.2.6 PID information and revised section 6.2.7 control mode. 7. Chapter 7: Section 7.2.4 added notes on CR. 8. Chapter 8: New functions in new FW2.02. 9. Chapter 9: Updated section 9.2.5 output impedance information and added sections 9.2.7.1-9.2.7.9 for new functions added and operational examples. 	2018/11/26
5 th	<ol style="list-style-type: none"> 1. Chapter 7: Revised contents of CR#0 and #59 in section 7.2.4. 2. Chapter 8: Deleted a note in section 8.6.4. 	2019/1/29
6 th	<ol style="list-style-type: none"> 1. Chapter 5: Updated wiring information in section 5.2.8. 	2019/5/10

Version	Revision	Date
7 th	<ol style="list-style-type: none"> 1. Chapter 1: Added model information including AS02PU-A, AS04PU-A, AS02HC-A, AS04SIL-A and AS-FPFN02 2. Chapter 2: Updated section 2.2.1 specification, 2.2.4 and 2.2.5 CR table, and 2.4 adding a new error code. 3. Chapter 3: Updated section 3.2.4 CR table and 3.4 adding a new error code. 4. Chapter 4: Updated section 4.2 specification, 4.2.4 CR table and 4.4 adding a new error code. 5. Chapter 5: Updated section 5.2 specification, 5.2.4 and 5.2.5 CR table, and 5.4 adding a new error code. 6. Chapter 6: Updated section 6.2.4 and 6.2.5 CR table. Added DMPID instruction supporting firmware versions and section 6.4 adding a new error code. 7. Chapter 7: Updated section 7.2.4 and 7.2.5 CR table and 7.5 adding a new error code. 8. Chapter 8: Added a new error code in section 8.7.2.2. 9. Chapter 9: Updated AS-F2AD specifications in sections 9.2.4 and 9.2.5. Deleted SM1110 and SR1540 in section 9.2.7. Added AS-FPFN02 information in sections 9.2.8 and 9.3.5. 10. Chapter 11: New chapter introducing positioning modules AS02PU-A and AS04PU-A. 	2019/11/29
8 th	<ol style="list-style-type: none"> 1. Chapter 1: Updated section 1.1 to include software information for new AX series PLC, updated AS02HC-A specifications and added AS-FOPC02 information. Added an installation note in section 1.3.4. 2. Chapter 2: New chapter introducing digital input/output modules. 3. Chapter 3 – 7: Added DIADesigner+ and Hardware Configuration information. 4. Chapter 8: Updated CR#120 default value and input values 100 to 105 of CR200 command set in section 8.2.4. 5. Chapter 9: Added AS-FPEN02 and AS04SIL-A information, added LED indicator information of EtherNet/IP in section 9.4.2, and added error LED indicator information of AS00SCM-A in section 9.7.2.2. 6. Chapter 10: Updated software images in section 10.2.7 and 10.2.7.2, updated section 10.2.7.7, added AS-FPFN02 installed on AS00SCM-A information in section 10.2.8, added AS-FOPC02 product information in sections 10.2.9 and 10.3.6, updated LED indicator information of AS-FEN02 in section 10.3.4. 7. Chapter 12: Updated response time and input isolation specifications in section 12.2.1. 8. Chapter 13: New chapter introducing IO link communication module, AS04SIL-A. 9. Chapter 14: New chapter introducing high speed counter modules AS02PU and AS04PU. 	2020/04/30
9 th	<ol style="list-style-type: none"> 1. Chapter 1: Updated AS02/04PU-A module descriptions 2. Chapter 3-8: Added DIADesigner-AX software operation 3. Chapter 9: Updated sections 9.7.2.2 and 9.7.2.3 AS00SCM Error LED Indicators 4. Chapter 10: Deleted EtherNet/IP Adapter information in section 10.2.9. 	2020/10/30

Version	Revision	Date
	<ol style="list-style-type: none"> 5. Chapter 13: Added filter time in section 13.2.1 and added 13.3.2.5 Application-specific API for Communications of IO-Link Devices. 6. Chapter 14: Added the process images of the Timing to Count in section 14.2.5 Pulse Input Counting. 	
10 th	<ol style="list-style-type: none"> 1. Chapter 1: Added new product information for AS02ADH-A and AS-FFTP01. 2. Chapter 6: Added Maximum Measurable Range in functional specifications and Conversion Details in section 6.21. Added a label description in profile in section 6.2.2. 3. Chapter 7: Added more applicable sensor types in, including C, U, L and TXK. Added Conversion Details in section 7.2.1. Added a label description in Profile in section 7.2.2 Added compatible firmware versions and more descriptions on control mode in section 7.2.7. 4. Chapter 8: Added Weight in functional specifications in section 8.2.1. Added a label description in Profile in section 8.2.2. Added new CRs, CR#400 to #479 in section 8.2.4. Added a new illustration for zero point tracking in section 8.2.5. Updated the software images in section 8.3.2, 8.3.3 and 8.4. Added troubleshooting for diver board failure in section 8.6.2. 5. Chapter 9: Updated Introduction and added applicable PLC CPU for AS00SCM-A in RTU mode in section 9.1. Updated Knob Function in section 9.2.3. Updated Modbus information and added software images in sections 9.3.1, 9.3.1.1 and 9.3.1.2. Updated UD Link information, added software images in section 9.3.2, and added new description for SCMSOft in section 9.3.2.2. Added more descriptions and example for applications of AS00SCM-A in RTU mode in section 9.4.2. Deleted software image from manufacturer R in section 9.4.2.6. Added Network Security information in section 9.4.2.7. Added error code 16#1304 in section 9.7.2.1, updated error codes 16#1506 in section 9.7.2.2 and updated 16#1502 in section 9.7.2.1. 6. Chapter 10: Updated supported firmware and software versions in section 10.2.7.1. Updated Features in section 10.2.7.2. Added a new section for IP Setting in section 10.2.7.4. Updated information in Data Mapping through EtherNet/IP Adapter in section 10.2.7.6. Updated software images (from manufacturer R) and descriptions in Example of Connecting to 3rd Party PLC Scanner through EIP Builder in section 10.2.7.7. Updated supported firmware and software versions in section 10.2.8.1. Updated Features in section 10.2.8.2. Updated 	2021/08/20

Version	Revision	Date
	<p>information in Configuring the Data Length for I/O Module (Works with AS300) in section 10.2.8.4. Updated applicable modules in section 10.2.8.6. Updated software images (from manufacturer S) and PROFINET Device Example (Adapter) in section 10.2.8.8. Updated features for AS-FOPC02 in section 10.2.9.2. Added Modbus TCP Specifications and OPC UA Specifications in section 10.2.9.3. Added SR information for AS300 in section 10.2.9.4. Added Setting UTC Time in OPC UA Slave information in section 10.2.9.6. Added Network Security information in section 10.2.9.7. Added The Copyright Information about the Used External Software Sources in 10.2.9.8. Added a new section 10.2.10 for AS-FFTP01. Updated AS-FPFN02 LED information in section 10.3.5.</p> <p>7. Chapter 12: Updated information in Special Features in section 12.2.4. Updated software images in section 12.3.</p> <p>8. Chapter 13: Updated AS PLC CPU firmware version in section 13.1. Updated application-specific API information in section 13.3.2.5. Updated 16#FF21~16#FF25 in IO-Link Event Code table in section 13.5.</p> <p>9. Chapter 14: Updated the receiving data length to 32 bits in section 14.1.1. Move the input/output information to section 14.3. Updated software images in section 14.4.</p> <p>10. Chapter 15: Added a new chapter for High-speed analog module AS02ADH.</p>	
11 th	<p>1. Chapter 1: Added new product information for AS-FECAT. Added information about DIADesigner software. Added supported firmware versions for AS04AD-A, AS08AD-B, AS08AD-C, AS06XA-A, AS04RTD-A and AS06RTD-A.</p> <p>2. Chapter 2: Updated information for specifications of input/output isolation voltage.</p> <p>3. Chapter 3: Added information about DIADesigner software. Added Built-in moving average and proportional filter function in section 3.1.1. Added supported firmware versions and updated information for specifications of conversion time as well as isolation in section 3.2.</p> <p>4. Chapter 4: Added information about DIADesigner software. Updated information for specifications of isolation in section 4.2.</p> <p>5. Chapter 5: Added information about DIADesigner software. Added supported firmware versions and updated information for specifications of conversion time as well as isolation in section 5.2.</p> <p>6. Chapter 6: Added information about DIADesigner</p>	2022/05/16

Version	Revision	Date
	<p>software and Ni120. Added supported firmware versions and updated information for specifications of conversion time as well as isolation in section 6.2.</p> <p>7. Chapter 7: Added information about DIADesigner software. Updated information for specifications of resolution, isolation and maximum measurable range in section 7.2.</p> <p>8. Chapter 8: Added information about DIADesigner software. Updated information for specifications of maximum filter and average weights in section 8.2.1. Updated the contents of CR8 and CR67 in section 8.2.4. Updated the contents of filtering function in section 8.2.5.</p> <p>9. Chapter 9: Added information about DIADesigner software. Updated information for CANopen mode (AS-FCOPM) in section 9.4.1.</p> <p>10. Chapter 10: Update isolation information. Updated IOPS/IOCS information in section 10.2.8.4. Added supported firmware version for AS-FOPC02 in section 10.2.9.1 and updated contents in sections 10.2.9.5, 10.2.9.6, and 10.2.10.4, where the descriptions of OPC UA Client should be OPC UA Server instead. Added log section for AS-FFTP01 and updated contents (OPC UA, FTP, Log, Web, and MQTT) in section 10.2.10. Added new product information for AS-FECAT in section 10.2.11.</p> <p>11. Chapter 11: Updated information for specifications of isolation in section 11.1.2.</p> <p>12. Chapter 12: Added information about DIADesigner software. Updated information for specifications of input/output isolation voltage in section 12.2.</p> <p>13. Chapter 13: Updated information for specifications of isolation in section 13.2.1.</p> <p>14. Chapter 14: Added information about DIADesigner software. Updated information for specifications of input/output isolation voltage in section 14.2.</p> <p>15. Chapter 15: Added information about DIADesigner software. Updated information for specifications of isolation in section 15.2.</p>	

AS Series Module Manual

Table of Contents

Chapter 1 Introduction

1.1	Overview	1-2
1.2	Specifications	1-5
1.2.1	General Specifications.....	1-5
1.2.2	EMS Standards	1-6
1.3	Installation.....	1-8
1.3.1	Installing a Module	1-8
1.3.2	Installing a Removable Terminal Block.....	1-10
1.3.3	Changing a Module.....	1-11
1.3.4	Installing and Removing an Extension Card.....	1-12
1.3.5	Installing a Wiring Module	1-13

Chapter 2 Digital Input / Output Modules

2.1	Digital Input/Output Module Specifications.....	2-2
2.1.1	General Specifications.....	2-2
2.1.2	Digital Input/Output Module Profiles	2-4
2.1.3	Digital Input/Output Module Terminals	2-12

Chapter 3 Analog Input Module AS04/08AD

3.1	Overview	3-2
3.1.1	Characteristics.....	3-2
3.2	Specifications and Functions	3-3
3.2.1	Specifications	3-3
3.2.2	Profile	3-5
3.2.3	Arrangement of Terminals	3-6
3.2.4	AS04AD Control Register.....	3-6
3.2.5	AS08AD Control Registers	3-11
3.2.6	Functions.....	3-17
3.2.7	Wiring	3-20
3.2.8	LED Indicators.....	3-24

3.3	HWCONFIG in ISPSOft	3-24
3.3.1	Initial Setting	3-24
3.3.2	Checking the Version of a Module	3-27
3.3.3	Online Mode.....	3-28
3.3.4	Importing/Exporting a Parameter File	3-29
3.3.5	Parameters	3-30
3.4	DIADesigner-AX (Hardware Configuration)	3-34
3.4.1	Initial Setting	3-34
3.4.2	Checking the Version of a Module	3-37
3.4.3	Online Mode.....	3-38
3.4.4	Parameters	3-39
3.5	Troubleshooting	3-41
3.5.1	Error Codes	3-41
3.5.2	Troubleshooting Procedure	3-42

Chapter 4 Analog Output Module AS04DA

4.1	Overview	4-2
4.1.1	Characteristics	4-2
4.2	Specifications and Functions	4-3
4.2.1	Specifications.....	4-3
4.2.2	Profile	4-5
4.2.3	Arrangement of Terminals	4-6
4.2.4	Control Registers	4-6
4.2.5	Functions.....	4-8
4.2.6	Wiring.....	4-12
4.2.7	LED Indicators.....	4-14
4.3	HWCONFIG in ISPSOft	4-14
4.3.1	Initial Setting	4-14
4.3.2	Checking the Version of a Module	4-17
4.3.3	Online Mode.....	4-18
4.3.4	Importing/Exporting a Parameter File	4-19
4.3.5	Parameters	4-20
4.4	DIADesigner-AX (Hardware Configuration)	4-23
4.4.1	Initial Setting.....	4-23
4.4.2	Checking the Version of a Module.....	4-26
4.4.3	Online Mode	4-27
4.4.4	Parameters.....	4-28

4.5	Troubleshooting	4-30
4.5.1	Error Codes	4-30
4.5.2	Troubleshooting Procedure.....	4-30

Chapter 5 Analog Input / Output Module AS06XA

5.1	Overview	5-2
5.1.1	Characteristics	5-2
5.2	Specifications and Functions	5-3
5.2.1	Specifications	5-3
5.2.2	Profile	5-6
5.2.3	Arrangement of Terminals	5-7
5.2.4	Control Registers	5-8
5.2.5	Functions.....	5-13
5.2.6	Wiring	5-20
5.2.7	LED Indicators	5-22
5.3	HWCONFIG in ISPSOft	5-23
5.3.1	Initial Setting	5-23
5.3.2	Checking the Version of a Module	5-26
5.3.3	Online Mode	5-27
5.3.4	Importing/Exporting a Parameter File.....	5-28
5.3.5	Parameters	5-29
5.4	DIADesigner-AX (Hardware Configuration)	5-34
5.4.1	Initial Setting	5-34
5.4.2	Checking the Version of a Module	5-37
5.4.3	Online Mode	5-38
5.4.4	Parameters	5-39
5.5	Troubleshooting	5-41
5.5.1	Error Codes	5-41
5.5.2	Troubleshooting Procedure.....	5-42

Chapter 6 Temperature Measurement Module AS04/06RTD

6.1 Overview	6-2
6.1.1 Characteristics	6-2
6.2 Specifications and Functions	6-3
6.2.1 Specifications	6-3
6.2.2 Profile	6-6
6.2.3 Arrangement of Terminals	6-7
6.2.4 AS04RTD Control Registers	6-8
6.2.5 AS06RTD Control Registers	6-12
6.2.6 Functions.....	6-17
6.2.7 Control Mode	6-20
6.2.8 Wiring.....	6-20
6.2.9 LED Indicators.....	6-23
6.3. HWCONFIG in ISPSOft	6-24
6.3.1 Initial Setting	6-24
6.3.2 Checking the Version of a Module	6-27
6.3.3 Online Mode.....	6-28
6.3.4 Importing/Exporting a Parameter File	6-29
6.3.5 Parameters	6-30
6.4 DIADesigner-AX (Hardware Configuration)	6-33
6.4.1 Initial Setting	6-33
6.4.2 Checking the Version of a Module	6-35
6.4.3 Online Mode.....	6-36
6.4.4 Parameters	6-37
6.5 Troubleshooting	6-39
6.5.1 Error Codes	6-39
6.5.2 Troubleshooting Procedure	6-40
6.5.3 State of the Connection	6-41

Chapter 7 Temperature Measurement Module AS04/08TC

7.1	Overview	7-2
7.1.1	Characteristics	7-3
7.2	Specifications and Functions	7-4
7.2.1	Specifications	7-4
7.2.2	Profile	7-7
7.2.3	Arrangement of Terminals	7-8
7.2.4	AS04TC Control Registers.....	7-8
7.2.5	AS08TC Control Registers.....	7-12
7.2.6	Functions	7-18
7.2.7	Control Mode.....	7-21
7.2.8	Wiring	7-31
7.2.9	LED Indicators	7-32
7.3	HWCONFIG in ISPSOft	7-33
7.3.1	Initial Setting	7-33
7.3.2	Checking the Version of a Module	7-36
7.3.3	Online Mode	7-37
7.3.4	Importing/Exporting a Parameter File.....	7-38
7.3.5	Parameters	7-39
7.4	DIADesigner-AX (Hardware Configuration)	7-42
7.4.1	Initial Setting	7-42
7.4.2	Checking the Version of a Module	7-45
7.4.3	Online Mode	7-46
7.4.4	Parameters	7-47
7.5	Troubleshooting	7-49
7.5.1	Error Codes	7-49
7.5.2	Troubleshooting Procedure	7-50

Chapter 8 Load Cell Module AS02LC

8.1	Overview	8-2
8.2	Specifications	8-2
8.2.1	Specifications	8-2
8.2.2	Profile	8-3
8.2.3	Arrangement of Terminals	8-4
8.2.4	Control Registers	8-5
8.2.5	Functions.....	8-13
8.2.6	Wiring.....	8-19
8.3	Making Adjustments	8-20
8.3.1	Steps to adjust points	8-20
8.3.2	Adjustment settings / LC Wizard	8-21
8.3.3	Adjustment Settings / Calibrational Commands	8-24
8.3.4	LED Indicators.....	8-27
8.4	HWCONFIG in ISPSOft	8-28
8.4.1	Initial Setting	8-28
8.4.2	Checking the Version of a Module.....	8-31
8.4.3	Online Mode.....	8-32
8.4.4	Importing/Exporting a Parameter File	8-33
8.4.5	Parameters	8-34
8.5	Basic Operation on DIADesigner-AX	8-37
8.5.1	Creating a New Project	8-37
8.5.2	Adding a Module	8-39
8.5.3	Parameters - Configuring the Module	8-41
8.5.4	I/O Mapping.....	8-44
8.5.5	Status.....	8-45
8.5.6	Information	8-45
8.6	Troubleshooting	8-46
8.6.1	Error Codes	8-46
8.6.2	Troubleshooting Procedure	8-47

Chapter 9 Serial Communication Module AS00SCM

9.1	Introduction	9-2
9.2	Specification, Function and Wiring	9-4
9.2.1	The functional specifications	9-4
9.2.2	Dimensions and Profile.....	9-5
9.2.3	Knob Functions	9-6
9.2.4	Wiring	9-9
9.3	COM mode	9-11
9.3.1	Modbus	9-11
9.3.2	UD Link	9-16
9.3.3	CANopen Mode	9-24
9.4	RTU Mode	9-26
9.4.1	CANopen Mode (AS-FCOPM)	9-26
9.4.2	EtherNet/IP Mode.....	9-32
9.4.3	Remote Module Setting	9-45
9.5	Normal Exchange Area	9-47
9.6	Application	9-49
9.6.1	Modbus	9-49
9.6.2	UD Link	9-58
9.6.3	Remote IO Application (AS-FCOPM)	9-73
9.6.4	Remote IO Application (AS-FEN02) Through EIP Builder.....	9-80
9.6.5	Remote IO Application (Multiple AS-FEN02)	9-82
9.7	Error Codes	9-83
9.7.1	Troubleshooting for Module AS00SCM-A as a Communication Module	9-84
9.7.2	Troubleshooting for Module AS00SCM-A as a Remote Module	9-85

Chapter 10 Function Cards

10.1	Introduction	10-2
10.2	Specification and Function.....	10-2
10.2.1	AS-F232	10-2
10.2.2	AS-F422	10-2
10.2.3	AS-F485	10-2
10.2.4	AS-F2AD	10-3
10.2.5	AS-F2DA	10-4
10.2.6	AS-FCOPM	10-4
10.2.7	AS-FEN02	10-5
10.2.8	AS-PPFN02	10-20
10.2.9	AS-FOPC02	10-27
10.2.10	AS-FFTP01	10-34
10.2.11	AS-FECAT	10-65
10.3	Profiles and Dimensions	10-74
10.3.1	AS-F232	10-74
10.3.2	AS-F422/AS-F485/AS-F2AD/AS-F2DA	10-74
10.3.3	AS-FCOPM	10-74
10.3.4	AS-FEN02	10-75
10.3.5	AS-PPFN02	10-76
10.3.6	AS-FOPC02	10-77
10.3.7	AS-FFTP01	10-78
10.3.8	AS-FECAT	10-79
10.4	Wiring	10-80
10.4.1	AS-F2AD	10-80
10.4.2	AS-F2DA	10-81
10.4.3	Topology of AS-FEN02, AS-FOPC02, AS-PPFN02 and AS-FECAT	10-82
10.4.4	Topology of AS-FFTP01	10-83
10.5	HWCONFIG in ISPSOft	10-84
10.5.1	Initial Setting	10-84

Chapter 11 DeviceNet Master Scanner Module AS01DNET-A

11.1	Introduction o AS01DNET-A	11-3
11.1.1	Feature.....	11-3
11.1.2	Specifications	11-3
11.2	Components of AS01DNET-A.....	11-4
11.2.1	Profile and Dimensions.....	11-4
11.2.2	Components.....	11-5
11.2.3	Mode Toggle (RTU- Master/Slave)	11-5
11.2.4	DeviceNet Connector	11-5
11.2.5	Address Switch	11-6
11.2.6	Function Switch	11-6
11.2.7	Digital Displayer	11-6
11.3	DeviceNet Network Communication.....	11-7
11.3.1	Relationship between Transmission Distance and Baud Rate.....	11-7
11.3.2	DeivceNet Network Topology Structure.....	11-7
11.3.3	Choice and Purpose of a DeviceNet Terminal Resistor	11-11
11.3.4	DeviceNet Network Supply Power	11-12
11.4	Master /Slave Mode.....	11-13
11.4.1	Introduction of Master/Slave Mode	11-13
11.4.2	Installation.....	11-14
11.4.3	IO Mapping for AS01DNET in AS PLC.....	11-15
11.4.4	Bit-strobe Command	11-17
11.4.5	Network Node Status Display.....	11-18
11.4.6	Setting the Time for Data Exchange between Master and Slaves	11-18
11.4.7	Application Example	11-19
11.4.8	Sending Explicit Message through Ladder Diagram.....	11-29
11.4.9	LED Indicators and Troubleshooting.....	11-36
11.4.10	Master-Slave Mode Switch and 8 Baud Rates Setting via Software....	11-39
11.5	RTU Mode	11-51
11.5.1	Introduction of AS01DNET (in RTU Mode)	11-51
11.5.2	AS-Series Extension Modules Connectable to AS01DNET (RTU)	11-52
11.5.3	Installation.....	11-53
11.5.4	Configuring AS01DNET (in RTU mode)	11-55
11.5.5	Application Example	11-82
11.5.6	Error Diagnosis and Trouble Shooting.....	11-91
11.6	How to Call DeviceNet Builder through ISPSoft (AS-Series PLC) .	11-97

Chapter 12 Positioning Modules AS02/04PU

12.1 Overview	12-2
12.1.1. Characteristics	12-2
12.2 Specifications and Functions	12-3
12.2.1. Specifications	12-3
12.2.2. Profile	12-5
12.2.3. Arrangement of Terminals	12-6
12.2.4. Special Features	12-8
12.2.5. Wiring	12-8
12.3 HWCONFIG in ISPSOft	12-11
12.3.1. Initial Setting	12-11
12.3.2. Checking the Version of a Module	12-13
12.3.3. Online Mode	12-15
12.3.4. Importing/Exporting a Parameter File	12-16
12.3.5. Parameters	12-18
12.3.6. Normal Exchange Area	12-20
12.4 Troubleshooting	12-21
12.4.1. Error Codes	12-21
12.4.2. Troubleshooting Procedure	12-21
12.4.3. State Codes (Axis 1 - 4)	12-21

Chapter 13 I/O Link Communication Modules AS04SIL

13.1 Overview	13-2
13.1.1. Firmware and Software Versions	13-2
13.2 Specification and Wiring	13-3
13.2.1. Specifications	13-3
13.2.2. Profile	13-5
13.2.3. Wiring	13-6
13.3 Functions	13-8
13.3.1. Basic Functions	13-8
13.3.2. Application Functions	13-14
13.4 Application Examples	13-16
13.4.1. Using AS Series CPU as Upper Device	13-16
13.4.2. Using AH Series CPU or Non-Delta Master PLC as Upper Device	13-17
13.4.3. Application of AS Special Remote Mode	13-18
13.4.4. Application of Delta Special Driver & AS Remote Mode	13-30

13.4.5	Application of CANopen DS301 Mode	13-32
13.5	IO-Link Event Code Table	13-39
13.6	Module Status Codes	13-41

Chapter 14 High Speed Counter Module AS02/04HC

14.1	Overview	4-2
14.1.1	Characteristics	4-2
14.2	Specifications and Functions	4-3
14.2.1	Specifications	4-3
14.2.2	Profile	4-6
14.2.3	Terminals	4-7
14.2.4	Wiring	4-8
14.2.5	LED Indicators	4-11
14.3	Operation	4-12
14.3.1	Parameter Settings	4-12
14.3.2	Pulse Input Counting	4-13
14.3.3	SSI Input Counting	4-16
14.3.4	Z-Phase Function Setting	4-22
14.3.5	List of Dedicated API Instructions	4-23
14.3.6	The impact of AS CPU Status on AS02HC-A	4-24
14.4	Hardware Configuration via HWCONFIG in ISPSOft	4-25
14.4.1	Initial Setting	4-25
14.4.2	Checking the Module Version	4-28
14.4.3	Online Mode	4-29
14.4.4	Import and Export a Parameter File	4-30
14.4.5	Parameters	4-31
14.4.6	Normal Exchange Area	4-32
14.5	Troubleshooting	4-33
14.5.1	Error Codes	4-33
14.5.2	Troubleshooting Procedure	4-34

Chapter 15 High Speed Analog Input Module AS02ADH

15.1 Overview	15-2
15.1.1 Characteristics	15-2
15.2 Specifications and Functions	15-3
15.2.1 Specifications	15-3
15.2.2 Profile	15-6
15.2.3 Arrangement of Terminals	15-7
15.2.4 AS02ADH Control Register	15-8
15.2.5 Functions.....	15-11
15.2.6 Wiring.....	15-23
15.2.6.1 Digital Input Wiring	15-23
15.2.6.2 Analog Input Wiring.....	15-24
15.2.7 LED Indicators.....	15-27
15.3 HWCONFIG in ISPSoft	15-28
15.3.1 Initial Setting	15-28
15.3.2 Checking the Version of a Module.....	15-31
15.3.3 Online Mode.....	15-32
15.3.4 Importing/Exporting a Parameter File	15-34
15.3.5 Parameters	15-35
15.4 Troubleshooting	15-39
15.4.1 Error Codes	15-39
15.4.2 Troubleshooting Procedure	15-40

* All the Windows screenshots are used with permission from Microsoft.

Chapter 1 Introduction

Table of Contents

1.1	Overview	1-2
1.2	Specifications	1-5
1.2.1	General Specifications	1-5
1.2.2	EMS Standards	1-6
1.3	Installation	1-8
1.3.1	Installing a Module	1-8
1.3.2	Installing a Removable Terminal Block	1-10
1.3.3	Changing a Module	1-11
1.3.4	Installing and Removing an Extension Card	1-12
1.3.5	Installing a Wiring Module	1-13

1.1 Overview

This manual introduces the use of special modules. The special modules are the analog input/output modules, temperature measurement modules, load cell modules, and network modules. For software operation, ISPSOFT, DIADesigner or DIADesigner-AX is what you need. If you are using AS Series PLC CPU, refer to ISPSOFT User Manual or DIADesigner Manual for more information. The new software DIADesigner-AX only supports AX Series PLC CPU and AS Series modules now, refer to AX-3 User Manual for more information on software operation.

The following table shows the module descriptions.

Classification	Model Name	Description
Analog input/output module	AS04AD-A	4-channel analog input module Hardware resolution: 16 bits 0–10 V, 0/1–5 V, -5 to +5 V, -10 to +10 V, 0/4–20 mA, -20 to +20 mA Conversion time: 2 ms/channel (FW V1.02 or later: 1 ms/channel)
	AS08AD-B	8-channel analog input module Hardware resolution: 16 bits 0–10 V, 0/1–5 V, -5 to +5 V, -10 to +10 V Conversion time: 2 ms/channel (FW V1.02 or later: 1 ms/channel)
	AS08AD-C	8-channel analog input module Hardware resolution: 16 bits 0/4–20 mA, -20 to +20 mA Conversion time: 2 ms/channel (FW V1.02 or later: 1 ms/channel)
	AS04DA-A	4-channel analog input module Hardware resolution: 12 bits -10 to +10 V, 0–20 mA, 4–20 mA Conversion time: 2 ms/channel
	AS06XA-A	4-channel analog input module Hardware resolution: 16 bits 0–10 V, 0/1–5 V, -5 to +5 V, -10 to +10 V, 0/4–20 mA, -20 to +20 mA Conversion time: 2 ms/channel (FW V1.02 or later: 1 ms/channel) 2-channel analog input module Hardware resolution: 12 bits -10 to +10 V, 0–20 mA, 4–20 mA Conversion time: 2 ms/channel
	AS02ADH-A	2-channel analog input module Hardware resolution: 16 bits 0–10 V, 0/1–5 V, -5 to +5 V, -10 to +10 V, 0/4–20 mA, -20 to +20 mA High-speed conversion time: 2 μs Full isolation (the analog channels are isolated from one another.) Logging function enable/disable: 2000 data per channel, peak records Filtering: Low-pass filter, band-pass filter
Temperature measurement module	AS04RTD-A	4-channel, 2-wire/3-wire RTD Sensor type: Pt100 / Ni100 / Pt1000 / Ni1000 / JPt100 / LG-Ni1000 / Cu50 / Cu100 / 0–300Ω / 0–3000Ω input impedance and Ni120 (FW V1.06 or later) Resolution: 0.1°C/0.1°F (16 bits) Conversion time: 200 ms/channel
	AS06RTD-A	6-channel, 2-wire/3-wire RTD Sensor type: Pt100 / Ni100 / Pt1000 / Ni1000 / JPt100 / LG-Ni1000 / Cu50 / Cu100 / 0–300Ω / 0–3000Ω input impedance and Ni120 (FW V1.06 or later)

Classification	Model Name	Description
		Resolution: 0.1°C/0.1°F (16 bits) Conversion time: 200 ms/channel
	AS04TC-A	4-channel thermocouple Sensor type: J, K, R, S, T, E, N, B, and -100 to +100 mV Resolution: 0.1°C/0.1°F (24 bits) Conversion time: 200 ms/channel
	AS08TC-A	8-channel thermocouple Sensor type: J, K, R, S, T, E, N, B, and -100 to +100 mV Resolution: 0.1°C/0.1°F (24 bits) Conversion time: 200 ms/channel
Load cell module	AS02LC-A	2-channel, 4-wire/6-wire load cell sensor Eigenvalue applicable to a load cell: 1, 2, 4, 6, 20, 40, 80 mV/V Highest accuracy: 0.04% of full-scale ADC Resolution : 24 bits Conversion time: 2.5–400 ms (nine options to choose from)
Positioning / counter module	AS02PU-A	2-axis positioning control 5-24 VDC, 1 (A/B/Z phase) differential input, hardware maximum bandwidth for input: 200 kHz; 24 VDC, 5 mA, 5 external inputs, hardware maximum bandwidth for input: 1 kHz; 5 VDC, 2-axis (4 points) high-speed differential outputs, maximum bandwidth for output: 200 kHz;
	AS04PU-A	4-axis positioning control 24 VDC, 5mA, 6 inputs, hardware maximum bandwidth for input: 1 kHz; 5-30 VDC, 0.1A, 4-axis (8 points) NPN output, maximum bandwidth for output: 100 kHz;
	AS02HC-A	2-channel high-speed counters Input methods for the 2-channel are pulse-input (max. at 200 kHz) and SSI communication interface input (max. at 1.25 MHz) Incrementing / decrementing encoder input 4-point high-speed open collector output, 5-30 VDC, 0.1A, work with high speed differential output
Network module	AS00SCM-A	Serial communication module, 2x communication ports, applicable to communication cards, supporting MODBUS protocols
	AS01DNET-A	DeviceNet communication port, functioning as master or slave
	AS04SIL-A	IO-Link module, built-in with 4 IO-Link communication ports
Remote I/O module	AS00SCM-A + AS-FCOPM	Network module with AS-FCOPM function cards
	AS00SCM-A + AS-FEN02	Network module with AS-FEN02 function cards
	AS01DNET-A (RTU)	DeviceNet remote IO slave, its right side connectswith AS Series extension modules, including digital modules, analog modules, temperature modules, etc.
Function cards	AS-F232	Serial communication port, RS232, functioning as master or slave
	AS-F422	Serial communication port, RS422, functioning as master or slave
	AS-F485	Serial communication port, RS485, functioning as master or slave
	AS-FCOPM	CANopen communication port, supporting DS301, AS series remote modules, and Delta servo systems
	AS-F2AD	2-channel analog input, 0–10 V (12 bits), 4–20 mA (11 bits), Conversion time: 3 ms/channel
	AS-F2DA	2-channel analog input, 0–10 V, 4–20 mA (12 bits), Conversion time: 2 ms/channel

Classification	Model Name	Description
	AS-FEN02	2x Ethernet ports, supporting data exchange, supporting MODBUS TCP, EtherNet/IP Adapter, AS Series remote control, and DLR function
	AS-FPFN02	2x Ethernet ports, supporting data exchange, supporting PROFINET Device (adapter)
	AS-FOPC02	2x Ethernet ports, supporting data exchange, supporting OPC UA Server, only available for AS300 Series PLC CPU
	AS-FFTP01	1x Ethernet ports, supporting FTP Server, OPC UA Server, MQTT Client, Web Server, Data log, only available for AS300 Series PLC CPU
	AS-FECAT	2x Ethernet ports, supporting data exchange (before EtherCAT Master enabled), MODBUS TCP Server (1 connection), EtherCAT Master 16-axes point-to-point positioning control (only available for Delta drive), only available for AS 300 Series PLC CPU

1.2 Specifications

1.2.1 General Specifications

Item	Specifications
Operating temperature	-20 to +60°C
Storage temperature	-40 to +80°C
Operating humidity	5–95% No condensation
Storage humidity	5–95% No condensation
Work environment	No corrosive gas
Installation location	In a control box
Pollution degree	2
Ingress protection (IP ratings)	IP20
EMC (electromagnetic compatibility)	Refer to Chapter 7 for more information.
Vibration resistance	Tested with: 5 Hz \leq f \leq 8.4 Hz, constant amplitude 3.5 mm 8.4 Hz \leq f \leq 150 Hz, constant acceleration 1 g Duration of oscillation: 10 sweep cycles per axis on each direction of the three mutually perpendicular axes International Standard IEC 61131-2 & IEC 60068-2-6 (TEST Fc)
Shock resistance	Tested with: Half-sine wave Strength of shock: 15 g peak value, 11 ms duration Shock direction: The shocks on each direction per axis, of the three mutually perpendicular axes (for a total of 18 shocks) International Standard IEC 61131-2 & IEC 60068-2-27 (TEST Ea)
Safety	Conforms to IEC 61131-2, UL508
Ambient air temperature-barometric pressure-altitude	Operating: 1080 ~ 795hPa (-1000 ~ 2000 m) Storage:1080 ~ 660hPa (-1000 ~ 3500 m)

1.2.2 EMS Standards

1.2.2.1 EMI

Port	Frequency Range	Level (Normative)	Reference Standard
Enclosure port (radiated) (measured at a distance of 10 meters)	30-230 MHz	40 dB ($\mu\text{V}/\text{m}$) quasi-peak	IEC 61000-6-4
	230-1000 MHz	47 dB ($\mu\text{V}/\text{m}$) quasi-peak	
AC power port (conducted)	0.15-0.5 MHz	79 dB (μV) quasi-peak	
		66 dB (μV) average	
	0.5-30 MHz	73 dB (μV) quasi-peak	
		60 dB (μV) average	

1.2.2.2 EMS

Environmental Phenomenon	Reference Standard	Test		Test Level
Electrostatic Discharge	IEC 61000-4-2	Contact		± 4 kV
		Air		± 8 kV
Radio Frequency Electromagnetic Field Amplitude Modulated	IEC 61000-4-3	80% AM, 1 kHz sinusoidal	2.0-2.7 GHz	1 V/m
			1.4-2.0 GHz	3 V/m
			80-1000 MHz	10 V/m
Power Frequency Magnetic Field	IEC 61000-4-8	60 Hz		30 A/m
		50 Hz		30 A/m

1.2.2.3 Conducted Immunity Test

Environmental Phenomenon		Fast Transient Burst	High Energy Surge	Radio Frequency Interference
Reference Standard		IEC 61000-4-4	IEC 61000-4-5	IEC 61000-4-6
Interface/Port	Specific Interface/Port	Test Level	Test Level	Test Level
Data communication	Shielded cable	1 kV	1 kV CM	10 V
	Unshielded cable	1 kV	1 kV CM	10 V
Digital and analog I/O	AC I/O (unshielded)	2 kV	2 kV CM 1 kV DM	10 V
	Analog or DC I/O (unshielded)	1 kV	1 kV CM	10 V
	All shielded lines (earth)	1 kV	1 kV CM	10 V
Equipment power	AC power	2 kV	2 kV CM 1 kV DM	10 V
	DC power	2 kV	0.5 kV CM 0.5 kV DM	10 V
I/O power and auxiliary power output	AC I/O and AC auxiliary power	2 kV	2 kV CM 1 kV DM	10 V
	DC I/O and DC auxiliary power	2 kV	0.5 kV CM 0.5 kV DM	10 V

1.3 Installation

1.3.1 Installing a Module

1. Push the clip rings if they are out as the image 1 shown. Push the module to the desire position until you hear a click to finish installation.
2. Link the I/O modules on the right side of the PLC and make sure they are hooked together. Push the modules into the DIN rail until you hear a click.
3. After you installed the module, fasten the screws on the modules to secure the module on the DIN rail.

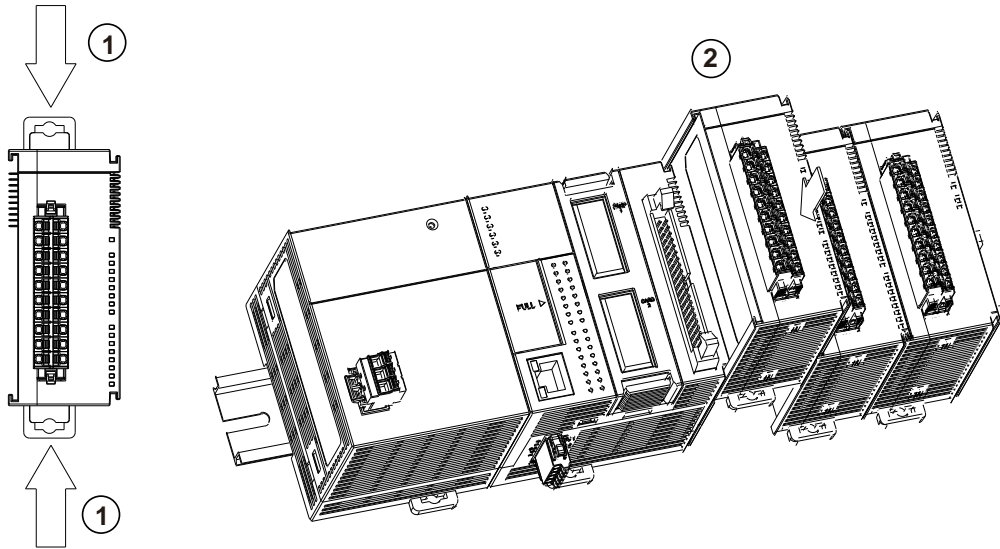

If there is a vibration source near the installation site, install anti-vibration baffles on the sides of the AS Series modules for better stabilization, such as the gray baffles show below.

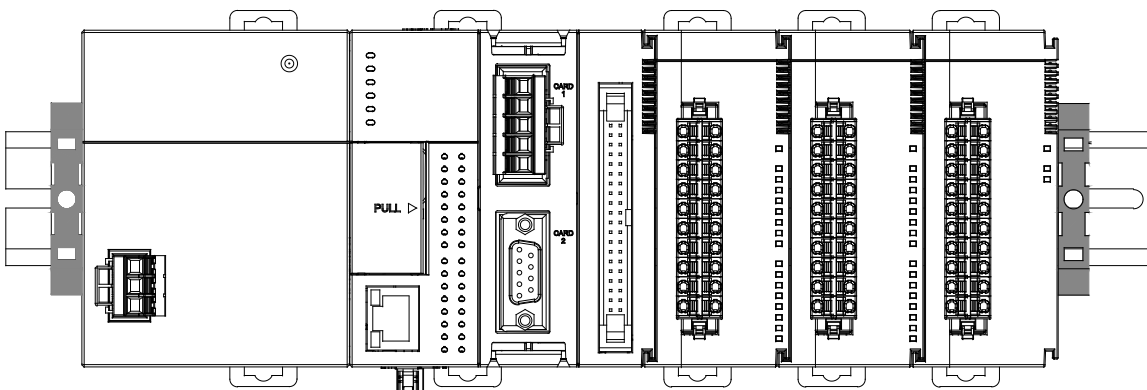

- **Install the baffles:**

1. Hook the baffle onto the DIN rail and press it down as the directional arrow shows below.

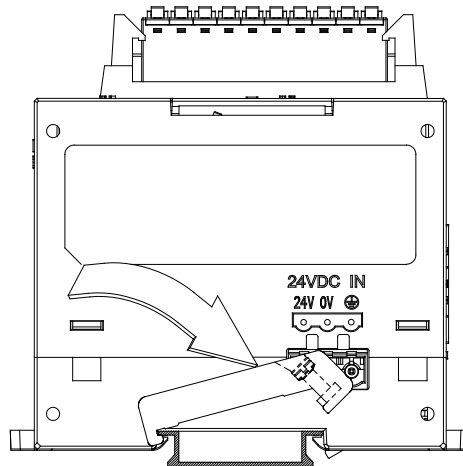

2. Use screws to secure the baffle.

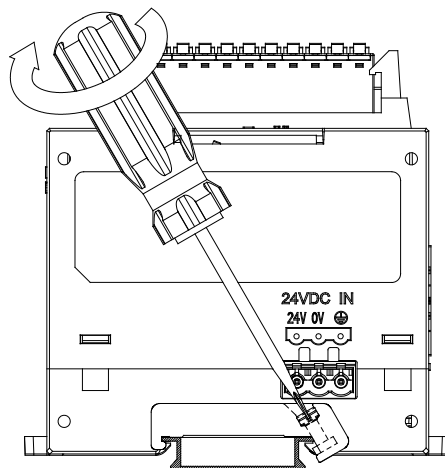

3. The completed baffle installation is as shown below.

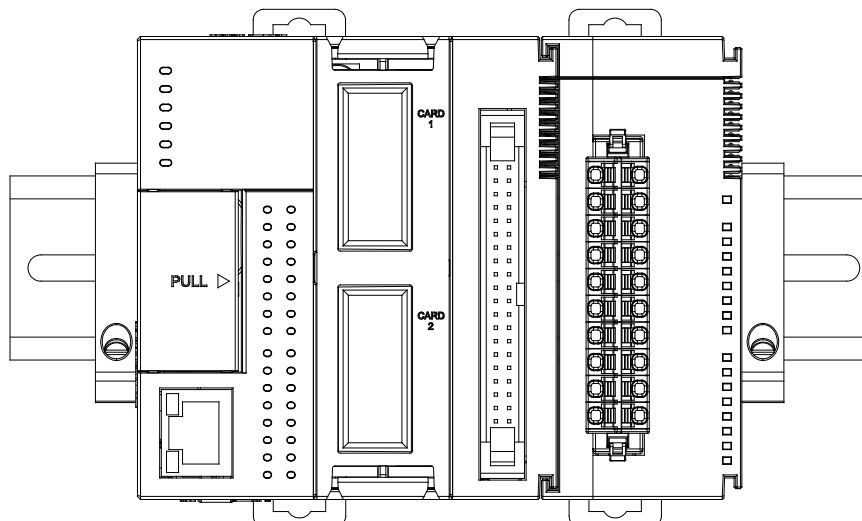

1.3.2 Installing a Removable Terminal Block

Install a removable terminal block on the module as illustrated below.

- **Installation**

Align the terminal block at the port, and press it into the CPU.

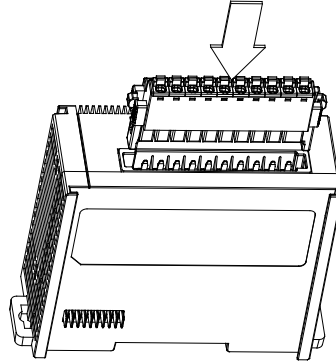

- **Removal**

Push the clips inward as the arrow 1 shown to release the terminal block and then pull it up as the arrow 2 shown.

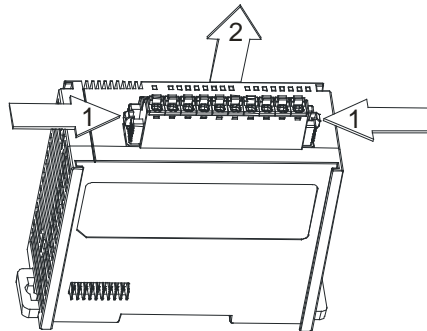

1.3.3 Changing a Module

1. Take the removable terminal block out of the module, and then pull the clip out from the DIN rail as shown below.

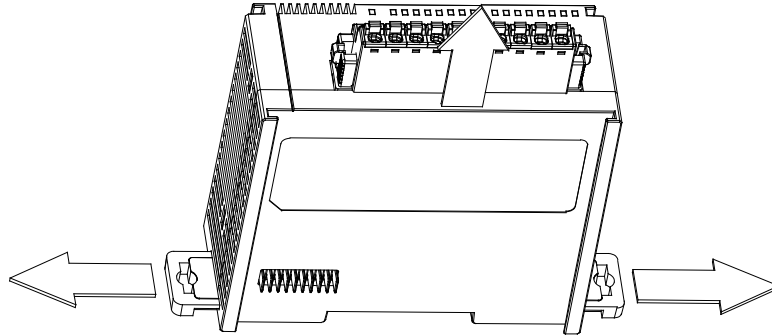

2. Remove the module.
3. Slide the new module in as shown below.

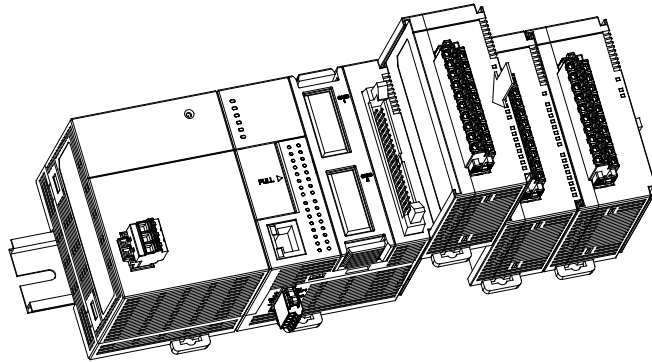

1.3.4 Installing and Removing an Extension Card

● Installation

Push the extension card into the extension card slot until you hear a click.

Note: before the installation begin, you need to check if the pin arrangement and appearance are normal. If there is any bent or missing pin, you need to change to a new card. You should also check the PLC card slot to make sure everything is ok.

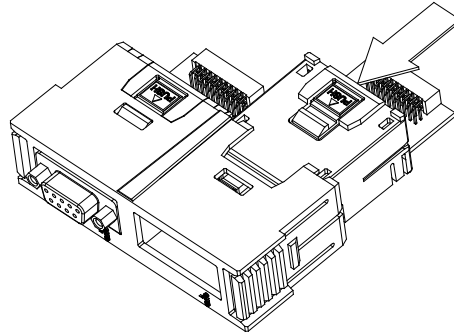

● Removal

Press the tab labeled  to release the extension card, and then remove the extension card.

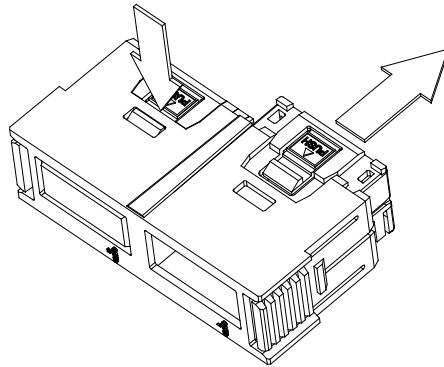

1.3.5 Installing a Wiring Module

Connect a communication cable to the port on a CPU module, and make sure that the connector of the cable is properly seated in the port.

- **Installation**

1. Firmly seat one side of the wiring module first.
2. Press the driver board in the direction indicated by arrow 1, and make sure that the groove is attached to the DIN rail.

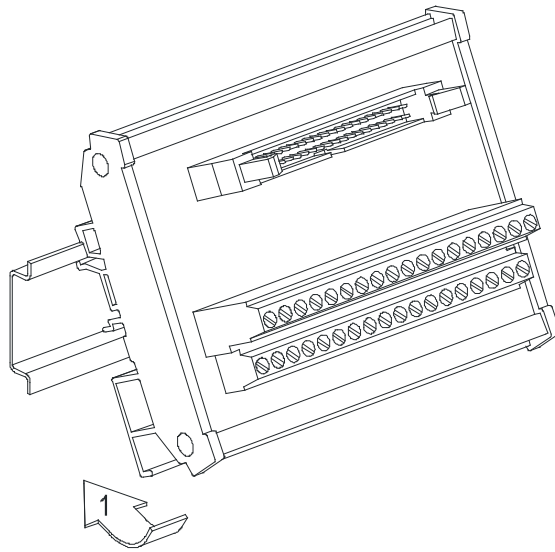

- **Removal**

1. Push the wiring module in the direction indicated by arrow 1.
2. Pull the wiring module in the direction indicated by arrow 2.

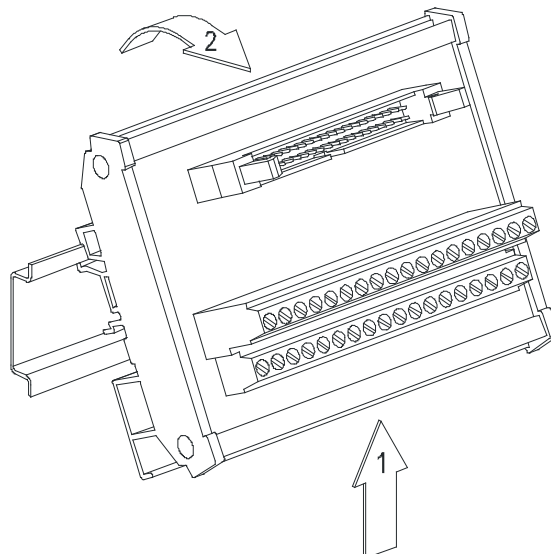

MEMO

1

Chapter 2 Digital Input/Output Modules

Table of Contents

- 2.1 Digital Input/Output Module Specifications.....2-2**
- 2.1.1 General Specifications..... 2-2
- 2.1.2 Digital Input/Output Module Profiles 2-4
- 2.1.3 Digital Input/Output Module Terminals 2-12

2.1 Digital Input/Output Module Specifications

2.1.1 General Specifications

- Electrical specifications for the inputs on digital input/output modules

(The signals passing through the inputs are 24 VDC signals.)

Module name		08AM10N -A	16AM10N -A	32AM10N -A	64AM10N -A	16AP11R A	16AP11T -A	16AP11P -A
Number of inputs		8	16	32	64	8	8	8
Connector type		Removable terminal block		MIL connector		Removable terminal block		
Input type		Digital input						
Input form		Direct current (sinking or sourcing)						
Input voltage/ current		24 VDC · 5 mA			24 VDC 3.2 mA	24 VDC · 5 mA		
Input impedance		4.7 k Ω			7.5k Ω	4.7 k Ω		
Action level	OFF→ON	>15 VDC						
	ON→OFF	<5 VDC						
Response time	OFF→ON	< 20 us						
	ON→OFF	< 200 us						
Software filter time		Setting range: 0 ~ 25 ms; default: 10 ms						
Maximum input frequency		Varies according to the filter time; for example when the filter is 1 ms, the maximum input frequency is 500 Hz, when 2 ms, 250 Hz. Note: CPU scan time also affects the maximum input frequency.						
Input signal		Voltage input Sinking: The inputs are NPN transistors whose collectors are open collectors. Sourcing: The inputs are PNP transistors whose collectors are open collectors.						
Input isolation voltage		500 VAC						
Input display		When the optocoupler is driven, the input LED indicator is ON.						
Weight		100 g	117 g	100 g	140 g	138 g	120 g	120 g

- Electrical specifications for the outputs on a digital input/output module

Item	Model	08AN01	16AN01	16AP11	08AN01	16AN01	16AP11	08AN01	16AN01	16AP11
		R-A	R-A	R-A	T-A	T-A	T-A	P-A	P-A	P-A
Number of outputs		8	16	8	8	16	8	8	16	8
Connector type		Removable terminal block								
Output type		Digital output								
Output form		Relay-R			Transistor-T (sinking)			Transistor-P (sourcing)		
Voltage/ current		240 VAC/24 VDC			5–30 VDC			5–30 VDC		
Leakage current		0uA			<10uA			<250uA (@V1.00A0) <10uA (@V1.00A1)		
Maximum load	Resistance	2A/output, 8A/COM			0.5A/output, 4A/COM			0.5A/output, 4A/COM		
	Inductance	Life cycle curve ²			12 W (24 VDC)			12 W (24 VDC)		
	Bulb	20 W (24 VDC) 100 W (230 VAC)			2 W (24 VDC)			2 W (24 VDC)		
Maximum	Resistance	1 Hz			100 Hz			100 Hz		

Item		Model	08AN01	16AN01	16AP11	08AN01	16AN01	16AP11	08AN01	16AN01	16AP11
		R-A	R-A	R-A	T-A	T-A	T-A	P-A	P-A	P-A	
output frequency*1	Inductance	0.5 Hz			0.5 Hz			0.5 Hz			
	Bulb	1 Hz			10 Hz			10 Hz			
	OFF→ON	10 ms			0.5 ms			0.5 ms			
Maximum Response time	ON→OFF	10 ms			0.5 ms			0.5 ms			
Output isolation voltage		1500 VAC			500 VAC						
Weight		120 g	158 g	138 g	100 g	122 g	120 g	100 g	123 g	120 g	

Item		Model	32AN02T-A	64AN02T-A
Number of outputs			32	64
Connector type			MIL connector	
Output type			Digital output	
Output form			Transistor-T (sinking)	
Output voltage			5-30 VDC	
Leadage current			<10uA	
Maximum load	Resistance		0.1A/output, 3.2A/COM	
	Inductance		N/A	
	Bulb		N/A	
Maximum output frequency*1	Resistance		100 Hz	
	Inductance		N/A	
	Bulb		N/A	
Maximum Response time	OFF→ON		0.5 ms	
	ON→OFF			
Output isolation voltage			500 VAC	
Weight			100 g	142 g

*1: The scan cycle affects the frequency.

*2: The life cycle curve is shown below.

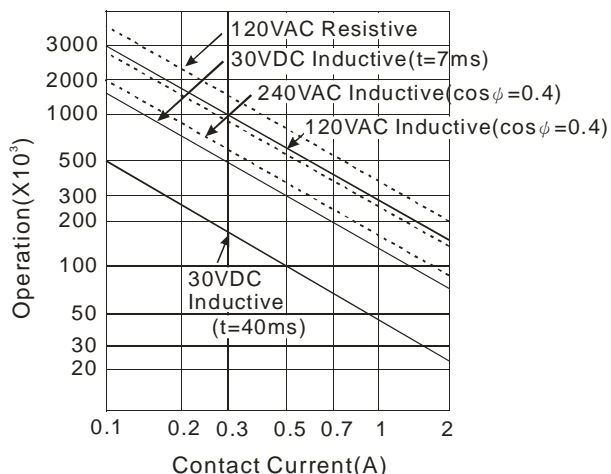

2.1.2 Digital Input/Output Module Profiles

- AS08AM10N-A/AS08AN01P-A/AS08AN01R-A/AS08AN01T-A

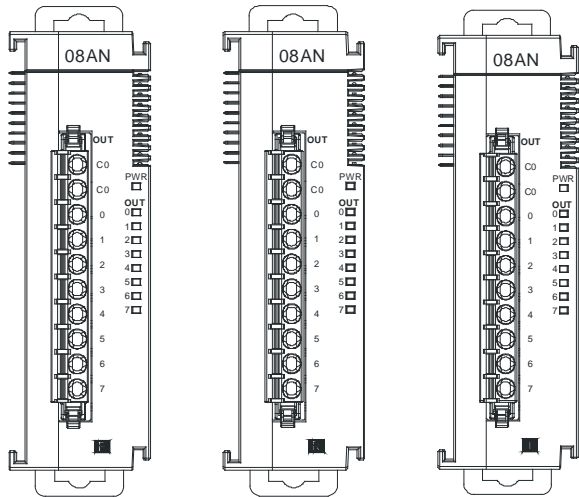
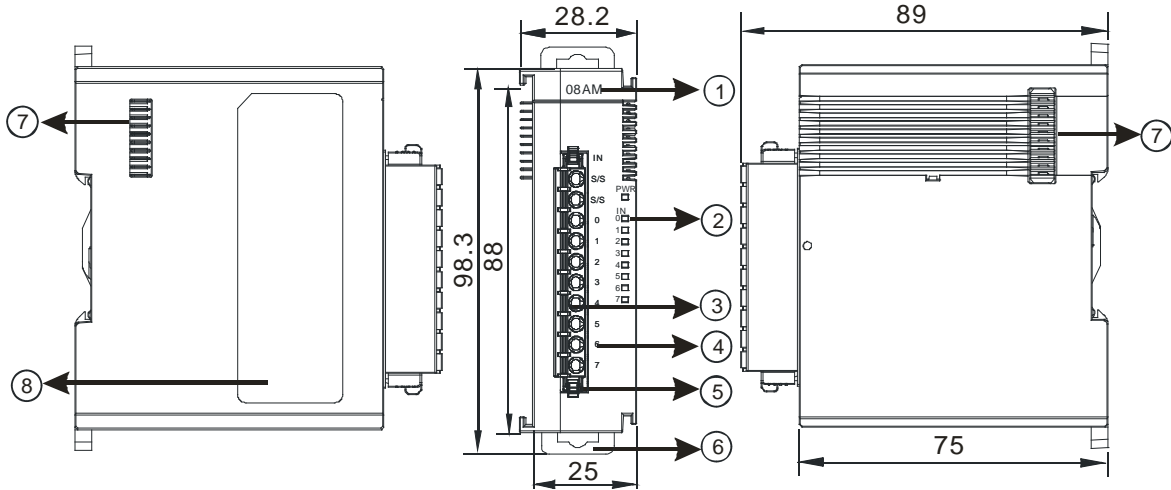

Unit: mm

Number	Name	Description
1	Model name	Model name of the module
2	Input/output LED indicator	If there is an input signal, the input LED indicator is ON. If there is an output signal, the output LED indicator is ON.
3	Removable terminal block	The inputs are connected to sensors. The outputs are connected to loads to be driven.
4	Arrangement of the input/output terminals	Arrangement of the terminals
5	Terminal block clip	Secures the terminal block
6	DIN rail clip	Secures the DIN rail
7	External module port	Connects the modules
8	Label	Nameplate

- AS16AM10N-A/AS16AN01P-A/AS16AN01R-A/AS16AN01T-A/AS16AP11P-A/AS16AP11R-A/AS16AP11T-A

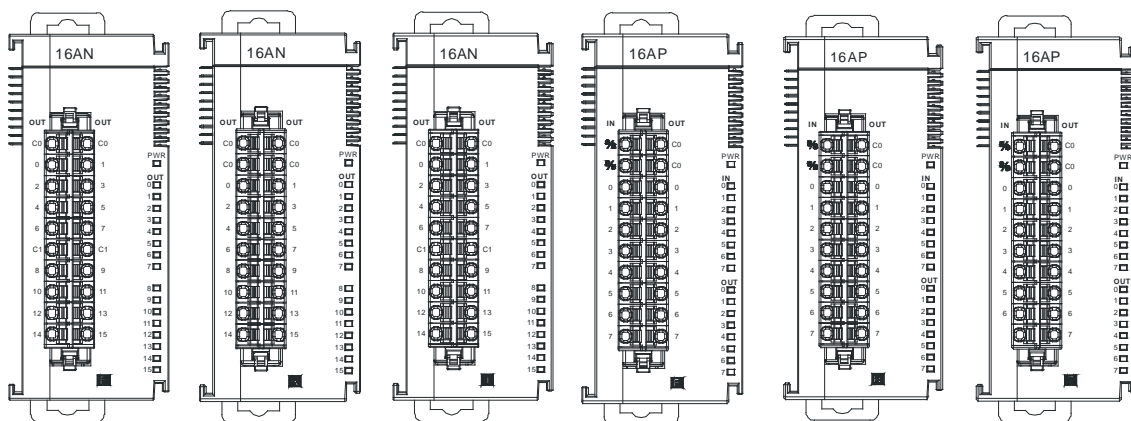
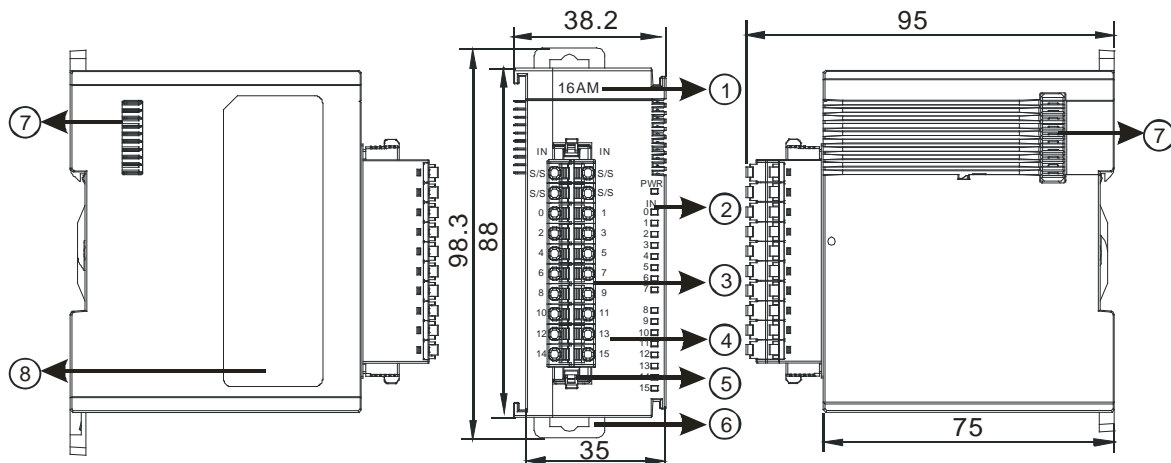

Unit: mm

Number	Name	Description
1	Model name	Model name of the module
2	Input/Output LED indicator	If there is an input signal, the input LED indicator is ON. If there is an output signal, the output LED indicator is ON.
3	Removable terminal block	The inputs are connected to sensors. The outputs are connected to loads to be driven.
4	Arrangement of the input/output terminals	Arrangement of the terminals
5	Terminal block clip	Secures the terminal block
6	DIN rail clip	Secures the DIN rail
7	External module port	Connects the modules
8	Label	Nameplate

Number	Name	Description
1	Model name	Model name of the module
2	Y0/Y1 LED indicator switch	Switches the LED indicators to their represented outputs.
3	ML connector	For the external I/O connecting cables UC-ET010-24D, UC-ET020-24D, UC-ET030-24D
4	Power LED indicator	Indicates the power status of the module
5	Output LED indicator	LED indicator is ON during output.
6	DIN rail clip	Secures the DIN rail
7	External module port	Connects the modules
8	Label	Nameplate

● AS64AM10N-A

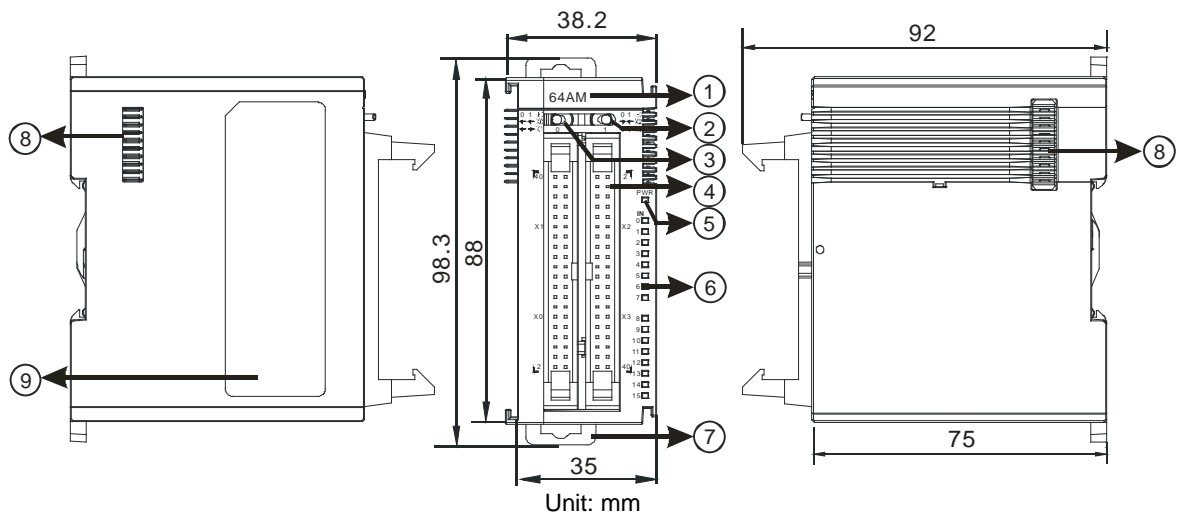

Number	Name	Description
1	Model name	Model name of the module
2	LED indicator switch 1	Switches the LED indicators to their represented inputs.
3	LED indicator switch 2	Switches the LED indicators to their represented inputs.
4	ML connector	For the external I/O connecting cables UC-ET010-24B, UC-ET020-24B, UC-ET030-24B
5	Power LED indicator	Indicates the power status of the module
6	Input LED indicator	If there is an input signal, the input LED indicator is ON.
7	DIN rail clip	Secures the DIN rail
8	External module port	Connects the modules
9	Label	Nameplate

● AS64AN02T-A

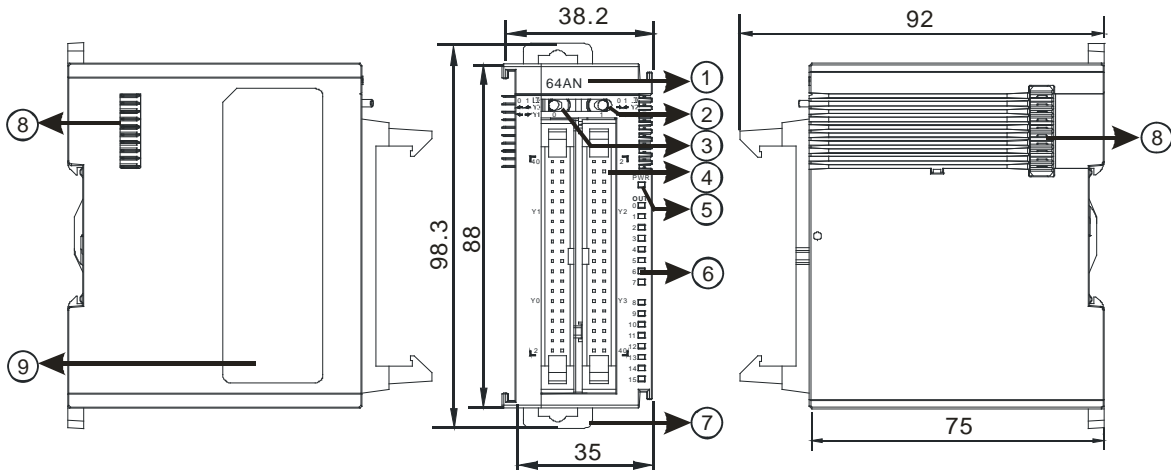

Unit: mm

Number	Name	Description
1	Model name	Model name of the module
2	LED indicator switch 1	Switches the LED indicators to their represented outputs.
3	LED indicator switch 2	Switches the LED indicators to their represented outputs.
4	ML connector	For the external I/O connecting cables UC-ET010-24D, UC-ET020-24D, UC-ET030-24D
5	Power LED indicator	Indicates the power status of the module
6	Output LED indicator	If there is an output signal, the output LED indicator is ON.
7	DIN rail clip	Secures the DIN rail
8	External module port	Connects the modules
9	Label	Nameplate

● ML connector, extension cable, and wiring modules

1. Extension Cable UC-ET010-24D (1M) / UC-ET020-24D (2M) / UC-ET030-24D (3M)

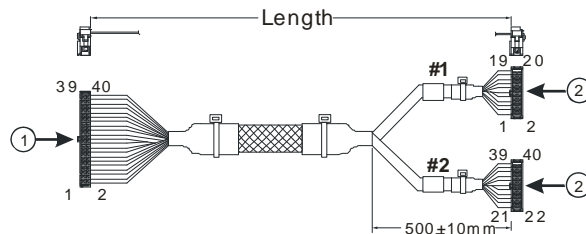

Unit: mm

Number	Name	Description
1	IDC 40-pin terminal	Connects a digital input/output module and an external terminal module.
2	IDC 20-pin terminal	Connects the external terminal modules UB-10-ID16A/UB-10-OR16A/UB-10-OR16B

2. I/O connecting cables UC-ET010-24B (1M) / UC-ET020-24B (2M) / UC-ET030-24B (3M)

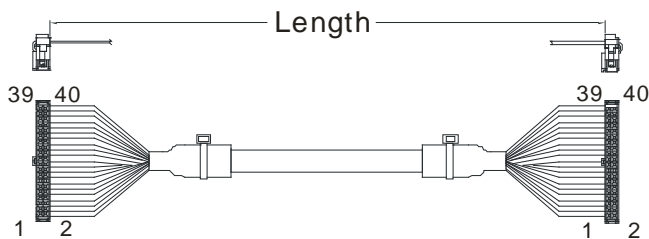

Number	Name	Description
1	IDC 40-pin terminal	Connects an external terminal module and a wiring module UB-10-ID32A, and UB-10-OT32A

3. AS32AM10N-A/AS64AM10N-A and the external terminal modules UB-10-ID16A, UB-10-ID32A

◆ UB-10-ID16A

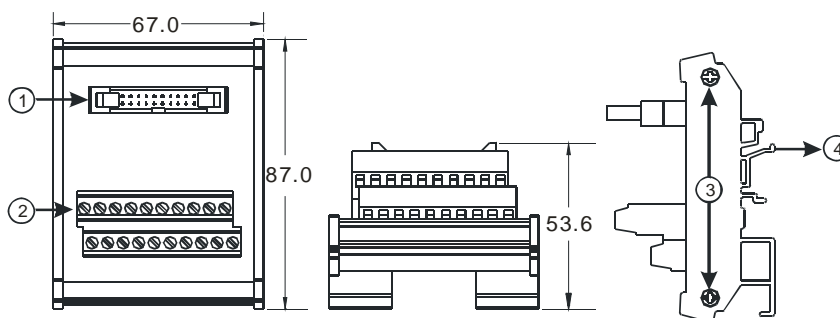

Unit: mm

◆ UB-10-ID32A

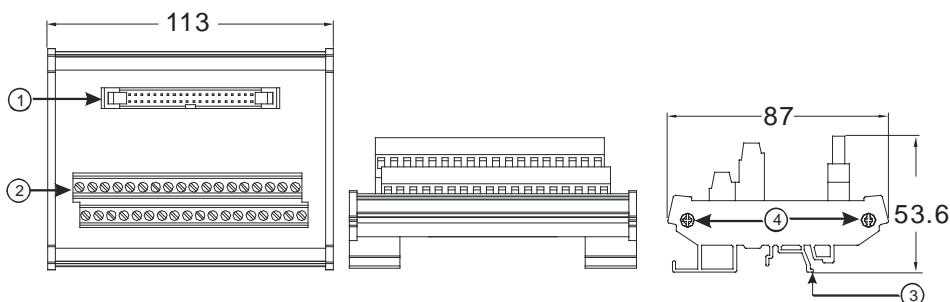

Unit: mm

Number	Name	Description
1	UB-10-ID16A: 20-pin ML connector UB-10-ID32A: 40-pin ML connector	Connects the external terminal module and a wiring module
2	Terminals	Input/Output terminals for wiring
3	Clip	Hangs the external terminal module on a DIN rail
4	Set screw	Fixes the base

4. AS332T-A/AS64AN02T-A and the external terminal modules UB-10-ID16A, UB-10-OR16A, and UB-10-OT32A.

◆ UB-10-ID16A

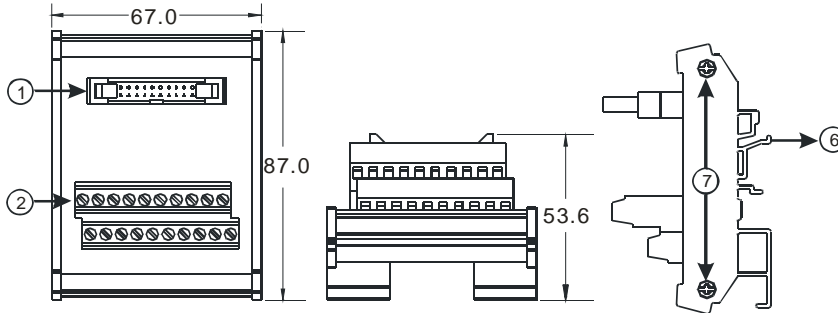

Unit: mm

◆ UB-10-OR16A

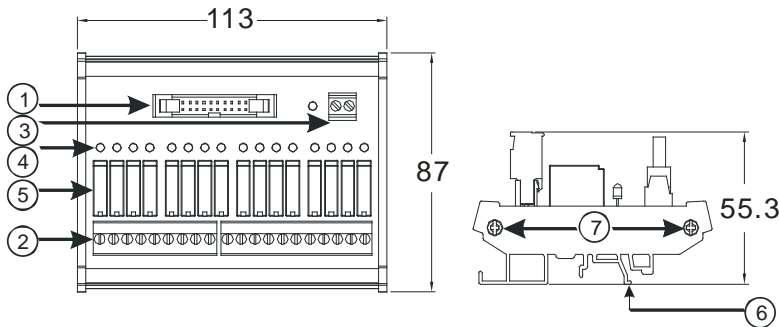

Unit: mm

◆ UB-10-OT32A

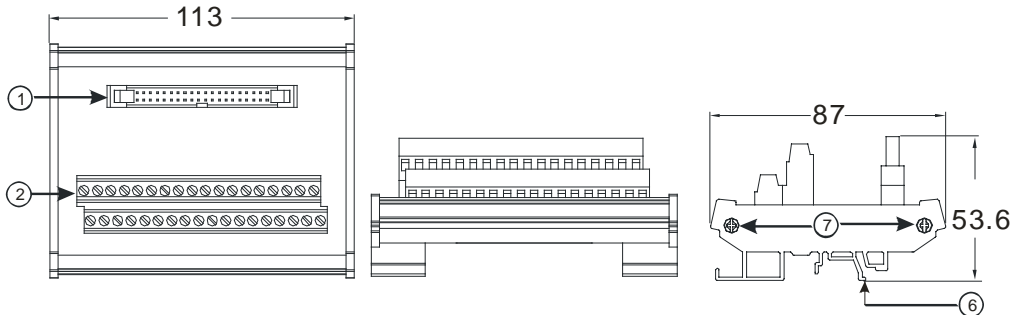

Unit: mm

Number	Name	Description
1	UB-10- ID16A /OR16A: 20-pin ML connector UB-10-OT32A: 40-pin ML connector	Connects the external terminal module and a wiring module
2	Terminals	Input/Output terminals for wiring
3	2-pin power input terminal	Power input terminal for wiring
4	Output LED indicator	LED indicator is ON during output.
5	Relay output	Relay output
6	Clip	Hangs the external terminal module on a DIN rail
7	Set screw	Fixes the base

- Spring clamp/MIL connector terminal block UB-10-IO32D for AS32AM10N-A/AS32AN02T-A

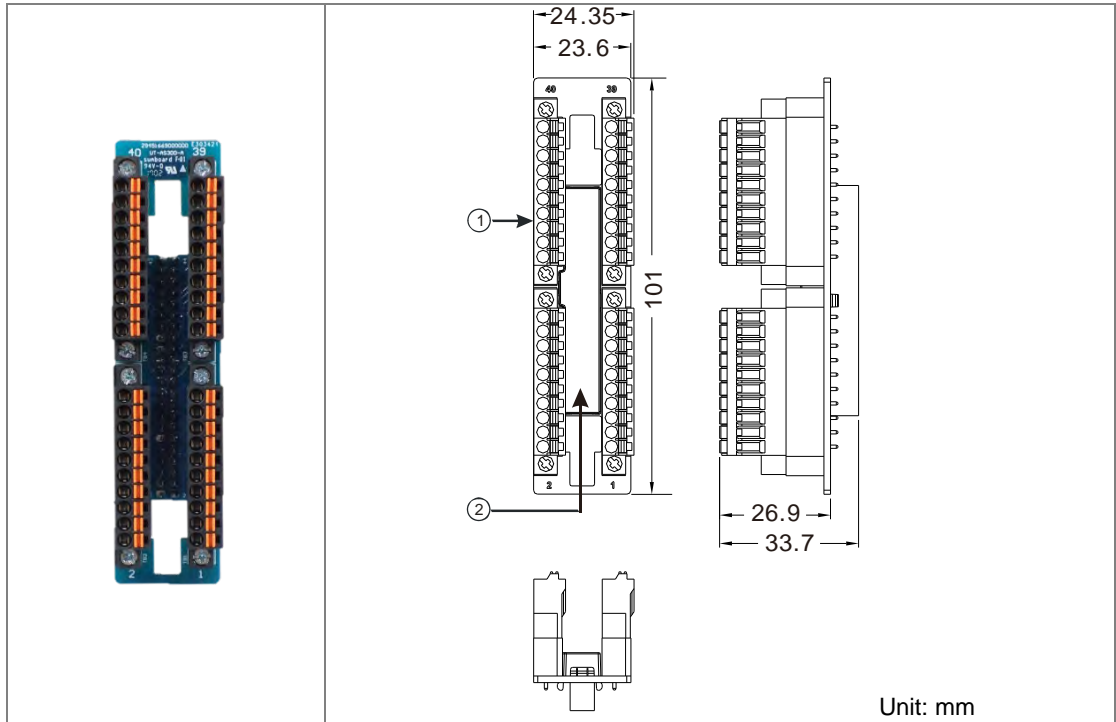

Number	Name	Description
1	Terminal block for output	Terminal block
2	40-pin MIL connector	Connects the module and the wiring module

2.1.3 Digital Input/Output Module Terminals

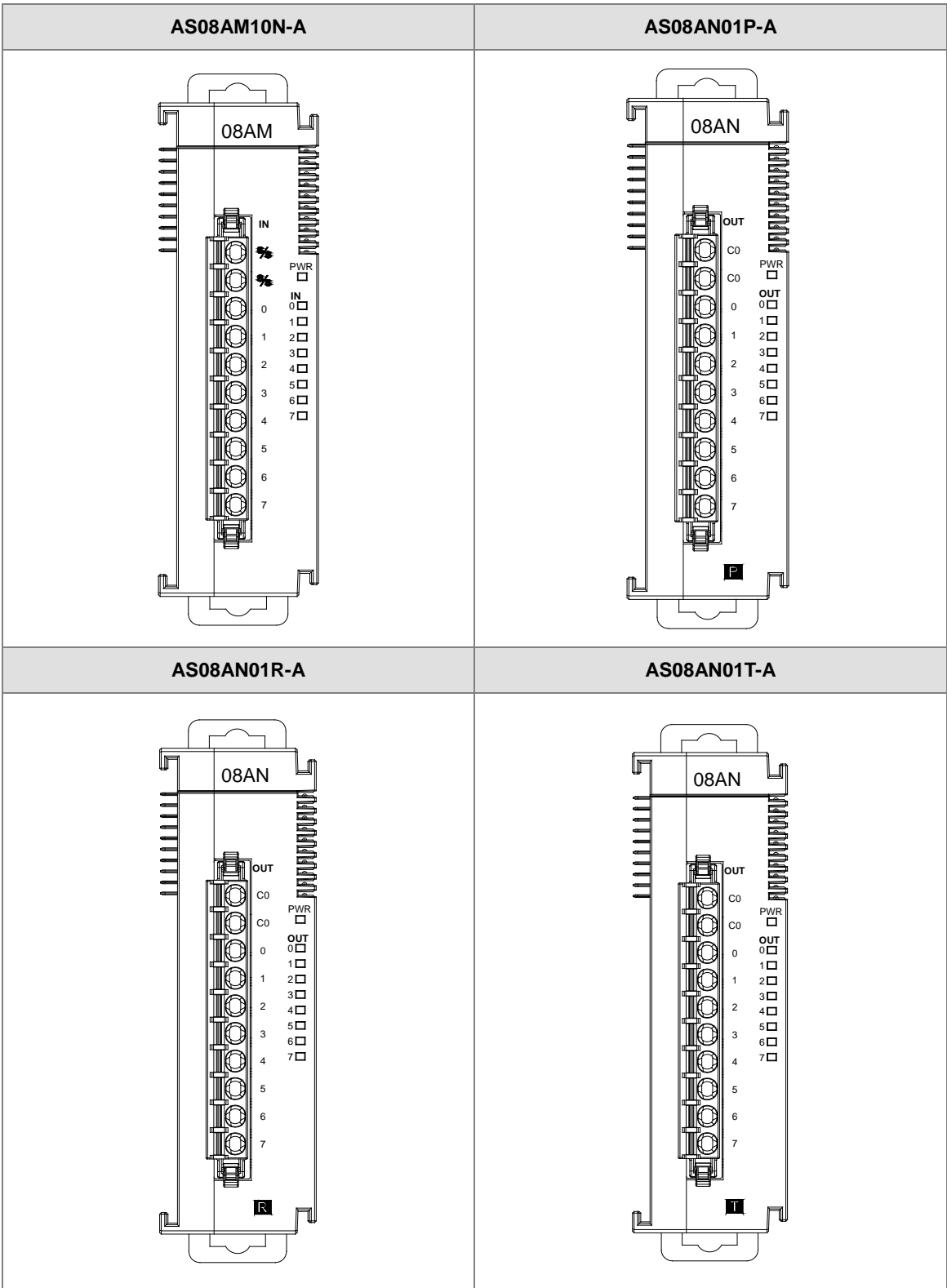

2

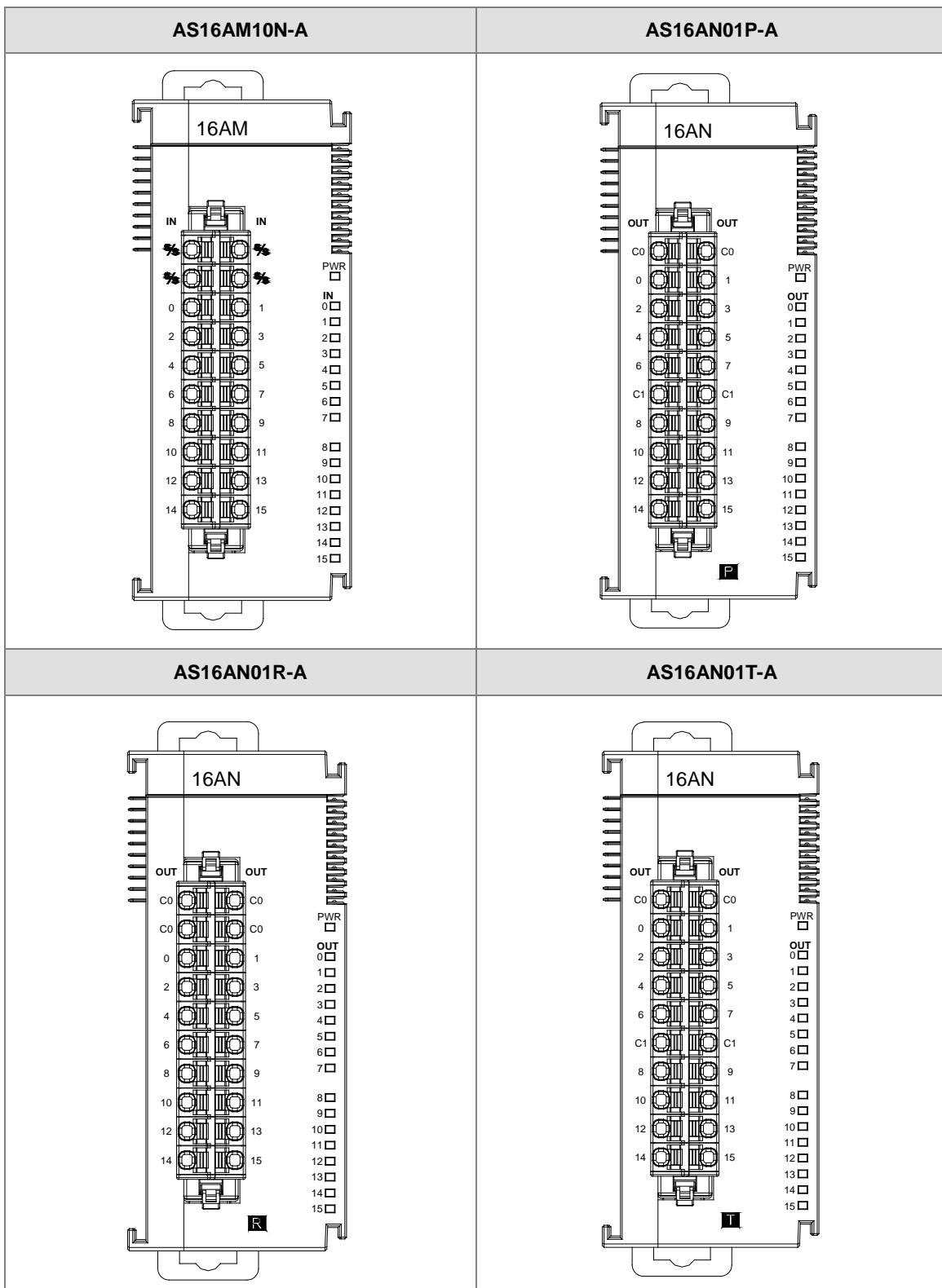

2

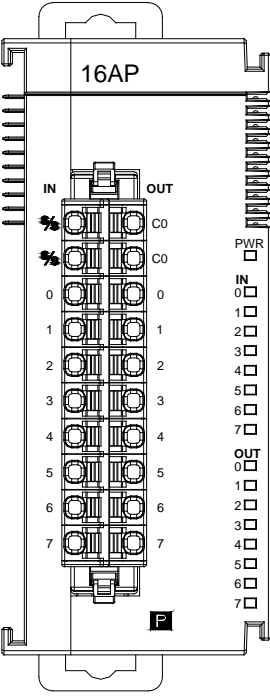
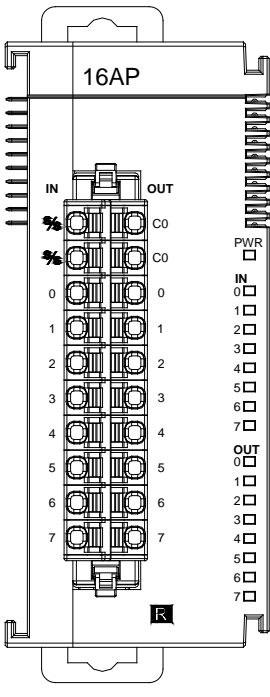
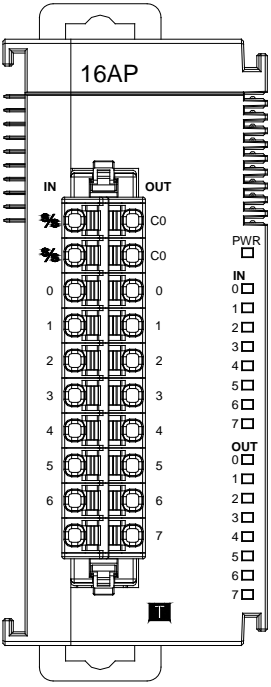
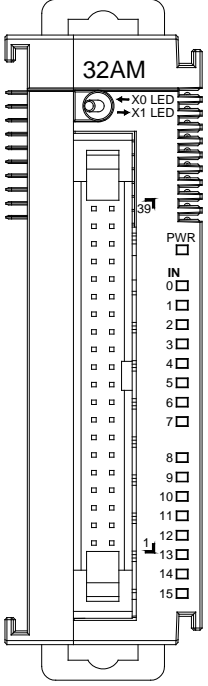
AS16AP11P-A	AS16AP11R-A																																								
																																									
AS16AP11T-A	AS32AM10N-A																																								
	<div style="display: flex; align-items: center;">  <table border="1" style="width: 50%; border-collapse: collapse; margin-left: 10px;"> <tbody> <tr><td style="text-align: center;">-</td><td style="text-align: center;">-</td></tr> <tr><td style="text-align: center;">S/S</td><td style="text-align: center;">S/S</td></tr> <tr><td style="text-align: center;">1.15</td><td style="text-align: center;">1.14</td></tr> <tr><td style="text-align: center;">1.13</td><td style="text-align: center;">1.12</td></tr> <tr><td style="text-align: center;">1.11</td><td style="text-align: center;">1.10</td></tr> <tr><td style="text-align: center;">1.9</td><td style="text-align: center;">1.8</td></tr> <tr><td style="text-align: center;">1.7</td><td style="text-align: center;">1.6</td></tr> <tr><td style="text-align: center;">1.5</td><td style="text-align: center;">1.4</td></tr> <tr><td style="text-align: center;">1.3</td><td style="text-align: center;">1.2</td></tr> <tr><td style="text-align: center;">1.1</td><td style="text-align: center;">1.0</td></tr> <tr><td style="text-align: center;">-</td><td style="text-align: center;">-</td></tr> <tr><td style="text-align: center;">S/S</td><td style="text-align: center;">S/S</td></tr> <tr><td style="text-align: center;">0.15</td><td style="text-align: center;">0.14</td></tr> <tr><td style="text-align: center;">0.13</td><td style="text-align: center;">0.12</td></tr> <tr><td style="text-align: center;">0.11</td><td style="text-align: center;">0.10</td></tr> <tr><td style="text-align: center;">0.9</td><td style="text-align: center;">0.8</td></tr> <tr><td style="text-align: center;">0.7</td><td style="text-align: center;">0.6</td></tr> <tr><td style="text-align: center;">0.5</td><td style="text-align: center;">0.4</td></tr> <tr><td style="text-align: center;">0.3</td><td style="text-align: center;">0.2</td></tr> <tr><td style="text-align: center;">0.1</td><td style="text-align: center;">0.0</td></tr> </tbody> </table> </div>	-	-	S/S	S/S	1.15	1.14	1.13	1.12	1.11	1.10	1.9	1.8	1.7	1.6	1.5	1.4	1.3	1.2	1.1	1.0	-	-	S/S	S/S	0.15	0.14	0.13	0.12	0.11	0.10	0.9	0.8	0.7	0.6	0.5	0.4	0.3	0.2	0.1	0.0
-	-																																								
S/S	S/S																																								
1.15	1.14																																								
1.13	1.12																																								
1.11	1.10																																								
1.9	1.8																																								
1.7	1.6																																								
1.5	1.4																																								
1.3	1.2																																								
1.1	1.0																																								
-	-																																								
S/S	S/S																																								
0.15	0.14																																								
0.13	0.12																																								
0.11	0.10																																								
0.9	0.8																																								
0.7	0.6																																								
0.5	0.4																																								
0.3	0.2																																								
0.1	0.0																																								

AS32AN02T-A		AS64AM10N-A			
	-	-	-	-	-
	C0	C0	2.0	2.1	-
	1.15	1.14	2.2	2.3	-
	1.13	1.12	2.4	2.5	-
	1.11	1.10	2.6	2.7	-
	1.9	1.8	2.8	2.9	-
	1.7	1.6	2.10	2.11	-
	1.5	1.4	2.12	2.13	-
	1.3	1.2	2.14	2.15	-
	1.1	1.0	S/S	S/S	-
	-	-	-	-	-
	C0	C0	3.0	3.1	-
	0.15	0.14	3.2	3.3	-
	0.13	0.12	3.4	3.5	-
	0.11	0.10	3.6	3.7	-
0.9	0.8	3.8	3.9	-	
0.7	0.6	3.10	3.11	-	
0.5	0.4	3.12	3.13	-	
0.3	0.2	3.14	3.15	-	
0.1	0.0	S/S1	S/S1	-	
AS64AN02T-A					
	-	-	2.0	2.1	-
	C0	C0	2.2	2.3	-
	1.15	1.14	2.4	2.5	-
	1.13	1.12	2.6	2.7	-
	1.11	1.10	2.8	2.9	-
	1.9	1.8	2.10	2.11	-
	1.7	1.6	2.12	2.13	-
	1.5	1.4	2.14	2.15	-
	1.3	1.2	C1	C1	-
	1.1	1.0	-	-	-
	-	-	3.0	3.1	-
	C0	C0	3.2	3.3	-
	0.15	0.14	3.4	3.5	-
	0.13	0.12	3.6	3.7	-
	0.11	0.10	3.8	3.9	-
0.9	0.8	3.10	3.11	-	
0.7	0.6	3.12	3.13	-	
0.5	0.4	3.14	3.15	-	
0.3	0.2	C1	C1	-	
0.1	0.0	-	-	-	

● **ML connector and the wiring module**

1. AS32AM10N-A/AS64AM10N-A

◆ The wiring module: UB-10-ID16A

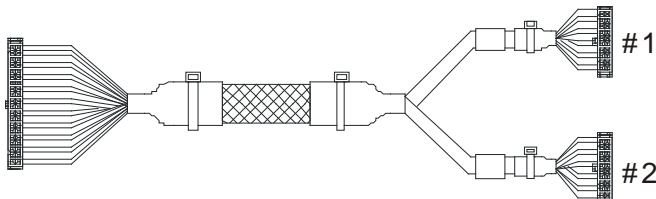
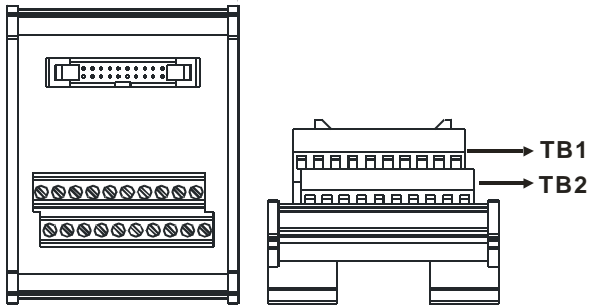

AS32AM10N-A/ AS64AM10N-A											
#2	TB1	X0.0	X0.2	X0.4	X0.6	X0.8	X0.10	X0.12	X0.14	S/S	-
	TB2	X0.1	X0.3	X0.5	X0.7	X0.9	X0.11	X0.13	X0.15	S/S	-

◆ The wiring module: UB-10-ID32A

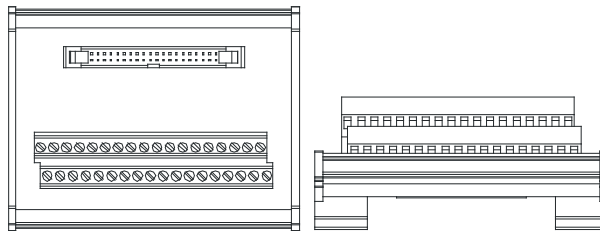

AS series terminals:

Upper row	X0.0	X0.2	X0.4	X0.6	X0.8	X0.10	X0.12	X0.14	X1.0	X1.2	X1.4	X1.6	X1.8	X1.10	X1.12	X1.14	S/S	S/S
Lower row	X0.1	X0.3	X0.5	X0.7	X0.9	X0.11	X0.13	X0.15	X1.1	X1.3	X1.5	X1.7	X1.9	X1.11	X1.13	X1.15	S/S	S/S

2. AS32AN02T-A/AS64AN02T-A and the wiring modules:

◆ UB-10-ID16A

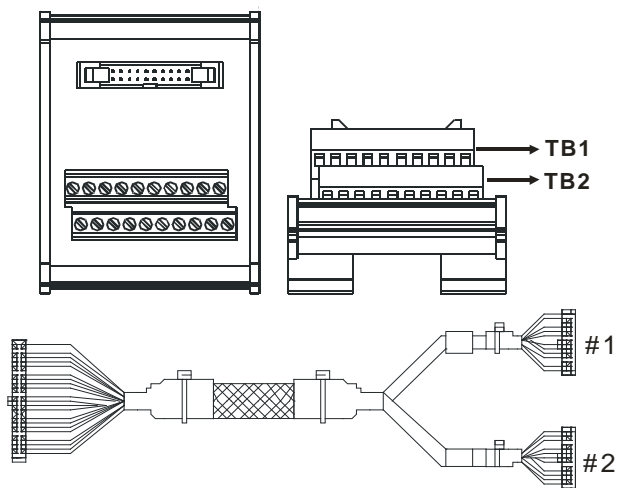

AS332T-A											
#1	TB1	Y0.0	Y0.2	Y0.4	Y0.6	Y0.8	Y0.10	Y0.12	Y0.14	C0	-
	TB2	Y0.1	Y0.3	Y0.5	Y0.7	Y0.9	Y0.11	Y0.13	Y0.15	C0	-

◆ UB-10-OT32A

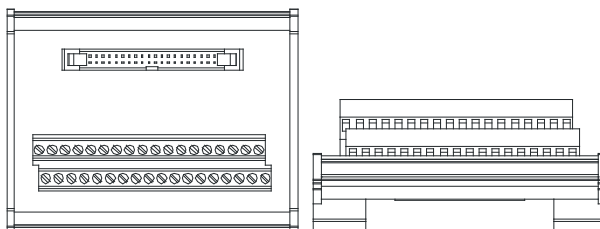

AS series terminals:

Upper row	Y0.0	Y0.2	Y0.4	Y0.6	Y0.8	Y0.10	Y0.12	Y0.14	Y1.0	Y1.2	Y1.4	Y1.6	Y1.8	Y1.10	Y1.12	Y1.14	•	•
Lower row	Y0.1	Y0.3	Y0.5	Y0.7	Y0.9	Y0.11	Y0.13	Y0.15	Y1.1	Y1.3	Y1.5	Y1.7	Y1.9	Y1.11	Y1.13	Y1.15	C0	C0

◆ UB-10-OR16A

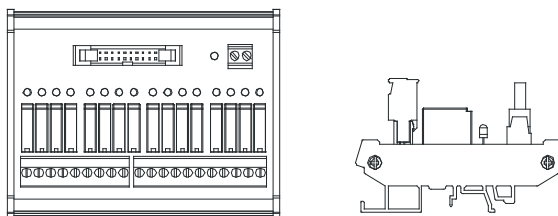

Terminals:

																			GND	+24V
C0	Y0	Y1	Y2	Y3	C1	Y4	Y5	Y6	Y7	C2	Y10	Y11	Y12	Y13	C3	Y14	Y15	Y16	Y17	

AS series terminals:

																				GND	+24V
C0	Y0.0	Y0.1	Y0.2	Y0.3	C1	Y0.4	Y0.5	Y0.6	Y0.7	C2	Y0.8	Y0.9	Y0.10	Y0.11	C3	Y0.12	Y0.13	Y0.14	Y0.15		

3. AS32AM10N-A/AS32AN02T-A and the wiring modules:

◆ UB-10-IO32D

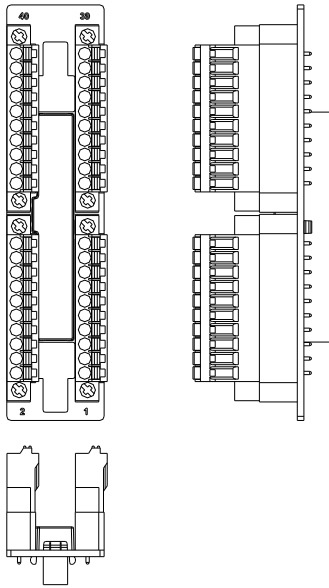

2

Chapter 3 Analog Input Module

AS04/08AD

Table of Contents

3.1 Overview	3-2
3.1.1 Characteristics	3-2
3.2 Specifications and Functions	3-3
3.2.1 Specifications	3-3
3.2.2 Profile	3-5
3.2.3 Arrangement of Terminals	3-6
3.2.4 AS04AD Control Register	3-6
3.2.5 AS08AD Control Registers	3-11
3.2.6 Functions	3-17
3.2.7 Wiring	3-20
3.2.8 LED Indicators	3-24
3.3 HWCONFIG in ISPSoft	3-24
3.3.1 Initial Setting	3-24
3.3.2 Checking the Version of a Module	3-27
3.3.3 Online Mode	3-28
3.3.4 Importing/Exporting a Parameter File.....	3-29
3.3.5 Parameters	3-30
3.4 DIADesigner-AX (Hardware Configuration)	3-34
3.4.1 Initial Setting	3-34
3.4.2 Checking the Version of a Module	3-37
3.4.3 Online Mode	3-38
3.4.4 Parameters	3-39
3.5 Troubleshooting	3-41
3.5.1 Error Codes	3-41
3.5.2 Troubleshooting Procedure	3-42

3.1 Overview

This chapter describes the specifications for analog-to-digital modules, their operation, and their programming. In this chapter, "module" refers to the analog-to-digital modules AS04AD-A, AS08AD-B, and AS08AD-C. For software operation, ISPSOft, DIADesigner or DIADesigner-AX is what you need. If you are using AS Series PLC CPU, refer to ISPSOft User Manual or DIADesigner Manual for more information. The new software DIADesigner-AX only supports AX Series PLC CPU and AS Series modules now, refer to AX-3 User Manual for more information on software operation.

3.1.1 Characteristics

(1) **Select a module based on its practical application.**

AS04AD-A: Has four channels. A channel can receive either voltage or current input.

AS08AD-B: Has eight channels. A channel can receive voltage input.

AS08AD-C: Has eight channels. A channel can receive current input.

(2) **High-speed conversion**

Analog signals are converted to digital signals at a rate of 2 ms per channel. (FW V1.02 or later: 1 ms/channel)

(3) **High accuracy**

Conversion accuracy: The error range for both voltage input and current input is $\pm 0.2\%$ at ambient temperature of 25° C. The number of voltage/current inputs that are averaged is 100.

(4) **Use the utility software to configure the module.**

The HWCONFIG utility software is built into ISPSOft. You can set modes and parameters directly in HWCONFIG of ISPSOft or Hardware Configuration of DIADesigner without spending time writing programs to set registers to manage functions.

(5) **Built-in moving average and proportional filter function.**

3.2 Specifications and Functions

3.2.1 Specifications

- Electrical specifications

Module Name	AS04AD-A	AS08AD-B	AS08AD-C
Number of Inputs	4	8	8
Analog-to-Digital Conversion	Voltage input/Current input	Voltage input	Current input
Supply Voltage	24 VDC (20.4 VDC–28.8 VDC) (-15% to +20%)		
Connector Type	Removable terminal block		
Conversion Time	2 ms/channel (FW V1.02 or later: 1 ms/channel)		
Isolation	<p>An analog circuit is isolated from a digital circuit by a digital integrated circuit/optocoupler, but the analog channels are not isolated from one another.</p> <p>Isolation between a digital circuit and a ground: 500 VAC</p> <p>Isolation between an analog circuit and a ground: 500 VAC</p> <p>Isolation between an analog circuit and a digital circuit: 500 VC</p> <p>Isolation between the 24 VDC and a ground: 500 VAC</p>		
Weight	145g		

- Functional specifications

Analog-to-Digital Conversion	Voltage Input				
Rated Input Range	-10 V ~ +10 V	0 V ~ 10 V	±5 V	0 V ~ 5 V	1 V ~ 5 V
Rated Conversion Range	K-32000 ~ K32000	K0 ~ K32000	K-32000 ~ K32000	K0 ~ K32000	K0 ~ K32000
Hardware Input Limit*1	-10.12V ~ 10.12V	-0.12V ~ 10.12V	-5.06V ~ 5.06V	-0.06V ~ 5.06V	0.95V ~ 5.05V
Conversion Limit*2	K-32384 ~ K32384	K-384 ~ K32384	K-32384 ~ K32384	K-384 ~ K32384	K-384 ~ K32384
Error Rate	Room Temperature: ±0.2% ; Full Temperature Range: ±0.5%				
Hardware Resolution	16 bits				
Input Impedance	2MΩ				
Absolute Input Range*3	±15 V				

*1: If the input signal exceeds the hardware input limit, the module only shows the maximum value. If the input signal is below the lower limit, it only shows the minimum value.

*2: If the input signal exceeds the hardware input limit, it also exceeds the digital conversion limit and a conversion limit error appears. For example in the voltage input mode (-10 V to +10 V), when the input signal is 10.15 V, exceeding the hardware upper limit, it also exceeds the conversion upper limit. The module uses the upper limit value (32387) as the input signal and a conversion limit error appears.

*3: If an input signal exceeds the absolute range, it might damage the channel.

Analog-to-Digital Conversion	Current Input		
	Rated Input Range	±20 mA	0 mA–20 mA
Rated Conversion Range	K-32000 ~ K+2000	K0 ~ K32000	K0 ~ K32000
Hardware Input Limit*1	-20.24 mA ~ 20.24 mA	-0.24 mA ~ 20.24 mA	3.81 mA ~ 20.19 mA
Conversion Limit*2	K-32384 ~ K32384	K-384 ~ K32384	K-384 ~ K32384
Error Rate	Room Temperature: ±0.2% ; Full Temperature Range: ±0.5%		
Hardware Resolution	16 bits		
Input Impedance	250Ω		
Absolute Input Range*3	±32 mA		

*1: If the input signal exceeds the hardware input limit, the module only shows the maximum value. If the input signal is below the lower limit, it only shows the minimum value.

*2: If the input signal exceeds the hardware input limit, it also exceeds the digital conversion limit and a conversion limit error appears. For example in the voltage input mode (4 mA to 20 mA), when the input signal is 0 mA, exceeding the hardware upper limit, it also exceeds the conversion upper limit. The module uses the upper limit value (-384) as the input signal and a conversion limit error appears.

*3: If an input signal exceeds the absolute range, it might damage the channel.

3.2.2 Profile

- AS04AD-A

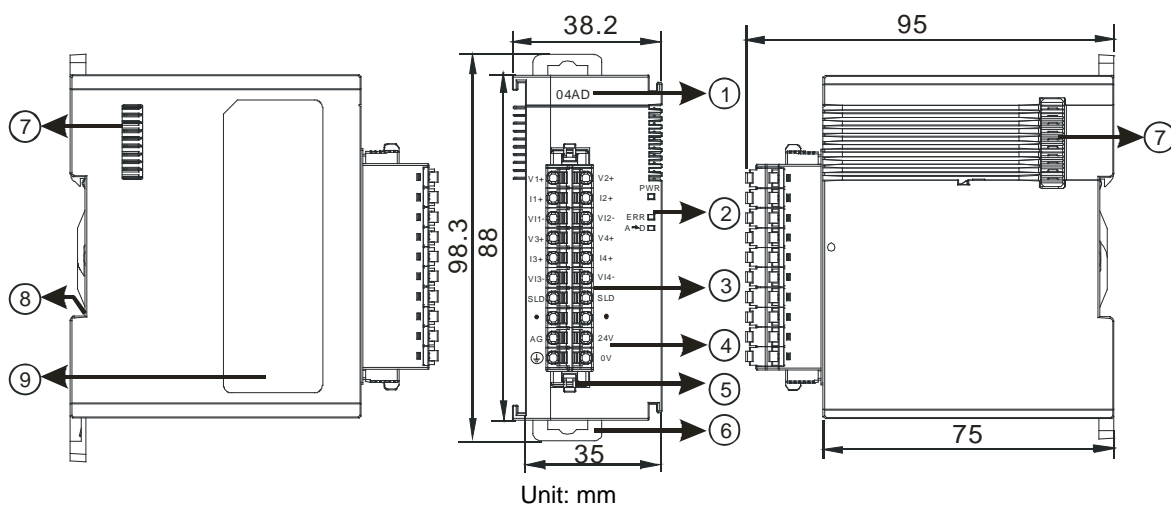

Number	Name	Description
1	Model Name	Model name of the module
2	POWER LED Indicator	Status of the power supply ON: the power is on. OFF: the power is off.
	ERROR LED Indicator	Error status of the module ON: a serious error exists in the module. OFF: the module is operating normally. Blinking: A minor error exists in the module.
	Analog to Digital Conversion Indicator	Analog-to-digital conversion status Blinking: conversion is in process. OFF: conversion has stopped.
3	Removable Terminal Block	Inputs are connected to sensors. Outputs are connected to loads to be driven.
4	Arrangement of the Input/Output Terminals	Arrangement of the terminals
5	Terminal Block Clip	For removing the terminal block
6	DIN Rail Clip	Secures the module onto the DIN rail
7	Module Connecting Set	Connects the modules
8	Ground Clip	
9	Label	Nameplate

3.2.3 Arrangement of Terminals

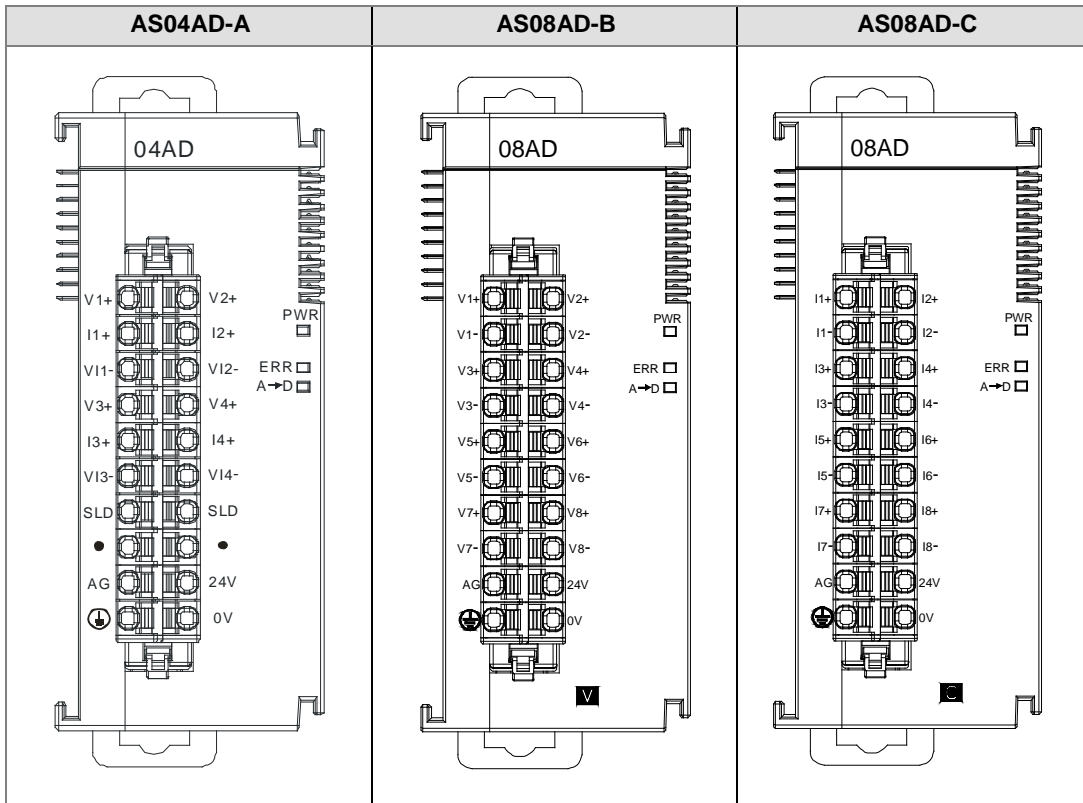

3.2.4 AS04AD Control Register

*If you use HWCONFIG to set values in CRs, once the set value is downloaded, the values can be retained in the module; however if you use TO instruction to write data into CRs, the values CANNOT be retained, after power failure or after transition of the CPU from STOP to RUN.

Note: The attribute of the CR must be W (write) to use TO instruction.

CR#	Name	Description	Atr.	Defaults
0	Format Setup	0: integer format 1: floating point format	R	0
1	Channel 1 mode setup	0: closed 1: -10 V to +10 V	R/W	1
2	Channel 2 mode setup	2: 0 V-10 V 3: -5 V to +5 V		
3	Channel 3 mode setup	4: 0 V-5 V 5: 1 V-5 V		
4	Channel 4 mode setup	6: 0 mA-20 mA 7: 4 mA-20 mA		

CR#	Name	Description	Atr.	Defaults
		8: -20 mA to +20 mA		
5	Channel 1 offset	Range: -32768 to +32767	R/W	0
6	Channel 2 offset			
7	Channel 3 offset			
8	Channel 4 offset			
9	Channel 1 gain	Range: -32768 to +32767	R/W	1000
10	Channel 2 gain			
11	Channel 3 gain			
12	Channel 4 gain			
13	Channel 1 average times	Range: 1–100	R/W	10
14	Channel 2 average times			
15	Channel 3 average times			
16	Channel 4 average times			
17	Channel 1 filter average percentage	Range: 0–3 Unit: $\pm 10\%$ 1: $\pm 10\%$ 2: $\pm 20\%$ 3: $\pm 30\%$	R/W	1
18	Channel 2 filter average percentage			
19	Channel 3 filter average percentage			
20	Channel 4 filter average percentage			
21	Channel sampling cycle (sampling/integration time)	0: 2 ms 1: 4 ms 2: 10 ms 3: 15 ms 4: 20 ms 5: 30 ms	R/W	0

CR#	Name	Description	Atr.	Defaults
		6: 40 ms 7: 50 ms 8: 60 ms 9: 70 ms 10: 80 ms 11: 90 ms 12: 100 ms		
22	Channel Alarm Setup	0: open channel alarm 1: close channel alarm bit0: channel 1 bit1: channel 2 bit2: channel 3 bit3: channel 4 0: warning 1: alarm bit8: error in the power supply bit9: error in the module hardware bit10: error in calibration	R/W	0
23	The minimum scale range for channel 1	When the format is set to integer in HWCONFIG, the scale range is invalid. For analog-digital modules, it is much more convenient if the system can convert digital values to floating-point values for earlier understanding. Here you can set the minimum and maximum scale ranges of corresponding floating-point values for channels. For example, if the scale range for an analog to digital input channel is ± 10.0 V, it indicates the maximum value is +10.0 V and the minimum value is -10.0 V. If the scale range for an analog to digital input channel is 4 mA ~ 20 mA. It indicates the maximum	R	-10.0
24				
25	The minimum scale range for channel 2			-10.0
26				
27	The minimum scale range for channel 3			-10.0
28				
29	The minimum scale range for channel 4			-10.0
30				
31	The maximum scale range for channel 1			10.0
32				
33	The maximum scale range for channel 2	10.0		
34				
35	The maximum scale range for channel 3	10.0		
36				

CR#	Name	Description	Atr.	Defaults
37	The maximum scale range for channel 4	value is 20 mA and the minimum value is 4 mA.		10.0
38		Note: You can use PLC instruction DSCLP (API0217) and set SM685 to ON to use floating-point operations when a conversion range needs to edit.		
201	Instruction Set	<p>Instructions for peak values</p> <p>16#0101: record the peak value again for channel 1</p> <p>16#0102: record the peak value again for channel 2</p> <p>16#0104: record the peak value again for channel 3</p> <p>16#0108: record the peak value again for channel 4</p> <p>16#010F: record the peak values again for channels 1–4</p> <p>16#0201: enable recording for channel 1</p> <p>16#0202: enable recording for channel 2</p> <p>16#0204: enable recording for channel 3</p> <p>16#0208: enable recording for channel 4</p> <p>16#020F: enable recording for channels 1–4</p> <p>16#0211: disable recording for channel 1</p> <p>16#0212: disable recording for channel 2</p> <p>16#0214: disable recording for channel 3</p> <p>16#0218: disable recording for channel 4</p> <p>16#021F: disable recording for channels 1–4</p> <p>16#0502: restore default settings</p>	W	0
210	The maximum peak value for channel 1	Integer format; the maximum peak value for analog inputs	R	0
211	The maximum peak value for channel 2			0
212	The maximum peak value for channel 3			0
213	The maximum peak value for channel 4			0

CR#	Name	Description	Atr.	Defaults
214	The minimum peak value for channel 1	Integer format; the minimum peak value for analog inputs	R	0
215	The minimum peak value for channel 2			0
216	The minimum peak value for channel 3			0
217	The minimum peak value for channel 4			0
222	The time to record for channel 1	Unit: 10 ms Range: 1–100 Time to record the digital value for the channel	R/W	1
223	The time to record for channel 2			1
224	The time to record for channel 3			1
225	The time to record for channel 4			1
240	The number of records for channel 1	Range: 0–500, display the current records	R	0
241	The number of records for channel 2			0
242	The number of records for channel 3			0
243	The number of records for channel 4			0
4000~4499	Records for channel 1	500 records for channel 1	R	--
4500~4999	Records for channel 2	500 records for channel 2	R	--
5000~5499	Records for channel 3	500 records for channel 3	R	--
5500~5999	Records for channel 4	500 records for channel 4	R	--

3.2.5 AS08AD Control Registers

*If you use HWCONFIG to set values in CRs, once the set value is downloaded, the values can be retained in the module; however if you use TO instruction to write data into CRs, the values CANNOT be retained, after power failure or after transition of the CPU from STOP to RUN.

Note: The attribute of the CR must be W (write) to use TO instruction.

CR#	Name	Description	Atr.	Defaults
0	Format Setup	0: integer format 1: floating point format	R	0
1	Channel 1 mode setup	AS08AD-B 0: closed 1: -10 V to +10 V 2: 0 V–10 V 3: -5 V to +5 V 4: 0 V–5 V 5: 1 V–5 V	R/W	1
2	Channel 2 mode setup			
3	Channel 3 mode setup			
4	Channel 4 mode setup			
5	Channel 5 mode setup			
6	Channel 6 mode setup			
7	Channel 7 mode setup			
8	Channel 8 mode setup			
9	Channel 1 offset	AS08AD-C 0: closed 1: -20 mA to +20 mA 2: 0 mA–20 mA 3: 4 mA–20 mA	R/W	0
10	Channel 2 offset			
11	Channel 3 offset			
12	Channel 4 offset			
13	Channel 5 offset			
14	Channel 6 offset			
15	Channel 7 offset			
16	Channel 8 offset			

CR#	Name	Description	Atr.	Defaults
17	Channel 1 gain	Range: -32768 to +32767	R/W	1000
18	Channel 2 gain			
19	Channel 3 gain			
20	Channel 4 gain			
21	Channel 5 gain			
22	Channel 6 gain			
23	Channel 7 gain			
24	Channel 8 gain			
25	Channel 1 average times	Range: 1–100	R/W	10
26	Channel 2 average times			
27	Channel 3 average times			
28	Channel 4 average times			
29	Channel 5 average times			
30	Channel 6 average times			
31	Channel 7 average times			
32	Channel 8 average times			
33	Channel 1 filter average percentage	Range: 0–3 Unit: $\pm 10\%$ 1: $\pm 10\%$ 2: $\pm 20\%$ 3: $\pm 30\%$	R/W	1
34	Channel 2 filter average percentage			
35	Channel 3 filter average percentage			
36	Channel 4 filter average percentage			
37	Channel 5 filter average percentage			
38	Channel 6 filter average percentage			
39	Channel 7 filter average percentage			
40	Channel 8 filter average			

CR#	Name	Description	Atr.	Defaults
	percentage			
41	Channel Sampling Cycle (Sampling/Integration Time)	0: 2 ms 1: 4 ms 2: 10 ms 3: 15 ms 4: 20 ms 5: 30 ms 6: 40 ms 7: 50 ms 8: 60 ms 9: 70 ms 10: 80 ms 11: 90 ms 12: 100 ms	R/W	0
42	Channel Alarm Setup	0: open channel alarm 1: close channel alarm bit0: channel 1 bit1: channel 2 bit2: channel 3 bit3: channel 4 bit4: channel 5 bit5: channel 6 bit6: channel 7 bit7: channel 8 0: warning 1: alarm bit8: error in the power supply bit9: error in the module hardware bit10: error in calibration	R/W	0
43	The minimum scale range	When the format is set to integer in HWCONFIG, the scale range is invalid. For analog-digital modules, it is much more	R	-10.0
44	for channel 1			
45	The minimum scale range			

CR#	Name	Description	Atr.	Defaults		
46	for channel 2	<p>convenient if the system can convert digital values to floating-point values for earlier understanding. Here you can set the minimum and maximum scale ranges of corresponding floating-point values for channels.</p> <p>For example, if the scale range for an analog to digital input channel is ± 10.0 V, it indicates the maximum value is +10.0 V and the minimum value is -10.0 V.</p> <p>If the scale range for an analog to digital input channel is 4 mA ~ 20 mA. It indicates the maximum value is 20 mA and the minimum value is 4 mA.</p> <p>Note: You can use PLC instruction DSCLP (API0217) and set SM685 to ON to use floating-point operations when a conversion range needs to edit.</p>				
47	The minimum scale range					
48	for channel 3					
49	The minimum scale range					
50	for channel 4					
51	The minimum scale range					
52	for channel 5					
53	The minimum scale range					
54	for channel 6					
55	The minimum scale range					
56	for channel 7					
57	The minimum scale range					
58	for channel 8					
59	The maximum scale range				<p>R</p> <p>10.0</p>	<p>10.0</p>
60	for channel 1					
61	The maximum scale range					
62	for channel 2					
63	The maximum scale range					
64	for channel 3					
65	The maximum scale range					
66	for channel 4					
67	The maximum scale range					
68	for channel 5					
69	The maximum scale range					
70	for channel 6					
71	The maximum scale range					
72	for channel 7					
73	The maximum scale range					
74	for channel 8					

3

CR#	Name	Description	Atr.	Defaults
201	Instruction Set	Instructions for peak values 16#0101: record the peak value again for channel 1 16#0102: record the peak value again for channel 2 16#0104: record the peak value again for channel 3 16#0108: record the peak value again for channel 4 16#010F: record the peak values again for channels 1-4 16#0201: enable recording for channel 1 16#0202: enable recording for channel 2 16#0204: enable recording for channel 3 16#0208: enable recording for channel 4 16#020F: enable recording for channels 1–4 16#0211: disable recording for channel 1 16#0212: disable recording for channel 2 16#0214: disable recording for channel 3 16#0218: disable recording for channel 4 16#021F: disable recording for channels 1–4 16#0502: restore default settings	W	0
210	The maximum peak value for channel 1	Integer format; the maximum peak value for analog inputs	R	0
211	The maximum peak value for channel 2			0
212	The maximum peak value for channel 3			0
213	The maximum peak value for channel 4			0
214	The maximum peak value for channel 5			0
215	The maximum peak value for channel 6			0

CR#	Name	Description	Atr.	Defaults
216	The maximum peak value for channel 7			0
217	The maximum peak value for channel 8			0
218	The minimum peak value for channel 1	Integer format; the minimum peak value for analog inputs	R	0
219	The minimum peak value for channel 2			0
220	The minimum peak value for channel 3			0
221	The minimum peak value for channel 4			0
222	The minimum peak value for channel 5			0
223	The minimum peak value for channel 6			0
224	The minimum peak value for channel 7			0
225	The minimum peak value for channel 8			0
222	The time to record for channel 1			Unit: 10 ms Range: 1–100 Time to record the digital value for the channels
223	The time to record for channel 2	1		
224	The time to record for channel 3	1		
225	The time to record for channel 4	1		

3

3.2.6 Functions

Item	Function	Description
1	Enable/Disable a Channel	1. Enable or disable a channel. 2. If a channel is disabled, the total conversion time decreases.
2	Calibration	Calibrate a linear curve.
3	Average	Conversion values are averaged and filtered.
4	Disconnection Detection	Disconnection detection only operates when the analog range is 4 mA–20 mA or 1 V–5 V.
5	Channel Detect and Alarm	If an input signal exceeds the range of inputs that the hardware can receive, the module produces an alarm or a warning. You can disable this function.
6	The Limit Detections for Channels	Save the maximum/minimum values for channels.
7	Records for Channels (Applicable for AS04AD)	Save the analog curves for channels
8	Scale Range	When the format is floating-point, you can set the scale range.

1. Enable/Disable a channel

An analog signal is converted into a digital signal at a rate of 2 ms per channel. The total conversion time is 2 ms X (the number of channels). For firmware V1.02 or later, an analog signal is converted into a digital signal at a rate of 1 ms per channel. The total conversion time is 1 ms X (the number of channels). If a channel is not used, you can disable it to decrease the total conversion time.

2. Calibration

To make a curve meet specific needs, calibrate the curve by changing the offset and the gain. The calibration range depends on the range of inputs that the hardware can receive. The formula is:

$$Output = \frac{(Input \times Gain)}{1000} + Offset$$

Example:

A channel receives voltage inputs between -10.0 V to +10.0 V. The gain is 1000, and the offset is 0. The corresponding value for the original signal -10.0 V to +10.0 V is -32000 to +32000. If you change the offset to -100, the calibrated value for the original signal -10.0 V to +10.0 V becomes -31900 to +32100.

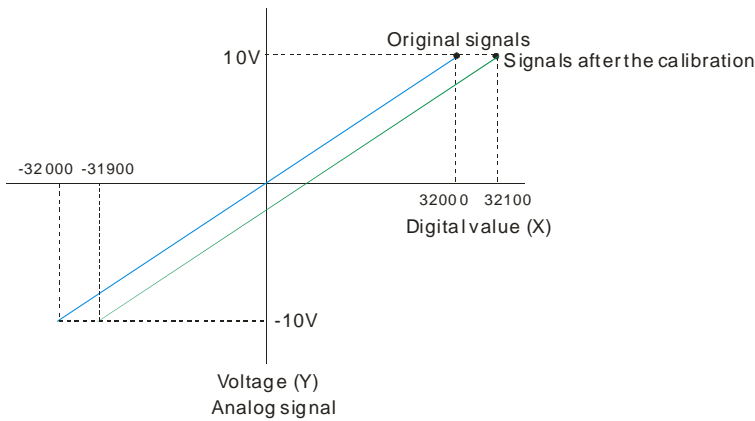

3

3. Average

This function is achieved by moving average. You can set the average times can be set between 1–100. It is a steady value obtained from the sum of the recorded values. If the recorded values include an acute pulse due to unavoidable external factors, however, you may observe violent changes in the average value. Use the filtering function to exclude acute pulses from the sum-up and equalization, so that the computed average value is not affected by the acute recorded values. Set the filter percentage to the range 0–3, where the unit is 10%. If you set the filter range to 0, the system sums up all the recorded values and divides them to obtain the average value, but if you set the filter range to 1, for example, the system excludes the bottom 10% and top 10% of the values and averages only the remaining values to obtain the average value. For instance, set the average value to 100 and set the filter percentage to 3. When there are 100 pieces of data collected, the system arranges the collected data according to their values from large to small and then excludes the bottom 30% and top 30% of the values (60 pieces of data) and averages only the remaining values (40 pieces of data) to obtain the average value.

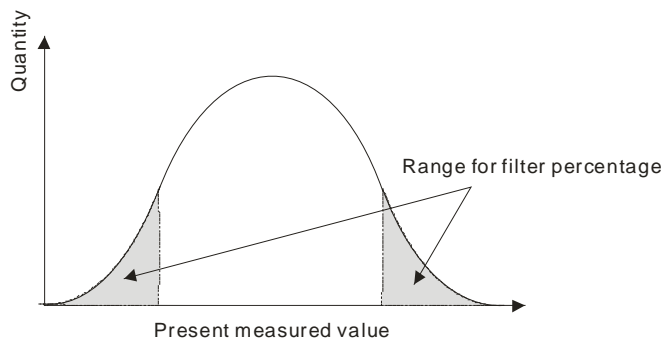

4. Disconnection detection

Disconnection detection only operates when the analog range is 4–20 mA or 1–5 V. If a module that can receive inputs between 4–20 mA or from 1–5 V is disconnected, the input signal exceeds the range of allowable inputs, so the module produces an alarm or a warning.

5. Channel detection

If an input signal exceeds the allowable range of inputs, an error message appears. You can disable this function so that the module does not produce an alarm or a warning when the input signal exceeds the input range.

6. Limit detections for channels

This function saves the maximum and minimum values for channels so that you can determine the peak to peak values.

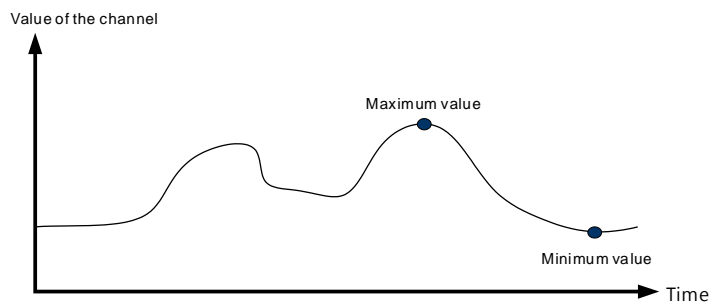

7. Records for channels (applicable for AS04AD)

Record the input values of the cyclic sampling for each channel. The system saves up to 500 data points and the recording time is 10 ms.

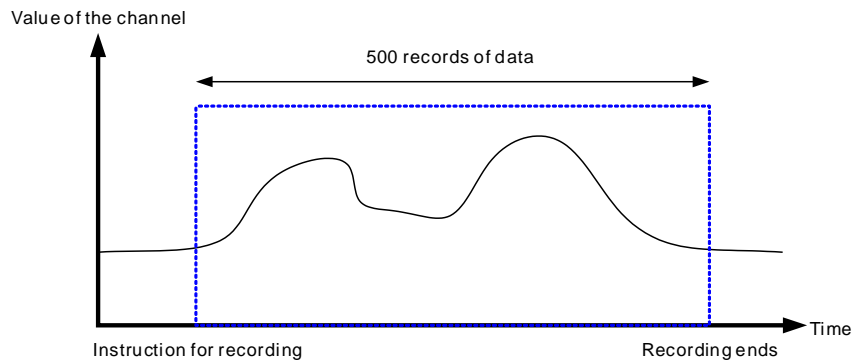

8. Scale range

You can set the scale range when the format is floating-point. The analog output mode of a channel has a corresponding digital range. Digital values correspond to analog outputs sent by the module. For example, if the analog range is -10 V to $+10\text{ V}$, the digital range is -10.0 to $+10.0$, the HSP scale is 10.0 , and the LSP scale is -10.0 . The digital values -10.0 to $+10.0$ correspond to the analog values -10 V to $+10\text{ V}$, as the example below shows.

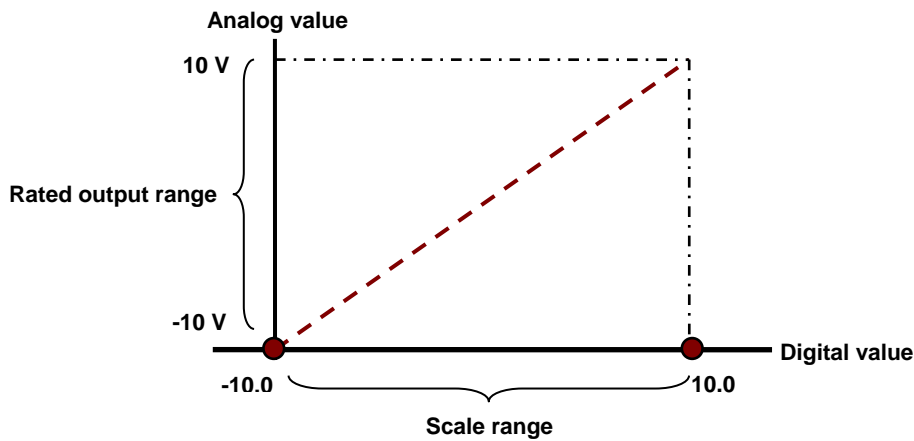

3.2.7 Wiring

- **Precautions**

To ensure the analog-to-digital module functions well and reliably, the external wiring must prevent noise. Before you install the cables, follow the precautions below.

- (1) To prevent a surge and induction, the AC cable and the input signal cables that are connected to the module must be separate cables.
- (2) Do not install the cable near a main circuit, a high-voltage cable, or a cable connected to a load that is not a PLC. In addition, the cable must not be bound to a main circuit, a high-voltage cable, or a cable connected to a load which is not a PLC.
- (3) Ground shielded cables and hermetically sealed cables separately.
- (4) Terminals with insulation sleeves cannot be arranged as a terminal block, so you should cover the terminals with insulation tubes.
- (5) Use single-core cables or twin-core cables in a diameter of 24 AWG–22 AWG with pin-type connectors smaller than 1 mm. Use only copper conducting wires that can resist temperatures above 60° C–75° C.

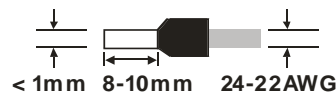

- (6) Notes on two-wire, three-wire, and four-wire connections:
 - Two-wire connection/three-wire connection (passive transducer): connect the transducer and the analog input module to the same power circuit.
 - Four-wire connection (active transducer): the transducer uses an independent power supply so do not connect it to the same power circuit as the analog input module.
- (7) Note: use cables with the same length (less than 200 m) and use wire resistance of less than 100 ohm.

● AS04AD-A External wiring

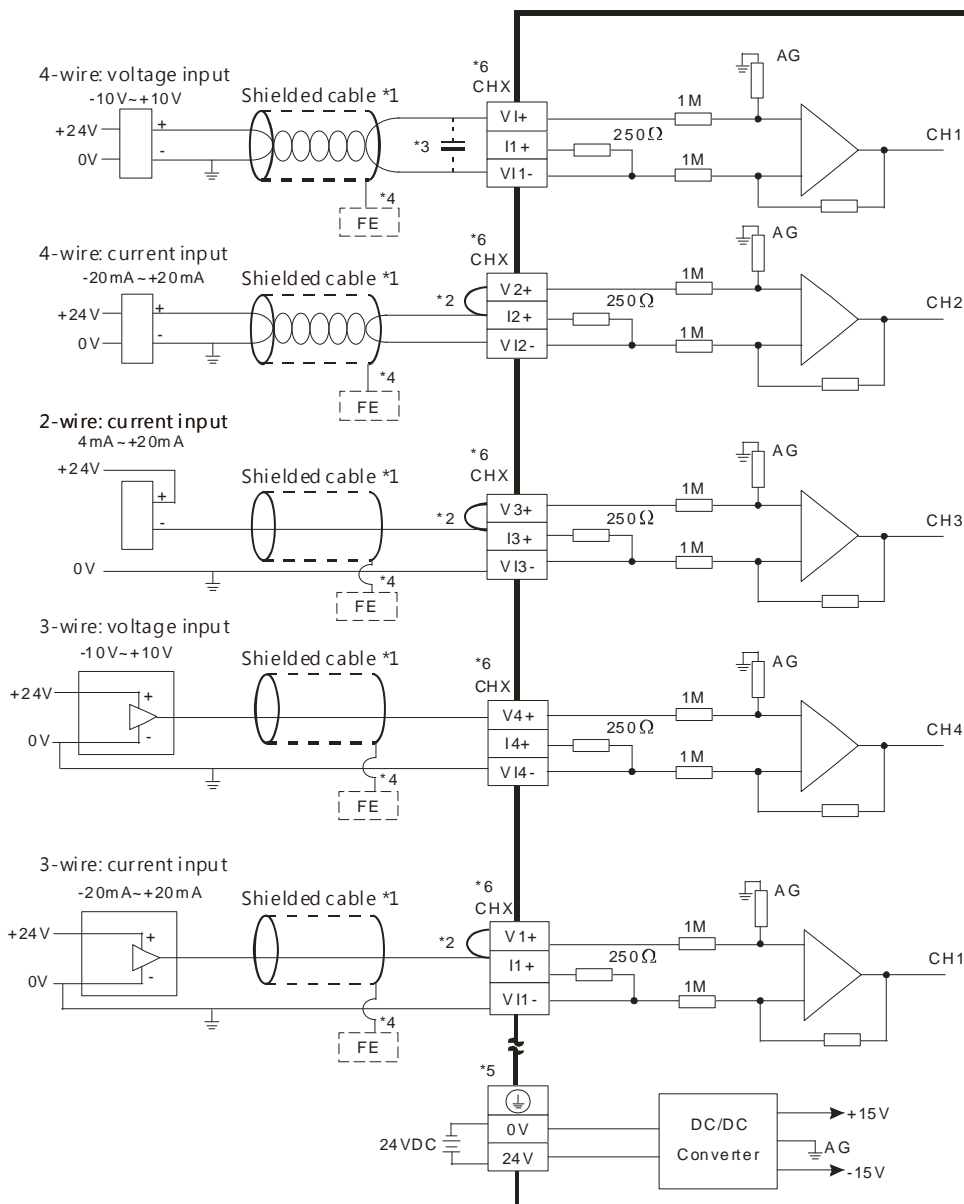

- *1. Use shielded cables to isolate the analog input signal cable from other power cables.
- *2. If the module is connected to a current signal, the terminals V_n and I_n+ ($n=1-4$) must be short-circuited.
- *3. If variability in the input voltage results in interference within the wiring, connect the module to a capacitor with a capacitance between $0.1-0.47 \mu\text{F}$ and a working voltage of 25 V.
- *4. Connect the shielded cable to the terminal FE.
- *5. Connect the terminal ⏏ to the ground terminal.
- *6. Every channel can operate with the wiring presented above.

● AS08AD-B External wiring

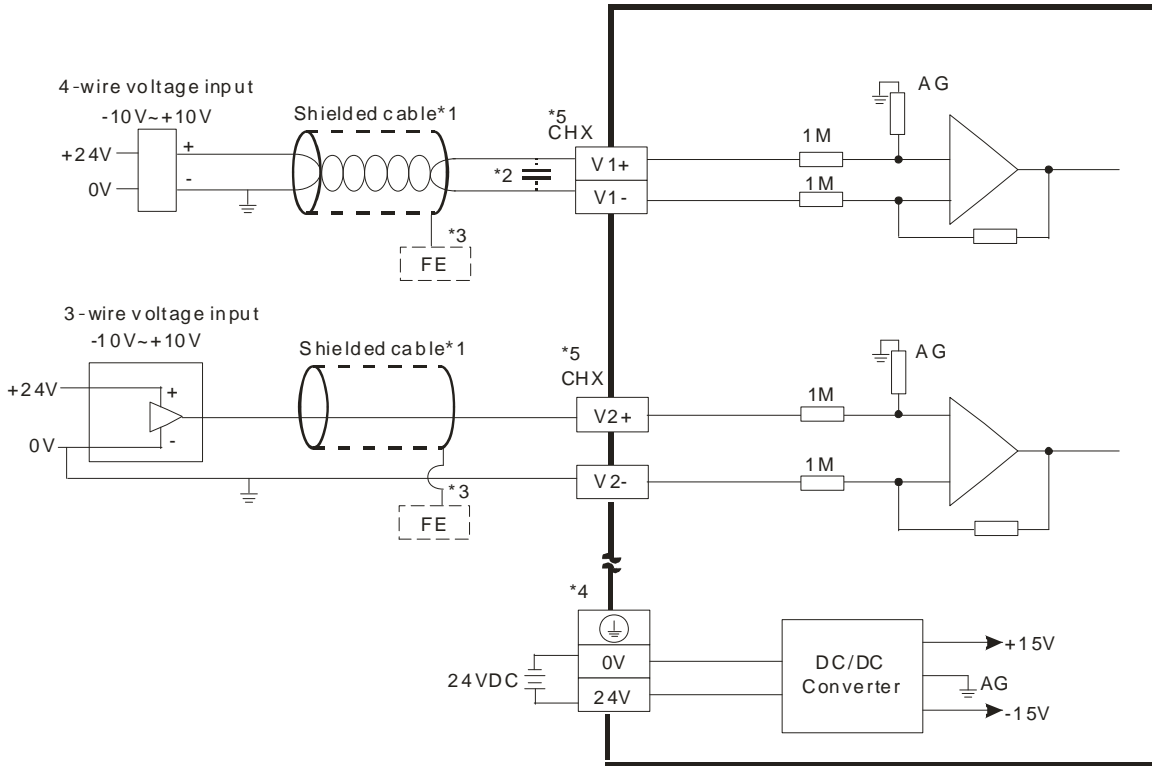

*1. Use shielded cables to isolate the analog input signal cable from other power cables.

*2. If variability in the input voltage results in interference within the wiring, connect the module to a capacitor with a capacitance between 0.1–0.47 μF and a working voltage of 25 V.

*3. Connect the shielded cable to the terminal FE.

*4. Connect the terminal ⏏ to the ground terminal.

*5. Every channel can operate with the wiring presented above.

● AS08AD-C External wiring

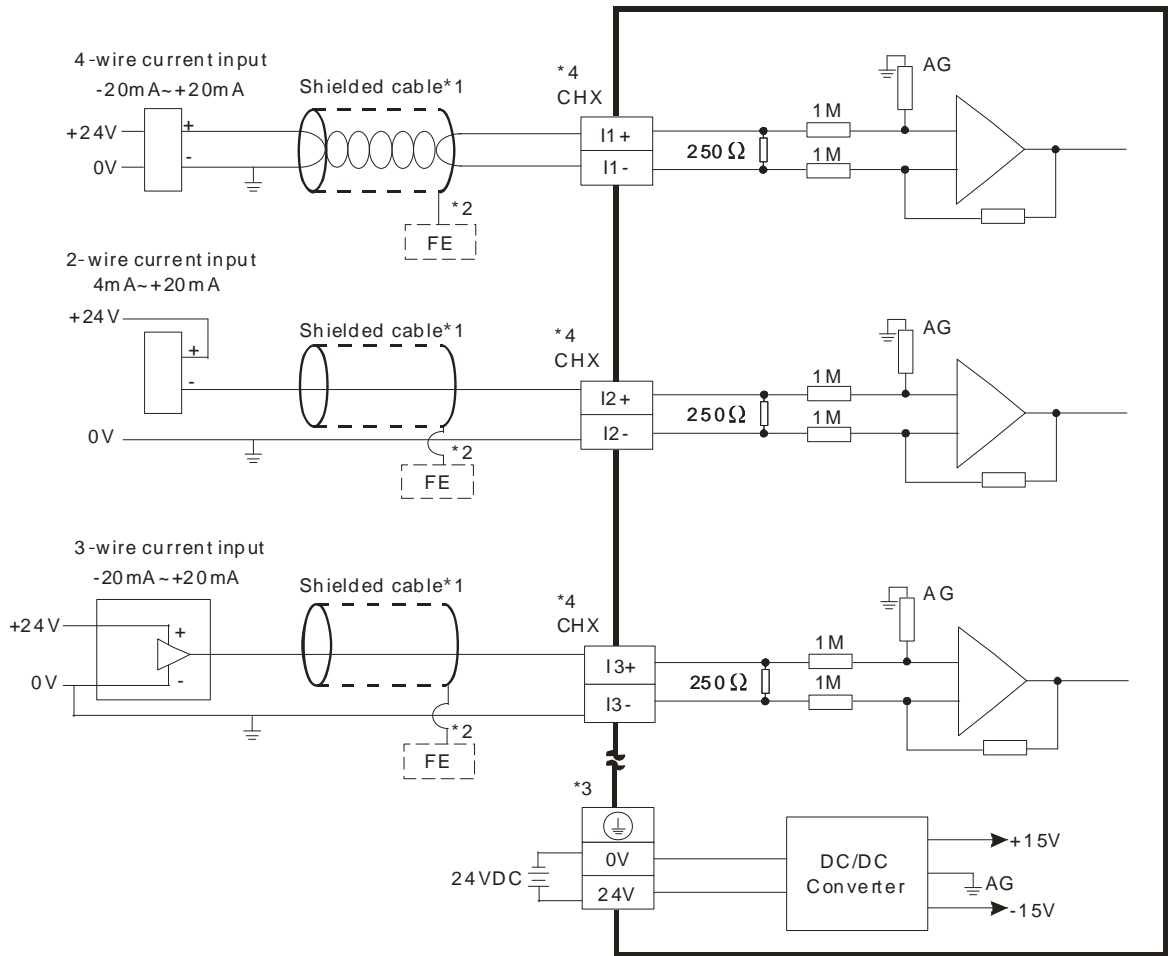

*1. Use shielded cables to isolate the analog input signal cable from other power cables.

*2. Connect the shielded cable to the terminal FE.

*3. Connect the terminal ⏏ to the ground terminal.

*4. Every channel can operate with the wiring presented above.

3.2.8 LED Indicators

Number	Name	Description
1	RUN LED Indicator	Operating status of the module ON: the module is running. OFF: the module is not running.
2	ERROR LED Indicator	Error status of the module ON: a serious error exists in the module. OFF: the module is operating normally. Blink: a minor error exists in the module.
3	Analog to Digital Conversion Indicator	Analog-to-digital conversion status Blinking: conversion is in process. OFF: conversion has stopped.

3.3 HWCONFIG in ISPSOft

The following example uses the AS04AD-A module.

3.3.1 Initial Setting

- (1) Start ISPSOft and double-click **HWCONFIG**.

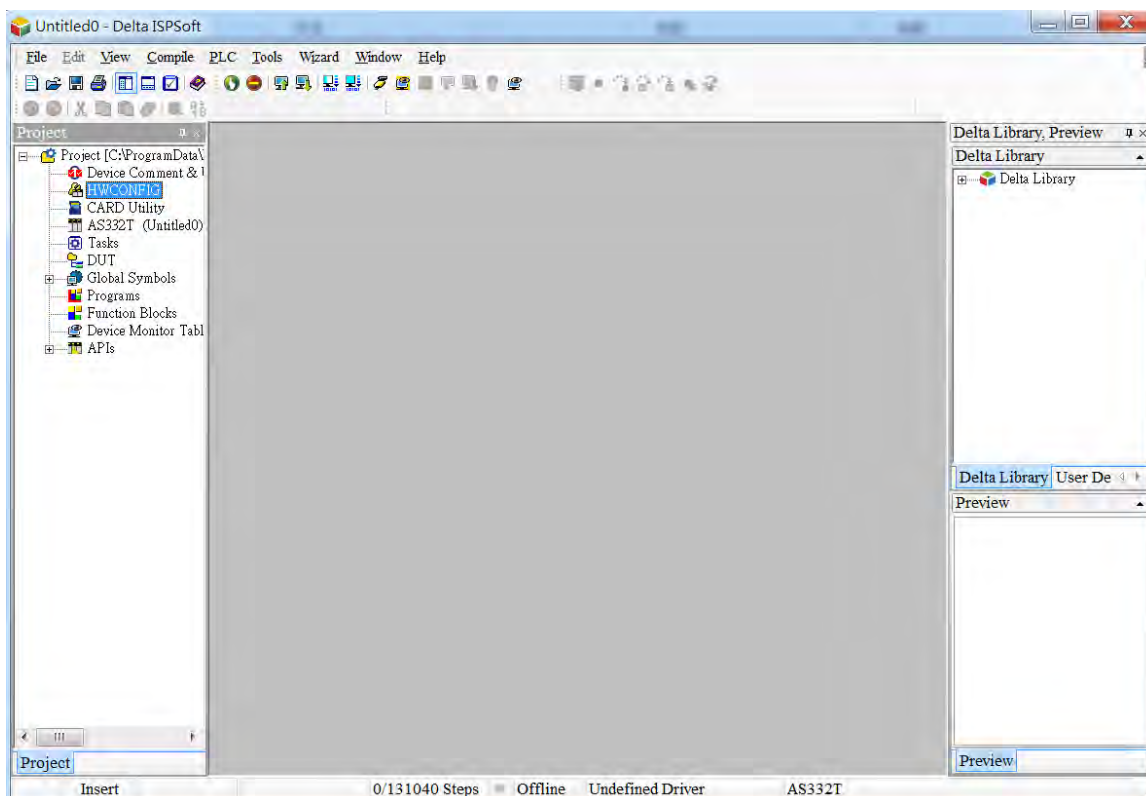

- (2) Select a module and drag it to the working area.

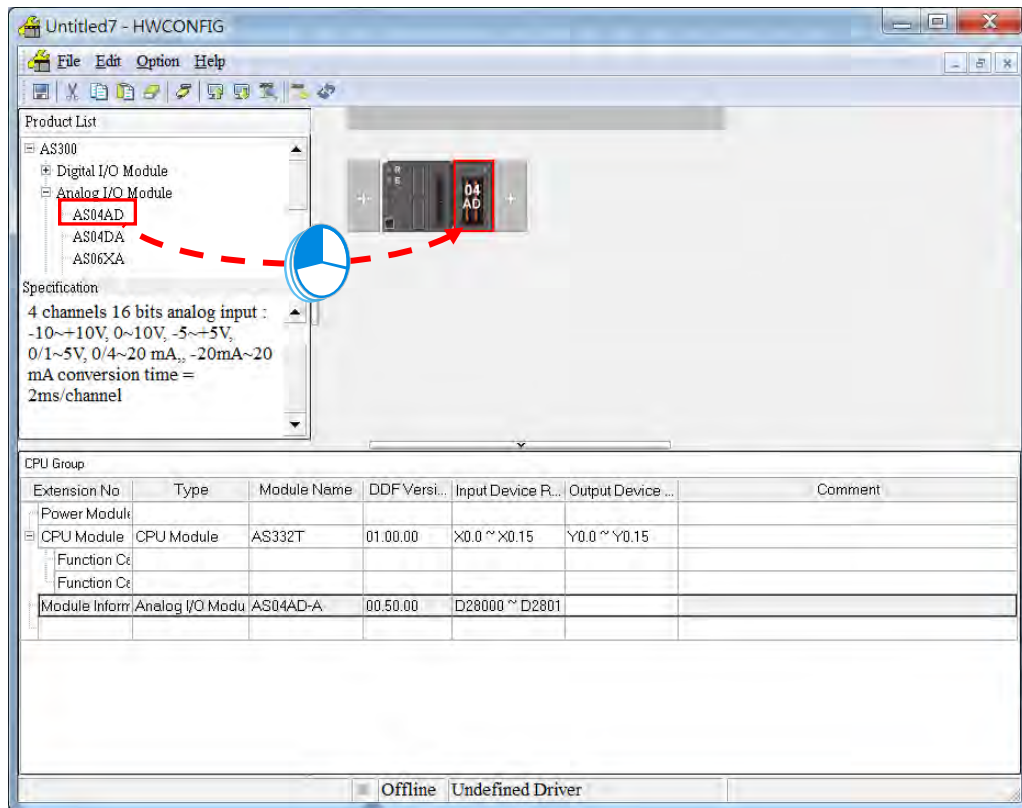

- (3) Double-click the module in the working area to open the Device Setting page.

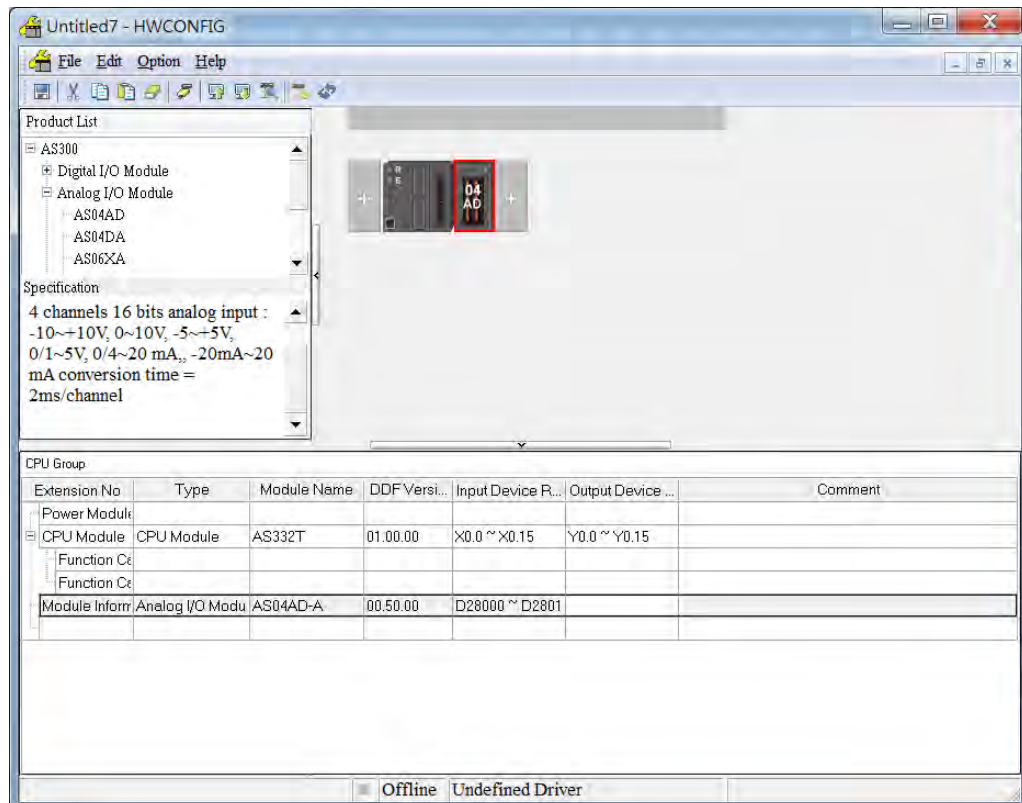

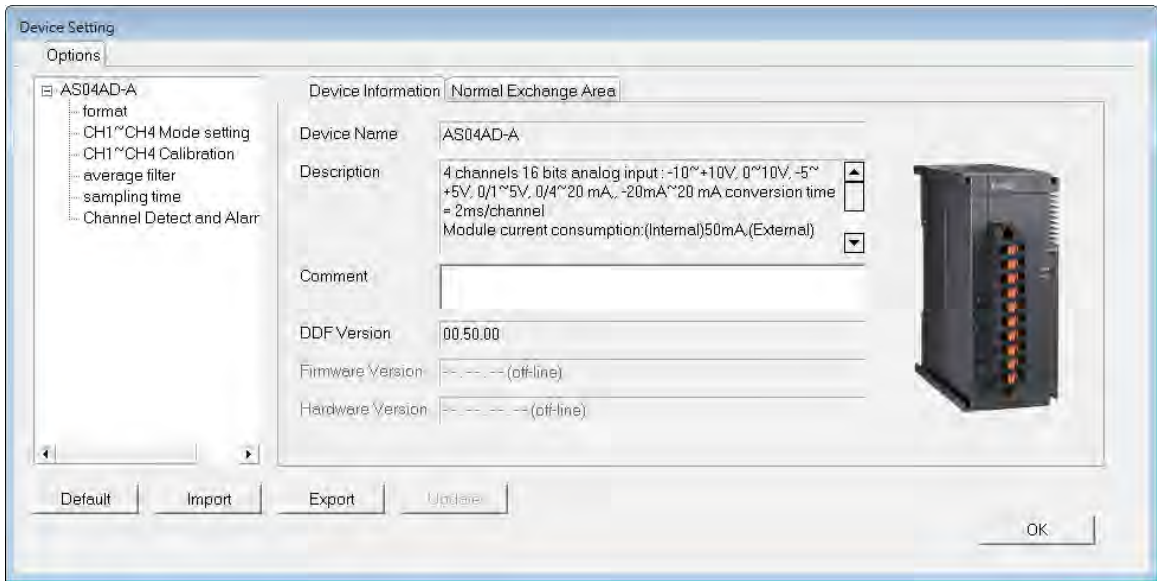

(4) Choose a parameter, set the values, and click **OK**.

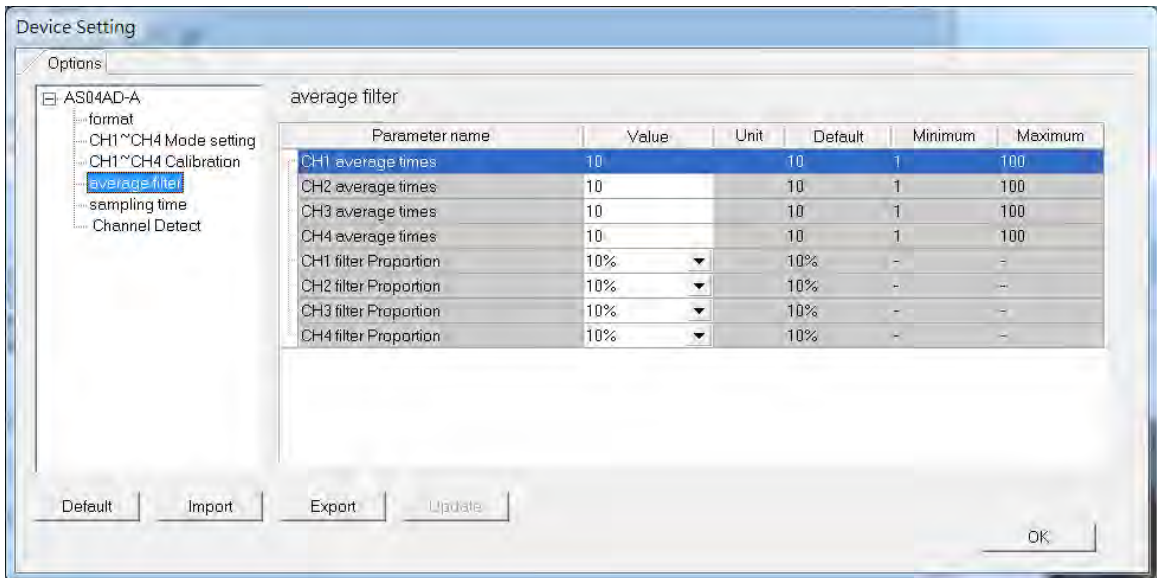

- (5) Click **Download** on the toolbar to download the parameters. Note that you cannot download the parameters while the CPU module is running.

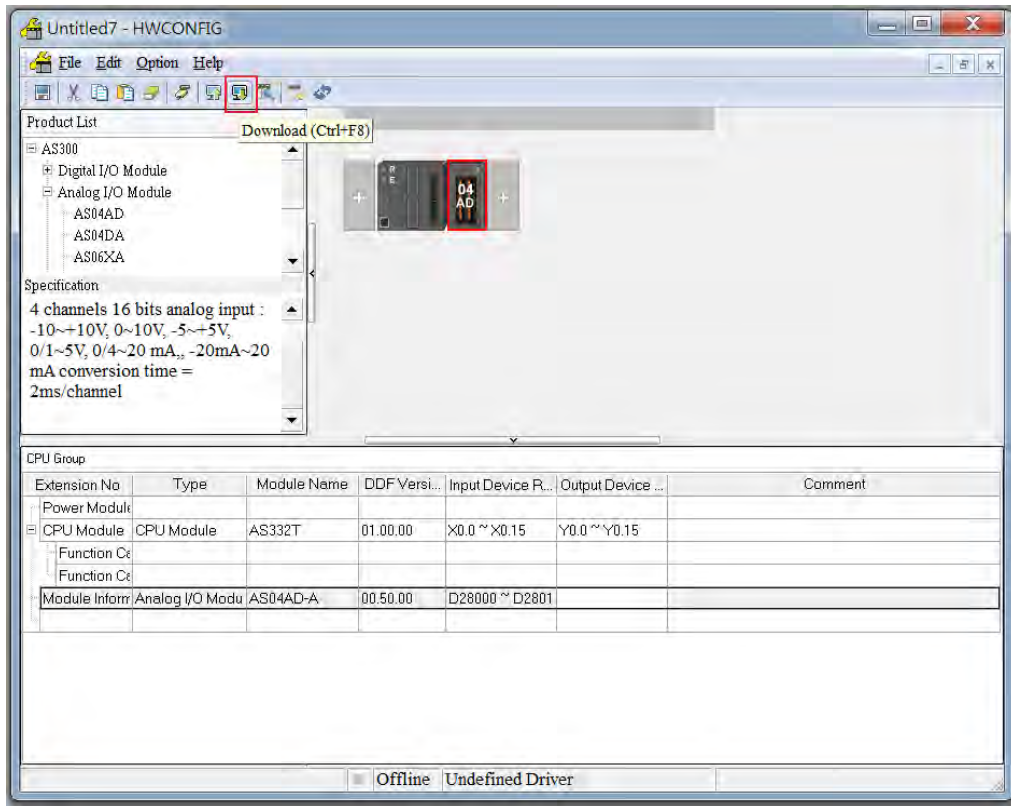

3.3.2 Checking the Version of a Module

- (1) On the **Option** menu, click **Online Mode**.

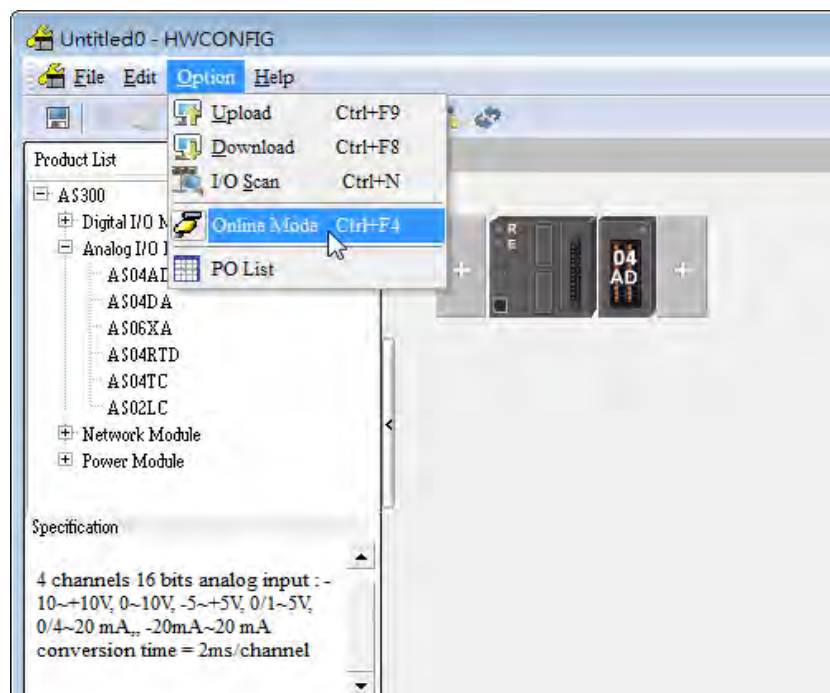

- (2) Double-click the module to open the Device Setting page. The versions of both the firmware and the hardware are displayed.

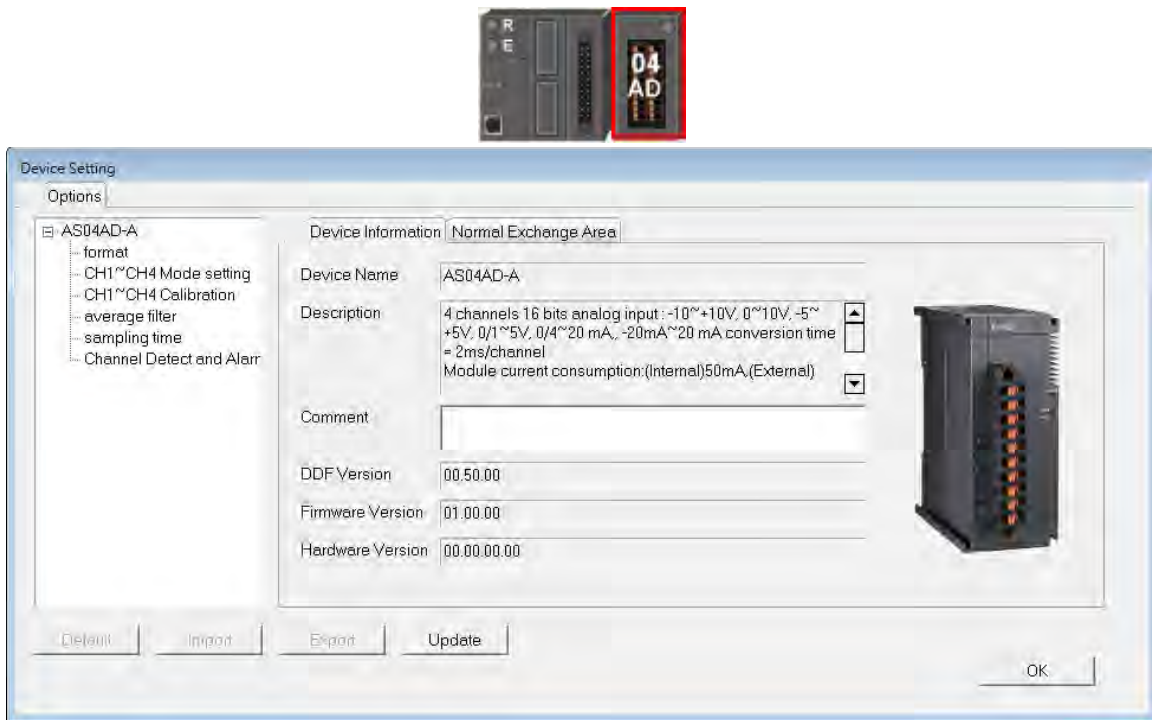

3.3.3 Online Mode

- (1) Click **Online Mode** on the toolbar.

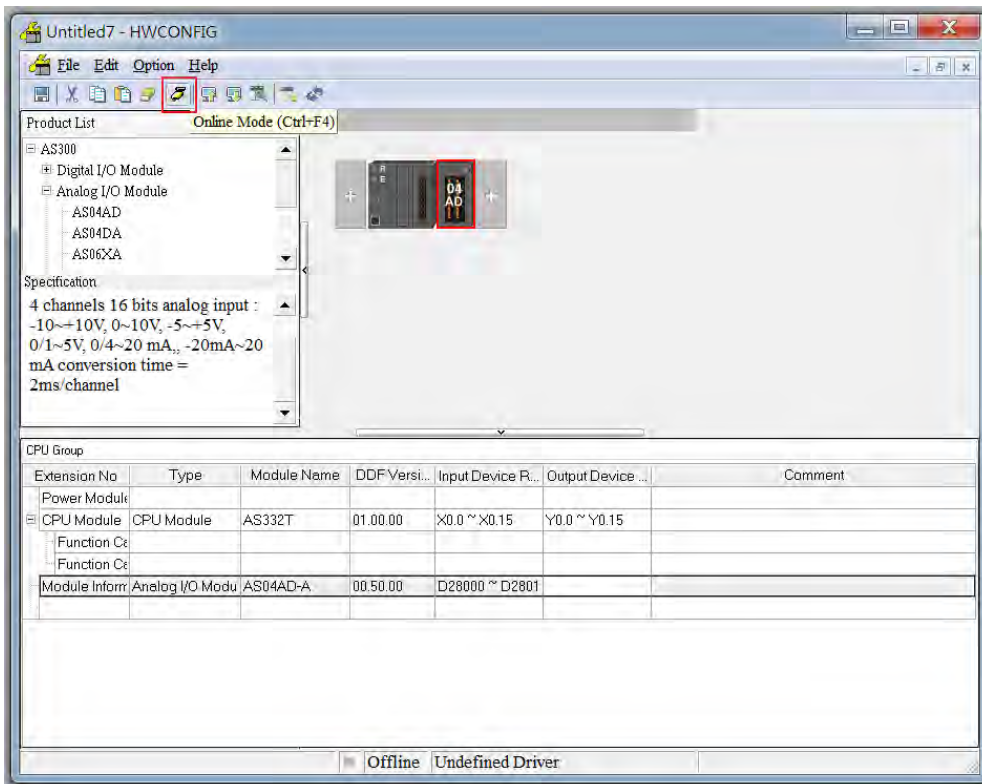

- (2) Right-click the module and click **Module Status**.

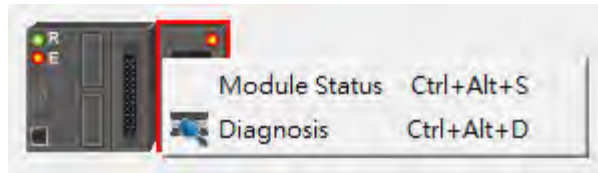

- (3) View the module status.

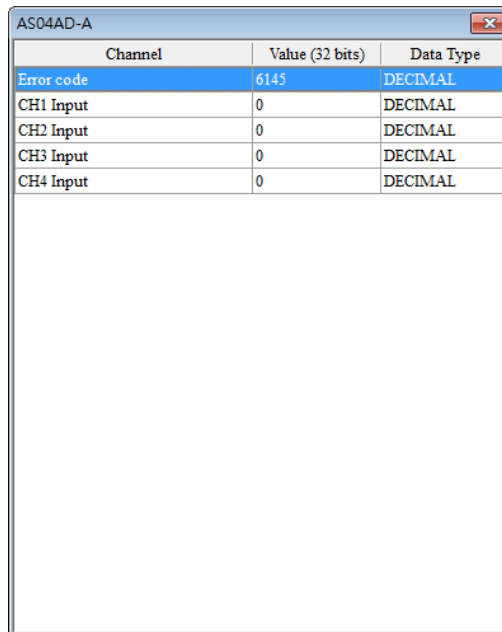

Channel	Value (32 bits)	Data Type
Error code	6145	DECIMAL
CH1 Input	0	DECIMAL
CH2 Input	0	DECIMAL
CH3 Input	0	DECIMAL
CH4 Input	0	DECIMAL

3.3.4 Importing/Exporting a Parameter File

- (1) Click **Export** in the Device Settings dialog box to save the current parameters as a CSV file (.csv).

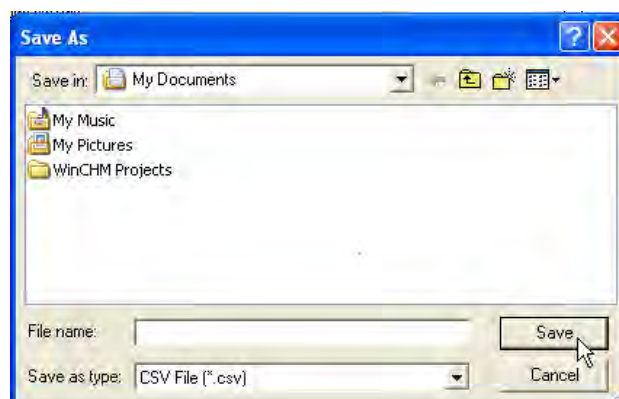
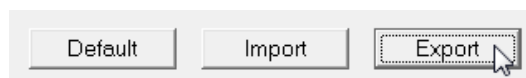



(2) Click **Import** in the Device Settings dialog box and select a CSV file to import saved parameters.

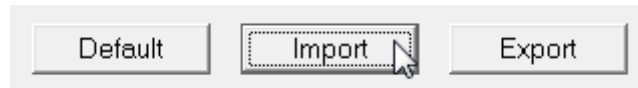

3

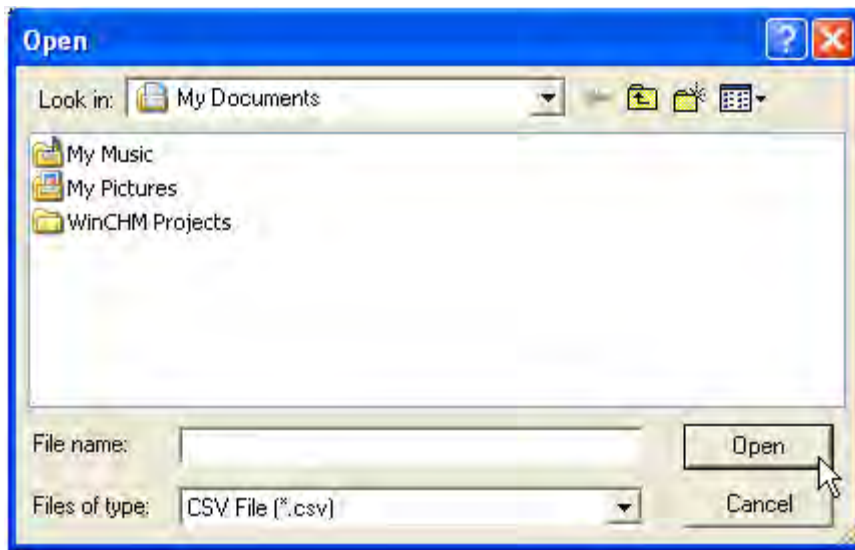

3.3.5 Parameters

(1) The input formats of the channels

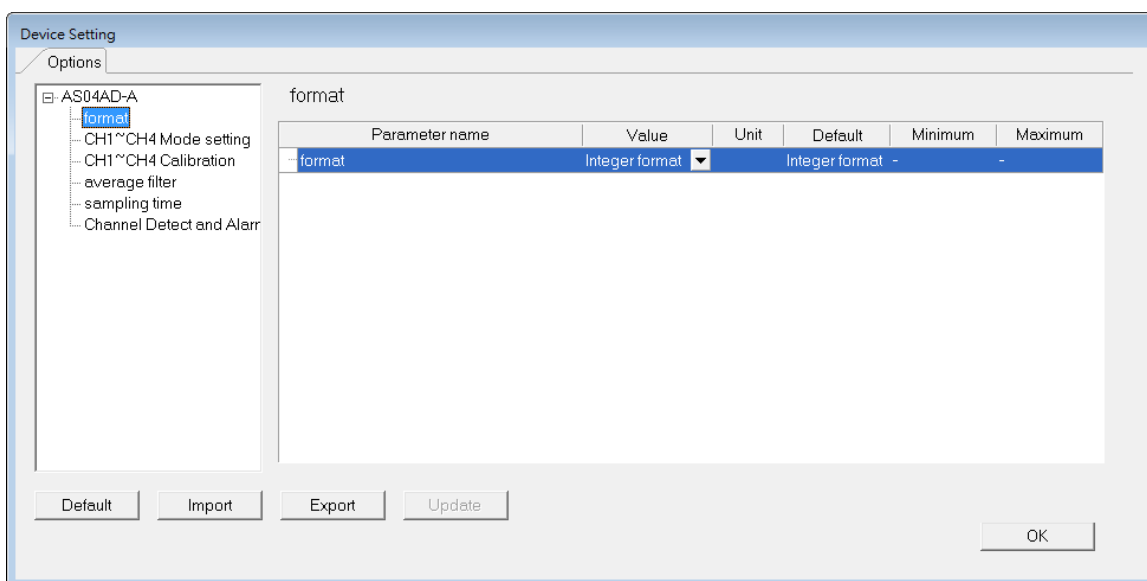

(2) The CH1-CH4 (channel 1-channel 4) mode settings

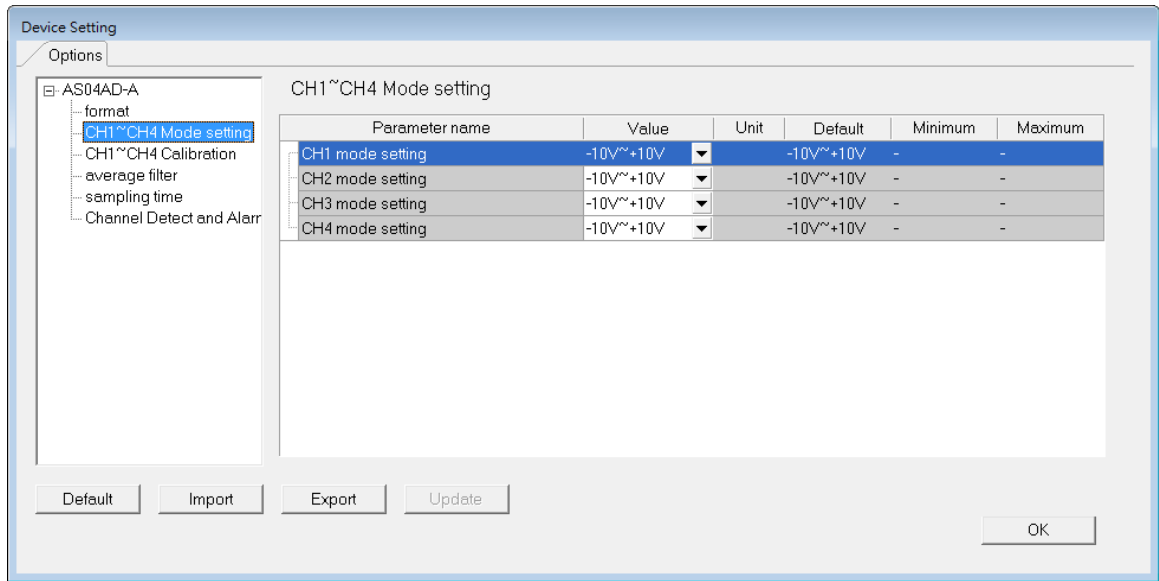

(3) The CH1-CH4 calibration settings

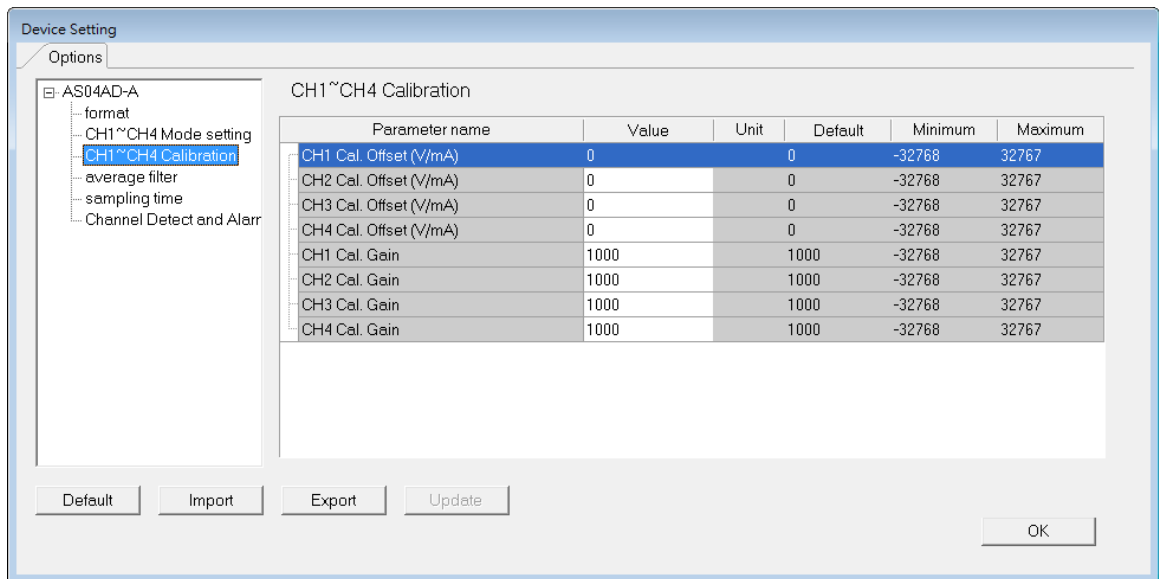

(4) The average filter settings

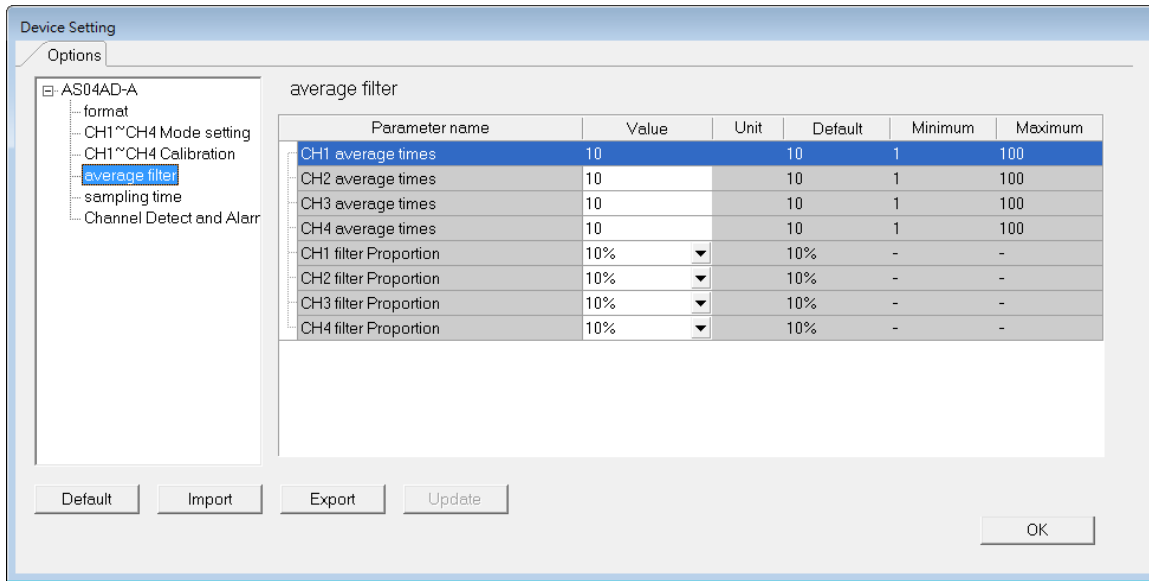

(5) The sampling time settings

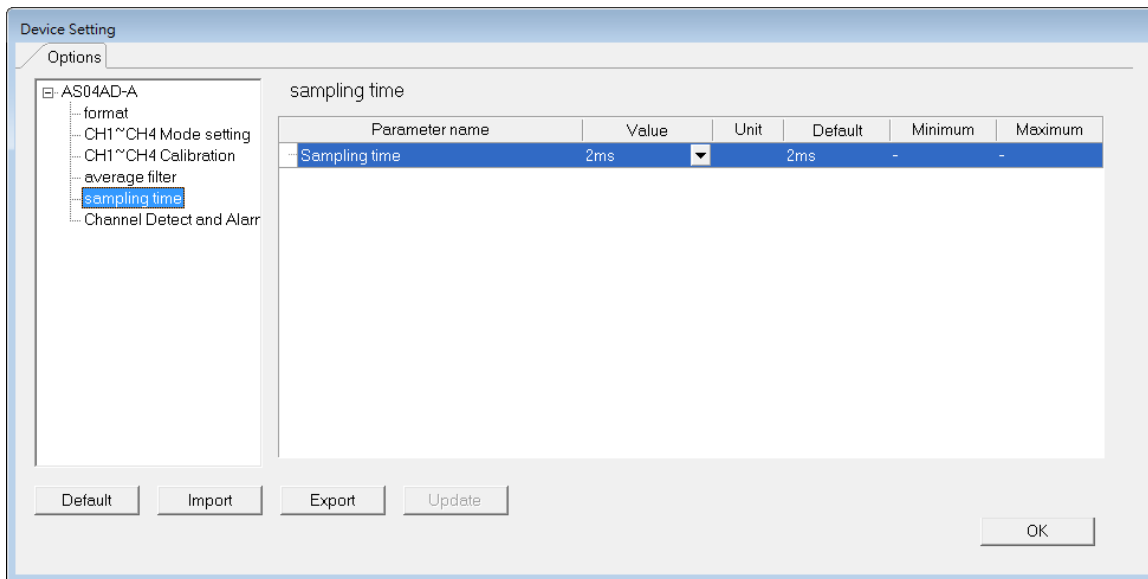

(6) The channel detection settings

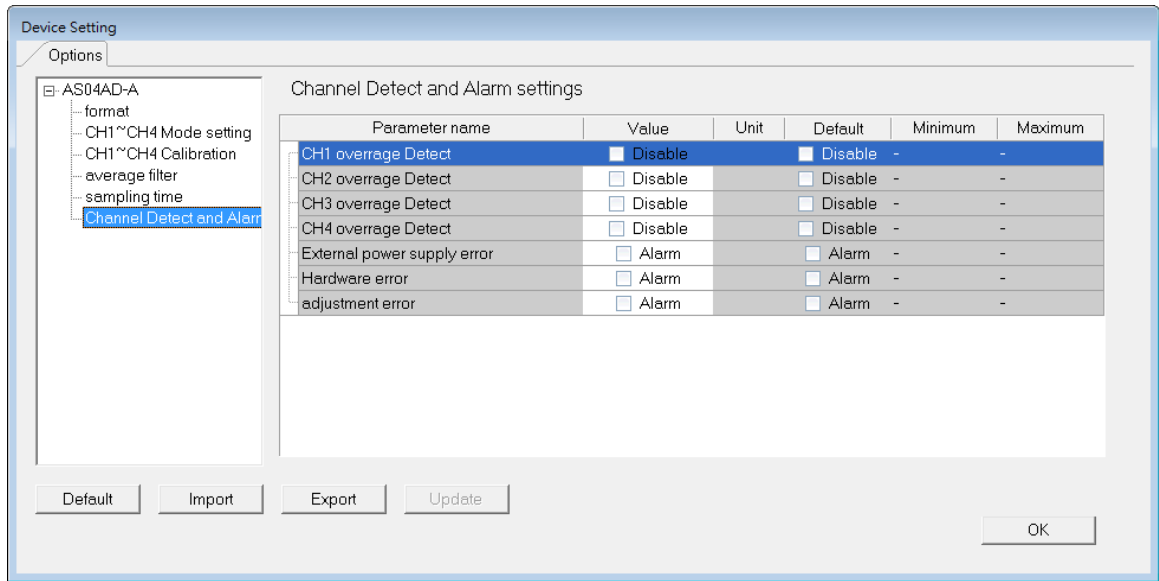

3.4 DIADesigner-AX (Hardware Configuration)

The following example uses AS04AD-A.

3.4.1 Initial Setting

- (1) Start DIADesigner-AX, click **New Project**, and then **Project+Device** to create a new project.

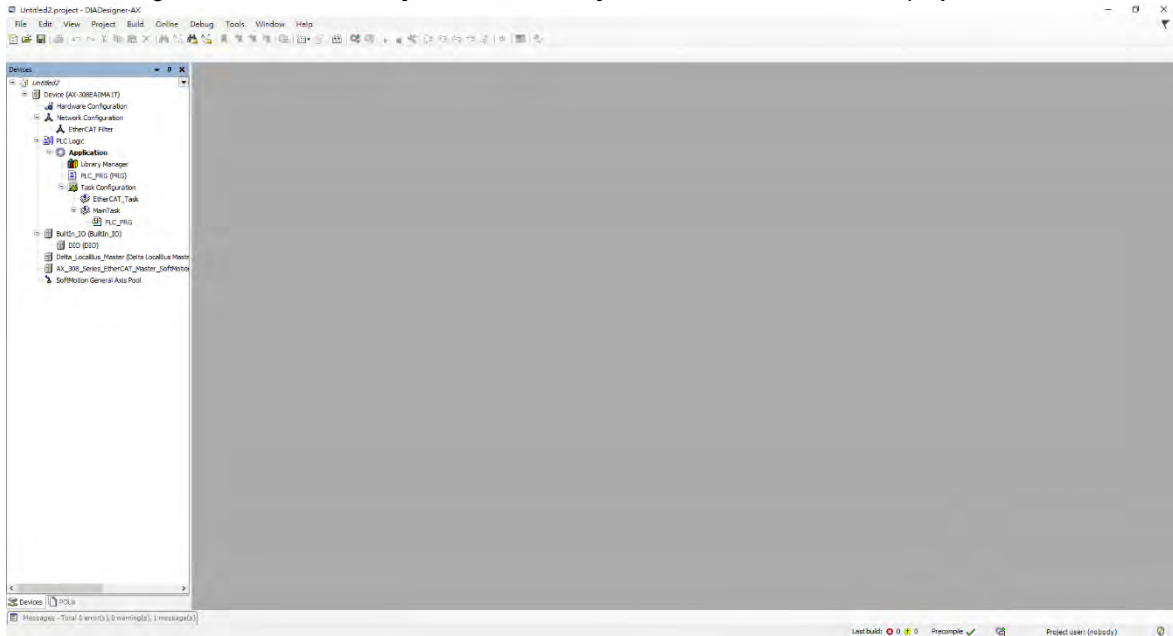

- (2) Add modules in:
 - ① Double-click **Hardware Configuration**
 - ② Select the **+** section and drag and drop the module that you want to add from the Product List to the **+** section.
 - or ③ Right-click **Delta_Localbus Master** to see the context menu and then double-click **Add Device** to add devices manually or double-click **Scan for Devices**.

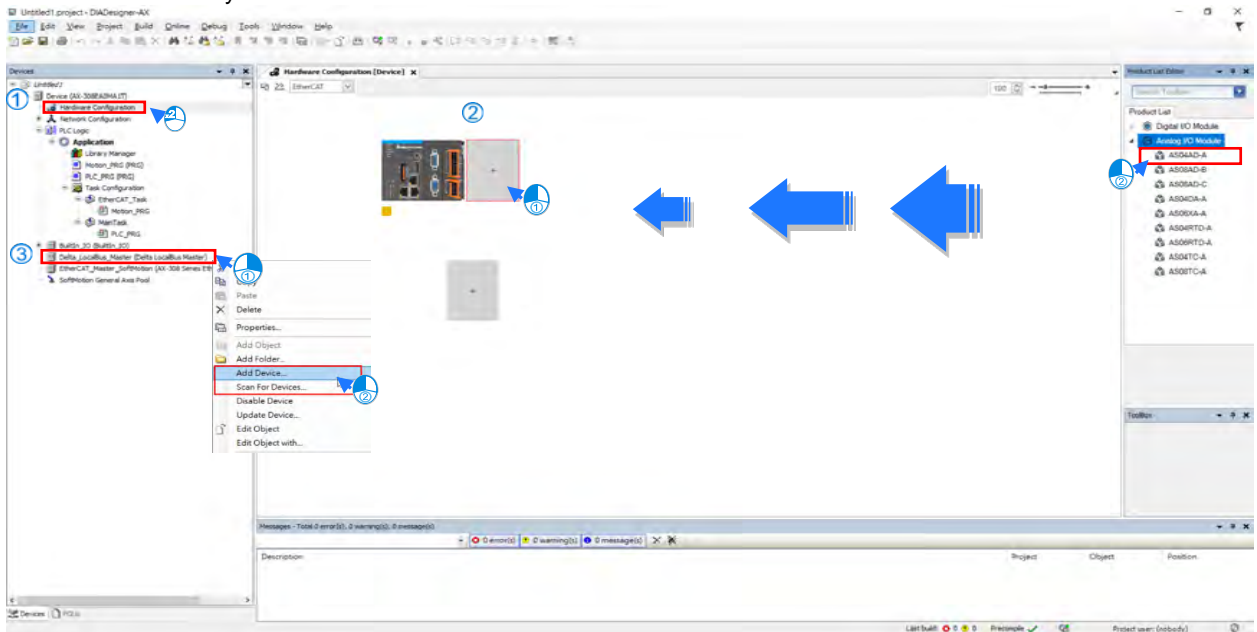

- (3) Select modules:
- ① Double-click the module name in the **Hardware Configuration** area.
 - or ② Double-click the module name shown in the node.

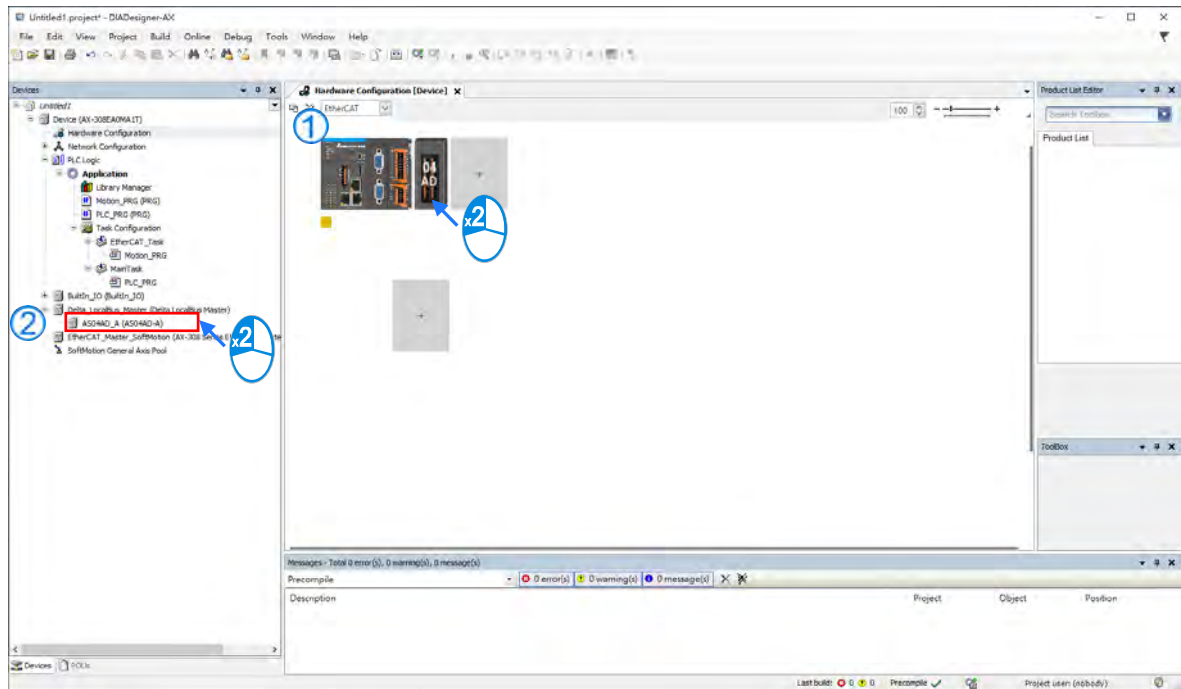

- (4) Module parameter setting page:

Parameter	Type	Value	Defa...	Unit	Description
AS04AD-A Parameters					
AS04AD-A I/O Mapping					
Status					
Information					
Format	Enumeration of UINT	Integer	Integer		
CH1~CH4 Mode Setting					
CH1 Mode Setting	Enumeration of WORD	-10V~...	-10V~...		
CH2 Mode Setting	Enumeration of WORD	-10V~...	-10V~...		
CH3 Mode Setting	Enumeration of WORD	-10V~...	-10V~...		
CH4 Mode Setting	Enumeration of WORD	-10V~...	-10V~...		
CH1~CH4 Calibration					
CH1 Cal. Offset (V/mA)	INT(-32768..32767)	0	0		
CH2 Cal. Offset (V/mA)	INT(-32768..32767)	0	0		
CH3 Cal. Offset (V/mA)	INT(-32768..32767)	0	0		
CH4 Cal. Offset (V/mA)	INT(-32768..32767)	0	0		
CH1 Cal. Gain	INT(-32768..32767)	1000	1000		
CH2 Cal. Gain	INT(-32768..32767)	1000	1000		
CH3 Cal. Gain	INT(-32768..32767)	1000	1000		
CH4 Cal. Gain	INT(-32768..32767)	1000	1000		
Average Filter					
CH1 Average Times	WORD(1..100)	10	10		
CH2 Average Times	WORD(1..100)	10	10		
CH3 Average Times	WORD(1..100)	10	10		
CH4 Average Times	WORD(1..100)	10	10		
CH1 Filter Proportion	Enumeration of WORD	10%	10%		
CH2 Filter Proportion	Enumeration of WORD	10%	10%		
CH3 Filter Proportion	Enumeration of WORD	10%	10%		
CH4 Filter Proportion	Enumeration of WORD	10%	10%		
Sampling Time					
sampling time	Enumeration of WORD	2ms	2ms		
Channel Detect and Alarm Settings	WORD	0			
CH1 Overrange Detect	BOOL	FALSE	FALSE		
CH2 Overrange Detect	BOOL	FALSE	FALSE		
CH3 Overrange Detect	BOOL	FALSE	FALSE		
CH4 Overrange Detect	BOOL	FALSE	FALSE		
Reserved	BOOL	FALSE	FALSE		
Reserved	BOOL	FALSE	FALSE		
Reserved	BOOL	FALSE	FALSE		

(5) After setting is complete, select the module and click **Login** on the tool bar to download the settings to the modules.

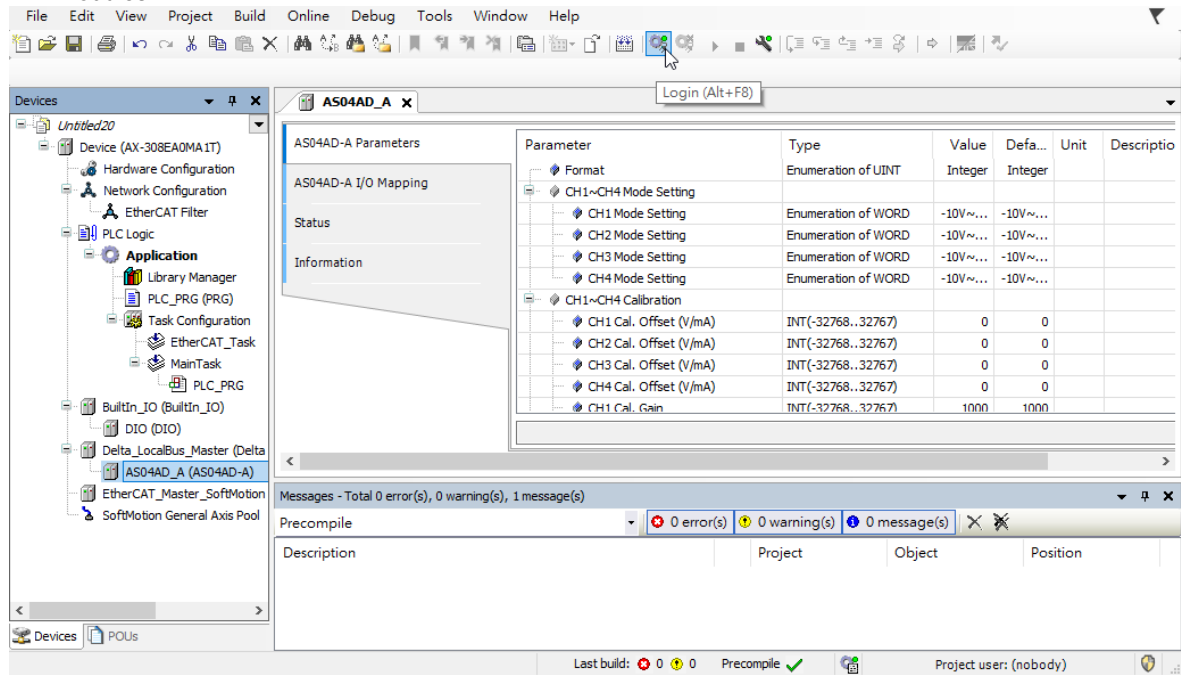

3.4.2 Checking the Version of a Module

- (1) Select the module and click the Information tab to see the module information.

AS04AD-A Parameters

AS04AD-A I/O Mapping

Status

Information

General

Name: AS04AD-A
Vendor: Delta Electronics, Inc.
Categories:
Type: 40000
ID: 16F7 8301
Version: 1.0.0.6
Order Number: AS04AD-A
Description: 4 channels 16 bits analog input : -10~+10V, 0~10V, -5~+5V, 0/1~5V, 0/4~20 mA,, -20mA~20 mA conversion time = 2ms/channel

- (2) Select the module and click **Login** on the tool bar to go to Online Mode. You can find the Module Revision from the Parameters tab.

File Edit View Project Build Online Debug Tools Window Help

AS04AD_A x

AS04AD-A Parameters

AS04AD-A I/O Mapping

Status

Information

Parameter	Type	Current Value	Prepa
Format	Enumeration of UINT	Integer	
CH1~CH4 Mode Setting			
CH1~CH4 Calibration			
Average Filter			
Sampling Time			
Channel Detect and Alarm Settings	WORD	16#0000	
Module Revision	DWORD	16#00010000	

Messages - Total 0 error(s), 0 warning(s), 7 message(s)

Build 0 error(s) 0 warning(s) 7 message(s)

Description Project Object Position

Messages - Total 0 error(s), 0 warning(s), 7 message(s) Watch 1 Breakpoints

Device user: Anonymous Last build: 0 0 Precompile STOP Program loaded Program unchanged Project user: (nobody)

3.4.3 Online Mode

- Select the module and click **Login** on the tool bar to go to **Online Mode**. You can monitor all configuration parameters. Values in the column of Prepared Value are configurable online. After editing the values in the Prepared Value column, click **Write Parameter** to confirm the change.

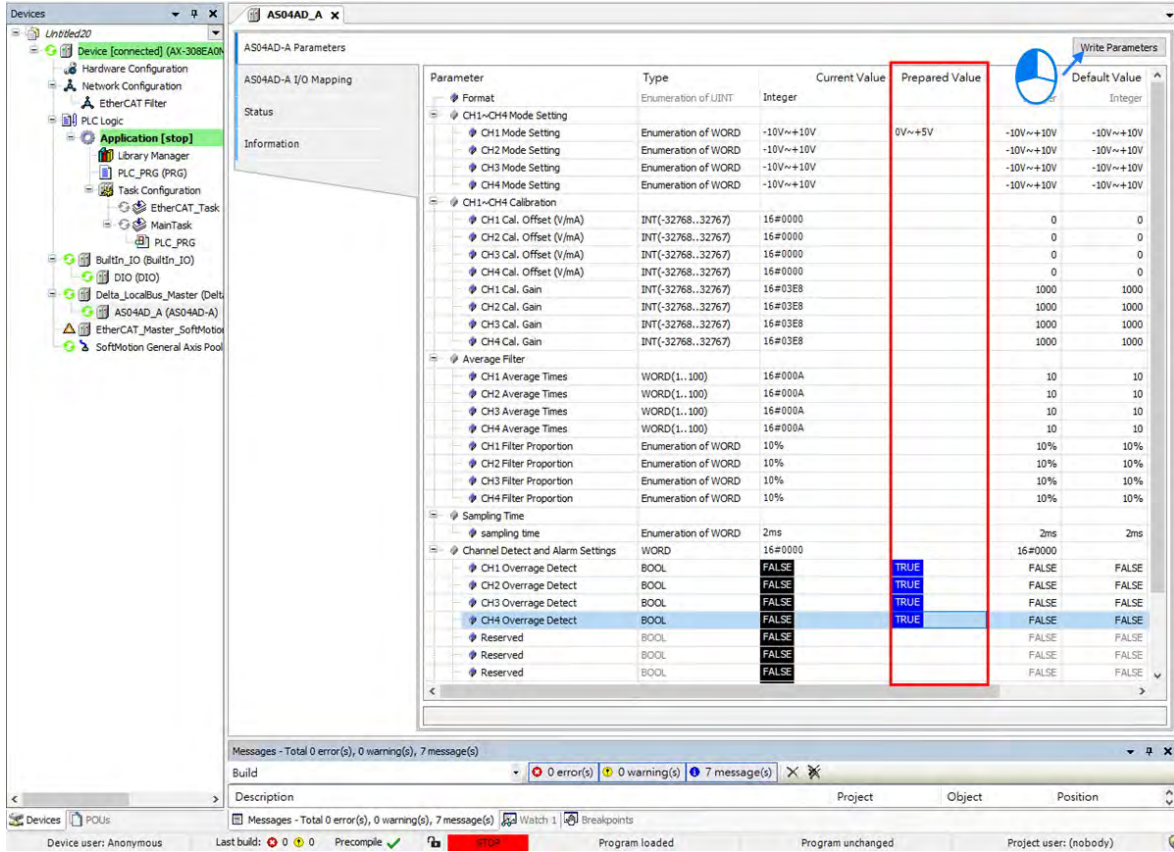

- You can monitor the values, status, error codes in each channel from the I/O Mapping tab.

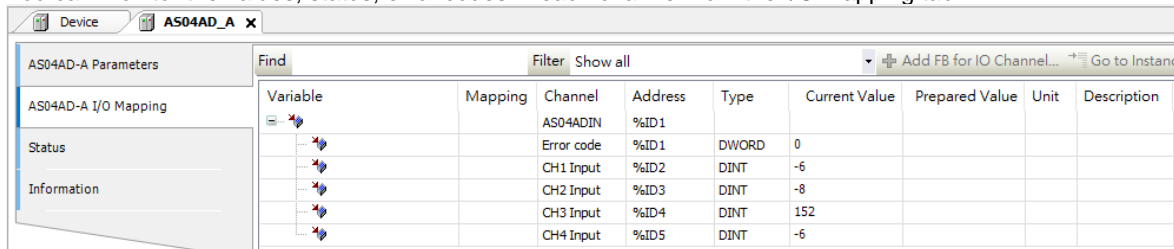

- You can monitor the current status and error codes from the Status tab.

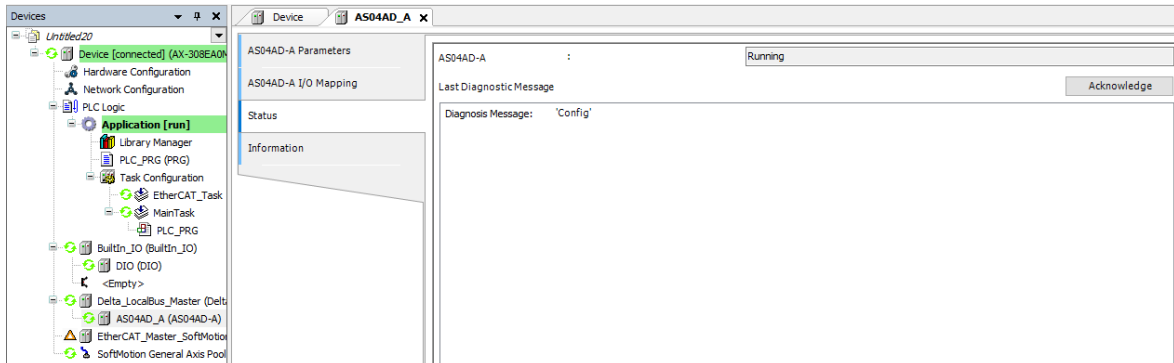

3.4.4 Parameters

- (1) You can set up the value format to **Integer** or **Floating** for Channel 1 to 4.

Parameter	Type	Value	Default Value	Unit	Description
Format	Enumeration of UINT	Integer	Integer		
CH1~CH4 Mode Setting					
CH1 Mode Setting	Enumeration of WORD	Integer	V~+10V		
CH2 Mode Setting	Enumeration of WORD	-10V~+10V	V~+10V		
CH3 Mode Setting	Enumeration of WORD	-10V~+10V	-10V~+10V		
CH4 Mode Setting	Enumeration of WORD	-10V~+10V	-10V~+10V		

- (2) You can set up the values for Channel 1 to 4.

Parameter	Type	Value	Default Value	Unit	Description
Format	Enumeration of UINT	Integer	Integer		
CH1~CH4 Mode Setting					
CH1 Mode Setting	Enumeration of WORD	-10V~+10V	-10V~+10V		
CH2 Mode Setting	Enumeration of WORD	Close	-10V~+10V		
CH3 Mode Setting	Enumeration of WORD	-10V~+10V	-10V~+10V		
CH4 Mode Setting	Enumeration of WORD	0V~+10V	-10V~+10V		
CH1~CH4 Calibration					
CH1 Cal. Offset (V/mA)	INT(-32768..32767)	0mA~20mA	0		
CH2 Cal. Offset (V/mA)	INT(-32768..32767)	4mA~20mA	0		
CH3 Cal. Offset (V/mA)	INT(-32768..32767)	-20mA~20mA	0		

- (3) You can set up the calibrations for for Channel 1 to 4.

Parameter	Type	Value	Default Value	Unit	Description
CH1~CH4 Calibration					
CH1 Cal. Offset (V/mA)	INT(-32768..32767)	0	0		
CH2 Cal. Offset (V/mA)	INT(-32768..32767)	0	0		
CH3 Cal. Offset (V/mA)	INT(-32768..32767)	0	0		
CH4 Cal. Offset (V/mA)	INT(-32768..32767)	0	0		
CH1 Cal. Gain	INT(-32768..32767)	1000	1000		
CH2 Cal. Gain	INT(-32768..32767)	1000	1000		
CH3 Cal. Gain	INT(-32768..32767)	1000	1000		
CH4 Cal. Gain	INT(-32768..32767)	1000	1000		

- (4) You can set up the average filtering for Channel 1 to 4.

Parameter	Type	Value	Default Value	Unit	Description
Average Filter					
CH1 Average Times	WORD(1..100)	10	10		
CH2 Average Times	WORD(1..100)	10	10		
CH3 Average Times	WORD(1..100)	10	10		
CH4 Average Times	WORD(1..100)	10	10		
CH1 Filter Proportion	Enumeration of WORD	10%	10%		
CH2 Filter Proportion	Enumeration of WORD	10%	10%		
CH3 Filter Proportion	Enumeration of WORD	10%	10%		
CH4 Filter Proportion	Enumeration of WORD	10%	10%		

(5) You can set up the sampling time.

Sampling Time	Enumeration of WORD	2ms	2ms		
Channel Detect and Alarm Settings	WORD	0			
CH1 Overrange Detect	BOOL	FALSE	FALSE		
CH2 Overrange Detect	BOOL	FALSE	FALSE		
CH3 Overrange Detect	BOOL	FALSE	FALSE		
CH4 Overrange Detect	BOOL	FALSE	FALSE		
Reserved	BOOL	FALSE	FALSE		
Reserved	BOOL	FALSE	FALSE		
Reserved	BOOL	FALSE	FALSE		

(6) You can set up the channel detect and alarm settings.

Channel Detect and Alarm Settings	WORD	0			
CH1 Overrange Detect	BOOL	FALSE	FALSE		
CH2 Overrange Detect	BOOL	FALSE	FALSE		
CH3 Overrange Detect	BOOL	FALSE	FALSE		
CH4 Overrange Detect	BOOL	FALSE	FALSE		
Reserved	BOOL	FALSE	FALSE		
Reserved	BOOL	FALSE	FALSE		
Reserved	BOOL	FALSE	FALSE		
Reserved	BOOL	FALSE	FALSE		
External Power Supply Error	BOOL	FALSE	FALSE		
Hardware Error	BOOL	FALSE	FALSE		
Adjustment Error	BOOL	FALSE	FALSE		

3.5 Troubleshooting

3.5.1 Error Codes

Error Code	Description	A → D LED Indicator	ERROR LED Indicator
16#1605	Hardware failure	OFF	ON
16#1607	The external voltage is abnormal.	OFF	ON
16#1608	The factory calibration is abnormal.	OFF	ON
16#1801	The external voltage is abnormal.	OFF	Blinking
16#1802	Hardware failure	OFF	Blinking
16#1804	The factory calibration is abnormal.	OFF	Blinking
16#1808	The signal received by channel 1 exceeds the range of inputs that the hardware can receive.	Run: blinking Stop: OFF	Blinking
16#1809	The signal received by channel 2 exceeds the range of inputs that the hardware can receive.		
16#180A	The signal received by channel 3 exceeds the range of inputs that the hardware can receive.		
16#180B	The signal received by channel 4 exceeds the range of inputs that the hardware can receive.		
16#180C	The signal received by channel 5 exceeds the range of inputs that the hardware can receive.		
16#180D	The signal received by channel 6 exceeds the range of inputs that the hardware can receive.		
16#180E	The signal received by channel 7 exceeds the range of inputs that the hardware can receive.		
16#180F	The signal received by channel 8 exceeds the range of inputs that the hardware can receive.		
-	When power-on, the module is not detected by CPU module.	OFF	Blinking once or twice and after 2 seconds, it blinks repeatedly

3.5.2 Troubleshooting Procedure

Description	Procedure
The external voltage is abnormal.	Ensure the external 24 V power supply to the module is functioning normally.
Hardware failure	Return the module to the factory for repair.
Internal error The factory calibration is abnormal.	Contact the factory.
The signal received by channel 1 exceeds the range of inputs that the hardware can receive.	Check the signal received by channel 1
The signal received by channel 2 exceeds the range of inputs that the hardware can receive.	Check the signal received by channel 2.
The signal received by channel 3 exceeds the range of inputs that the hardware can receive.	Check the signal received by channel 3.
The signal received by channel 4 exceeds the range of inputs that the hardware can receive.	Check the signal received by channel 4.
The signal received by channel 5 exceeds the range of inputs that the hardware can receive.	Check the signal received by channel 5.
The signal received by channel 6 exceeds the range of inputs that the hardware can receive.	Check the signal received by channel 6.
The signal received by channel 7 exceeds the range of inputs that the hardware can receive.	Check the signal received by channel 7.
The signal received by channel 8 exceeds the range of inputs that the hardware can receive.	Check the signal received by channel 8.
When power-on, the module is not detected by CPU module.	Check if the connection between module and CPU module is working. If not, connect again.

Chapter 4 Analog Output Module AS04DA

Table of Contents

4.1 Overview	4-2
4.1.1 Characteristics.....	4-2
4.2 Specifications and Functions	4-3
4.2.1 Specifications	4-3
4.2.2 Profile	4-5
4.2.3 Arrangement of Terminals.....	4-6
4.2.4 Control Registers	4-6
4.2.5 Functions.....	4-8
4.2.6 Wiring	4-12
4.2.7 LED Indicators.....	4-14
4.3 HWCONFIG in ISPSOft	4-14
4.3.1 Initial Setting	4-14
4.3.2 Checking the Version of a Module.....	4-17
4.3.3 Online Mode.....	4-18
4.3.4 Importing/Exporting a Parameter File	4-19
4.3.5 Parameters	4-20
4.4 DIADesigner-AX (Hardware Configuration)	4-23
4.4.1 Initial Setting	4-23
4.4.2 Checking the Version of a Module.....	4-26
4.4.3 Online Mode.....	4-27
4.4.4 Parameters	4-28
4.5 Troubleshooting	4-30
4.5.1 Error Codes.....	4-30
4.5.2 Troubleshooting Procedure	4-30

4.1 Overview

An analog output module receives four 12-bit blocks of digital data from a CPU module. The module converts the digital data into analog signals (voltage or current). For software operation, ISPSOft, DIADesigner or DIADesigner-AX is what you need. If you are using AS Series PLC CPU, refer to ISPSOft User Manual or DIADesigner Manual for more information. The new software DIADesigner-AX only supports AX Series PLC CPU and AS Series modules now, refer to AX-3 User Manual for more information on software operation.

4.1.1 Characteristics

(1) **Select a module based on its practical application.**

AS04DA-A: Has four channels. A channel can send either voltage or current output.

(2) **High-speed conversion**

Digital signals are converted to analog signals at a rate of 2 ms per channel.

(3) **High accuracy**

Conversion accuracy: The error range for both voltage output and current output is $\pm 0.2\%$ at ambient temperature of 25° C.

(4) **Use the utility software to configure the module.**

The HWCONFIG utility software is built into ISPSOft. You can set modes and parameters directly in HWCONFIG of ISPSOft or Hardware Configuraiton of DIADesigner without spending time writing programs to set registers to manage functions.

4.2 Specifications and Functions

4.2.1 Specifications

- **Electrical specifications**

Module Name	AS04DA-A
Number of Outputs	4
Digital-to-Analog Conversion	Voltage input/Current input
Supply Voltage	24 VDC (20.4 VDC–28.8 VDC) (-15% to +20%)
Connector Type	Removable terminal block
Conversion Time	2 ms/channel
Isolation	An analog circuit is isolated from a digital circuit by a digital integrated circuit/optocoupler, but the analog channels are not isolated from one another. Isolation between a digital circuit and a ground: 500 VAC Isolation between an analog circuit and a ground: 500 VAC Isolation between an analog circuit and a digital circuit: 500 VAC Isolation between the 24 VDC and a ground: 500 VAC
Weight	145 g

- **Functional specifications**

Digital-to-Analog Conversion	Voltage Output				
	± 10 V	0 V~10 V	± 5 V	0 V~5 V	1 V~5 V
Rated Output Range	± 10 V	0 V~10 V	± 5 V	0 V~5 V	1 V~5 V
Conversion Range	K-32000 ~ K32000	K0~K32000	K-32000 ~ K32000	K0 ~ K32000	K0 ~ K32000
Hardware Output Range	-10.1V~10.1V	-0.1V~10.1V	-5.05V~5.05V	-0.05V~5.05V	0.95V~5.05V
Error Rate (Room Temperature)	$\pm 0.2\%$				
Error Rate (Full Temperature Range)	$\pm 0.5\%$				
Linearity error (Room Temperature)	$\pm 0.05\%$				
Linearity error (Full Temperature Range)	$\pm 0.05\%$				
Hardware Resolution	12 bits				

Digital-to-Analog Conversion	Voltage Output	
Output Impedance	$\geq 1 \text{ k}\Omega$	$\geq 500 \Omega$

Digital-to-Analog Conversion	Current Output	
Rated Output Range	0 mA–20 mA	4 mA–20 mA
Conversion Range	K0 ~ K32000	
Hardware Output Range	-0.2 mA to +20.2 mA	3.8 mA–20.2 mA
Error Rate (Room Temperature)	$\pm 0.2\%$	
Error Rate (Full Temperature Range)	$\pm 0.5\%$	
Linearity Error (Room Temperature)	$\pm 0.03\%$	
Linearity error (Full Temperature Range)	$\pm 0.03\%$	
Hardware Resolution	12 bits	
Output Impedance	$\leq 550 \Omega$	

4.2.2 Profile

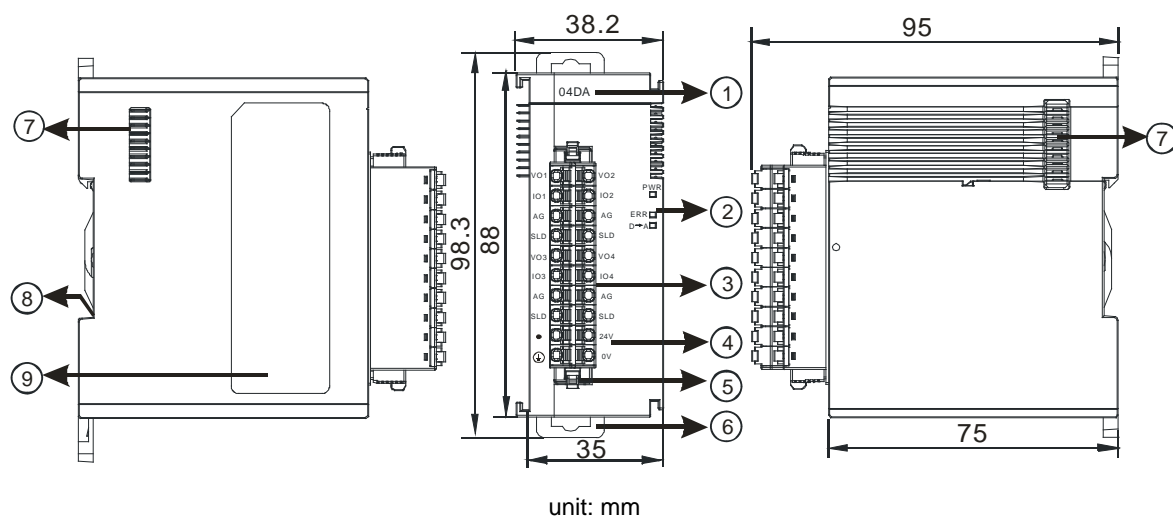

Number	Name	Description
1	Model Name	Model name of the module
2	POWER LED Indicator	Status of the power supply ON: the power is on. OFF: the power is off.
	ERROR LED Indicator	Error status of the module ON: a serious error exists in the module. OFF: the module is operating normally. Blinking: a minor error exists in the module.
	Digital-to-Analog conversion Indicator	Digital-to-Analog conversion status Blinking: conversion is in process. OFF: conversion has stopped.
3	Removable Terminal Block	Outputs are connected to loads to be driven.
4	Arrangement of the Input/Output Terminals	Arrangement of the terminals
5	Terminal Block Clip	For removing the terminal block
6	DIN Rail Clip	Secures the module onto the DIN rail
7	Module Connecting Set	Connects the modules
8	Ground Clip	
9	Label	Nameplate

4.2.3 Arrangement of Terminals

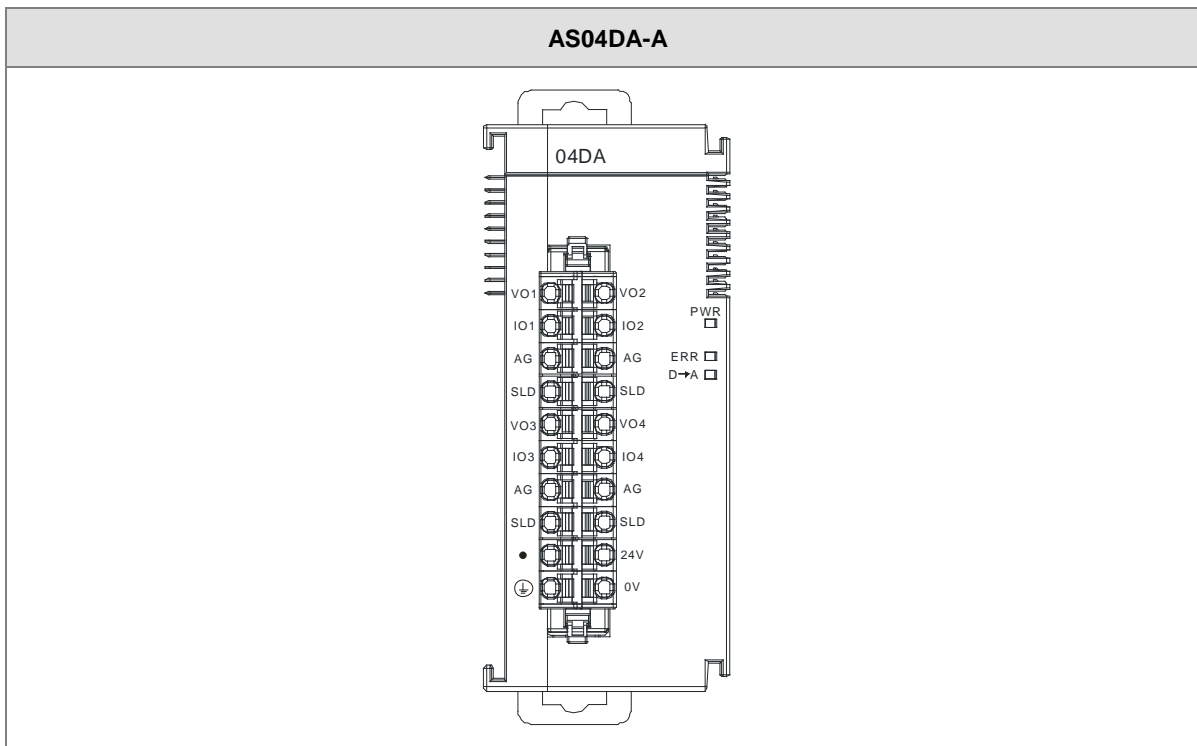

4.2.4 Control Registers

*If you use HWCONFIG to set values in CRs, once the set value is downloaded, the values can be retained in the module; however if you use TO instruction to write data into CRs, the values CANNOT be retained, after power failure or after transition of the CPU from STOP to RUN.

Note: The attribute of the CR must be W (write) to use TO instruction.

CR#	Name	Description	Atr.	Defaults
0	Format Setup	0: integer format 1: floating-point format	R	0
1	Channel 1 mode setup	0: closed 1: -10 V to +10 V (default)	R/W	1
2	Channel 2 mode setup	2: 0 V-10 V 3: -5 V to +5 V	R/W	
3	Channel 3 mode setup	4: 0 V-5 V 5: 1 V-5 V	R/W	
4	Channel 4 mode setup	6: 0 mA-20 mA 7: 4 mA-20 mA	R/W	
5	Channel 1 offset	Range: -32768 to +32767	R/W	

CR#	Name	Description	Atr.	Defaults
6	Channel 2 offset			
7	Channel 3 offset			
8	Channel 4 offset			
9	Channel 1 gain	Range: -32768 to +32767	R/W	1000
10	Channel 2 gain			
11	Channel 3 gain			
12	Channel 4 gain			
13	Retaining an output sent by channel 1	0: when the PLC stops, the value of the analog output is reset to 0. 1: when the PLC stops, the value of the analog output is retained.	R/W	0
14	Retaining an output sent by channel 2			
15	Retaining an output sent by channel 3			
16	Retaining an output sent by channel 4			
17	Refreshing the time for an output sent by channel 1	Range: 10–3200 (100 ms–32000 ms) Unit: 10 ms Any value less than 10 is processed as 0. Any value larger than 3200 is processed as 3200. Set the value to 0 to disable this function.	R/W	0
18	Refreshing the time for an output sent by channel 2			0
19	Refreshing the time for an output sent by channel 3			0
20	Refreshing the time for an output sent by channel 4			0
21	The minimum scale range for channel 1	When the format is set to integer in HWCONFIG, the scale range is invalid.	R	-10.0
22			R	
23	The minimum scale range for channel 2	For analog-digital modules, it is much more convenient if the system can convert digital values to floating-point values for earlier understanding. Here you can set the minimum and maximum scale ranges of corresponding floating-point values for channels.	R	-10.0
24			R	
25	The minimum scale range for channel 3		R	-10.0
26			R	
27	The minimum scale range for channel 4		R	-10.0

CR#	Name	Description	Atr.	Defaults
28	range for channel 4	For example, if the scale range for an analog to digital input channel is ± 10.0 V, it indicates the maximum value is +10.0 V and the minimum value is -10.0 V. If the scale range for an analog to digital input channel is 4 mA ~ 20 mA. It indicates the maximum value is 20 mA and the minimum value is 4 mA. Note: You can use PLC instruction DSCLP (API0217) and set SM685 to ON to use floating-point operations when a conversion range needs to edit.	R	
29	The maximum scale		R	10.0
30	range for channel 1		R	
31	The maximum scale		R	10.0
32	range for channel 2		R	
33	The maximum scale		R	10.0
34	range for channel 3		R	
35	The maximum scale		R	10.0
36	range for channel 4	R		
37	Channel alarm setup	0: warning 1: alarm bit0: error in the power supply bit1: error in the module hardware bit2: error in calibration	R/W	0

4.2.5 Functions

Item	Function	Description
1	Enable/Disable a Channel	1. Enable or disable a channel. 2. If a channel is disabled, the total conversion time decreases.
2	Calibration	Calibrate a linear curve.
3	Retain an Output	When a module stops running, the system can retain the signal sent by the module.
4	Refresh Time for an Output	Refresh the analog output value according to the value of the fixed slope.
5	Scale Range	You can set the scale range when the format is floating-point.

1. Enable/Disable a Channel

An analog signal is converted into a digital signal at a rate of 2 ms per channel. The total conversion time is 2 ms X (the number of channels). If a channel is not used, you can disable it to decrease the total conversion time.

2. Calibration

To make a curve meet specific needs, calibrate the curve by changing the offset and the gain. The calibration range depends on the range of inputs that the hardware can receive. The formula is:

$$\text{Output} = \frac{(\text{Input} \times \text{Gain})}{1000} + \text{Offset}$$

Example:

A channel receives voltage inputs between -10.0 V to +10.0 V. The gain is 1000, and the offset is 0. The corresponding value for the original signal -10.0 V to +10.0 V is -32000 to +32000. If you change the offset to -100, the calibrated value for the original signal -10.0 V to +10.0 V becomes -31900 to +32100.

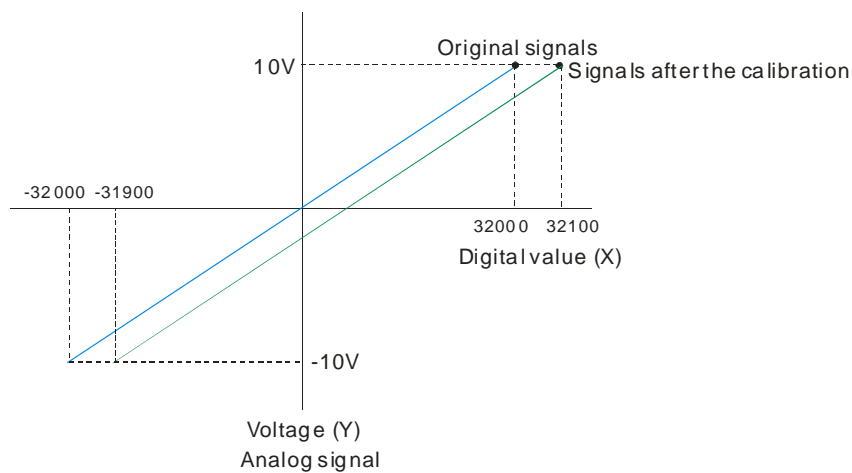

3. Retain an Output

When a module stops running, the system can retain the signal sent by the module.

The output is retained:

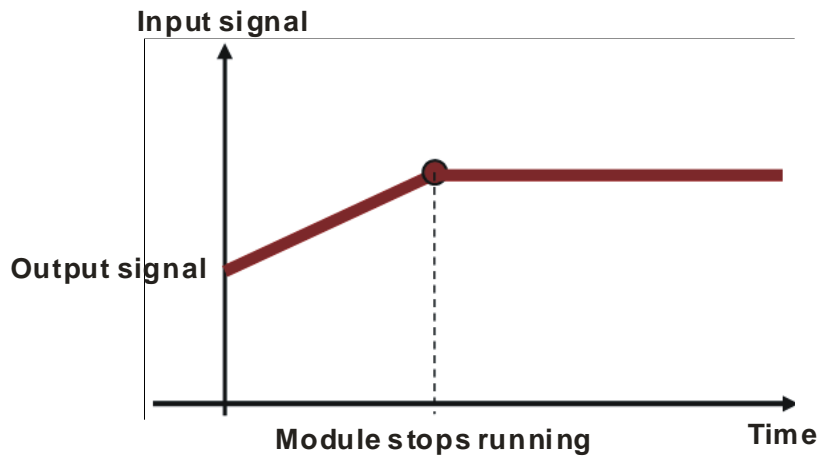

The output is not retained:

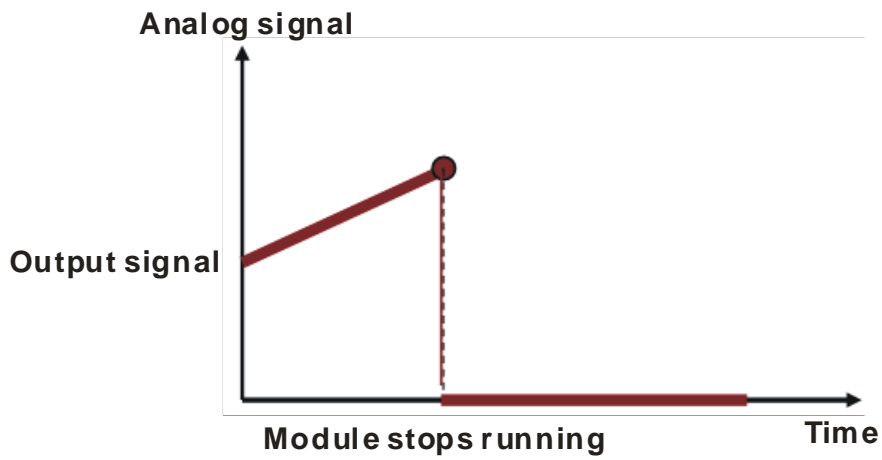

4. Refresh time for an Output

Set the refresh time for an output and the system updates the value of the slope (m) accordingly.

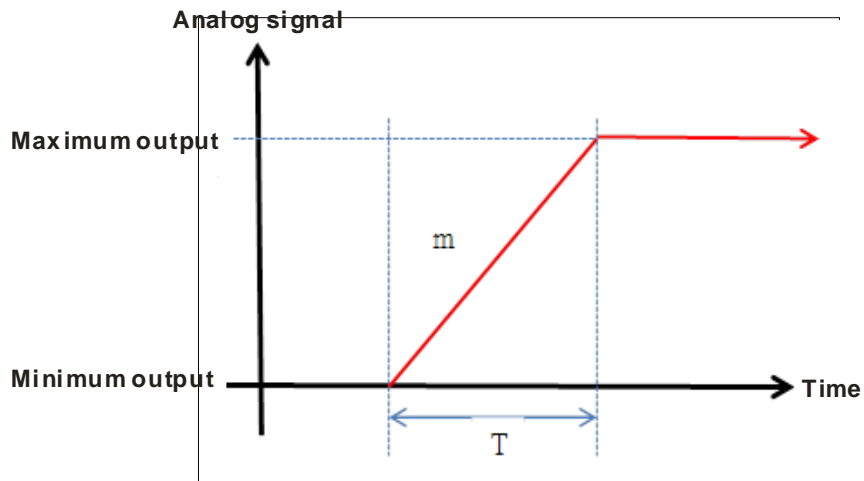

When the analog output signal changes, the system updates the value of the analog output according to the value set in the slope, as shown in the image below.

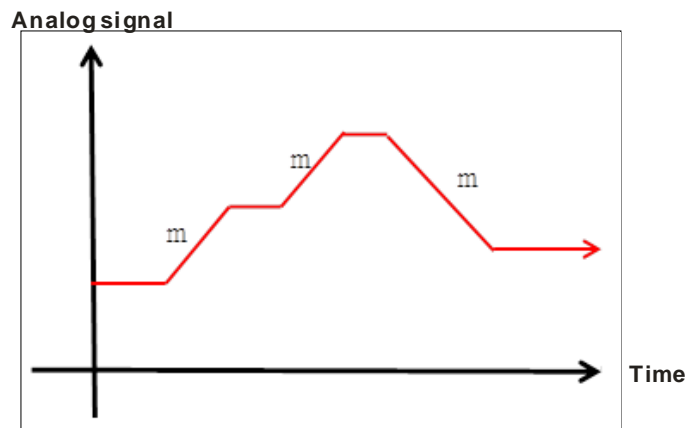

5. Scale Range

You can set the scale range when the format is floating-point. The analog output mode of a channel has a corresponding digital range. Digital values correspond to analog outputs sent by the module. For example, if the analog range is -10 V to +10 V, the digital range is -10.0 to +10.0, the HSP scale is 10.0, and the LSP scale is -10.0. The digital values -10.0 to +10.0 correspond to the analog values -10 V to +10 V, as the example below shows.

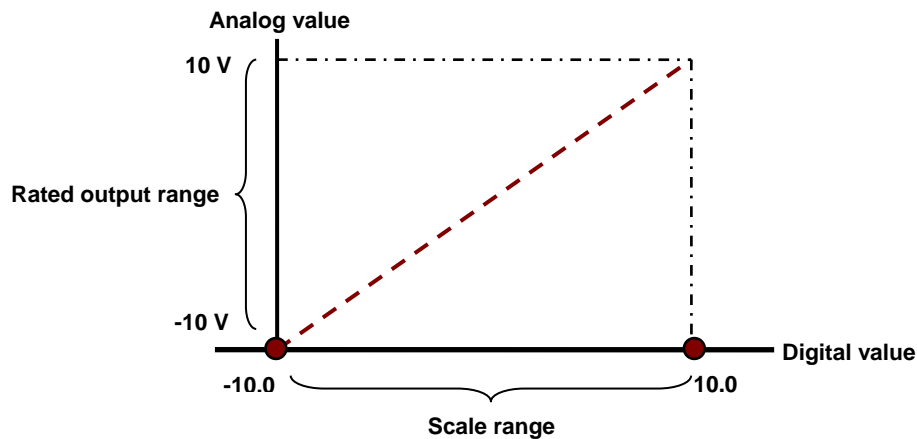

4.2.6 Wiring

● Precautions

To ensure the digital-to-analog module functions well and reliably, the external wiring must prevent noise.

- (1) To prevent a surge and induction, the AC cable and the output signal cables that are connected to the AS04DA-A must be separate cables.
- (2) Do not install or bound the cable to a main circuit, a high-voltage cable, or a cable connected to a load that is not a PLC.
- (3) Ground shielded cables and hermetically sealed cables separately.
- (4) Terminals with insulation sleeves cannot be arranged as a terminal block, so you should cover the terminals with insulation tubes.
- (5) Connect 24 to 22 AWG (1 mm) wires to the input/output terminals. The plastic jackets that are removed from the cables should be 8 mm to 10 mm long. The specifications for the terminals and the wiring of the terminals are shown below. Use only copper leads that can resist temperatures above 60° C /75° C.

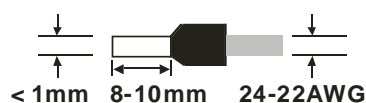

- (6) Note: use cables with the same length (less than 200 m) and use wire resistance of less than 100 ohm.

● External wiring

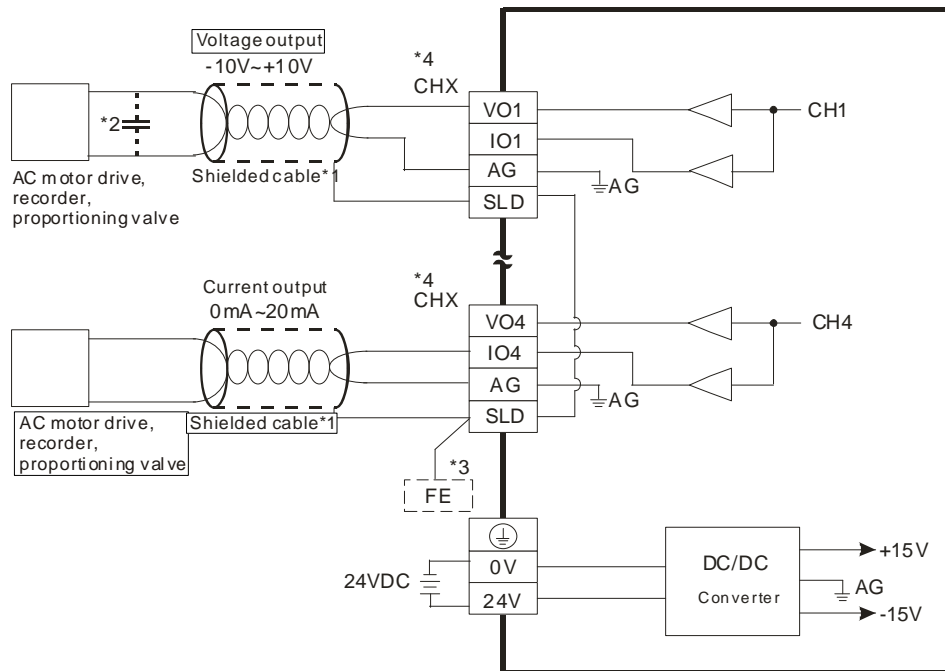

*1. Use shielded cables to isolate the analog input signal cable from other power cables.

*2. If variability in the input voltage results in interference within the wiring, connect the module to a capacitor having a capacitance between $0.1\text{--}0.47\ \mu\text{F}$ and a working voltage of 25 V.

*3. Connect the SLD to FE, and connect both the FE and the terminal \oplus to the ground terminal.

*4. Every channel can operate with the wiring presented above.

4.2.7 LED Indicators

Number	Name	Description
1	RUN LED Indicator	Operating status of the module ON: the module is running. OFF: the module is not running.
2	ERROR LED Indicator	Error status of the module ON: a serious error exists in the module. OFF: the module is operating normally. Blink: a minor error exists in the module.
3	Digital to Analog Conversion Indicator	Digital-to-analog conversion status Blinking: conversion is in process. OFF: conversion has stopped.

4

4.3 HWCONFIG in ISPSoft

4.3.1 Initial Setting

- (1) Start ISPSoft and double-click **HWCONFIG**.

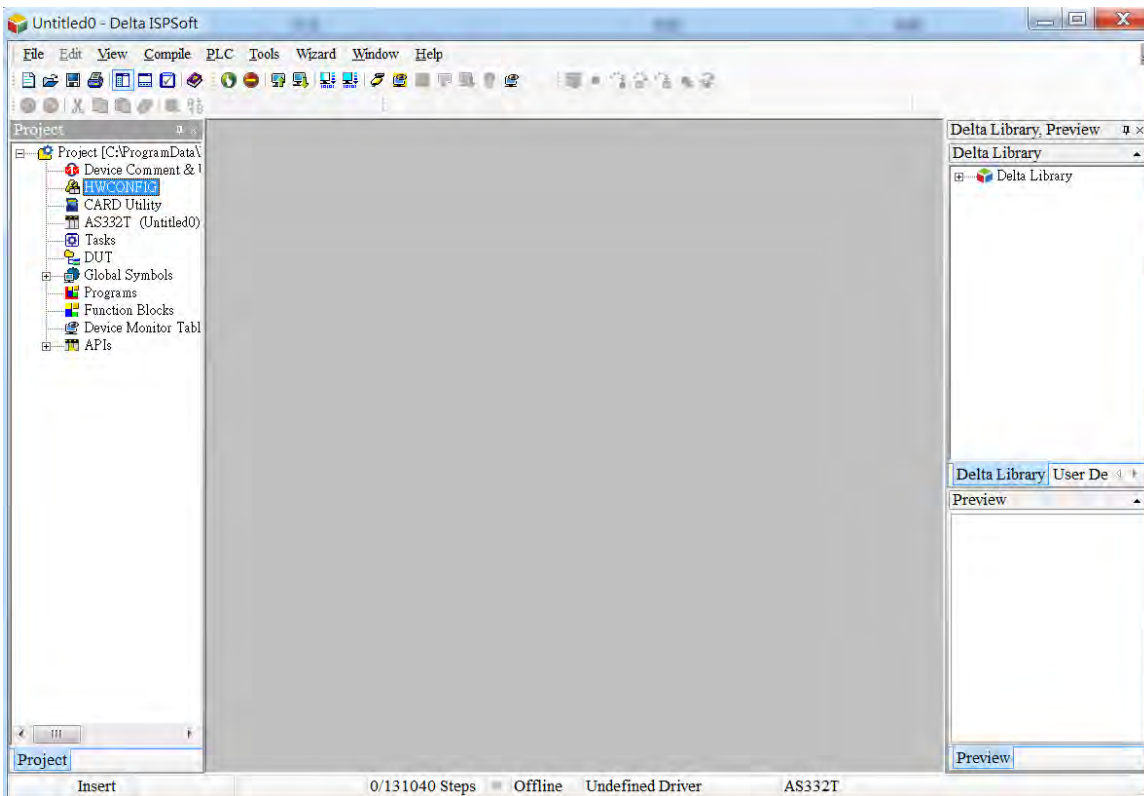

- (2) Select a module and drag it to the working area.

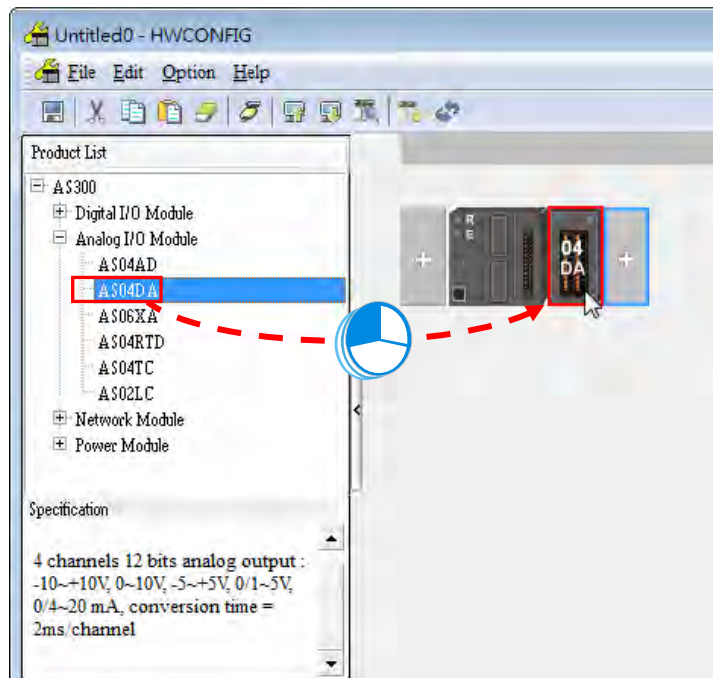

- (3) Double-click the module in the working area to open the Device Setting page.

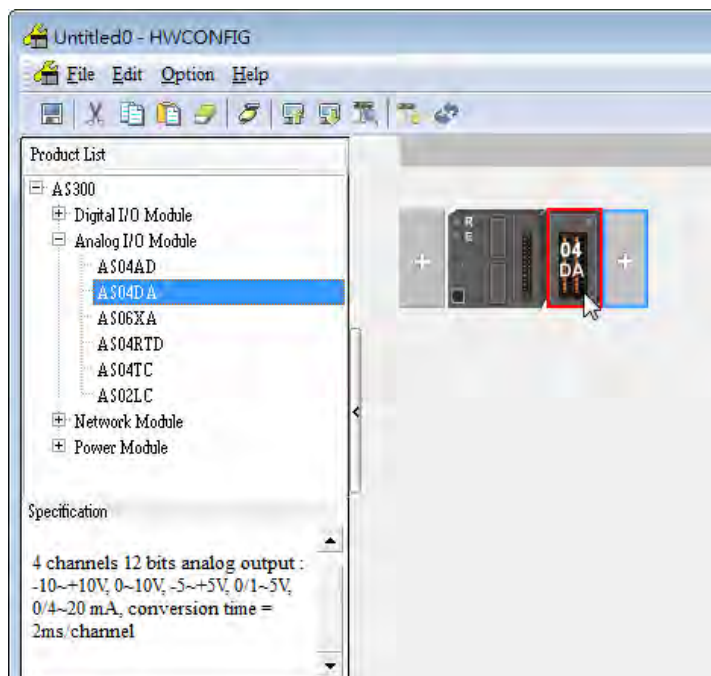

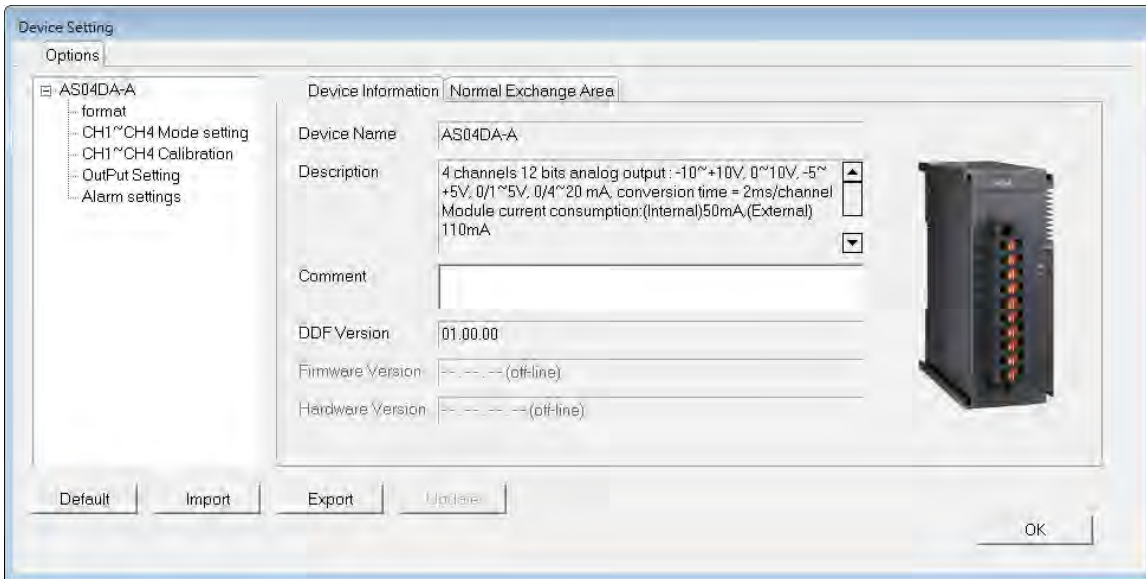

4

(4) Choose a parameter, set the values, and click **OK**.

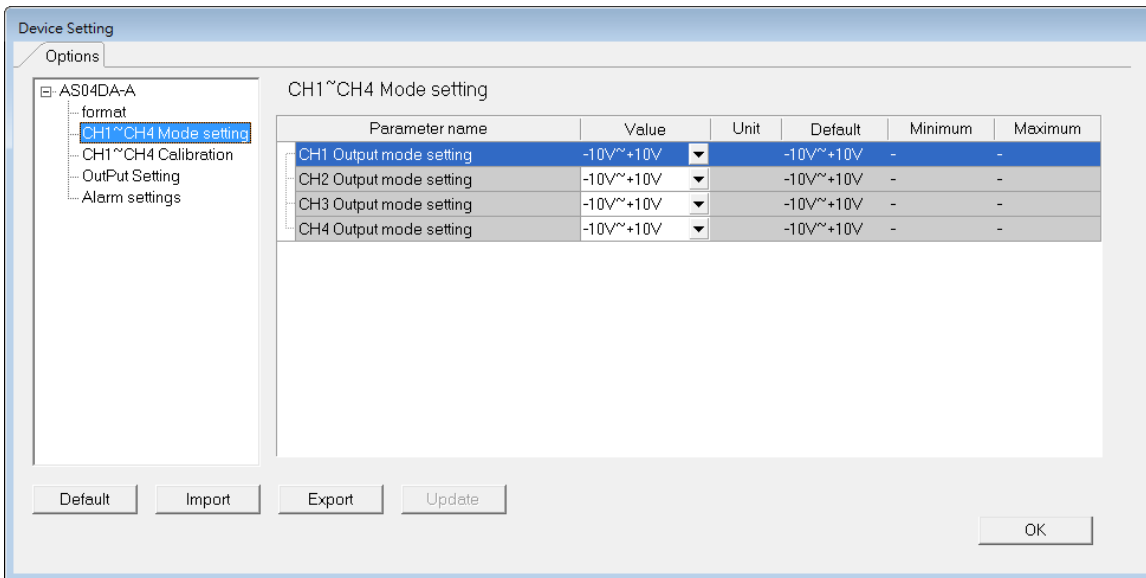

- (5) Click **Download** on the toolbar to download the parameters. Note you cannot download the parameters cannot be downloaded.

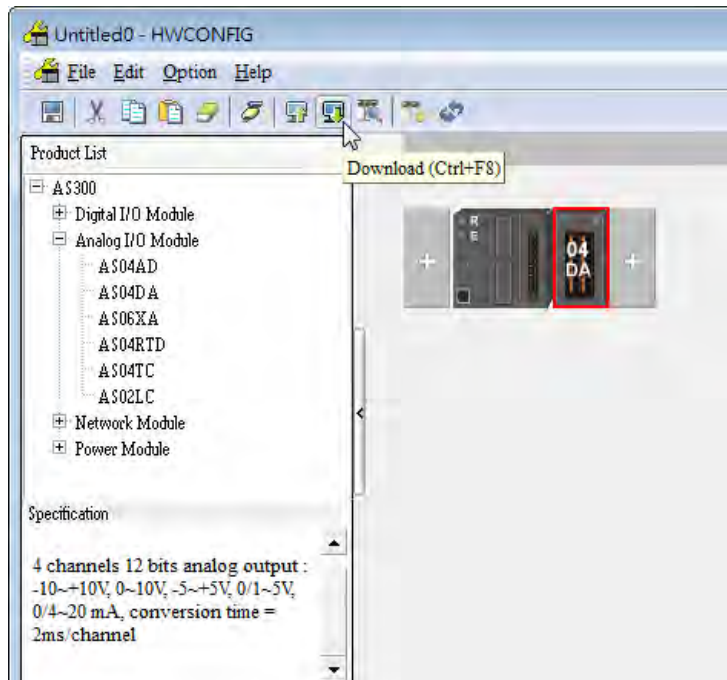

4.3.2 Checking the Version of a Module

- (1) On the **Option** menu, click **Online Mode**.

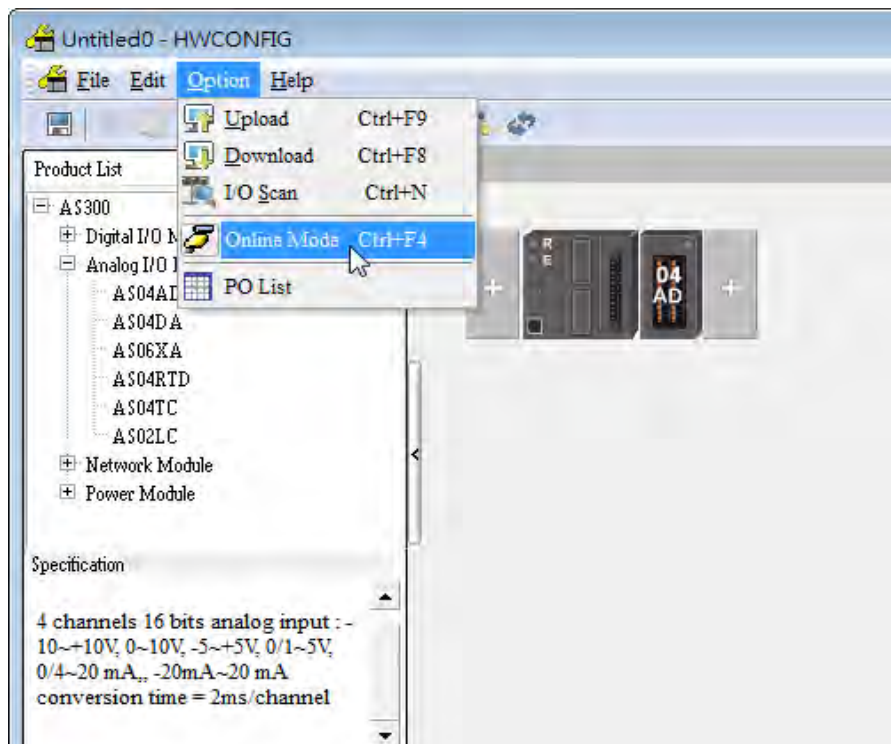

- (2) Double-click the module to open the Device Setting page. The versions of both the firmware and the hardware are displayed.

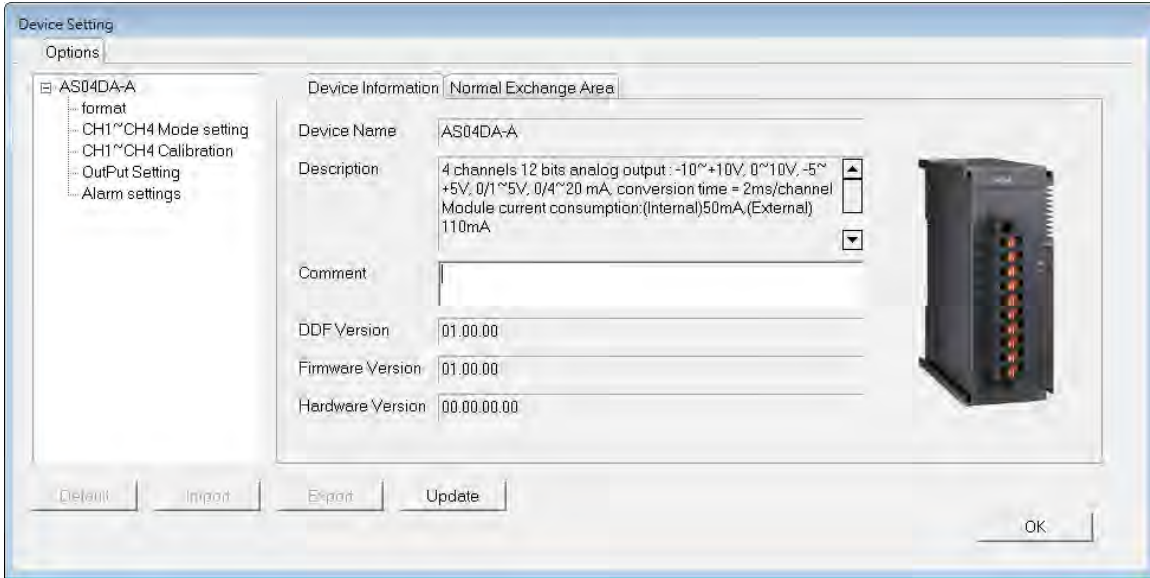

4.3.3 Online Mode

- (1) On the **Option** menu, click **Online Mode**.

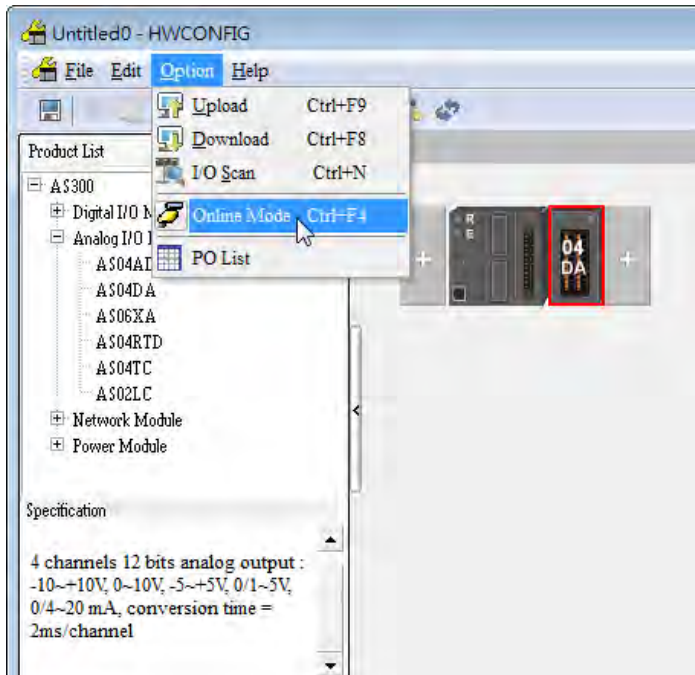

- (2) Right-click the module and click on **Module Status**.

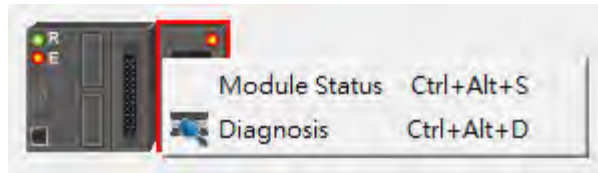

- (3) View the module status.

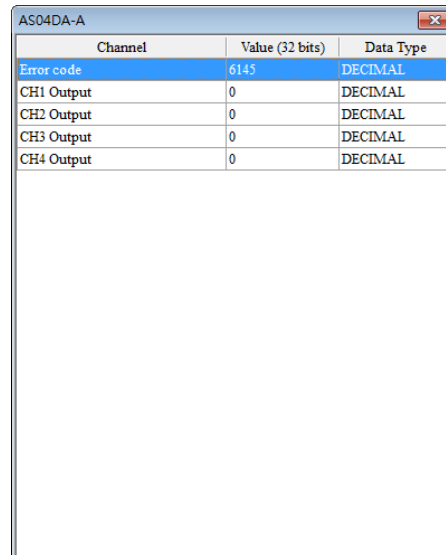

Channel	Value (32 bits)	Data Type
Error code	6145	DECIMAL
CH1 Output	0	DECIMAL
CH2 Output	0	DECIMAL
CH3 Output	0	DECIMAL
CH4 Output	0	DECIMAL

4.3.4 Importing/Exporting a Parameter File

- (1) Click **Export** in the Device Settings dialog box to save the current parameters as a CSV file (.csv).

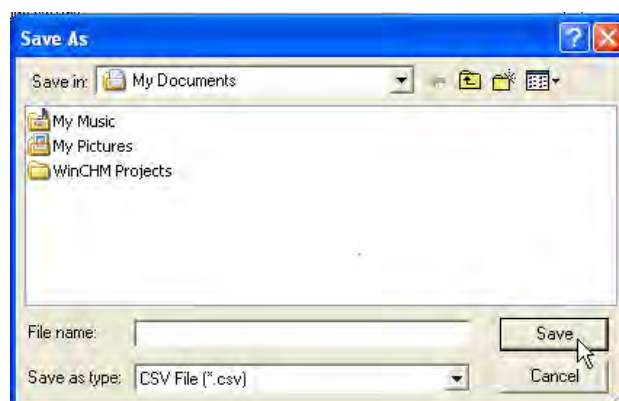
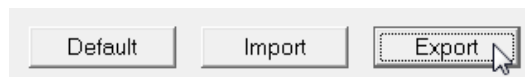

(2) Click **Import** in the Device Settings dialog box and select a CSV file to import save parameters.

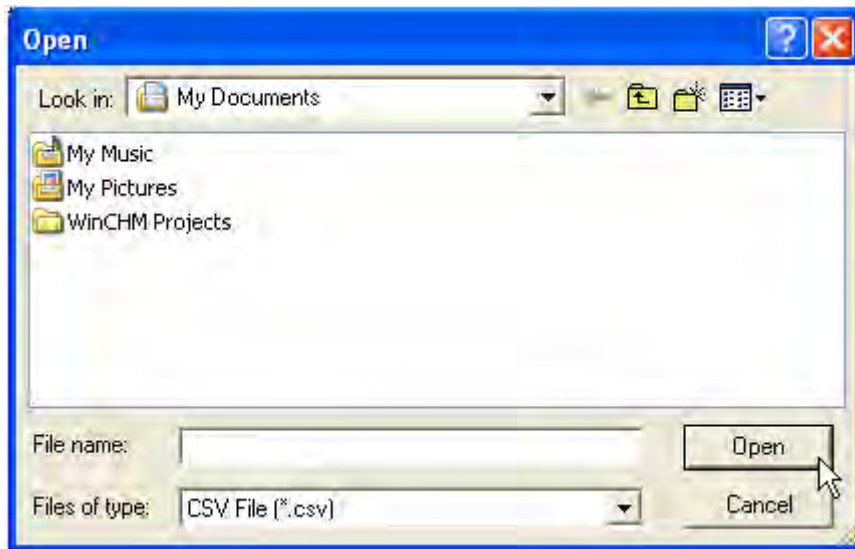
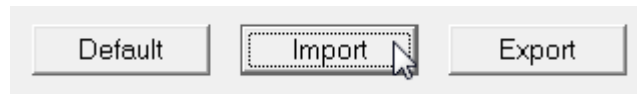

4

4.3.5 Parameters

(1) The output formats of the channels

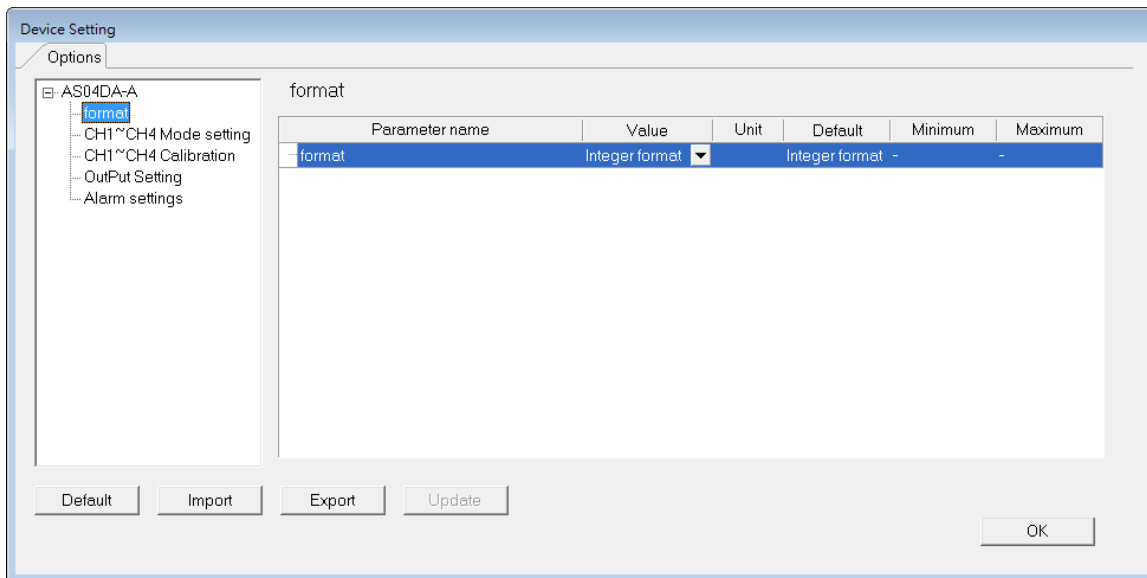

(2) The CH1–CH4 (channel 1–channel 4) mode settings

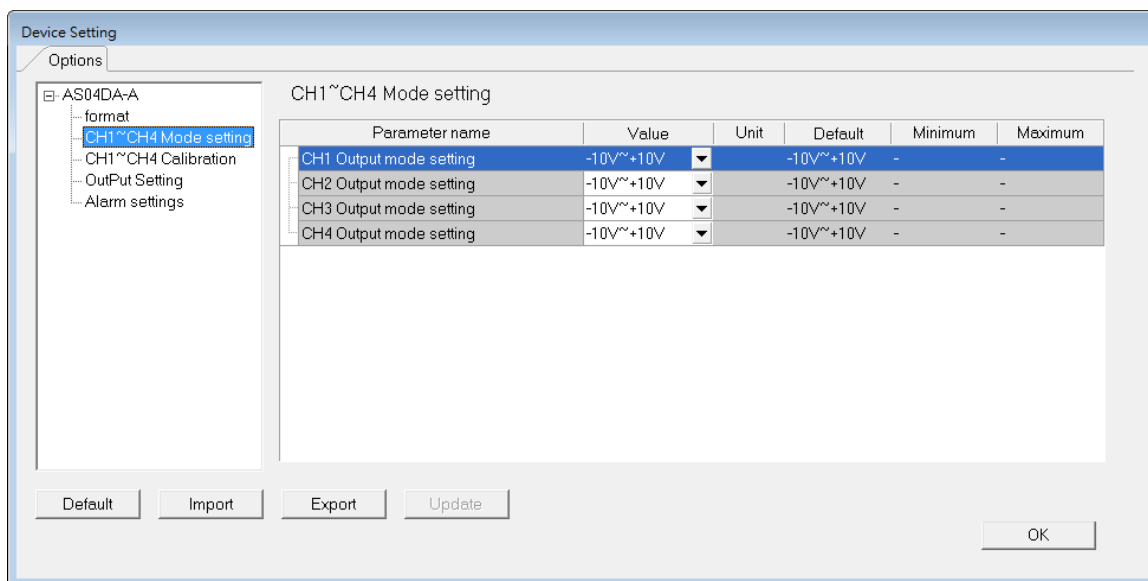

4

(3) The CH1–CH4 calibration settings

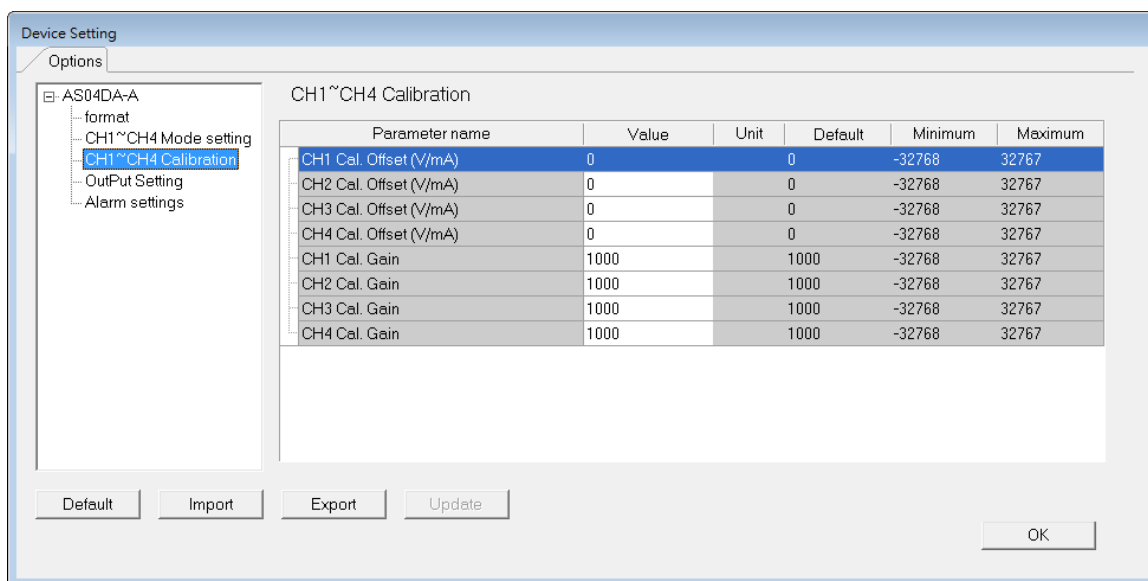

(4) The output settings

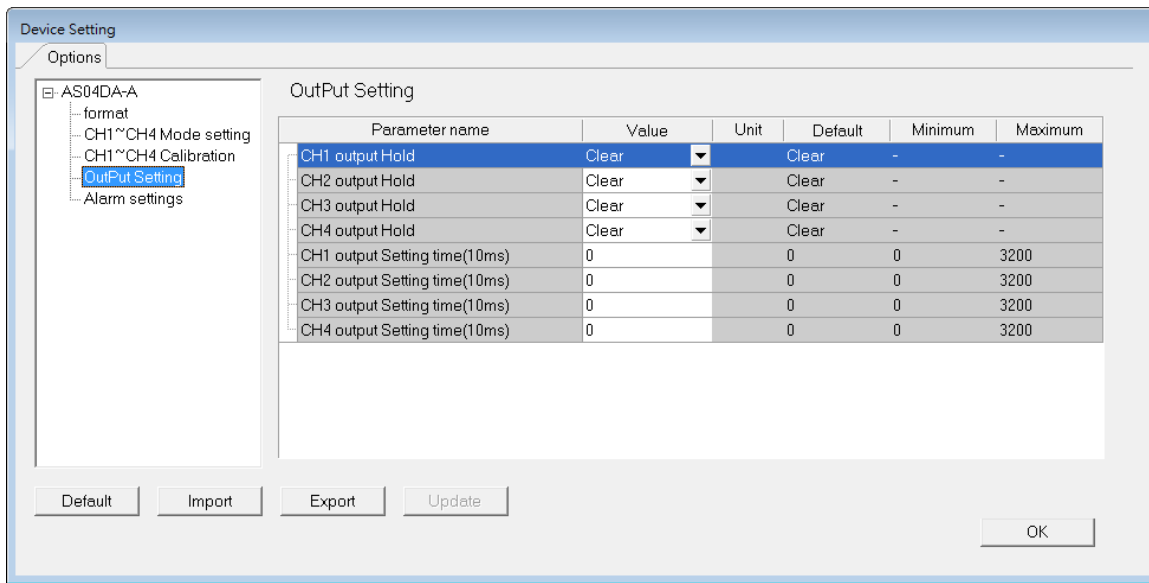

4

(5) The alarm settings

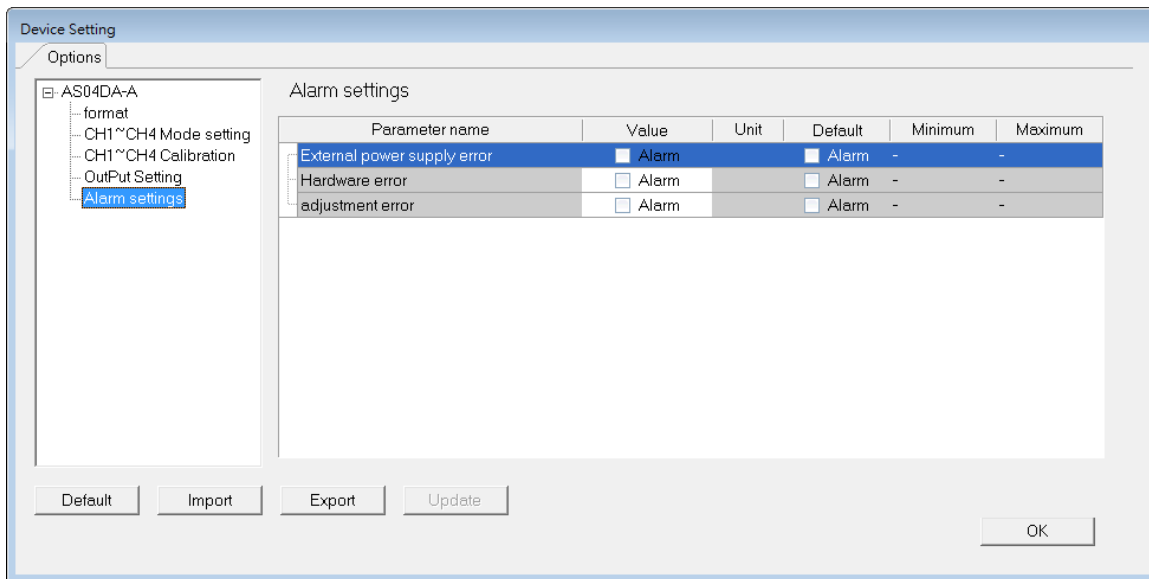

4.4 DIADesigner-AX (Hardware Configuration)

The following example uses AS04DA-A.

4.4.1 Initial Setting

- (1) Start DIADesigner-AX, click **New Project**, and then **Project+Device** to create a new project.

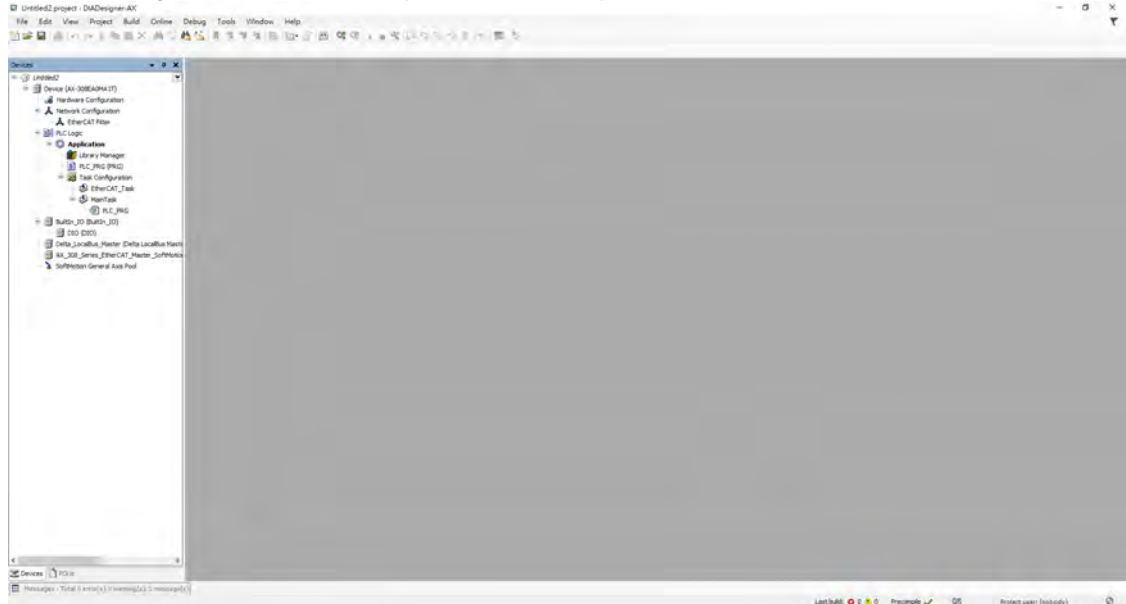

- (2) Add modules in:

- ① Double-click **Hardware Configuration**
- ② Select the **+** section and drag and drop the module that you want to add from the Product List to the **+** section.

or ③ Right-click **Delta_Localbus Master** to see the context menu and then double-click **Add Device** to add devices manually or double-click **Scan for Devices**.

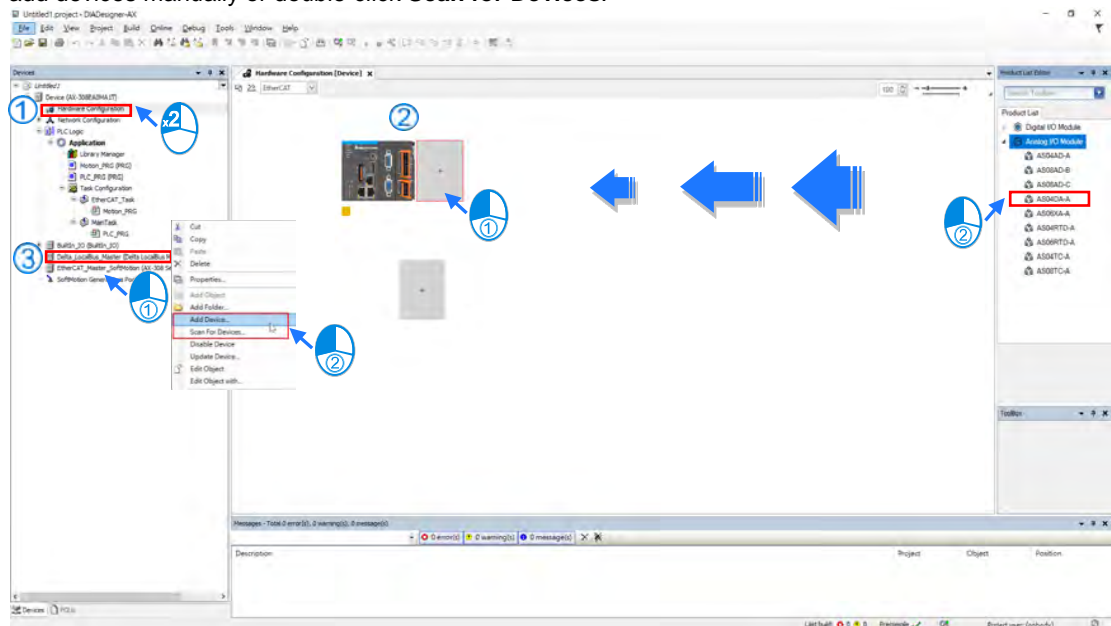

(3) Select modules:

- ① Double-click the module name in the **Hardware Configuration** area.
- or ② Double-click the module name shown in the node.

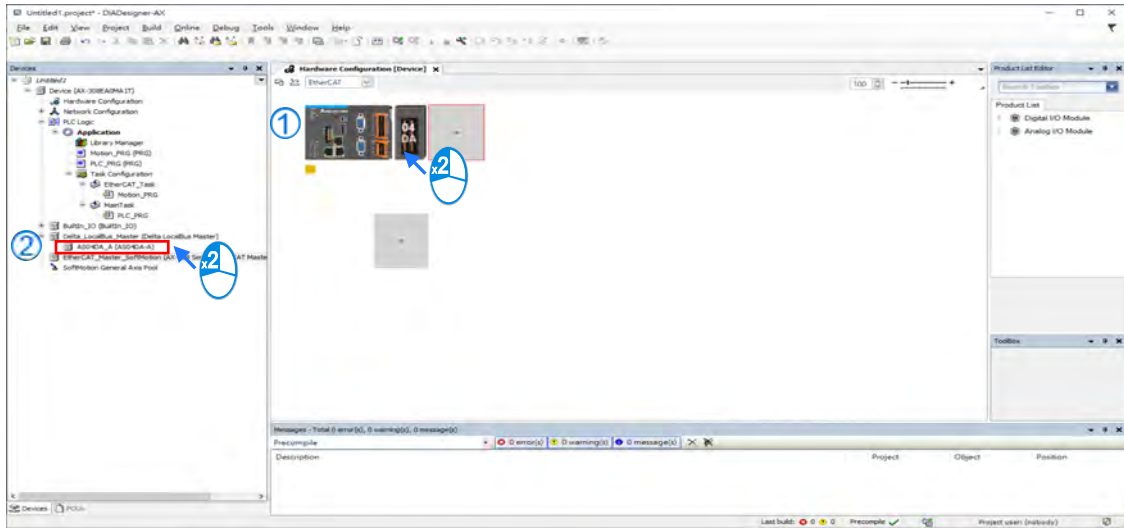

(4) Module parameter setting page:

Parameter	Type	Value	Defa...	Unit	Description
Format	Enumeration of UINT	Integer	Integer		
CH1~CH4 Mode Setting					
CH1 Mode Setting	Enumeration of WORD	-10V~...	-10V~...		
CH2 Mode Setting	Enumeration of WORD	-10V~...	-10V~...		
CH3 Mode Setting	Enumeration of WORD	-10V~...	-10V~...		
CH4 Mode Setting	Enumeration of WORD	-10V~...	-10V~...		
CH1~CH4 Calibration					
CH1 Cal. Offset (V/mA)	INT(-32768..32767)	0	0		
CH2 Cal. Offset (V/mA)	INT(-32768..32767)	0	0		
CH3 Cal. Offset (V/mA)	INT(-32768..32767)	0	0		
CH4 Cal. Offset (V/mA)	INT(-32768..32767)	0	0		
CH1 Cal. Gain	INT(-32768..32767)	1000	1000		
CH2 Cal. Gain	INT(-32768..32767)	1000	1000		
CH3 Cal. Gain	INT(-32768..32767)	1000	1000		
CH4 Cal. Gain	INT(-32768..32767)	1000	1000		
Output Setting					
CH1 Output Hold	Enumeration of WORD	Clear	Clear		
CH2 Output Hold	Enumeration of WORD	Clear	Clear		
CH3 Output Hold	Enumeration of WORD	Clear	Clear		
CH4 Output Hold	Enumeration of WORD	Clear	Clear		
CH1 Output Setting Time(10ms)	INT(0..3200)	0	0		
CH2 Output Setting Time(10ms)	INT(0..3200)	0	0		
CH3 Output Setting Time(10ms)	INT(0..3200)	0	0		
CH4 Output Setting Time(10ms)	INT(0..3200)	0	0		
Alarm Settings	WORD	0			
External Power Supply Error	BOOL	FALSE	FALSE		
Hardware Error	BOOL	FALSE	FALSE		
Adjustment Error	BOOL	FALSE	FALSE		
Module Revision	DWORD	0	0		Module Firmware Revision

- (5) After setting is complete, select the module and click **Login** on the tool bar to download the settings to the modules.

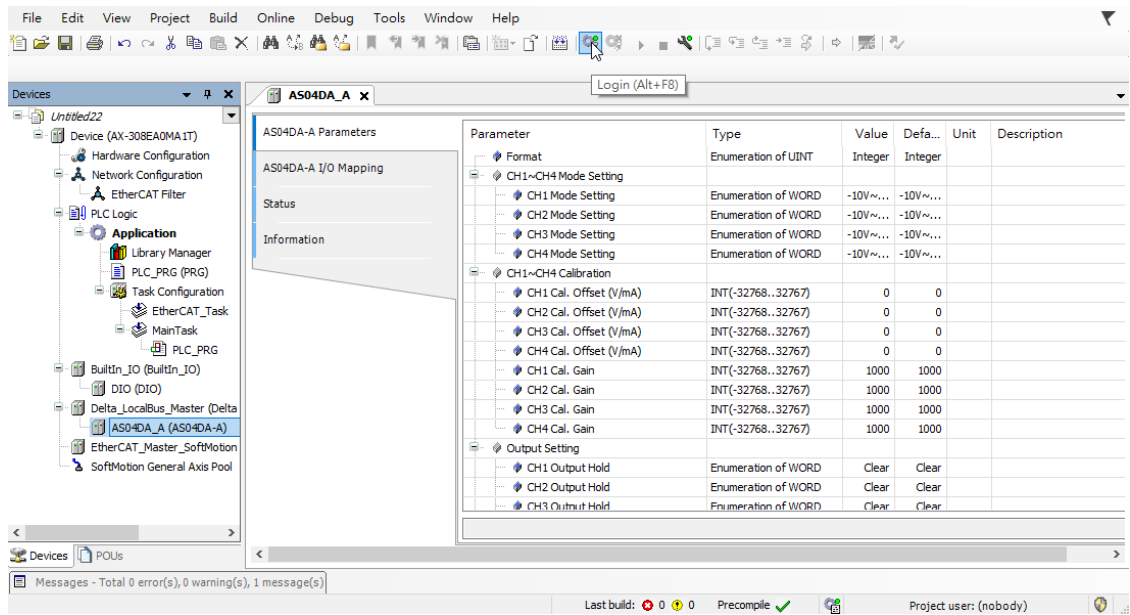

4.4.2 Checking the Version of a Module

- (1) Select the module and click the Information tab to see the module information.

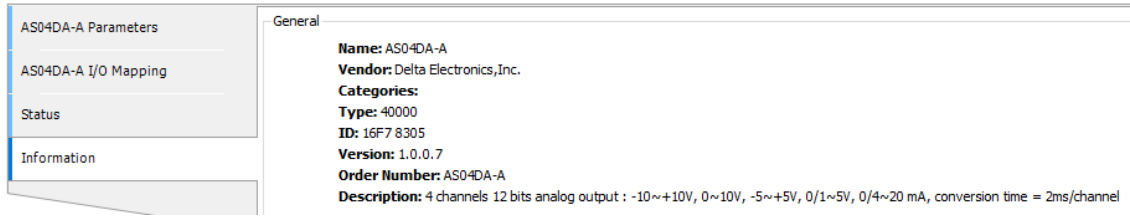

- (2) Select the module and click **Login** on the tool bar to go to Online Mode. You can find the Module Revision from the Parameters tab.

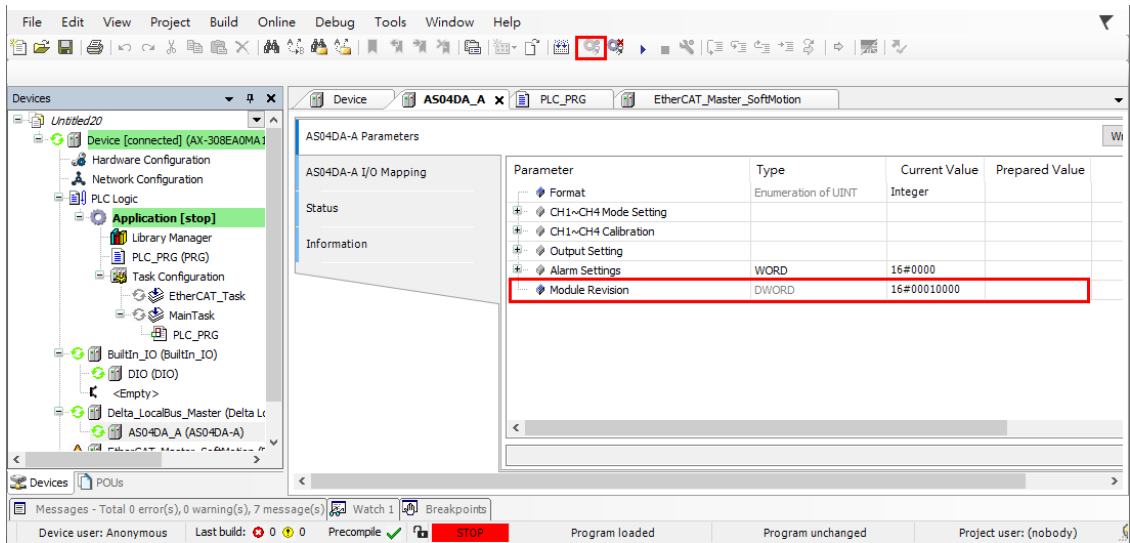

4.4.3 Online Mode

- (1) Select the module and click **Login** on the tool bar to go to **Online Mode**. You can monitor all configuration parameters. Values in the column of Prepared Value are configurable online. After editing the values in the Prepared Value column, click **Write Parameter** to confirm the change.

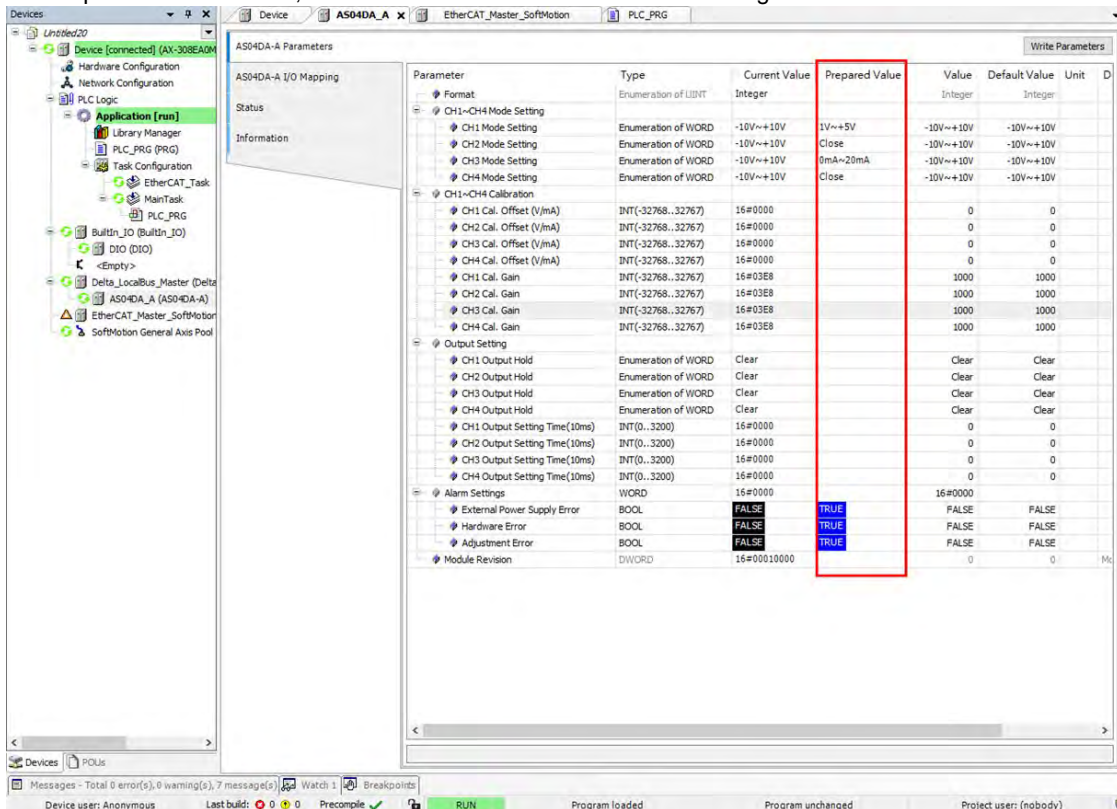

- (2) You can monitor the values, status, error codes in each channel from the I/O Mapping tab. You can also set a new value in the column of Prepared Value and press Ctrl+F7 on the keyboard to write the new values in.

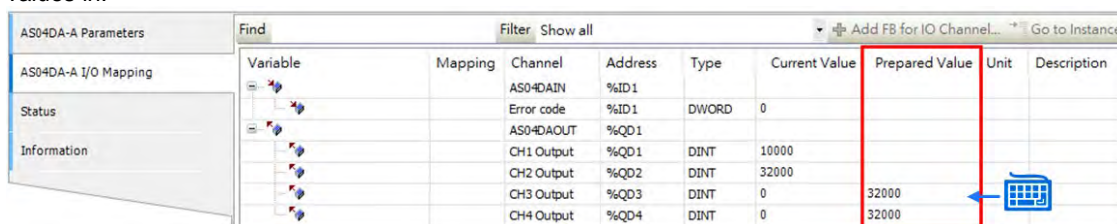

- (3) You can monitor the current status and error codes from the Status tab.

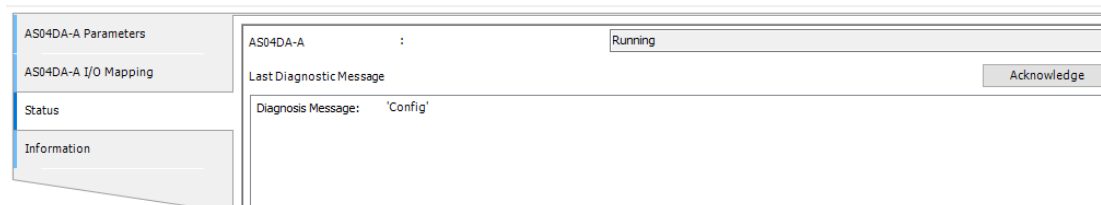

4.4.4 Parameters

(1) You can set up the value format to **Integer** or **Floating** for Channel 1 to 4.

Parameter	Type	Value	Default Value	Unit	Description
Format	Enumeration of UINT	Integer	Integer		
CH1~CH4 Mode Setting					
CH1 Mode Setting	Enumeration of WORD	-10V~+10V	Integer	V~+10V	
CH2 Mode Setting	Enumeration of WORD	-10V~+10V	Floating	V~+10V	
CH3 Mode Setting	Enumeration of WORD	-10V~+10V	-10V~+10V		
CH4 Mode Setting	Enumeration of WORD	-10V~+10V	-10V~+10V		

(2) You can set up the values for Channel 1 to 4.

Parameter	Type	Value	Default Value	Unit	Description
Format	Enumeration of UINT	Integer	Integer		
CH1~CH4 Mode Setting					
CH1 Mode Setting	Enumeration of WORD	-10V~+10V	-10V~+10V		
CH2 Mode Setting	Enumeration of WORD	Close	-10V~+10V		
CH3 Mode Setting	Enumeration of WORD	-10V~+10V 0V~+10V	-10V~+10V		
CH4 Mode Setting	Enumeration of WORD	-5V~+5V 0V~+5V	-10V~+10V		
CH1~CH4 Calibration					
CH1 Cal. Offset (V/mA)	INT(-32768..32767)	0mA~20mA 1V~+5V	0		
CH2 Cal. Offset (V/mA)	INT(-32768..32767)	4mA~20mA	0		
CH3 Cal. Offset (V/mA)	INT(-32768..32767)	-20mA~20mA	0		

(3) You can set up the calibrations for for Channel 1 to 4.

Parameter	Type	Value	Default Value	Unit	Description
CH1~CH4 Calibration					
CH1 Cal. Offset (V/mA)	INT(-32768..32767)	0	0		
CH2 Cal. Offset (V/mA)	INT(-32768..32767)	0	0		
CH3 Cal. Offset (V/mA)	INT(-32768..32767)	0	0		
CH4 Cal. Offset (V/mA)	INT(-32768..32767)	0	0		
CH1 Cal. Gain	INT(-32768..32767)	1000	1000		
CH2 Cal. Gain	INT(-32768..32767)	1000	1000		
CH3 Cal. Gain	INT(-32768..32767)	1000	1000		
CH4 Cal. Gain	INT(-32768..32767)	1000	1000		

(4) You can set up the average filtering for Channel 1 to 4.

Parameter	Type	Value	Default Value	Unit	Description
Average Filter					
CH1 Average Times	WORD(1..100)	10	10		
CH2 Average Times	WORD(1..100)	10	10		
CH3 Average Times	WORD(1..100)	10	10		
CH4 Average Times	WORD(1..100)	10	10		
CH1 Filter Proportion	Enumeration of WORD	10%	10%		
CH2 Filter Proportion	Enumeration of WORD	10%	10%		
CH3 Filter Proportion	Enumeration of WORD	10%	10%		
CH4 Filter Proportion	Enumeration of WORD	10%	10%		

(5) You can set up the sampling time.

Sampling Time				
sampling time	Enumeration of WORD	2ms	2ms	
Channel Detect and Alarm Settings	WORD	0		
CH1 Overage Detect	BOOL	FALSE	FALSE	
CH2 Overage Detect	BOOL	FALSE	FALSE	
CH3 Overage Detect	BOOL	FALSE	FALSE	
CH4 Overage Detect	BOOL	FALSE	FALSE	
Reserved	BOOL	FALSE	FALSE	
Reserved	BOOL	FALSE	FALSE	
Reserved	BOOL	FALSE	FALSE	

(6) You can set up the channel detect and alarm settings.

Channel Detect and Alarm Settings	WORD	0		
CH1 Overage Detect	BOOL	FALSE	FALSE	
CH2 Overage Detect	BOOL	FALSE	FALSE	
CH3 Overage Detect	BOOL	FALSE	FALSE	
CH4 Overage Detect	BOOL	FALSE	FALSE	
Reserved	BOOL	FALSE	FALSE	
Reserved	BOOL	FALSE	FALSE	
Reserved	BOOL	FALSE	FALSE	
Reserved	BOOL	FALSE	FALSE	
External Power Supply Error	BOOL	FALSE	FALSE	
Hardware Error	BOOL	FALSE	FALSE	
Adjustment Error	BOOL	FALSE	FALSE	

4.5 Troubleshooting

4.5.1 Error Codes

Error Code	Description	D → A LED Indicator	ERROR LED Indicator
16#1605	Hardware failure	OFF	ON
16#1607	The external voltage is abnormal.	OFF	ON
16#1608	The factory calibration is abnormal.	OFF	ON
16#1801	The external voltage is abnormal.	OFF	Blinking
16#1802	Hardware failure	OFF	Blinking
16#1804	The factory calibration is abnormal.	OFF	Blinking
-	When power-on, the module is not detected by CPU module.	OFF	Blinking once or twice and after 2 seconds, it blinks repeatedly

4.5.2 Troubleshooting Procedure

Description	Procedure
The external voltage is abnormal.	Ensure the external 24 V power supply to the module is functioning normally.
Hardware failure	Return the module to the factory for repair.
Internal error The factory calibration is abnormal.	Contact the factory.
When power-on, the module is not detected by CPU module.	Check if the connection between module and CPU module is working. If not, connect again.

Chapter 5 Analog Input/Output Module

AS06XA

Table of Contents

5.1 Overview	5-2
5.1.1 Characteristics	5-2
5.2 Specifications and Functions	5-3
5.2.1 Specifications	5-3
5.2.2 Profile	5-6
5.2.3 Arrangement of Terminals	5-7
5.2.4 Control Registers	5-8
5.2.5 Functions	5-13
5.2.6 Wiring	5-20
5.2.7 LED Indicators	5-22
5.3 HWCONFIG in ISPSOft	5-23
5.3.1 Initial Setting	5-23
5.3.2 Checking the Version of a Module	5-26
5.3.3 Online Mode	5-27
5.3.4 Importing/Exporting a Parameter File.....	5-28
5.3.5 Parameters	5-29
5.4 DIADesigner-AX (Hardware Configuration)	5-34
5.4.1 Initial Setting	5-34
5.4.2 Checking the Version of a Module	5-37
5.4.3 Online Mode	5-38
5.4.4 Parameters	5-39
5.5 Troubleshooting	5-41
5.5.1 Error Codes	5-41
5.5.2 Troubleshooting Procedure	5-42

5.1 Overview

This chapter describes the specifications for the analog input/output module, its operation, and its programming. On the analog input/output module, four channels receive analog signals (voltage or current), and converts those signals into 16-bit digital signals. In addition, the analog input/output module receives two blocks of 16-bit digital data from a CPU module, and converts the digital data into analog signals (voltage or current). The analog input/output module sends the analog signals by two channels. For software operation, ISPSOFT, DIADesigner or DIADesigner-AX is what you need. If you are using AS Series PLC CPU, refer to ISPSOFT User Manual or DIADesigner Manual for more information. The new software DIADesigner-AX only supports AX Series PLC CPU and AS Series modules now, refer to AX-3 User Manual for more information on software operation.

5.1.1 Characteristics

(1) **Use the AS06XA-A analog input/output module, based on its practical application.**

CH1–CH4: A channel can receive either voltage or current inputs.

CH5–CH6: A channel can send either voltage or current outputs.

(2) **High-speed conversion**

The conversion rate is 2 ms per channel. (For FW V1.02 or later, upgraded to 1 ms/channel)

(3) **High accuracy**

Conversion accuracy: At ambient temperature of 25° C.

Input: The error range for both voltage and current input is $\pm 0.2\%$.

Output: The error range for both voltage and current output is $\pm 0.02\%$.

(4) **Use the utility software to configure the module.**

The HWCONFIG utility software is built into ISPSOFT. You can set modes and parameters directly in HWCONFIG of ISPSOFT or Hardware Configuration of DIADesigner without spending time writing programs to set registers to manage functions.

5.2 Specifications and Functions

5.2.1 Specifications

- Electrical specifications

Module Name	AS06XA-A
Number of Analog Inputs/Outputs	4 inputs 2 outputs
Analog-to-Digital Conversion	Voltage input/Current input/Voltage output/Current output
Supply Voltage	24 VDC (20.4–28.8 VDC) (-15% to +20%)
Connector Type	Removable terminal block
Conversion Time	2ms/channel (FW V1.02 or later, upgraded to 1ms/channel)
Isolation	An analog circuit is isolated from a digital circuit by a digital integrated circuit/optocoupler, but the analog channels are not isolated from one another. Isolation between a digital circuit and the ground: 500 VAC Isolation between an analog circuit and the ground: 500 VAC Isolation between an analog circuit and a digital circuit: 500 VAC Isolation between the 24 VDC and the ground: 500 VAC
Weight	145 g

- Functional specifications for the analog-to-digital conversion

Analog-to-Digital Conversion	Voltage Input				
Rated Input Range	-10 V ~ +10 V	0 V ~ 10 V	±5 V	0 V ~ 5 V	1 V ~ 5 V
Rated Conversion Range	K-32000 ~ K32000	K0 ~ K32000	K-32000 ~ K32000	K0 ~ K32000	K0 ~ K32000
Hardware Input Limit* ¹	-10.12V ~ 10.12V	-0.12V ~ 10.12V	-5.06V ~ 5.06V	-0.06V ~ 5.06V	0.95V ~ 5.05V
Conversion Limit* ²	K-32384 ~ K32384	K-384 ~ K32384	K-32384 ~ K32384	K-384 ~ K32384	K-384 ~ K32384
Error Rate	Room Temperature: ±0.2% ; Full Temperature Range: ±0.5%				
Hardware Resolution	16 bits				
Input Impedance	2MΩ				
Absolute Input Range* ³	±15 V				

*1: If the input signal exceeds the hardware input limit, the module only shows the maximum value. If the input signal is below the lower limit, it only shows the minimum value.

*2: If the input signal exceeds the hardware input limit, it also exceeds the conversion limit and a conversion limit error appears. For example in the voltage input mode (-10 V to +10 V), when the input signal is 10.15 V, exceeding the hardware upper limit, it also exceeds the conversion upper limit. The module uses the upper limit value (32384) as the input signal and a conversion limit error appears.

*3: If an input signal exceeds the absolute range, it might damage the channel.

Analog-to-Digital Conversion	Current Input		
Rated Input Range	±20 mA	0 mA–20 mA	4 mA–20 mA
Rated Conversion Range	K-32000 ~ K+2000	K0 ~ K32000	K0 ~ K32000
Hardware Input Limit*1	-20.24 mA ~ 20.24 mA	-0.24 mA ~ 20.24 mA	3.81 mA ~ 20.19 mA
Conversion Limit*2	K-32384 ~ K32384	K-384 ~ K32384	K-384 ~ K32384
Error Rate	Room Temperature: ±0.2% ; Full Temperature Range: ±0.5%		
Hardware Resolution	16 bits		
Input Impedance	250Ω		
Absolute Input Range*3	±32 mA		

*1: If the input signal exceeds the hardware input limit, the module only shows the maximum value. If the input signal is below the lower limit, it only shows the minimum value.

*2: If the input signal exceeds the hardware input limit, it also exceeds the conversion limit and a conversion limit error appears. For example in the voltage input mode (4 mA to 20 mA), when the input signal is 0 mA, exceeding the hardware upper limit, it also exceeds the conversion upper limit. The module uses the upper limit value (-384) as the input signal and a conversion limit error appears.

*3: If an input signal exceeds the absolute range, it might damage the channel.

- Functional specifications for the digital-to-analog conversion

Digital-to-Analog Conversion	Voltage Output				
Rated Output Range	±10 V	0 ~ 10 V	±5 V	0 ~ 5 V	1 ~ 5 V
Conversion Range	K-32000 ~ K32000	K0 ~ K32000	K-32000 ~ K32000	K0 ~ K32000	K0 ~ K32000
Hardware Output Range	-10.1 V ~ +10.1 V	-0.1 V ~ 10.1 V	-5.05 V ~ +5.05 V	-0.05 V ~ +5.05 V	0.95 ~ 5.05 V
Error Rate (Room Temperature)	±0.2%				
Error Range (Full temperature range)	±0.5%				
Linearity Error (Room Temperature)	±0.05%				
Linearity Error (Full Temperature Range)	±0.05%				
Hardware Resolution	12 bits				
Permissible load impedance	≥1kΩ		≥500Ω		

Digital-to-Analog Conversion	Current Output	
Rated Output Range	0–20 mA	4–20 mA
Conversion Range	K0 ~ K32000	K0 ~ K32000
Hardware Output Range	-0.2 mA to 20.2 mA	3.8–20.2 mA
Error Range (Room Temperature)	±0.2%	
Error Range (Full Temperature Range)	±0.5%	
Linearity Error (Room Temperature)	±0.03%	
Linearity Error	±0.10%	

(Full Temperature Range)	
Hardware Resolution	12 bits
Permissible Load Impedance	$\leq 550 \Omega$

5.2.2 Profile

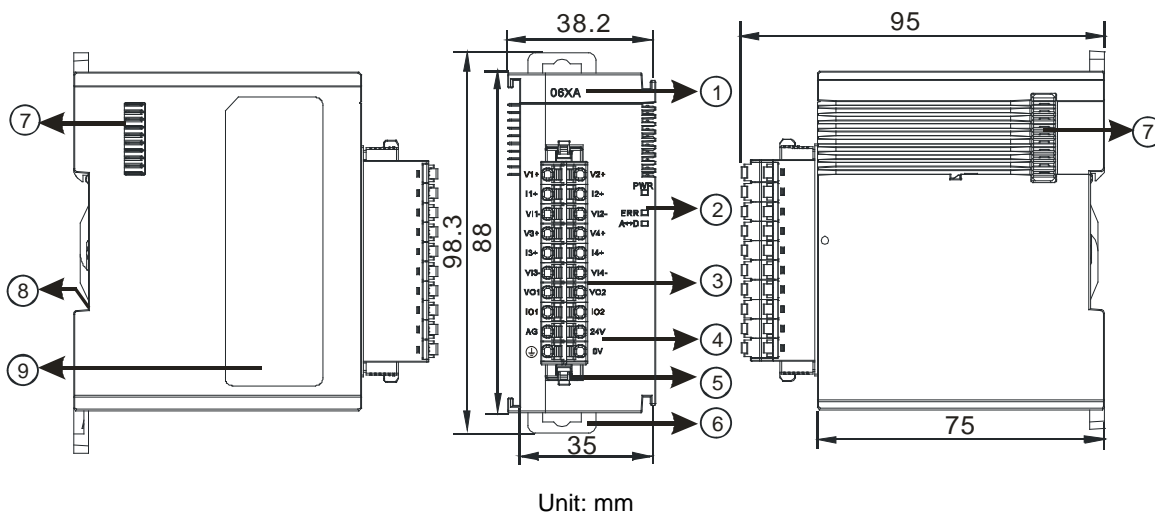

Unit: mm

Number	Name	Description
1	Model Name	Model name of the module
2	RUN LED Indicator	Operating status of the module ON: the module is running. OFF: the module is not running.
	ERROR LED Indicator	Error status of the module ON: a serious error exists in the module. OFF: the module is operating normally. Blink: a minor error exists in the module.
	Analog-to-Digital Conversion Indicator	Conversion status Blinking: conversion is in process. OFF: conversion has stopped.
3	Removable Terminal Block	Inputs are connected to transducers. Outputs are connected to loads to be driven.
4	Arrangement of the Input/Output Terminals	Arrangement of the terminals

Number	Name	Description
5	Clip	For removing the terminal block
6	DIN Rail Clip	Secures the module onto the DIN rail
7	Module Connecting Set	Connects the modules
8	Ground Clip	
9	Label	Nameplate

5.2.3 Arrangement of Terminals

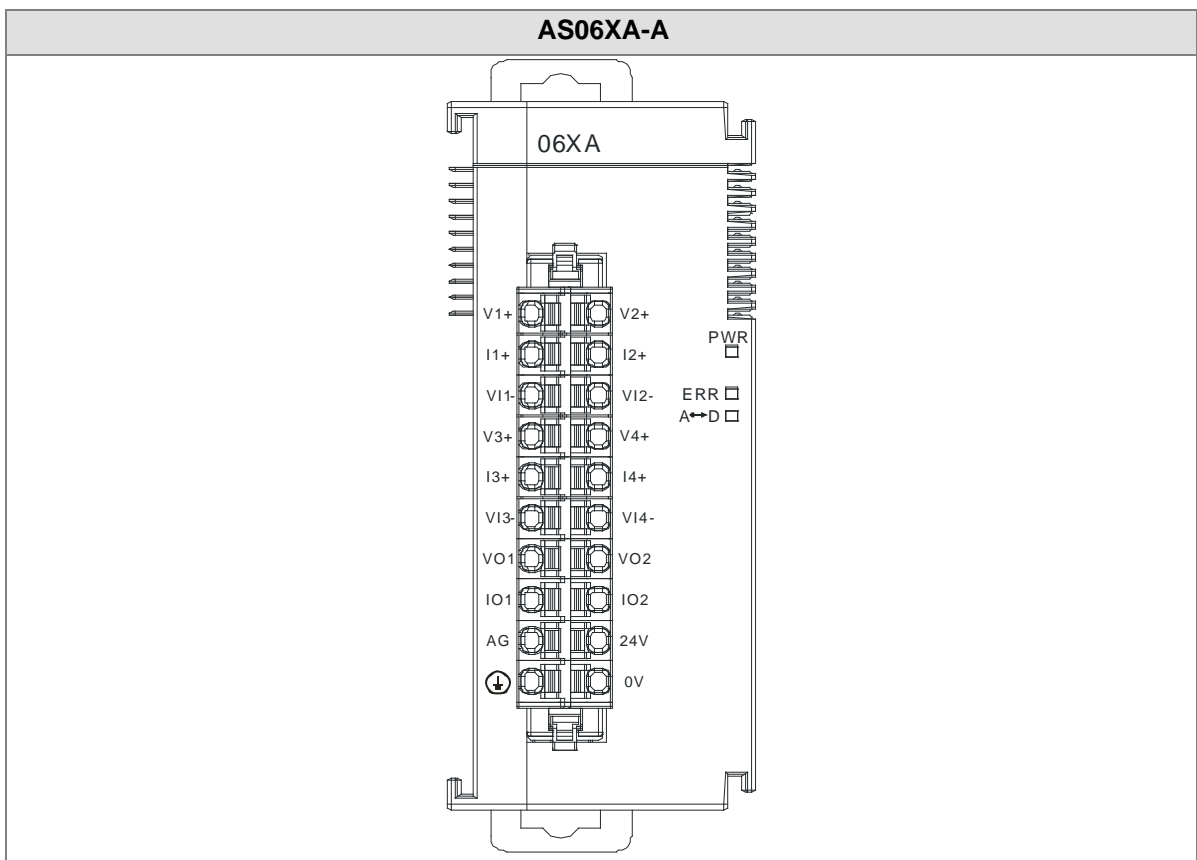

5.2.4 Control Registers

*If you use HWCONFIG to set values in CRs, once the set value is downloaded, the values can be retained in the module; however if you use TO instruction to write data into CRs, the values CANNOT be retained, after power failure or after transition of the CPU from STOP to RUN.

Note: The attribute of the CR must be W (write) to use TO instruction.

CR#	Name	Description	Atr.	Defaults
0	Format Setup	0: integer format 1: floating point format	R	0
1	Input channel 1 mode setup	0: closed 1: -10 V to +10 V (default)	R/W	1
2	Input channel 2 mode setup	2: 0–10 V 3: -5 to +5 V		
3	Input channel 3 mode setup	4: 0–5 V 5: 1–5 V		
4	Input channel 4 mode setup	6: 0–20 mA 7: 4–20 mA 8: -20 mA to +20 mA		
5	Input channel 1 offset	Range: -32768 to +32767	R/W	0
6	Input channel 2 offset			
7	Input channel 3 offset			
8	Input channel 4 offset			
9	Input channel 1 gain	Range: -32768 to +32767	R/W	1000
10	Input channel 2 gain			
11	Input channel 3 gain			
12	Input channel 4 gain			
13	Input channel 1 average times	Range: 1–100	R/W	10
14	Input channel 2 average times			
15	Input channel 3 average times			
16	Input channel 4 average times			
17	Input channel 1 filter		R/W	1

CR#	Name	Description	Atr.	Defaults
	average percentage			
18	Input channel 2 filter average percentage	Range: 0–3 Unit: $\pm 10\%$		
19	Input channel 3 filter average percentage	1: $\pm 10\%$ 2: $\pm 20\%$		
20	Input channel 4 filter average percentage	3: $\pm 30\%$		
21	Input channel sampling cycle (sampling/integration time)	0: 2 ms 1: 4 ms 2: 10 ms 3: 15 ms 4: 20 ms 5: 30 ms 6: 40 ms 7: 50 ms 8: 60 ms 9: 70 ms 10: 80 ms 11: 90 ms 12: 100 ms	R/W	0
22	Input channel alarm setup	0: open channel alarm 1: close channel alarm bit0: channel 1 bit1: channel 2 bit2: channel 3 bit3: channel 4 0: warning 1: alarm bit8: error in the power supply bit9: error in the module hardware bit10: error in calibration	R/W	0

CR#	Name	Description	Atr.	Defaults
23	Output channel 1 mode setup	0: closed 1: -10 V to +10 V (default) 2: 0–10 V 3: -5 V to +5 V	R/W	1
24	Output channel 2 mode setup	4: 0–5 V 5: 1–5 V 6: 0–20 mA 7: 4–20 mA		
25	Output channel 1 offset	Range: -32768 to +32767	R/W	0
26	Output channel 2 offset			
27	Output channel 1 gain	Range: -32768 to +32767	R/W	1000
28	Output channel 2 gain			
29	Retain the output sent by channel 1	0: When the PLC stops, the value of the analog output is reset to 0.	R/W	0
30	Retain the output sent by channel 2	1: When the PLC stops, the value of the analog output is retained.		
31	Refresh the time for output sent by channel 1	Range: 10–3200 (100 ms–32000 ms) Unit: 10 ms	R/W	0
32	Refreshing the time for an output sent by channel 2	Any value less than 10 is read as 0. Any value larger than 3200 is read as 3200. Set the value to 0 to disable this function.	R/W	0
33	The minimum scale range	When the format is set to integer in HWCONFIG, the scale range is invalid. For analog-digital modules, it is much more convenient if the system can convert digital values to floating-point values for earlier understanding. Here you can set the minimum and maximum scale ranges of corresponding floating-point values for channels. For example, if the scale range for an analog to digital input channel is ± 10.0 V, it indicates the maximum value is +10.0 V and the minimum value is -10.0 V.	R	-10.0
34	for input channel 1			
35	The minimum scale range			-10.0
36	for input channel 2			
37	The minimum scale range			-10.0
38	for input channel 3			
39	The minimum scale range			-10.0
40	for input channel 4			
41	The minimum scale range			-10.0
42	for output channel 1			
43	The minimum scale range	-10.0		
44	for output channel 2			

CR#	Name	Description	Atr.	Defaults		
45	The maximum scale range	If the scale range for an analog to digital input channel is 4 mA ~ 20 mA. It indicates the maximum value is 20 mA and the minimum value is 4 mA. Note: You can use PLC instruction DSCLP (API0217) and set SM685 to ON to use floating-point operations when a conversion range needs to edit.		10.0		
46	for input channel 1					
47	The maximum scale range			10.0		
48	for input channel 2					
49	The maximum scale range			10.0		
50	for input channel 3					
51	The maximum scale range			10.0		
52	for input channel 4					
53	The maximum scale range			10.0		
54	for output channel 1					
55	The maximum scale range			10.0		
56	for output channel 2					
201	Instruction Set			<p>Instructions for peak values</p> <p>16#0101: record the peak value again for channel 1</p> <p>16#0102: record the peak value again for channel 2</p> <p>16#0104: record the peak value again for channel 3</p> <p>16#0108: record the peak value again for channel 4</p> <p>16#010F: record the peak values again for channels 1–4</p> <p>16#0201: enable recording for channel 1</p> <p>16#0202: enable recording for channel 2</p> <p>16#0204: enable recording for channel 3</p> <p>16#0208: enable recording for channel 4</p> <p>16#020F: enable recording for channels 1–4</p> <p>16#0211: disable recording for channel 1</p> <p>16#0212: disable recording for channel 2</p> <p>16#0214: disable recording for channel 3</p> <p>16#0218: disable recording for channel 4</p> <p>16#021F: disable recording for channels 1–4</p> <p>16#0502: restore default settings</p>	W	0

CR#	Name	Description	Atr.	Defaults
210	The maximum peak value for channel 1	Integer format; the maximum peak value for analog inputs	R	-
211	The maximum peak value for channel 2			
212	The maximum peak value for channel 3			
213	The maximum peak value for channel 4			
214	The minimum peak value for channel 1	Integer format; the minimum peak value for analog inputs	R	-
215	The minimum peak value for channel 2			
216	The minimum peak value for channel 3			
217	The minimum peak value for channel 4			
222	The time to record for channel 1	Unit: 10 ms Range: 1–100 Time to record the digital value for the channels	R/W	1
223	The time to record for channel 2			
224	The time to record for channel 3			
225	The time to record for channel 4			
240	The number of records for channel 1	Range: 0–500, display the current records	R	0
241	The number of records for channel 2			
242	The number of records for channel 3			
243	The number of records for channel 4			
4000 ~4499	Records for channel 1	500 records for channel 1	R	-
4500 ~4999	Records for channel 2	500 records for channel 2		

CR#	Name	Description	Atr.	Defaults
5000 ~5499	Records for channel 3	500 records for channel 3		
5500 ~5999	Records for channel 4	500 records for channel 4		

5.2.5 Functions

Set modes of operation and parameters with HWCONFIG utility software built into ISPSOft.

- **Analog input**

Item	Function	Description
1	Enable/Disable a Channel	1. Enable or disable a channel. 2. If a channel is disabled, the total conversion time decreases.
2	Calibration	Calibrate a linear curve.
3	Average	Conversion values are averaged and filtered.
4	Disconnection Detection	Disconnection detection only operates when the analog range is 4–20 mA or 1–5 V.
5	Channel Detect and Alarm	If an input signal exceeds the range of inputs that the hardware can receive, the module produces an alarm or a warning. You can disable this function.
6	Limit Detections for Channels	Save the maximum/minimum values for channels
7	Records for Channels	Save the analog curves for channels.
8	Scale Range	When the format is floating-point, you can set the scale range.

1. Enable/Disable a Channel

An analog signal is converted into a digital signal at a rate of 2 ms per channel. The total conversion time is 2 ms X (the number of channels). For firmware V1.02 or later, an analog signal is converted into a digital signal at a rate of 1 ms per channel. The total conversion time is 1 ms X (the number of channels). If a channel is not used, you can disable it to decrease the total conversion time.

2. Calibration

To make a curve meet specific needs, calibrate the curve by changing the offset and the gain. The calibration range depends on the range of inputs which can be received by the hardware. The formula is:

$$Output = \frac{(Input \times Gain)}{1000} + Offset$$

Example:

A channel receives voltage inputs between -10.0 V to +10.0 V. The gain is 1000, and the offset is 0. The corresponding value for the original signal -10.0 V to +10.0 V is -32000 to +32000. If you change the offset to -100, the calibrated value for the original signal -10.0 V to +10.0 V becomes -31900 to +32100. When the input voltage is 0 V, the digital value becomes -100. When the input voltage is 10.0 V, the digital value becomes 32100.

Gain = 1000, Offset = -100

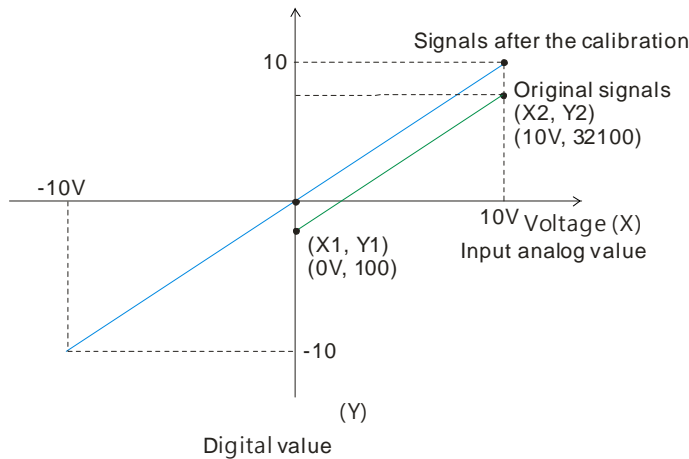

3. Average

You can set the average value between 1–100. It is a steady value obtained from the sum of the recorded values. If the recorded values include an acute pulse due to unavoidable external factors, however, you may observe violent changes in the average value. Use the filtering function to exclude acute pulses from the sum-up and equalization, so the computed average value is not affected by the acute recorded values. Set the filter percentage to the range 0–3, where the unit is 10%. If you set the filter range to 0, the system sums up all the recorded values and divides them to obtain the average value, but if you set the filter range to 1, for example, the system excludes the bottom 10% and the top 10% of the values and averages only the remaining values to get the average value. For instance, set the average value to 100 and set the filter percentage to 3. When there are 100 pieces of data collected, the system arranges the collected data according to their values from large to small and then excludes the bottom 30% and top 30% of the values (60 pieces of data) and averages only the remaining values (40 pieces of data) to obtain the average value.

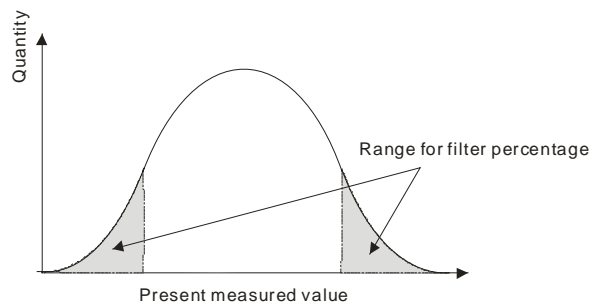

4. Disconnection detection

Disconnection detection only operates when the analog range is 4–20 mA or 1–5 V. If a module which can receive inputs between 4–20 mA or between 1–5 V is disconnected, the input signal exceeds the range of allowable inputs, so the module produces an alarm or a warning.

5. Channel Detection

If an input signal exceeds the allowable range of inputs, an error message appears. You can disable this function so that the module does not produce an alarm or a warning when the input signal exceeds the input range.

6. Limit detections for channels

This function saves the maximum and minimum values for channels so that you can determine the peak to peak values.

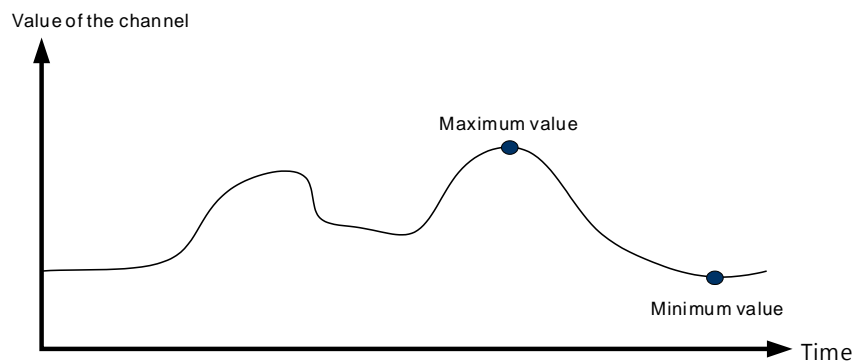

7. Records for Channels

Record the input values of the cyclic sampling for each channel. The system saves up to 500 data points and the recording time is 10 ms.

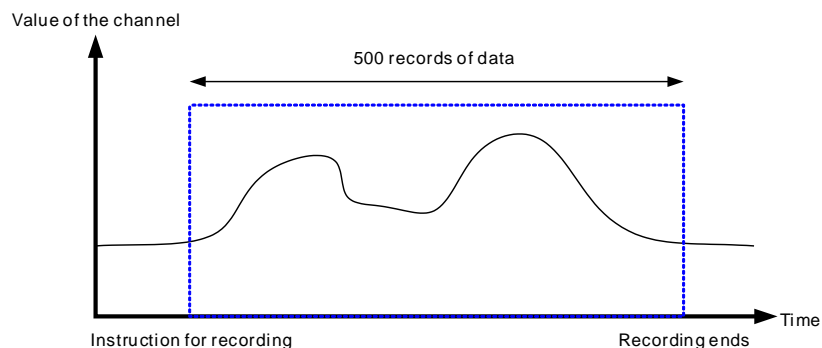

8. Scale range

When the format is floating-point, you can set the scale range. The analog output mode of a channel has a corresponding digital range. Digital values correspond to analog outputs sent by the module. For example, if the analog range is -10 V to +10 V, the digital range is -10.0 to +10.0, the HSP scale is 10.0, and the LSP scale is -10.0. The digital values -10.0 to +10.0 correspond to the analog values -10 V to +10 V, as the example below shows.

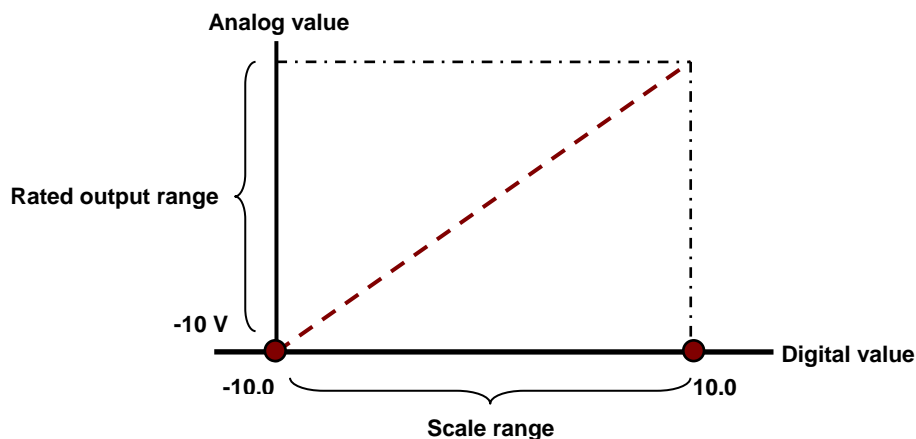

● Analog Output

Item	Function	Description
①	Enable/Disable a Channel	1. Enable or disable a channel. 2. If a channel is disabled, the total conversion time decreases.
②	Calibration	Calibrate a linear curve.
③	Retain an Output	When a module stops running, the system retains the signal sent by the module.
④	Refresh Time for an Output	Refresh the analog output value according to the value of the fixed slope.
⑤	Scale Range	You can set the scale range when the format is floating-point.

① Enable/Disable a Channel

An analog signal is converted into a digital signal at a rate of 2 ms per channel. The total conversion time is 2 ms X (the number of channels). For firmware V1.02 or later, an analog signal is converted into a digital signal at a rate of 1 ms per channel. The total conversion time is 1 ms X (the number of channels). If a channel is not used, you can disable it to decrease the total conversion time.

② Calibration

To make a curve meet specific needs, calibrate the curve by changing the offset and the gain. The calibration range depends on the range of inputs which can be received by the hardware. The formula is:

$$\text{Output} = \frac{(\text{Input} \times \text{Gain})}{1000} + \text{Offset}$$

Example:

A channel receives voltage inputs between -10.0 V to +10.0 V. The gain is 1000, and the offset is 0. The corresponding value for the original signal -10.0 V to +10.0 V is -32000 to +32000. If you change the offset to 200 and the gain to 1000, the calibrated value for the original signal -10.0 V to +10.0 V is -31800 to +32200.

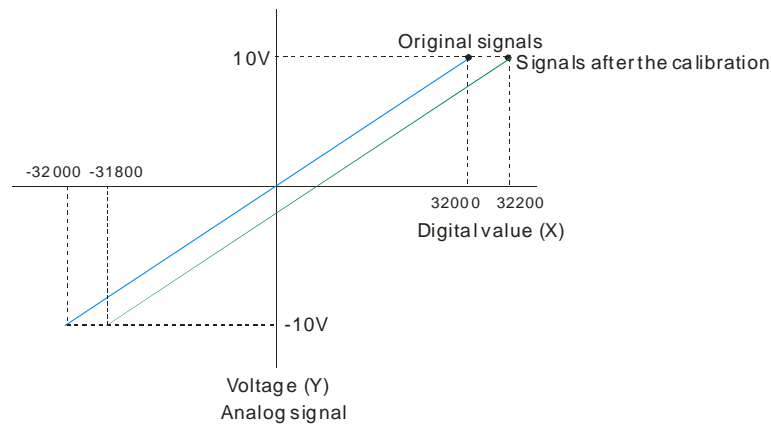

③ Retain an Output

When a module stops running, the system retains the signal sent by the module.

The output is not retained:

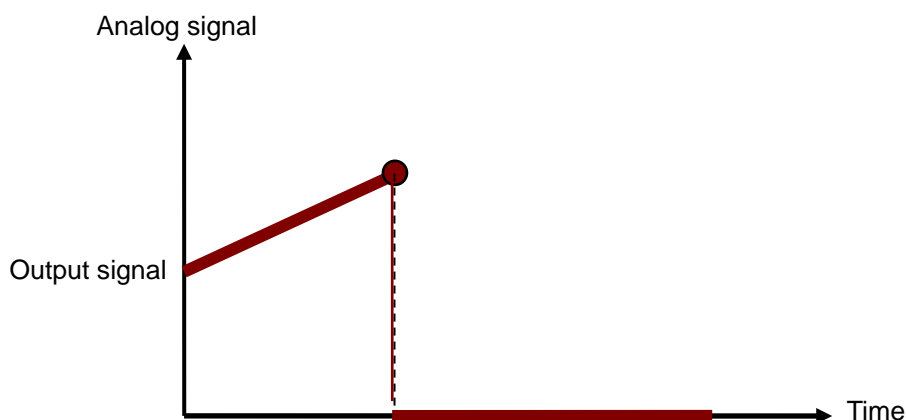

④ Refresh Time for an Output

Set the refresh time for an output and the system updates the value of the slope (m) accordingly.

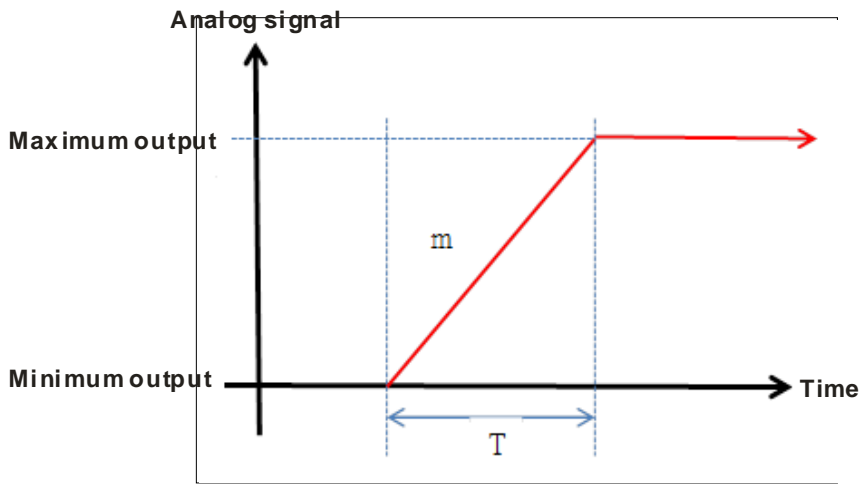

When the analog output signal changes, the system updates the value of the analog output according to the value set in the slope, as shown in the image below.

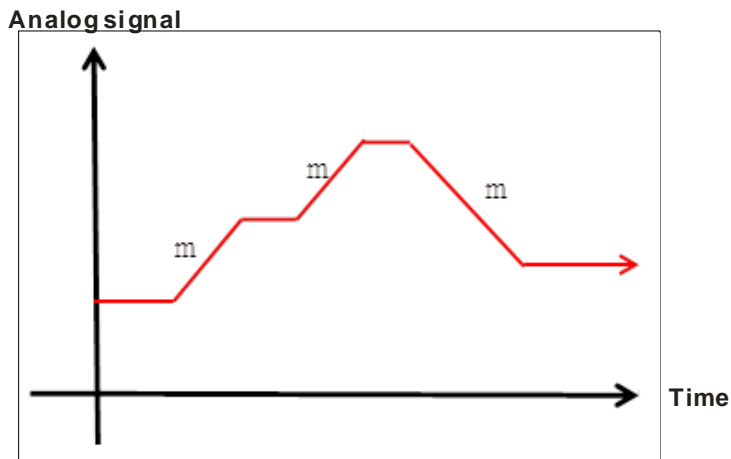

*The output conversion time and the input channel sampling cycle are the same.

⑤ Scale Range

You can set the scale range when the format is floating-point. The analog output mode of a channel has a corresponding digital range. Digital values correspond to analog outputs sent by the module. For example, if the analog range is -10 V to +10 V, the digital range is -10.0 to +10.0, the HSP scale is 10.0, and the LSP scale is -10.0. The digital values -10.0 to +10.0 correspond to the analog values -10 V to +10 V, as the example below shows.

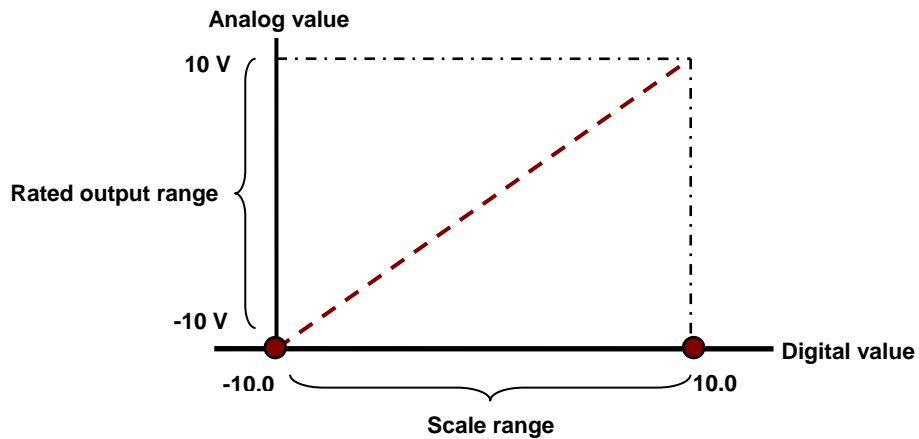

5.2.6 Wiring

● Precautions

To ensure the analog-to-digital module functions well and reliably, the external wiring must prevent noise. Before you install the cables, follow the precautions below.

- (1) To prevent a surge and induction, the AC cable and the input signal cables that are connected to the AS06XA-A must be separate cables.
- (2) Do not install the cable near a main circuit, a high-voltage cable, or a cable connected to a load that is not a PLC. In addition, the cable must not be bound to a main circuit, a high-voltage cable, or a cable connected to a load which is not a PLC.
- (3) Ground shielded cables and hermetically sealed cables separately.
- (4) Terminals with insulation sleeves cannot be arranged as a terminal block, so you should cover the terminals with insulation tubes.
- (5) Use single-core cables or twin-core cables with a diameter of 24–22 AWG and with pin-type connectors smaller than 1 mm. Only use copper conducting wires which can withstand temperatures of 60° C /75° C or higher.

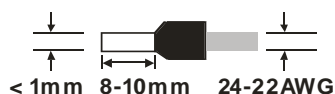

- (6) Note: use cables with the same length (less than 200 m) and use wire resistance of less than 100 ohm.
- (7) Notes on two-wire, three-wire, and four-wire connections:
 - Two-wire connection/three-wire connection (passive transducer): connect the transducer and the analog input module to the same power circuit.
 - Four-wire connection (active transducer): the transducer uses an independent power supply, so do not connect it to the same power circuit as the analog input module.

● External wiring

(1) AS06XA-A

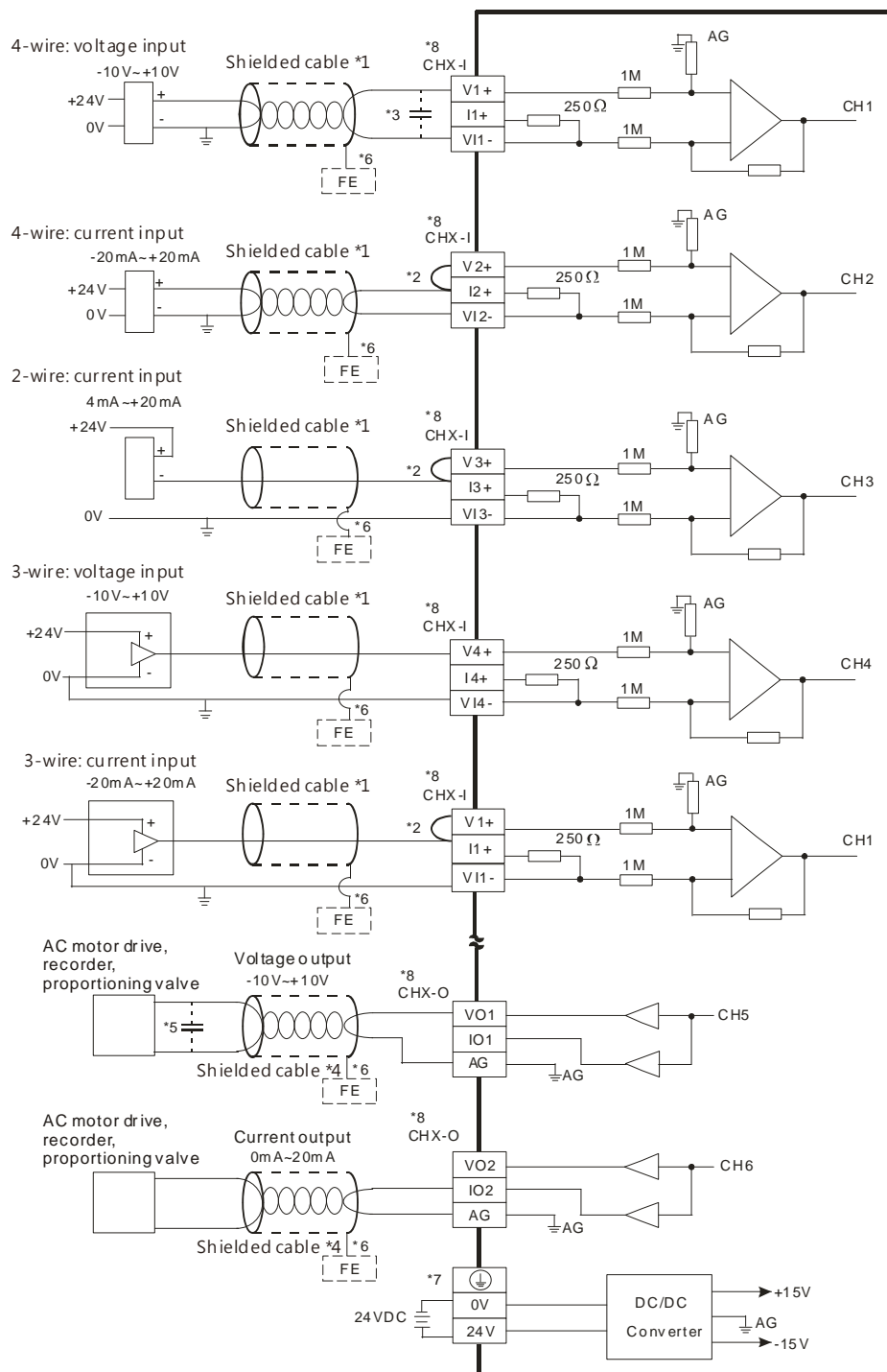

*1. Use shielded cables to isolate the analog input signal cable from other power cables.

*2. If the module is connected to a current signal, the terminals Vn and In+ (n=1-4) must be short-circuited.

*3. If variability in the input voltage results in interference within the wiring, connect the module to a capacitor having a capacitance between 0.1-0.47 μF and a working voltage of 25 V.

*4. Connect the shielded cable to the terminal FE and to the ground terminal.

*5. Connect the terminal  to the ground terminal.

*6. The wording "CHX-I" indicates that you can use those five wiring methods for every input channel. The wording "CHX-O" indicates that you can use those two wiring methods for every output channel.

5.2.7 LED Indicators

Number	Name	Description
1	RUN LED Indicator	Operating status of the module ON: the module is running. OFF: the module is not running.
2	ERROR LED Indicator	Error status of the module ON: a serious error exists in the module. OFF: the module is operating normally. Blink: a minor error exists in the module.
3	Analog-to-Digital Conversion Indicator	Conversion status Blinking: conversion is in process. OFF: conversion has stopped.

5.3 HWCONFIG in ISPSOft

5.3.1 Initial Setting

- (1) Start ISPSOft and double-click **HWCONFIG**.

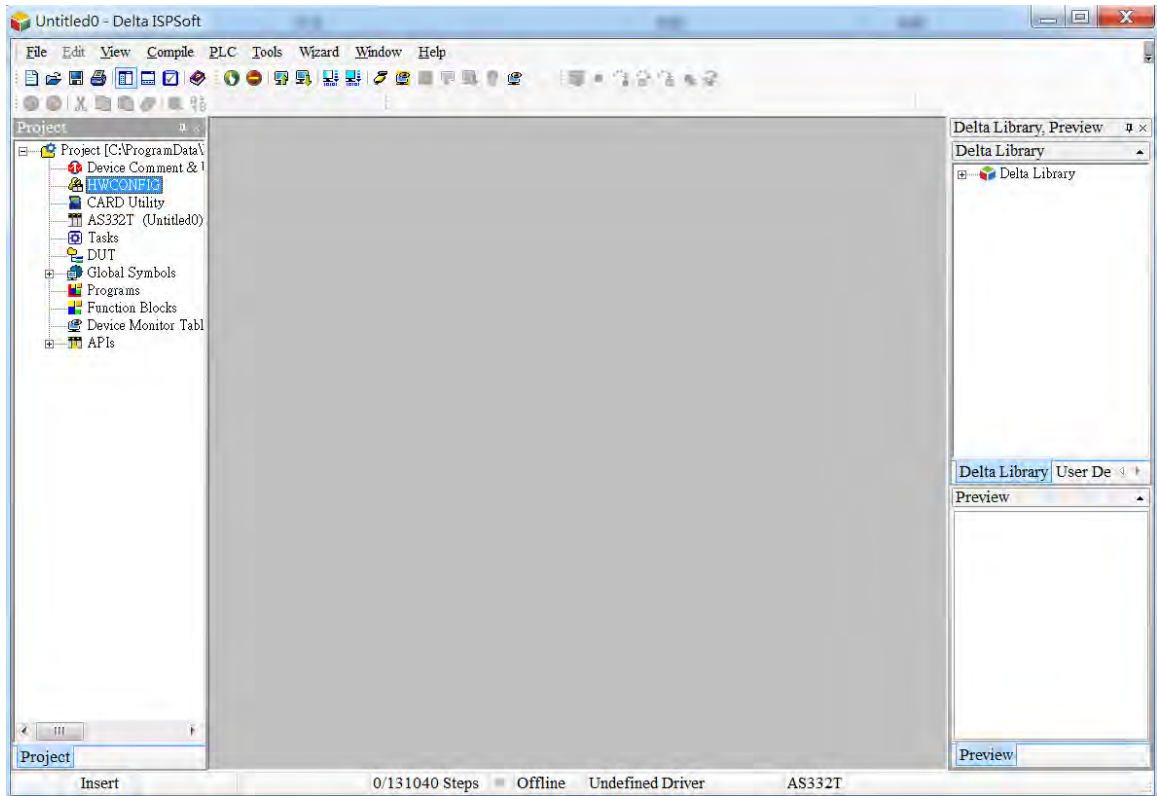

- (2) Select a module and drag it to the working area.

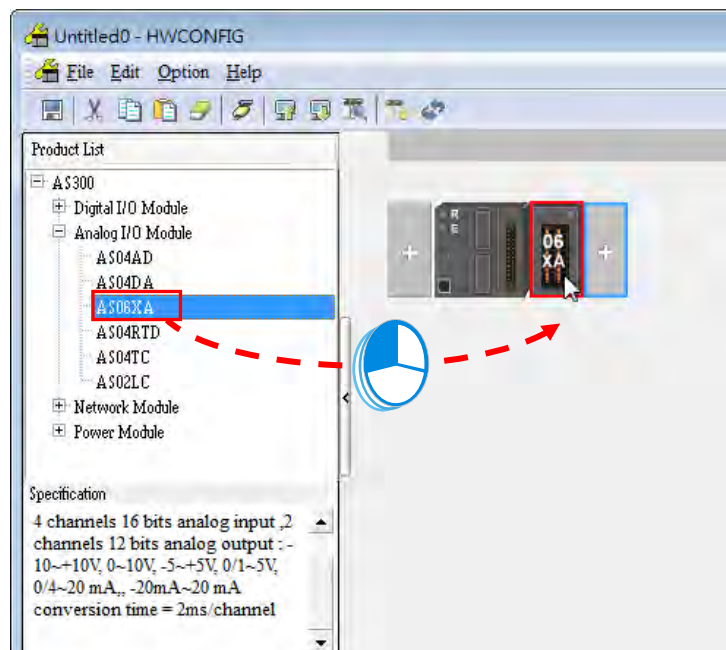

(3) Double-click the module in the working area to open the Device Setting page.

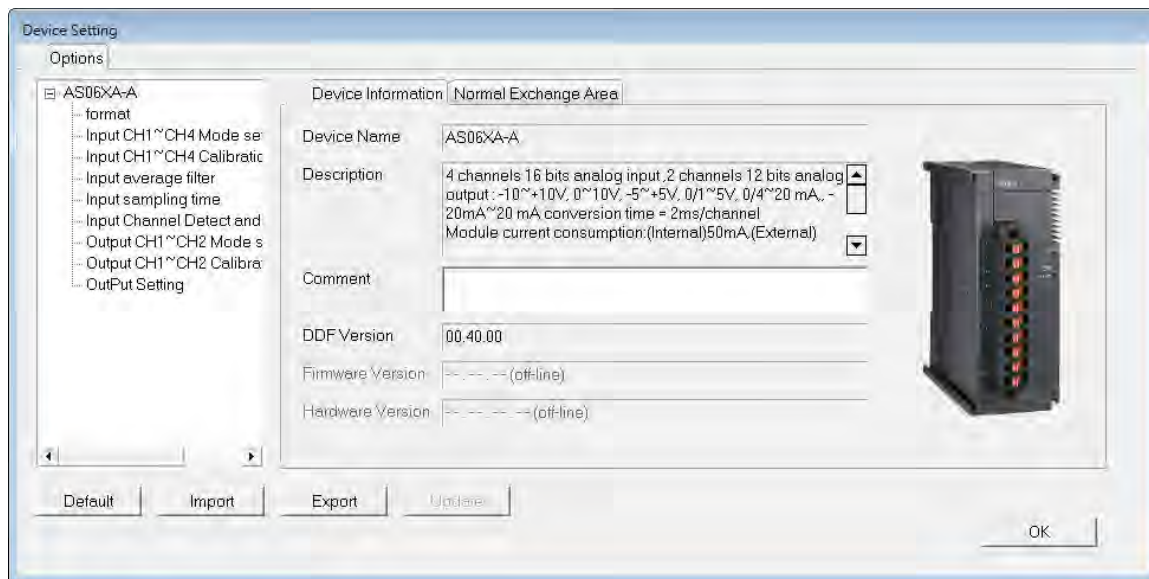
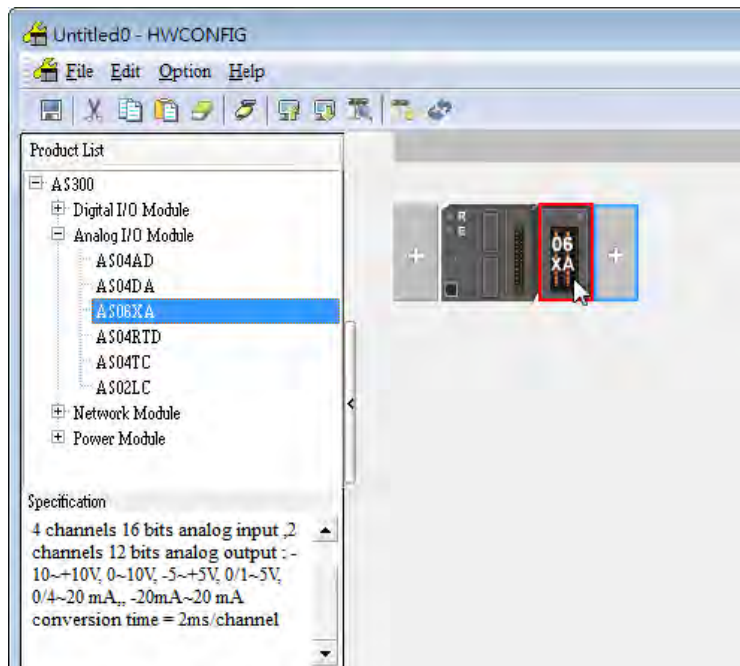

- (4) Choose the parameter, set the values, and click **OK**.

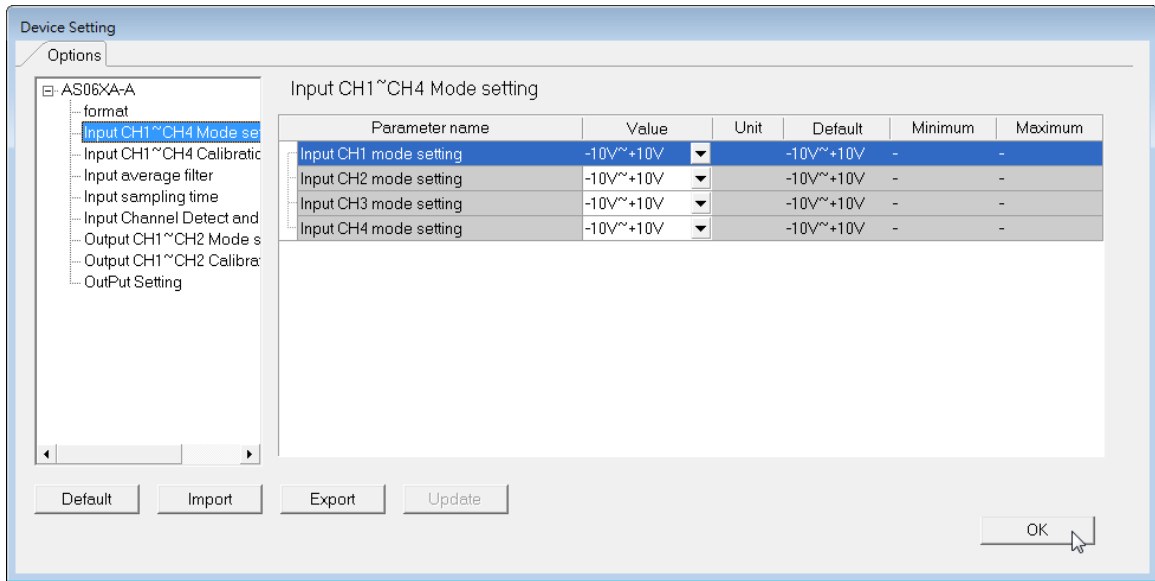

- (5) Click **Download** on the toolbar to download the parameters. Note that you cannot download the parameters while the CPU module is running.

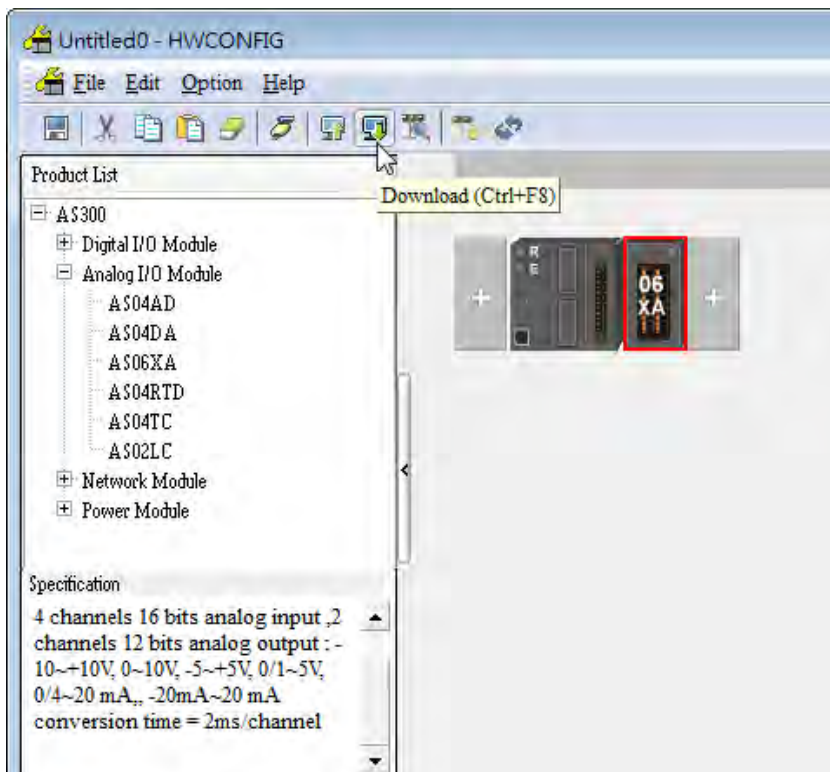

5.3.2 Checking the Version of a Module

- (1) On the **Option** menu, click **Online Mode**.

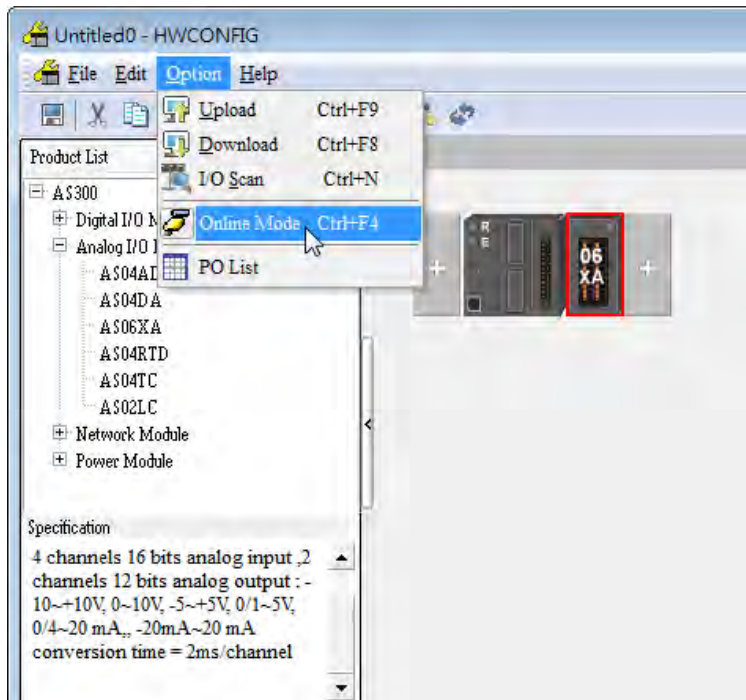

- (2) Double-click the module to open the Device Setting page. The versions of both the firmware and the hardware are displayed.

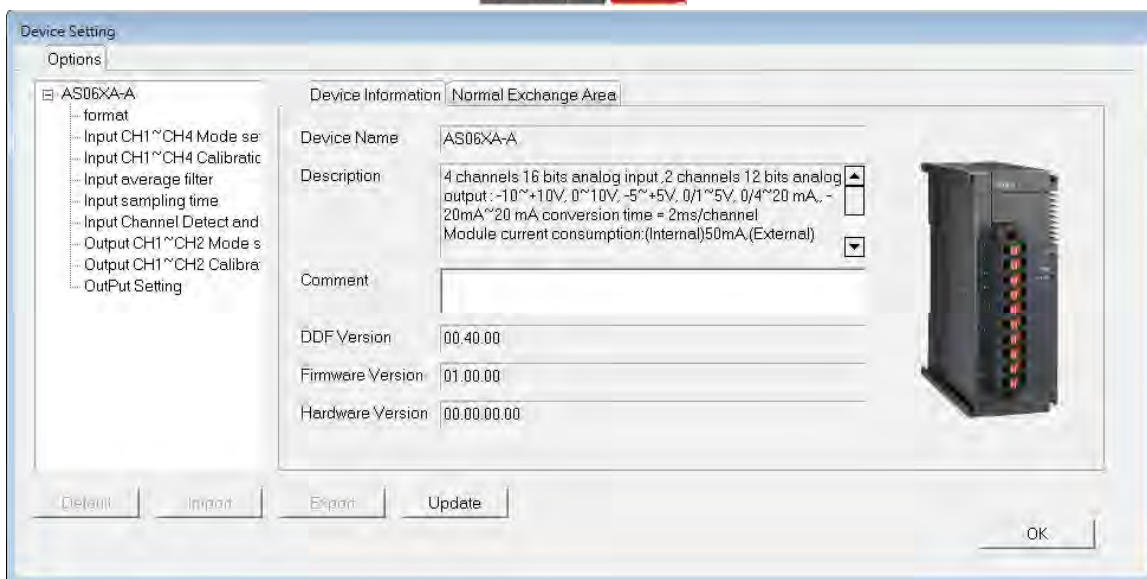

5.3.3 Online Mode

- (1) On the **Option** menu, click **Online Mode**.

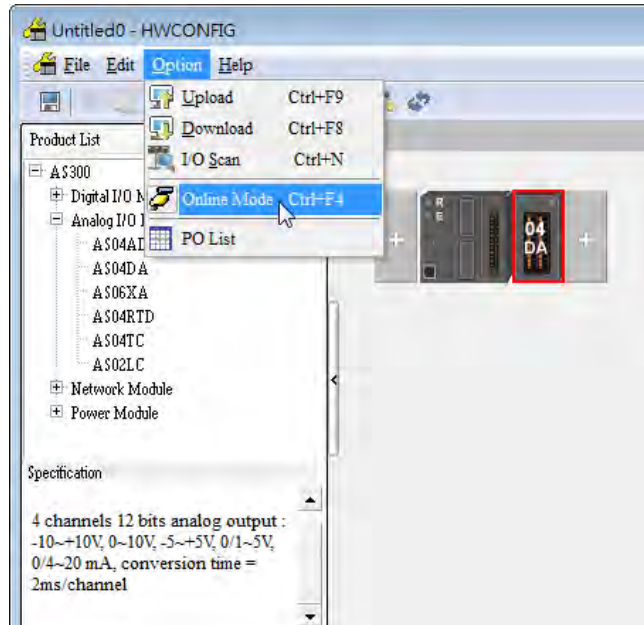

- (2) Right-click the module and click **Module Status**.

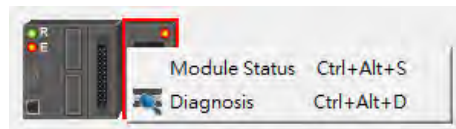

- (3) View the module status.

Channel	Value (32 bits)	Data Type
Error code	6145	DECIMAL
CH1 Input	0	DECIMAL
CH2 Input	0	DECIMAL
CH3 Input	0	DECIMAL
CH4 Input	0	DECIMAL
CH1 Output	0	DECIMAL
CH2 Output	0	DECIMAL

5.3.4 Importing/Exporting a Parameter File

(1) Click **Export** in the Device Settings dialog box to save the current parameters as a CSV file (.csv).

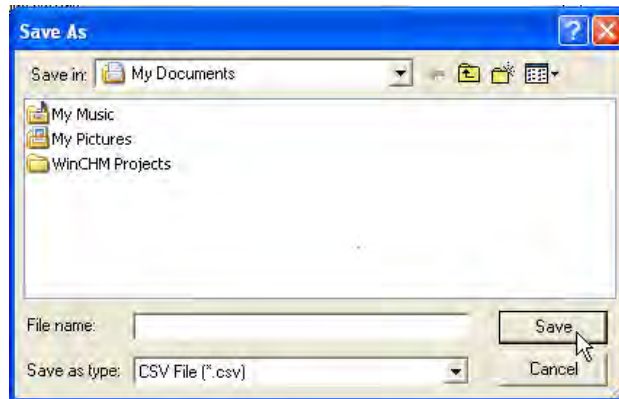

(2) Click **Import** in the Device Settings dialog box and select a CSV file to import saved parameters.

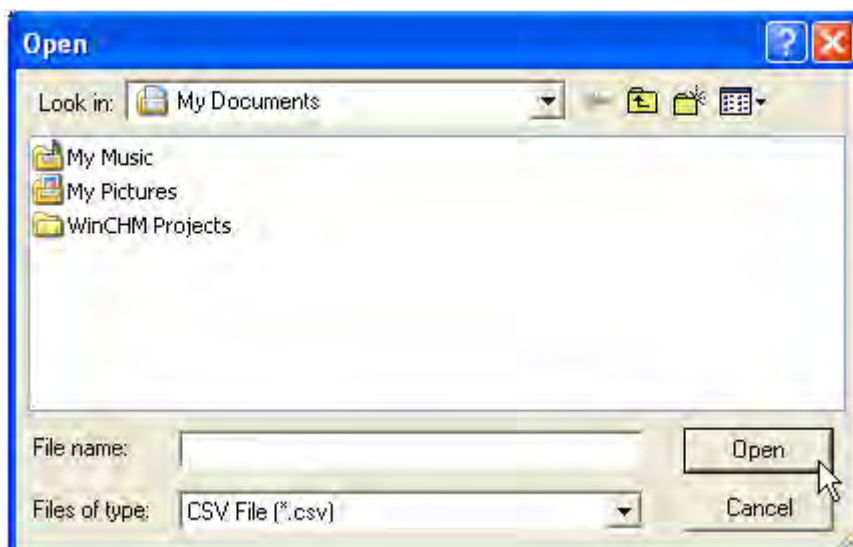

5.3.5 Parameters

(1) The input modes of the channels

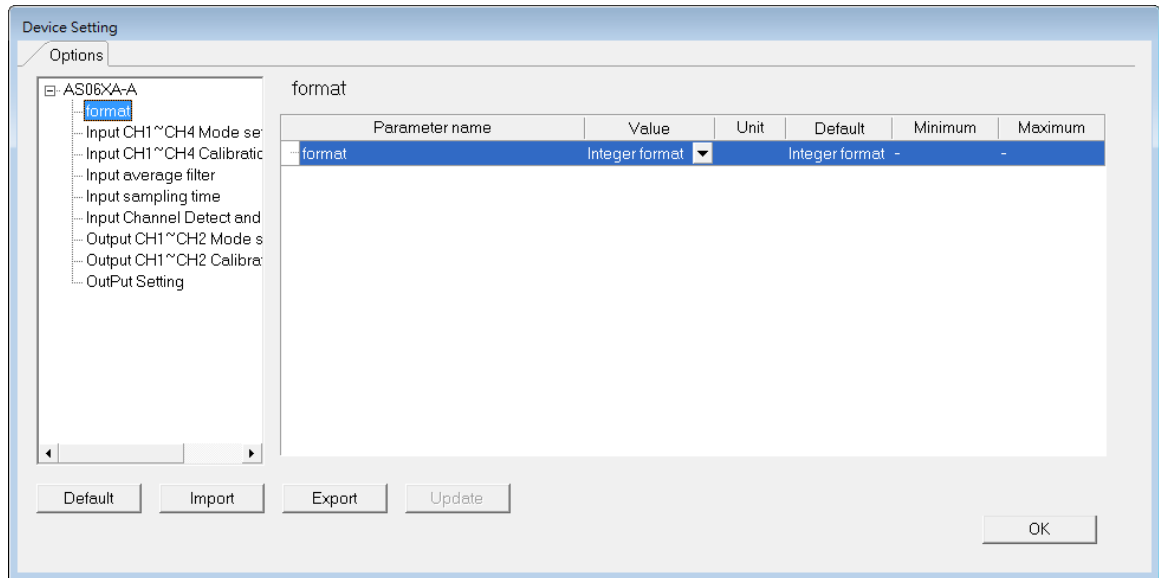

(2) Input CH1-CH4 (channel 1-channel 4) mode settings

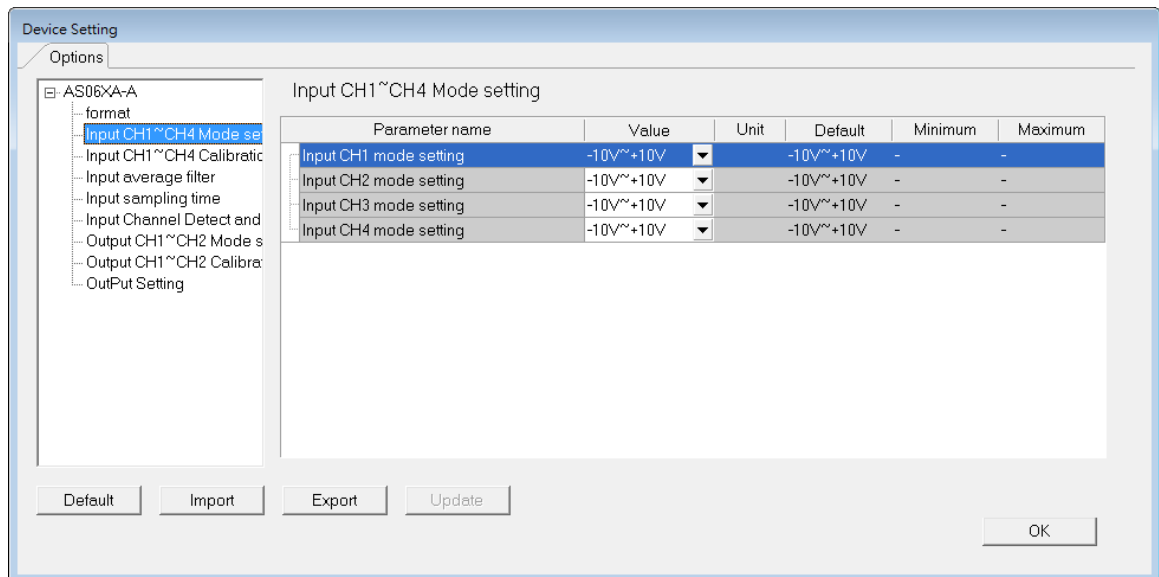

(3) Input CH1-CH4 calibration

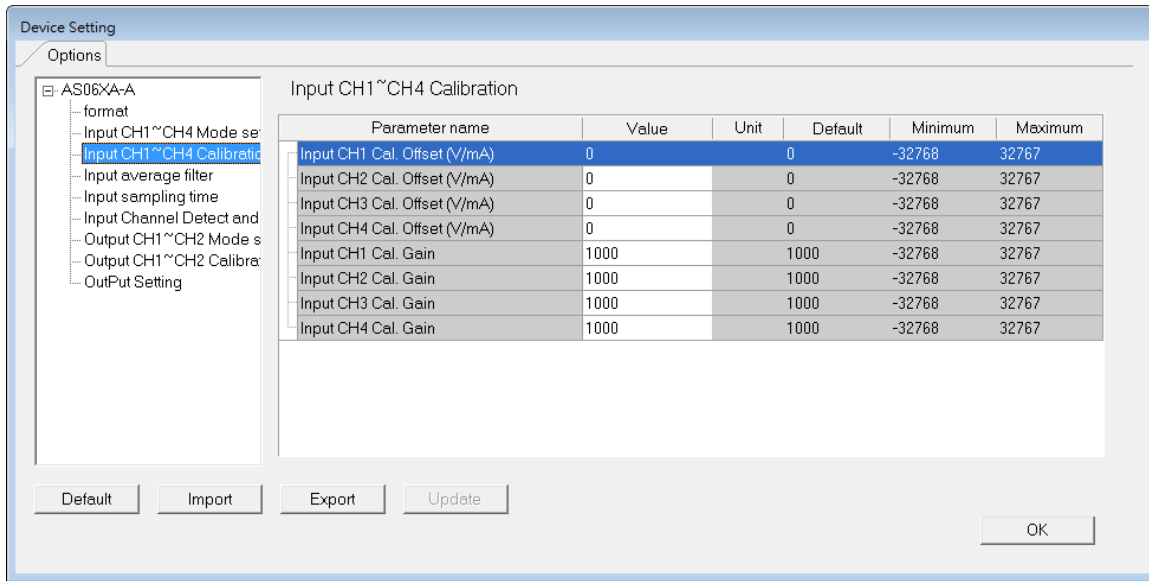

(4) Input average filter

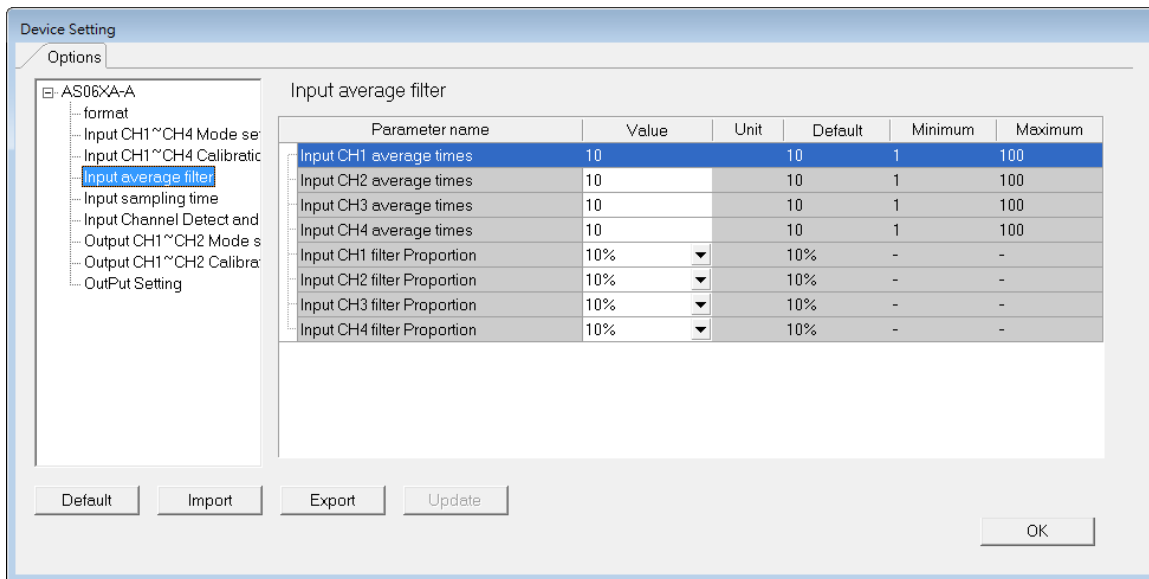

(5) Input sampling time

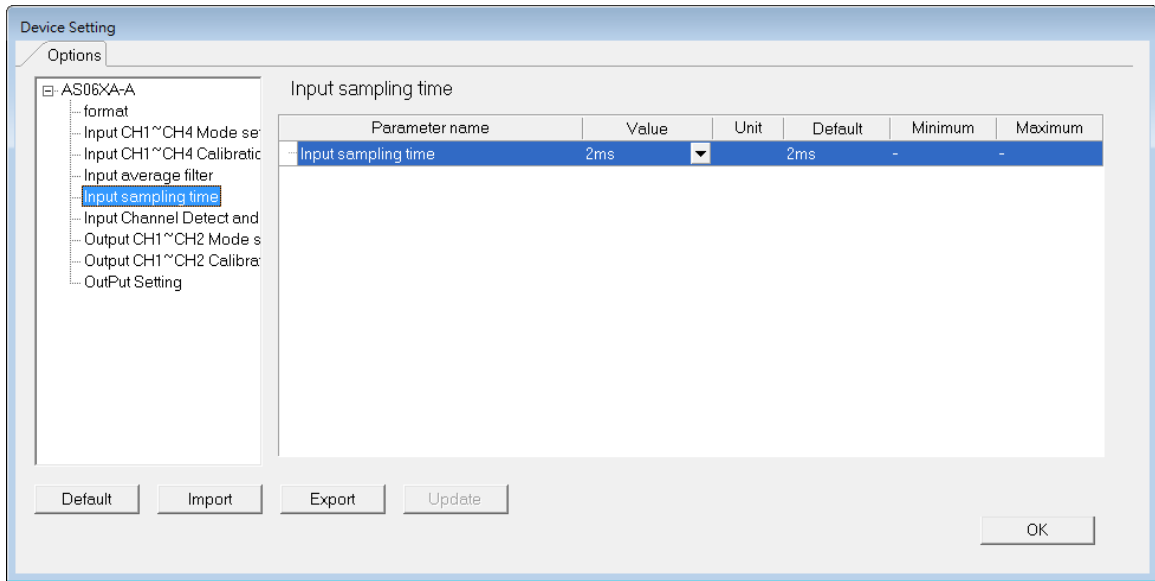

(6) Input channel detection and alarm settings

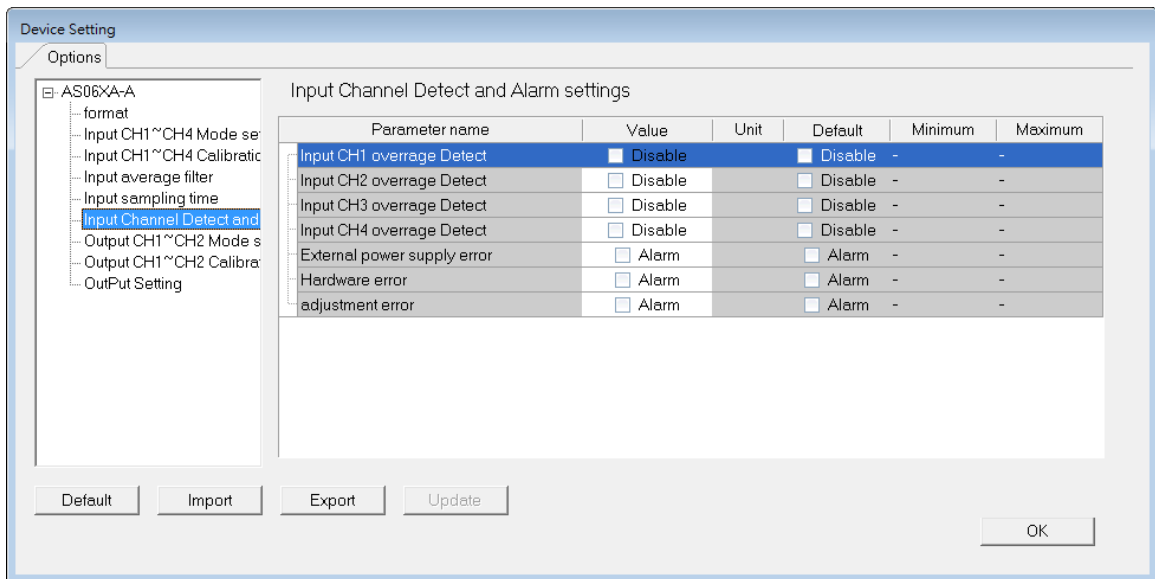

(7) Output CH1-CH2 mode settings

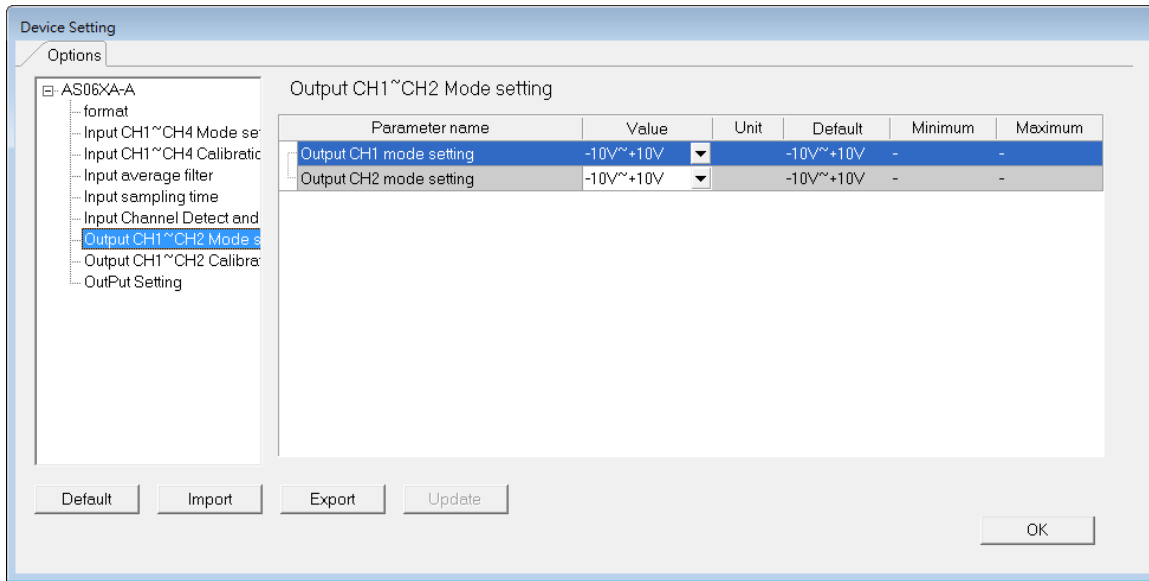

(8) Output CH1-2 calibration

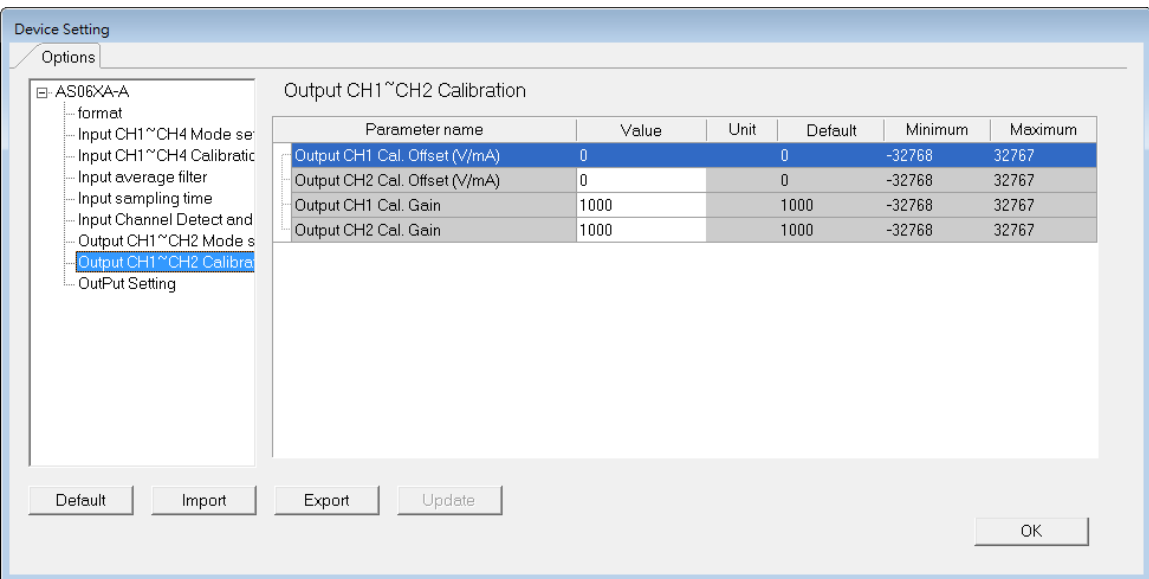

(9) Output Settings

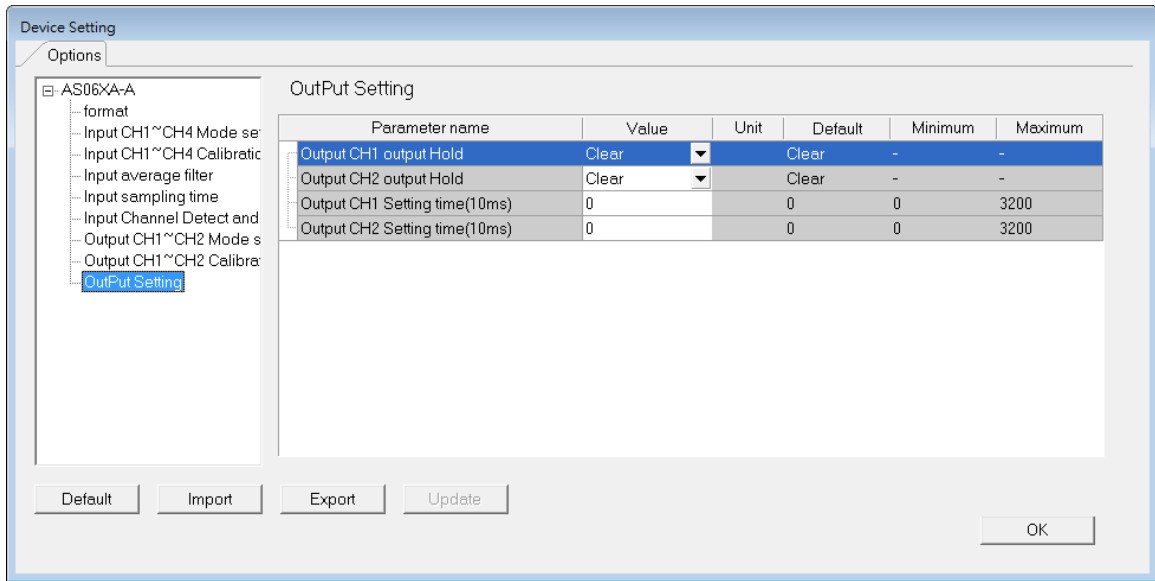

5.4 DIADesigner-AX (Hardware Configuration)

The following example uses AS06XA-A.

5.4.1 Initial Setting

- (1) Start DIADesigner-AX, click **New Project**, and then **Project+Device** to create a new project.

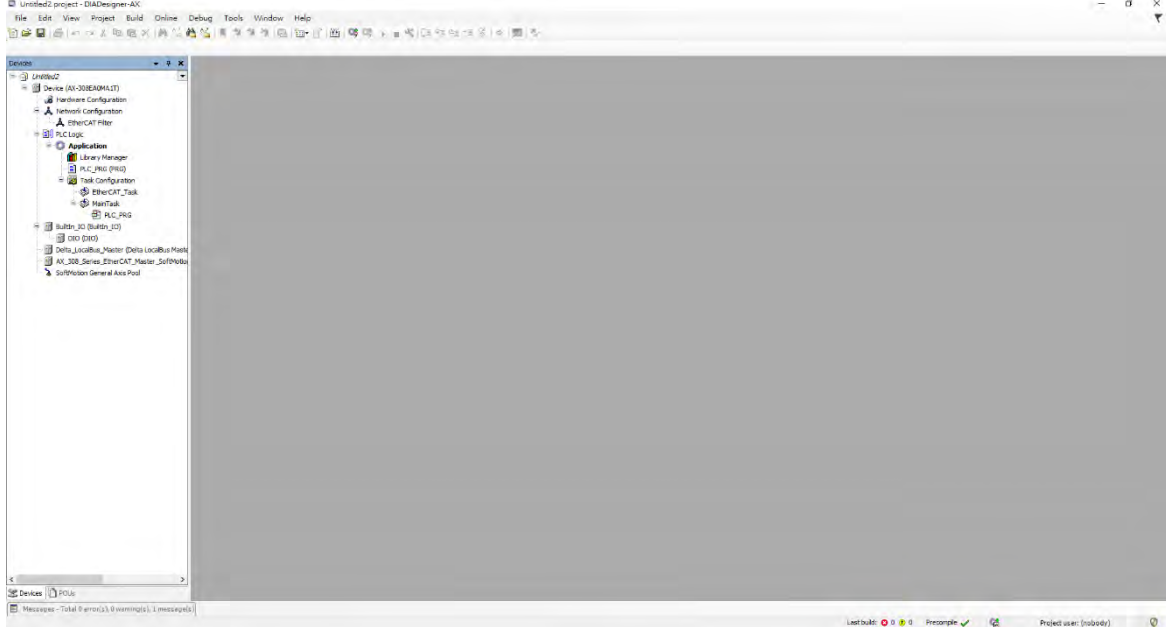

- (2) Add modules in:

- ① Double-click **Hardware Configuration**

- ② Select the **+** section and drag and drop the module that you want to add from the Product List to the **+** section.

or ③ Right-click **Delta_Localbus Master** to see the context menu and then double-click **Add Device** to add devices manually or double-click **Scan for Devices**.

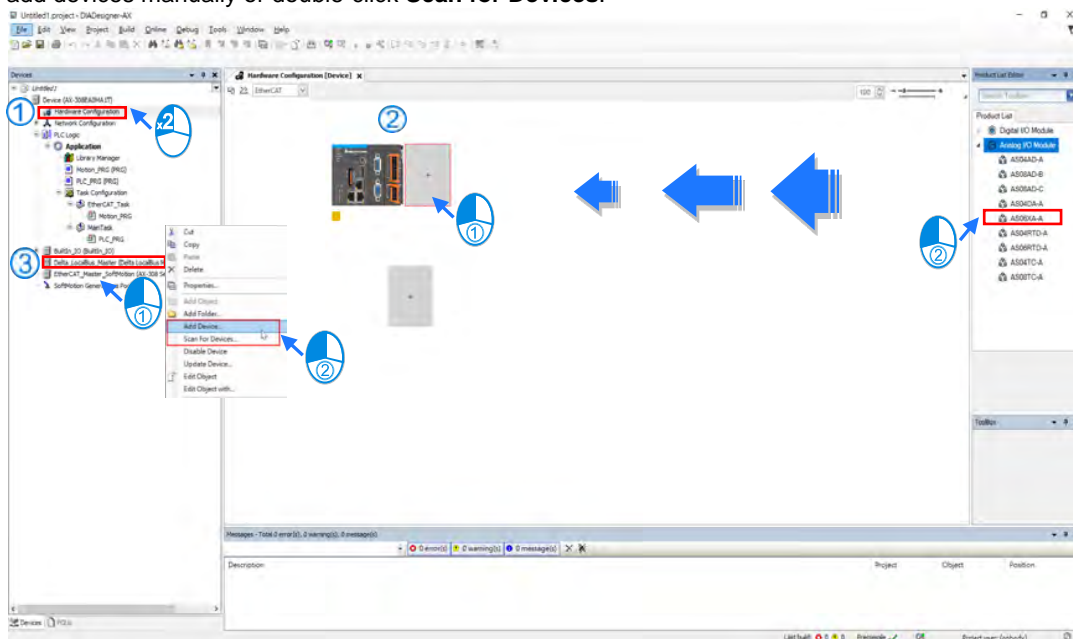

(3) Select modules:

- ① Double-click the module name in the **Hardware Configuration** area.
- or ② Double-click the module name shown in the node.

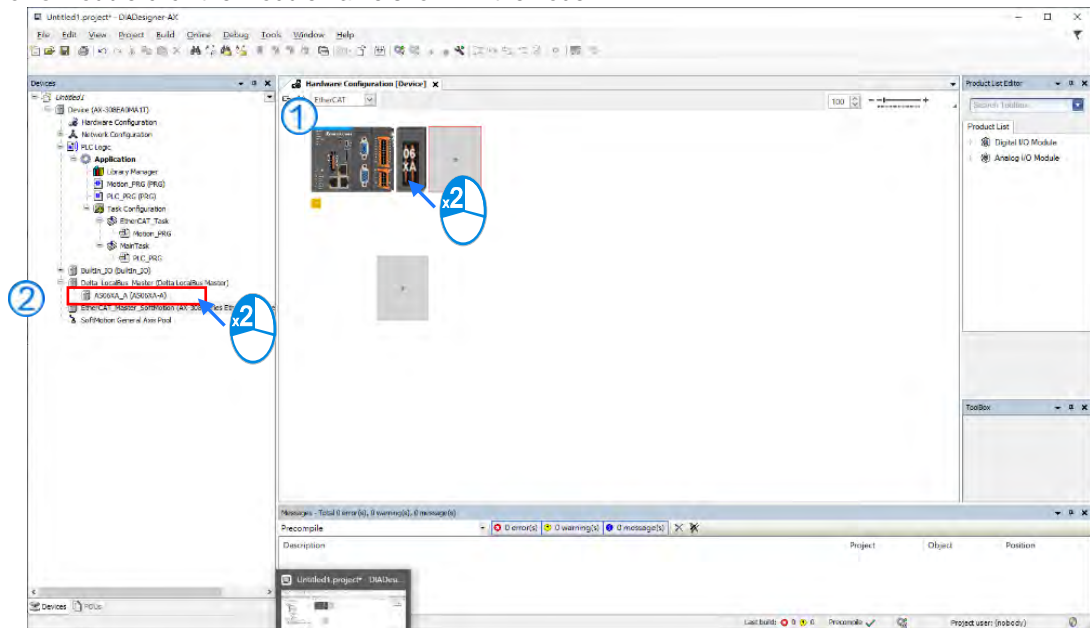

(4) Module parameter setting page:

Parameter	Type	Val...	De...	Unit	Description
Format	Enumeration of UINT	Int...	Int...		
Input CH1~CH4 Mode Setting					
Input CH1 Mode Setting	Enumeration of WORD	-10...	-10...		
Input CH2 Mode Setting	Enumeration of WORD	-10...	-10...		
Input CH3 Mode Setting	Enumeration of WORD	-10...	-10...		
Input CH4 Mode Setting	Enumeration of WORD	-10...	-10...		
Input CH1~CH4 Calibration					
Input CH1 Cal. Offset	INT(-32768..32767)	0	0		
Input CH2 Cal. Offset	INT(-32768..32767)	0	0		
Input CH3 Cal. Offset	INT(-32768..32767)	0	0		
Input CH4 Cal. Offset	INT(-32768..32767)	0	0		
Input CH1 Cal. Gain	INT(-32768..32767)	1000	1000		
Input CH2 Cal. Gain	INT(-32768..32767)	1000	1000		
Input CH3 Cal. Gain	INT(-32768..32767)	1000	1000		
Input CH4 Cal. Gain	INT(-32768..32767)	1000	1000		
Input Average Filter					
Input CH1 Average Times	WORD(1..100)	10	10		
Input CH2 Average Times	WORD(1..100)	10	10		
Input CH3 Average Times	WORD(1..100)	10	10		
Input CH4 Average Times	WORD(1..100)	10	10		
Input CH1 Filter Proportion	Enumeration of WORD	10%	10%		
Input CH2 Filter Proportion	Enumeration of WORD	10%	10%		
Input CH3 Filter Proportion	Enumeration of WORD	10%	10%		
Input CH4 Filter Proportion	Enumeration of WORD	10%	10%		
Input Sampling Time					
Input sampling time	Enumeration of WORD	2ms	2ms		
Input Channel Detect and Alarm Settings	WORD	0			
Input CH1 Overrange Detect	BOOL	FALSE	FALSE		
Input CH2 Overrange Detect	BOOL	FALSE	FALSE		
Input CH3 Overrange Detect	BOOL	FALSE	FALSE		
Input CH4 Overrange Detect	BOOL	FALSE	FALSE		
Reserved	BOOL	FALSE	FALSE		
Reserved	BOOL	FALSE	FALSE		
Reserved	BOOL	FALSE	FALSE		
Reserved	BOOL	FALSE	FALSE		
External Power Supply Error	BOOL	FALSE	FALSE		
Hardware Error	BOOL	FALSE	FALSE		
Adjustment Error	BOOL	FALSE	FALSE		
Output Ch1~Ch2 Mode Setting					
Output CH1 Mode Setting	Enumeration of WORD	-10...	-10...		

- (5) After setting is complete, select the module and click **Login** on the tool bar to download the settings to the modules.

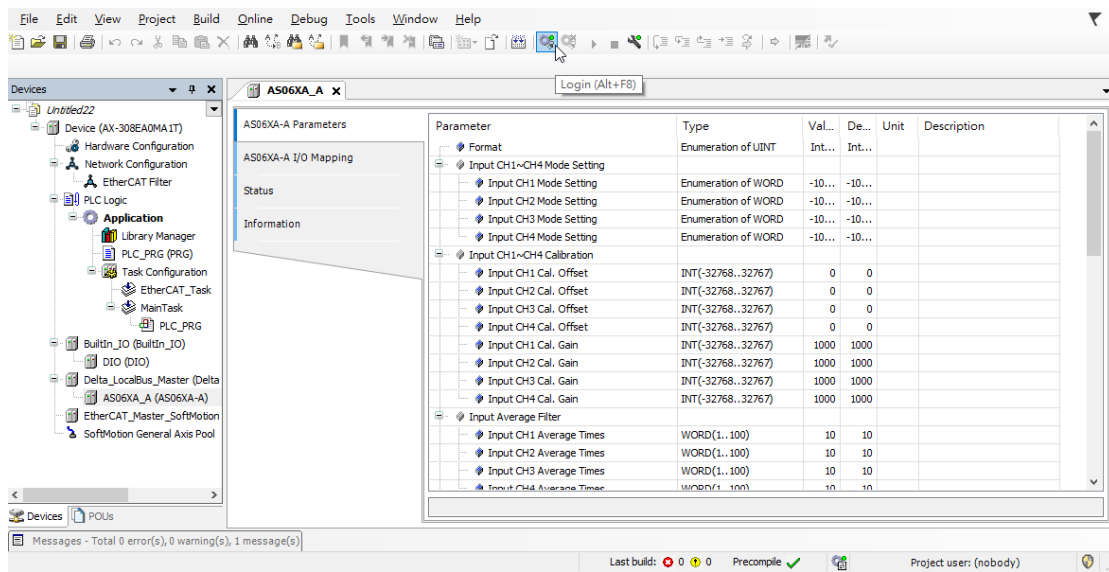

5.4.2 Checking the Version of a Module

- (1) Select the module and click the Information tab to see the module information.

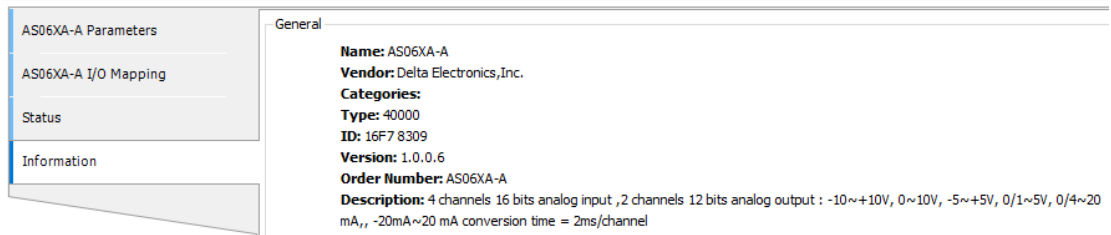

The screenshot shows the 'AS06XA-A Parameters' dialog box with the 'Information' tab selected. The 'General' section contains the following information:

- Name:** AS06XA-A
- Vendor:** Delta Electronics, Inc.
- Categories:**
- Type:** 40000
- ID:** 16F7 8309
- Version:** 1.0.0.6
- Order Number:** AS06XA-A
- Description:** 4 channels 16 bits analog input , 2 channels 12 bits analog output : -10~+10V, 0~10V, -5~+5V, 0/1~5V, 0/4~20 mA,, -20mA~20 mA conversion time = 2ms/channel

- (2) Select the module and click **Login** on the tool bar to go to Online Mode. You can find the Module Revision from the Parameters tab.

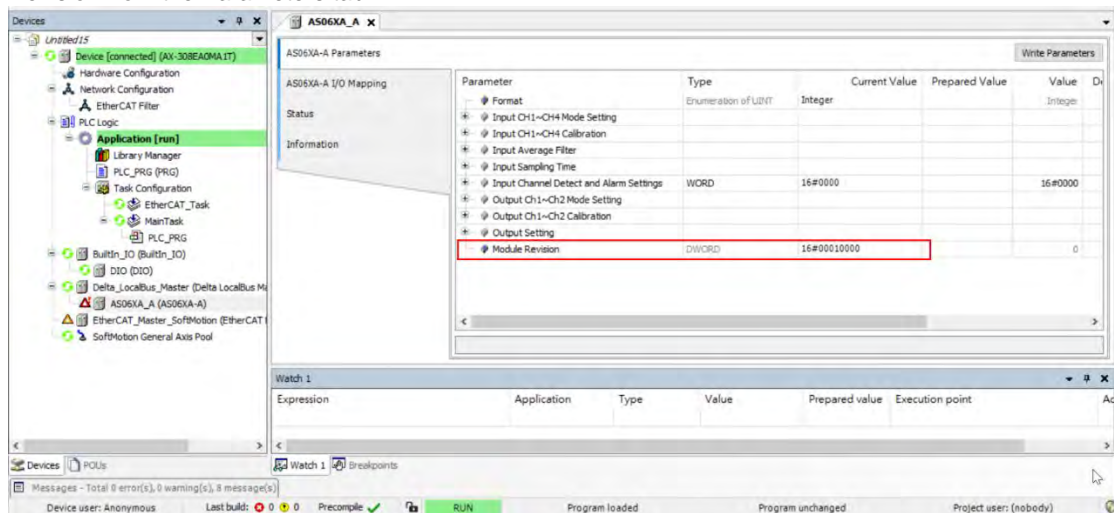

The screenshot shows the 'AS06XA-A Parameters' dialog box with the 'Parameters' tab selected. The 'Module Revision' parameter is highlighted with a red box. The 'Watch 1' window is also visible, showing the current value of the 'Module Revision' parameter as 16#00010000.

Parameter	Type	Current Value	Prepared Value	Value	Di
Format	Enumeration of UDINT	Integer		Integer	
Input CH1~CH4 Mode Setting					
Input CH1~CH4 Calibration					
Input Average Filter					
Input Sampling Time					
Input Channel Detect and Alarm Settings	WORD	16#0000		16#0000	
Output Ch1~Ch2 Mode Setting					
Output Ch1~Ch2 Calibration					
Output Setting					
Module Revision	DWORD	16#00010000		0	

5.4.3 Online Mode

- (1) Select the module and click **Login** on the tool bar to go to **Online Mode**. You can monitor all configuration parameters. Values in the column of Prepared Value are configurable online. After editing the values in the Prepared Value column, click **Write Parameter** to confirm the change.

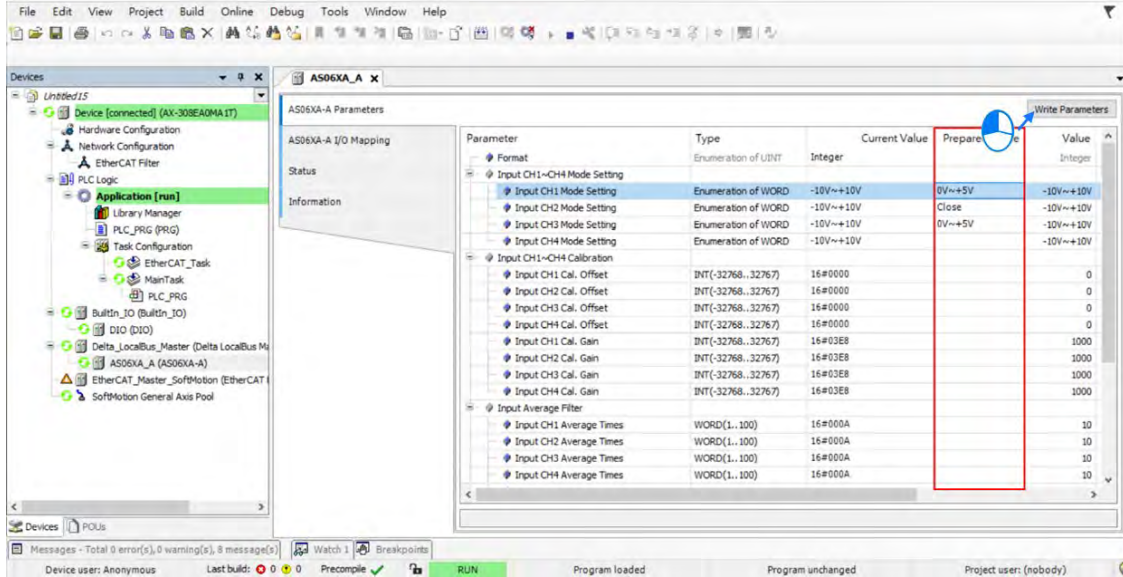

- (2) You can monitor the values, status, error codes in each channel from the I/O Mapping tab. You can also set a new value in the column of Prepared Value and press Ctrl+F7 on the keyboard to write the new values in.

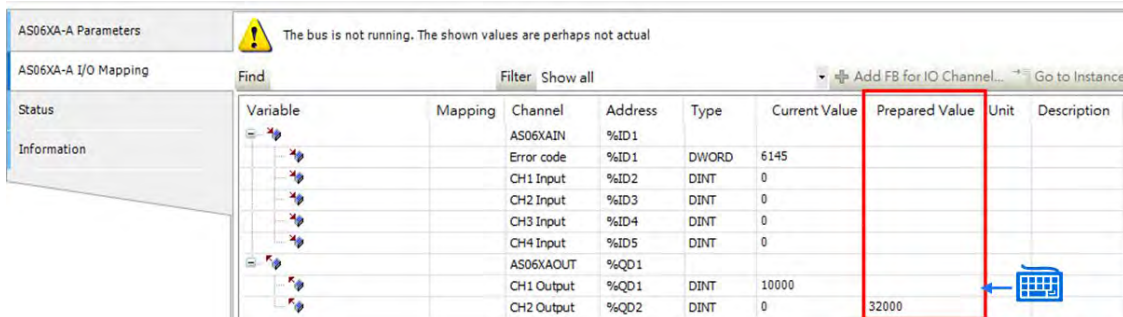

- (3) You can monitor the current status and error codes from the Status tab.

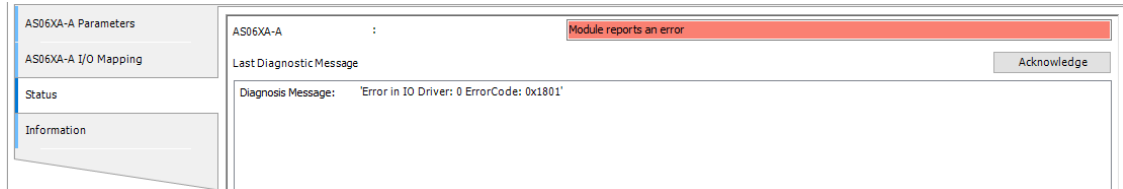

5.4.4 Parameters

(1) You can set up the value format to **Integer** or **Floating** for Channel 1 to 4.

Parameter	Type	Value	Default Value	Unit	Description
Format	Enumeration of UINT	Integer	Integer		
CH1~CH4 Mode Setting					
CH1 Mode Setting	Enumeration of WORD	-10V~+10V	Integer	V	V~+10V
CH2 Mode Setting	Enumeration of WORD	-10V~+10V	Floating	V	V~+10V
CH3 Mode Setting	Enumeration of WORD	-10V~+10V	-10V~+10V	V	-10V~+10V
CH4 Mode Setting	Enumeration of WORD	-10V~+10V	-10V~+10V	V	-10V~+10V

(2) You can set up the values for Channel 1 to 4.

Parameter	Type	Value	Default Value	Unit	Description
Format	Enumeration of UINT	Integer	Integer		
CH1~CH4 Mode Setting					
CH1 Mode Setting	Enumeration of WORD	-10V~+10V	-10V~+10V	V	-10V~+10V
CH2 Mode Setting	Enumeration of WORD	Close	-10V~+10V	V	-10V~+10V
CH3 Mode Setting	Enumeration of WORD	-10V~+10V	-10V~+10V	V	-10V~+10V
CH4 Mode Setting	Enumeration of WORD	0V~+10V	-10V~+10V	V	-10V~+10V
CH1~CH4 Calibration					
CH1 Cal. Offset (V/mA)	INT(-32768..32767)	0mA~20mA	0		
CH2 Cal. Offset (V/mA)	INT(-32768..32767)	4mA~20mA	0		
CH3 Cal. Offset (V/mA)	INT(-32768..32767)	-20mA~-20mA	0		

(3) You can set up the calibrations for for Channel 1 to 4.

Parameter	Type	Value	Default Value	Unit	Description
CH1~CH4 Calibration					
CH1 Cal. Offset (V/mA)	INT(-32768..32767)	0	0		
CH2 Cal. Offset (V/mA)	INT(-32768..32767)	0	0		
CH3 Cal. Offset (V/mA)	INT(-32768..32767)	0	0		
CH4 Cal. Offset (V/mA)	INT(-32768..32767)	0	0		
CH1 Cal. Gain	INT(-32768..32767)	1000	1000		
CH2 Cal. Gain	INT(-32768..32767)	1000	1000		
CH3 Cal. Gain	INT(-32768..32767)	1000	1000		
CH4 Cal. Gain	INT(-32768..32767)	1000	1000		

(4) You can set up the average filtering for Channel 1 to 4.

Parameter	Type	Value	Default Value	Unit	Description
Average Filter					
CH1 Average Times	WORD(1..100)	10	10		
CH2 Average Times	WORD(1..100)	10	10		
CH3 Average Times	WORD(1..100)	10	10		
CH4 Average Times	WORD(1..100)	10	10		
CH1 Filter Proportion	Enumeration of WORD	10%	10%		
CH2 Filter Proportion	Enumeration of WORD	10%	10%		
CH3 Filter Proportion	Enumeration of WORD	10%	10%		
CH4 Filter Proportion	Enumeration of WORD	10%	10%		

(5) You can set up the sampling time.

Sampling Time				
sampling time	Enumeration of WORD	2ms	2ms	
Channel Detect and Alarm Settings	WORD	0		
CH1 Overrange Detect	BOOL	FALSE	FALSE	
CH2 Overrange Detect	BOOL	FALSE	FALSE	
CH3 Overrange Detect	BOOL	FALSE	FALSE	
CH4 Overrange Detect	BOOL	FALSE	FALSE	
Reserved	BOOL	FALSE	FALSE	
Reserved	BOOL	FALSE	FALSE	
Reserved	BOOL	FALSE	FALSE	

(6) You can set up the channel detect and alarm settings.

Channel Detect and Alarm Settings	WORD	0		
CH1 Overrange Detect	BOOL	FALSE	FALSE	
CH2 Overrange Detect	BOOL	FALSE	FALSE	
CH3 Overrange Detect	BOOL	FALSE	FALSE	
CH4 Overrange Detect	BOOL	FALSE	FALSE	
Reserved	BOOL	FALSE	FALSE	
Reserved	BOOL	FALSE	FALSE	
Reserved	BOOL	FALSE	FALSE	
Reserved	BOOL	FALSE	FALSE	
External Power Supply Error	BOOL	FALSE	FALSE	
Hardware Error	BOOL	FALSE	FALSE	
Adjustment Error	BOOL	FALSE	FALSE	

5

(7) You can set up the output channel mode for Channel 1 and 2.

Output Ch1~Ch2 Mode Setting				
Output CH1 Mode Setting	Enumeration of WORD	-10V~+10V	-10V~+10V	
Output CH2 Mode Setting	Enumeration of WORD	-10V~+10V	-10V~+10V	

(8) You can set up the calibrations for output Channel 1 and 2.

Output Ch1~Ch2 Calibration				
Output CH1 Cal. Offset	INT(-32768..32767)	0	0	
Output CH2 Cal. Offset	INT(-32768..32767)	0	0	
Output CH1 Cal. Gain	INT(-32768..32767)	1000	1000	
Output CH2 Cal. Gain	INT(-32768..32767)	1000	1000	

(9) You can set up the output settings for output Channel 1 and 2.

Output Setting				
Output CH1 Output Hold	Enumeration of WORD	Clear	Clear	
Output CH2 Output Hold	Enumeration of WORD	Clear	Clear	
Output CH1 Setting Time(10ms)	INT(0..3200)	0	0	
Output CH2 Setting Time(10ms)	INT(0..3200)	0	0	

5.5 Troubleshooting

5.5.1 Error Codes

Error Code	Description	A↔D LED indicator	ERROR LED indicator
16#1605	Hardware failure	OFF	ON
16#1607	The external voltage is abnormal.	OFF	ON
16#1608	The factory calibration is abnormal.	OFF	ON
16#1801	The external voltage is abnormal.	OFF	Blinking
16#1802	Hardware failure	OFF	Blinking
16#1804	The factory calibration is abnormal.	OFF	Blinking
16#1808	The signal received by channel 1 exceeds the range of inputs that the hardware can receive.	Run: blinking Stop: OFF	Blinking
16#1809	The signal received by channel 2 exceeds the range of inputs that the hardware can receive.		
16#180A	The signal received by channel 3 exceeds the range of inputs that the hardware can receive.		
16#180B	The signal received by channel 4 exceeds the range of inputs that the hardware can receive.		
-	When power-on, the module is not detected by CPU module.	OFF	Blinking once or twice and after 2 seconds, it blinks repeatedly

5.5.2 Troubleshooting Procedure

Description	Procedure
The external voltage is abnormal.	Ensure the external 24 V power supply to the module is functioning normally.
Hardware failure	Return the module to the factory for repair.
Internal error The factory calibration is abnormal.	Contact the factory.
The signal received by channel 1 exceeds the range of inputs that the hardware can receive.	Check the signal received by channel 1
The signal received by channel 2 exceeds the range of inputs that the hardware can receive.	Check the signal received by channel 2.
The signal received by channel 3 exceeds the range of inputs that the hardware can receive.	Check the signal received by channel 3.
The signal received by channel 4 exceeds the range of inputs that the hardware can receive.	Check the signal received by channel 4.
When power-on, the module is not detected by CPU module.	Check if the connection between module and CPU module is working. If not, connect again.

Chapter 6 Temperature Measurement

Module AS04/06RTD

Table of Contents

6.1 Overview	6-2
6.1.1 Characteristics	6-2
6.2 Specifications and Functions	6-3
6.2.1 Specifications	6-3
6.2.2 Profile	6-6
6.2.3 Arrangement of Terminals	6-7
6.2.4 AS04RTD Control Registers	6-8
6.2.5 AS06RTD Control Registers	6-12
6.2.6 Functions	6-17
6.2.7 Control Mode	6-20
6.2.8 Wiring	6-20
6.2.9 LED Indicators	6-23
6.3. HWCONFIG in ISPSOft	6-24
6.3.1 Initial Setting	6-24
6.3.2 Checking the Version of a Module	6-27
6.3.3 Online Mode	6-28
6.3.4 Importing/Exporting a Parameter File	6-29
6.3.5 Parameters	6-30
6.4 DIADesigner-AX (Hardware Configuration)	6-33
6.4.1 Initial Setting	6-33
6.4.2 Checking the Version of a Module	6-35
6.4.3 Online Mode	6-36
6.4.4 Parameters	6-37
6.5 Troubleshooting	6-39
6.5.1 Error Codes	6-39
6.5.2 Troubleshooting Procedure	6-40
6.5.3 State of the Connection	6-41

6.1 Overview

This section describes the specifications for temperature measurement modules, their operation, and their programming. The AS04/06RTD is a temperature measurement module that converts the temperatures received from four/six thermocouples into digital signals. You can select either Celsius or Fahrenheit as the unit of measurement. For software operation, ISPSOft, DIADesigner or DIADesigner-AX is what you need. If you are using AS Series PLC CPU, refer to ISPSOft User Manual or DIADesigner Manual for more information. The new software DIADesigner-AX only supports AX Series PLC CPU and AS Series modules now, refer to AX-3 User Manual for more information on software operation.

6.1.1 Characteristics

(1) **Select a sensor based on its practical application.**

Pt100/Ni100/Pt1000/Ni1000/JPt100/LG-Ni1000/Cu50/Cu100/0–300 Ω/0–3000 Ω sensor and for FW V1.06, Ni120 is also available.

(2) **High-speed conversion**

Two-wire/Three-wire configuration: 200 ms/channel

(3) **High accuracy**

Conversion accuracy: The error range of the input is $\pm 0.1\%$ at ambient temperature of $25^{\circ} \pm 5^{\circ} \text{C}$.)

(4) **Disconnection detection**

When a sensor is disconnected, the AS04RTD produces an alarm or a warning.

(5) **PID control**

An object's temperature can be maintained through PID control actions.

(6) **Use the utility software to configure the module.**

The HWCONFIG utility software is built into ISPSOft. You can set modes and parameters directly in HWCONFIG of ISPSOft or Hardware Configuration of DIADesigner without spending time writing programs to set registers to manage functions.

6.2 Specifications and Functions

6.2.1 Specifications

- Electrical specifications

Module	AS04RTD-A	AS06RTD-A
Number of Analog Inputs	4	6
Applicable Sensor	<p><u>2-Wire & 3-Wire:</u></p> <p>Pt100: DIN 43760-1980 JIS C1604-1989; 100 Ω 3850 PPM/°C</p> <p>Pt1000: DIN EN60751; 1 kΩ 3850 PPM/°C</p> <p>Ni100/Ni1000: DIN 43760</p> <p>JPt100: JIS C1604-1989</p> <p>LG-Ni1000</p> <p>Cu50/Cu100</p>	
Supply Voltage	24 VDC (20.4–28.8 VDC) (-15% to +20%)	
Connector Type	Removable terminal block	
Overall Accuracy	Pt100/Ni100/Ni120/Pt1000/Ni1000/JPt100	
	25° C/77° F: The allowed error range is ±0.1% of full scale.	
	-20° C to 60° C/-4° F to 140° F: The allowed error range is ±0.5% of full scale.	
	LG-Ni1000; 25° C/77° F: The allowed error range is ±0.1% of full scale.	
	Cu50; 25° C/77° F: The allowed error range is ±4% of full scale.	
	Cu100; 25° C/77° F: The allowed error range is ±2% of full scale.	
Resolution	0.1°C / 0.1°F	
Conversion Time	Two-wire/Three-wire configuration: 200 ms/channel	
Isolation	<p>An analog circuit is isolated from a digital circuit by a digital integrated circuit/optocoupler, and the analog channels are isolated from one another by optocouplers.</p> <p>Isolation between a digital circuit and the ground: 500 VAC</p> <p>Isolation between an analog circuit and the ground: 500 VAC</p> <p>Isolation between an analog circuit and the digital circuit: 500 VAC</p> <p>Isolation between the 24 VDC and the ground: 500 VAC</p>	
Weight	115 g	125 g

● **Functional specifications**

Analog-to-Digital Conversion	Centigrade (°C)	Fahrenheit (°F)	Input Impedance
Rated Measurement Range^{*1}	Pt100: -180° C to +800° C Ni100: -80° C to +170° C Ni120: -80° C to +320° C Pt1000: -180° C to +800° C Ni1000: -80° C to +170° C JPt100: -180° C to +500° C LG-Ni1000: -50° C to +180° C Cu50: -50° C to +150° C Cu100: -50° C to +150° C	Pt100: -292° F to +1,472° F Ni100: -112° F to +338° F Ni120: -112° F to +608° F Pt1000: -292° F to +1,472° F Ni1000: -112° F to +338° F JPt100: -292° F to +932° F LG-Ni1000: -58° F to +356° F Cu50: -58° F to +302° F Cu100: -58° F to +302° F	0-300 Ω 0-3000 Ω
Maximum Measurable Range^{*2}	Pt100: -200°C to 850°C Ni100: -100°C to 180°C Ni120: -80° C to +320° C Pt1000: -200°C to 850°C Ni1000: -100°C to 180°C JPt100: -200°C to 510°C LG-Ni1000: -60°C to 200°C Cu50: -50°C to 150°C Cu100: -50°C to 150°C	Pt100 : -328°F to 1,562°F Ni100: -148°F to 356°F Ni120: -112° F to +608° F Pt1000 : -328°F to 1,562°F Ni1000 : -148°F to 356°F JPt100 : -328°F to 950°F LG-Ni1000 : -76°F to 392°F Cu50 : -58°F to 302°F Cu100 : -58°F to 302°F	0-320 Ω 0-3200 Ω
Average function	Range: 1-100		
Self-diagnosis	Disconnection detection		

*1: If any of these limits are exceeded, device functionality should not be assumed, damage may occur and reliability may be affected.

*2: If the to be measured temperature exceeds the upper/lower limit, it only shows the maximum / minimum value.

Conversion details

Centigrade (°C)			
Sensor type	Maximum measurable range	Integer value range after digital conversion	Floating point value range after digital conversion
Pt100	-200°C ~ 850°C	K-2000 ~ K8500	-200.0 ~ 850.0
Ni100	-100°C ~ 180°C	K-1000 ~ K1800	-100.0 ~ 180.0
Ni120	-80°C ~ 320°C	K-800 ~ K3200	-80.0 ~ 320.0
Pt1000	-200°C ~ 850°C	K-2000 ~ K8500	-200.0 ~ 850.0
Ni1000	-100°C ~ 180°C	K-1000 ~ K1800	-100.0 ~ 180.0
JPt100	-200°C ~ 510°C	K-2000 ~ K5100	-200.0 ~ 510.0
LG-Ni1000	-60°C ~ 200°C	K-600 ~ K2000	-60.0 ~ 200.0
Cu50	-50°C ~ 150°C	K-500 ~ K1500	-50.0 ~ 150.0
Cu100	-50°C ~ 150°C	K-500 ~ K1500	-50.0 ~ 150.0
0~300Ω	0 ~ 320Ω	K0 ~ K32000	0.0 ~ 320.00
0~3000Ω	0 ~ 3200Ω	K0 ~ K32000	0.0 ~ 3200.0

Fahrenheit (°F)			
Sensor type	Maximum measurable range	Integer value range after digital conversion	Floating point value range after digital conversion
Pt100	-328°F ~ 1,562°F	K-3280 ~ K15620	-328.0 ~ 1562.0
Ni100	-148°F ~ 356°F	K-1480 ~ K3560	-148.0 ~ 356.0
Ni120	-112°C ~ 608°C	K-1120 ~ K6080	-112.0 ~ 608.0
Pt1000	-328°F ~ 1,562°F	K-3280 ~ K15620	-328.0 ~ 1562.0
Ni1000	-148°F ~ 356°F	K-1480 ~ K3560	-148.0 ~ 356.0
JPt100	-328°F ~ 950°F	K-3280 ~ K9500	-328.0 ~ 950.0
LG-Ni1000	-76°F ~ 392°F	K-760 ~ K3920	-76.0 ~ 392.0
Cu50	-58°F ~ 302°F	K-580 ~ K3020	-58.0 ~ 302.0
Cu100	-58°F ~ 302°F	K-580 ~ K3020	-58.0 ~ 302.0
0 ~ 300Ω	0 ~ 320Ω	K0 ~ K32000	0.0 ~ 320.00
0 ~ 3000Ω	0 ~ 3200Ω	K0 ~ K32000	0.0 ~ 3200.0

6.2.2 Profile

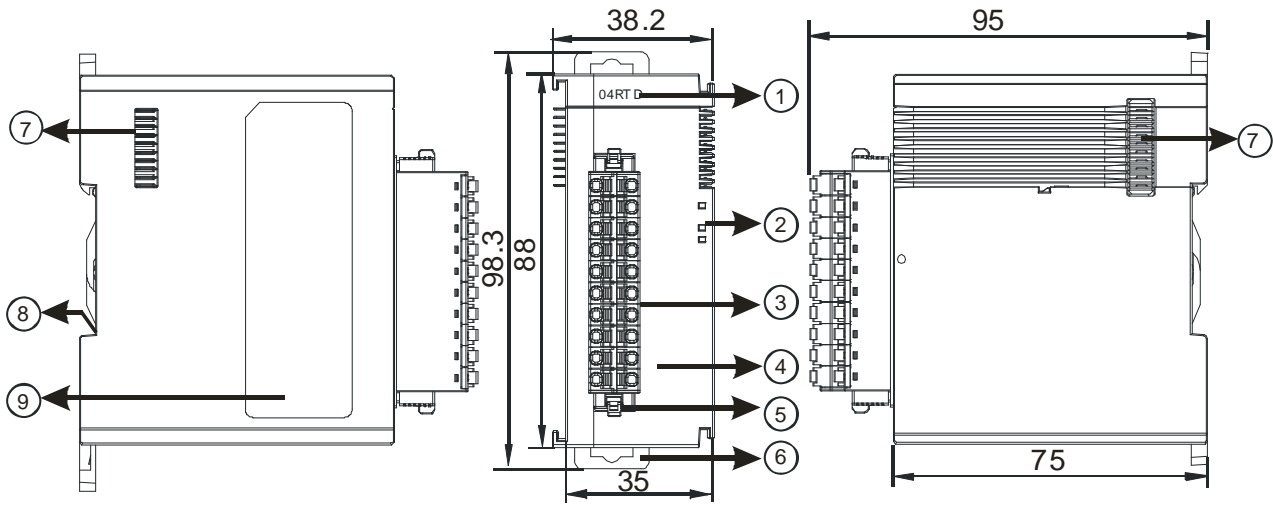

Unit: mm

Number	Name	Description
1	Model Name	Model name of the module
2	RUN LED Indicator	Operating status of the module ON: the module is running. OFF: the module is not running.
	ERROR LED Indicator	Error status of the module ON: a serious error exists in the module. OFF: the module is operating normally. Blink: a minor error exists in the module.
	Analog-to-Digital Conversion Indicator	Conversion status Blinking: conversion is in process. OFF: conversion has stopped.
3	Removable Terminal Block	The inputs are connected to transducers. The outputs are connected to loads to be driven.
4	Arrangement of the Input/Output Terminals	Arrangement of the terminals
5	Clip	For removing the terminal block
6	DIN Rail Clip	Secures the module onto the DIN rail
7	Module Connecting Set	Connects the modules
8	Ground Clip	
9	Label	Name plate

6.2.3 Arrangement of Terminals

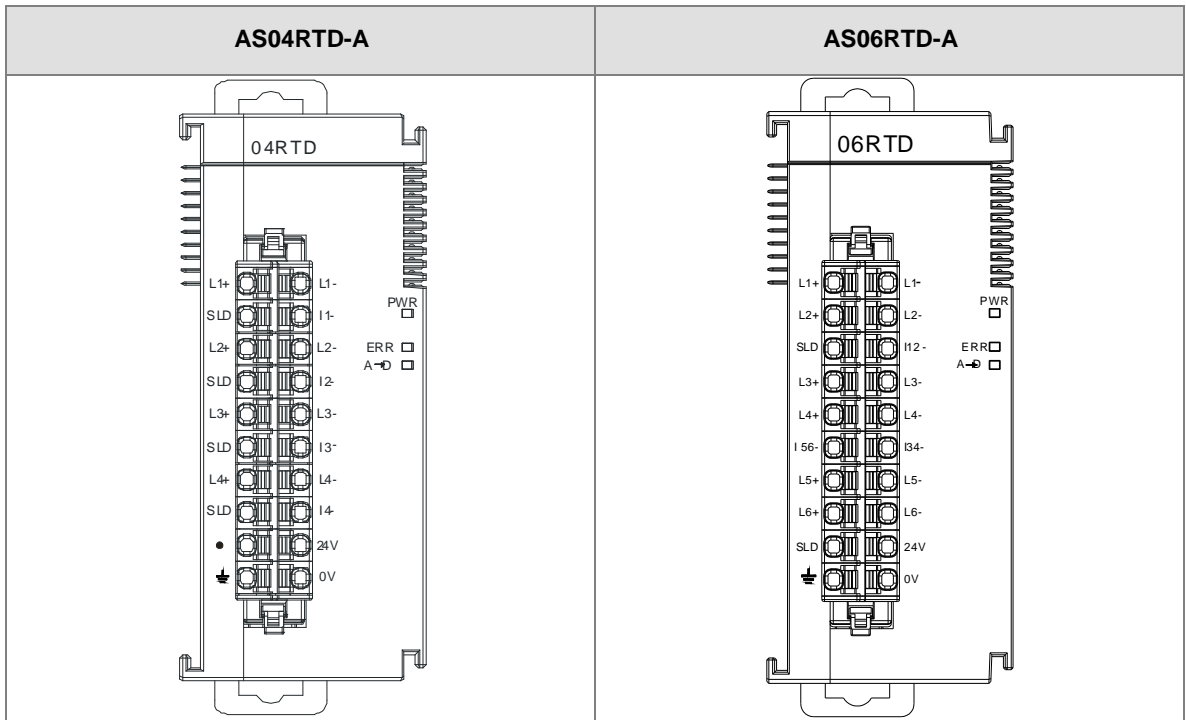

6.2.4 AS04RTD Control Registers

*If you use HWCONFIG to set values in CRs, once the set value is downloaded, the values can be retained in the module; however if you use TO instruction to write data into CRs, the values CANNOT be retained, after power failure or after transition of the CPU from STOP to RUN.

Note: The attribute of the CR must be W (write) to use TO instruction.

CR#	Name	Description	Atr.	Defaults
0	Format Setup	0: integer format 1: floating point format	R	0
1	Channel 1 mode setup	0: closed 1: 0–300 Ω (default) 2: 0–3000 Ω	R/W	1
2	Channel 2 mode setup	3: Pt100 4: JPt100 5: Pt1000		
3	Channel 3 mode setup	6: Ni100 7: Ni1000 8: LG-Ni1000		
4	Channel 4 mode setup	9: Cu50 10: Cu100 11: Ni120 (FW V1.06 or later)		
5	Channel 1 offset	Range: -32768 to +32767	R/W	0
6	Channel 2 offset			
7	Channel 3 offset			
8	Channel 4 offset			
9	Channel 1 gain	Range: -32768 to +32767	R/W	1000
10	Channel 2 gain			
11	Channel 3 gain			
12	Channel 4 gain			
13	Channel 1 average times	Range: 1–100	R/W	10
14	Channel 2 average times			
15	Channel 3 average times			
16	Channel 4 average times			
17	Channel 1 filter average percentage	Range: 0–3	R/W	1

CR#	Name	Description	Atr.	Defaults
18	Channel 2 filter average percentage	Unit: $\pm 10\%$		
19	Channel 3 filter average percentage			
20	Channel 4 filter average percentage			
21	Units of temperature	0: Fahrenheit 1: Celsius	R/W	0
22	Channel alarm setup	0: open channel alarm 1: close channel alarm bit0: channel 1 bit1: channel 2 bit2: channel 3 bit3: channel 4 0: warning 1: alarm bit8: error in the power supply bit9: error in the module hardware bit10: error in calibration	R/W	0
201	Instruction set	16#0101: record the peak value again for channel 1 16#0102: record the peak value again for channel 2 16#0104: record the peak value again for channel 3 16#0108: record the peak value again for channel 4 16#010F: record the peak values again for channels 1–4 16#0201: enable recording for channel 1 16#0202: enable recording for channel 2 16#0204: enable recording for channel 3	W	0

CR#	Name	Description	Atr.	Defaults
		16#0208: enable recording for channel 4 16#020F: enable recording for channels 1–4 16#0211: disable recording for channel 1 16#0212: disable recording for channel 2 16#0214: disable recording for channel 3 16#0218: disable recording for channel 4 16#021F: disable recording for channels 1–4 16#0502: restore default settings		
210	The maximum peak value for channel 1	Integer format; the maximum peak value for analog inputs	R	-
211	The maximum peak value for channel 2			-
212	The maximum peak value for channel 3			-
213	The maximum peak value for channel 4			-
214	The minimum peak value for channel 1	Integer format; the minimum peak value for analog inputs	R	-
215	The minimum peak value for channel 2			-
216	The minimum peak value for channel 3			-
217	The minimum peak value for channel 4			-
222	The time to record for channel 1	Unit: 10 ms	R/W	1
223	The time to record for channel 2	Range: 1–100		1
224	The time to record for channel 3	The time to record the digital value for the channels		1
225	The time to record for channel 4			1
240	The number of records for channel 1	Range: 0–500, display the current records	R	0
241	The number of records for channel 2			0
242	The number of records for channel 3			0
243	The number of records for channel 4			0
4000-4499	Records for channel 1	500 records for channel 1	R	--

CR#	Name	Description	Atr.	Defaults
4500- 4999	Records for channel 2	500 records for channel 2	R	--
5000- 5499	Records for channel 3	500 records for channel 3	R	--
5500- 5999	Records for channel 4	500 records for channel 4	R	--

6.2.5 AS06RTD Control Registers

*If you use HWCONFIG to set values in CRs, once the set value is downloaded, the values can be retained in the module; however if you use TO instruction to write data into CRs, the values CANNOT be retained, after power failure or after transition of the CPU from STOP to RUN.

Note: The attribute of the CR must be W (write) to use TO instruction.

CR#	Name	Description	Atr.	Defaults
0	Format Setup	0: integer format 1: floating point format	R	0
1	Channel 1 mode setup	0: closed 1: 0–300 Ω (default)	R/W	1
2	Channel 2 mode setup	2: 0–3000 Ω		
3	Channel 3 mode setup	3: Pt100		
4	Channel 4 mode setup	4: JPt100		
5	Channel 5 mode setup	5: Pt1000		
6	Channel 6 mode setup	6: Ni100		
		7: Ni1000		
		8: LG-Ni1000		
		9: Cu50		
		10: Cu100		
		11: Ni120 (FW V1.06 or later)		
7	Channel 1 offset	Range: -32768 to +32767	R/W	0
8	Channel 2 offset			
9	Channel 3 offset			
10	Channel 4 offset			
11	Channel 5 offset			
12	Channel 6 offset			
13	Channel 1 gain	Range: -32768 to +32767	R/W	1000
14	Channel 2 gain			
15	Channel 3 gain			
16	Channel 4 gain			
17	Channel 5 gain			
18	Channel 6 gain			
19	Channel 1 average times	Range: 1–100	R/W	10

CR#	Name	Description	Atr.	Defaults
20	Channel 2 average times			
21	Channel 3 average times			
22	Channel 4 average times			
23	Channel 5 average times			
24	Channel 6 average times			
25	Channel 1 filter average percentage			
26	Channel 2 filter average percentage			
27	Channel 3 filter average percentage	Range: 0–3		
28	Channel 4 filter average percentage	Unit: ±10%	R/W	1
29	Channel 5 filter average percentage			
30	Channel 6 filter average percentage			
31	Units of temperature	0: Fahrenheit 1: Celsius	R/W	0
32	Channel alarm setup	0: open channel alarm 1: close channel alarm bit0: channel 1 bit1: channel 2 bit2: channel 3 bit3: channel 4 bit4: channel 5 bit5: channel 6 0: warning 1: alarm bit8: error in the power supply bit9: error in the module hardware	R/W	0

CR#	Name	Description	Atr.	Defaults
		bit10: error in calibration		
201	Instruction set	16#0101: record the peak value again for channel 1 16#0102: record the peak value again for channel 2 16#0104: record the peak value again for channel 3 16#0108: record the peak value again for channel 4 16#110: record the peak values again for channels 5 16#120: record the peak values again for channels 6 16#013: record the peak values again for channels 1-6 16#0201: enable recording for channel 1 16#0202: enable recording for channel 2 16#0204: enable recording for channel 3 16#0208: enable recording for channel 4 16#0210: enable recording for channels 5 16#0220: enable recording for channels 6 16#023F: enable recording for channels 1-6 16#0301: disable recording for channel 1 16#0302: disable recording for channel 2 16#0304: disable recording for channel 3 16#0308: disable recording for channel 4 16#0310: disable recording for channel 5 16#0320: disable recording for channel 6 16#033F: disable recording for channel1-6 16#0501: restore default settings, clear setting values in the Flash 16#0502: restore default settings, do not	W	0

CR#	Name	Description	Atr.	Defaults
		clear setting values in the Flash		
210	The maximum peak value for channel 1	Integer format; the maximum peak value for analog inputs	R	-
211	The maximum peak value for channel 2			-
212	The maximum peak value for channel 3			-
213	The maximum peak value for channel 4			-
214	The maximum peak value for channel 5			-
215	The maximum peak value for channel 6			-
216	The minimum peak value for channel 1	Integer format; the minimum peak value for analog inputs	R	-
217	The minimum peak value for channel 2			-
218	The minimum peak value for channel 3			-
219	The minimum peak value for channel 4			-
220	The minimum peak value for channel 5			-
221	The minimum peak value for channel 6			-
222	The time to record for channel 1	Unit: 100 ms Range: 1–100 The time to record the digital value for the channels	R/W	1
223	The time to record for channel 2			1
224	The time to record for channel 3			1
225	The time to record for channel 4			1
226	The time to record for channel 5			1
227	The time to record for channel 6			1
240	The number of records for channel 1	Range: 0–200, display the current records	R	0

CR#	Name	Description	Atr.	Defaults
241	The number of records for channel 2			0
242	The number of records for channel 3			0
243	The number of records for channel 4			0
244	The number of records for channel 5			0
245	The number of records for channel 6			0
4000 - 4199	Records for channel 1	200 records for channel 1	R	-
4500 - 4699	Records for channel 2	200 records for channel 2	R	-
5000 - 5199	Records for channel 3	200 records for channel 3	R	-
5500 - 5699	Records for channel 4	200 records for channel 4	R	-
6000 - 6199	Records for channel 4	200 records for channel 5	R	-
6500 - 6699	Records for channel 4	200 records for channel 6	R	-

6

6.2.6 Functions

Use the HWCONFIG utility software built into ISPSOft to set modes of operation and parameters.

- **Analog input**

Item	Function	Description
1	Enable/Disable a Channel	1. Enable or disable a channel. 2. If a channel is disabled, the total conversion time decreases.
2	Unit of Measurement	Select the unit of measurement: Fahrenheit or Celsius.
3	Calibration	Calibrate a linear curve.
4	Average	Conversion values are averaged and filtered.
5	Disconnection Detection	If the channel is open, the module can detect when it is disconnected. If the input is open-circuited, the module produces an alarm or a warning.
6	Channel Detection and Alarm	If an input signal exceeds the range of inputs that the hardware can receive, the module produces an alarm or a warning. You can disable this function.
7	Limit Detections for Channels	Save the maximum/minimum values for channels.
8	Records for Channels	Save the analog curves for channels.
9	PID Algorithm	PID control modes

1. Enable/Disable a Channel

An analog signal is converted into a digital signal at a rate of 200 ms per channel. If a channel is not used, you can disable it to decrease the total conversion time.

2. Unit of Measurement

Select the unit of measurement, Fahrenheit or Celsius, according to your needs.

3. Calibration

- To make a curve meet specific needs, calibrate the curve by changing the offset and the gain. The calibration range depends on the range of inputs that the hardware can receive. The formula is:

$$Output = \frac{(Input \times Gain)}{1000} + Offset$$

Example:

If the gain is 1000 and the offset is 0, the corresponding value for the original signal 0° C to 100° C is 0–1000. If you change the offset to 100, the calibrated value for the original signal 0° C to 100° C becomes 100–1100.

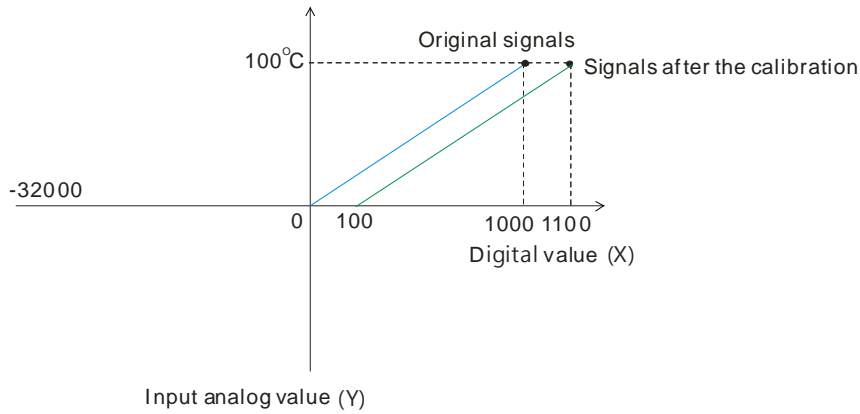

4. Average

You can set the average value between 1–100. It is a steady value obtained from the sum of the recorded values. If the recorded values include an acute pulse due to unavoidable external factors, however, you may observe violent changes in the average value. Use the filtering function to exclude the acute pulses from the sum-up and equalization, so the computed average value is not affected by the acute recorded values. Set the filter percentage to the range 0–3, where the unit is 10%. If you set the filter range to 0, the system sums up all the recorded values and divides them to obtain the average value, but if you set the filter range to 1, for example, the system excludes the bottom 10% and the top 10% of the values and averages only the remaining values to obtain the average value.

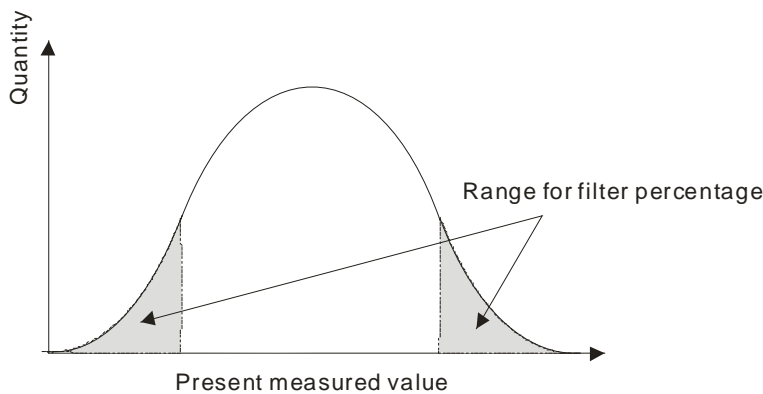

5. Disconnection Detection

If the channel is open, the module can detect when it is disconnected. If the input is open-circuited, the module produces an alarm or a warning.

6. Channel Detection

If an input signal exceeds the allowable range of inputs, an error message appears. You can disable this function so that the module does not produce an alarm or a warning when the input signal exceeds the input range.

7. Limit Detections for Channels

This function saves the maximum and minimum values for channels so that you can determine the peak to peak values.

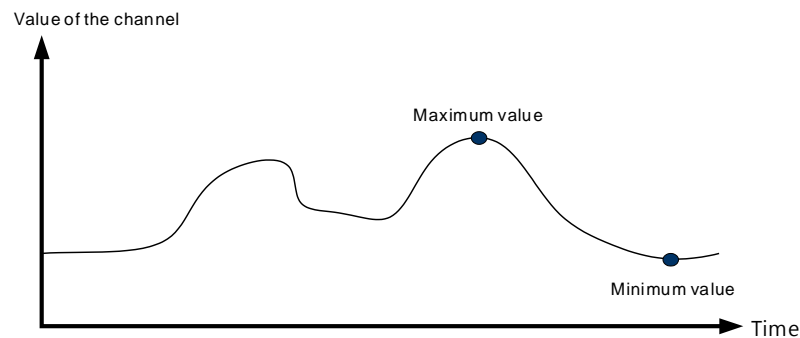

8. Records for Channels

Record the input values of the cyclic sampling for each channel. The system saves up to 500 data points for AS04RTD-A and up to 200 data points for AS06RTD-A and the recording time is 100 ms. The following uses AS04RTD-A as an example to demonstrate.

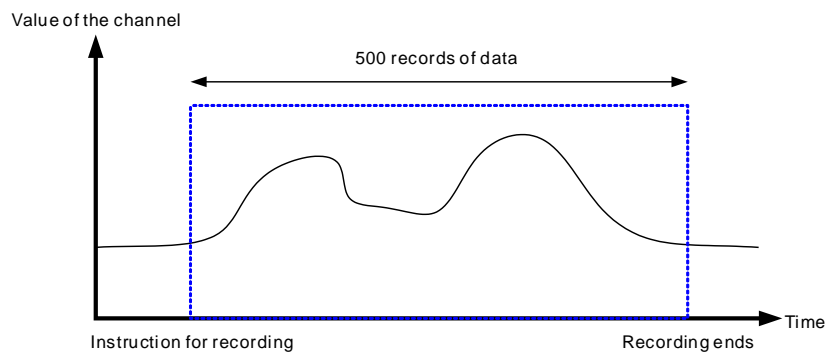

9. PID control

PID algorithm is available for every channel. With its auto tuning function, parameters such as K_p , K_i , K_d and more can be calculated and therefore temperature control can be achieved. You can also use DMPID instruction to calculate relative parameters by entering the parameters in the endpoints of corresponding instruction image and you can then obtain the output values from the output endpoints.

Note: DMPID instruction is available for AS04RTD-A (V1.04 or later), AS06RTD-A (V1.00 or later), AS Series PLC (V1.06 or later) and AS-SCM (V2.04 or later).

6.2.7 Control Mode

1. Refer to section 7.2.7 for more details on how to use DMPID instruction.
2. When using PID parameters to set up control registers: PID control registers of AS04RTD-A are retainable; however PID control registers of AS06RTD-A are not retainable.

6.2.8 Wiring

- **Precautions**

To ensure the analog-to-digital module functions well and reliably, the external wiring must prevent noise. Before you install the cables, follow the precautions below.

- (1) To prevent a surge and induction, the AC cable and the input signal cables that are connected to the ASRTD Series must be separate cables.
- (2) Do not install the cable near a main circuit, a high-voltage cable, or a cable connected to a load which is not a PLC. In addition, the cable must not be bound to a main circuit, a high-voltage cable, or a cable connected to a load which is not a PLC.
- (3) Ground shielded cables and hermetically sealed cables separately.
- (4) Terminals with insulation sleeves cannot be arranged as a terminal block, so you should cover the terminals with insulation tubes.
- (5) Note: use cables with the same length (less than 200 m) and use wire resistance of less than 20 ohm.

- External wiring

(1) AS04RTD-A

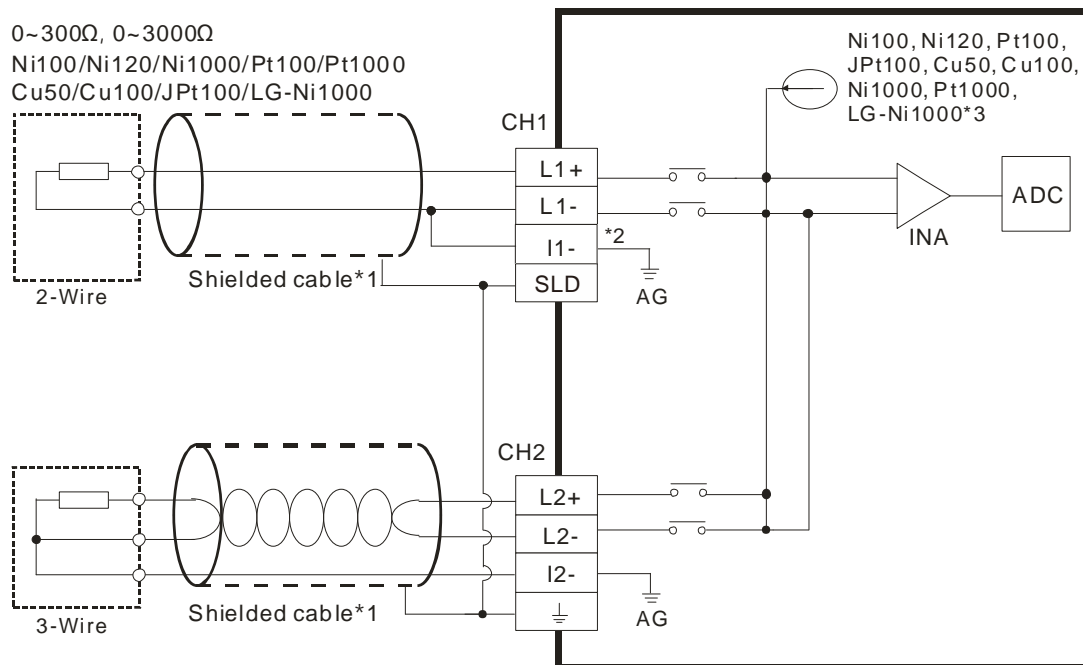

*1. Use shielded twisted pair cables for temperature sensors, and keep them away from power cables and other cables that generate noise.

*2. If using two-wire temperature sensors, L_n- and I_n- must be short-circuited (where n is between 1–4).

*3. There are two different internal excitation currents. If you are using a Ni100 temperature sensor, a Pt100 sensor, a JPt100, a Cu50/Cu100, or a 0~300 Ω resistance sensor, the internal excitation current is 1.5 mA. If you are using a Ni1000 temperature sensor, a Pt1000 temperature sensor, a LG-Ni1000 sensor, or a 0~3000 Ω resistance sensor, the internal excitation current is 0.2 mA.

Note: When using a three-wire temperature sensor, the cables should be the same length (less than 200 meter) and with a resistor less than 20 ohm.

(2) AS06RTD-A

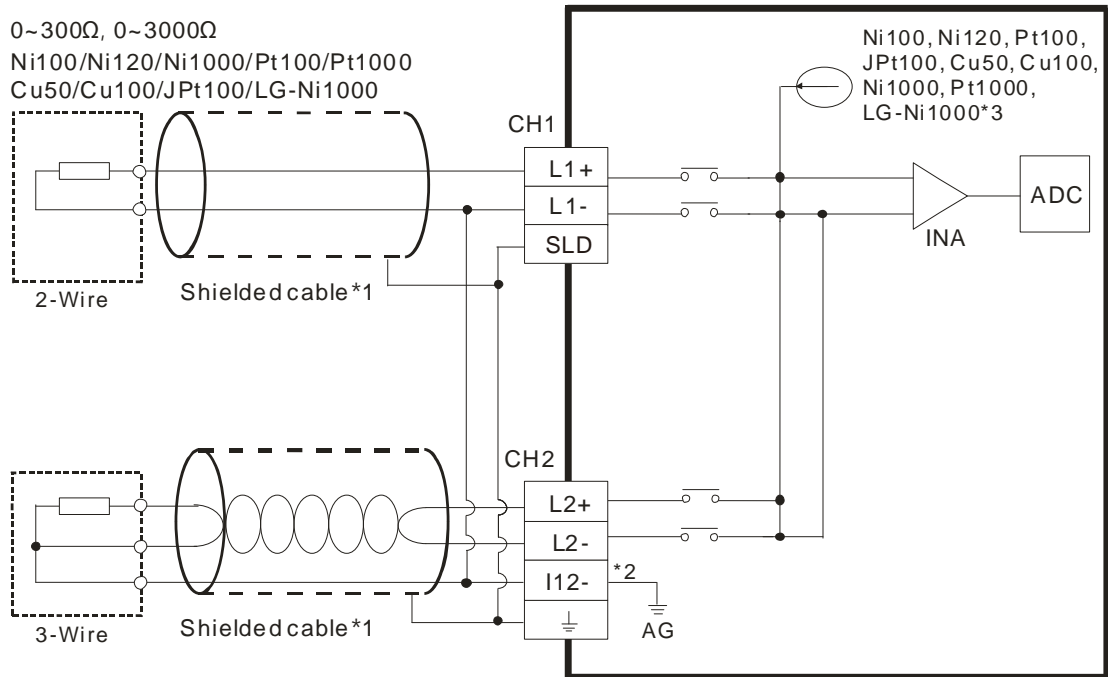

*1. Use shielded twisted pair cables for temperature sensors and keep them away from power cables and other cables that generate noise.

*2. Terminal "I12-" indicates " I1- & I2-", terminal "I34-" indicates " I3- & I4-", and terminal "I56-" indicates " I5- & I6-". If you use two-wire temperature sensors, Ln- and In- must be short-circuited (where n is between 1-6).

*3. There are two different internal excitation currents. If you are using a Ni100 temperature sensor, a Pt100 sensor, a JPt100, a Cu50/Cu100, or a 0~300 Ω resistance sensor, the internal excitation current is 1.0 mA. If you are using a Ni1000 temperature sensor, a Pt1000 temperature sensor, a LG-Ni1000 sensor, or a 0~3000 Ω resistance sensor, the internal excitation current is 0.2 mA.

Note: When using a three-wire temperature sensor, the cables should be the same length (less than 200 meter) and with a resistor less than 20 ohm.

6.2.9 LED Indicators

Number	Name	Description
1	RUN LED Indicator	Operating status of the module ON: the module is running. OFF: the module is not running.
2	ERROR LED Indicator	Error status of the module ON: a serious error exists in the module. OFF: the module is operating normally. Blink: a minor error exists in the module.
3	Analog-to-Digital Conversion Indicator	Conversion status Blinking: conversion is in process. OFF: conversion has stopped.

6.3. HWCONFIG in ISPSoft

6.3.1 Initial Setting

The following users AS04RTD-A as an example to demonstrate.

- (1) Start ISPSoft and double-click **HWCONFIG**.

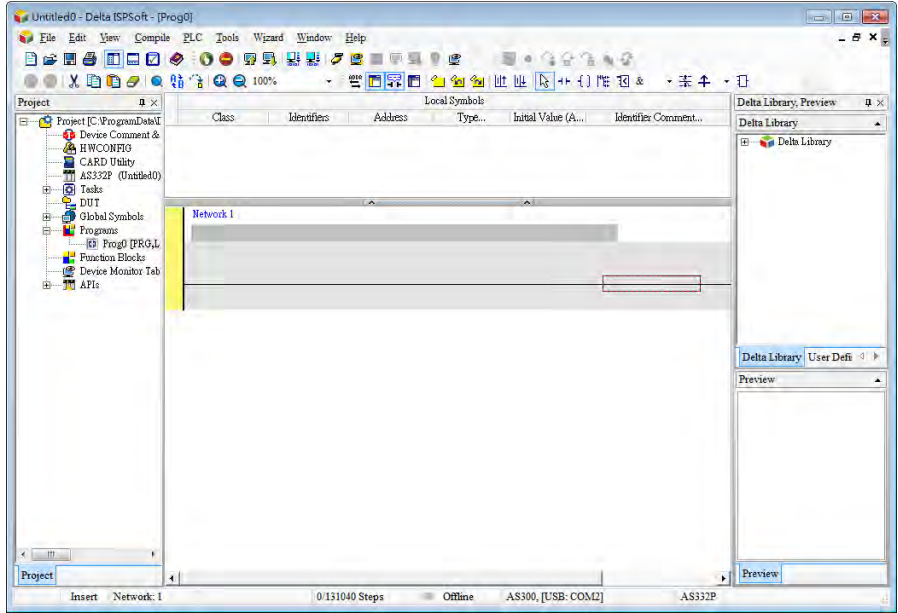

- (2) Select a module and drag it to the working area.

6

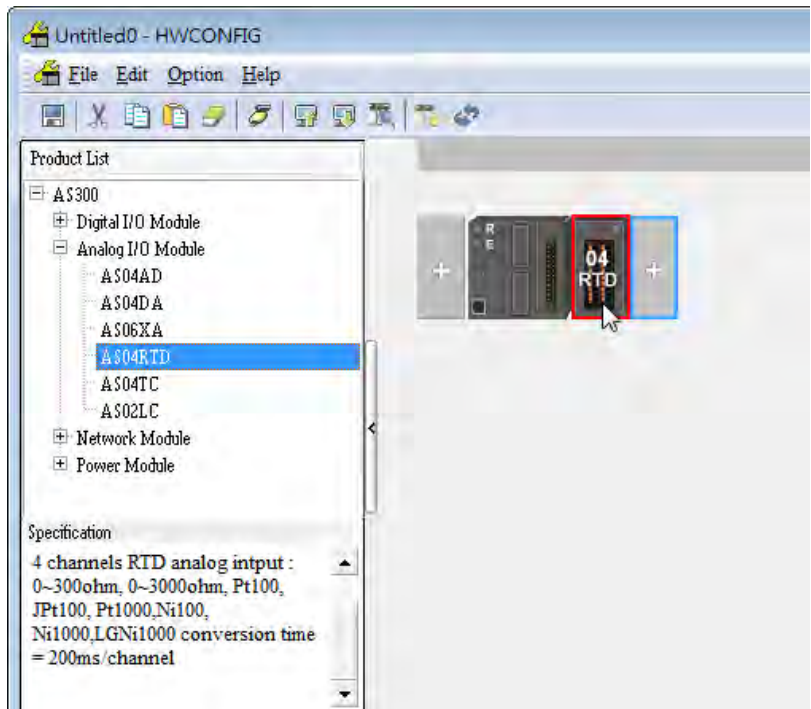

- (3) Double-click the module in the working area to open the Device Setting page.

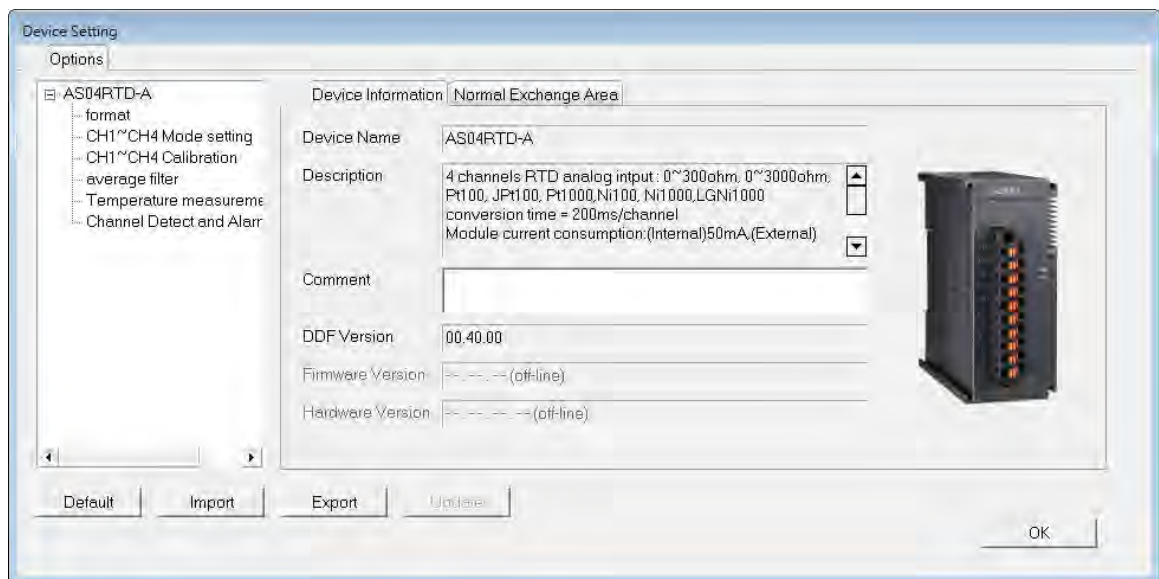
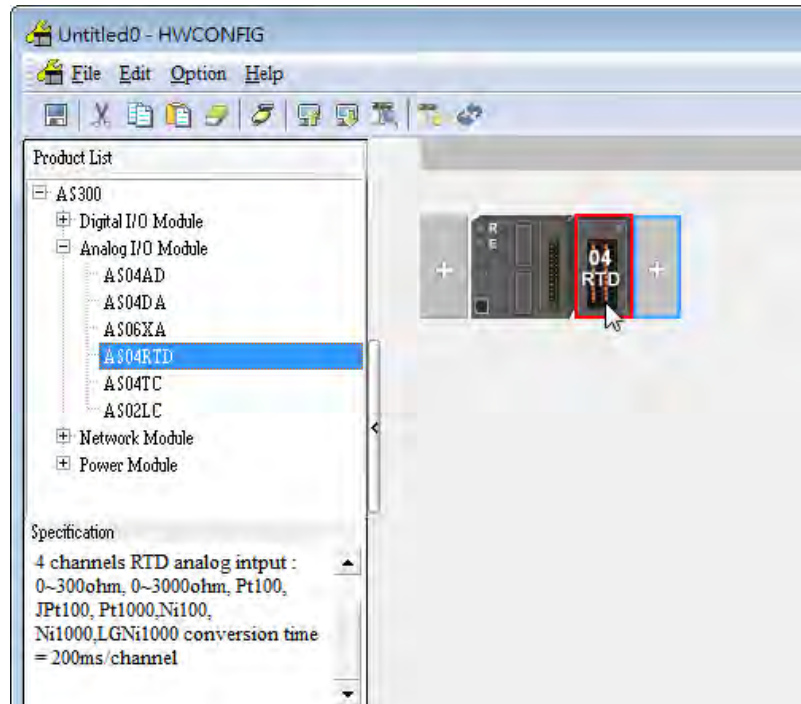

(4) Choose the parameter, set the values, and click **OK**.

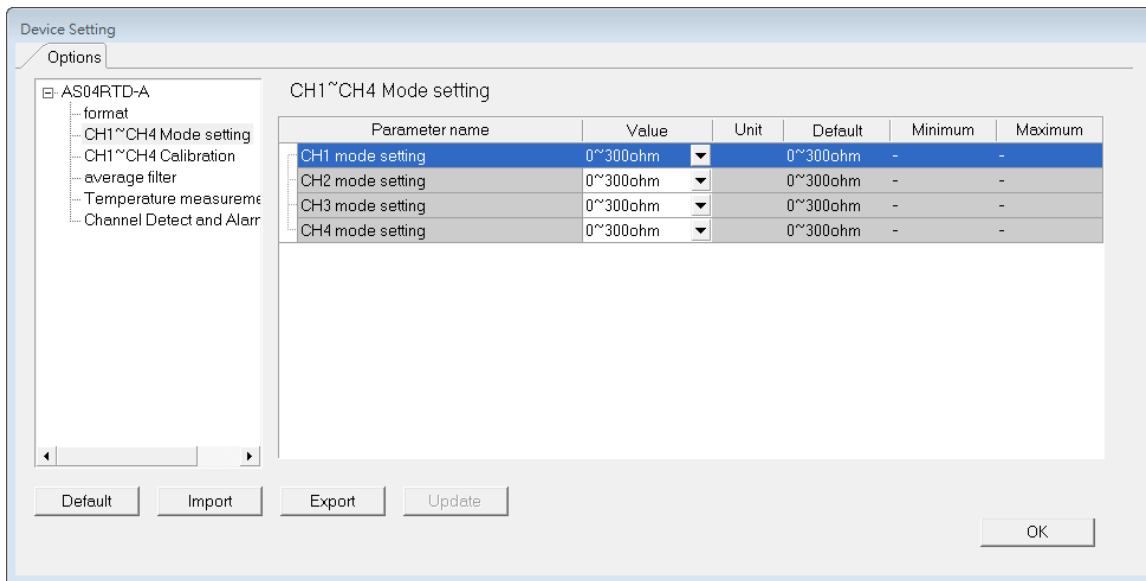

(5) Click **Download** on the toolbar to download the parameters. Note that you cannot download the parameters while the CPU module is running.

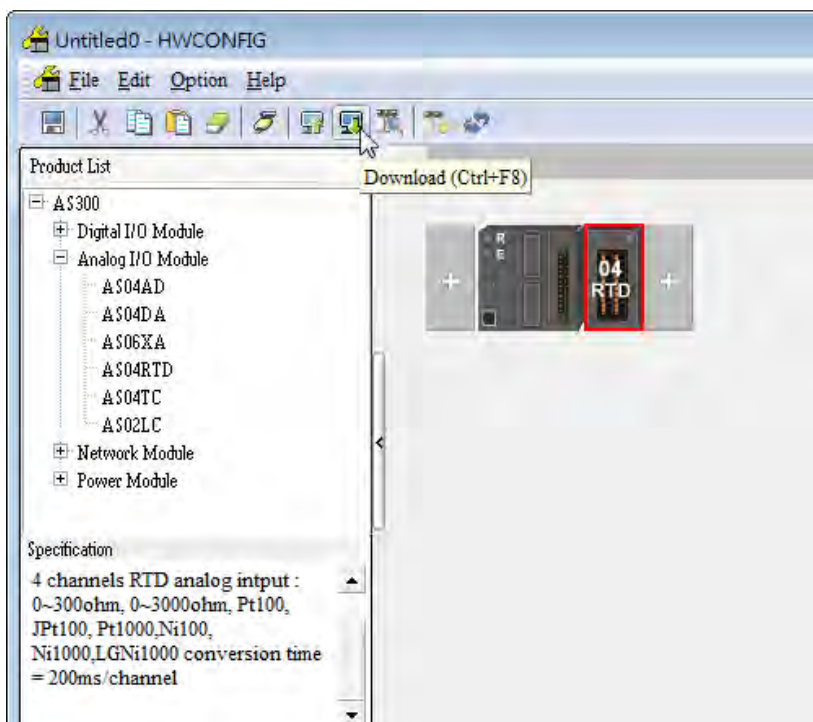

6.3.2 Checking the Version of a Module

- (1) On the **Option** menu, click **Online Mode**.

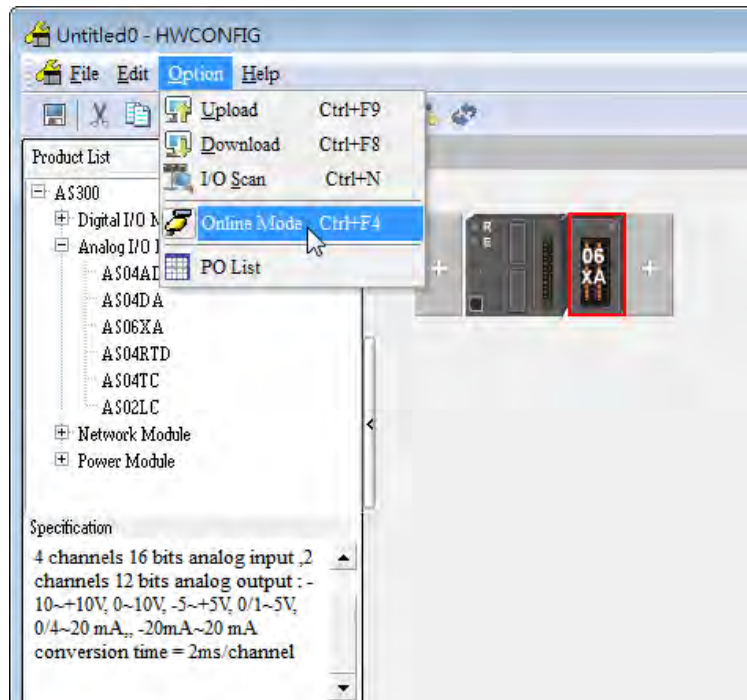

- (2) Double-click the module to open the Device Setting page. The versions of both the firmware and the hardware are displayed.

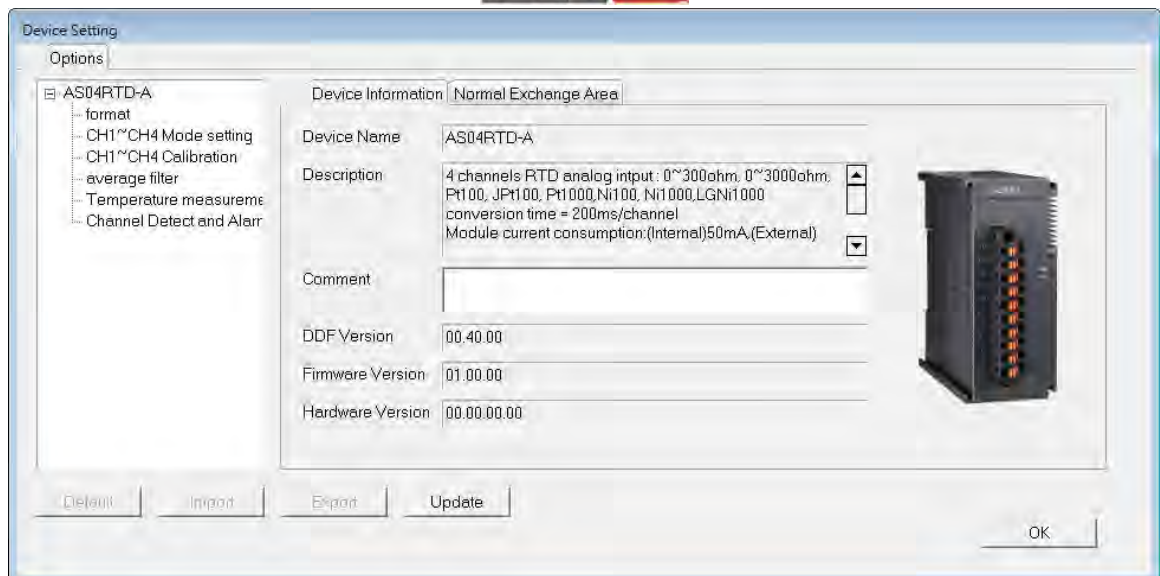

6.3.3 Online Mode

(1) On the **Option** menu, click **Online Mode**.

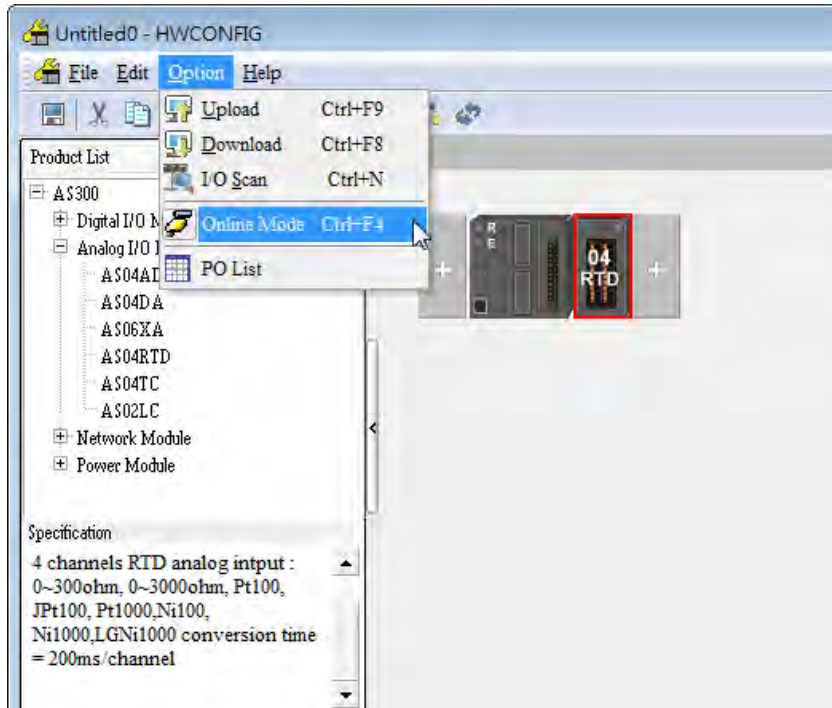

(2) Right-click the module and click **Module Status**.

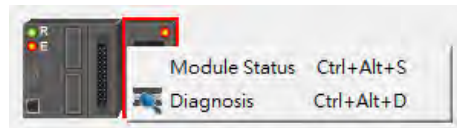

(3) View the module status.

Channel	Value (32 bits)	Data Type
Error code	6145	DECIMAL
CH1 Input	0	DECIMAL
CH2 Input	0	DECIMAL
CH3 Input	0	DECIMAL
CH4 Input	0	DECIMAL

6.3.4 Importing/Exporting a Parameter File

(1) Click **Export** in the Device Setting dialog box to save the current parameters as a CSV file (.csv).



(2) Click **Import** in the Device Setting dialog box and select a CSV file to import saved parameters.

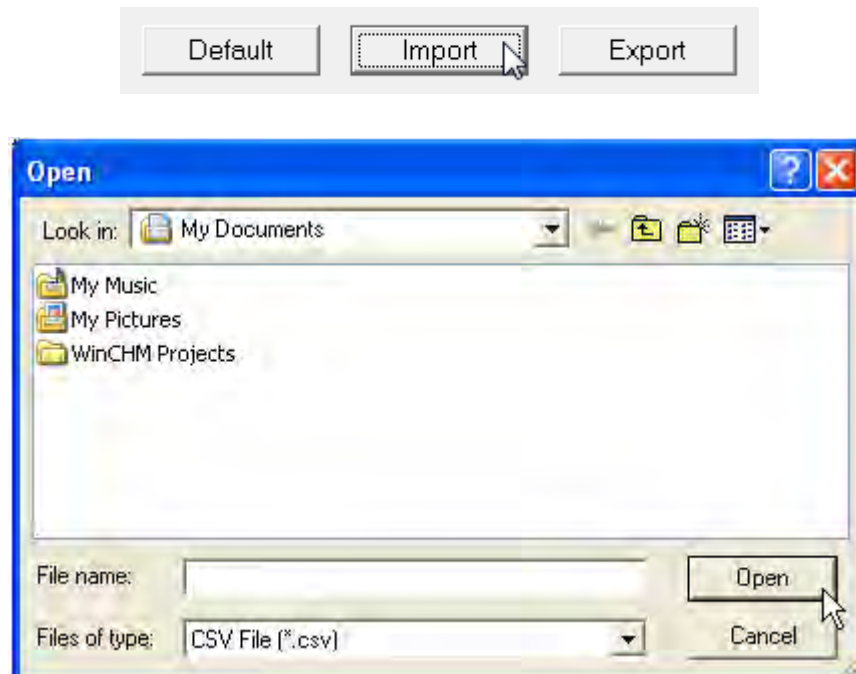

6.3.5 Parameters

(1) The input modes of the channels

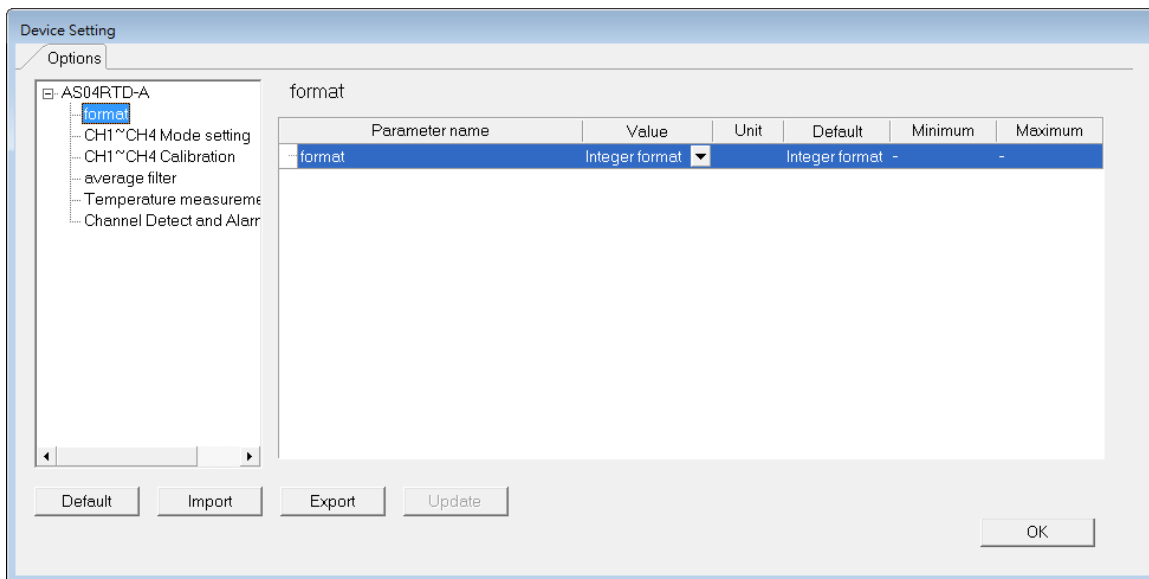

(2) Input CH1–CH4 (channel 1–channel 4) mode settings

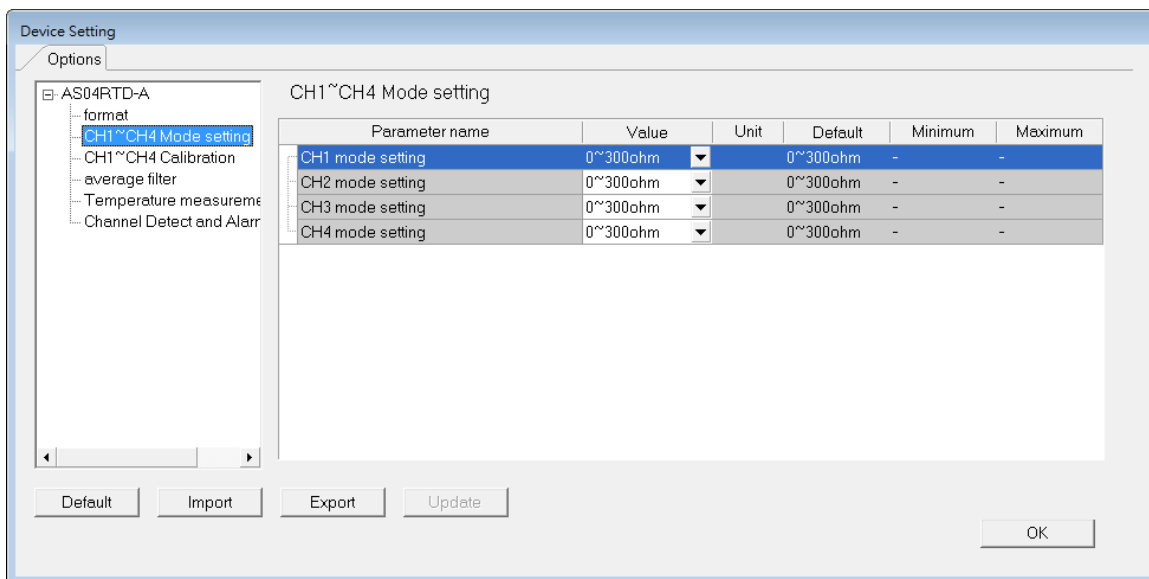

(3) Input CH1-CH4 calibration

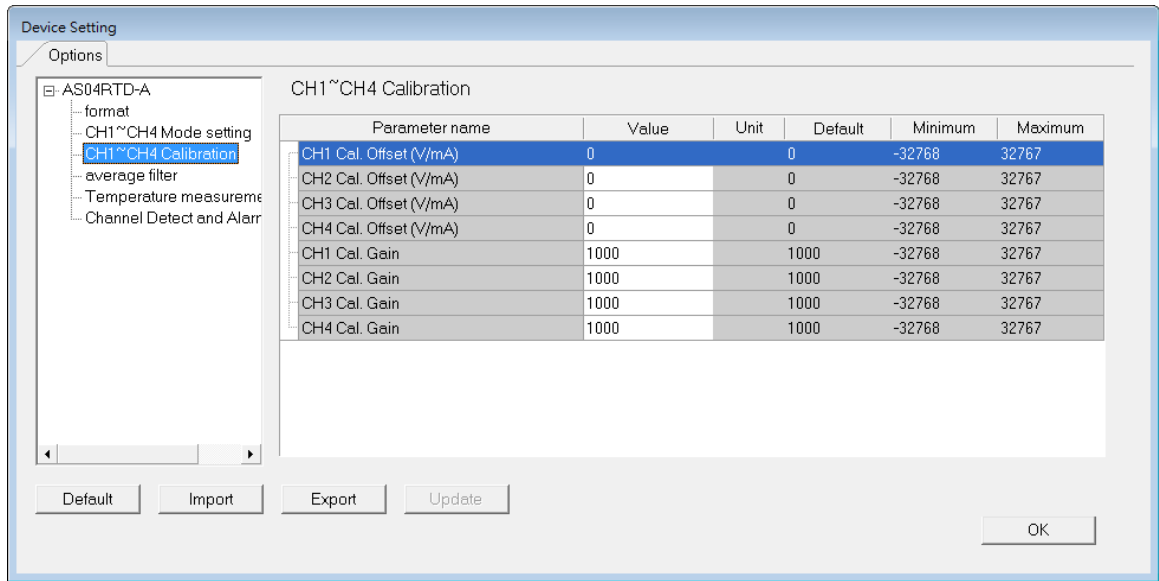

(4) Input average filter

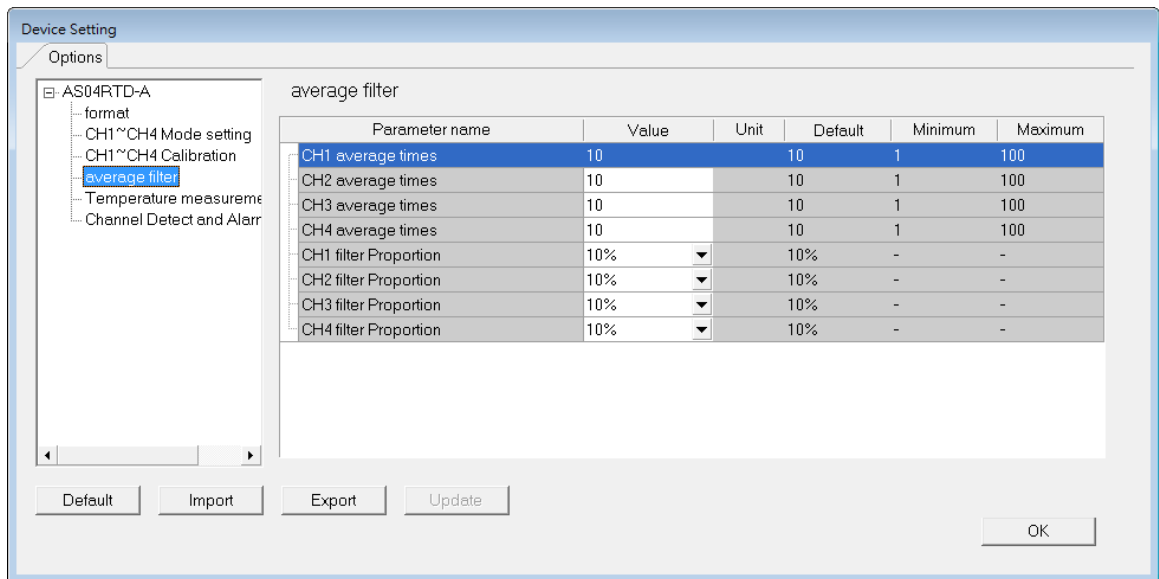

(5) Temperature measurement

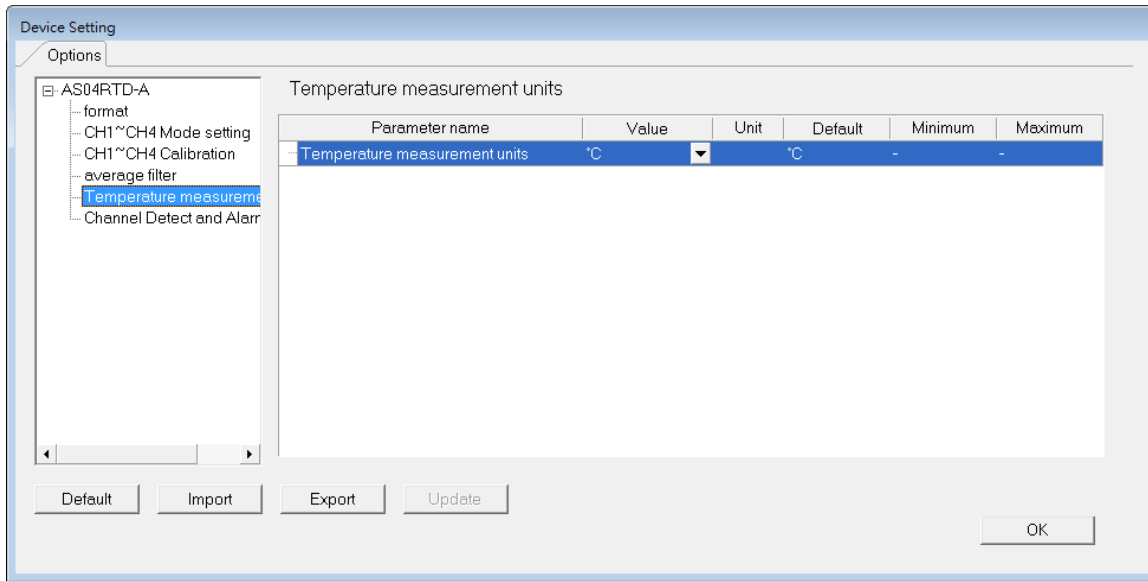

(6) Input channel detection and alarm settings

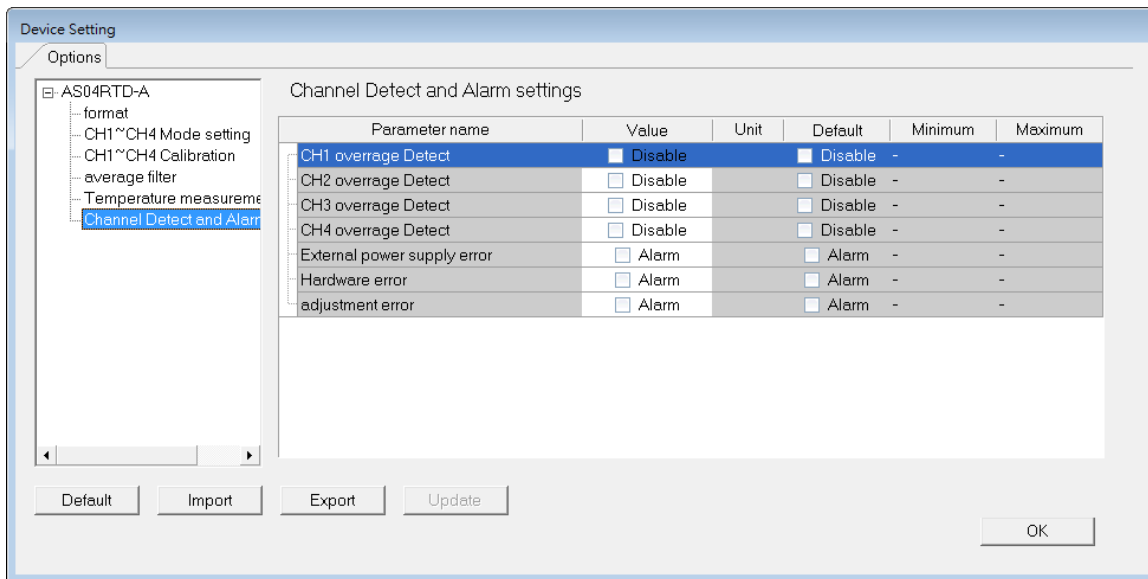

6.4 DIADesigner-AX (Hardware Configuration)

The following example uses AS04DTD-A.

6.4.1 Initial Setting

- (1) Start DIADesigner-AX, click **New Project**, and then **Project+Device** to create a new project.

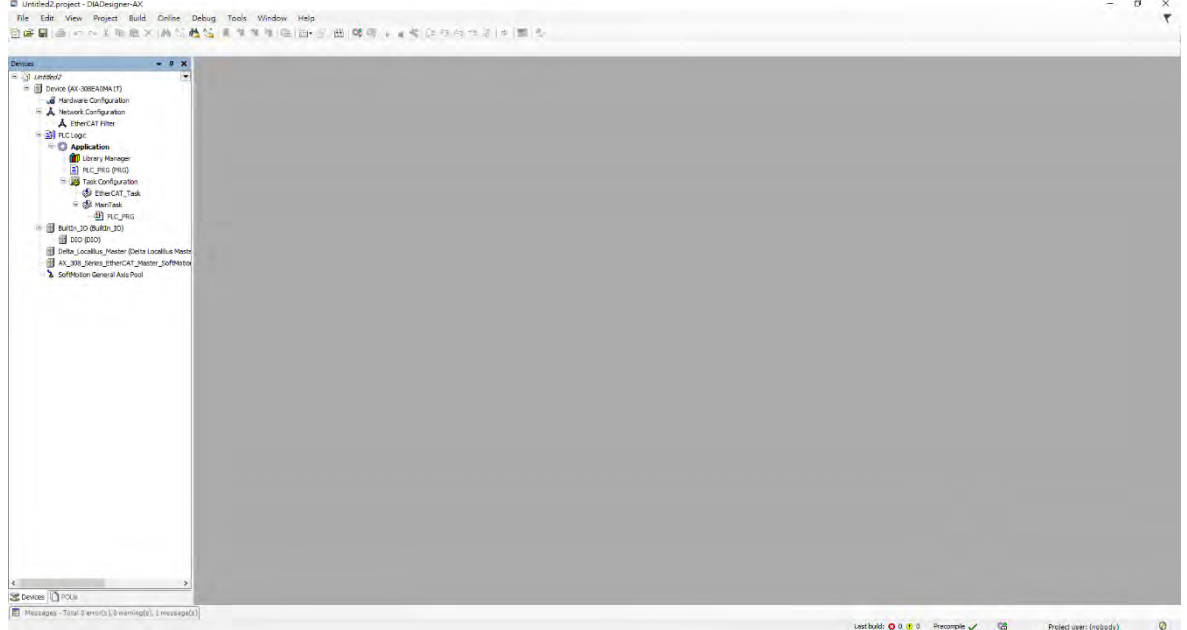

- (2) Add modules in:

- ① Double-click **Hardware Configuration**
- ② Select the **+** section and drag and drop the module that you want to add from the Product List to the **+** section.

or ③ Right-click **Delta_Localbus Master** to see the context menu and then double-click **Add Device** to add devices manually or double-click **Scan for Devices**.

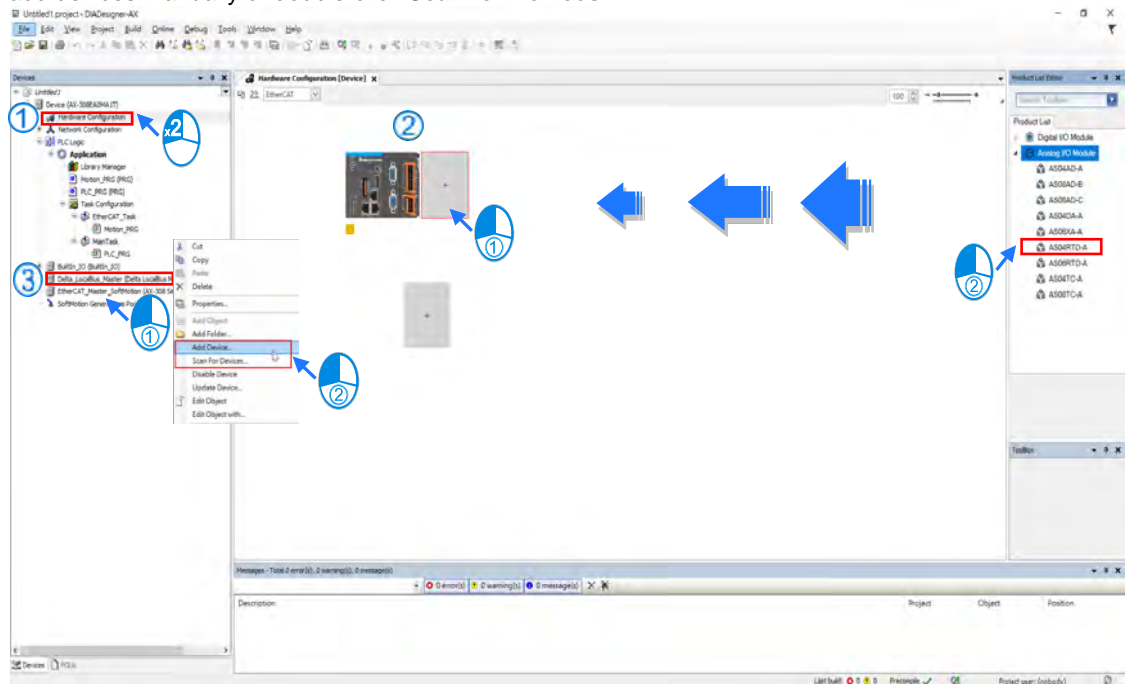

(3) Select modules:

- ① Double-click the module name in the **Hardware Configuration** area.
- or ② Double-click the module name shown in the node.

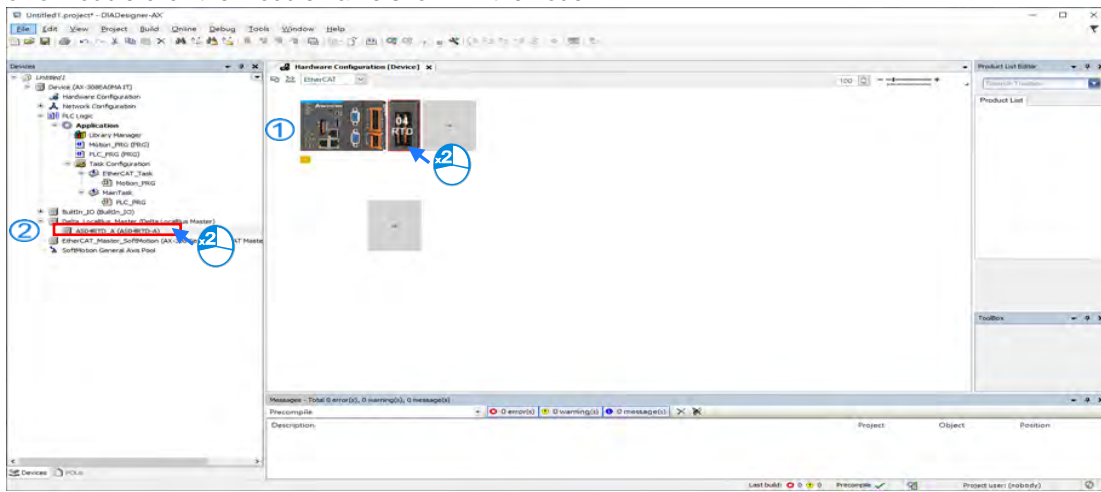

(4) Module parameter setting page:

AS04RTD-A Parameters	Parameter	Type	Value	Default Value	Unit	Description
AS04RTD-A I/O Mapping	Format	Enumeration of UINT	Integer	Integer		
Status	CH1~CH4 Mode Setting	Enumeration of WORD	0~300ohm	0~300ohm		
Information	CH1 Mode Setting	Enumeration of WORD	0~300ohm	0~300ohm		
	CH2 Mode Setting	Enumeration of WORD	0~300ohm	0~300ohm		
	CH3 Mode Setting	Enumeration of WORD	0~300ohm	0~300ohm		
	CH4 Mode Setting	Enumeration of WORD	0~300ohm	0~300ohm		
	CH1~CH4 Calibration					
	CH1 Cal. Offset (V/mA)	INT(-32768..32767)	0	0		
	CH2 Cal. Offset (V/mA)	INT(-32768..32767)	0	0		
	CH3 Cal. Offset (V/mA)	INT(-32768..32767)	0	0		
	CH4 Cal. Offset (V/mA)	INT(-32768..32767)	0	0		
	CH1 Cal. Gain	INT(-32768..32767)	1000	1000		
	CH2 Cal. Gain	INT(-32768..32767)	1000	1000		
	CH3 Cal. Gain	INT(-32768..32767)	1000	1000		
	CH4 Cal. Gain	INT(-32768..32767)	1000	1000		
	Average Filter					
	CH1 Average Times	WORD(1..100)	10	10		
	CH2 Average Times	WORD(1..100)	10	10		
CH3 Average Times	WORD(1..100)	10	10			
CH4 Average Times	WORD(1..100)	10	10			
CH1 Filter Proportion	Enumeration of WORD	10%	10%			
CH2 Filter Proportion	Enumeration of WORD	10%	10%			
CH3 Filter Proportion	Enumeration of WORD	10%	10%			
CH4 Filter Proportion	Enumeration of WORD	10%	10%			
Temperature Measurement Units						
Temperature measurement units	Enumeration of WORD	°C	°C			
Channel Detect and Alarm Settings						
CH1 Overrange Detect	BOOL	FALSE	FALSE			
CH2 Overrange Detect	BOOL	FALSE	FALSE			
CH3 Overrange Detect	BOOL	FALSE	FALSE			
CH4 Overrange Detect	BOOL	FALSE	FALSE			
Reserved	BOOL	FALSE	FALSE			
Reserved	BOOL	FALSE	FALSE			
Reserved	BOOL	FALSE	FALSE			
Reserved	BOOL	FALSE	FALSE			
External Power Supply Error	BOOL	FALSE	FALSE			
Hardware Error	BOOL	FALSE	FALSE			
Adjustment Error	BOOL	FALSE	FALSE			
Module Revision	DWORD	0	0		Module Firmware Revision	

- After setting is complete, select the module and click **Login** on the tool bar to download the settings to the modules.

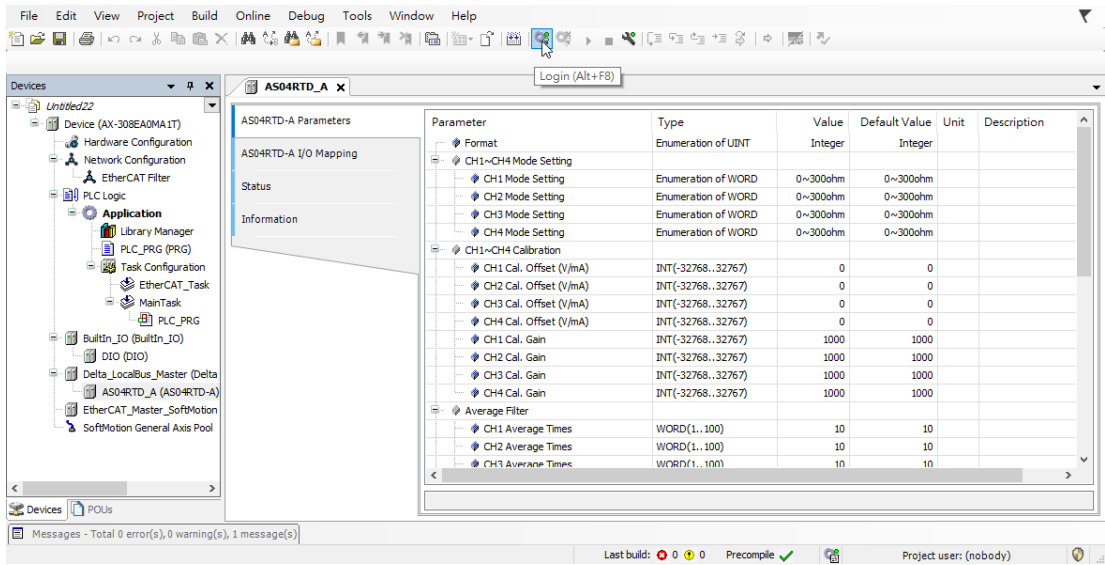

6.4.2 Checking the Version of a Module

- Select the module and click the Information tab to see the module information.



- Select the module and click **Login** on the tool bar to go to Online Mode. You can find the Module Revision from the Parameters tab.

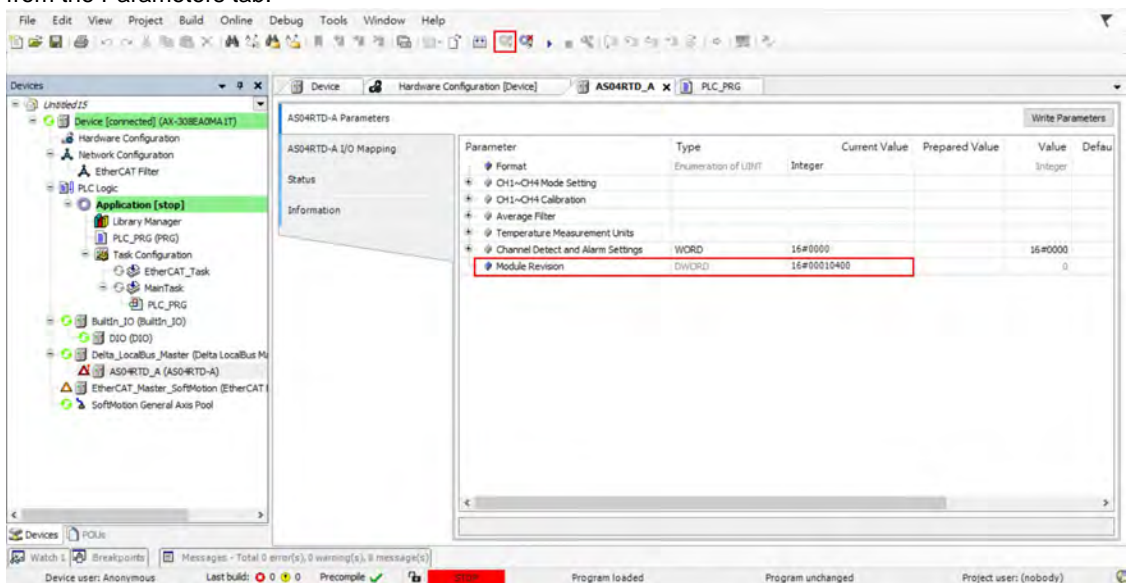

6.4.3 Online Mode

- Select the module and click **Login** on the tool bar to go to **Online Mode**. You can monitor all configuration parameters. Values in the column of Prepared Value are configurable online. After editing the values in the Prepared Value column, click **Write Parameter** to confirm the change.

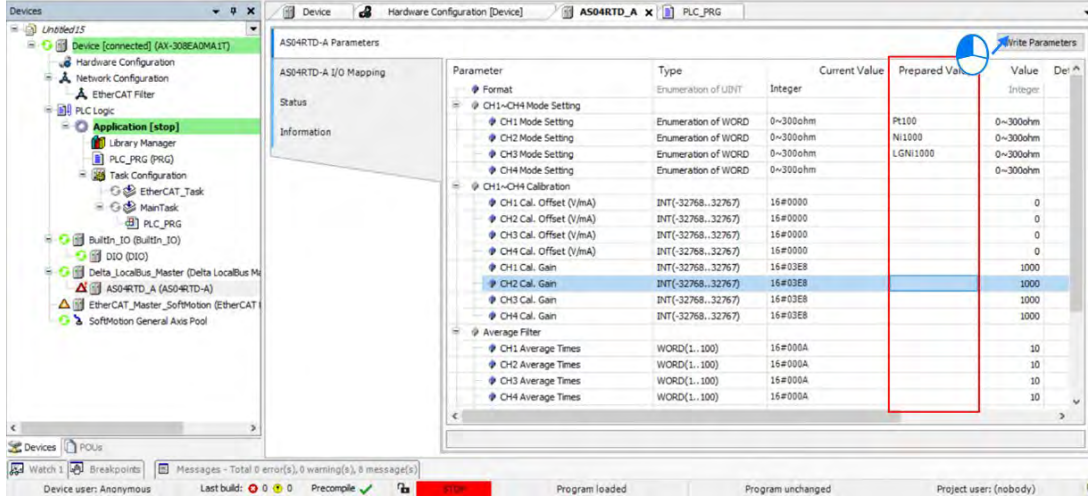

- You can monitor the values, status, error codes in each channel from the I/O Mapping tab.

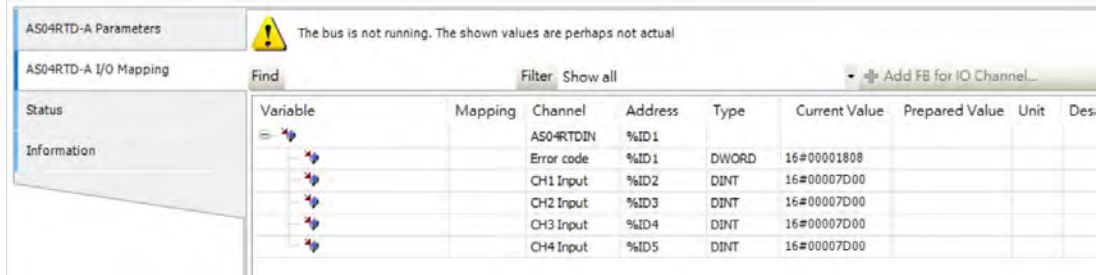

- You can monitor the current status and error codes from the Status tab.



6.4.4 Parameters

- (1) You can set up the value format to **Integer** or **Floating** for Channel 1 to 4.

Parameter	Type	Value	Default Value	Unit	Description
Format	Enumeration of UINT	Integer	Integer		
CH1~CH4 Mode Setting					
CH1 Mode Setting	Enumeration of WORD	Integer	Integer	V~+10V	
CH2 Mode Setting	Enumeration of WORD	-10V~+10V	-10V~+10V	V~+10V	
CH3 Mode Setting	Enumeration of WORD	-10V~+10V	-10V~+10V		
CH4 Mode Setting	Enumeration of WORD	-10V~+10V	-10V~+10V		

- (2) You can set up the values for Channel 1 to 4.

CH1~CH4 Mode Setting					
CH1 Mode Setting	Enumeration of WORD	0~300ohm	0~300ohm		
CH2 Mode Setting	Enumeration of WORD	Close	0~300ohm	ohm	
CH3 Mode Setting	Enumeration of WORD	0~300ohm	0~300ohm	ohm	
CH4 Mode Setting	Enumeration of WORD	0~3000ohm	0~3000ohm	ohm	
CH1~CH4 Calibration					
CH1 Cal. Offset (V/mA)	INT(-32768..32767)			0	
CH2 Cal. Offset (V/mA)	INT(-32768..32767)			0	
CH3 Cal. Offset (V/mA)	INT(-32768..32767)			0	
CH4 Cal. Offset (V/mA)	INT(-32768..32767)			0	
CH1 Cal. Gain	INT(-32768..32767)	1000	1000	1000	
CH2 Cal. Gain	INT(-32768..32767)	1000	1000	1000	
CH3 Cal. Gain	INT(-32768..32767)	1000	1000	1000	
CH4 Cal. Gain	INT(-32768..32767)	1000	1000	1000	

- (3) You can set up the calibrations for for Channel 1 to 4.

CH1~CH4 Calibration					
CH1 Cal. Offset (V/mA)	INT(-32768..32767)	0	0		
CH2 Cal. Offset (V/mA)	INT(-32768..32767)	0	0		
CH3 Cal. Offset (V/mA)	INT(-32768..32767)	0	0		
CH4 Cal. Offset (V/mA)	INT(-32768..32767)	0	0		
CH1 Cal. Gain	INT(-32768..32767)	1000	1000		
CH2 Cal. Gain	INT(-32768..32767)	1000	1000		
CH3 Cal. Gain	INT(-32768..32767)	1000	1000		
CH4 Cal. Gain	INT(-32768..32767)	1000	1000		

- (4) You can set up the average filtering for Channel 1 to 4.

Average Filter					
CH1 Average Times	WORD(1..100)	10	10		
CH2 Average Times	WORD(1..100)	10	10		
CH3 Average Times	WORD(1..100)	10	10		
CH4 Average Times	WORD(1..100)	10	10		
CH1 Filter Proportion	Enumeration of WORD	10%	10%		
CH2 Filter Proportion	Enumeration of WORD	10%	10%		
CH3 Filter Proportion	Enumeration of WORD	10%	10%		
CH4 Filter Proportion	Enumeration of WORD	10%	10%		

(5) You can set up the temperature measurement units.

Temperature Measurement Units				
Temperature measurement units	Enumeration of WORD	°C	°C	
Channel Detect and Alarm Settings	WORD	16#0000		
Module Revision	DWORD	0	0	

(6) You can set up the channel detect and alarm settings.

Channel Detect and Alarm Settings	WORD	0		
CH1 Overrange Detect	BOOL	FALSE	FALSE	
CH2 Overrange Detect	BOOL	FALSE	FALSE	
CH3 Overrange Detect	BOOL	FALSE	FALSE	
CH4 Overrange Detect	BOOL	FALSE	FALSE	
Reserved	BOOL	FALSE	FALSE	
Reserved	BOOL	FALSE	FALSE	
Reserved	BOOL	FALSE	FALSE	
Reserved	BOOL	FALSE	FALSE	
External Power Supply Error	BOOL	FALSE	FALSE	
Hardware Error	BOOL	FALSE	FALSE	
Adjustment Error	BOOL	FALSE	FALSE	

6.5 Troubleshooting

6.5.1 Error Codes

Error Code	Description	A↔ D LED Indicator	ERROR LED Indicator
16#1605	Hardware failure	OFF	ON
16#1607	The external voltage is abnormal.	OFF	ON
16#1608	The factory calibration is abnormal.	OFF	ON
16#1801	The external voltage is abnormal.	OFF	Blinking
16#1802	Hardware failure	OFF	Blinking
16#1804	The factory calibration is abnormal.	OFF	Blinking
16#1808	The signal received by channel 1 exceeds the range of inputs that the hardware can receive.	Run: blinking Stop: OFF	Blinking
16#1809	The signal received by channel 2 exceeds the range of inputs that the hardware can receive.		
16#180A	The signal received by channel 3 exceeds the range of inputs that the hardware can receive.		
16#180B	The signal received by channel 4 exceeds the range of inputs that the hardware can receive.		
16#180C	The signal received by channel 5 exceeds the range of inputs that the hardware can receive.		
16#180D	The signal received by channel 6 exceeds the range of inputs that the hardware can receive.		
-	When power-on, the module is not detected by CPU module.	OFF	Blinking once or twice and after 2 seconds, it blinks repeatedly

6.5.2 Troubleshooting Procedure

Description	Procedure
The external voltage is abnormal.	Ensure the external 24 V power supply to the module is functioning normally.
Hardware failure	Return the module to the factory for repair.
Internal error The factory calibration is abnormal.	Contact the factory.
The signal received by channel 1 exceeds the range of inputs that the hardware can receive.	Check the signal received by channel 1.
The signal received by channel 2 exceeds the range of inputs that the hardware can receive.	Check the signal received by channel 2.
The signal received by channel 3 exceeds the range of inputs that the hardware can receive.	Check the signal received by channel 3.
The signal received by channel 4 exceeds the range of inputs that the hardware can receive.	Check the signal received by channel 4.
The signal received by channel 5 exceeds the range of inputs that the hardware can receive.	Check the signal received by channel 5.
The signal received by channel 6 exceeds the range of inputs that the hardware can receive.	Check the signal received by channel 6.
When power-on, the module is not detected by CPU module.	Check if the connection between module and CPU module is working. If not, connect again.

6.5.3 State of the Connection

State of connection			Channel value
L+	L-	I-	
•	•	•	Maximum value for the channel
•	•		Maximum value for the channel
•		•	Maximum value for the channel
•			Maximum value for the channel
	•	•	Maximum value for the channel
	•		Maximum value for the channel
		•	Minimum value for the channel*1

•: Disconnection

*1: for AS06RTD Series: in the modes of 0-300Ω and 0-3000Ω, it cannot detect I- state of connection.

MEMO

Chapter 7 Temperature Measurement Module AS04/08TC

Table of Contents

7.1 Overview	7-2
7.1.1 Characteristics	7-3
7.2 Specifications and Functions	7-4
7.2.1 Specifications	7-4
7.2.2 Profile	7-7
7.2.3 Arrangement of Terminals	7-8
7.2.4 AS04TC Control Registers.....	7-8
7.2.5 AS08TC Control Registers.....	7-12
7.2.6 Functions.....	7-18
7.2.7 Control Mode.....	7-21
7.2.8 Wiring	7-31
7.2.9 LED Indicators.....	7-32
7.3 HWCONFIG in ISPSOft	7-33
7.3.1 Initial Setting	7-33
7.3.2 Checking the Version of a Module	7-36
7.3.3 Online Mode	7-37
7.3.4 Importing/Exporting a Parameter File	7-38
7.3.5 Parameters	7-39
7.4 DIADesigner-AX (Hardware Configuration)	7-42
7.4.1 Initial Setting	7-42
7.4.2 Checking the Version of a Module	7-45
7.4.3 Online Mode.....	7-46
7.4.4 Parameters	7-47
7.5 Troubleshooting	7-49
7.5.1 Error Codes.....	7-49
7.5.2 Troubleshooting Procedure	7-50

7.1 Overview

This chapter describes the specifications for the ASTC-A module, its operation, and its programming. The AS04TC-A is a temperature measurement module that converts temperatures received from thermocouples (type J, K, R, S, T, E, N, B, C, U, L, or TXK with ± 100 mV voltage inputs) into digital signals. You can select either Celsius (resolution: 0.1° C) or Fahrenheit (resolution: 0.1° F) as the unit of measurement. For software operation, ISPSOft, DIADesigner or DIADesigner-AX is what you need. If you are using AS Series PLC CPU, refer to ISPSOft User Manual or DIADesigner Manual for more information. The new software DIADesigner-AX only supports AX Series PLC CPU and AS Series modules now, refer to AX-3 User Manual for more information on software operation.

An introduction to thermocouples

A thermocouple uses the Seebeck effect to measure differences in temperature. Generally speaking, a thermocouple consists of two conductors of different materials that produce a voltage at the point where the two conductors contact. The voltage produced depends on the difference of temperature between the junctions with other parts of those conductors, and it ranges from several dozen microvolts to several thousand microvolts. Because the voltage is so low, it needs to be amplified.

Differential operations are used to eliminate external noise. Thermocouples are more stable than thermistors, resistance thermometers, and thermal resistors, so thermocouples are widely used in industrial applications.

A thermocouple consists of a circuit having two wires of different metals or metal alloys welded together or joined at both ends. One of the junctions—normally the cold junction—is maintained at a known reference temperature, and the other junction is at the temperature to be sensed. A temperature gradient across the junction of the wires gives rise to an electric potential according to the Seebeck effect. The voltage produced is proportional to the difference of temperature between the junctions with other parts of those conductors.

The voltage can be derived from the following equation.

$$V = \int_{T_1}^{T_2} (Q_A - Q_B) dT \quad (A)$$

where Q_A and Q_B are the thermopowers (Seebeck coefficient) of the metals A and B, and T_1 and T_2 are the temperatures of the two junctions.

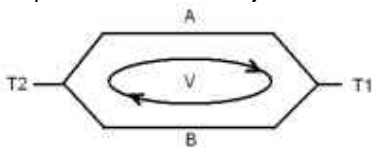

Principle of operation

Because Q_A and Q_B are almost unrelated to temperature, formula (A) above can be approximated as in equation (B).

$$V = \alpha(T_2 - T_1) \quad (B)$$

There are two types of thermocouple thermometers: wrapped thermocouples and bare thermocouples. A wrapped thermocouple is wrapped in protective metal, and is similar to an electric spoon in appearance. Wrapped thermocouples are used to measure temperature of liquid, and bare thermocouples are used to measure temperature of gas.

7.1.1 Characteristics

(1) **Select a sensor based on its practical application.**

Type J, K, R, S, T, E, N, B, C, U, L, or TXK thermocouples, with ± 100 mV voltage inputs.

(2) **Select a module based on its practical application.**

AS04TC-A: Has four channels. Inputs received by a channel are temperatures.

AS08TC-A: Has eight channels. Inputs received by a channel are temperatures.

(3) **High-speed conversion**

A temperature is converted into a digital signal at a speed of 200 ms per channel.

(4) **High accuracy**

Conversion accuracy: the error range is $\pm 0.5\%$ of the input at ambient temperature of $25^{\circ}\text{C} \pm 5^{\circ}\text{C}$.

(5) **Disconnection detection**

When a sensor is disconnected, the module produces an alarm or a warning.

(6) **PID control**

An object's temperature can be maintained through PID control actions.

(7) **Use the utility software to configure the module.**

The HWCONFIG utility software is built into ISPSOft. You can set modes and parameters directly in HWCONFIG of ISPSOft or Hardware Configuration of DIADesigner without spending time writing programs to set registers to manage functions.

7.2 Specifications and Functions

7.2.1 Specifications

- Electrical specifications

Module Name	AS04TC-A	AS08TC-A
Number of Analog Inputs	4	8
Applicable Sensor	Type J, K, R, S, T, E, N, B, C, U, L, or TXK with ± 100 mV voltage inputs	
Supply Voltage	24 VDC (20.4–28.8 VDC) (-15% to +20%)	
Connector Type	Removable terminal block	
Overall Accuracy	25° C/77° F: The error range allowed is $\pm 0.5\%$ of full scale. -20° C to +60° C/-4° F to +140° F: the error range allowed is $\pm 1\%$ of full scale.	
Resolution	0.1°C / 0.1°F	
Conversion Time	200 ms/channel	
Isolation	<p>An analog circuit is isolated from a digital circuit by a digital integrated circuit/optocoupler, and the analog channels are isolated from one another by optocouplers.</p> <p>Isolation between a digital circuit and the ground: 500 VAC Isolation between an analog circuit and the ground: 500 VAC Isolation between an analog circuit and a digital circuit: 500 VAC Isolation between the 24 VDC and the ground: 500 VAC Isolation between analog channels: 120 VAC</p>	
Weight	115g	125g

- **Functional specifications**

Analog-to-Digital Conversion	Centigrade (°C)	Fahrenheit (°F)	Voltage Input
Rated Input Range^{*1}	Type J: -100° C to +1,200° C Type K: -100° C to +1,350° C Type R: 0° C to 1,750° C Type S: 0° C to 1,750° C Type T: -150° C to +400° C Type E: -150° C to +980° C Type N: -150° C to +1,300° C Type B: 200° C to +1,800° C Type C: 0° C to 2,320° C Type U: -200° C to 600° C Type L: -200° C to 900° C Type TXK: -200° C~800° C	Type J: -148° F to +2,192° F Type K: -148° F to +2,462° F Type R: 32° F to 3,182° F Type S: 32° F to 3,182° F Type T: -238° F to +734° F Type E: -238° F to +1,796° F Type N: -238° F to +2,372° F Type B: 392° F to 3,272° F Type C: NA Type U: -328° F~1,112° F Type L: -328° F~1,652° F Type TXK: -328° F~1,472° F	±100 mV
Maximum Measurable Range^{*2}	Type J: -210° C to +1,200° C Type K: -250° C to +1,350° C Type R: -50° C to 1,760° C Type S: -50° C to 1,760° C Type T: -250° C to +400° C Type E: -250° C to +1000° C Type N: -250° C to +1,300° C Type B: 20° C to +1,800° C Type C: 0° C to 2,320° C Type U: -200° C to 600° C Type L: -200° C to 900° C Type TXK: -200° C~800° C	Type J: -346° F to +2,192° F Type K: -418° F to +2,462° F Type R: -58° F to 3,200° F Type S: -25° F to 3,200° F Type T: -418° F to +752° F Type E: -418° F to +2,372° F Type N: -418° F to +2,372° F Type B: 68° F to 3,272° F Type C: NA Type U: -328° F~1,112° F Type L: -328° F~1,652° F Type TXK: -328° F~1,472° F	±100 mV
Average Function	Range: 1-100		
Self-Diagnosis	Disconnection detection		

*1 If the measured temperature exceeds the upper limit, it only shows the maximum value. If the measured temperature is below the lower limit, it only shows the minimum value.

Conversion details

Centigrade (°C)			
Sensor type	Rated input range	Integer value range after digital conversion	Floating point value range after digital conversion
J	-100°C ~ 1200°C	K-1000 ~ K12000	-100.0 ~ 1200.0
K	-100°C ~ 1,350°C	K-1000 ~ K13500	-100.0 ~ 1350.0
R	0°C ~ 1,750°C	K0 ~ K17500	0.0 ~ 1750.0
S	0°C ~ 1,750°C	K0 ~ K17500	0.0 ~ 1750.0
T	-150°C ~ 400°C	K-1500 ~ K4000	-150.0 ~ 400.0
E	-150°C ~ 980°C	K-1500 ~ K9800	-150.0 ~ 980.0
N	-150°C ~ 1,300°C	K-1500 ~ K13000	-150.0 ~ 1300.0
B	200°C ~ 1,800°C	K2000 ~ K18000	200.0 ~ 1800.0
C	0°C ~ 2320°C	K0 ~ K23200	0.0 ~ 2320.0
U	-200°C ~ 600°C	K-2000 ~ K6000	-200.0 ~ 600.0
L	-200°C ~ 900°C	K-2000 ~ K9000	-200.0 ~ 900.0
TXK	-200°C ~ 800°C	K-2000 ~ K8000	-200.0 ~ 800.0
±100mV	-100mV ~ 100mV	K-10000 ~ K10000	-100.00 ~ 100.00

Fahrenheit (°F)			
Sensor type	Rated input range	Integer value range after digital conversion	Floating point value range after digital conversion
J	-148°F ~ 2,192°F	K-1480 ~ K21920	-148.0 ~ 2192.0
K	-148°F ~ 2,462°F	K-1480 ~ K24620	-148.0 ~ 2462.0
R	32°F ~ 3,182°F	K320 ~ K31820	32.0 ~ 3182.0
S	32°F ~ 3,182°F	K320 ~ K31820	32.0 ~ 3182.0
T	-238°F ~ 752°F	K-2380 ~ K7520	-238.0 ~ 752.0
E	-238°F ~ 1,796°F	K-2380 ~ K17960	-238.0 ~ 1796.0
N	-238°F ~ 2,372°F	K-2380 ~ K23720	-238.0 ~ 2372.0
B	392°F ~ 3,272°F	K3920 ~ K32720	392.0 ~ 3272.0
C	NA	NA	NA
U	-328°F ~ 1112°F	K-3280 ~ K11120	-328.0 ~ 1112.0
L	-328°F ~ 1652°F	K-3280 ~ K16520	-328.0 ~ 1652.0
TXK	-328°F ~ 1472°F	K-3280 ~ K14720	-328.0 ~ 1472.0
±100mV	-100mV ~ 100mV	K-10000 ~ K10000	-100.00 ~ 100.00

7.2.2 Profile

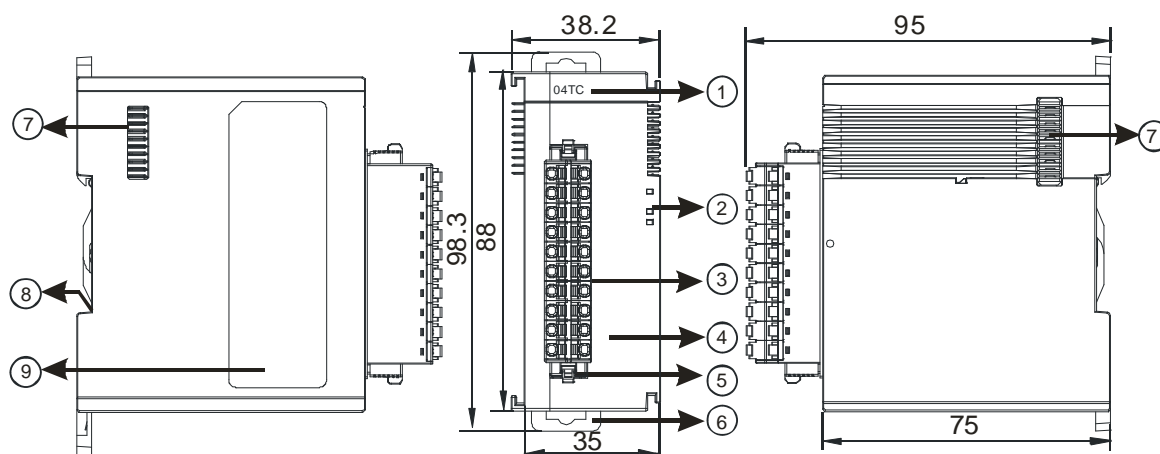

Unit: mm

Number	Name	Description
1	Model Name	Model name of the module
2	RUN LED Indicator	Operating status of the module ON: the module is running. OFF: the module is not running.
	ERROR LED Indicator	Error status of the module ON: a serious error exists in the module. OFF: the module is operating normally. Blink: a minor error exists in the module.
	Analog-to-Digital Conversion Indicator	Conversion status Blinking: conversion is in process. OFF: conversion has stopped.
3	Removable Terminal Block	The inputs are connected to transducers. The outputs are connected to loads to be driven.
4	Arrangement of the Input/Output Terminals	Arrangement of the terminals
5	Clip	For removing the terminal block
6	DIN rail clip	Secures the module onto the DIN rail
7	Module connecting set	Connects the modules
8	Ground clip	
9	Label	Nameplate

7.2.3 Arrangement of Terminals

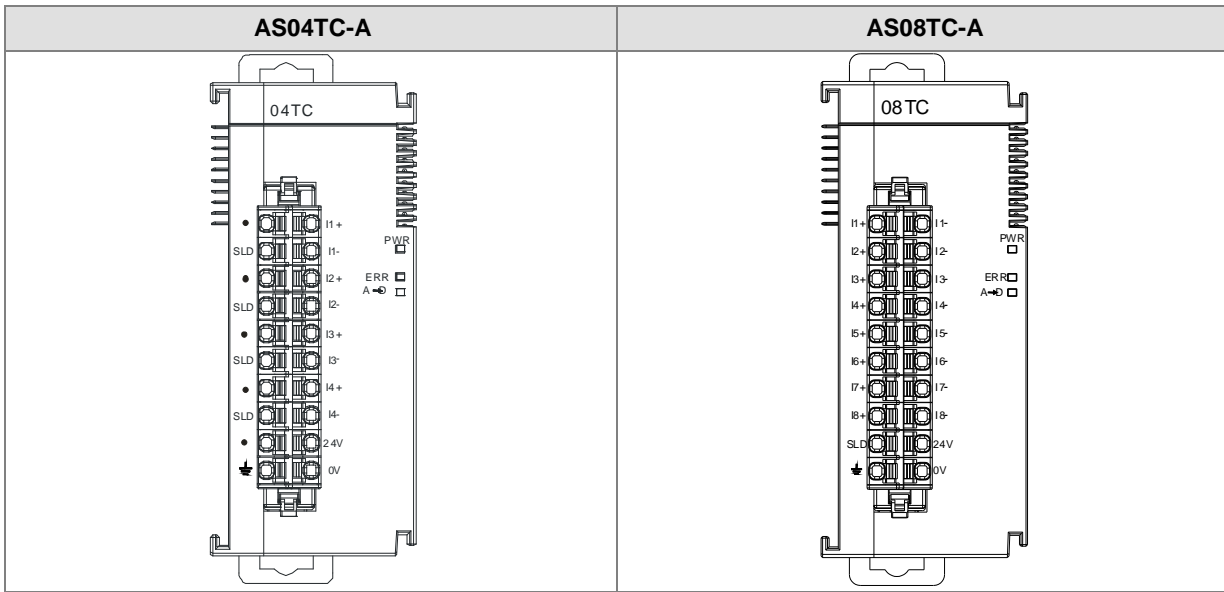

7.2.4 AS04TC Control Registers

*If you use HWCONFIG to set values in CRs, once the set value is downloaded, the values can be retained in the module; however if you use TO instruction to write data into CRs, the values CANNOT be retained, after power failure or after transition of the CPU from STOP to RUN.

Note: The attribute of the CR must be W (write) to use TO instruction.

CR#	Name	Description	Atr.	Defaults
0	Format Setup	0: integer format 1: floating point format	R	0
1	Channel 1 mode setup	0: closed 1: -100 mV to +100 mV	R/W	1
2	Channel 2 mode setup	2: J-Type 3: K-Type 4: R-Type		
3	Channel 3 mode setup	5: S-Type 6: T-Type 7: E-Type		
4	Channel 4 mode setup	8: N-Type 9: B-Type 10: C-Type 11: U-Type 12: L-Type 13: TXK-Type		

CR#	Name	Description	Atr.	Defaults
5	Channel 1 offset	Range: -32768 to +32767	R/W	0
6	Channel 2 offset			
7	Channel 3 offset			
8	Channel 4 offset			
9	Channel 1 gain	Range: -32768 to +32767	R/W	1000
10	Channel 2 gain		R/W	
11	Channel 3 gain		R/W	
12	Channel 4 gain		R/W	
13	Channel 1 average times	Range: 1–100	R/W	10
14	Channel 2 average times			
15	Channel 3 average times			
16	Channel 4 average times			
17	Channel 1 filter average percentage	Range: 0–3 Unit: $\pm 10\%$	R/W	1
18	Channel 2 filter average percentage			
19	Channel 3 filter average percentage			
20	Channel 4 filter average percentage			
21	Units of temperature	0: Fahrenheit 1: Celsius	R/W	0
22	Channel alarm setup	0: open channel alarm 1: close channel alarm bit0: channel 1 bit1: channel 2 bit2: channel 3 bit3: channel 4 0: warning 1: alarm	R/W	0

CR#	Name	Description	Atr.	Defaults
		bit8: error in the power supply bit9: error in the module hardware bit10: error in calibration bit11: error in CJC temperature		
201	Instruction set	16#0101: record the peak value again for channel 1 16#0102: record the peak value again for channel 2 16#0104: record the peak value again for channel 3 16#0108: record the peak value again for channel 4 16#010F: record the peak values again for channels 1–4 16#0201: enable recording for channel 1 16#0202: enable recording for channel 2 16#0204: enable recording for channel 3 16#0208: enable recording for channel 4 16#020F: enable recording for channels 1–4 16#0211: disable recording for channel 1 16#0212: disable recording for channel 2 16#0214: disable recording for channel 3 16#0218: disable recording for channel 4 16#021F: disable recording for channels 1–4 16#0502: restore default settings	W	0
210	The maximum peak value for channel 1	Integer format; the maximum peak value for analog inputs	R	-
211	The maximum peak value for channel 2			-
212	The maximum peak value for channel 3			-
213	The maximum peak value for channel 4			-
214	The minimum peak value for channel 1	Integer format; the minimum peak value for analog inputs	R	-
215	The minimum peak			-

7

CR#	Name	Description	Atr.	Defaults
	value for channel 2			
216	The minimum peak value for channel 3			-
217	The minimum peak value for channel 4			-
222	The time to record for channel 1			1
223	The time to record for channel 2	Unit: 100 ms Range: 1–100	R/W	1
224	The time to record for channel 3	The time to record the digital value for the channels		1
225	The time to record for channel 4			1
240	The number of records for channel 1			0
241	The number of records for channel 2			0
242	The number of records for channel 3	Range: 0-500, display the current records	R	0
243	The number of records for channel 4			0
4000 ~4499	Records for channel 1	500 records for channel 1	R	-
4500 ~4999	Records for channel 2	500 records for channel 2	R	-
5000 ~5499	Records for channel 3	500 records for channel 3	R	-
5500 ~5999	Records for channel 4	500 records for channel 4	R	-

7.2.5 AS08TC Control Registers

*If you use HWCONFIG to set values in CRs, once the set value is downloaded, the values can be retained in the module; however if you use TO instruction to write data into CRs, the values CANNOT be retained, after power failure or after transition of the CPU from STOP to RUN.

Note: The attribute of the CR must be W (write) to use TO instruction.

CR#	Name	Description	Atr.	Defaults
0	Format Setup	0: integer format 1: floating point format	R	0
1	Channel 1 mode setup	0: closed	R/W	1
2	Channel 2 mode setup	1: -100 mV to +100 mV		
3	Channel 3 mode setup	2: J-Type		
4	Channel 4 mode setup	3: K-Type		
5	Channel 5 mode setup	4: R-Type		
6	Channel 6 mode setup	5: S-Type		
7	Channel 7 mode setup	6: T-Type		
8	Channel 8 mode setup	7: E-Type		
		8: N-Type		
		9: B-Type		
9	Channel 1 offset	Range: -32768 to +32767	R/W	0
10	Channel 2 offset			
11	Channel 3 offset			
12	Channel 4 offset			
13	Channel 5 offset			
14	Channel 6 offset			
15	Channel 7 offset			
16	Channel 8 offset			
17	Channel 1 gain	Range: -32768 to +32767	R/W	1000
18	Channel 2 gain			
19	Channel 3 gain			
20	Channel 4 gain			
21	Channel 5 gain			
22	Channel 6 gain			

CR#	Name	Description	Atr.	Defaults
23	Channel 7 gain			
24	Channel 8 gain			
25	Channel 1 average times	Range: 1–100	R/W	10
26	Channel 2 average times			
27	Channel 3 average times			
28	Channel 4 average times			
29	Channel 5 average times			
30	Channel 6 average times			
31	Channel 7 average times			
32	Channel 8 average times			
33	Channel 1 filter average percentage	Range: 0–3 Unit: $\pm 10\%$	R/W	1
34	Channel 2 filter average percentage		R/W	
35	Channel 3 filter average percentage		R/W	
36	Channel 4 filter average percentage		R/W	
37	Channel 5 filter average percentage		R/W	
38	Channel 6 filter average percentage		R/W	
39	Channel 7 filter average percentage		R/W	
40	Channel 8 filter average percentage		R/W	
41	Units of temperature	0: Fahrenheit 1: Celsius	R/W	0
42	Channel alarm setup	0: open channel alarm 1: close channel alarm bit0: channel 1 bit1: channel 2 bit2: channel 3 bit3: channel 4 bit4: channel 5 bit5: channel 6	R/W	0

CR#	Name	Description	Atr.	Defaults
		bit6: channel 7 bit7: channel 8 0: warning 1: alarm bit8: error in the power supply bit9: error in the module hardware bit10: error in calibration bit11: error in CJC temperature		
201	Instruction set	16#0101: record the peak value again for channel 1 16#0102: record the peak value again for channel 2 16#0104: record the peak value again for channel 3 16#0108: record the peak value again for channel 4 16#0110: record the peak value again for channel 5 16#0120: record the peak value again for channel 6 16#0140: record the peak value again for channel 7 16#0180: record the peak value again for channel 8 16#01FF: record the peak value again for channels 1-8 16#0201: enable recording for channel 1 16#0202: enable recording for channel 2 16#0204: enable recording for channel 3 16#0208: enable recording for channel 4 16#0210: enable recording for channel 5 16#0220: enable recording for channel 6 16#0240: enable recording for channel 7 16#0280: enable recording for channel 8	W	0

CR#	Name	Description	Atr.	Defaults
		16#02FF: enable recording for channels 1-8 16#0301: disable recording for channel 1 16#0302: disable recording for channel 2 16#0304: disable recording for channel 3 16#0308: disable recording for channel 4 16#0310: disable recording for channel 5 16#0320: disable recording for channel 6 16#0340: disable recording for channel 7 16#0380: disable recording for channel 8 16#03FF: disable recording for channels 1-8 16#0501: restore default settings, clear setting values in the Flash 16#0502: restore default settings, do not clear setting values in the Flash		
210	The maximum peak value for channel 1	Integer format; the maximum peak value for analog inputs	R	-
211	The maximum peak value for channel 2			-
212	The maximum peak value for channel 3			-
213	The maximum peak value for channel 4			-
214	The maximum peak value for channel 5			-
215	The maximum peak value for channel 6			-
216	The maximum peak value for channel 7			-
217	The maximum peak value for channel 8			-
218	The minimum peak value for channel 1	Integer format; the minimum peak value for analog inputs	R	-
219	The minimum peak value for channel 2			-

CR#	Name	Description	Atr.	Defaults
220	The minimum peak value for channel 3			-
221	The minimum peak value for channel 4			-
222	The minimum peak value for channel 5			-
223	The minimum peak value for channel 6			-
224	The minimum peak value for channel 7			-
225	The minimum peak value for channel 8			-
226	The time to record for channel 1	Unit: 100 ms Range: 1–100 The time to record the digital value for the channels	R/W	1
227	The time to record for channel 2		R/W	1
228	The time to record for channel 3		R/W	1
229	The time to record for channel 4		R/W	1
230	The time to record for channel 5		R/W	1
231	The time to record for channel 6		R/W	1
232	The time to record for channel 7		R/W	1
233	The time to record for channel 8		R/W	1
240	The number of records for channel 1	Range: 0-100, display the current records	R	0
241	The number of records for channel 2			
242	The number of records for channel 3			
243	The number of records for channel 4			

7

CR#	Name	Description	Atr.	Defaults
244	The number of records for channel 5			
245	The number of records for channel 6			
246	The number of records for channel 7			
247	The number of records for channel 8			
4000 ~4099	Records for channel 1	100 records for channel 1	R	-
4500 ~4599	Records for channel 2	100 records for channel 2	R	-
5000 ~5099	Records for channel 3	100 records for channel 3	R	-
5500 ~5599	Records for channel 4	100 records for channel 4	R	-
6000 ~6099	Records for channel 5	100 records for channel 5	R	-
6500 ~6599	Records for channel 6	100 records for channel 6	R	-
7000 ~7099	Records for channel 7	100 records for channel 7	R	-
7500 ~7599	Records for channel 8	100 records for channel 8	R	-

7.2.6 Functions

Item	Function	Description
1	Enable/Disable a Channel	1. Enable or disable a channel. 2. If a channel is disabled, the total conversion time decreases.
2	Unit of Measurement	Select the unit of measurement: Fahrenheit or Celsius.
3	Calibration	Calibrate a linear curve.
4	Average	Conversion values are averaged and filtered.
5	Disconnection Detection	If the channel is open, the module can detect when it is disconnected. If the input is open-circuited, the module produces an alarm or a warning.
6	Channel Detection and Alarm	If an input signal exceeds the range of inputs that the hardware can receive, the module produces an alarm or a warning. You can disable this function.
7	Limit Detections for Channels	Save the maximum/minimum values for channels.
8	Records for Channels	Save the analog curves for channels.
9	PID Algorithm	PID control modes

1. Enable/Disable a Channel

An analog signal is converted into a digital signal at a rate of 200 ms per channel. If a channel is not used, you can disable it to decrease the total conversion time.

2. Unit of Measurement

Select the unit of measurement, Fahrenheit or Celsius, according to your needs.

3. Calibration

To make a curve meet specific needs, calibrate the curve by changing the offset and the gain. The calibration range depends on the range of inputs that the hardware can receive. The formula is:

$$Output = \frac{(Input \times Gain)}{1000} + Offset$$

Example:

If the gain is 1000 and the offset is 0, the corresponding value for the original signal 0° C to 100° C is 0–1000. If you change the offset to 100, the calibrated value for the original signal 0° C to 100° C becomes 100–1100.

Gain = 1000, Offset = 0

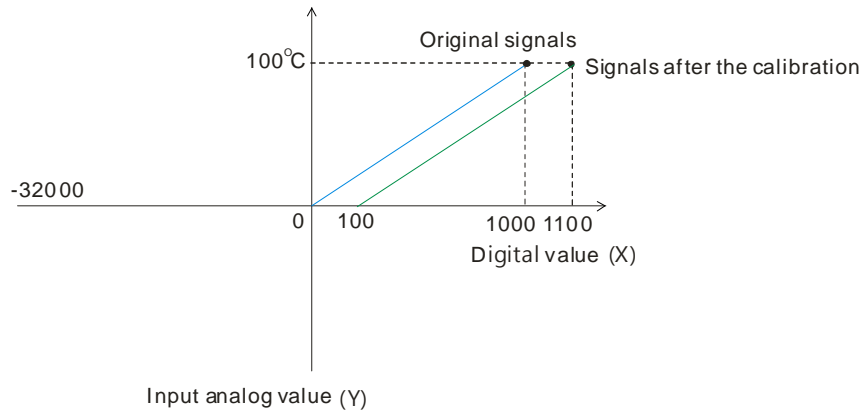

4. Average

You can set the average value between 1–100. It is a steady value obtained from the sum of the recorded values. If the recorded values include an acute pulse due to unavoidable external factors, however, you may observe violent changes in the average value. Use the filtering function to exclude the acute pulses from the sum-up and equalization, so the computed average value is not affected by the acute recorded values. Set the filter percentage to the range of 0–3, where the unit is 10%. If you set the filter range to 0, for example, the system sums up all the recorded values and divides them to obtain the average value, but if you set the filter range to 1, the system excludes the bottom 10% and the top 10% of the values and averages only the remaining values to obtain the average value.

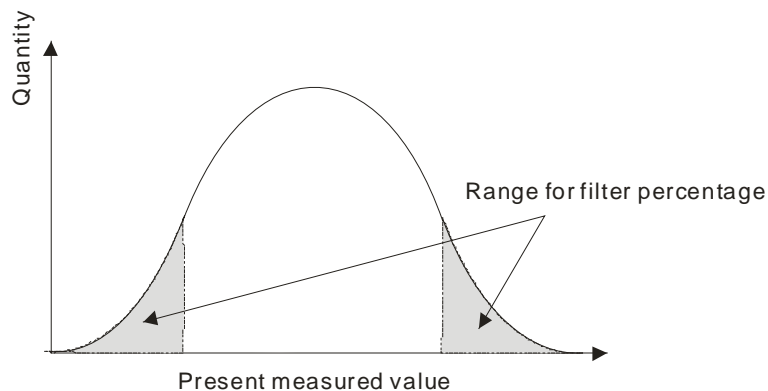

5. Disconnection Detection

If the channel is open, the module can detect when it is disconnected. If the input is open-circuited, the module produces an alarm or a warning.

6. Channel Detection

If an input signal exceeds the allowable range of inputs that the hardware can receive, an error message appears and the Error LED blinks. You can disable this function so that the module does not produce an alarm or warning and the Error LED also does not blink when the input signal exceeds the input range.

7. Limit Detections for Channels

This function saves the maximum and minimum values for channels so that you can determine the peak to peak values.

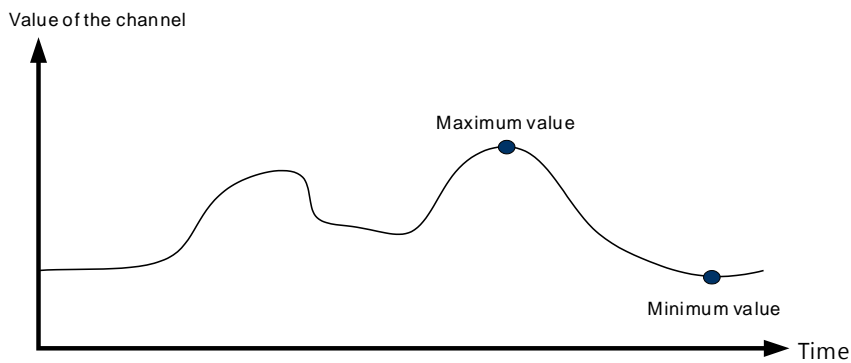

8. Records for channels

Record the input values of the cyclic sampling for each channel. For AS04TC-A, the system saves up to 500 data points and the recording time is 10 ms. For example, if the conversion time is 2 ms and 4 channels are open, the recording time is 8 ms x 500 data points = 4 seconds in total. And the system saves up to 100 data points for AS08TC-A and the recording time is 100 ms. The following uses AS04TC-A as an example to demonstrate.

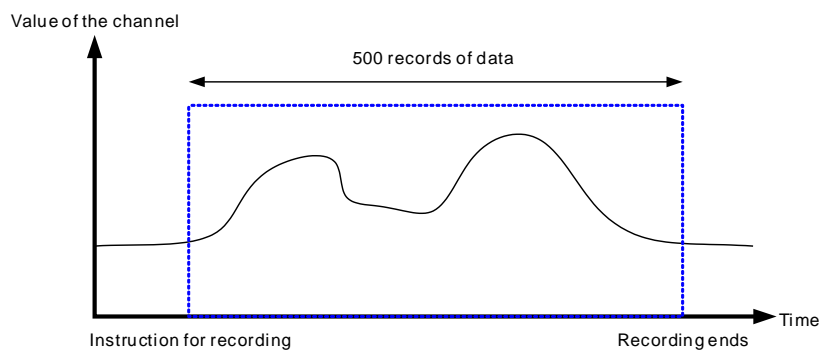

9. PID control

PID algorithm is available for every channel. With its auto tuning function, parameters such as Kp, Ki, Kd and more can be calculated and therefore temperature control can be achieved. You can also use DMPID instruction to calculate relative parameters by entering the parameters in the endpoints of the corresponding instruction image and then you can then obtain the output values from the output endpoints. Note: DMPID instruction is available for AS04TC-A (V1.04 or later), AS08TC-A (V1.00 or later), AS Series PLC (V1.06 or later) and AS-SCM (V2.04 or later).

7.2.7 Control Mode

1. You can use DMPID (API1417) to execute PID control. The applicable models and FW are AS04TC-A (V1.04 or later), AS08TC-A (V1.00 or later), AS Series PLC (V1.06 or later) and AS-SCM (V2.04 or later). Refer to AS Series Programming Manual for more details.
2. If the device you have does NOT support DMPID instruction, you can use the following PID parameter to execute PID control.

Use PID parameters

CR#								Operand	Function	Description	Defaults
CH1	CH2	CH3	CH4	CH5	CH6	CH7	CH8				
600	630	660	690	720	750	780	810	PID_RUN	Enable the PID algorithm	1: the PID algorithm is implemented. 0: the output value (MV) is reset to 0, and the PID algorithm is not implemented.	0
601	631	661	691	721	751	781	811	SV	SV	Target value	0
602	632	662	692	722	752	782	812	PID_MODE	PID control mode	0: automatic control When PID_MAN is switched from 1 to 0, the output value (MV) is included in the automatic algorithm. 1: the parameters are tuned automatically for the temperature control. When the tuning is	0

CR#								Operand	Function	Description	Defaults
CH1	CH2	CH3	CH4	CH5	CH6	CH7	CH8				
										complete, the device is automatically reset to 0, and the parameters Kc_Kp, Ti_Ki, Td_Kd, and Tf are set appropriately.	
603	633	663	693	723	753	783	813	PID_MAN	PID A/M mode	0: auto; the MV is output based on the PID algorithm. 1: manual; the MV is output based on the MOUT. When PID_MODE is also set to 1, this setting is ineffective.	0
604	634	664	694	724	754	784	814	MOUT_AUTO	MOUT automatic change mode	0: normal; the MOUT does not vary with the MV. 1: auto; the MOUT varies with the MV.	0
605	635	665	695	725	755	785	815	Auto DBWA	Auto tuning non-action zone	Range: 0–32000, used when SV is in the \pm dead band in auto tuning mode.	0

7

CR#								Operand	Function	Description	Defaults
CH1	CH2	CH3	CH4	CH5	CH6	CH7	CH8				
606 607	636 637	666 667	696 697	726 727	756 757	786 787	816 817	Kc_Kp	Calculated proportional coefficient (Kc or Kp)	Kc_Kp are floating-point numbers. If the P coefficient is less than 0, the Kc_Kp is 0. Independently, if Kc_Kp is 0, it is not controlled by P.	3.846
608 609	638 639	668 669	698 699	728 729	758 759	788 789	818 819	Ti_Ki	Integral coefficient (Ti or Ki)	Ti_Ki are floating-point numbers. If the calculated coefficient I is less than 0, Ti_Ki is 0. If Ti_Ki is 0, it is not controlled by I.	0.013
610 611	640 641	670 671	700 701	730 731	760 761	790 791	820 821	Td_Kd	Derivative coefficient (Td or Kd)	Td_Kd are floating-point numbers. If the calculated coefficient D is less than 0, Td_Kd is 0. If Ti_Ki is 0, it is not controlled by D.	190.078
612 613	642 643	672 673	702 703	732 733	762 763	792 793	822 823	Tf	Derivate-action time constant	If the derivate-action time constant is less than 0, Tf is 0 and it is not controlled by the derivate-action time constant.	4.941

CR#								Operand	Function	Description	Defaults
CH1	CH2	CH3	CH4	CH5	CH6	CH7	CH8				
614	644	674	704	734	764	794	824	PID_EQ	PID formula types	0: independent formula 1: dependent formula	0
615	645	675	705	735	765	795	825	PID_DE	The calculation of the PID derivative error	0: use the variations in the error (E) to calculate the control value of the derivative (derivative of E). 1: use the variations in the PV to calculate the control value of the derivative (derivative of PV).	0
616	646	676	706	736	766	796	826	PID_DIR	PID forward/reverse direction	0: heating action (E=SV-PV) 1: cooling action (E=PV-SV)	0
617	647	677	707	737	767	797	827	ERR_DBW	Range within which the error value is counted as 0	The error value (E) is the difference between the SV and the PV. When this setting is 0, the function is not enabled. When this setting is enabled, the CPU module checks	0

7

CR#								Operand	Function	Description	Defaults
CH1	CH2	CH3	CH4	CH5	CH6	CH7	CH8				
										whether the present difference is less than the absolute value of ERR_DBW, and it checks whether the present difference meets the cross status condition. If the present difference is less than the absolute value of ERR_DBW and it meets the cross status condition, the present error is counted as 0, and the PID algorithm is implemented. Otherwise the present error is brought into the PID algorithm normally.	
618	648	678	708	738	768	798	828	α value	Integral sum	Range: 0–100	31
619	649	679	709	739	769	799	829	β value	Integral sum	Unit: 0.01	0
620	650	680	710	740	770	800	830	MOUT	Manual output value (MOUT)	When PID_MAN is set to 1, the MV value is output as this manual MOUT value, between MV_MAX and MV_MIN.	0

CR#								Operand	Function	Description	Defaults
CH1	CH2	CH3	CH4	CH5	CH6	CH7	CH8				
										Range: 0–1000 (0%–100%)	
621	651	681	711	741	771	801	831	BIAS	Feedforward output value	Feedforward output value, used for the PID feedforward	0
622 623	652 653	682 683	712 713	742 743	772 773	802 803	832 833	MV	Output value (MV)	A floating-point number Range: 0–100 Unit: %	--
624 625	654 655	684 685	714 715	744 745	774 775	804 805	834 835	I_MV	Accumulated integral value	Floating-point format. The accumulated integral value is temporarily stored for reference. When the MV is out of the range 0%–100%, the accumulated integral value in I_MV is unchanged.	--
626	656	686	716	746	776	806	836	CYCLE	Sampling time (T_s)	When this instruction is read, the PID algorithm is implemented according to the sampling time, and the MV is refreshed. If T_s is less than 1, it is read as 1. If T_s is larger than	1

CR#								Operand	Function	Description	Defaults
CH1	CH2	CH3	CH4	CH5	CH6	CH7	CH8				
										1,000, it is read as 1,000. Unit: 100 ms	

Note: PID control registers of AS04TC-A and RTD-A are retainable; however PID control registers of AS06RTD-A and AS08TC-A are not retainable. But you can use the data registers that are retainable to store the set PID parameters so that the PID parameters can be retainable.

PID formula:

1. When the PID_MODE is set to 0, the mode is set to auto:

- **Independent Formula & Derivative of E (PID_EQ=False & PID_DE=False)**

$$MV = K_p E + K_i \int_0^t E dt + K_d * \frac{dE}{dt} + BIAS \quad (E = SV - PV \text{ or } E = PV - SV)$$

- **Independent Formula & Derivative of PV (PID_EQ=False & PID_DE=True)**

$$MV = K_p E + K_i \int_0^t E dt - K_d * \frac{dPV}{dt} + BIAS \quad (E = SV - PV)$$

Or

$$MV = K_p E + K_i \int_0^t E dt + K_d * \frac{dPV}{dt} + BIAS \quad (E = PV - SV)$$

- **Dependent Formula & Derivative of E (PID_EQ=True & PID_DE=False)**

$$MV = K_c \left[E + \frac{1}{T_i} \int_0^t E dt + T_d * \frac{dE}{dt} \right] + BIAS \quad (E = SV - PV \text{ or } E = PV - SV)$$

- **Dependent Formula & Derivative of PV (PID_EQ=True & PID_DE=True)**

$$MV = K_c \left[E + \frac{1}{T_i} \int_0^t E dt - T_d * \frac{dE}{dt} \right] + BIAS \quad (E = SV - PV)$$

Or

$$MV = K_c \left[E + \frac{1}{T_i} \int_0^t E dt + T_d * \frac{dE}{dt} \right] + BIAS \quad (E = PV - SV)$$

2. When you set the PID_MODE to 1, auto tuning mode is enabled. When auto tuning is complete, the value becomes 0 and switches off the auto tuning mode automatically.

PID Control Block Diagram:

PID Block Diagram (Independent)

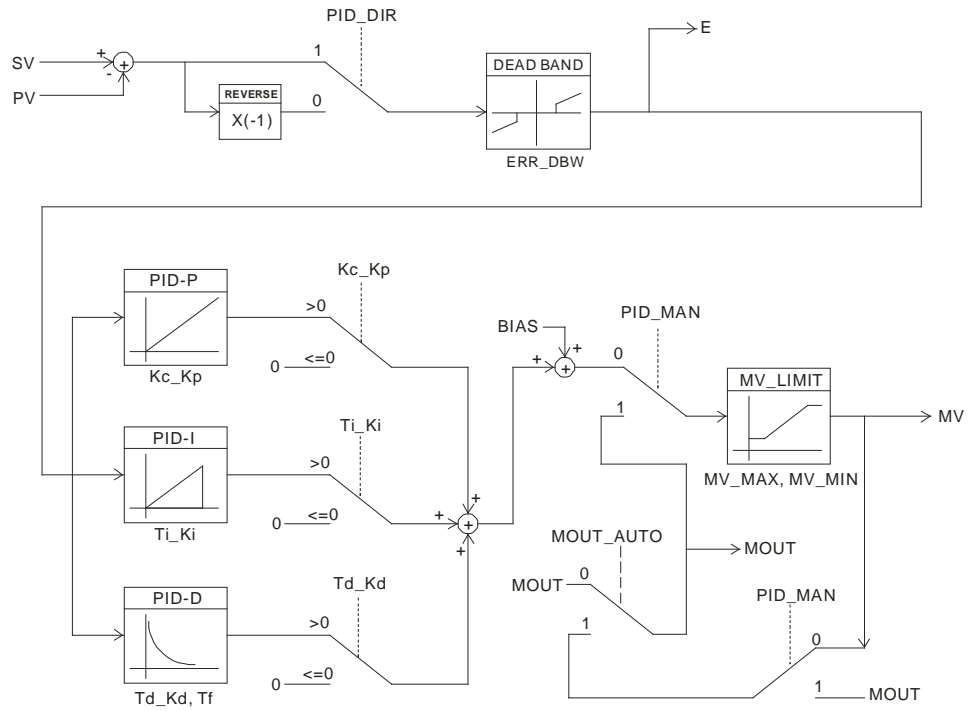

PID Block Diagram (Dependent)

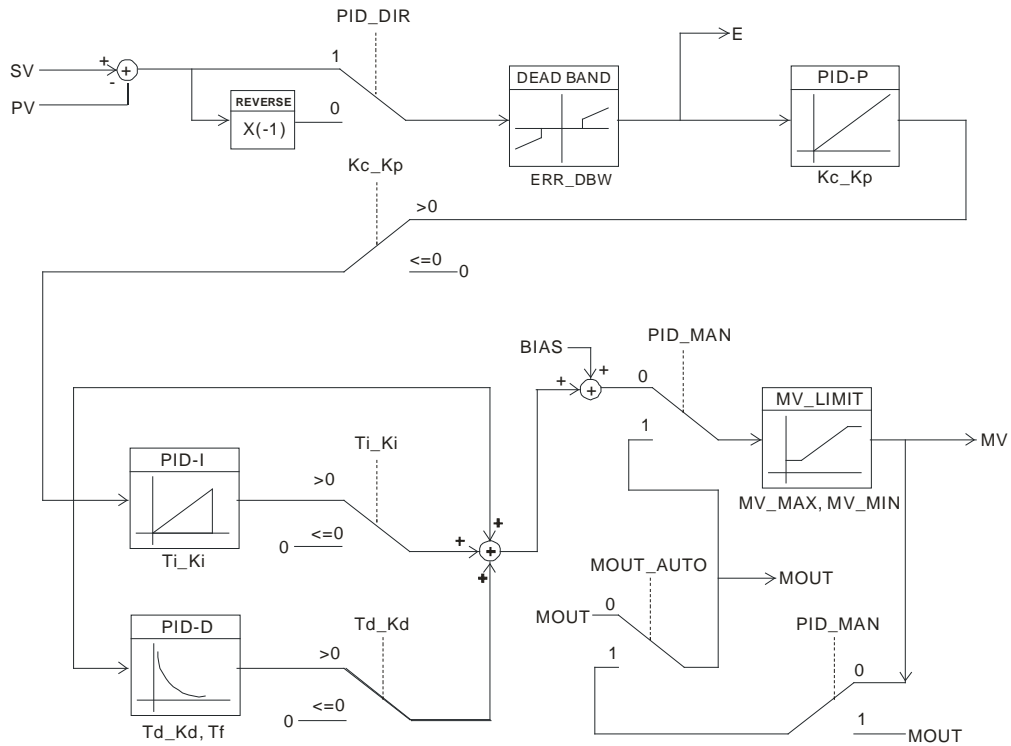

7

ERR_DBW

When the PV (present value) is in the range of **ERR_DBW**, at the beginning, the present error is brought into the PID algorithm according to the normal processing, and then the CPU module checks whether the present error meets the cross status condition: PV (present value) goes beyond the SV (target value). Once the condition is met, the present error is counted as 0 when applying the PID algorithm. After the PV (present value) is out of the **ERR_DBW** range, the present error is brought into the PID algorithm again. If PID_DE is true, that means it uses the variations in the PV to calculate the control value of the derivative, and after the cross status condition is met, the PLC treats ΔPV as 0 to apply the PID algorithm. ($\Delta PV = \text{current PV} - \text{previous PV}$). In the following example, the present error is brought into the PID algorithm according to the normal processing in section A, and the present error or ΔPV is counted as 0 to apply the PID algorithm in the section B.

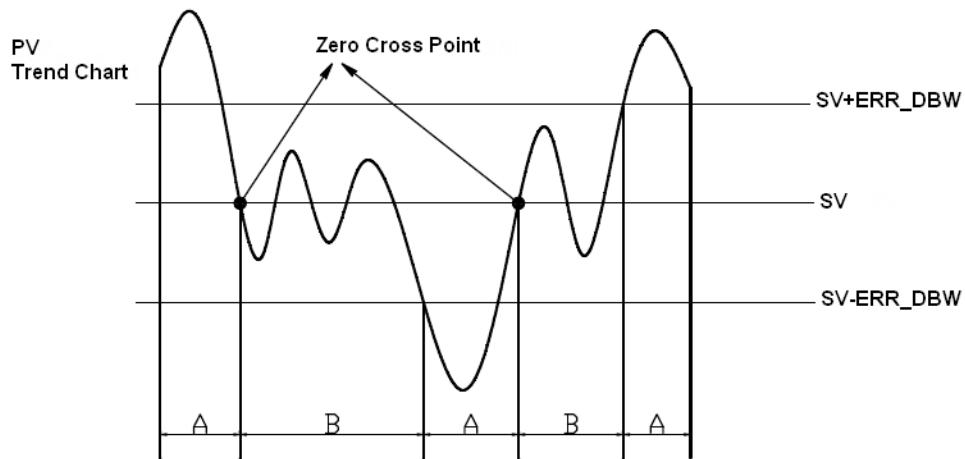

$\alpha \cdot \beta$ Value

To reduce overshoot, you can use parameters of ALPHA or BETA in the beginning of the PID operation or while SV (target value) varies to compensate initial value of integral calculus (for heating up or cooling down). See the images below. Use ALPHA parameter to reduce overshoot while the temperature is climbing up. Use BETA parameter to reduce overshoot while the temperature is dropping.

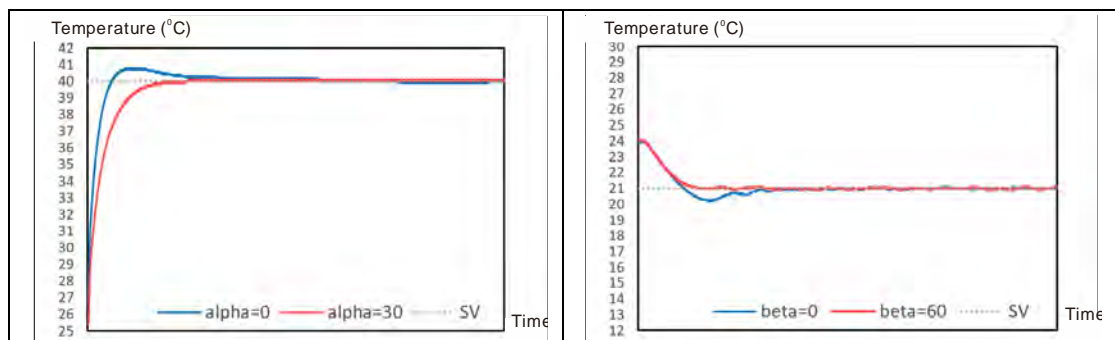

Formula of the output cycle:

➤ Pulse output width = MV (%) x output cycle

Execute the general pulse with modulation instruction (GPWM) to set pulse output width and output cycle sampling time to manage the cycle.

Example:

If the output cycle is 2000 ms, then the output value is 50% after the PID algorithm is implemented.

➤ Pulse output width = 50% x 2000 ms = 1000 ms

In other words, the GPWM instruction can be set to pulse output width = 1000 and output cycle = 2000.

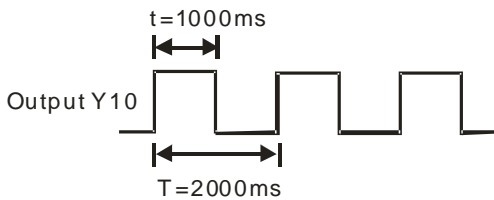

Note:

1. When tuning the parameters Kc_Kp, Ti_Ki, and Td_Kd (**PID_MODE=0**), set the Kc_Kp value first, and then set the Ti_Ki and Td_Kd values to 0. In a controlled environment, you can increase the values of Ti_Ki (from smaller to bigger) and Td_Kd (from bigger to smaller). When the value of Kc_Kp is 1, the proportional gain is 100%. That is, the error values increase by a factor of one. When the proportional gain is less than 100%, the error values decrease. When the proportional gain is greater than 100%, the error values increase.
2. The parameters which have been automatically tuned are not necessarily suitable for every controlled environment. You can, therefore, further modify the automatically-tuned parameters, but it is recommended that you only modify the values of Ti_Ki or Td_Kd.
3. The operand CYCLE is to set the sampling time to use the PID algorithm and refresh MV.
4. When the number of the channel for measurement is changed, the time to refresh the measured value also changes. For example, the measured value is refreshed every 200 ms when there is only 1 channel for measurement. The measured value is refreshed every 800 ms when there are 4 channels for measurement. The Kc_Kp, Ti_Ki, Td_Kd parameters may differ when the number of channel for measure is different.

7.2.8 Wiring

● Precautions

To ensure the analog-to-digital module functions well and reliably, the external wiring must prevent noise. Before you install the cables, follow the precautions below.

- (1) To prevent a surge and induction, the AC cable and the input signal cables that are connected to the ASTC-A Series must be separate cables.
- (2) Do not install the cable near a main circuit, a high-voltage cable, or a cable connected to a load which is not a PLC. In addition, the cable must not be bound to a main circuit, a high-voltage cable, or a cable connected to a load which is not a PLC.
- (3) Ground shielded cables and hermetically sealed cables separately.
- (4) Terminals with insulation sleeves cannot be arranged as a terminal block, so you should cover the terminals with insulation tubes.
- (5) Note1: do not wire empty terminals.
- (6) Note2: only use copper conducting wires with a temperature rating of 60/75°C and the length must be less than 50 m.
- (7) Note3: TC modules must run for 30 minutes before they start to take any temperature measurement.

● External wiring

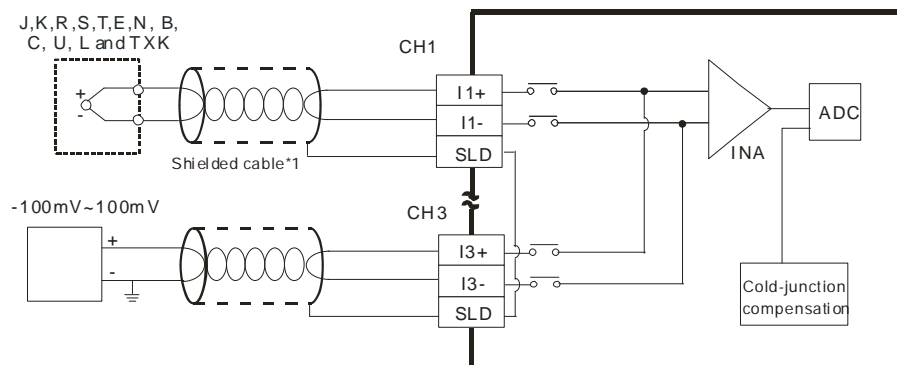

- *1. Use shielded twisted pair cables for Type J, K, R, S, T, E, N, B, C, U, L and TXK thermocouples, and keep them separate from power cables and other cables which generate noise.

7.2.9 LED Indicators

Number	Name	Description
1	RUN LED Indicator	Operating status of the module ON: the module is running. OFF: the module is not running.
2	ERROR LED Indicator	Error status of the module ON: a serious error exists in the module. OFF: the module is operating normally. Blink: a minor error exists in the module.
3	Analog-to-Digital Conversion Indicator	Conversion status Blinking: conversion is in process. OFF: conversion has stopped.

7.3 HWCONFIG in ISPSoft

7.3.1 Initial Setting

The following uses AS04TC-A as an example to demonstrate.

- (1) Start ISPSoft and double-click **HWCONFIG**.

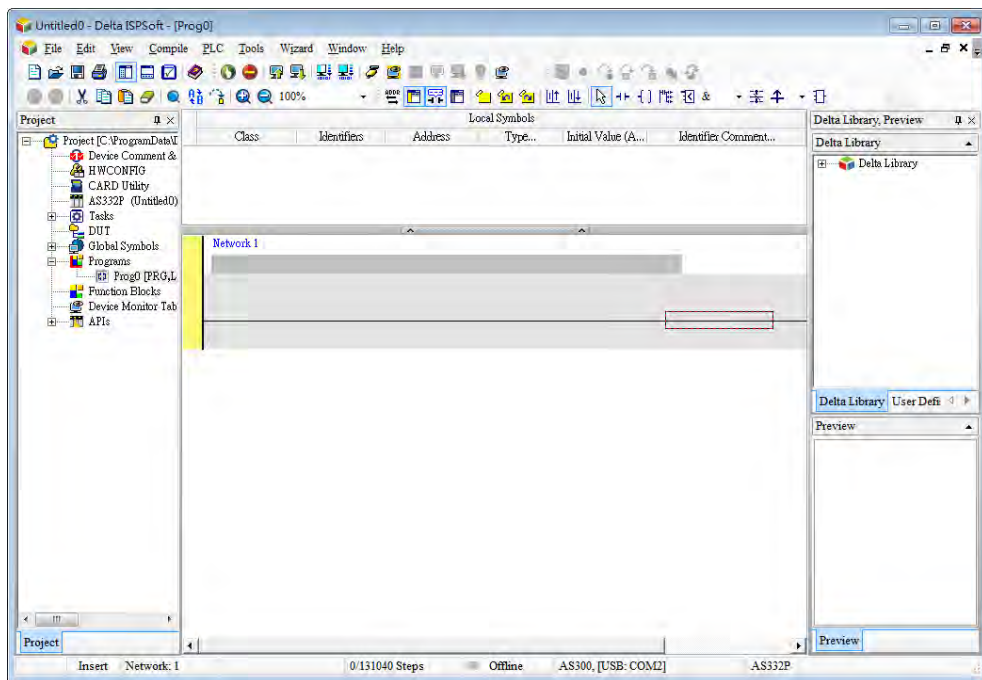

- (2) Select a module and drag it to the working area.

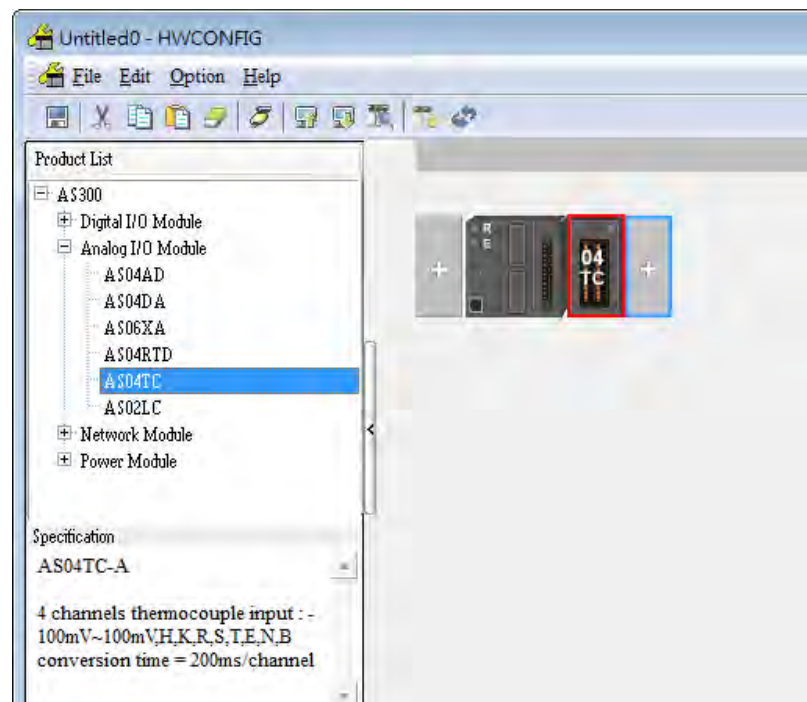

(3) Double-click the module in the working area to open the Device Setting page.

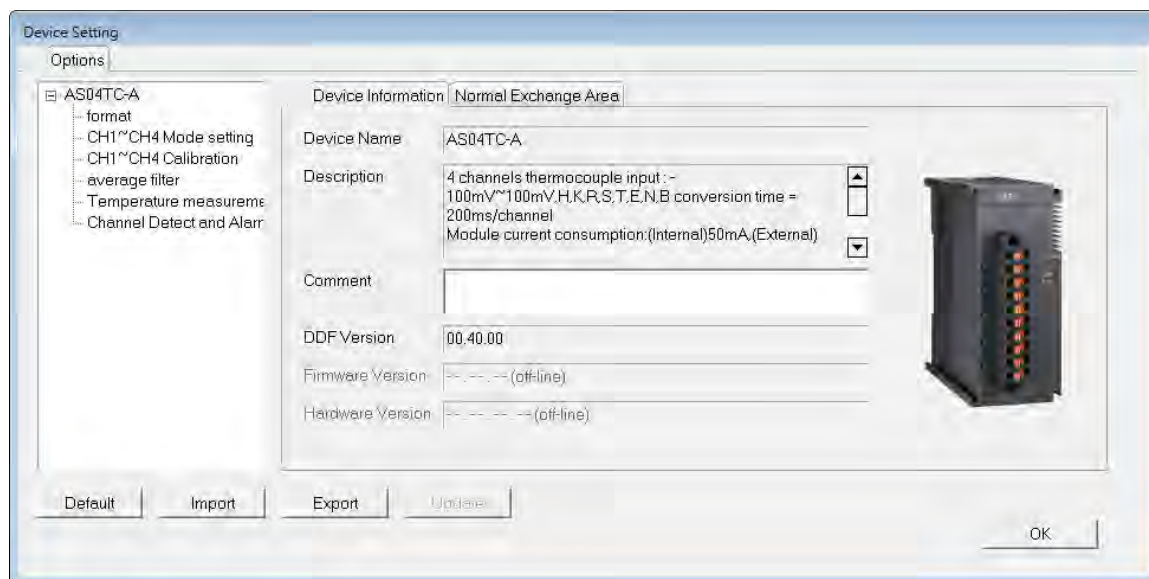
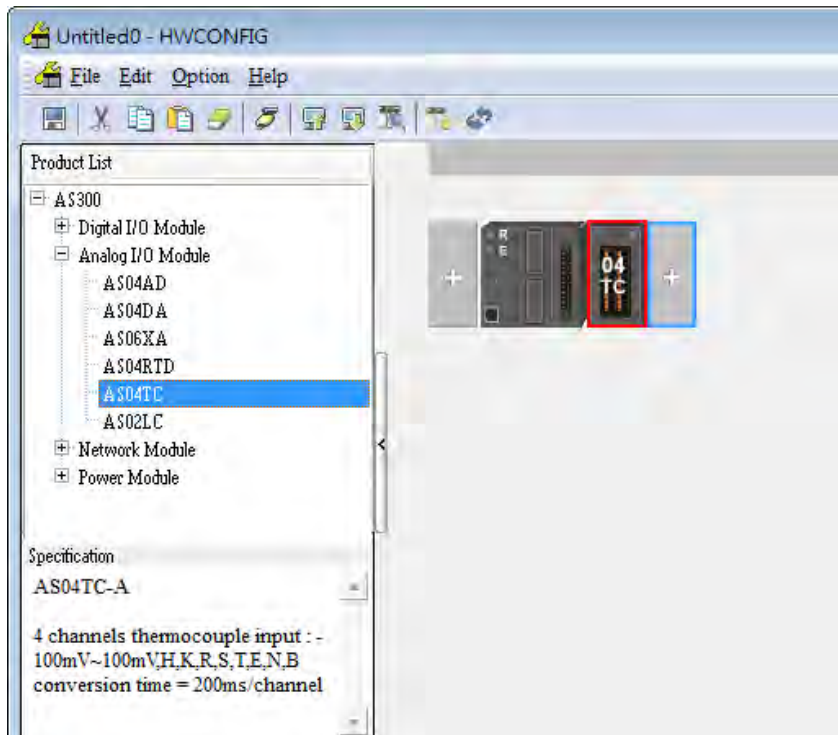

7

- (4) Choose the parameter, set the values, and click **OK**.

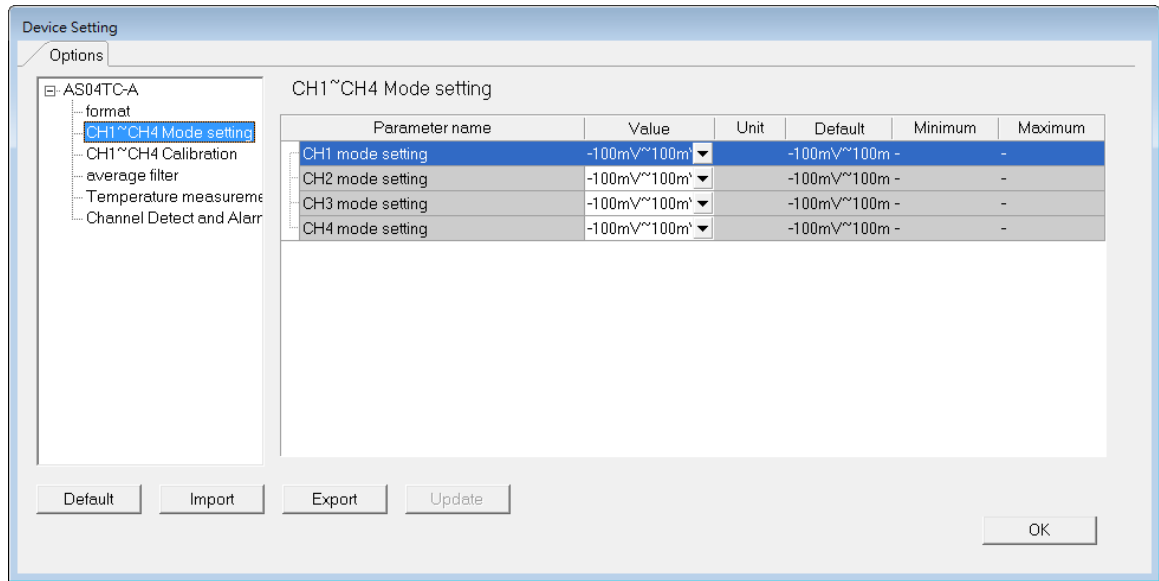

- (5) Click **Download** on the toolbar to download the parameters. Note that you cannot download the parameters while the CPU module is running.

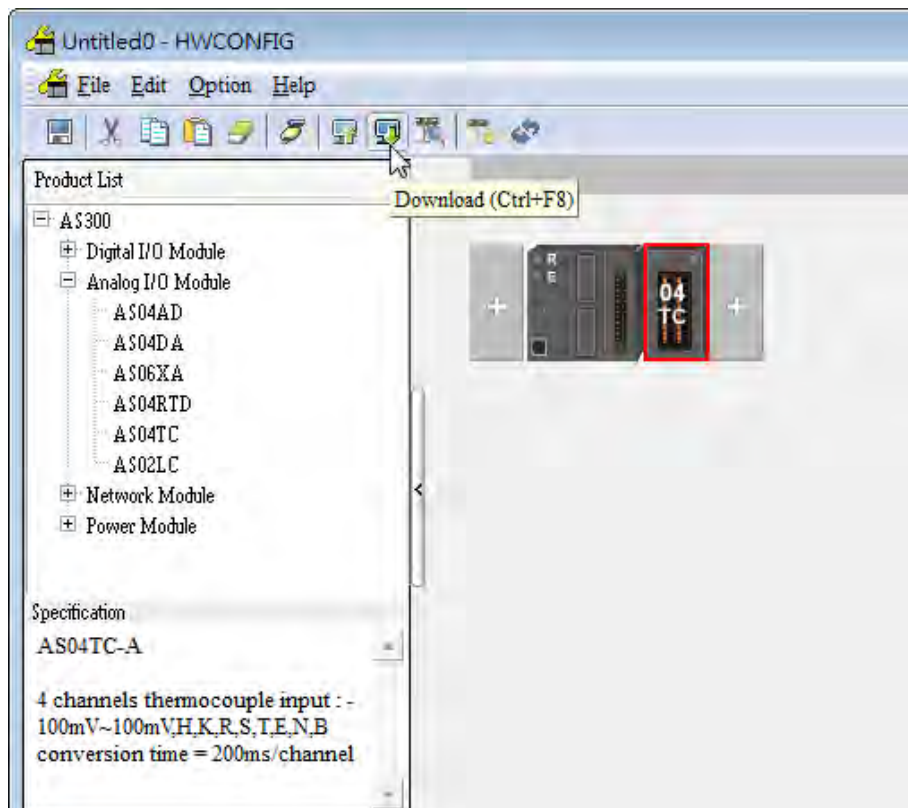

7.3.2 Checking the Version of a Module

(1) On the **Option** menu, click **Online Mode**.

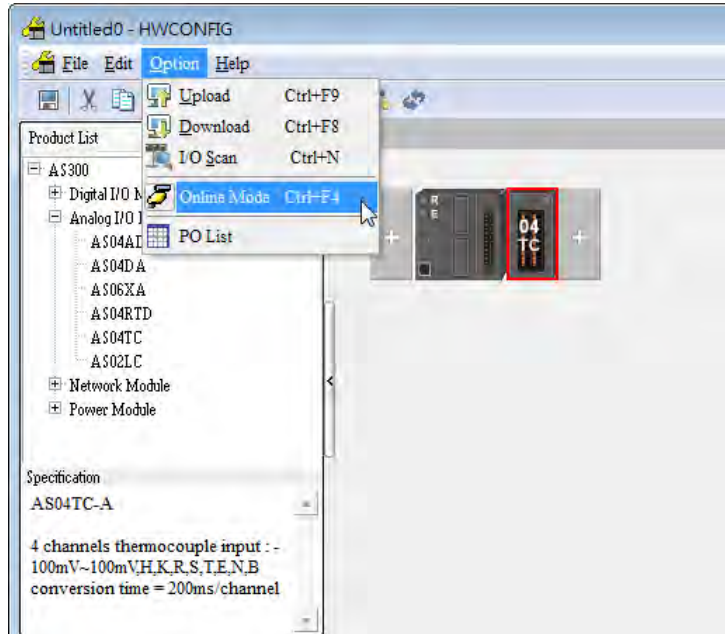

(2) Double-click the module to open the Device Setting page. The versions of both the firmware and the hardware are displayed.

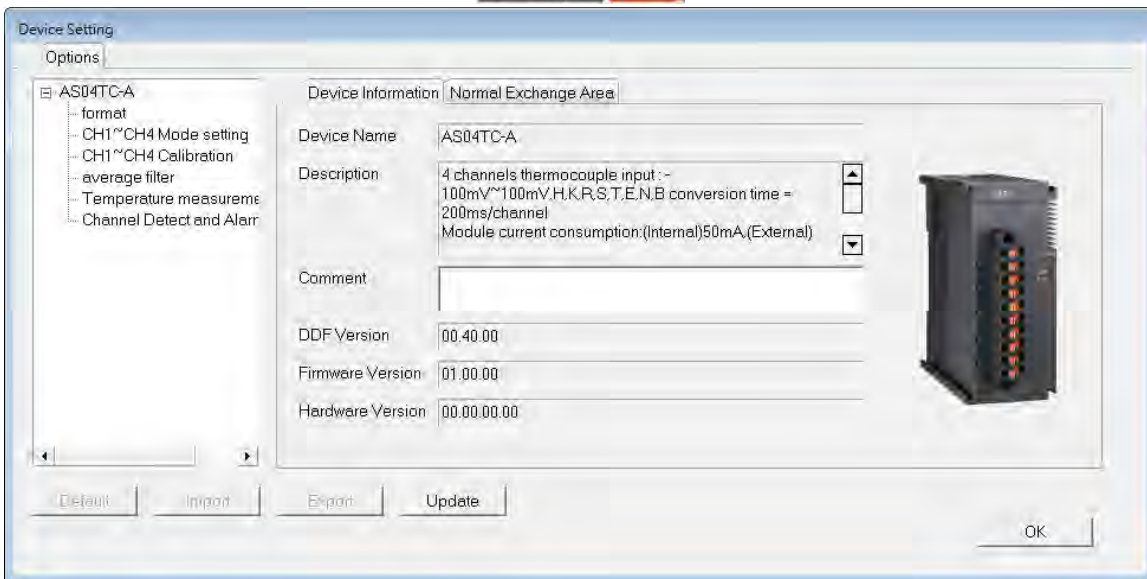

7

7.3.3 Online Mode

- (1) On the **Option** menu, click **Online Mode**.

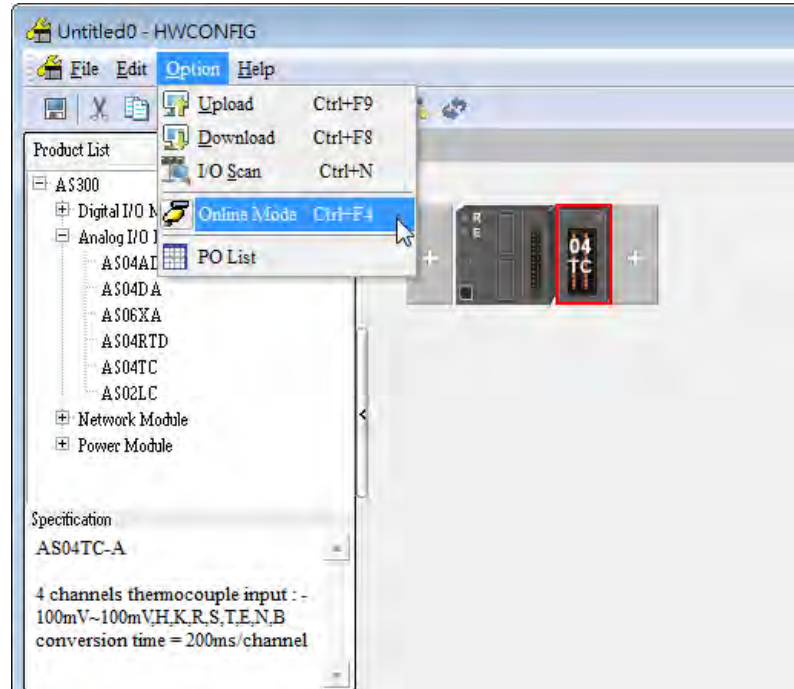

- (2) Right-click the module and click **Module Status**.

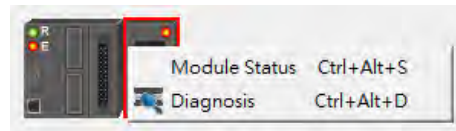

- (3) View the module status.

Channel	Value (32 bits)	Data Type
Error code	6145	DECIMAL
CH1 Input	0	DECIMAL
CH2 Input	0	DECIMAL
CH3 Input	0	DECIMAL
CH4 Input	0	DECIMAL

7.3.4 Importing/Exporting a Parameter File

(1) Click **Export** in the Device Setting dialog box to save the current parameters as a CSV file (.csv).

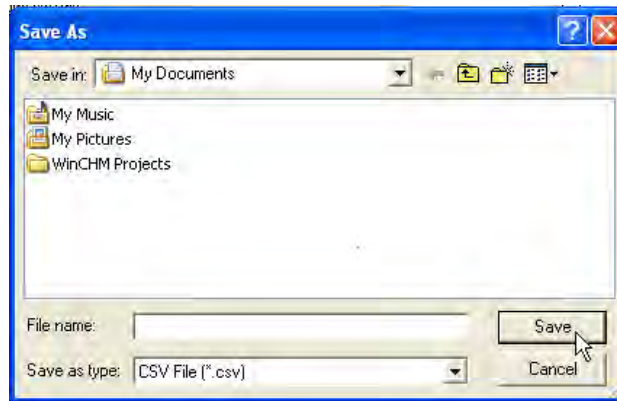
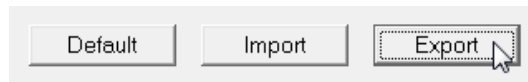

(2) Click **Import** in the Device Setting dialog box, and select a CSV file to import saved parameters.

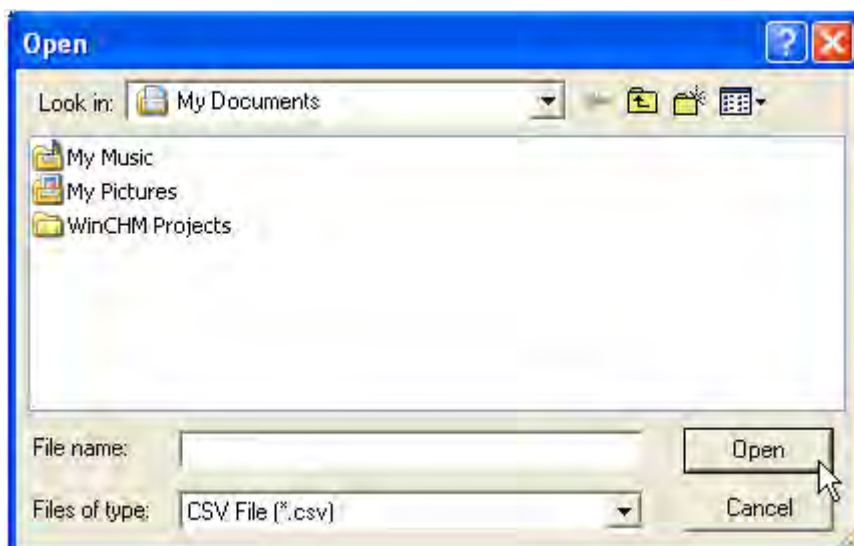
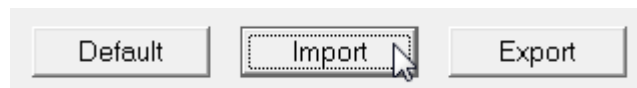

7

7.3.5 Parameters

(1) The input modes of the channels

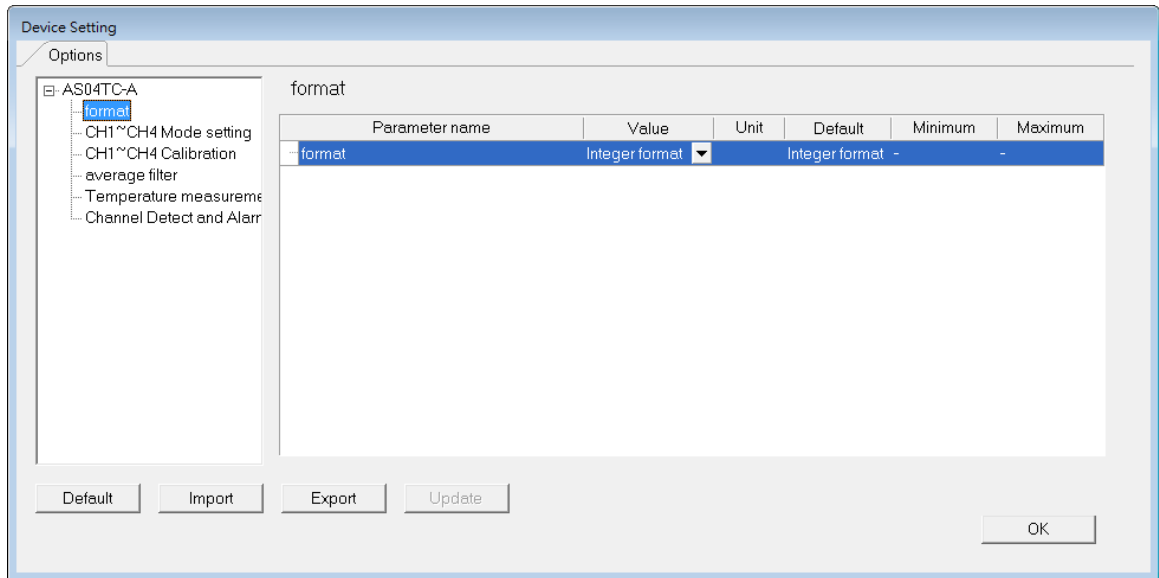

(2) Input CH1~CH4 (channel 1~channel 4) mode settings

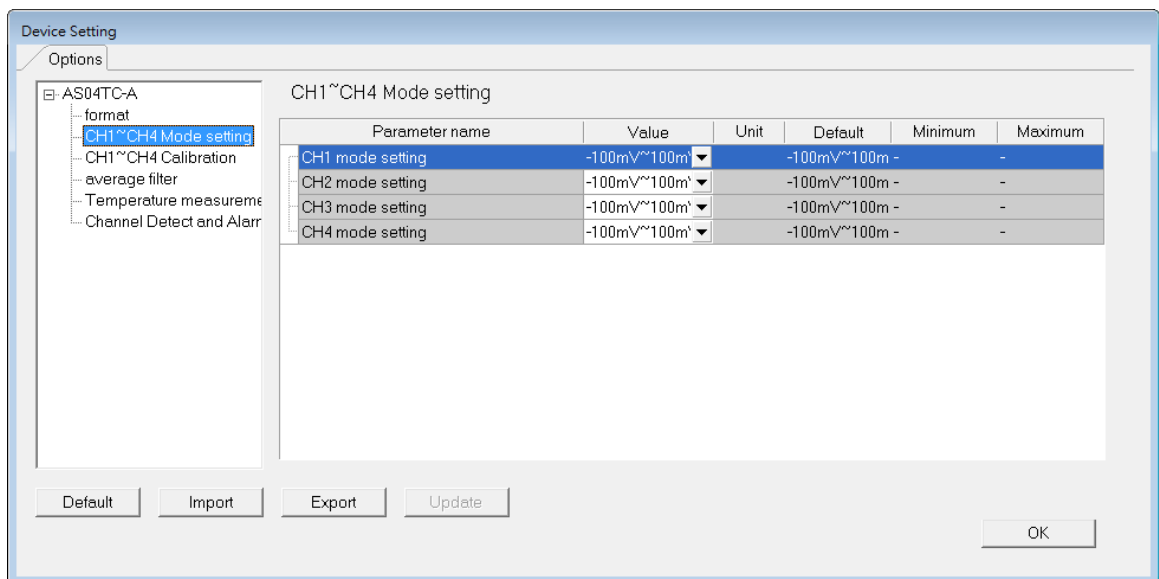

(3) Input CH1-CH4 calibration

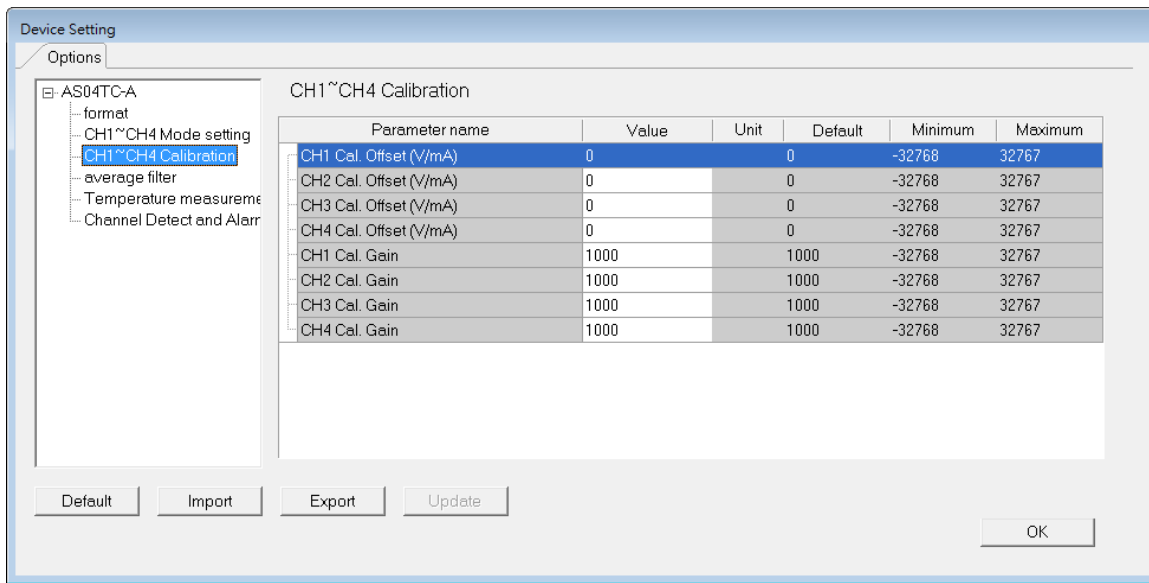

(4) Input average filter

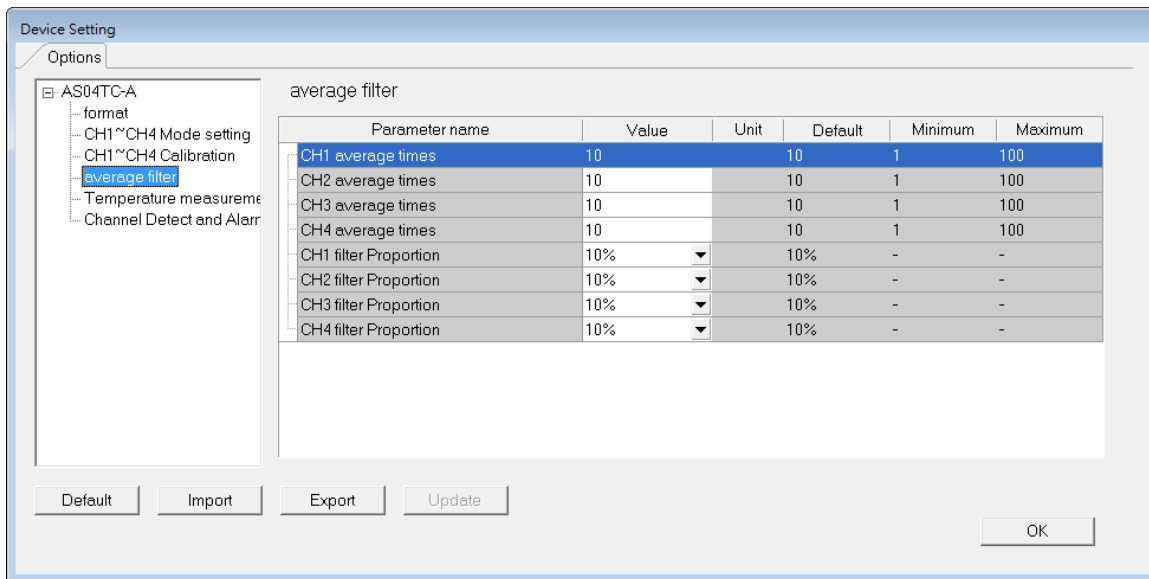

(5) Temperature measurement

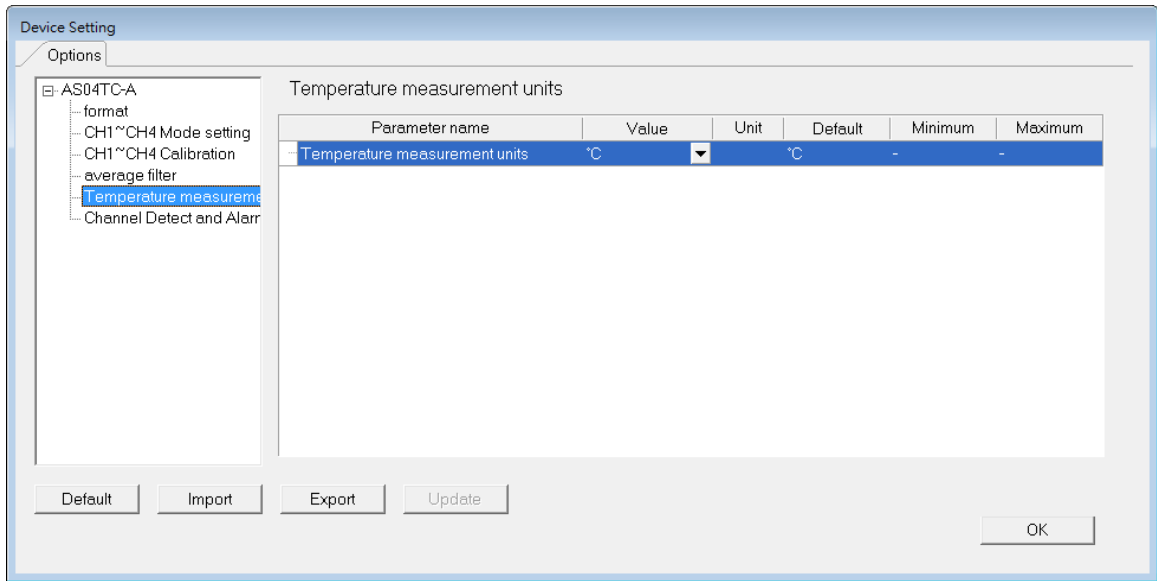

(6) Input channel detect and alarm settings

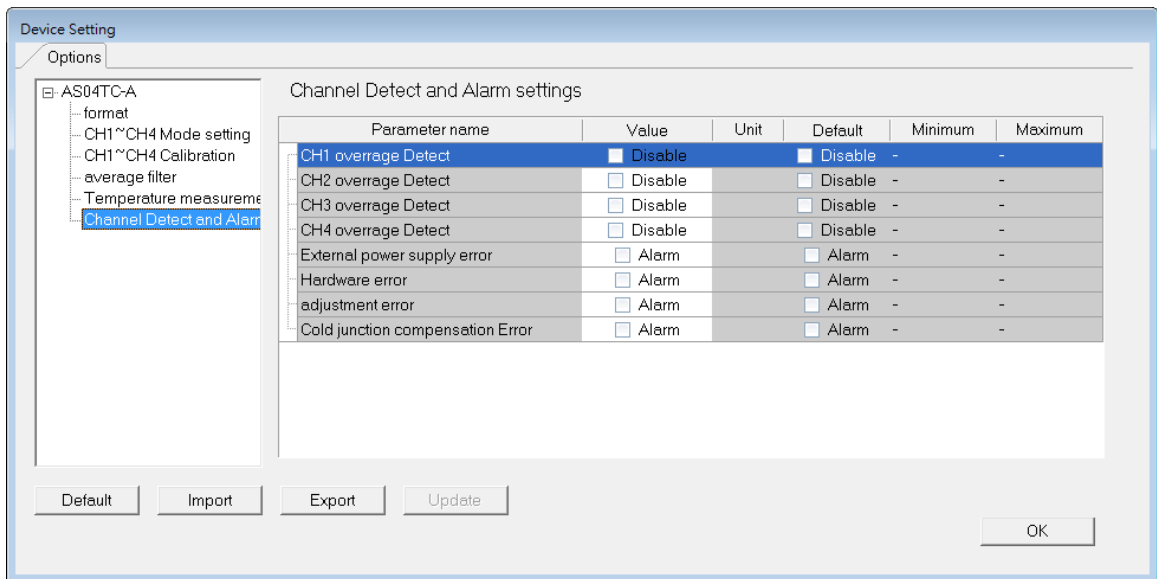

7.4 DIADesigner-AX (Hardware Configuration)

The following example uses AS04TC-A.

7.4.1 Initial Setting

- (1) Start DIADesigner-AX, click **New Project**, and then **Project+Device** to create a new project.

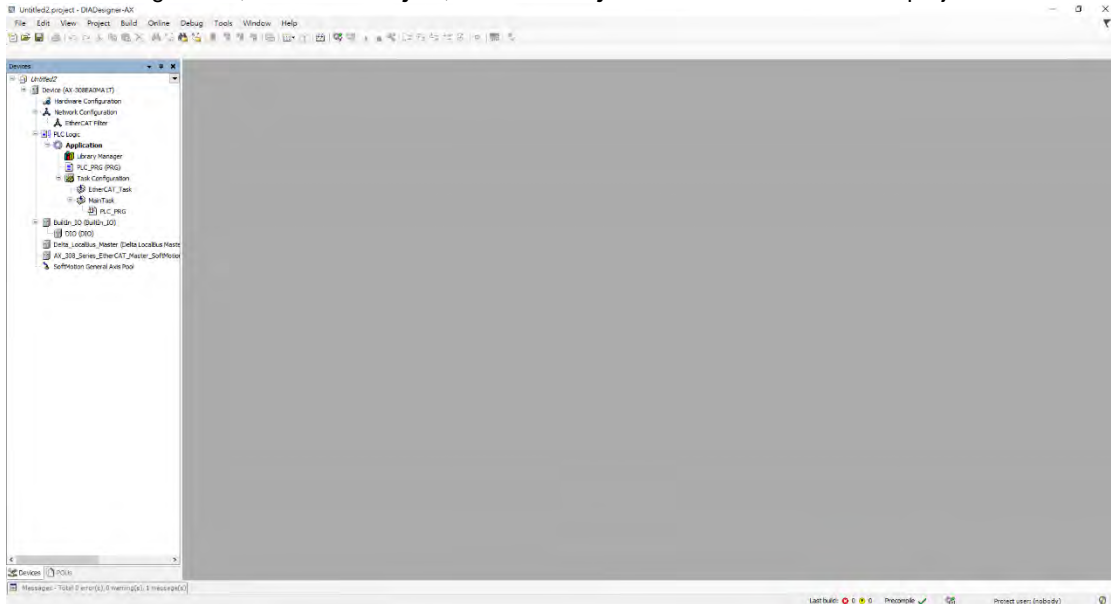

- (2) Add modules in:

- ① Double-click **Hardware Configuration**

- ② Select the **+** section and drag and drop the module that you want to add from the Product List to the **+** section.

or ③ Right-click **Delta_Localbus Master** to see the context menu and then double-click **Add Device** to add devices manually or double-click **Scan for Devices**.

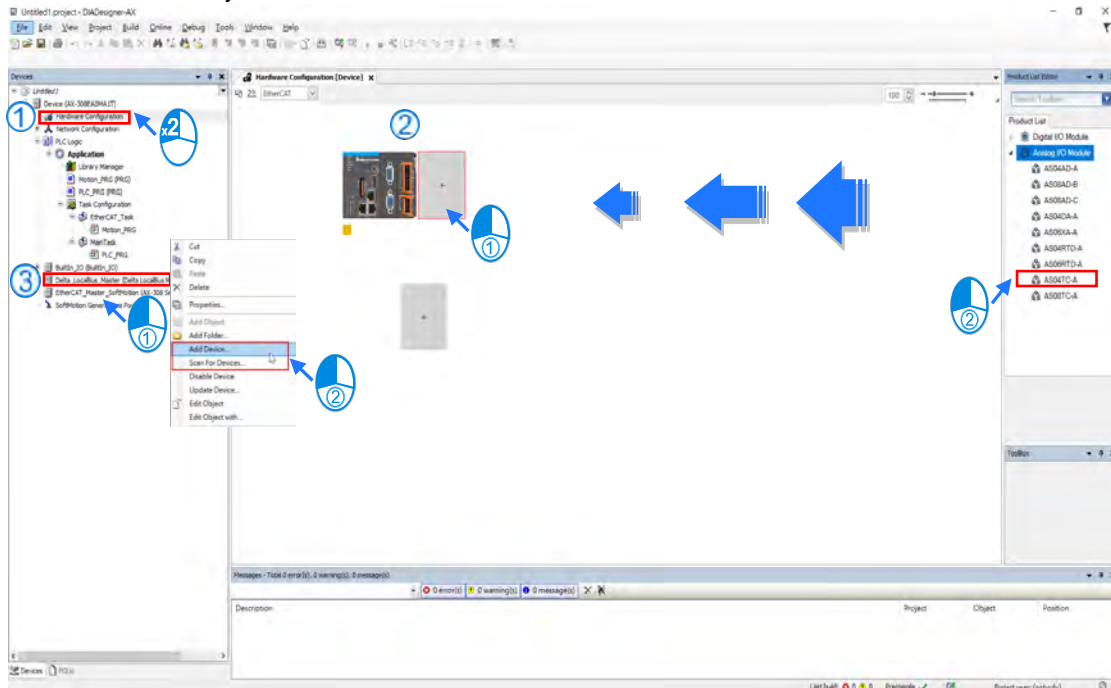

(3) Select modules:

① Double-click the module name in the **Hardware Configuration** area.

or ② Double-click the module name shown in the node.

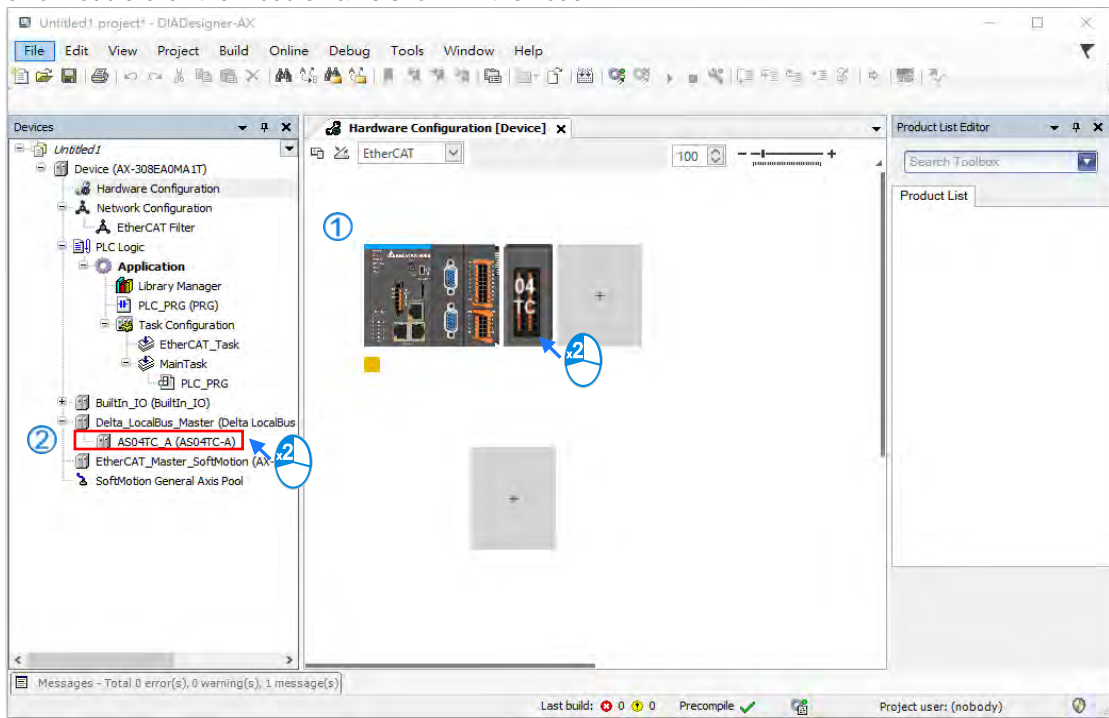

(4) Module parameter setting page:

Parameter	Type	Value	Default Value	Unit	Description
AS04TC-A Parameters					
AS04TC-A I/O Mapping					
Status					
Information					
Format	Enumeration of UINT	Integer	Integer		
CH1~CH4 Mode Setting					
CH1 Mode setting	Enumeration of WORD	-100mV~100mV	-100mV~100mV		
CH2 Mode Setting	Enumeration of WORD	-100mV~100mV	-100mV~100mV		
CH3 Mode Setting	Enumeration of WORD	-100mV~100mV	-100mV~100mV		
CH4 Mode Setting	Enumeration of WORD	-100mV~100mV	-100mV~100mV		
CH1~CH4 Calibration					
CH1 Cal. Offset (V/mA)	INT(-32768..32767)	0	0		
CH2 Cal. Offset (V/mA)	INT(-32768..32767)	0	0		
CH3 Cal. Offset (V/mA)	INT(-32768..32767)	0	0		
CH4 Cal. Offset (V/mA)	INT(-32768..32767)	0	0		
CH1 Cal. Gain	INT(-32768..32767)	1000	1000		
CH2 Cal. Gain	INT(-32768..32767)	1000	1000		
CH3 Cal. Gain	INT(-32768..32767)	1000	1000		
CH4 Cal. Gain	INT(-32768..32767)	1000	1000		
Average Filter					
CH1 Average Times	WORD(1..100)	10	10		
CH2 Average Times	WORD(1..100)	10	10		
CH3 Average Times	WORD(1..100)	10	10		
CH4 Average Times	WORD(1..100)	10	10		
CH1 Filter Proportion	Enumeration of WORD	10%	10%		
CH2 Filter Proportion	Enumeration of WORD	10%	10%		

- (5) After setting is complete, select the module and click **Login** on the tool bar to download the settings to the modules.

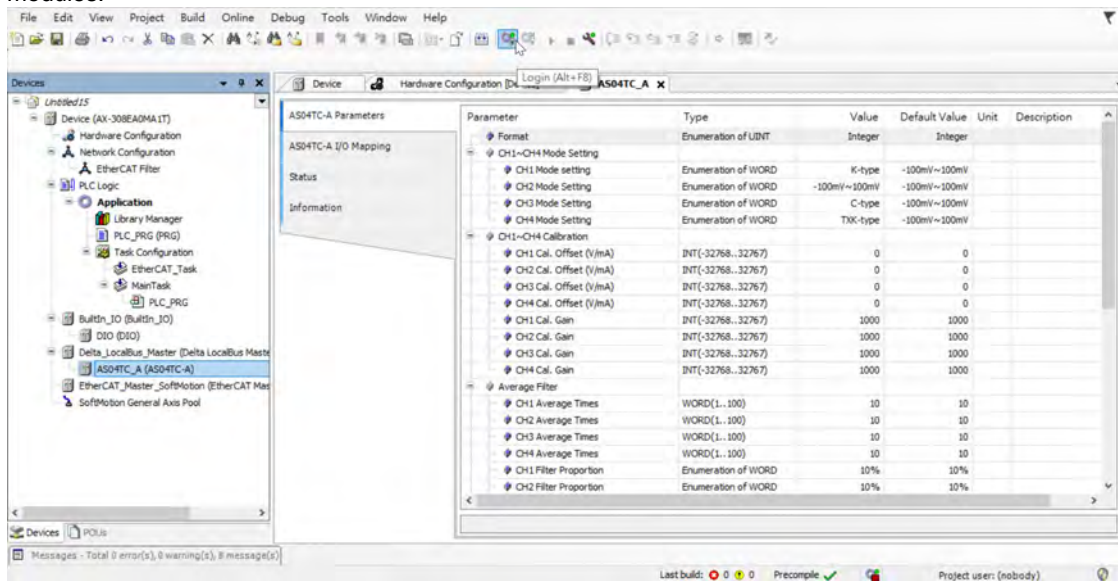

7.4.2 Checking the Version of a Module

- (1) Select the module and click the Information tab to see the module information.

The screenshot shows the 'AS04TC-A Parameters' dialog box with the 'Information' tab selected. The 'General' section contains the following information:

- Name:** AS04TC-A
- Vendor:** Delta Electronics, Inc.
- Categories:**
- Type:** 40000
- ID:** 16F7 8315
- Version:** 1.0.0.5
- Order Number:** AS04TC-A
- Description:** 4 channels thermocouple input : -100mV~100mV,H,K,R,S,T,E,N,B conversion time = 200ms/channell

- (2) Select the module and click **Login** on the tool bar to go to Online Mode. You can find the Module Revision from the Parameters tab.

The screenshot shows the software interface with the 'AS04TC-A' module selected in the 'Devices' tree. The 'Parameters' tab is active, displaying a table of parameters:

Parameter	Type	Current Value	Prepared Value	Value	Def.	Unit	Des.
Format	Enumeration of LIBV	Integer		Integer	Integer		
CH1~CH4 Mode Setting							
CH1~CH4 Calibration							
Average Filter							
Temperature Measurement Units							
Channel Detect and Alarm Settings	WORD	16#0000		16#...			
Module Revision	DWORD	16#00010400			0	0	Modu

7.4.3 Online Mode

- Select the module and click **Login** on the tool bar to go to **Online Mode**. You can monitor all configuration parameters. Values in the column of Prepared Value are configurable online. After editing the values in the Prepared Value column, click **Write Parameter** to confirm the change.

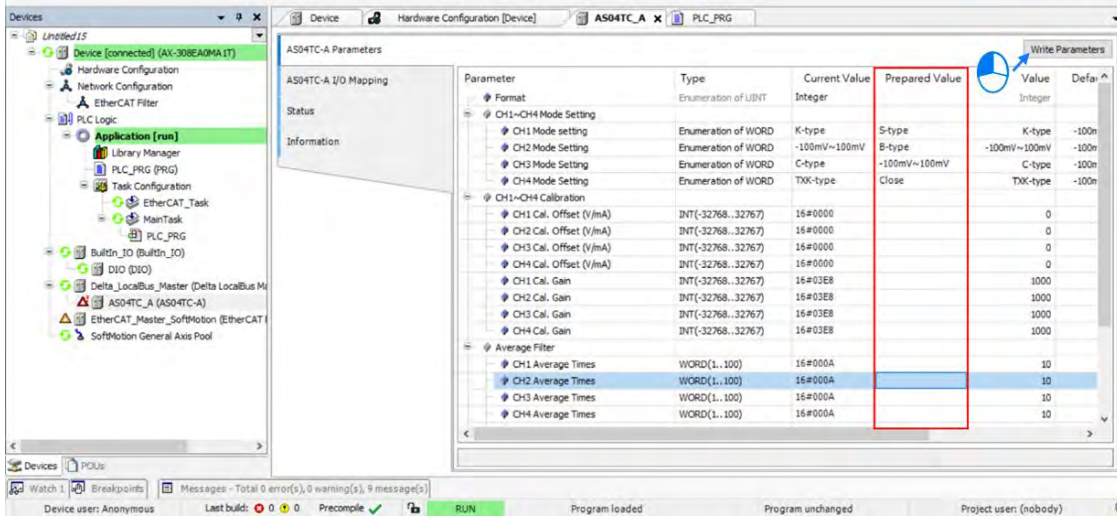

- You can monitor the values, status, error codes in each channel from the I/O Mapping tab.

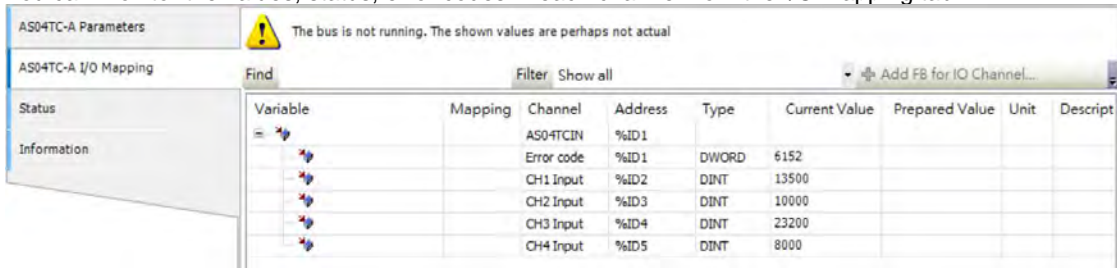

- You can monitor the current status and error codes from the Status tab.



7.4.4 Parameters

(1) You can set up the value format to **Integer** or **Floating** for Channel 1 to 4.

Parameter	Type	Value	Default Value	Unit	Description
Format	Enumeration of UINT	Integer	Integer		
CH1~CH4 Mode Setting					
CH1 Mode Setting	Enumeration of WORD	Integer	V~+10V		
CH2 Mode Setting	Enumeration of WORD	-10V~+10V	V~+10V		
CH3 Mode Setting	Enumeration of WORD	-10V~+10V	-10V~+10V		
CH4 Mode Setting	Enumeration of WORD	-10V~+10V	-10V~+10V		

(2) You can set up the values for Channel 1 to 4.

Parameter	Type	Value	Default Value	Unit	Description
Format	Enumeration of UINT	Integer	Integer		
CH1~CH4 Mode Setting					
CH1 Mode setting	Enumeration of WORD	K-type	-100mV~100mV		
CH2 Mode Setting	Enumeration of WORD	Close	-100mV~100mV		
CH3 Mode Setting	Enumeration of WORD	-100mV~100mV	-100mV~100mV		
CH4 Mode Setting	Enumeration of WORD	J-type	-100mV~100mV		
CH1~CH4 Calibration					
CH1 Cal. Offset (V/mA)	INT(-32768..32767)		0		
CH2 Cal. Offset (V/mA)	INT(-32768..32767)		0		
CH3 Cal. Offset (V/mA)	INT(-32768..32767)		0		
CH4 Cal. Offset (V/mA)	INT(-32768..32767)		0		
CH1 Cal. Gain	INT(-32768..32767)		1000		
CH2 Cal. Gain	INT(-32768..32767)	TXK-type	1000		

(3) You can set up the calibrations for for Channel 1 to 4.

Parameter	Type	Value	Default Value	Unit	Description
CH1~CH4 Calibration					
CH1 Cal. Offset (V/mA)	INT(-32768..32767)	0	0		
CH2 Cal. Offset (V/mA)	INT(-32768..32767)	0	0		
CH3 Cal. Offset (V/mA)	INT(-32768..32767)	0	0		
CH4 Cal. Offset (V/mA)	INT(-32768..32767)	0	0		
CH1 Cal. Gain	INT(-32768..32767)	1000	1000		
CH2 Cal. Gain	INT(-32768..32767)	1000	1000		
CH3 Cal. Gain	INT(-32768..32767)	1000	1000		
CH4 Cal. Gain	INT(-32768..32767)	1000	1000		

(4) You can set up the average filtering for Channel 1 to 4.

Parameter	Type	Value	Default Value	Unit	Description
Average Filter					
CH1 Average Times	WORD(1..100)	10	10		
CH2 Average Times	WORD(1..100)	10	10		
CH3 Average Times	WORD(1..100)	10	10		
CH4 Average Times	WORD(1..100)	10	10		
CH1 Filter Proportion	Enumeration of WORD	10%	10%		
CH2 Filter Proportion	Enumeration of WORD	10%	10%		
CH3 Filter Proportion	Enumeration of WORD	10%	10%		
CH4 Filter Proportion	Enumeration of WORD	10%	10%		

(5) You can set up the temperature measurement units Channel 1 to 4.

Temperature Measurement Units					
Temperature measurement units	Enumeration of WORD	°C	°C		°C
Channel Detect and Alarm Settings	WORD	°C	°C		
CH1 Overrange Detect	BOOL	°F	°F		FALSE
CH2 Overrange Detect	BOOL	FALSE	FALSE		FALSE
CH3 Overrange Detect	BOOL	FALSE	FALSE		FALSE
CH4 Overrange Detect	BOOL	FALSE	FALSE		FALSE

(6) You can set up the channel detect and alarm settings.

Channel Detect and Alarm Settings	WORD	0			
CH1 Overrange Detect	BOOL	FALSE	FALSE		
CH2 Overrange Detect	BOOL	FALSE	FALSE		
CH3 Overrange Detect	BOOL	FALSE	FALSE		
CH4 Overrange Detect	BOOL	FALSE	FALSE		
Reserved	BOOL	FALSE	FALSE		
Reserved	BOOL	FALSE	FALSE		
Reserved	BOOL	FALSE	FALSE		
Reserved	BOOL	FALSE	FALSE		
External Power Supply Error	BOOL	FALSE	FALSE		
Hardware Error	BOOL	FALSE	FALSE		
Adjustment Error	BOOL	FALSE	FALSE		

7.5 Troubleshooting

7.5.1 Error Codes

Error Code	Description	A↔ D LED Indicator	ERROR LED Indicator
16#1605	Hardware failure	OFF	ON
16#1607	The external voltage is abnormal.	OFF	ON
16#1608	The factory calibration is abnormal.	OFF	ON
16#1801	The external voltage is abnormal.	OFF	Blinking
16#1802	Hardware failure	OFF	Blinking
16#1804	The factory calibration is abnormal.	OFF	Blinking
16#1808	The signal received by channel 1 exceeds the range of inputs that the hardware can receive.	Run: blinking Stop: OFF	Blinking
16#1809	The signal received by channel 2 exceeds the range of inputs that the hardware can receive.		
16#180A	The signal received by channel 3 exceeds the range of inputs that the hardware can receive.		
16#180B	The signal received by channel 4 exceeds the range of inputs that the hardware can receive.		
16#180C	The signal received by channel 5 exceeds the range of inputs that the hardware can receive.		
16#180D	The signal received by channel 6 exceeds the range of inputs that the hardware can receive.		
16#180E	The signal received by channel 7 exceeds the range of inputs that the hardware can receive.		
16#180F	The signal received by channel 8 exceeds the range of inputs that the hardware can receive.		
-	When power-on, the module is not detected by CPU module.	OFF	Blinking once or twice and after 2 seconds, it blinks repeatedly

7.5.2 Troubleshooting Procedure

Description	Procedure
The external voltage is abnormal.	Ensure the external 24 V power supply to the module is functioning normally.
Hardware failure	Return the module to the factory for repair.
Internal error The factory calibration is abnormal.	Contact the factory.
The signal received by channel 1 exceeds the range of inputs that the hardware can receive.	Check the signal received by channel 1.
The signal received by channel 2 exceeds the range of inputs that the hardware can receive.	Check the signal received by channel 2.
The signal received by channel 3 exceeds the range of inputs that the hardware can receive.	Check the signal received by channel 3.
The signal received by channel 4 exceeds the range of inputs that the hardware can receive.	Check the signal received by channel 4.
The signal received by channel 5 exceeds the range of inputs that the hardware can receive.	Check the signal received by channel 5.
The signal received by channel 6 exceeds the range of inputs that the hardware can receive.	Check the signal received by channel 6.
The signal received by channel 7 exceeds the range of inputs that the hardware can receive.	Check the signal received by channel 7.
The signal received by channel 8 exceeds the range of inputs that the hardware can receive.	Check the signal received by channel 8.
When power-on, the module is not detected by CPU module.	Check if the connection between module and CPU module is working. If not, connect again.

Chapter 8 Load Cell Module AS02LC

Table of Contents

8.1	Overview	8-2
8.2	Specifications	8-2
8.2.1	Specifications	8-2
8.2.2	Profile	8-3
8.2.3	Arrangement of Terminals	8-4
8.2.4	Control Registers	8-5
8.2.5	Functions.....	8-13
8.2.6	Wiring.....	8-19
8.3	Making Adjustments	8-20
8.3.1	Steps to adjust points.....	8-20
8.3.2	Adjustment settings / LC Wizard	8-21
8.3.3	Adjustment Settings / Calibrational Commands	8-24
8.3.4	LED Indicators.....	8-27
8.4	HWCONFIG in ISPSOft	8-28
8.4.1	Initial Setting	8-28
8.4.2	Checking the Version of a Module	8-31
8.4.3	Online Mode.....	8-32
8.4.4	Importing/Exporting a Parameter File	8-33
8.4.5	Parameters	8-34
8.5	Basic Operation on DIADesigner-AX	8-37
8.5.1	Creating a New Project	8-37
8.5.2	Adding a Module	8-39
8.5.3	Parameters - Configuring the Module	8-41
8.5.4	I/O Mapping.....	8-44
8.5.5	Status.....	8-45
8.5.6	Information.....	8-45
8.6	Troubleshooting	8-46
8.6.1	Error Codes.....	8-46
8.6.2	Troubleshooting Procedure	8-47

8.1 Overview

This chapter describes the specifications for load cell modules, their operation, and their programming. You can use the AS02LC load cell module with four-wire or six-wire load cells with various eigenvalues, so you can adjust its response time according to your requirements. In addition, the AS02LC-A can read and write data via the AS Series PLC units using the FROM/TO instructions.

To ensure that the product is correctly installed and operated, read the manual carefully before use. This manual provides functional specifications, and it also introduces installation, basic operation, and settings. Refer to load cell related literature for more details on the principles of operating load cells.

For software operation, ISPSOft, DIADesigner or DIADesigner-AX is what you need. If you are using AS Series PLC CPU, refer to ISPSOft User Manual or DIADesigner Manual for more information. The new software DIADesigner-AX only supports AX Series PLC CPU and AS Series modules now, refer to AX-3 User Manual for more information on software operation.

8.2 Specifications

8.2.1 Specifications

Item	Description
Rated Supply Voltage/Power Consumption	24 VDC (-15% to +20%) / 3 W
Minimum/Maximum Voltage	18–31.2 VDC
Maximum Current Consumption	150 mA
Input Signal Range	±40 mVDC
Sensibility	+5 VDC +/-10%
Highest Accuracy	0.04 % of full scale
Communication Interface	RS-232, RS-485
Applicable Sensor Type	4-wire or 6-wire load cell
Expanding a Temperature Coefficient	≤ ±50 ppm/K v. E
Reducing a Temperature Coefficient to Zero	≤ ±0.4 μV/K
Linearity Error	≤0.02%
Response Time	2.5, 10, 16, 20, 50, 60, 100, 200, and 400 ms
Eigenvalue Applicable to a Load Cell	0–1, 0–2, 0–4, 0–6, 0–20, 0–40 and 0–80 mV/V
Maximum Distance for Connecting a Load Cell	100 meters
Maximum Output Current	5 VDC x 160 mA
Allowable Load	40–4010 Ω

Item	Description
Common-mode Rejection Ratio (CMRR @50/60 Hz)	≥100 dB
Maximum Filter	0 ~ 8
Average Weights	1–100 (FM V1.04: supports 1-400)
Isolation	Between a digital circuit and the ground: 500 VAC Between an analog circuit and the ground: 500 VAC Between an analog circuit and a digital circuit: 500 VAC
Weight	147 g

8.2.2 Profile

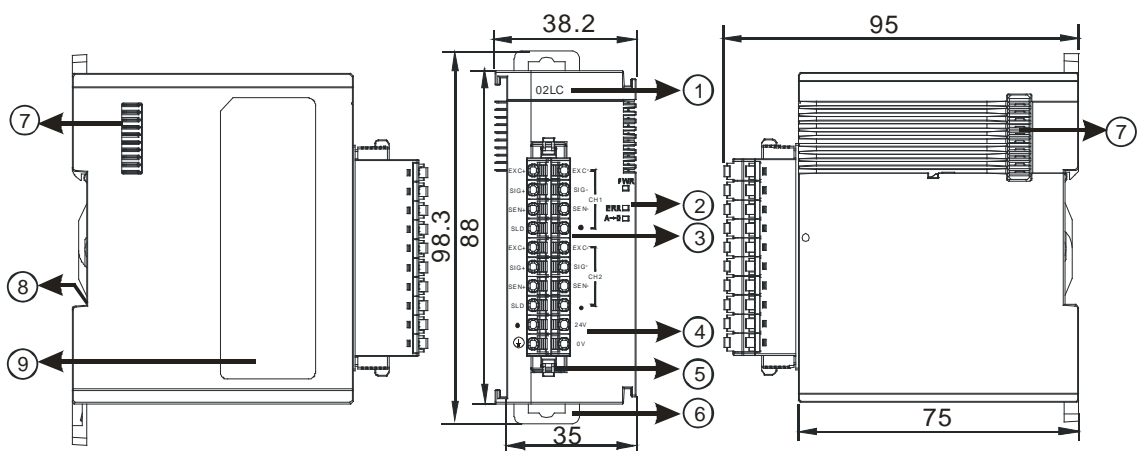

Unit: mm

Number	Name	Description
1	Model Name	Model name of the module
2	RUN LED Indicator	Operating status of the module ON: the module is running. OFF: the module is not running.
	ERROR LED Indicator	Error status of the module ON: a serious error exists in the module. OFF: the module is operating normally. Blink: a minor error exists in the module.
	Analog-to-Digital Conversion Indicator	Conversion status Blinking: conversion is in process. OFF: conversion has stopped.
3	Removable Terminal Block	The inputs are connected to transducers. The outputs are connected to loads to be driven.

Number	Name	Description
4	Arrangement of the Input/Output Terminals	Arrangement of the terminals
5	Clip	For removing the terminal block
6	DIN Rail Clip	Secures the module onto the DIN rail
7	Module Connecting Set	Connects the modules
8	Ground Clip	
9	Label	Nameplate

8.2.3 Arrangement of Terminals

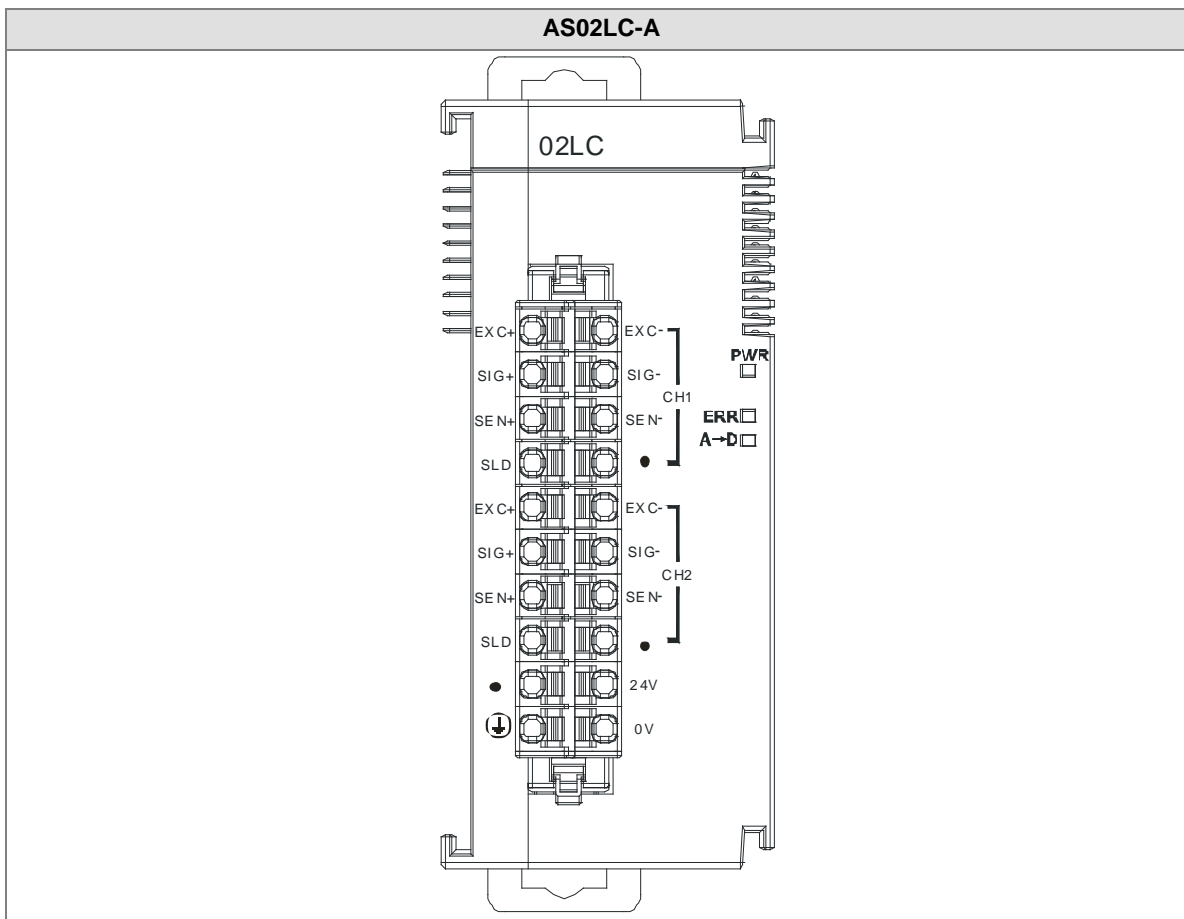

8.2.4 Control Registers

*If you use HWCONFIG to set values in CRs, once the set value is downloaded, the values can be retained in the module; however if you use TO instruction to write data into CRs, the values CANNOT be retained, after power failure or after transition of the CPU from STOP to RUN.

Note: The attribute of the CR must be W (write) to use TO instruction.

CR#	Name	Description	Att.	Default
0	Display options for CH1	0: disabled 1: gross weight 2: net weight 3: raw data	R/W	1
1	Eigenvalue for CH1	0: 1 mV/V 1: 2 mV/V 2: 4 mV/V 3: 6 mV/V 4: 20 mV/V 5: 40 mV/V 6: 80 mV/V	R/W	1
2	Sampling cycle for CH1	0: 2.5ms 1: 10ms 2: 16ms 3: 20ms 4: 50ms 5: 60ms 6: 100ms 7: 200ms 8: 400ms	R/W	4
3	Weight measured times in a stability range for CH1	Range: 1–500	R/W	5
4	Stability range for CH1	Floating-point format	R/W	10
5		Range: 0–100000		
6	Maximum weight for CH1	Floating-point format Maximum measuring weight; when the	R/W	100,000

CR#	Name	Description	Att.	Default
7		weight measured exceeds the limit, an alarm is triggered. The value should be greater than 1.		
8	Filter mode for CH1	0: no filter (default) 1: maximum filter mode 2: average filter mode Note: FW V1.06 or later: low-pass filter is available; refer to section 8.2.5 for more information.	R/W	0
9	Maximum filter for CH1	Range: 0–8; the bigger the number the stronger the filter	R/W	1
10	Average weight measured times for CH1	Range: 1–100 (for FW V1.04: 1–400 is available)	R/W	10
11	Upper limit of the zero return for CH1	Floating-point format Determines the current weight as the zero point in the upper/lower range; when the lower range is larger than the upper range, the lower range is read as the upper range and vice versa.	R/W	10
12				
13	Lower limit of the zero return for CH1		R/W	-10
14				
15	Zero point tracking time for CH1	Range: 5–500 Unit: 100 ms	R/W	10
16	Zero point tracking range for CH1	Floating-point format Range: 0–10000; 0: disabled	R/W	0
17				
18	Calibration points for CH1	Range: 2–20	R/W	2
19–58	Calibrated weight for CH1	Floating-point format Calibrated weight of the calibration points 1–20	R/W	-
59	Display options for CH2	0: disabled 1: gross weight 2: net weight 3: raw data	R/W	1
60	Eigenvalue for CH2	0 : 1 mV/V	R/W	1

CR#	Name	Description	Att.	Default
		1 : 2 mV/V 2 : 4 mV/V 3 : 6 mV/V 4 : 20 mV/V 5 : 40 mV/V 6 : 80 mV/V		
61	Sampling cycle for CH2	0 : 2.5 ms 1 : 10 ms 2 : 16 ms 3 : 20 ms 4 : 50 ms 5 : 60 ms 6 : 100 ms 7 : 200 ms 8 : 400 ms	R/W	4
62	Weight measured times in a stability range for CH2	Range: 1–500	R/W	5
63	Stability range for CH2	Floating-point format	R/W	10
64		Range: 0–100000		
65	Maximum weight for CH2	Floating-point format Maximum measuring weight; when the weight measured exceeds the limit, an alarm is triggered. The value should be greater than 1.	R/W	100,000
66				
67	Filter mode for CH2	0: no filter (default) 1: maximum filter mode 2: average filter mode Note: FW V1.06 or later: low-pass filter is available; refer to section 8.2.5 for more information.	R/W	0
68	Maximum filter for CH2	Range: 0–8; the bigger the number the stronger the filter	R/W	1
69	Average weight measured	Range: 1–100	R/W	10

CR#	Name	Description	Att.	Default
	times for CH2	(for FW V1.04: 1–400 is available)		
70	Upper limit of the zero return	Floating-point format	R/W	10
71	for CH2	Determines the current weight as the zero		
72	Lower limit of the zero return for CH2	point in the upper/lower range; when the	R/W	-10
73		lower range is larger than the upper range, the lower range is read as the upper range and vice versa.		
74	Zero point tracking time for CH2	Range: 5–500 Unit: 100 ms	R/W	10
75	Zero point tracking range for	Floating-point format	R/W	0
76	CH2	Range: 0–10000; 0: disabled		
77	Calibration points for CH2	Range: 2–20	R/W	2
78–117	Calibrated weight for CH2	Floating-point format Calibrated weight of the calibration points 1–20	R/W	-
118	Decimal place for CH1	Range: 0–4	R/W	1
119	Decimal place for CH2	Range: 0–4	R/W	1
120	Alarm	0: warning 1: alarm Bit0: error in the power supply Bit1: error in the module hardware Bit2: error in the driver board	R/W	1
200	State register	Refer to the explanation below.	R/W	-
201	Command set	Refer to the explanation below.	W	0
210	The maximum peak value for	Floating-point format	R	-
211	CH1	Maximum peak value for CH1		-
212	The maximum peak value for	Floating-point format	R	-
213	CH2	Maximum peak value for CH2		-
214	The minimum peak value for	Floating-point format	R	-
215	CH1	Minimum peak value for CH1		-
216	The minimum peak value for	Floating-point format	R	-
217	CH2	Minimum peak value for CH2		-

CR#	Name	Description	Att.	Default
222	The time to record for CH1	Unit: 1 ms	R/W	50
223	The time to record for CH2	Range: 1–100 (1 ms–1 s) Time to record the digital value for the channels		50
240	The number of records for CH1	Range: 0–500; display the current records	R	-
241	The number of records for CH2			-
400–439	Calibration of the raw data for CH1	Here displays the 20 piece of raw data in DWORD format for channel 1 and 2; the values will be loaded automatically during calibration. You can copy the values to other load cell modules of the same model number and with similar parameter settings for a quick commissioning without calibration. Note: By copying the calibration of the raw data to other modules, some errors or deviation may occur in the weighted values for different applications.	R/W	-
440–479	Calibration of the raw data for CH2		R/W	-
604	Tare weight measured by CH1	Display the tare weight measured by CH1	R/W	-
605				-
606	Tare weight measured by CH2	Display the tare weight measured by CH2	R/W	-
607				-
700–739	Theoretical calibration for CH1	Floating-point format Output voltage unit: mV	R/W	0
740–779	Theoretical calibration for CH2	Floating-point format Output voltage unit: mV	R/W	0
4000–4999	Records for CH1	Floating-point format 500 records for CH1	R	-
5000–5999	Records for CH2	Floating-point format 500 records for CH2	R	-

Normal Exchange Area

Explanation

You can view the error code, the channel value, and the state code, as well as the data registers that correspond to their commands under the Normal Exchange Area tab of the Device Setting dialog box in the HWCONFIG utility in ISPSOft.

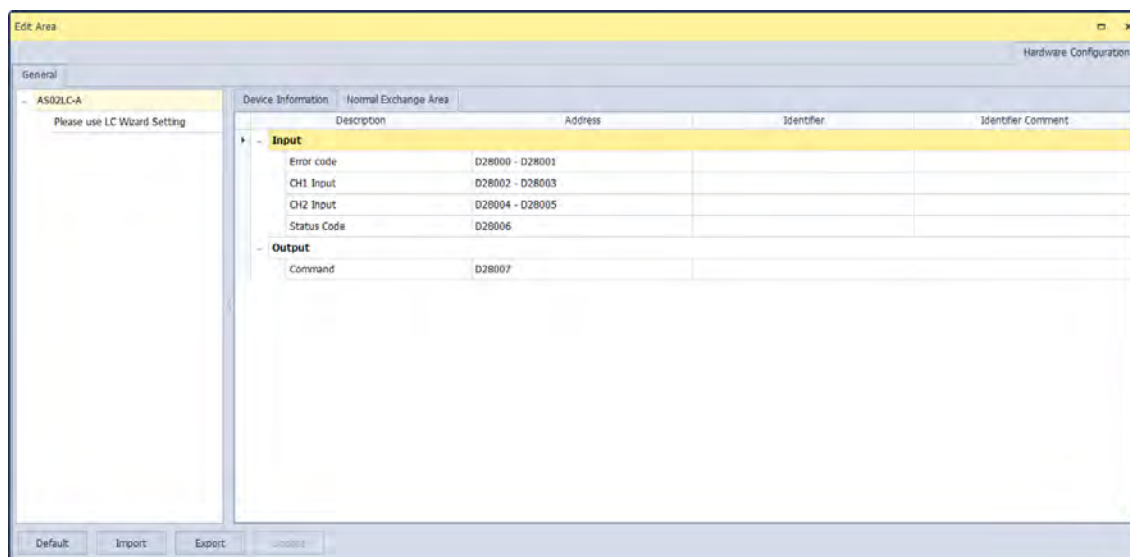

CR#200: Codes for the state register

Explanation

Bit	Code	Definition	Bit	Code	Definition
b0	16#0001	Error exists in the power supply.	b1	16#0002	Error exists in the module hardware.
b2	16#0004	Error exists in the driver board.	b3	16#0008	Calibration disabled
b4	16#0010	Reserved	b5	16#0020	Reserved
b6	16#0040	The weight measured by CH1 exceeds the maximum weight that can be measured, or the voltage of SEN is incorrect.	b7	16#0080	The weight measured by CH2 exceeds the maximum weight that can be measured, or the voltage of SEN is incorrect.
b8	16#0100	The weight measured by CH1 exceeds the maximum weight that can be measured.	b9	16#0200	The weight measured by CH2 exceeds the maximum weight that can be measured.
b10	16#0400	CH1 has been adjusted incorrectly.	b11	16#0800	CH2 has been adjusted incorrectly.
b12	16#1000	CH1 is not measuring any weight.	b13	16#2000	CH2 is not measuring any weight.
b14	16#4000	The weight measured by CH1 is in	b15	16#8000	The weight measured by CH2 is in

Bit	Code	Definition	Bit	Code	Definition
		the stability range specified.			the stability range specified.

Note: The state is determined by the corresponding bit and it is possible to have more than 2 states at the same time.

CR#201: Command set**Explanation**

Input value	Description	Input value	Description
0	No action	16#0101	Start a new recording of the peak value for CH1.
1–20	Commands for calibrating the calibration points 1–20 on CH1	16#0102	Start a new recording of the peak value for CH2.
21–40	Commands for calibrating the calibration points 1–20 on CH2	16#010F	Start a new recording of the peak value for CH1 - CH2.
98	Activate the weight calibration.	16#0201	Start a new recording for CH1.
99	Deactivate the weight calibration.	16#0202	Start a new recording for CH2.
100	Subtract the weight on CH1. Use the subtracted weight as the tare weight and store it in CR604 and CR605 (DWORD).	16#020F	Start a new recording for CH1 - CH2.
101	Restore the tare weight stored in CR604 and CR605 to CH1.	16#0211	Stop recording for CH1.
102	Clear the weight measured by CH1 to zero. You might need to execute this command after each power-off.	16#0212	Stop recording for CH2.
103	Subtract the weight on CH2. Use the subtracted weight as the tare weight and store it in CR606 and CR607 (DWORD).	16#021F	Stop recording for CH1 - CH2.
104	Restore the tare weight stored in CR606 and CR607 to CH2.	16#0301	Start a theoretical calibration for CH1.
105	Clear the weight measured by CH2 to zero. You might need to execute this	16#0302	Start a theoretical calibration for CH2.

Input value	Description	Input value	Description
	command after each power-off.		
16#030F	Start a theoretical calibration for CH1 - CH2.	16#0501	Restore default settings and clear settings in Flash.
16#0502	Restore default settings and settings in Flash stay intact.	16#6000	Read the current settings from Flash
16#6001	Write the current settings into Flash		

8.2.5 Functions

Item	Function	Description
1	Measuring net weight	Various measuring modes to choose from
2	Stability check	When an object is put on a load cell, you can check whether the present weight of the object is in a specified stability range.
3	Determining zero point	If an object is removed from the load cell, no weight is measured.
4	Filter out weights	Filter out the maximum or minimum weight measured or use an average weight for a more accurate value.
5	Multi-point adjustment	There are as many as 20 points for adjustment
6	Theoretical calibration	Calibration based on the output value of the sensor instead of the real weight calibration
7	Zero point tracking	Zero point tracking
8	Limit detections for channels	Save the maximum and minimum values for channels.
9	Records for channels	Save the analog curves for channels.

1. Measuring net weight

You can choose to measure either the net weight or the gross weight of an object. Net weight is the actual weight of a product without its package. The weight of a package is the tare weight. Gross weight is the total weight: net weight plus tare weight.

- Tare weight: the weight of a package
- Net weight: the weight of a product, that is, the actual weight of a product without its package
- Gross weight: the total weight, that is, the net weight of a product plus the tare weight of its package
- Gross weight=Net weight+Tare weight

Example: a product weighs 10 kg, and the carton in which the product is packed weighs 0.2 kg. The gross weight is 10.2 kg.

Net weight = 10 kg

Tare weight = 0.2 kg

Gross weight = 10.2 kg

2. Checking stability

When an object is placed on a load cell, you can check whether the present weight of the object is in a specified stability range.

- If the weight measured is in the specified stability range, the corresponding bit is set to 1.
- If the weight measured exceeds the specified stability range, the corresponding bit is set to 0 until the number of objects weighed in the stability range reaches the setting.

Example: the measurement time set is 10 ms, the number of weights measured in a stability range is 10, and the stability range is 1000 g. If a variation exceeds 1000 g, the corresponding bit is set to 0. If the variations within 100 ms (10×10 ms) are within 1000 g, the corresponding bit is set to 1. You should determine whether the present weight measured is in the stability range before you perform control actions.

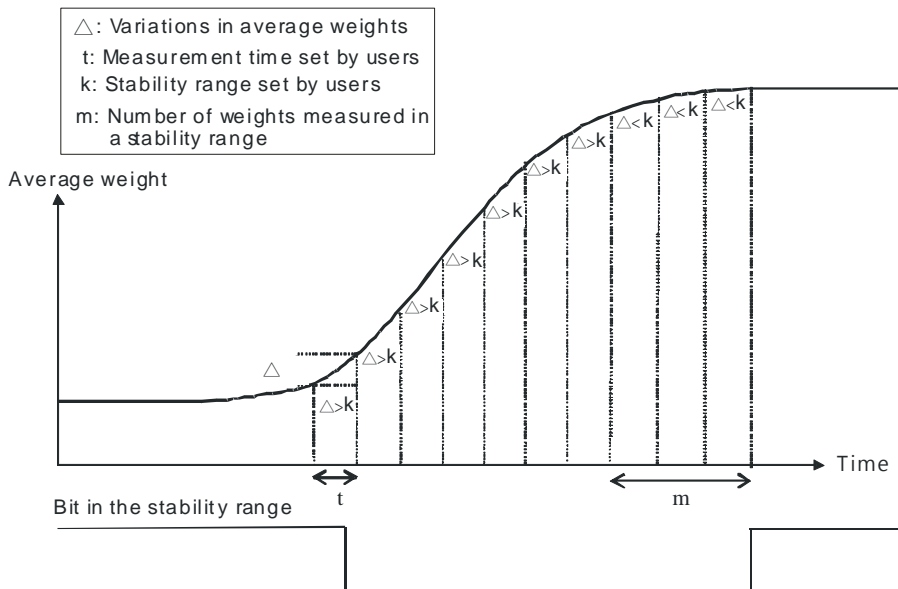

3. Determining zero point

If an object is removed from the load cell, the corresponding bit is set to 1, and you can perform the next control action. If a weight measured is in the specified zero range, the corresponding bit is also set to 1.

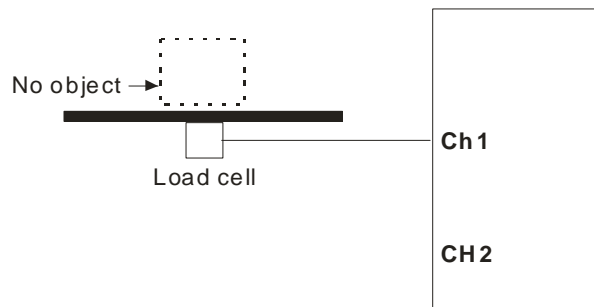

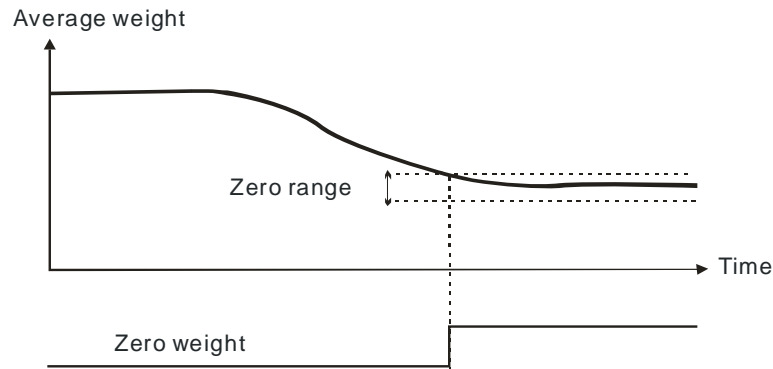

4. Filtering

There are three methods to filter

- Filtering out the maximum/minimum weight measured: If there is a maximum weight or a minimum weight, you can filter out the maximum weight or the minimum weight. The larger the value, the more weights are filtered out. Range: K0–K8
- Averaging weights: The values recorded are averaged so that a steady value is obtained. There may be peak values due to unavoidable external factors, and the average value obtained may change accordingly. A maximum of 100 values can be averaged.
- Low-pass filter (available for FWV1.06)
Work with the function block MLPF to set up different filtering ranges. Refert to MLPF instruction (API1430) from AS Series Programming Manual for more information.

5. Making multi-point adjustments

Make adjustments to get the weight measured by a cell to correspond to the digital value displayed by the load cell module. Generally, two points are adjusted. After a system is set up, put no load on the scale. The weight measured is 0 grams when there is no load. Then place an object of a given weight on the scale, and set a digital value corresponding to the weight. At that point, two points have been adjusted. For example, if you have a load cell sensor which can measure a maximum weight of 10 kg, and if 1 kg corresponds to K1000, the curve is like the one shown below.

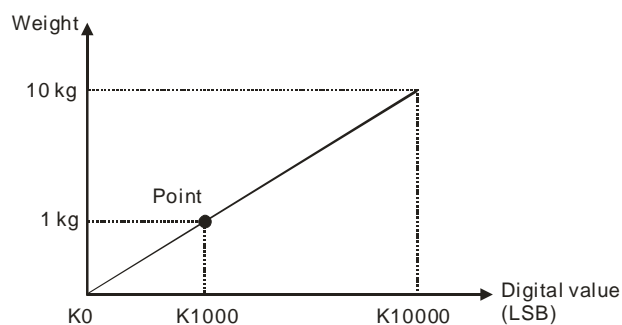

Adjusting two points

In addition to this two-point adjustment, the load cell also supports adjustments of up to 20 points. A characteristic curve is shown below.

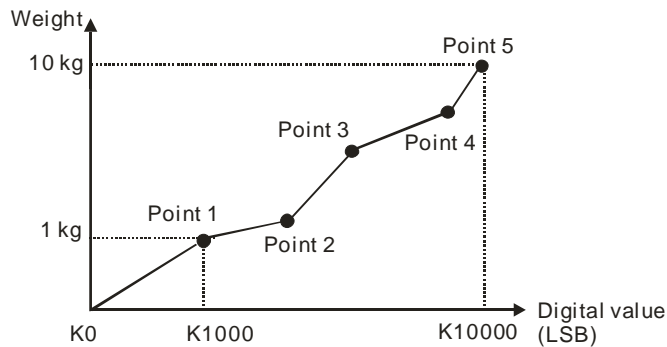

Adjusting multiple points

6. Determining theoretical calibration

Theoretical calibration is determined according to the sensor specification in order to input the voltage values corresponding to various weights. The registers for storing the voltage values are CR#700–739 for CH1 and CR#740–779 for CH2. After entering the voltage values into the registers, you can use the command set 16#301–302 to execute the calibration.

Example: the sensor specification is 10 kg and its eigenvalue is 2 mV/V. When the sensor is loaded with a 10 kg weight, the output is 10 mV. The theoretical calibration steps are:

Step 1: set the eigenvalue.

Parameter name	Value	Unit	Default	Minimum	Maximum
CH1 gross/net setting	gross		gross	-	-
CH1 Characteristic value	2mV/V		2mV/V	-	-
CH1 sampling time	50ms		50ms	-	-

Step 2: set the 2-point adjustment; when the sensor is loaded with a 1 kg weight, set the value to 1000.

Parameter name	Value	Unit	Default	Minimum	Maximum
CH1 Adjustment number	2		2	2	20
CH1 weight of Adjustment point 1 (Zero)	0		0	0	0
CH1 weight of Adjustment point 2	1000		1000	-	-

Step 3: set the voltage calibration for the zero point to 0 (0 mV) in the CR#700/701 registers, and to 1.0 (1 mV) in the CR702/703 registers.

Step 4: enable the calibration function and enter 98 into the command set CR#201.

Step 5: enter 16#0301 into the command set CR#201 to execute a theoretical calibration for channels 1.

Step 6: do not put any load on the sensor and enter 16#102 into the command set CR#201 to reset the value to 0 for CH1.

Step 7: disable the calibration function to prevent inappropriate changes. To complete the theoretical calibration, enter 99 into the command set CR#201. Put a 1 kg weight on the sensor and the load cell should show 1000.

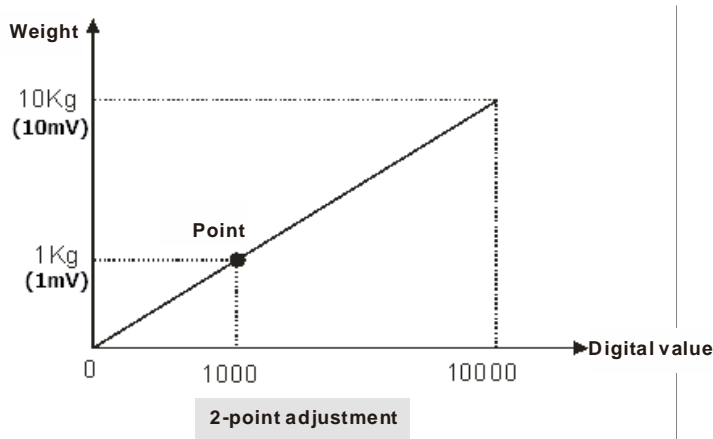

Step 8: write 16#6001 in CR#201 to disable the calibration function to write the current settings into Flash and have the settings in the latched area.

7. Zero point tracking

Zero point tracking refers to resetting the current value to 0. You can reset the value to 0 within a certain duration or at a certain weight. This is especially useful when the sensor is no longer as accurate as it was before.

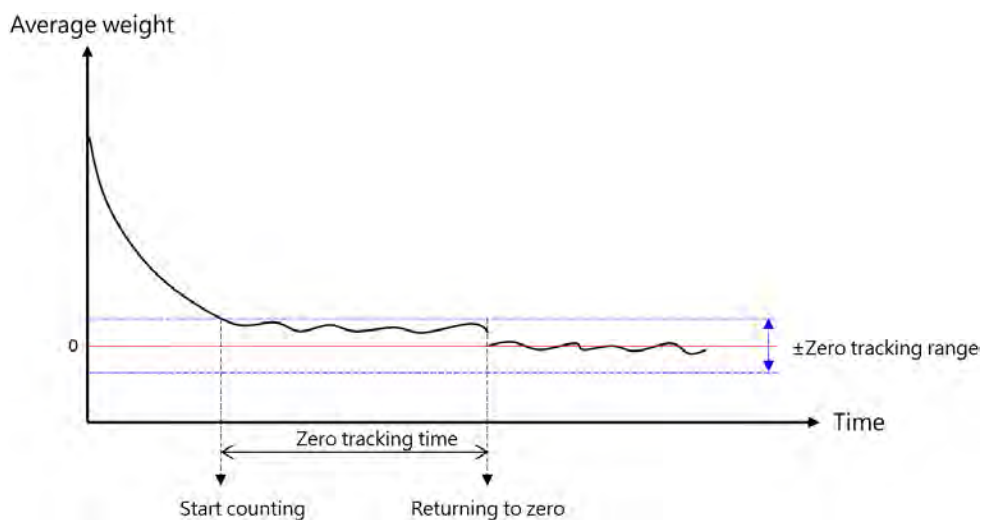

8. Limit detections for channels

Save the maximum and minimum values for channels so you can determine the peak to peak values.

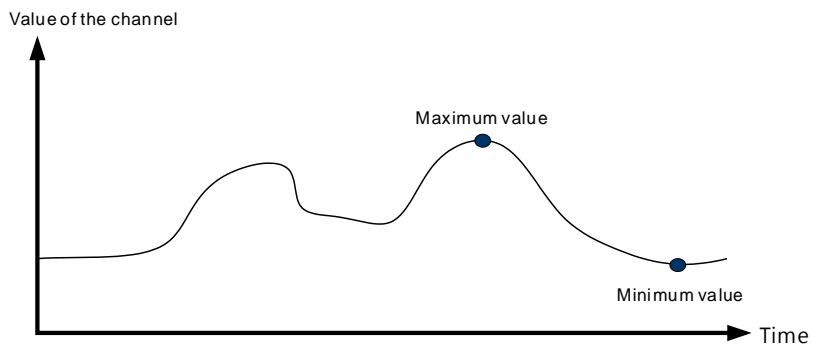

9. Recording channels

Record the input values of the cyclic sampling for each channel. The system saves up to 500 data points and the recording time is 10 ms.

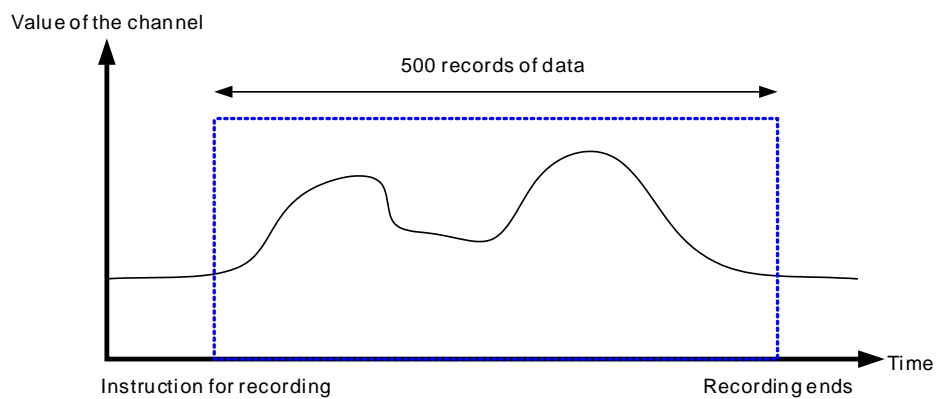

8.2.6 Wiring

- External wiring

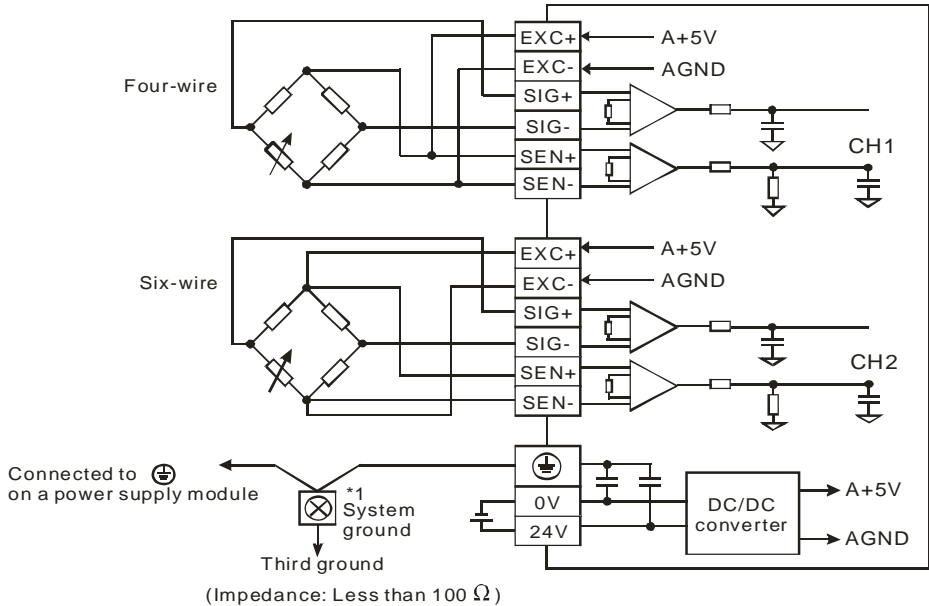

- Multiple load cells connected in parallel are connected to a single load cell module.

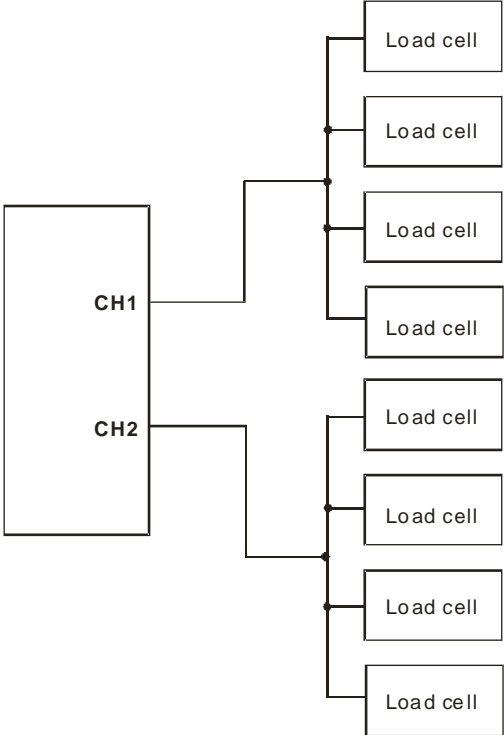

Note 1: Please connect ⏚ on the power supply module and ⏚ on the load cell module to a system ground, and then ground the system ground or connect the system ground to a distribution box.

Note 2: If multiple load cells are connected in parallel, the total impedance should be greater than 40 Ω.

8.3 Making Adjustments

Make adjustments to get the weight measured by a cell to correspond to the digital value displayed by the load cell module. You can make adjustments by following the commands below or by setting up the theoretical calibration (refer to section 8.2.5 for more details).

8.3.1 Steps to adjust points

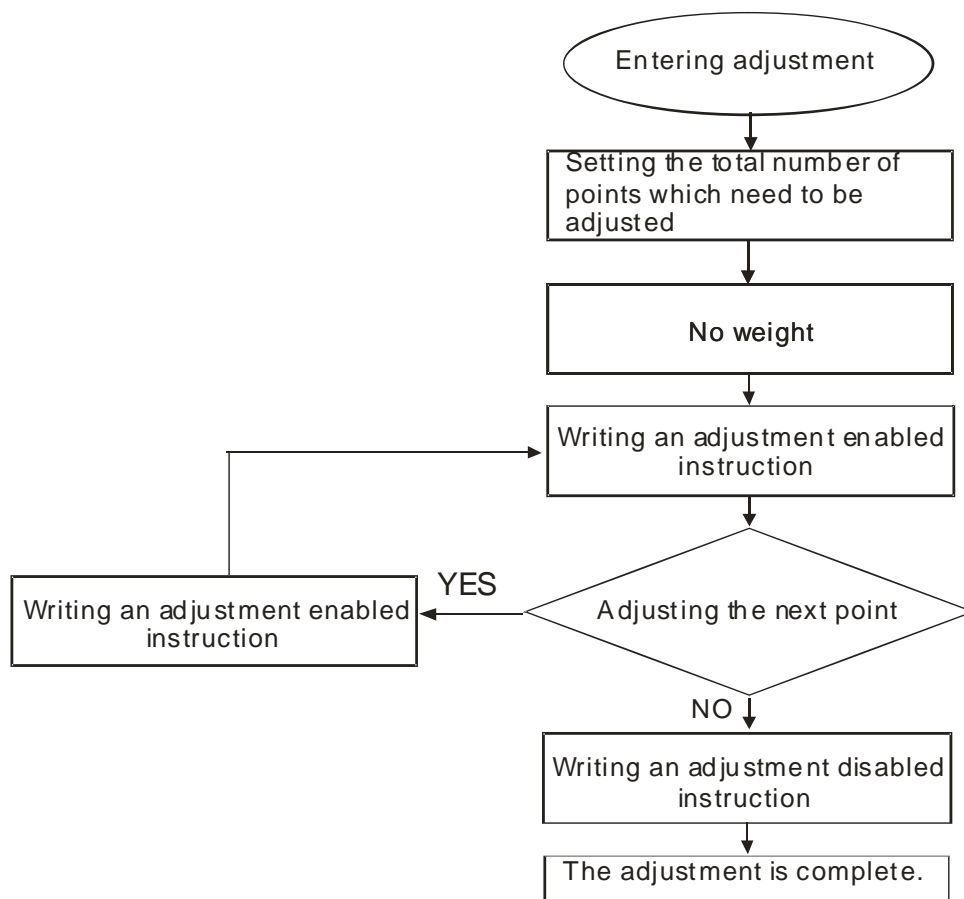

8.3.2 Parameter settings in LC Wizard

Step 1: Open LC Wizard from HWCONFIG.

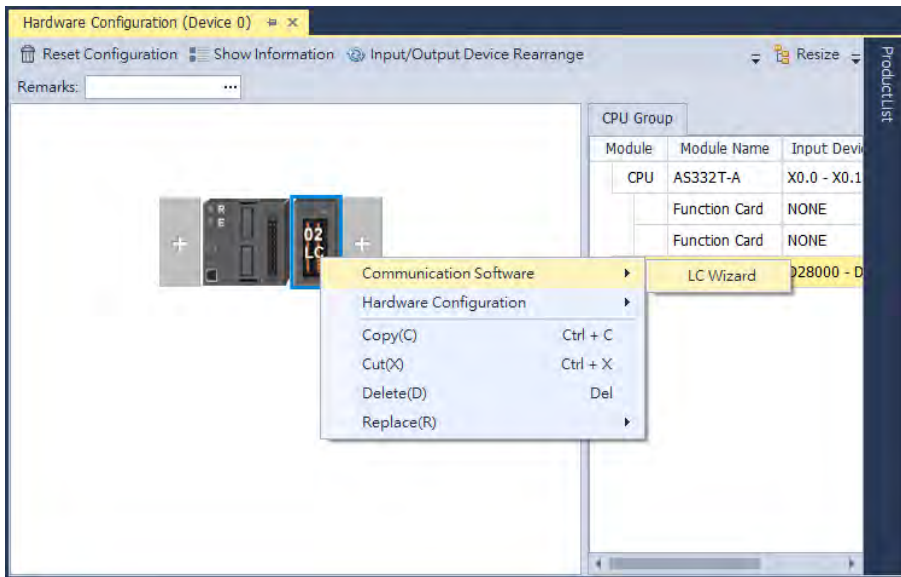

Step 2: Set the eigenvalue.

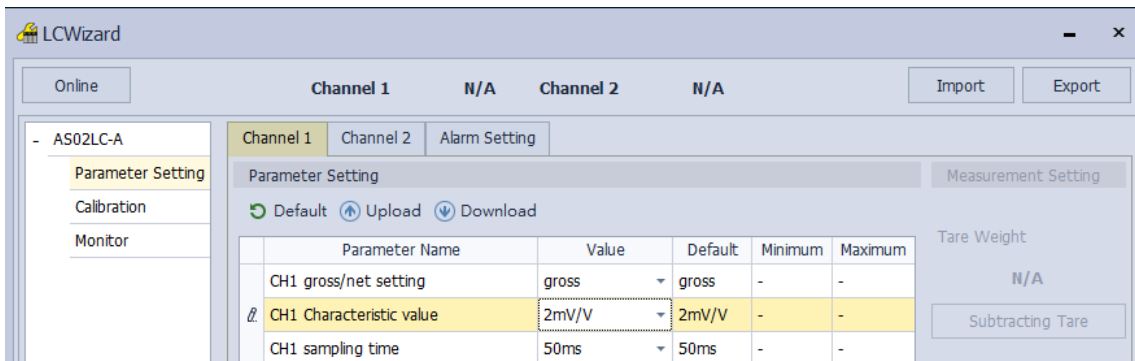

Step 3: Set the number of adjustments and their corresponding values. The example below shows a 2-point adjustment in which point 1 = 0 and point 2 = 1000, corresponding to 1 kg.

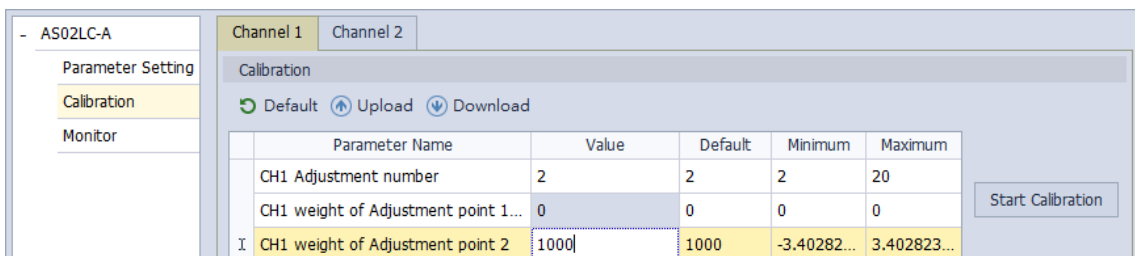

Step 4: After the configuration is complete, download the parameters to the module.

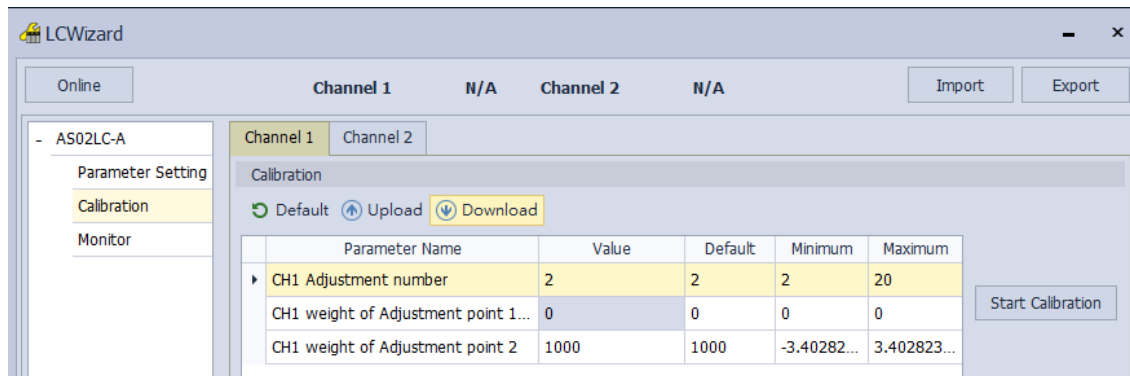

Step 5: Start calibration.

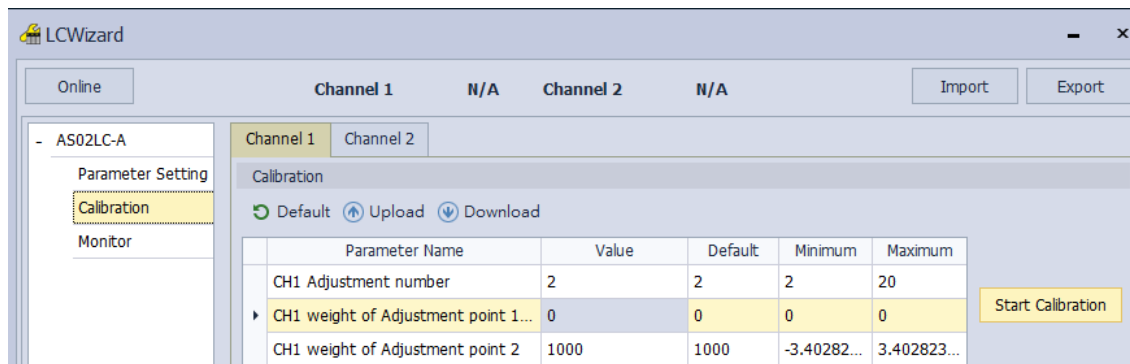

Step 6: Leave no load on the load cell (adjustment point 1) and click **Next Step** to proceed.

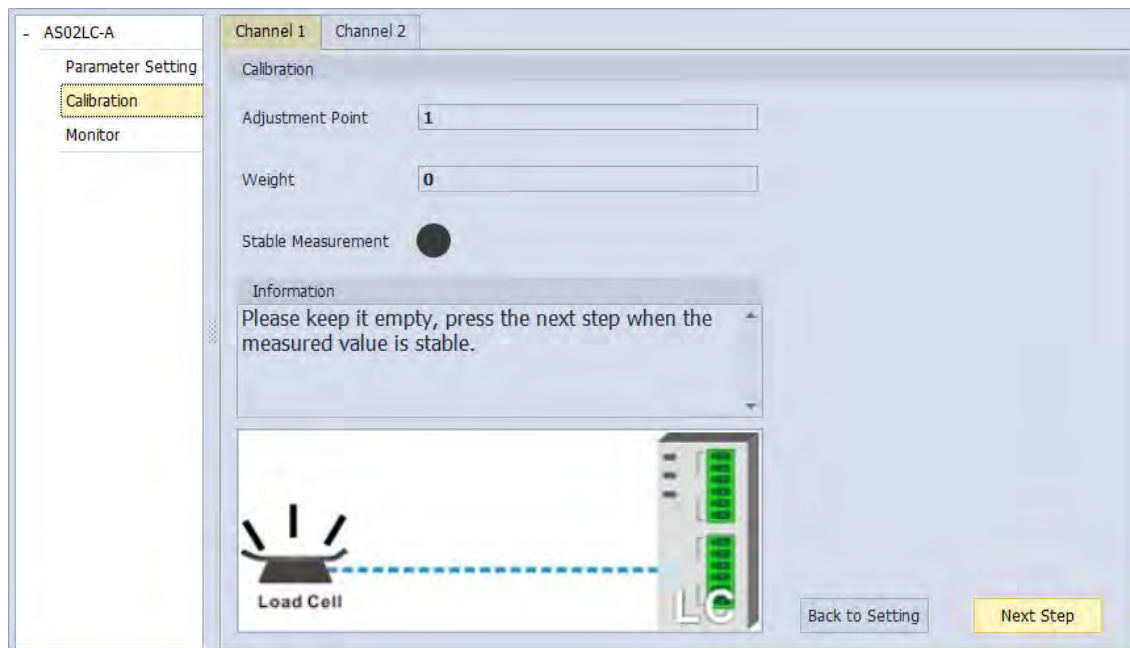

Step 7: Put a load on the load cell (adjustment point 2). For multi-point adjustment, repeat this step. This example uses a 1 kg weight.

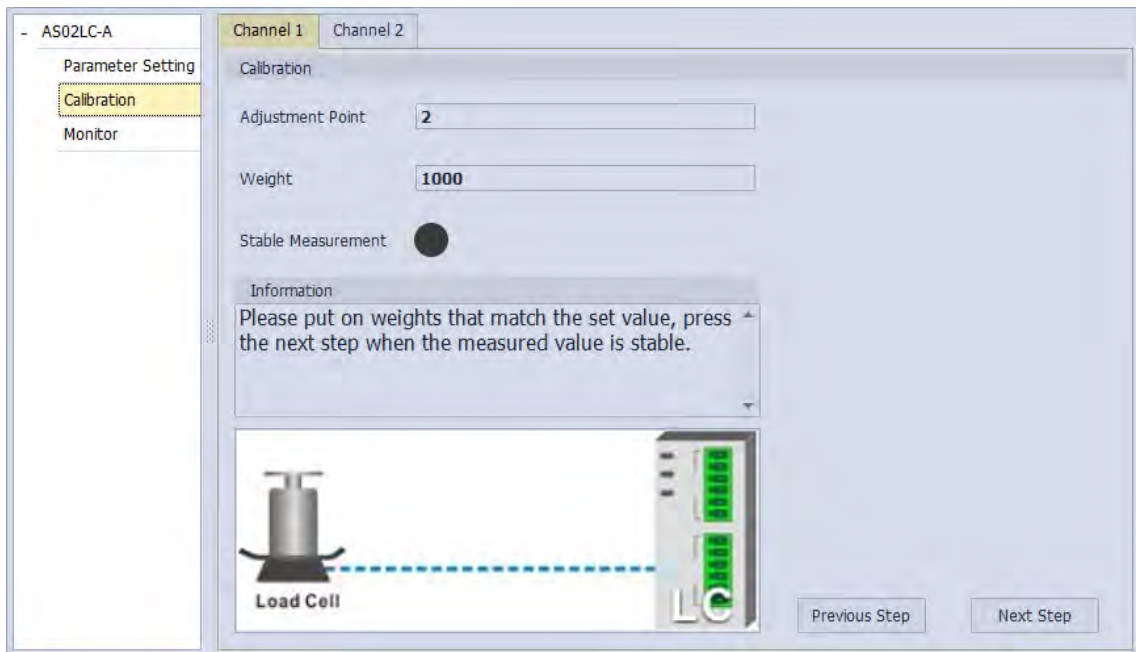

Step 8: The calibration is complete.

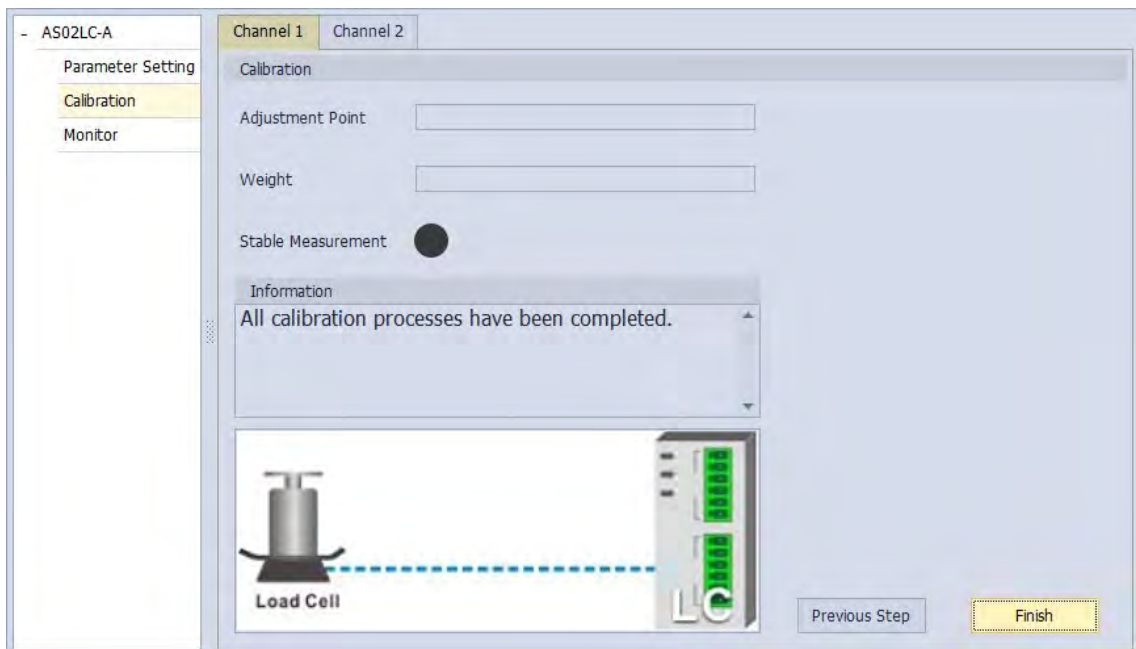

A characteristic curve is shown below.

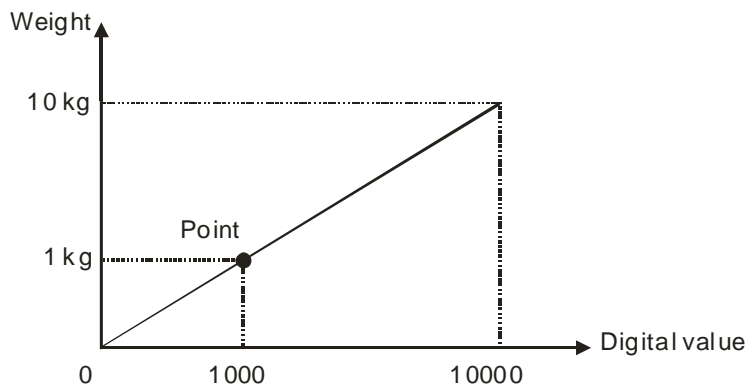

Adjusting two points

8.3.3 Adjustment Settings / Calibrational Commands

Step 1: Set the eigenvalue in LCWizard.

The screenshot shows the LCWizard interface for AS02LC-A. The 'Parameter Setting' tab is active for Channel 1. The following table represents the data shown in the interface:

Parameter Name	Value	Default	Minimum	Maximum
CH1 gross/net setting	gross	gross	-	-
CH1 Characteristic value	2mV/V	2mV/V	-	-
CH1 sampling time	50ms	50ms	-	-

Step 2: Set the number of adjustments and their corresponding values. The example below shows a 2-point adjustment where point 1 = 0 and point 2 = 1000, corresponding to 1 kg.

The screenshot shows the LCWizard interface for AS02LC-A. The 'Calibration' tab is active for Channel 1. The following table represents the data shown in the interface:

Parameter Name	Value	Default	Minimum	Maximum
CH1 Adjustment number	2	2	2	20
CH1 weight of Adjustment point 1...	0	0	0	0
CH1 weight of Adjustment point 2	1000	1000	-3.40282...	3.402823...

Step 3: After the configuration is complete, download the parameters to the module.

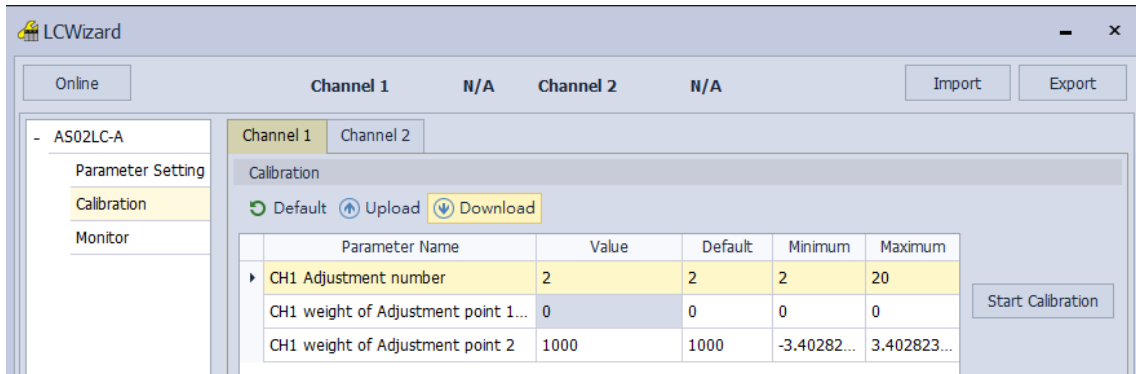

Step 4: Double-click on the module to see the settings and verify that the corresponding address the command is D28007 in the Normal Exchange Area.

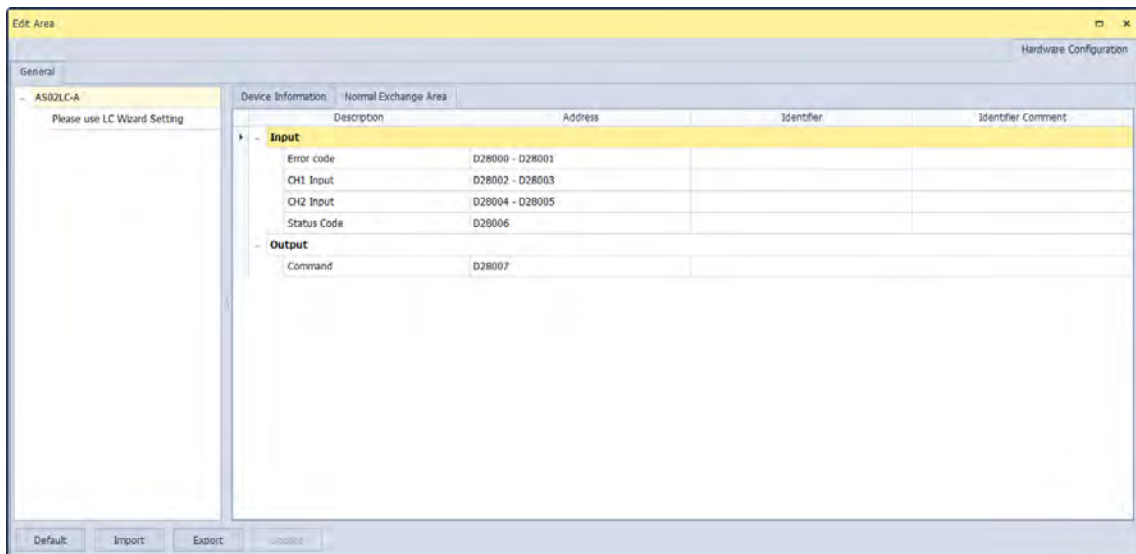

Step 5: Enter the command for activating the weight calibration 98 into D28007.

Step 6: Leave no load on the load cell (adjustment point 1) and enter 1 into D28007. 1 represents CH1 and 2 represents CH2.



Object	Identifiers	Device Name	Status	Data Type	Value (16bits)	Value (32bits)
		D28007			1	1

Step 7: Put a load on the load cell (adjustment point 2). For multi-point adjustment, repeat this step. This example uses a 1 kg weight.



Object	Identifiers	Device Name	Status	Data Type	Value (16bits)	Value (32bits)
		D28007			2	2

Step 8: to complete the adjustment, enter the command for deactivating the weight calibration 99 into D28007.

A characteristic curve is shown below.

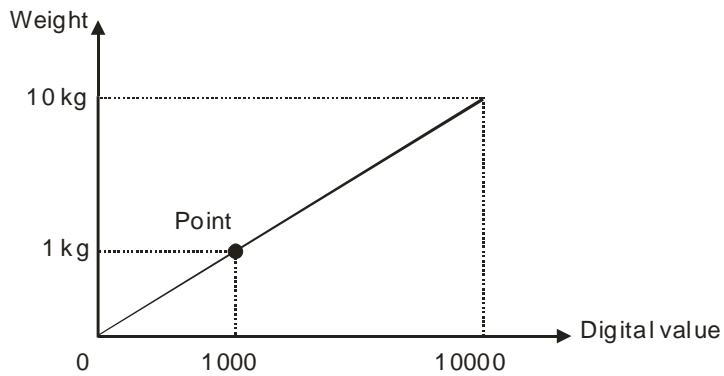

Adjusting two points

8.3.4 LED Indicators

Number	Name	Description
1	RUN LED Indicator	Operating status of the module ON: the module is running. OFF: the module is not running.
2	ERROR LED Indicator	Error status of the module ON: a serious error exists in the module. OFF: the module is operating normally. Blink: a minor error exists in the module.
3	Analog-to-Digital Conversion Indicator	Conversion status Blinking: conversion is in process. OFF: conversion has stopped.

8.4 HWCONFIG in ISPSOft

8.4.1 Initial Setting

(1) Start ISPSOft and double-click **HWCONFIG**.

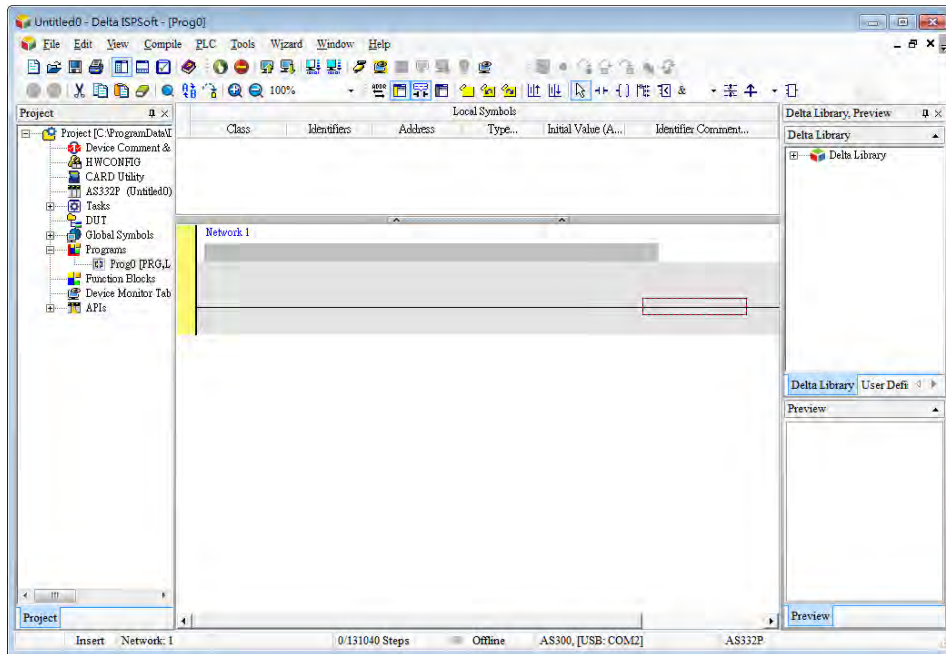

(2) Select a module and drag it to the working area.

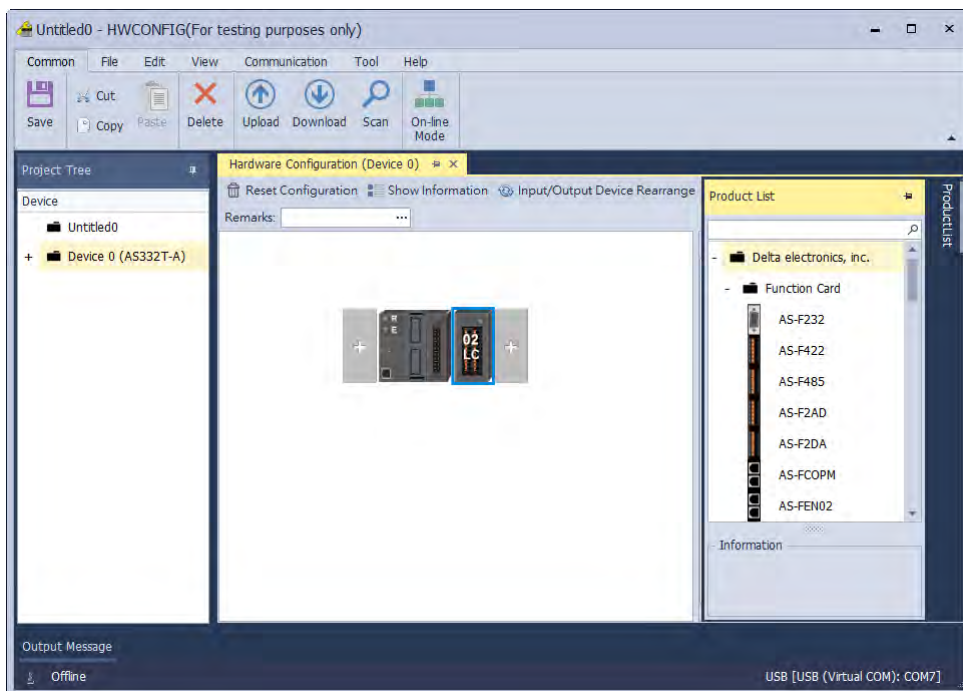

(3) Right-click on the module and then click LC Wizard to go to the setting page.

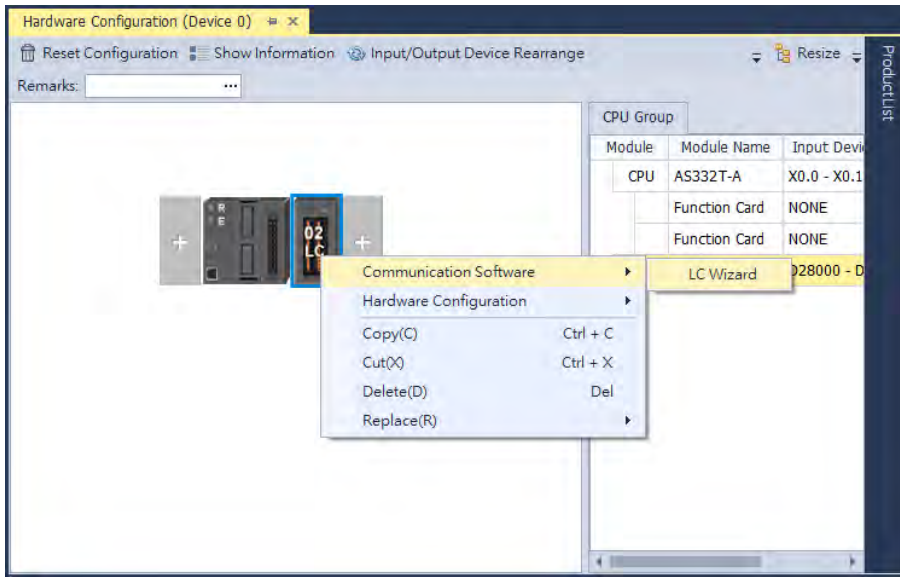

(4) Set the setting values.

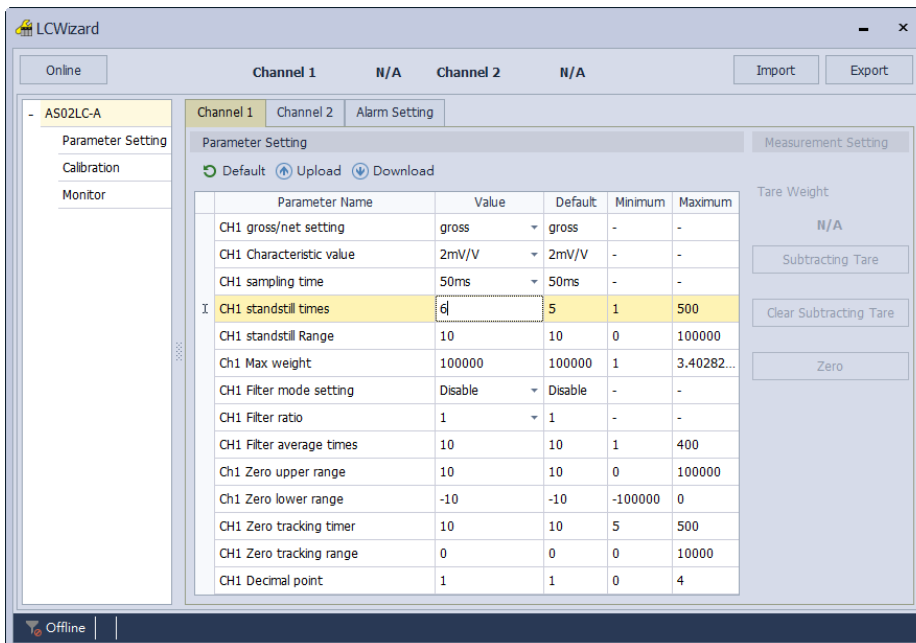

(5) Click **Download** on the toolbar to download the parameters in HWCONFIG. Note that you cannot download the parameters while the CPU module is running.)

The screenshot shows the 'AS02LC-A' software interface. The 'Parameter Setting' window is active, displaying a table of parameters for Channel 1. The table has columns for Parameter Name, Value, Default, Minimum, and Maximum. The 'CH1 gross/net setting' is highlighted in yellow. To the right of the table, there are buttons for 'Subtracting Tare', 'Clear Subtracting Tare', and 'Zero'. The 'Tare Weight' is shown as 'N/A'.

Parameter Name	Value	Default	Minimum	Maximum
CH1 gross/net setting	gross	gross	-	-
CH1 Characteristic value	2mV/V	2mV/V	-	-
CH1 sampling time	50ms	50ms	-	-
CH1 standstill times	6	5	1	500
CH1 standstill Range	10	10	0	100000
Ch1 Max weight	100000	100000	1	3.40282...
CH1 Filter mode setting	Disable	Disable	-	-
CH1 Filter ratio	1	1	-	-
CH1 Filter average times	10	10	1	400
Ch1 Zero upper range	10	10	0	100000
Ch1 Zero lower range	-10	-10	-100000	0
CH1 Zero tracking timer	10	10	5	500
CH1 Zero tracking range	0	0	0	10000
CH1 Decimal point	1	1	0	4

8.4.2 Checking the Version of a Module

- (1) Click **On-line Mode**.

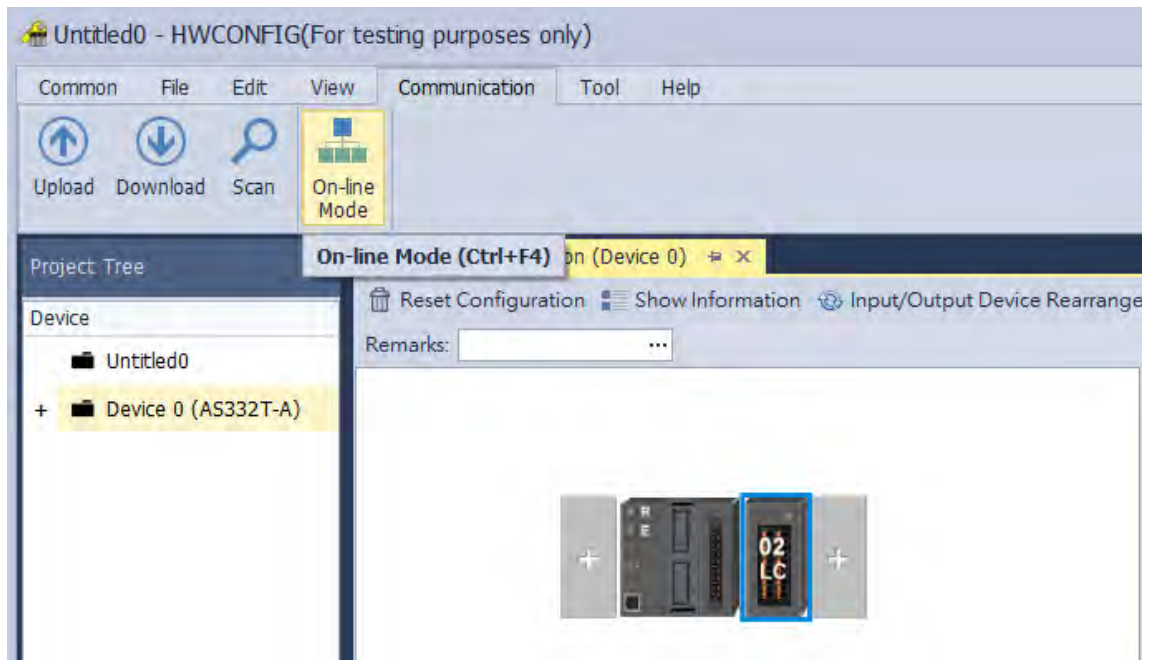

- (2) Double-click the module to open the Device Setting page. The versions of both the firmware and the hardware are displayed.

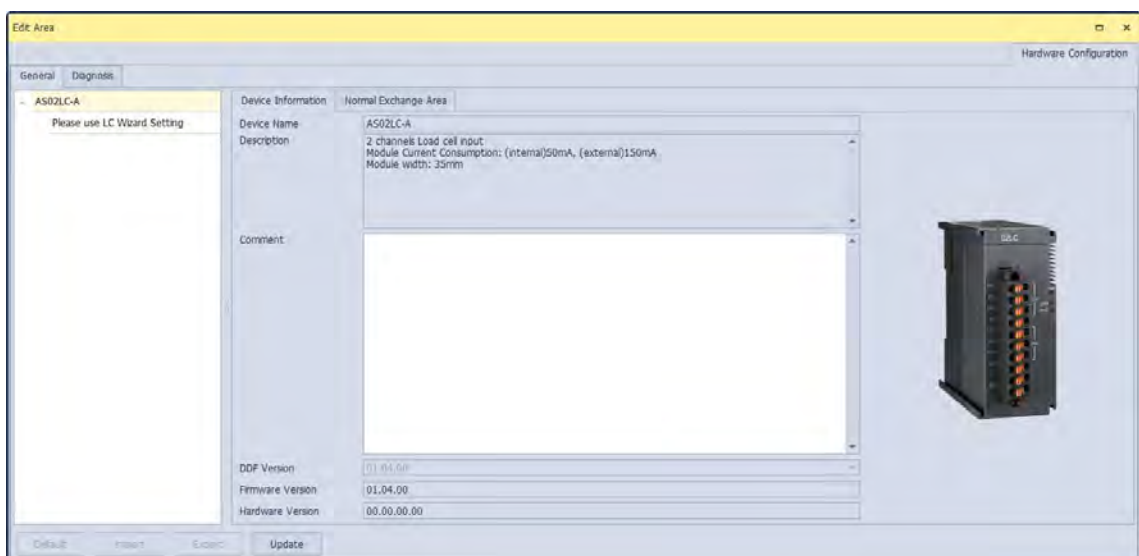

8.4.3 Online Mode

(1) In the **On-line Mode**.

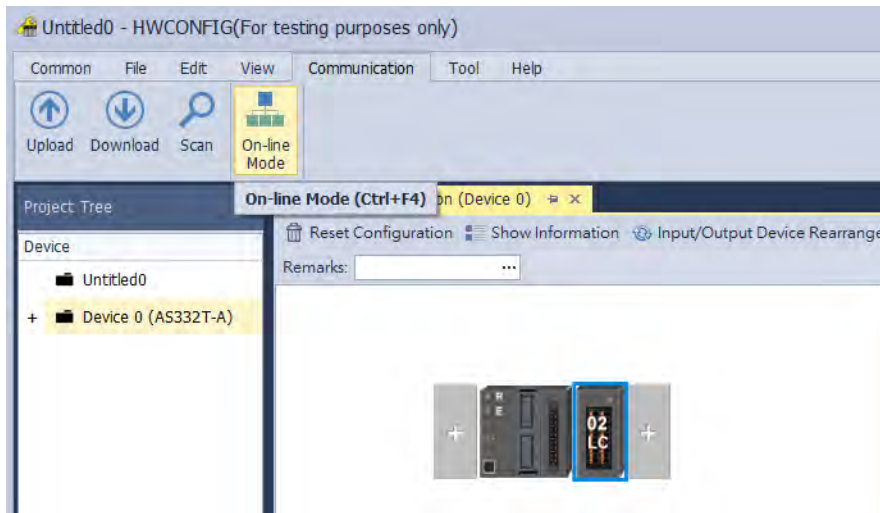

(2) Right-click the module and click **Module Status**.

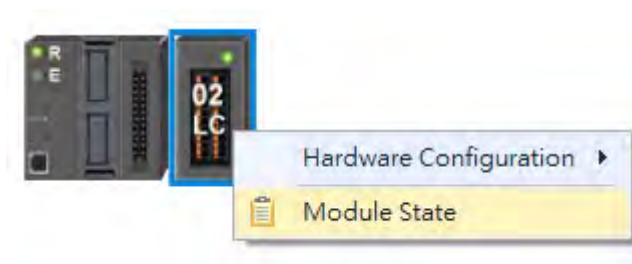

(3) View the module state.

Channel	Value (Decimal)	Value (Float)
Error code	0	0.000
CH1 Input	1120534528	101.000
CH2 Input	0	0.000
Status Code	16392	0.000
Command	0	0.000

8.4.4 Importing/Exporting a Parameter File

- (1) Click **Export** in the Device Settings dialog box to save the current parameters as a dep file (.dep).

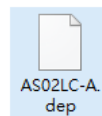
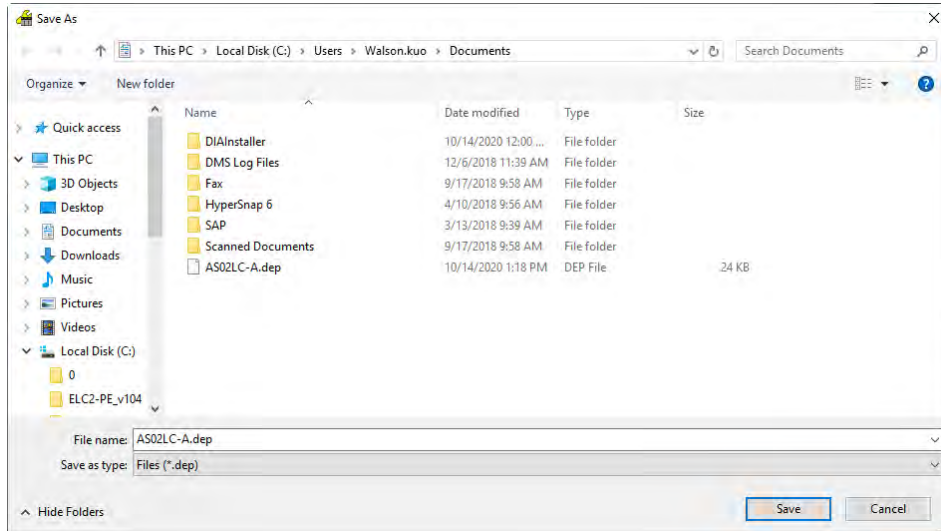

- (2) Click **Import** in the Device Settings dialog box and select a dep file to import saved parameters.

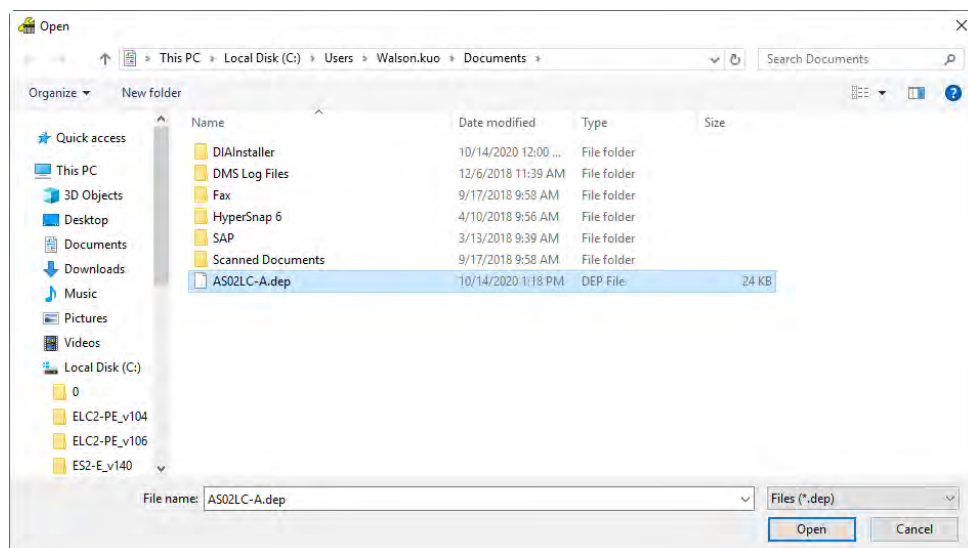
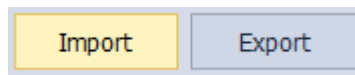

8.4.5 Parameters

(1) Settings for CH1

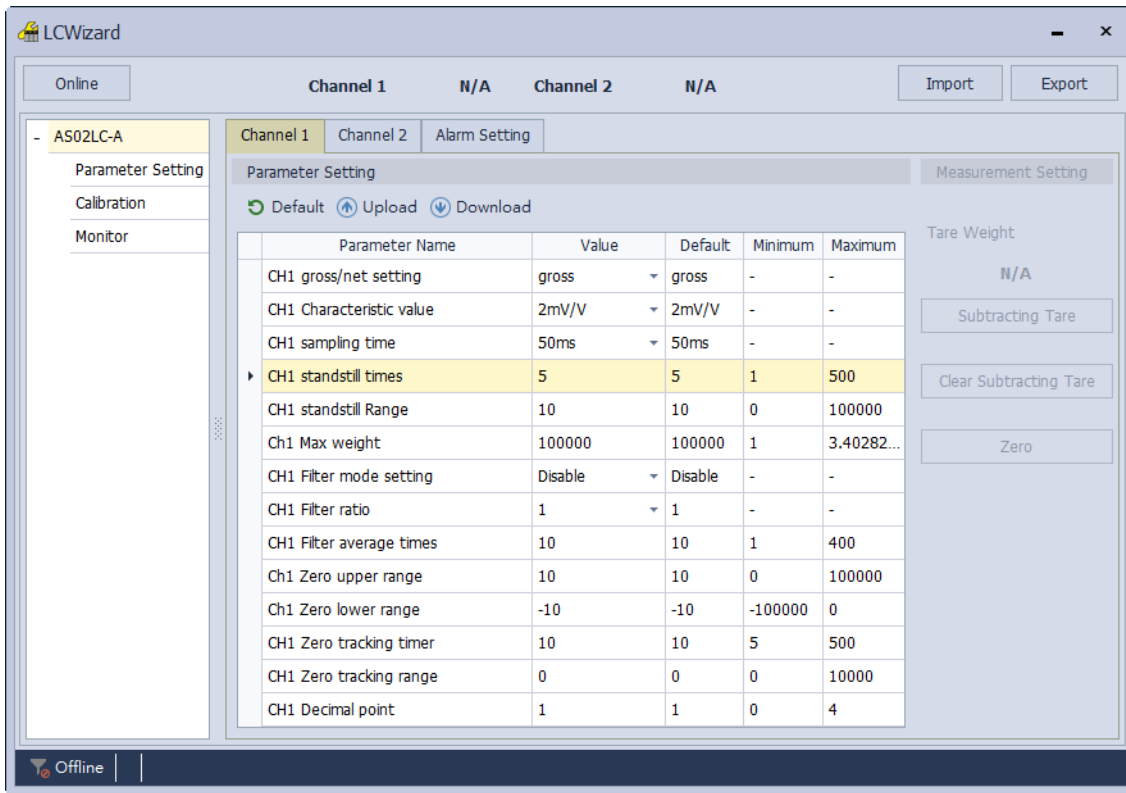

(2) Adjustment for CH1

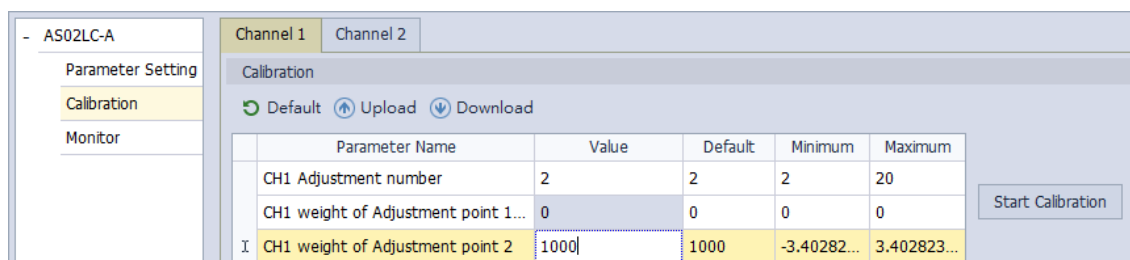

(3) Settings for CH2

LCWizard

Channel 1 N/A Channel 2 N/A

AS02LC-A

Parameter Setting

Calibration

Monitor

Channel 1 Channel 2 Alarm Setting

Parameter Setting

Measurement Setting

Default Upload Download

Parameter Name	Value	Default	Minimum	Maximum
CH2 gross/net setting	Disable	gross	-	-
CH2 Characteristic value	2mV/V	2mV/V	-	-
CH2 sampling time	50ms	50ms	-	-
CH2 standstill times	5	5	1	500
CH2 standstill Range	10	10	0	100000
Ch2 Max weight	100000	100000	1	3.40282...
CH2 Filter mode setting	Disable	Disable	-	-
CH2 Filter ratio	1	1	-	-
CH2 Filter average times	10	10	1	400
Ch2 Zero upper range	10	10	0	100000
Ch2 Zero lower range	-10	-10	-100000	0
CH2 Zero tracking timer	10	10	5	500
CH2 Zero tracking range	0	0	0	10000
CH2 Decimal point	1	1	0	4

Tare Weight

N/A

Subtracting Tare

Clear Subtracting Tare

Zero

(4) Adjustment for CH2

AS02LC-A

Parameter Setting

Calibration

Monitor

Channel 1 Channel 2

Calibration

Default Upload Download

Parameter Name	Value	Default	Minimum	Maximum
CH1 Adjustment number	2	2	2	20
CH1 weight of Adjustment point 1...	0	0	0	0
CH1 weight of Adjustment point 2	100	1000	-3.40282...	3.402823...

Start Calibration

(5) Alarm settings

- AS02LC-A

Channel 1 Channel 2 Alarm Setting

Default Upload Download



Parameter Name	Value	Default	Minimum	Maximum
External power supply error	<input checked="" type="checkbox"/>	<input checked="" type="checkbox"/>	-	-
Hardware error	<input type="checkbox"/>	<input type="checkbox"/>	-	-
Driver board error	<input type="checkbox"/>	<input type="checkbox"/>	-	-

Parameter Setting
Calibration
Monitor

8.5 Basic Operation on DIADesigner-AX

DIADesigner-AX is an open platform for PLC development system and industrial automation. The adaptable DIADesigner-AX provides an easy way to create professional engineering of IEC 61131-3 automation projects. Based on the IEC 61131-3 data structure and the high-level language programming, DIADesigner-AX is strong in functionality, easy to develop, reliable, extendable and open for development. Integrated with components such as visualization and Safety solution, DIADesigner-AX offers a variety of user-friendly engineering functions for your professional applications in controller development system sectors including PLC and motion control. In DIADesigner-AX, you can customize the user interface by arranging the window layout and the appearance of menus, toolbars and commands according to your requirements.

8.5.1 Creating a New Project

Double-click the DIADesigner-AX icon  to open DIADesigner-AX. Click **New Project**  on the Start Page or select *File > New Project (Ctrl+N)* to create a new project.

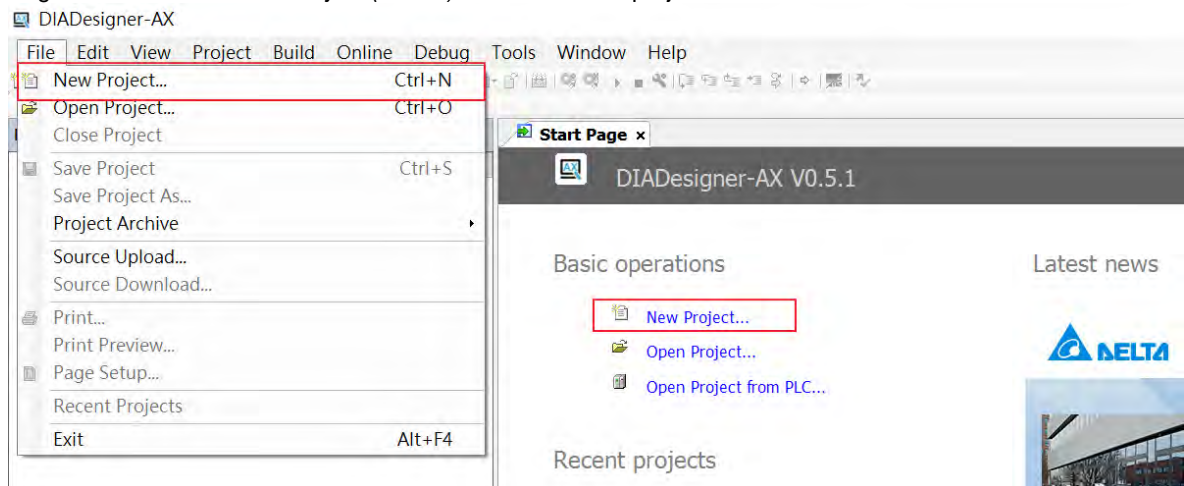

Next you will see a window with two sections, Categories and Templates. Click **Projects** in the Categories section and click **Standard project** in the Templates section. After that create a Name and specify a location for the project and then click **OK**.

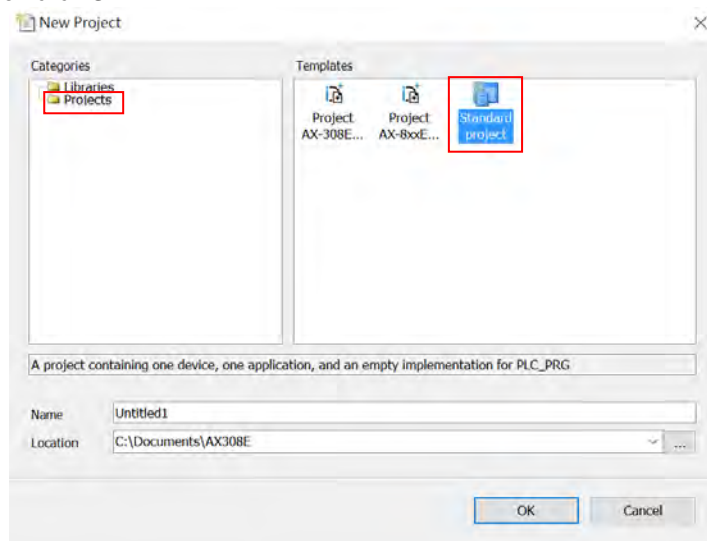

And a Standard Project dialog appears. You can select the device and the programming language from the drop-down list. Click **OK**, the system generates a cyclic task with a default PLC_PRG.

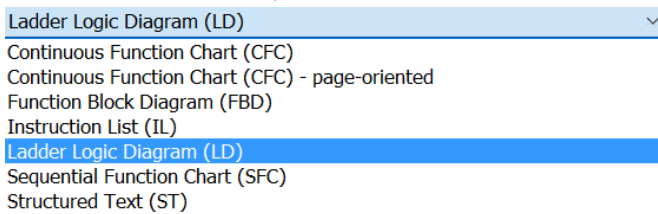
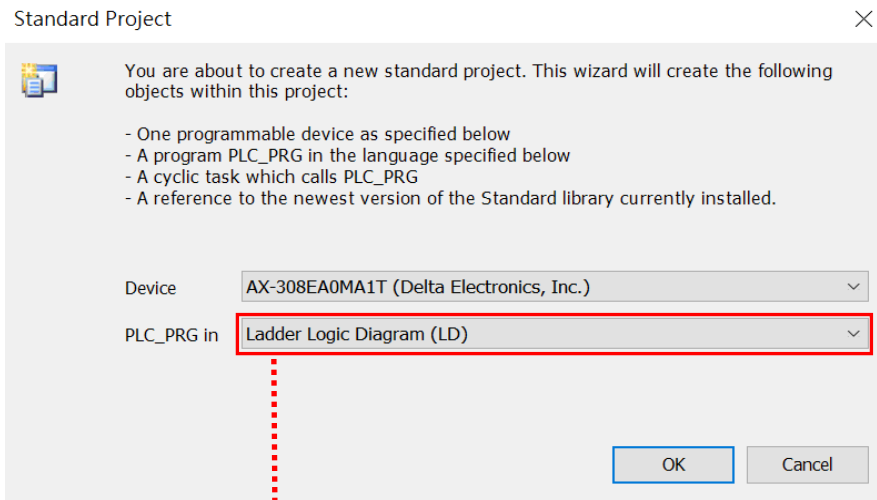

After a new project is successfully created, you can see a project management area in the left side of the window. All the options are listed in nodes. *Click View -> Devices (Alt+0)* on the tool bar, if nothing appears in the project management area.

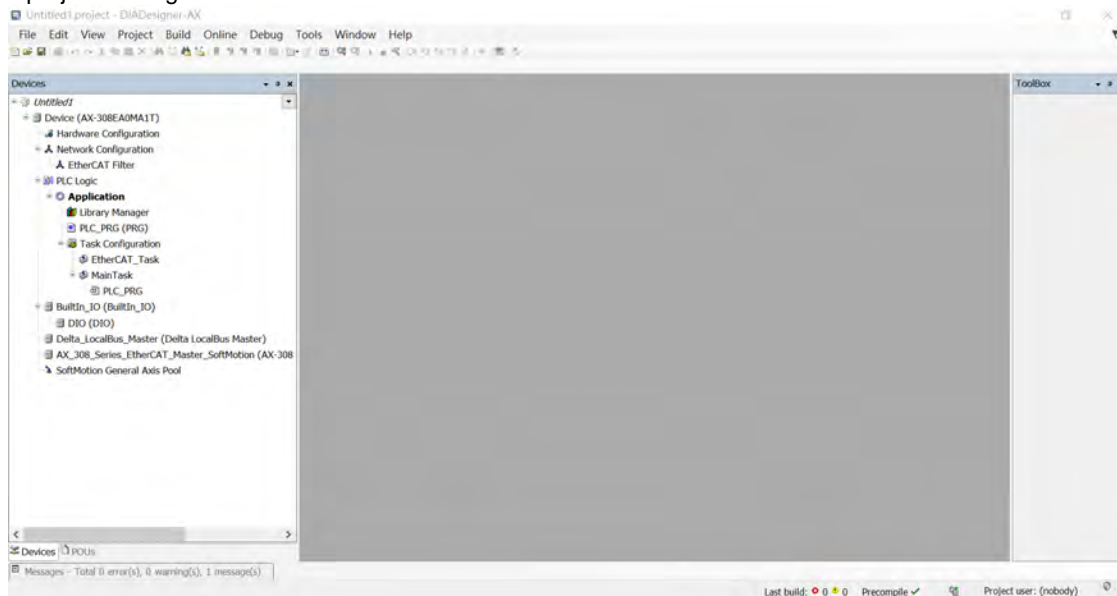

8.5.2 Adding a Module

- **Method 1**

With AX-3 Series PLC backplaneless design, the extension module can install on the right-side of AX-3 Series PLC directly. Double-click or drag and drop the extension module that you'd like to add from the Product List. Newly added extension modules will appear on the right-side of the AX-3 Series PLC. And the device names will also show up on the left-side under Delta_LocalBus_Master.

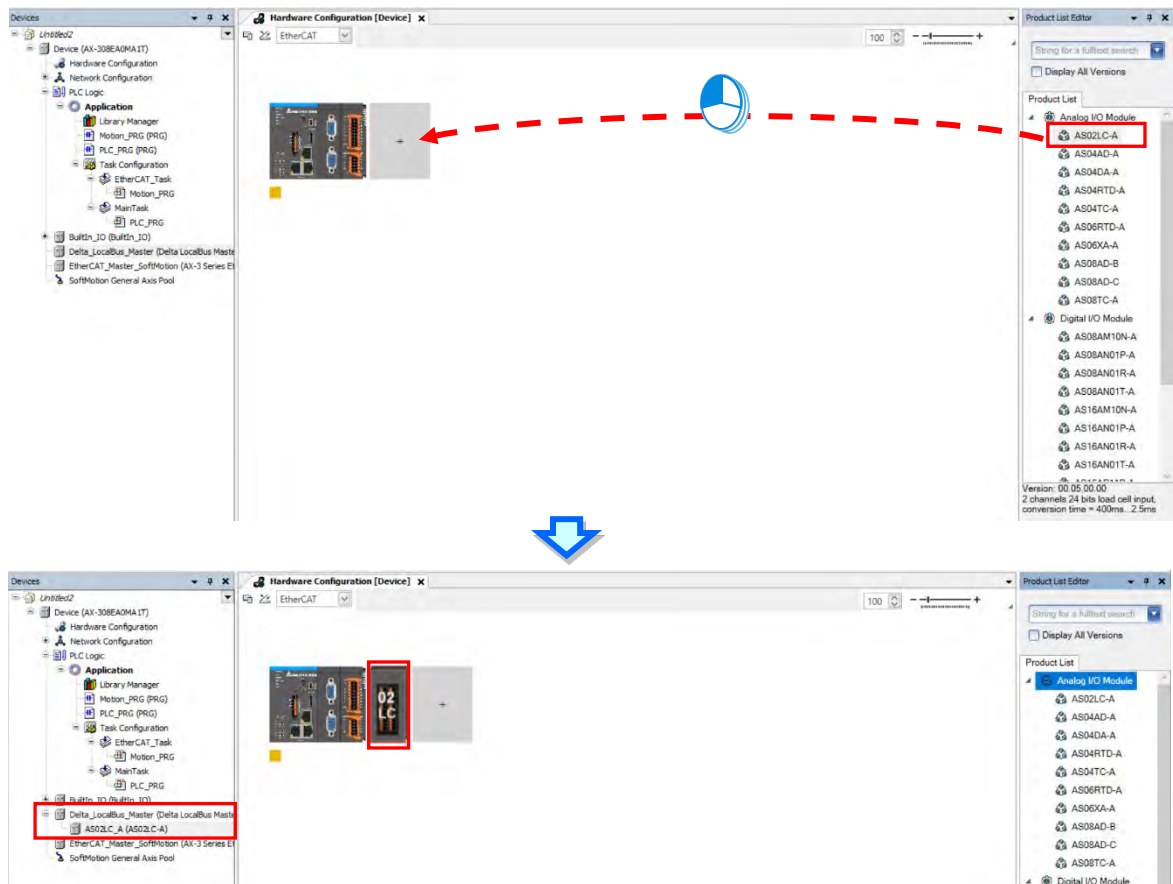

- **Method 2**

If the AX-3 Series PLC and its connected extension module are powered on and the gateway is correctly set,

you can use the icon  to scan and add the modules in. Newly added extension modules will appear on the right-side of the AX-3 Series PLC. And the device names will also show up on the left-side under Delta_LocalBus_Master.

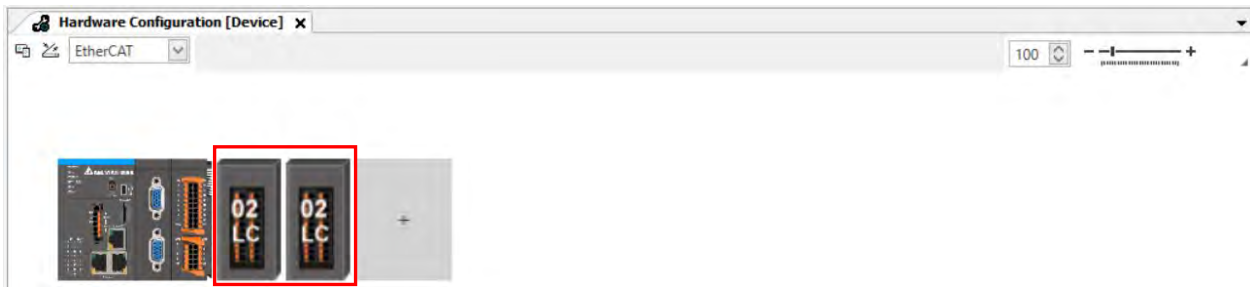
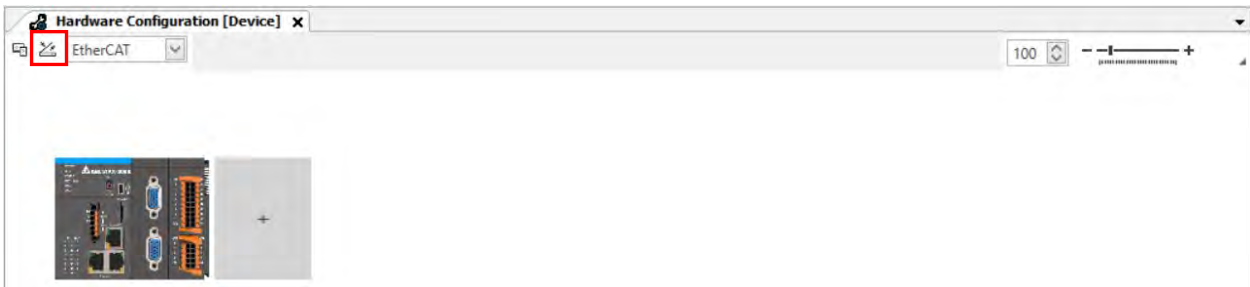

8.5.3 Parameters - Configuring the Module

Two methods to open the parameter setting page.

- **Method 1**

Find and double-click **Hardware Configuration** in the tree view to open the Hardware Configuration.

Double-click the image of the module you'd like to configure to open the parameter setting page.

- **Method 2**

Find and double-click the module you'd like to configure under Delta_LocalBus_Master (Delta LocalBus Master) in the tree view to open the parameter setting page.

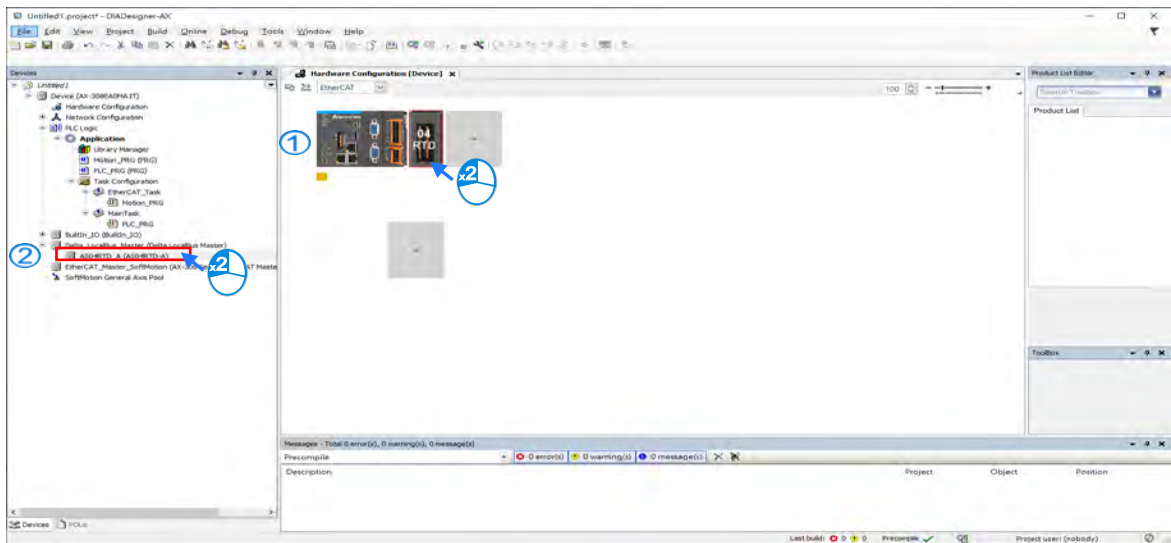

Check and set the configurations on the parameter setting page.

AS02LC-A Parameters	Parameter	Type	Value	Default Value	Unit	Description
AS02LC-A I/O Mapping	CH1 Gross/Net Setting	Enumeration of WORD	Gross weight	Gross weight		
Status	CH1 Characteristic Value	Enumeration of WORD	2mV/V	2mV/V		
Information	CH1 Sampling Time	Enumeration of WORD	50ms	50ms		
	CH1 Standstill Times	INT(1..500)	5	5		
	CH1 Standstill Range	REAL(0..100000)	10	10		
	CH1 Max Weight	REAL(1..3.4028235E38)	100000	100000		
	CH1 Filter Mode	Enumeration of WORD	Disabled	Disabled		
	CH1 Filter Ratio	INT(0..8)	1	1		
	CH1 Filter Average Times	INT(1..400)	10	10		
	CH1 Zero Upper Range	REAL(0..100000)	10	10		
	CH1 Zero Lower Range	REAL(-100000..0)	-10	-10		
	CH1 Zero Tracking Time	INT(5..500)	10	10		
	CH1 Zero Tracking Range	REAL(0..100000)	0	0		
	CH1 Calibration Point Number	INT(2..20)	2	2		
	CH1 Weight of Calibration Point					
	CH1 Weight of Calibration Point 1	REAL(0..0)	0	0		
	CH1 Weight of Calibration Point 2	REAL(3.4028235E-38..3.4028235E38)	1000	1000		
	CH1 Weight of Calibration Point 3	REAL(3.4028235E-38..3.4028235E38)	2000	2000		
	CH1 Weight of Calibration Point 4	REAL(3.4028235E-38..3.4028235E38)	3000	3000		
	CH1 Weight of Calibration Point 5	REAL(3.4028235E-38..3.4028235E38)	4000	4000		
	CH1 Weight of Calibration Point 6	REAL(3.4028235E-38..3.4028235E38)	5000	5000		
	CH1 Weight of Calibration Point 7	REAL(3.4028235E-38..3.4028235E38)	6000	6000		
	CH1 Weight of Calibration Point 8	REAL(3.4028235E-38..3.4028235E38)	7000	7000		
	CH1 Weight of Calibration Point 9	REAL(3.4028235E-38..3.4028235E38)	8000	8000		
	CH1 Weight of Calibration Point 10	REAL(3.4028235E-38..3.4028235E38)	9000	9000		
	CH1 Weight of Calibration Point 11	REAL(3.4028235E-38..3.4028235E38)	10000	10000		
	CH1 Weight of Calibration Point 12	REAL(3.4028235E-38..3.4028235E38)	11000	11000		
	CH1 Weight of Calibration Point 13	REAL(3.4028235E-38..3.4028235E38)	12000	12000		
	CH1 Weight of Calibration Point 14	REAL(3.4028235E-38..3.4028235E38)	13000	13000		
	CH1 Weight of Calibration Point 15	REAL(3.4028235E-38..3.4028235E38)	14000	14000		
	CH1 Weight of Calibration Point 16	REAL(3.4028235E-38..3.4028235E38)	15000	15000		
	CH1 Weight of Calibration Point 17	REAL(3.4028235E-38..3.4028235E38)	16000	16000		
	CH1 Weight of Calibration Point 18	REAL(3.4028235E-38..3.4028235E38)	17000	17000		
	CH1 Weight of Calibration Point 19	REAL(3.4028235E-38..3.4028235E38)	18000	18000		

8.5.3.1 Channel 1 and Channel 2 Settings

You can set up Gross/Net setting, Characteristic Value, Sampling Time, Standstill Times, Standstill Range, Max Weight, Filter Mode, Filter Ratio, Filter Average Times, Zero Upper Range, Zero Lower Range, Zero Tracking Time and Zero Tracking Range for channel 1 and channel 2.

Channel 1:

Parameter	Type	Value	Default V...	Unit	Description
CH1 Gross/Net Setting	Enumeration of WORD	Gross weight	Gross weight		
CH1 Characteristic Value	Enumeration of WORD	2mV/V	2mV/V		
CH1 Sampling Time	Enumeration of WORD	50ms	50ms		
CH1 Standstill Times	INT(1..500)	5	5		
CH1 Standstill Range	REAL(0..100000)	10	10		
CH1 Max Weight	REAL(1..3.4028235E38)	100000	100000		
CH1 Filter Mode	Enumeration of WORD	Disabled	Disabled		
CH1 Filter Ratio	INT(0..8)	1	1		
CH1 Filter Average Times	INT(1..400)	10	10		
CH1 Zero Upper Range	REAL(0..100000)	10	10		
CH1 Zero Lower Range	REAL(-100000..0)	-10	-10		
CH1 Zero Tracking Time	INT(5..500)	10	10		
CH1 Zero Tracking Range	REAL(0..100000)	0	0		

Channel 2:

Parameter	Type	Value	Default V...	Unit	Description
CH2 Gross/Net Setting	Enumeration of WORD	Gross weight	Gross weight		
CH2 Characteristic Value	Enumeration of WORD	2mV/V	2mV/V		
CH2 Sampling Time	Enumeration of WORD	50ms	50ms		
CH2 Standstill Times	INT(1..500)	5	5		
CH2 Standstill Range	REAL(0..100000)	10	10		
CH2 Max Weight	REAL(1..3.4028235E38)	100000	100000		
CH2 Filter Mode	Enumeration of WORD	Disabled	Disabled		
CH2 Filter Ratio	INT(0..8)	1	1		
CH2 Filter Average Times	INT(1..400)	10	10		
CH2 Zero Upper Range	REAL(0..100000)	10	10		
CH2 Zero Lower Range	REAL(-100000..0)	-10	-10		
CH2 Zero Tracking Time	INT(5..500)	10	10		
CH2 Zero Tracking Range	REAL(0..100000)	0	0		

8.5.3.2 Channel Calibration Settings

You can set up Weight of Calibration Points for channel 1 and channel 2.

Channel 1:

Parameter	Type	Value	Default V...	Unit	Description
CH1 Calibration Point Number	INT(2..20)	2	2		
CH1 Weight of Calibration Point					
CH1 Weight of Calibration Point 1	REAL(0..0)	0	0		
CH1 Weight of Calibration Point 2	REAL(3.4028235E-38..3.4028235E38)	1000	1000		
CH1 Weight of Calibration Point 3	REAL(3.4028235E-38..3.4028235E38)	2000	2000		
CH1 Weight of Calibration Point 4	REAL(3.4028235E-38..3.4028235E38)	3000	3000		
CH1 Weight of Calibration Point 5	REAL(3.4028235E-38..3.4028235E38)	4000	4000		
CH1 Weight of Calibration Point 6	REAL(3.4028235E-38..3.4028235E38)	5000	5000		
CH1 Weight of Calibration Point 7	REAL(3.4028235E-38..3.4028235E38)	6000	6000		
CH1 Weight of Calibration Point 8	REAL(3.4028235E-38..3.4028235E38)	7000	7000		
CH1 Weight of Calibration Point 9	REAL(3.4028235E-38..3.4028235E38)	8000	8000		
CH1 Weight of Calibration Point 10	REAL(3.4028235E-38..3.4028235E38)	9000	9000		
CH1 Weight of Calibration Point 11	REAL(3.4028235E-38..3.4028235E38)	10000	10000		
CH1 Weight of Calibration Point 12	REAL(3.4028235E-38..3.4028235E38)	11000	11000		
CH1 Weight of Calibration Point 13	REAL(3.4028235E-38..3.4028235E38)	12000	12000		
CH1 Weight of Calibration Point 14	REAL(3.4028235E-38..3.4028235E38)	13000	13000		
CH1 Weight of Calibration Point 15	REAL(3.4028235E-38..3.4028235E38)	14000	14000		
CH1 Weight of Calibration Point 16	REAL(3.4028235E-38..3.4028235E38)	15000	15000		
CH1 Weight of Calibration Point 17	REAL(3.4028235E-38..3.4028235E38)	16000	16000		
CH1 Weight of Calibration Point 18	REAL(3.4028235E-38..3.4028235E38)	17000	17000		
CH1 Weight of Calibration Point 19	REAL(3.4028235E-38..3.4028235E38)	18000	18000		
CH1 Weight of Calibration Point 20	REAL(3.4028235E-38..3.4028235E38)	19000	19000		

Channel 2:

Parameter	Type	Value	Default V...	Unit	Description
CH2 Calibration Point Number	INT(2..20)	2	2		
CH2 Weight of Calibration Point					
CH2 Weight of Calibration Point 1	REAL(0..0)	0	0		
CH2 Weight of Calibration Point 2	REAL(3.4028235E-38..3.4028235E38)	1000	1000		
CH2 Weight of Calibration Point 3	REAL(3.4028235E-38..3.4028235E38)	2000	2000		
CH2 Weight of Calibration Point 4	REAL(3.4028235E-38..3.4028235E38)	3000	3000		
CH2 Weight of Calibration Point 5	REAL(3.4028235E-38..3.4028235E38)	4000	4000		
CH2 Weight of Calibration Point 6	REAL(3.4028235E-38..3.4028235E38)	5000	5000		
CH2 Weight of Calibration Point 7	REAL(3.4028235E-38..3.4028235E38)	6000	6000		
CH2 Weight of Calibration Point 8	REAL(3.4028235E-38..3.4028235E38)	7000	7000		
CH2 Weight of Calibration Point 9	REAL(3.4028235E-38..3.4028235E38)	8000	8000		
CH2 Weight of Calibration Point 10	REAL(3.4028235E-38..3.4028235E38)	9000	9000		
CH2 Weight of Calibration Point 11	REAL(3.4028235E-38..3.4028235E38)	10000	10000		
CH2 Weight of Calibration Point 12	REAL(3.4028235E-38..3.4028235E38)	11000	11000		
CH2 Weight of Calibration Point 13	REAL(3.4028235E-38..3.4028235E38)	12000	12000		
CH2 Weight of Calibration Point 14	REAL(3.4028235E-38..3.4028235E38)	13000	13000		
CH2 Weight of Calibration Point 15	REAL(3.4028235E-38..3.4028235E38)	14000	14000		
CH2 Weight of Calibration Point 16	REAL(3.4028235E-38..3.4028235E38)	15000	15000		
CH2 Weight of Calibration Point 17	REAL(3.4028235E-38..3.4028235E38)	16000	16000		
CH2 Weight of Calibration Point 18	REAL(3.4028235E-38..3.4028235E38)	17000	17000		
CH2 Weight of Calibration Point 19	REAL(3.4028235E-38..3.4028235E38)	18000	18000		
CH2 Weight of Calibration Point 20	REAL(3.4028235E-38..3.4028235E38)	19000	19000		

8.5.3.3 Alarm Settings

You can set up alarm settings for External Power Supply Error, Hardware Error and Driver Board Error.

Alarm Setting	WORD	1		
External Power Supply Error	BOOL	TRUE	TRUE	
Hardware Error	BOOL	FALSE	FALSE	
Driver Board Error	BOOL	FALSE	FALSE	

8.5.3.4 Online Mode

After the configuration is complete, click the **Login** button on the toolbar to go to the Online Mode and also download the parameter to the PLC module. You can read the parameter status and the Module Revision under the Parameter Tab when the system is in the Online Mode, but editing is NOT accessible in the Online Mode.

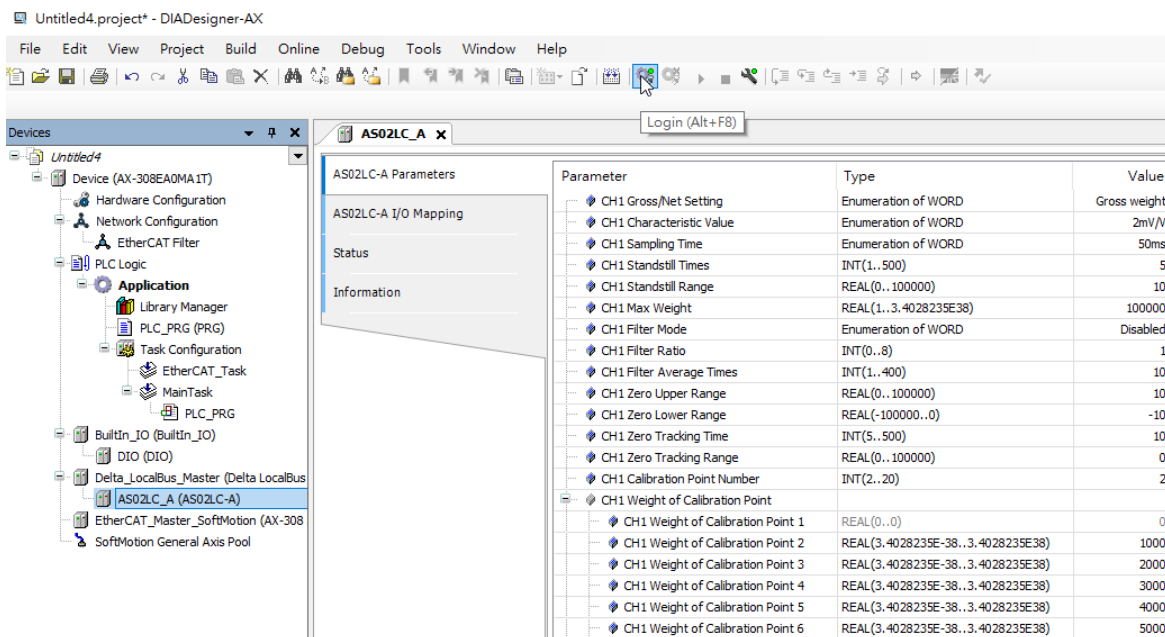

8.5.4 I/O Mapping

You can read/write values, status, error codes of each channel under the I/O Mapping Tab.

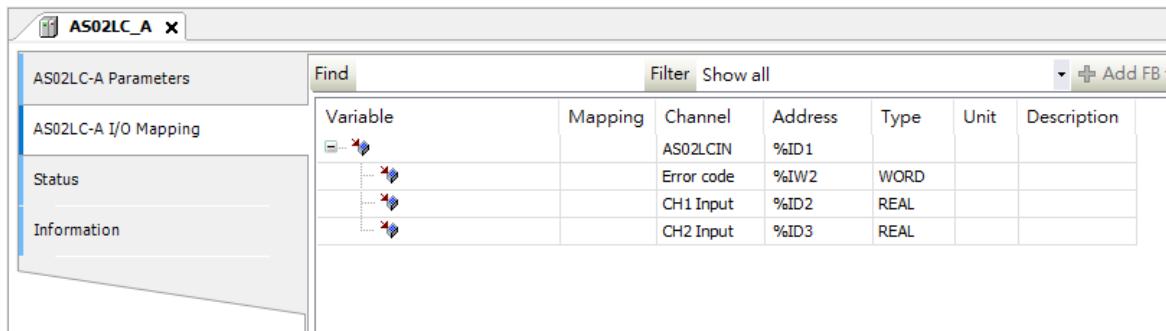

8.5.5 Status

You can monitor the status and error message of the module under the Status Tab.



8.5.6 Information

You can check the module information, including Name, Vendor, Categories, Type, ID, Version, Order Number and Description under the Information Tab.

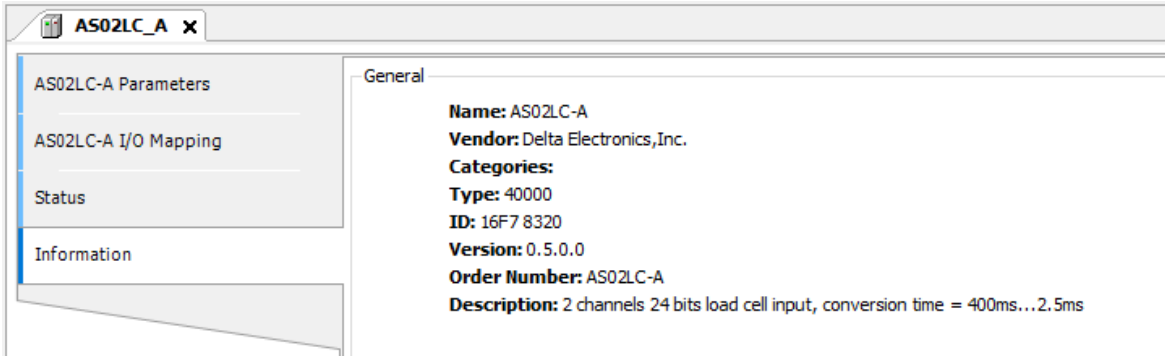

8.6 Troubleshooting

8.6.1 Error Codes

Error Code	Description	A↔ D LED indicator	ERROR LED indicator
16#1605	Hardware failure	OFF	ON
16#1607	The external voltage is abnormal.	OFF	ON
16#1801	The external voltage is abnormal.	OFF	Blinking
16#1802	Hardware failure	OFF	Blinking
16#1807	Diver board failure	OFF	Blinking
16#1808	The signal received by channel 1 exceeds the range of analog inputs or the SEN voltage is abnormal.	Run: blinking Stop: OFF	Blinking
16#1809	The signal received by channel 1 exceeds the weight limit.		
16#180A	The factory calibration in channel 1 is incorrect.		
16#180B	The signal received by channel 2 exceeds the range of analog inputs or the SEN voltage is abnormal.		
16#180C	The signal received by channel 2 exceeds the weight limit.		
16#180D	The factory calibration in channel 2 is incorrect.		
-	Upon power-on, the module does NOT receive any detecting request from the PLC CPU.	OFF	Blinking once or twice and after 2 seconds, it blinks repeatedly

8.6.2 Troubleshooting Procedure

Description	Procedure
The external voltage is abnormal.	Check the power supply.
Hardware failure	If the problem persists, contact the local authorized distributors.
Diver board failure	Check if the terminals is affected by any interference or is short-circuit (check EXC+ and EXC-). If the problem persists, contact the local authorized distributors.
The signal received by channel 1 exceeds the range of analog inputs or the SEN voltage is abnormal.	Check the signal received by channel 1 and the cable connections.
The signal received by channel 1 exceeds the weight limit.	Check the value input to channel 1 and the maximum weight setting.
The factory calibration in channel 1 is incorrect.	Check the weight calibration in channel 1.
The signal received by channel 2 exceeds the range of analog inputs or the SEN voltage is abnormal.	Check the signal received by channel 2 and the cable connections.
The signal received by channel 2 exceeds the weight limit.	Check the value input to channel 2 and the maximum weight setting.
The factory calibration in channel 2 is incorrect.	Check the weight calibration in channel 1.
Upon power-on, the module does NOT receive any detecting request from the PLC CPU.	Check the connection between the CPU and the module or reconnect them again.

MEMO

Chapter 9 Serial Communication Module AS00SCM

Table of Contents

9.1	Introduction	9-2
9.2	Specification, Function and Wiring	9-4
9.2.1	The functional specifications	9-4
9.2.2	Dimensions and Profile	9-5
9.2.3	Knob Functions	9-6
9.2.4	Wiring	9-9
9.3	COM mode	9-11
9.3.1	Modbus	9-11
9.3.2	UD Link	9-16
9.3.3	CANopen Mode	9-24
9.4	RTU Mode	9-26
9.4.1	CANopen Mode (AS-FCOPM)	9-26
9.4.2	EtherNet/IP Mode	9-32
9.4.3	Remote Module Setting	9-45
9.5	Normal Exchange Area	9-47
9.6	Application	9-49
9.6.1	Modbus	9-49
9.6.2	UD Link	9-58
9.6.3	Remote IO Application (AS-FCOPM)	9-73
9.6.4	Remote IO Application (AS-FEN02) Through EIP Builder	9-80
9.6.5	Remote IO Application (Multiple AS-FEN02)	9-82
9.7	Error Codes.....	9-83
9.7.1	Troubleshooting for Module AS00SCM-A as a Communication Module	9-84
9.7.2	Troubleshooting for Module AS00SCM-A as a Remote Module	9-85

9.1 Introduction

Thank you for using the AS00SCM-A, a serial communication module. To ensure that your AS00SCM-A is installed and operated correctly, read this manual carefully before using the module.

The AS00SCM-A is a serial communication module, supporting AS series communication extension modules (COM) as well as the remote modules (RTU) and the followings:

- COM mode (AS series communication extension modules installed on the right side of the AS CPU and no external power supply)
 - Serial communication cards: AS-F232, AS-F422, and AS-F485 support Modbus and UD Link (user-defined format).
 - AS00SCM-A with serial communication card installed can be used only in COM mode.
 - AS00SCM-A with CANopen communication card (AS-FCOPM) installed can be used in COM mode.

- RTU mode (remote modules, independent power supply)
 - CANopen communication card (AS-FCOPM) supports AS remote mode and CANopen DS301 (Slave).
 - AS00SCM-A with CANopen communication card (AS-FCOPM) installed can be used in RTU mode (without connecting to AS CPU).
 - Ethernet communication card (AS-FEN02) supports EtherNet/IP Adapter.
 - AS00SCM-A with Ethernet communication card (AS-FEN02) installed can be used only in RTU mode.
 - PROFINET communication card (AS-FPFN02) supports PROFINET devices.
 - AS00SCM-A with PROFINET communication card (AS-FPFN02) installed can be used only in RTU mode. Refer to Chapter 10 of AS Module Manual for more information.

AS00SCM Version and its supporting functions	COM Mode		RTU Mode			
	MODBUS UD Link	CANopen DS301 (Slave)	AS Remote Communication, Delta Special Driver & AS Remote Mode	CANopen DS301 (Slave)	EtherNet/IP Adapter	PROFINET Device
Card	AS-F232 AS-F485 AS-F422	AS-FCOPM	AS-FCOPM		AF-FEN02 (V1.02 or later)	AS-FPFN02 (V2.00 or later)
Card Slot	Card 1 / Card 2	Card 2	Card 2		Card 1 and Card 2	
V1.00	V	-	-	-	-	-
V2.00	V	V	V	-	-	-
V2.02	V	V	V	V	V	-
V2.06	V	V	V	V	V	V

When AS00SCM-A is used as a remote module, its right side supports the followings AS Series IO modules.

When AS00SCM-A acts as a CANopen remote module, the followings are supported.	
Digital Module	AS08AM10N-A, AS16AM10N-A, AS32AM10N-A, AS64AM10N-A, AS08AN01P-A, AS08AN01R-A, AS08AN01T-A, AS16AN01P-A, AS16AN01R-A, AS16AN01T-A, AS32AN02T-A, AS64AN02T-A, AS16AP11P-A, AS16AP11R-A, AS16AP11T-A
Analog Module	AS04AD-A, AS08AD-B, AS08AD-C, AS02ADH-A, AS04RTD-A, AS06RTD-A, AS04TC-A, AS08TC-A, AS04DA-A, AS06XA-A, AS02LC-A
Network Module	AS04SIL-A (for AS00SCM-A FW V2.06 or later)

When AS00SCM-A acts as an EtherNet/IP remote module, the followings are supported.	
Digital Module	AS08AM10N-A, AS16AM10N-A, AS32AM10N-A, AS64AM10N-A, AS08AN01P-A, AS08AN01R-A, AS08AN01T-A, AS16AN01P-A, AS16AN01R-A, AS16AN01T-A, AS32AN02T-A, AS64AN02T-A, AS16AP11P-A, AS16AP11R-A, AS16AP11T-A
Analog Module	AS04AD-A, AS08AD-B, AS08AD-C, AS02ADH-A, AS04RTD-A, AS06RTD-A, AS04TC-A, AS08TC-A, AS04DA-A, AS06XA-A, AS02LC-A

When AS00SCM-A acts as a PROFINET remote module, the followings are supported.	
Digital Module	AS08AM10N-A, AS16AM10N-A, AS32AM10N-A, AS64AM10N-A, AS08AN01P-A, AS08AN01R-A, AS08AN01T-A, AS16AN01P-A, AS16AN01R-A, AS16AN01T-A, AS32AN02T-A, AS64AN02T-A, AS16AP11P-A, AS16AP11R-A, AS16AP11T-A
Analog Module	AS04AD-A, AS08AD-B, AS08AD-C, AS04RTD-A, AS06RTD-A, AS04TC-A, AS08TC-A, AS04DA-A, AS06XA-A

- When AS00SCM-A acts as a serial communication extension module or a CANopen remote module, it should work with AS PLC CPU for configuration. Download ISPSOft V3.13 or later versions from Delta's official website to configure AS00SCM-A. You can also use DIADesigner to configure AS00SCM-A. Download DIADesigner and refer to section 6.1.1.12 from DIADesigner software user manual for more information.
- If you use UD Link, configure it through SCMSOft, which is embedded in HWCONFIG of DCISoft. Download DCISoft V1.24 or later from Delta's official website. You can also use DIADesigner to call SCMSOft. Download DIADesigner and refer to section 6.1.1.12 from DIADesigner software user manual for more information.
- When AS00SCM-A acts as an Ethernet remote module, you can set up the EtherNet/IP via EIP Builder and HWCONFIG of ISPSOft. Download ISPSOft V3.13 or later versions and EIP Builder V1.08 or later from Delta's official website. You can also use DIADesigner. Download DIADesigner and refer to DIADesigner software user manual for more information.
- The following contents use ISPSOft to demonstrate. For DIADesigner examples, please refer to DIADesigner software user manual for more information.

9.2 Specification, Function and Wiring

9.2.1 The functional specifications

■ RS-485/RS-422 communication interface

Item	Specifications
Connector type	5- pin European-style terminal block, spring-clip connector
Transmission speed	300, 600, 1200, 2400, 4800, 9600, 19200, 38400, 57600, 76800 115200 and 230400 bps
Communication format	Stop bit: 1 bit and 2 bits Parity bit: none, an odd parity bit, and an even parity bit Data bit: 7 bits and 8 bits
Communication protocol	Modbus ASCII/RTU UD Link

■ CANopen communication interface

Item	Specifications
Connector type	RJ45*2
Transmission speed	10k, 20k, 50k, 125k, 250k, 500k, and 1000k bps
Communication protocol	AS remote mode (RTU mode) CANopen (firmware V2.00 or later)

■ Ethernet communication interface

Item	Specifications
Connector type	RJ45*2
Transmission speed	10M, 100Mbps
Communication protocol	EtherNet/IP (firmware V2.02 or later), PROFINET (firmware V2.06 or later)

■ Electrical specifications

Item	Specifications
Supply voltage	24 VDC
Electric energy consumption	0.6 W
Weight	Approximately 169 g

9.2.2 Dimensions and Profile

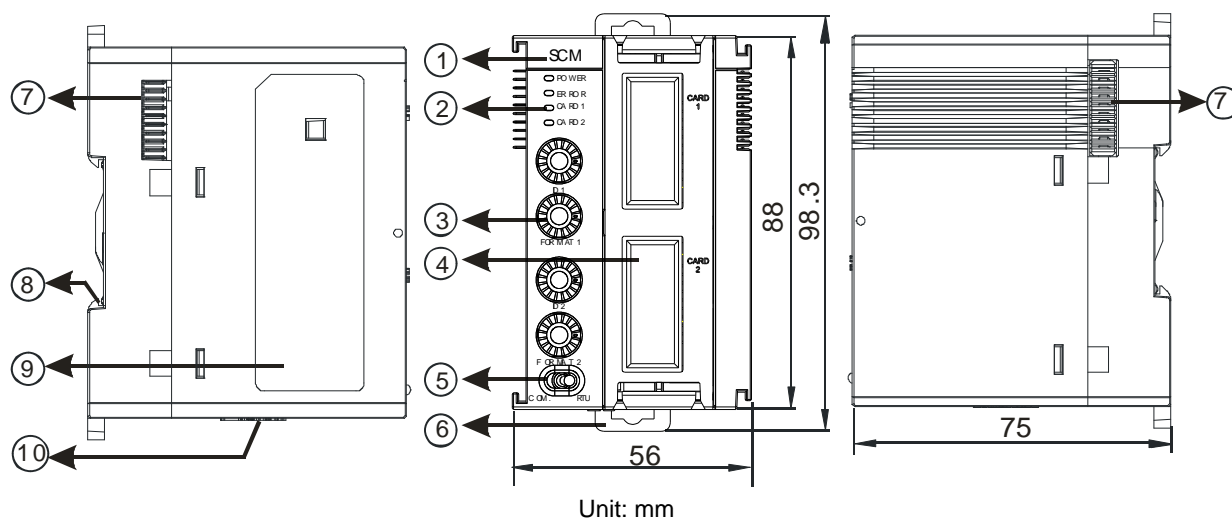

Number	Name	Description
1	Model Name	Model name of the module
2	RUN LED Indicator (blue)	Operating status of the module ON: the module is running. OFF: the module has low voltage or no power.
	ERROR LED Indicator (red)	Error status of the module ON: there is a hardware error. OFF: the module is operating normally. Blink: an error has occurred or occurs on the module; refer to section 9.7 for more information.
	Function card 1 Indicator (orange)	Blink: data is being transmitted to function card 1. OFF: there is no data transmission to function card 1.
	Function card 2 Indicator (orange)	Blink: data is being transmitted to function card 2. OFF: there is no data transmission to function card 2.
3	Knob for the Node ID and Format	2 sets, one for function card 1 and the other for function card 2
4	Function Card 1 Slot	COM Mode: for AS-F232, AS-F422, AS-F485
	Function Card 2 Slot	COM Mode: for AS-F232, AS-F422, AS-F485, AS-FCOPM RTU Mode: for AS-FCOPM, AS-FEN02, AS-FPFN02
5	Knob for the Work Mode	COM Mode: serial communication extension mode RTU Mode: remote module mode
6	DIN Rail Clip	Secures the module onto the DIN rail
7	Module Connecting Set	Connects the modules
8	Ground Clip	
9	Label	Nameplate
10	RTU Power Input	Supplies power to the RTU module for RTU Mode only

9.2.3 Knob Functions

9.2.3.1 Restore Default Settings

For all communication cards and work mode, you can cut the device power off and turn the knobs to the position F, and resupply the power. The AS00SCM-A module restores back to default settings once it is resupplied with power. Cut the power off again and turn the knobs to set the new values and then resupply the power. After that the ASSCCM00-A is set with new settings.

9.2.3.2 Modbus Parameter Settings (AS-F232/AS-F422/AS-F485)

Modbus communication (AS-F232/AS-F422/AS-F485) can be installed in Card 1 and Card 2 (in COM mode only).

1. When the setting range is 0x01–0x0F, you can use the knob to set the node ID1 and ID2. (The settings in the ISPSOft is ignored here.)
2. When the setting range is NOT between 0x01–0x0F, you can turn the knob to 0 and use ISPSOft (HWCONFIG) to set up the node ID. Follow the descriptions shown on the HWCONFIG for node ID setting range.

 ID Setup (AS-F232/AS-F422/AS-F485) in COM mode			
ID1/ID2	Node ID Setup	ID1/ID2	Node ID Setup
0	Use ISPSOft (HWCONFIG)	1-F	Manual Setting

3. When the FORMAT knob is NOT set to 0, use the FORMAT1 AND FORMAT2 knobs to set the communication mode. Refer to the following table. (The settings in the ISPSOft is ignored here.)
4. When the FORMAT knob is set to 0, you can use ISPSOft (HWCONFIG) to set up the communication mode.

 Modbus (AS-F232/AS-F422/AS-F485) in COM mode											
FORMAT 1/2	Baud rate (bps)	Data (bits)	Parity	Stop (bits)	ASCII/ RTU	FORMAT 1/2	Baud rate (bps)	Data (bits)	Parity	Stop (bits)	ASCII/ RTU
0	Software setting					8	38400	8	None	2	RTU
1	9600	7	Even	1	ASCII	9	38400	8	None	1	RTU
2	9600	8	Even	1	RTU	A	38400	7	Even	1	ASCII
3	9600	7	None	2	ASCII	B	57600	8	None	1	ASCII
4	9600	8	None	1	RTU	C	76800	8	None	1	RTU
5	19200	7	Even	1	ASCII	D	115200	7	None	1	ASCII
6	19200	8	None	1	RTU	E	115200	8	Even	1	RTU
7	19200	8	Odd	2	RTU	F	115200	7	None	2	ASCII

For UD Link function, you can turn the FORMAT knob to 0 and use ISPSOft (HWCONFIG) to set up the communication mode. Refer to section 9.3.2 for more details.

9.2.3.3 CANopen Parameter Settings (AS-FCOPM)

CANopen (AS-FCOPM) can only be installed in Card 2 for COM mode or RTU mode.

1. When the setting range is 0x01–0x0F, you can use the knob to set the node ID1 and ID2. (The settings in the ISPSOft is ignored here.)
2. When the setting range is NOT between 0x01–0x0F, you can turn the knob to 0 and use ISPSOft (HWCONFIG) to set up the node ID. Follow the descriptions shown on the HWCONFIG for node ID setting range.
3. When in RTU mode, the setting varies according to different CANopen communication mode; refer to section 9.4.1 for more details.

 ID Setup (AS-FCOPM in COM mode) in COM mode			
ID2	Node ID Setup	ID2	Node ID Setup
0	Use ISPSOft (HWCONFIG)	1-F	Manual Setting

4. COM and RTU Mode:

Refer to the following table and use FORMAT 2 knob to set up the communication. You can NOT use ISPSOft (HWCONFIG) to set up the communication mode in this format.

CANopen (AS-FCOPM) in COM Mode and RTU Mode								
FORMAT 2	1	2	3	4	5	6	7	8-F
Bit rates (bps)	10K	20K	50K	125K	250K	500K	1000K	NA
Distance (m)	5000	2500	1000	500	250	100	25	NA

9.2.3.4 EtherNet/IP (AS-FEN02)

EtherNet/IP (AS-FEN02) can only be installed in Card 2 and both slots of Card 1 and Card 2 will be used for RTU mode.

When using the communication card AS-FEN02, you need to set ID1 and FORMAT1 to 0. Refer to the following methods to edit the IP address and settings of AS-FEN02.

1. When both knobs ID2 and FORMAT 2 are set to 0, IP address is set through EIP Builder (ISPSOft -> HWCONFIG).
 - Open EIP Builder and add AS00SCM (RTU) + AS-FEN02 to your network. Double-click HWCONFIG to set up.
 - Open EIP Builder and select **IP Setting Tool** from the **Tool** on the tool bar to scan for the device IP address for setup.
2. When both ID2 and FORMAT 2 are set to F, IP setting mode is in DHCP mode. After setting is complete, you need to turn the power OFF and then ON to make sure the modules are sending DHCP requests. Check the sticker on the AS-FEN02 communication card for the MAC address. After that open EIP Builder and select **IP Manager** from the **Tool** on the tool bar and click **Start the Server** to set up the correspondences between MAC address and IP address.
3. When either ID2 or FORMAT 2 is Neither 0 nor F, IP address is set by knobs ID2 and FORMAT 2. Hexadecimal format is used and ID2 corresponds to x16¹ and FORMAT 2 to x16⁰. The possible IP address is 192.168.1.x, x=1~FE (1~254).

IP Address Setup (AS-FEN02) in RTU Mode				
ID1	0			
FORMAT 1	0			
ID2	0	F	Other combination	x16 ¹
FORMAT 2	0	F		x16 ⁰
IP Address Setup	Use ISPSOft (HWCONFIG)	DHCP	IP Address 192.168.1.x · x=1~FE (1~254)	

Note: The parameters of AS-FEN02 are stored in AS300 PLC or AS00SCM-A. Thus you need to use the knobs to set up the IP address for AS-FEN02 or use COMMGR or IP Setup tool to scan and check for the IP address of AS-FEN02. Refer to section 9.4.2 for more information.

9.2.3.5 PROFINET (AS-FPFN02)

You can use the knob to restore back to default settings.

9.2.4 Wiring

9.2.4.1 AS00SCM-A Power Wiring

- COM mode: Serial communication extension mode

Turn the work mode to COM. Install the module on the right hand side of the AS Series CPU. To avoid problems, do not use an external power supply for AS00SCM-A.

- RTU mode: Remote module mode

Turn the work mode to RTU. This module is equipped with an independent DC power connector.

To ensure the serial communication module functions well and reliably, the external wiring must prevent noise. Before you install cables, follow the precautions below.

- (1) To prevent a surge and induction, the DC cable and other power cables that are connected to the AS00SCM-A must be separate cables. An independent power supply is recommended for the AS00SCM-A.

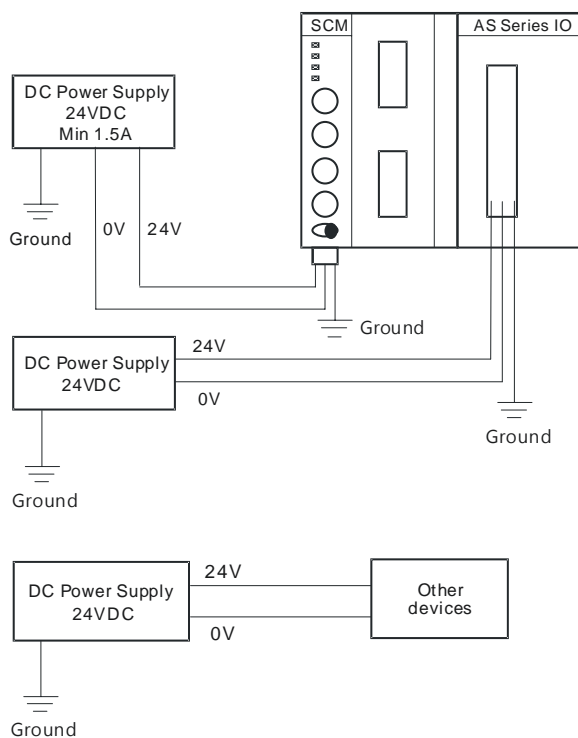

- (2) The 24 VDC cable should be twisted pair, and the shorter end should be connected to the module.
- (3) The cable (110 VAC, 220 VAC, and 24 VDC) must not be installed near a main circuit, a high-voltage cable, or a cable connected to a load that is not a PLC. In addition, the cable must not be bound to a main circuit, a high-voltage cable, or a cable connected to a load that is not a PLC. All the cables should be wired at least 100 mm apart.
- (4) Ground the power supply using a 14 AWG wire.
- (5) Connect 20–14 AWG (1 mm) wires to the input/output terminals. Use only copper leads that can resist temperatures above 60° C /75° C.

9.2.4.2 AS00SCM-A Communication Interface

- COM mode: Serial communication extension mode

This module comes with two function card slots, supporting AS-F232, AS-F422, and AS-F485 communication cards. The Card 2 slot also supports the AS-FCOPM communication card (firmware V2.00 or later). Refer to Chapter 10 for more information on wiring the cards.

- RTU mode: Remote module mode

The Card 2 slot supports the AS-FCOPM communication card (firmware V2.00 or later), AS-FEN02 (firmware V2.02 or later) and AS-PPFN02 (firmware V2.06 or later). Refer to Chapter 10 for more information on wiring the cards.

9.3 COM mode

This section introduces communication modes of AS00SCM-A module (firmware V2.00) when the communication protocol is Modbus, UD Link or CANopen.

9.3.1 Modbus

The AS00SCM-A supports standard communication protocols such as Modbus RS232, RS422, and RS485. Once you create a data exchange table, you can exchange data with slave modules.

- You can set up communication format and node ID via HWCONFIG. Refer to section 9.2.3 for more details.
- Refer to section 9.6.1 for more details on operational examples.

9.3.1.1 Modbus Master

- When AS00SCM-A acts as scanner/master, you can create a data exchange table and exchange data with slave modules. To initialize Modbus communication: Open ISPSOft. -> HWCONFIG -> AS00SCM-A. Be sure to check if the DDF version is the same as the actual firmware before setting up.

The screenshot shows the HWCONFIG software interface. The 'Edit Area' is highlighted in yellow. The 'Data Exchange' tab is selected. The 'AS00SCM-A' device is selected in the left pane. The 'Normal Exchange Area' is selected in the right pane. The 'DDF Version' field is highlighted with a red box and contains the value '02.06.00'.

Device Information	Normal Exchange Area
Device Name	AS00SCM-A
Description	Serial communication module, MODBUS, UD Link protocol (COM. mode), Remote IO control(RTU mode) Module Current Consumption: (internal)22mA, (external)0mA Function Card Current Consumption: [Slot 1]20mA, [Slot 2]20mA Module width: 53mm
Comment	
DDF Version	02.06.00

- **Set up the node ID and communication format. Go to Edit Area -> Function Card1 / Card 2 Setting.**
 - Retry times: set the times for the AS00SCM to retry communication. If no response after the set retry times, a slave timeout alarm will be triggered.
 - Received Data Timeout Alarm Enable: available for FW V2.06 or later, you can enable this function so that if a timeout occurs, an alarm will be triggered. Default: disable.

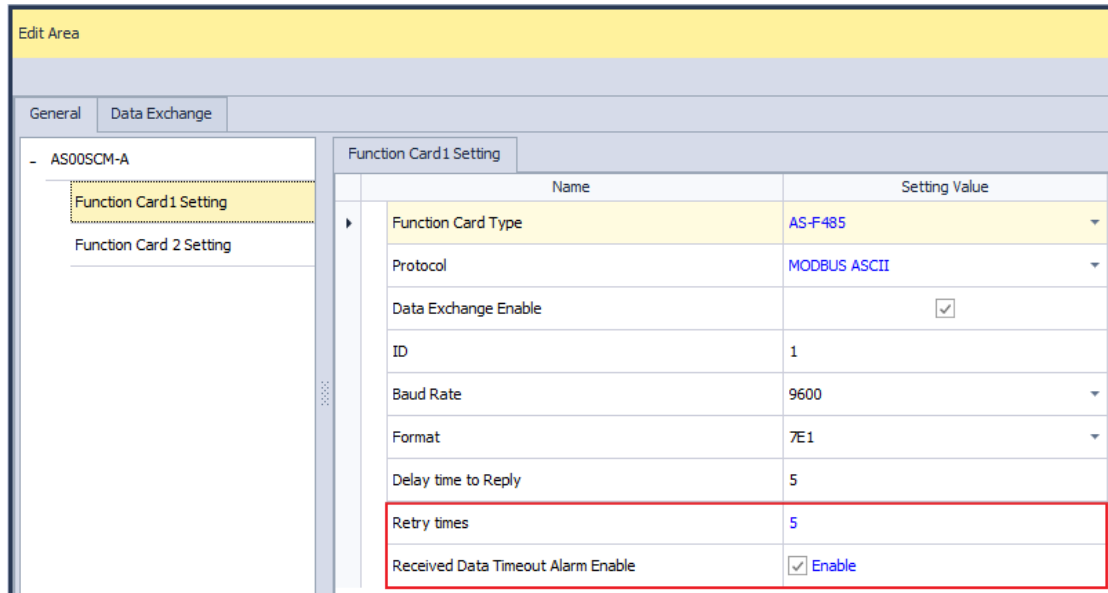

- **Select a mode to start. Go to Data Exchange -> Function Card1 / Function Card 2 -> Mode (Program Control, PLC Run, or Always Enable)**

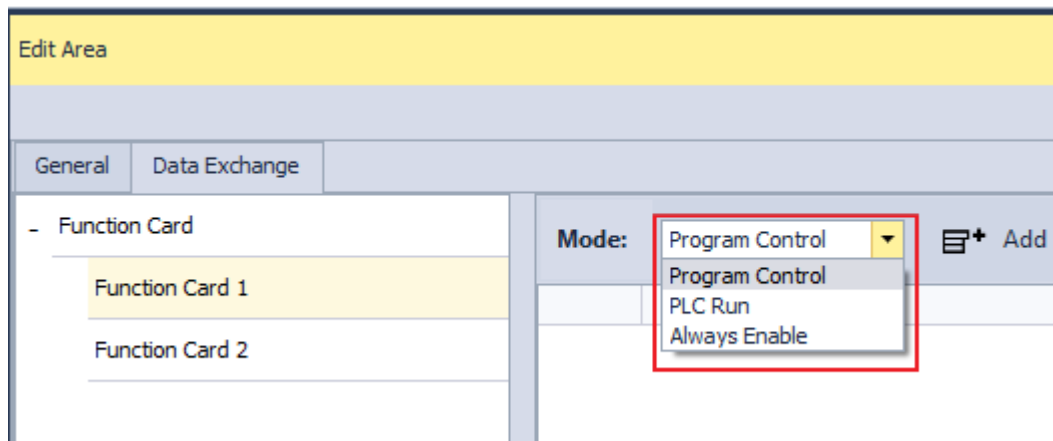

- **Program Control:** PLC decides whether the set data exchange is performed. Function Card 1 and Function Card 2 are independent; you can set them up differently.

Description	Address
Card 1 Data Exchange State (Item 1~32) (0:no...	D28002 - D28003
Card 2 Data Exchange State (Item 1~32) (0:no...	D28006 - D28007
Card 1 UD Link State (0:none/processing, 1:fns...	D28010
Card 2 UD Link State (0:none/processing, 1:fns...	D28011
Output	
Card 1 Data Exchange Mode Control (0:none, 1...	D28020
Card 2 Data Exchange Mode Control (0:none, 1...	D28021
Card 1 Data Exchange Trigger (Item1~32) (0:n...	D28022 - D28023
Card 2 Data Exchange Trigger (Item1~32) (0:n...	D28026 - D28027
Card 1 UD Link Group ID Trigger	D28030
Card 2 UD Link Group ID Trigger	D28031

- **PLC Run:** The set data exchange will be executed automatically when PLC is in RUN state. If the PLC is in STOP state, the communication will stop.
- **Always Enable:** The data exchange will be executed constantly after PLC is powered on.

● **Create a Data Exchange table: Tick the option Enable first.**

Data Exchange Setting

Local Device Setting

- Enable
- The Shortest Update Cycle (ms): 50 Apply to all
- Connection Timeouts (ms): 100 Apply to all
- Support Read/Write Synchronization (Function Code: 0x17)

Remote Device Setting

- Slave Address: 1
- IP Address: [Empty]
- Remote Device Type: AS Series

Read

Local Start Address D26000 - D26099 Remote Start Address D0 - D29999 Quantity (Word)

D Register 26000 0 ← D Register 0 0 1

Write

Local Start Address D26100 - D26199 Remote Start Address D0 - D29999 Quantity (Word)

D Register 26100 0 → D Register 0 0 1

OK Cancel

- Select the **Slave Address** and the **Remote Device Type** from their drop-down list.
- **The Shortest Update Cycle (ms):** You can set the shortest update cycle in ms. If a timeout error occurs too often, you can increase the value here, 10 ms as a unit to find out the best setting value.
- **Connection Timeouts (ms):** You can set the connection timeout time in ms. If for a period of time that you have set, there is no response from the slave device, this is considered as a timeout. The value here cannot be set too large, otherwise the PLC will need to wait for the time set for the slave device to

respond, and this will affect and prolong the data exchange time.

- Support Read/Write Synchronization (Function Code: 0x17):** the master PLC CPU can use MODBUS function code to complete read and write synchronization at one operation. However you need to make sure all the devices support MODBUS function codes; otherwise, the slaves devices may NOT recognize the function code and fail to complete read/write synchronization.
- After the setting is done, click Download. And you can find the Address of Card 1 / 2 Data Exchange State under the tab of Normal Exchange Area. If the address value is 1 here, it indicates the data exchange is a success one.**
- Note:** When you use HWCONFIG to scan the modules, the data exchange table of AS00SCM-A can NOT be copied back to HWCONIG. If you need the data exchange table of AS00SCM-A, you can use **Upload** on the tool bar to send the data exchange table of AS00SCM-A back to HWCONFIG.

9.3.1.2 Modbus Slave

When AS00SCM acts as adapter/slave, it provides a communication channel for AS series PLC to read and write.

Addresses and corresponding registers for function card 1 / 2

Function cards	Address for data to be written	Length (character)	Address for data to be read	Length (character)
Function card 1	16#0000	100	16#0100	100
Function card 2	16#0200	100	16#0300	100

You can find the corresponding registers in HWCONFIG, after setting up AS00SCM-A as the right-side module of AS CPU. As the image shown below, you can see the input device range (to write) for Card 1 is from D26000 to D26099 and the output device range (to read) is from D26100 to D26199.

CPU Group		Module Name	Input Device Range	Output Device Range
CPU	AS332T-A		X0.0 - X0.15	Y0.0 - Y0.15
	AS-F485		NONE	NONE
	AS-F485		NONE	NONE
1	AS00SCM-A		D28000 - D28019	D28020 - D28039
	AS-F485		D26000 - D26099	D26100 - D26199
	AS-F485		D26200 - D26299	D26300 - D26399

Supporting function codes and addresses are shown below.

Function Code	Attribute	Supporting addresses
0x03 0x04	Read	16#0000~16#0063 16#0100~16#0163 16#0200~16#0263 16#0300~16#0363
0x06 0x10	Write	16#0000~16#0063 16#0200~16#0263
0x17	Read	16#0000~16#0063 16#0100~16#0163 16#0200~16#0263 16#0300~16#0363
	Write	16#0000~16#0063 16#0200~16#0263

9.3.2 UD Link

The UD Link provides communications with devices that communicate via RS232, RS422 or RS485. You can edit a packet according to its communication format to send and receive packets. This section introduces the use of UD Link communications in COM mode.

Notes:

1. Make sure the knob of SCM module is turned to 0 before operation.
2. SCMSOft is embedded in DCISoft. Go to www.deltaww.com to download the last version of DCISoft.
3. Make sure you are using the last version of COMMGR.
4. Make sure you are an administrator to run ISPSOft.

9.3.2.1 Steps to Create an UD Link Protocol Communication

1. Setting up in HWCONFIG

Set up the function card. -> Set the communication protocol to UD Link. -> Set up the communication format and baud rate. -> Download to HWCONFIG. -> Use data length 8 byte as the communication format, 8E1, 8N1, 8O2 and so forth to ensure a complete transmission. After setting, you need to download HWCONFIG parameters.

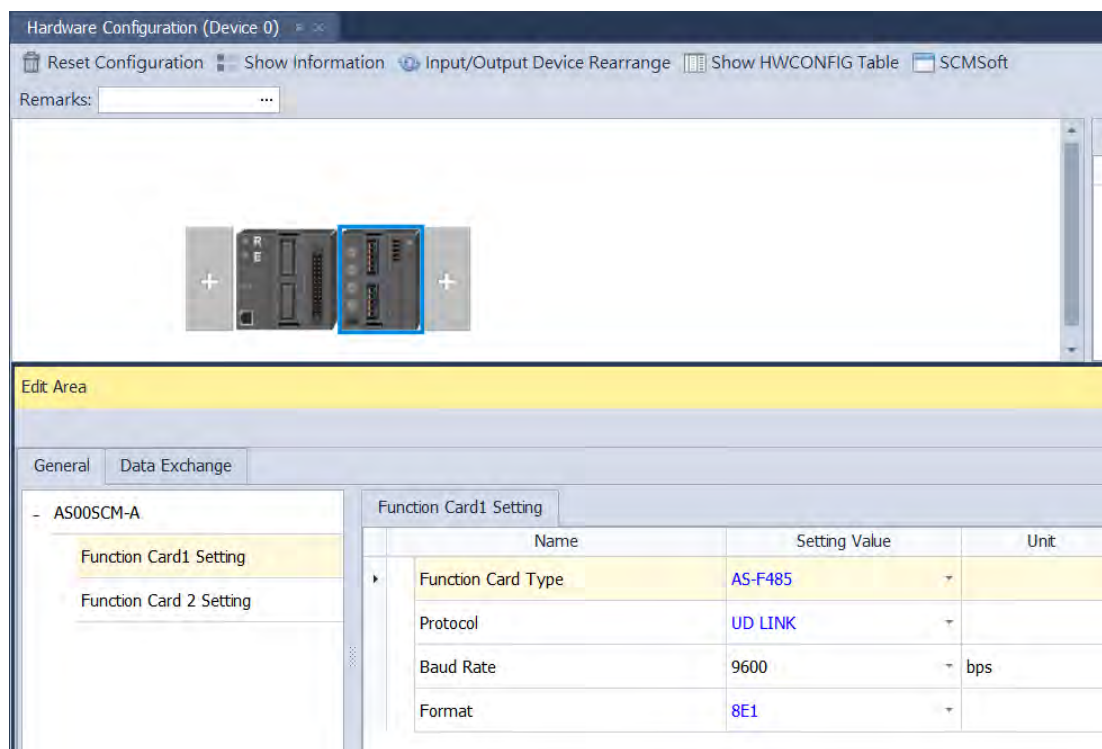

Hardware Configuration (Device 0)

Reset Configuration Show Information Input/Output Device Rearrange Show HWCONFIG Table SCMSOft

Remarks: ...

AS00SCM-A

Function Card1 Setting

Name	Setting Value	Unit
Function Card Type	AS-F485	
Protocol	UD LINK	
Baud Rate	9600	bps
Format	8E1	

2. Opening SCMSoft

Right-click any AS00SCM module if there is more than one AS00SCM module to see the context menu, click Communication Software and then double-click SCMSoft to open it.

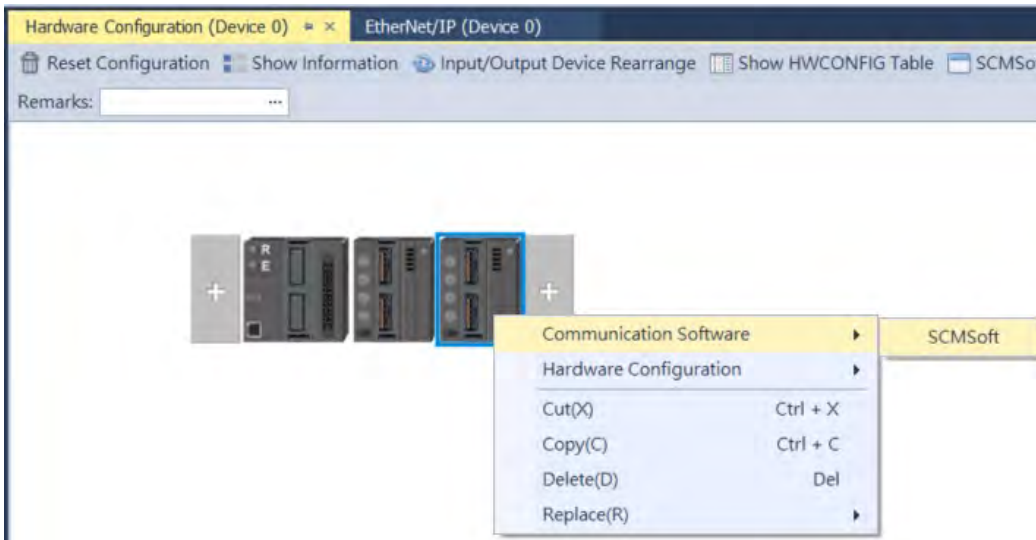

AS00SCM modules can upload UD Link parameters through SCMSoft. Select one slot as one SCM module and one AS00SCM module at one time.

9.3.2.2 SCMSoft

COM PORT Settings: Here is the parameters set in HWCONFIG and it is a read-only page. If you need to edit the parameters, close SCMSoft first and then go to HWCONFIG to edit.

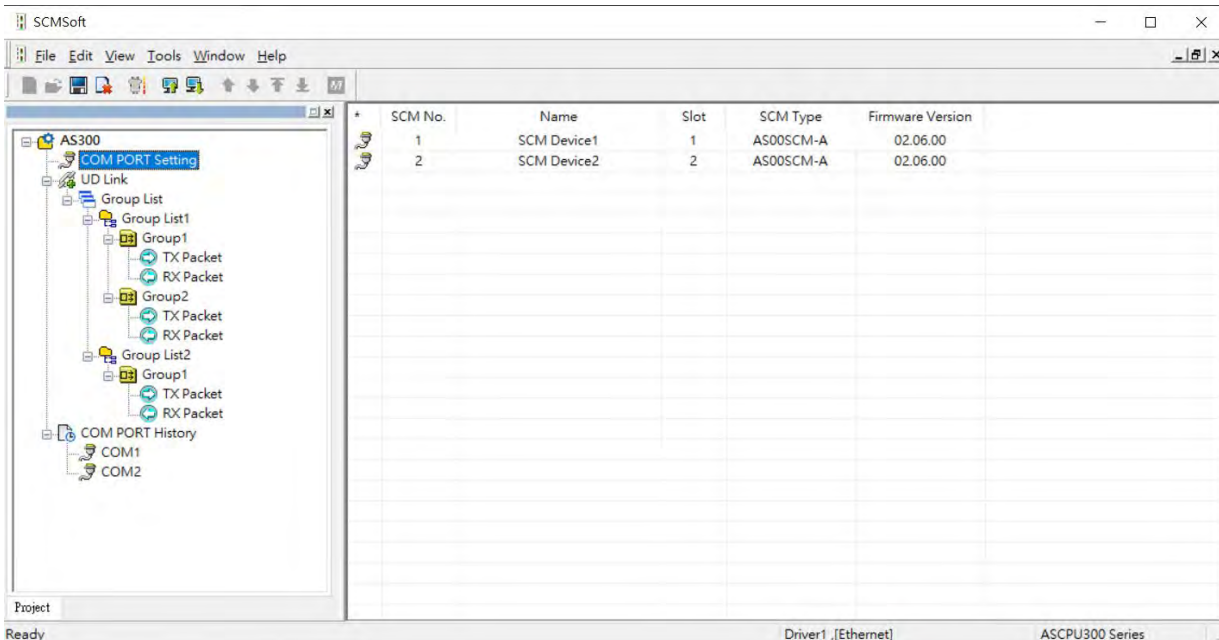

Upload the module parameters to UD Link. -> Right-click Group List to create a group list. -> Double-click the Group List 1 to set up the slot number on the editing window on the right -> Right-click the created group list on the node to create groups for data mapping. -> Define the Group ID and Group Name on the editing window on the right.

Group List: One group list corresponds to one slot, do NOT use the same group list on other slots repeatedly. The slot number in the group list is the actual placement order of AS00SCM-A on the right-side of the PLC. For example, the slot number 2 in the group list corresponds to the second module on the right-side of the PLC. Once the group list is assigned to a certain slot, the CARD 1 and CARD 2 of its corresponding module can trigger the group list of the selected slot.

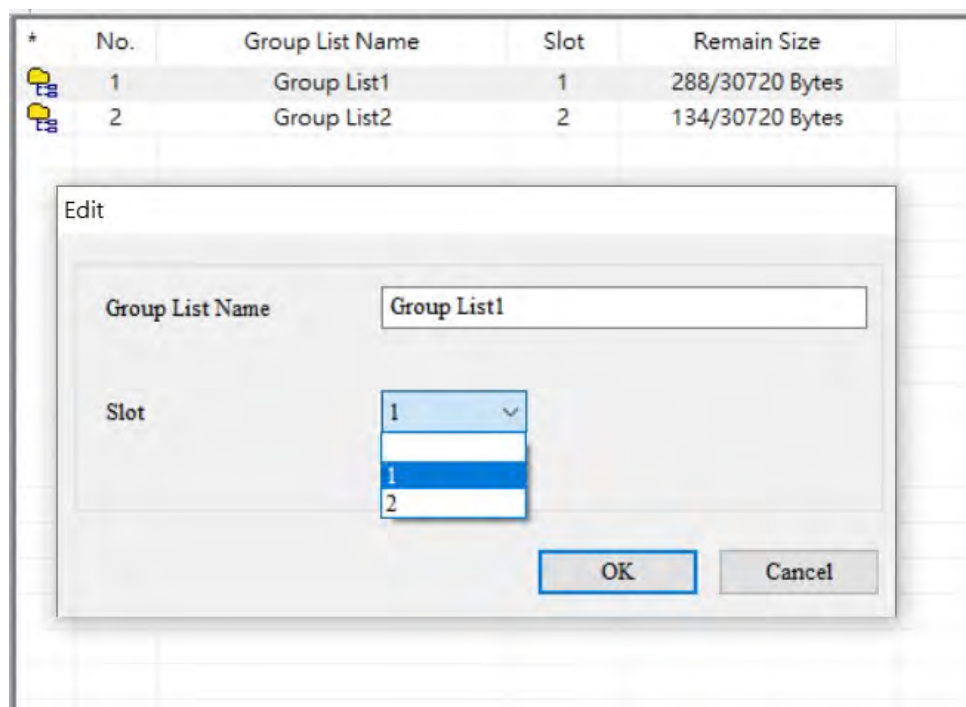
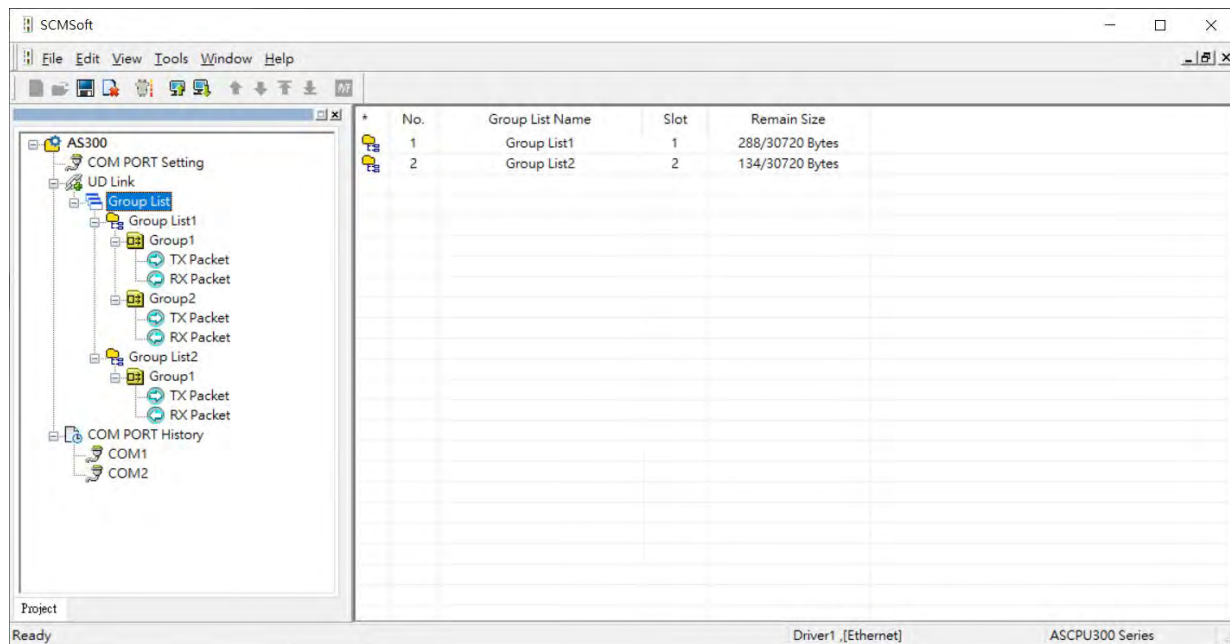

Group List under the Group List: Every group has its Group ID and this number will be used in PLC program as AS00SCM uses to call for the group to take orders.

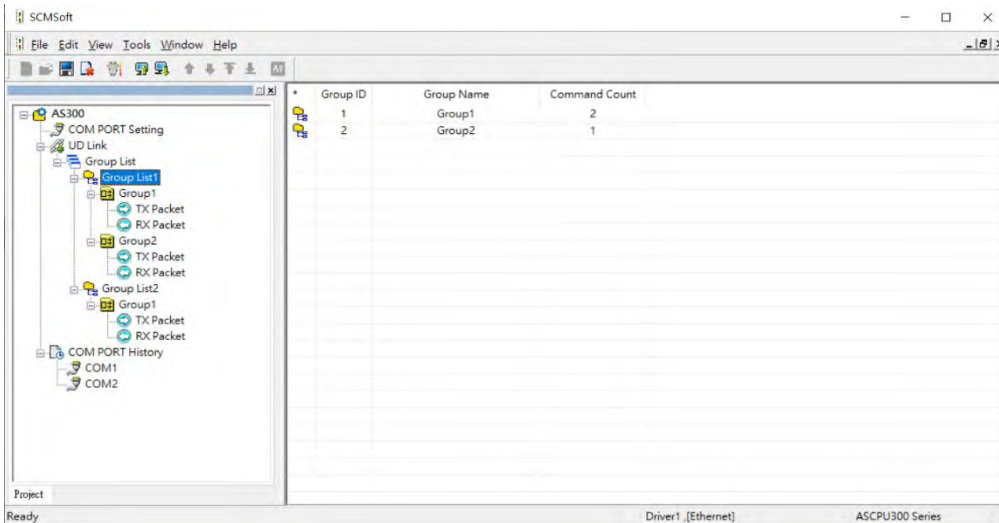

Group: Right-click anywhere on the blank area of the Group to create commands. When the Group ID is called, AS00SCM executes the commands in their numerical order of the called Group ID.

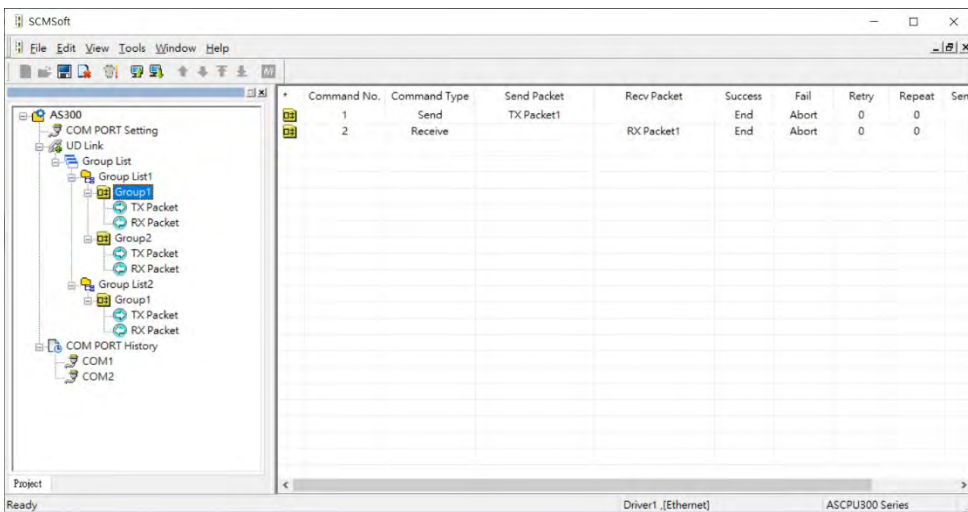

After the group list is created, you can edit packets for transmission.

- **Send packet / Receive packet:** use the packets to be sent or to be received but they can only be used in the group where they belong. Commands can be used to execute all kinds of packets.

Send: to send packets

Receive: to receive packets

Send & Receive: to send packets and to receive packets

1. **COM PORT History:** Right-click this node to upload the COM Port History. You can obtain the data stored in the communication port by selecting the slot (CARD 1 indicating COM 1 and CARD 2 indicating COM2). The data here include TX and RX packets and the data is included not only AS00SCM data but also other kinds of data as long as they are from the same communication port.

Refer to the next section for the settings on packets and commands. After the setting is done, download the parameters from SCMSOft to PLC. And once a group number is trigger, the function card starts to send and receive packets according to the command order. Make sure you add the group number in the UD Link group address in the Normal Exchange area. Refer to section 9.6.2 for more details on operation.

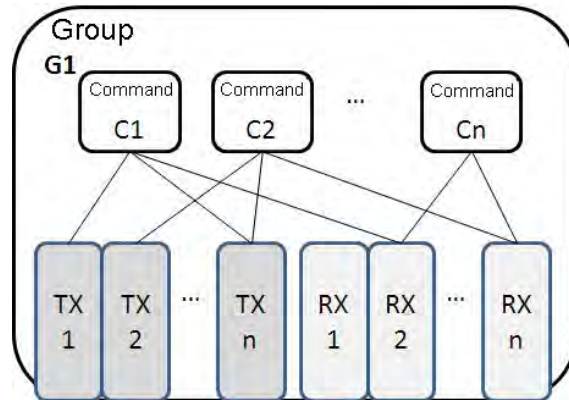

9.3.2.3 TX Packets and RX Packets

You can create several TX and RX packets in a group. A packet includes messages, an address, a length, and a checksum.

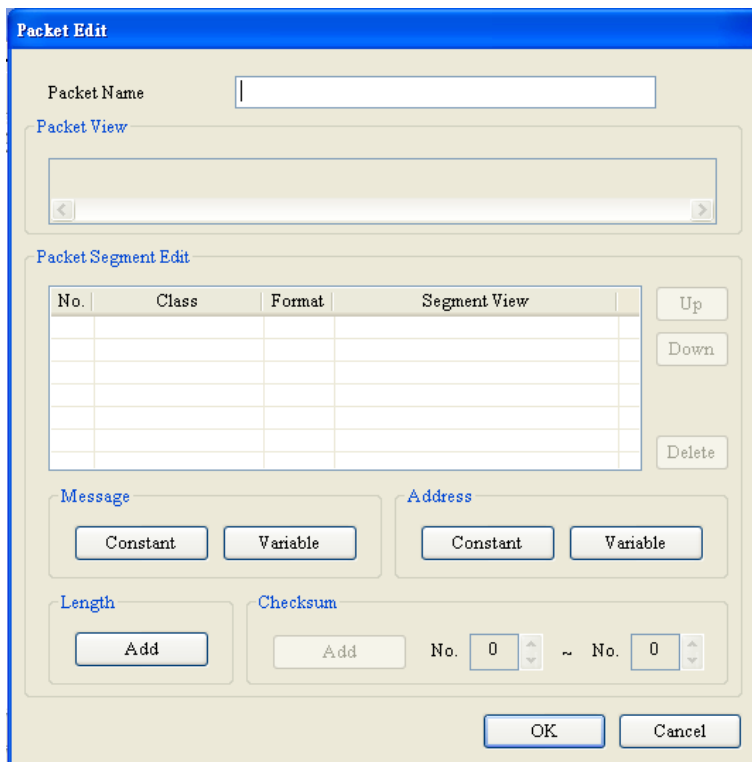

- **Packet Name:** enter the packet name.
- **Packet View:** shows the packet contents.
- **Packet Segment Edit:** adjust the sequence of segments and add or delete segments.
No.: the segment number. You can create no more than 64 segments.

Class: the segment class. The available classes are Message, Address, Length, and Checksum.

Format: the data format of the segment. The available data formats are Hex (hexadecimal), ASCII, and Code.

Segment View: the contents of the segment

- **Message:** a message may be either Constant or Variable. Messages can be applied to a header segment, a start bit segment, an end bit segment, and a data segment. There can be several messages in a packet.
- **Address:** an address may be either Constant or Variable. There can be only one address segment in a packet.
- **Length:** enter the length of a packet. There can be only one length segment in a packet.

Class: 1 byte or 2 bytes

Format: select a format for the length, Hex or ASCII

Value: enter a value for the length according to the format; unit: byte

- **Checksum:** edit the checksum. There can be only one checksum segment in a packet.

Class: select a Class.

Format: select the Format for the checksum.

Initial value: set the initial value for the checksum.

Reverse: the high byte of a one-word checksum is calculated, and the high byte (word) and low byte (byte) of the checksum are reversed.

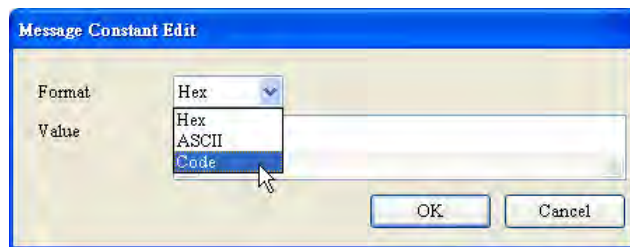

- **Constant:** enter a constant.

Format: Select **Hex**, **ASCII**, or **Code** in the **Format** box. If you select **Code**, the data is a control code.

Value: enter a constant .

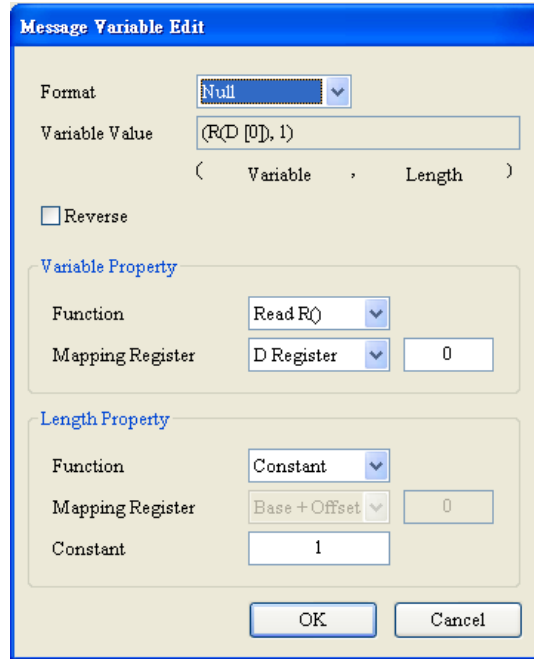

- **Variable:** a variable data to read or write. Specify either an internal register in AH10SCM-A or a register in a CPU module.

- **Format:** select the format for the data.

Null: data is not processed.

Hex: ASCII data is converted into hexadecimal data. ASCII data that cannot be converted into hexadecimal data is converted into 0.

ASCII: Hexadecimal data is converted into ASCII data. Hexadecimal data that cannot be converted into ASCII data is converted into 0.

- **Reverse:** the high byte of a one-word checksum which is calculated, and the low byte of the checksum are reversed.

- **Variable Property:**

Function: for a TX packet, select Read R() for the **Function**. For an RX packet, select **Read R()**, **Write W()**, or * for the **Function**.

Mapping Register: select a register in the PLC.

- **Length Property:**

Function: It is suggested to select to determine the length (*) automatically. The data length can be specified between the packet interval (around 4 character time length) and should receive all data. Select Read R () for a variable. And then you can select its corresponding register. The value here is the length. Select Constant and then you can define the data length.

For a TX packet, you can select the variable and the constant length. For a RX packet, you can select a variable, constant and determine the length (*) automatically.

9.3.2.4 Command

After creating several TX and RX packets, create commands to select packets to be sent and packets to be received. Also create a sequence to execute the commands.

- **Command No.:** every command has a number. The Command Number indicates the execution order. You can also use this Command Number to appoint a certain packet for transmission when using Goto function.
- **Command Type:** select **Send**, **Receive**, or **Send & Receive** for the **Command Type**. Once the type **Send** is selected, when the packet is sent, the transmission is considered successful. Once the type **Send & Receive** is selected, AS00SCM-A checks if the received data met the definition of RX packet. When they are matched, the transmission is considered successful.
- **Send Packet:** select a packet to send.
- **Receive Packet:** select a packet to receive.
- **Success:** specify the action to follow the successful execution of the command: **Next**, **Goto**, or **End**.
 - **Next:** the next command is executed based on Command Number. If the command that is being executed is command 1, the next command that will be executed is command 2.
 - **Goto:** specify a later command to be executed based on its Command Number.
 - **End:** end the sequence of commands.
- **Fail:** specify the action to follow the failure of the command: **Next**, **Goto**, or **Abort**.
 - **Next:** the next command is executed based on Command Number. If the command that is being executed is command 1, the next command that will be executed is command 2.
 - **Goto:** specify a later command to be executed based on its Command Number.
 - **Abort:** end the sequence of commands.
- **Retry:** set the number of times the command will be retried after a failure.
- **Repeat:** set the number of times the command will be repeated after successful execution.
- **Send Wait:** set an interval in milliseconds for the sequence to wait between commands. The default is 0 milliseconds, which causes the next command to be executed immediately after a reply is received.
- **Timeout:** set the amount of time in milliseconds for the system to wait for the command to be executed before the system reports a communication timeout. The default is 50 milliseconds. When it is set to 0, there is no timeout message and the module is at the status of waiting to receive.

9.3.2.5 Return to Default

Select **Tools** in SCMSOft and select **Return to Default**. Select the slot (module) you need to reset and clear all the saved settings in UD Link mode. After that turn off and then turn on AS00SCM-A so that UD Link mode can work again.

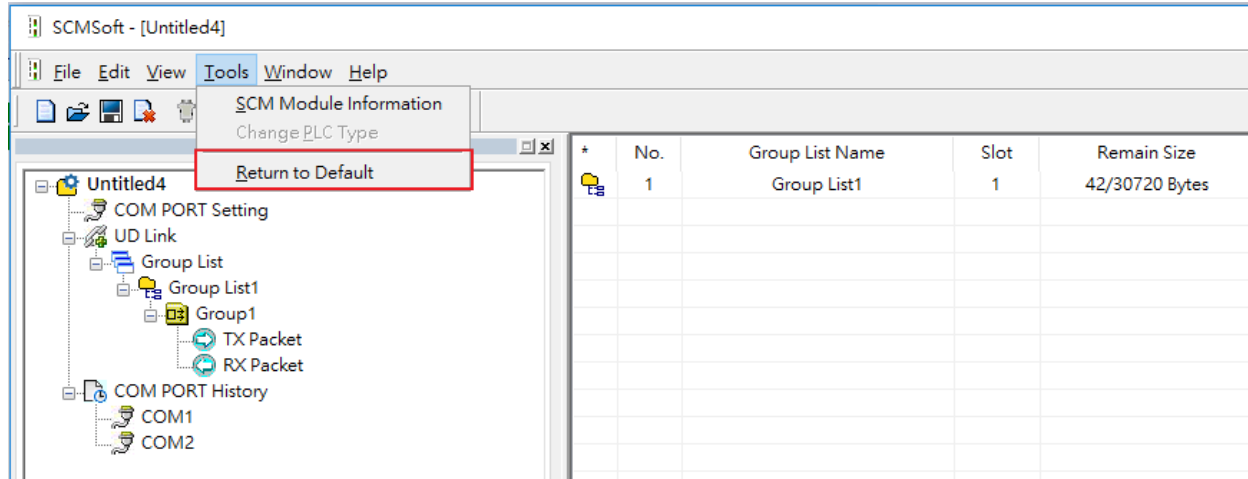

9.3.3 CANopen Mode

The installed on the right side of AS Series PLC CPU, AS00SCM-A (firmware V2.00 or later) can be connected to an AS-FCOPM module through the Card 2 slot. It can then be used as a slave for other modules in the CANopen network environment.

9.3.3.1 Features

When using the AS00SCM-A as a slave module, it has the following features:

- Complies with CANopen DS301 V4.02
- Supports NMT Slave
- Error-controlled; supports Heartbeat and Node-Guarding Protocols
- Supports PDO; up to 8 TxPDO and 8 RxPDO can be configured for every slave.
- Supports SDO:
 - Server: 1
 - User: 0
 - Supports SDO (expedited SDO) transmission mode
- Supports Emergency Protocol

9.3.3.2 Corresponding Input / Output Device Range

When the AS00SCM-A module acts as a CANopen slave, the CPU PLC assigns the input/output device ranges according to the placement of the AS00SCM-A. The corresponding input/output device ranges from the right hand side of the CPU PLC are shown in the example below from the HWCONFIG utility. The red box below is the data exchange section for AS00SCM-A, when the AS00SCM-A acting as a CANopen slave.

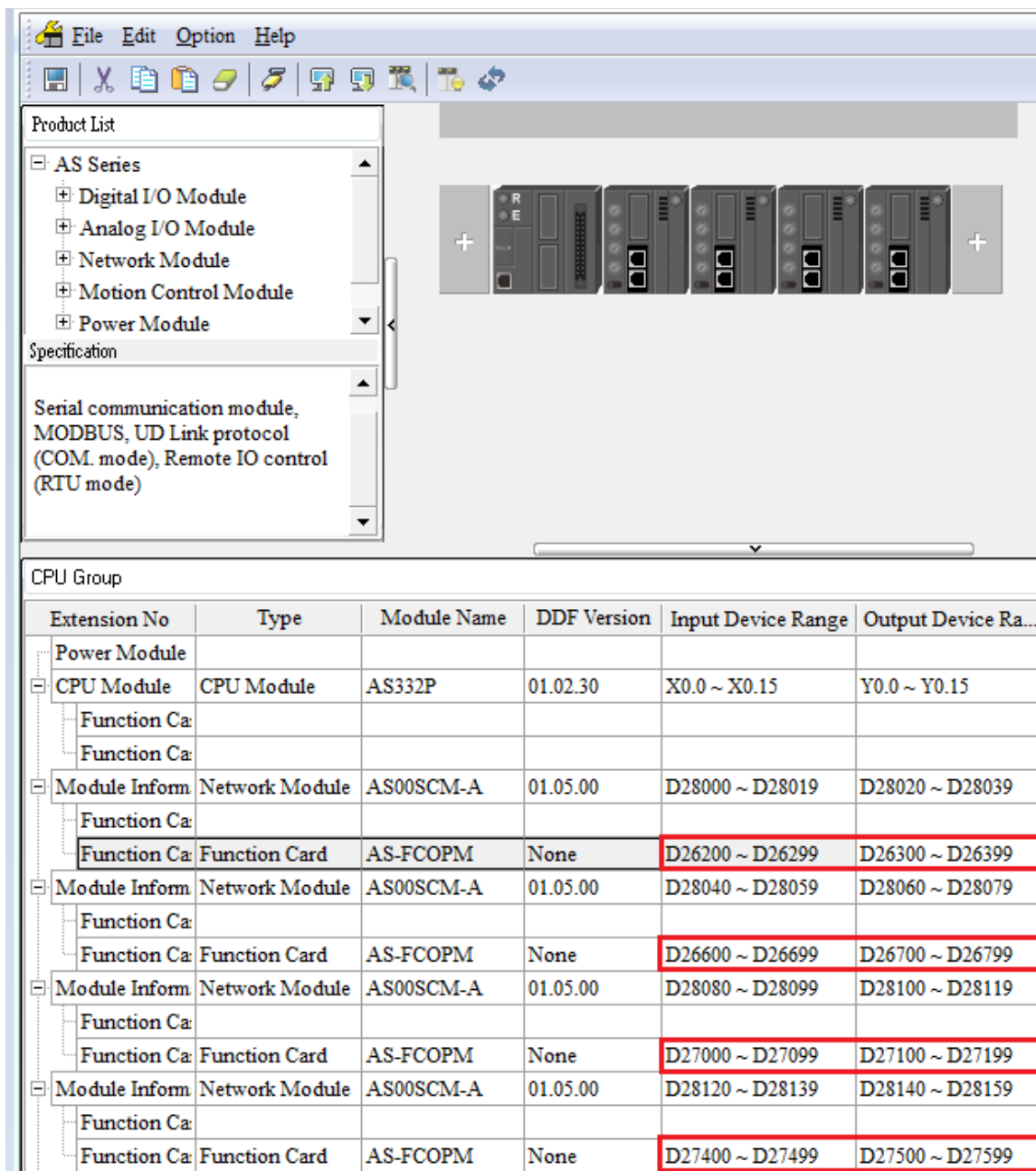

The screenshot shows the HWCONFIG utility interface. On the left, the 'Product List' is expanded to 'AS Series', showing options like Digital I/O Module, Analog I/O Module, Network Module, Motion Control Module, and Power Module. The 'Specification' section for the selected module reads: 'Serial communication module, MODBUS, UD Link protocol (COM. mode), Remote IO control (RTU mode)'. On the right, a rack of modules is shown with a red box highlighting the AS00SCM-A module. Below the interface is a table titled 'CPU Group' with the following data:

Extension No	Type	Module Name	DDF Version	Input Device Range	Output Device Ra...
Power Module					
CPU Module	CPU Module	AS332P	01.02.30	X0.0 ~ X0.15	Y0.0 ~ Y0.15
Function Ca:					
Function Ca:					
Module Inform	Network Module	AS00SCM-A	01.05.00	D28000 ~ D28019	D28020 ~ D28039
Function Ca:					
Function Ca:	Function Card	AS-FCOPM	None	D26200 ~ D26299	D26300 ~ D26399
Module Inform	Network Module	AS00SCM-A	01.05.00	D28040 ~ D28059	D28060 ~ D28079
Function Ca:					
Function Ca:	Function Card	AS-FCOPM	None	D26600 ~ D26699	D26700 ~ D26799
Module Inform	Network Module	AS00SCM-A	01.05.00	D28080 ~ D28099	D28100 ~ D28119
Function Ca:					
Function Ca:	Function Card	AS-FCOPM	None	D27000 ~ D27099	D27100 ~ D27199
Module Inform	Network Module	AS00SCM-A	01.05.00	D28120 ~ D28139	D28140 ~ D28159
Function Ca:					
Function Ca:	Function Card	AS-FCOPM	None	D27400 ~ D27499	D27500 ~ D27599

9.4 RTU Mode

Here you can find the introductions on the communication through CANopen and EtherNet/IP remote mode. For PROFINET remote mode, refer to Chapter 10.

9.4.1 CANopen Mode (AS-FCOPM)

When the function card AS-FCOPM works with an AS series PLC, it supports three kinds of RTU modes, including AS Remote Communication, CANopen DS301 Mode and Delta Special Driver & AS Remote Mode. Use the knob FORMAT 1 to turn among three RTU modes.

A. RTU Communication Mode Setup Knob "FORMAT 1"

FORMAT1	Description
0	AS Remote Communication
4	CANopen DS301
8	Delta Special Driver & AS Remote Mode

B. Node ID Setup Knob "ID1/ID2"

- ID1: 0 (recommended)
- ID2: 0 (the knob is no function; set up through ISPSOft); see the table below for the knob setting range.

RTU mode	FORMAT1	ID2 setting range
AS Remote Communication	0	1~F (by the number of remote slaves and set in a consecutive order)
CANopen DS301	4	1~F (by the number of DS301 slaves) 16-64 (if the knob is at 0, the setting range is set by HWCONFIG)
Delta Special Driver & AS Remote Mode	8	9~F (by the number of remote slaves and set in a consecutive order)
Compound modes: AS Remote Communication and CANopen DS301	4	16-20 and 29-64 (by the number of DS301 slaves)
	8	9~F (by the number of remote slaves and set in a consecutive order)

C. RTU Communication Speed Setup Knob "FORMAT 2"

Use the knob for setting. You cannot use ISPSOft (HWCONFIG) to set up the communication mode in this format.

FORMAT2	1	2	3	4	5	6	7	8-F
Byte (bps)	10K	20K	50K	125K	250K	500K	1000K	NA
Distance (m)	5000	2500	1000	500	250	100	25	NA

9.4.1.1 AS Remote Communication Mode

- Double-click the AS Series PLC, then in Device Setting click **Function Card 2 Setting** and set the function card 2 to AS-FCOPM, set to working mode to AS Remote Communication Mode, enter the number of the AS remote module and set up the baud rate. After the setting is done, download the parameters.

Parameter name	Value	Unit	Default	Minimum	Maximum
Card 2 Detect mode	Manual		Auto Detect	-	-
Manual Select Card	AS-FCOPM Ca		None	-	-
Card 2 ID No.	1		1	1	254
Protocol Setup Opportunity	Stop → Run		Stop → Run	-	-
Baud Rate	9600	bps	9600	-	-
Data bit	7	bit	7	-	-
Parity bit	Even		Even	-	-
Stop bit	1	bit	1	-	-
MODBUS mode	ASCII		ASCII	-	-
Delay time to Reply	0	ms	0	0	3000
Received Data Timeout	200	ms	200	0	3000
F2AD Analog Input mode	0~10V		0~10V	-	-
F2DA Analog Output mode	0~10V		0~10V	-	-
F2AD Sampling Time	3	ms	3	3	15
F2AD Average Times	10		10	1	15
AS-FCOPM Working mode	AS Remote Co		AS Remote Co	-	-
AS-FCOPM node ID	1		1	1	254
AS Remote module No.	1	unit	1	1	15
Select Run mode after detect remote module	Run connecte		Run connecte	-	-

Turn the FORMAT1 knob to 0 and it is in AS Remote Communication Mode. In AS Remote Communication mode, an AS series CPU PLC can connect to as many as 15 AS00SCM-A modules, as long as they are all in RTU mode. The RTU station number should be set from 1 to 15 in numerical order. RTU mode and baud rate cannot be set via ISPSOft (HWCONFIG). Use the knob ID2 to set up Node ID and use the knob FORMAT2 to set up the baud rate. (The baud rate should be the same as the PLC's baud rate.)



FORMAT1: 0x0_h

ID2: 0x1_h~0xF_h

FORMAT2: 0x1_h~0x7_h

Steps for a quick setup

1. Set up the PLC: AS Remote Communication mode, number of the device: 1; baud rate: 1000kbps; download the parameters.
2. Set up AS00SCM-A; set the ID1 knob to 0 and FORMAT1 to 0; ID2 knob to 1 and FORMAT2 to 7.
3. Supply power to AS00SCM-A and connect AS00SCM-A to the PLC with a CANopen cable.
4. Resupply power to the PLC and the indicator of CARD2 should keep blinking. That indicates AS00SCM-A and the PLC are connected. The PLC error indicator should be blinking too, since the setting is not done yet.
5. Use HWCONFIG to scan the connected devices to see if AS00SCM-A is connected.
6. Download the parameters and check if the PLC error indicator has stopped blinking. Then the setting of one RTU device is complete.

9.4.1.2 Delta Special Driver & AS Remote Mode

- Double-click the AS Series PLC, then in Device Setting click **Function Card 2 Setting** and set the function card 2 to AS-FCOPM, set to working mode to Delta Special Driver & AS Remote Mode and enter the number of the AS remote module and set up the baud rate. After the setting is done, download the parameters.

Parameter name	Value	Unit	Default	Minimum	Maximum
Card 2 Detect mode	Manual		Auto Detect	-	-
Manual Select Card	AS-FCOPM Card		None	-	-
Card 2 ID No.	1		1	1	254
Protocol Setup Opportunity	Stop → Run		Stop → Run	-	-
Baud Rate	9600	bps	9600	-	-
Data bit	7	bit	7	-	-
Parity bit	Even		Even	-	-
Stop bit	1	bit	1	-	-
MODBUS mode	ASCII		ASCII	-	-
Delay time to Reply	0	ms	0	0	3000
Received Data Timeout	200	ms	200	0	3000
F2AD Analog Input mode	0~10V		0~10V	-	-
F2DA Analog Output mode	0~10V		0~10V	-	-
F2AD Sampling Time	3	ms	3	3	15
F2AD Average Times	10		10	1	15
AS-FCOPM Working mode	Delta Special Driver		AS Remote Com	-	-
AS-FCOPM node ID	1		1	1	254
Number of remote module for ASDA	1		0	0	7
Select Run mode after detect remote module	Run connected r		Run connected :	-	-
AS CPU module keep or Stop when slave no	Only Show Error		Only Show Error :	-	-
Remote Communication time out	100	ms	100	0	3000
Re-connected Retry number after time out	60		60	0	255
Auto Retry connection after Disconnected	60	sec	60	0	255
AS-FCOPM Bit Rate	1000k	bps	125k	-	-

Turn the FORMAT1 knob to 8, and it is in Delta Special Driver & AS Remote Mode. In this mode, an AS series CPU PLC can connect to as many as 7 AS00SCM-A modules, as long as they are all in RTU mode. The RTU station number should be set from 9 to 15 in numerical order. RTU mode and baud rate cannot be set via ISPSOft (HWCONFIG). Use the knob ID2 to set up Node ID and use the knob FORMAT2 to set up the baud rate. (The baud rate should be the same as the PLC's baud rate.)

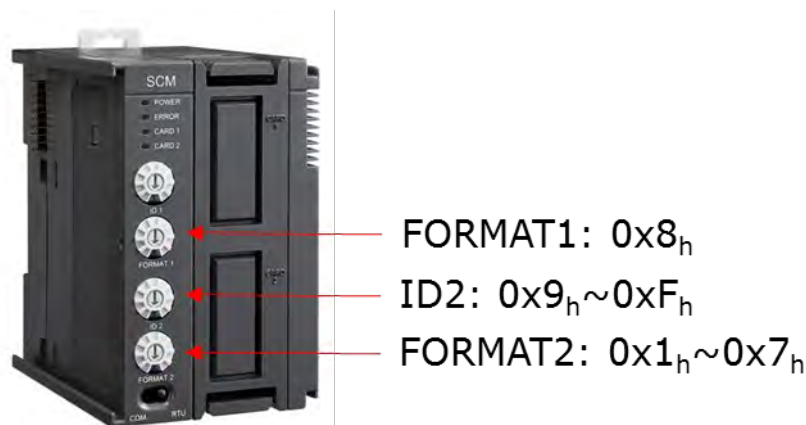

Steps for a quick setup

1. Set up the PLC: Delta Special Driver & AS Remote Modem mode, number of the device: 1; baud rate: 1000kbps; download the parameters.
2. Set up AS00SCM-A; set the ID1 knob to 0 and FORMAT1 to 8; ID2 knob to 9 and FORMAT2 to 7.
3. Supply power to AS00SCM-A and connect AS00SCM-A to the PLC with a CANopen cable.
4. Resupply power to the PLC and the indicator of CARD2 should keep blinking. That indicates AS00SCM-A and the PLC are connected. The PLC error indicator should be blinking too, since the setting is not done yet.
5. Use HWCONFIG to scan the connected devices to see if AS00SCM-A is connected.
6. Download the parameters and check if the PLC error indicator has stopped blinking. Then the setting of one RTU device is complete.

9.4.1.3 CANopen DS301 Mode

- This mode supports AS Series PLC acts as the CPU and the 3rd party CANopen DS301 devices (non-AS series devices and non-Delta PLC). When using Delta PLC as the CPU, you need to use CANopen Builder to set up.
- Before using a 3rd party PLC, use AS Series PLC as the CPU and select the AS Remote Communication Mode.
- Before connecting to CANopen DS301, turn the AS00SCM-A FORMAT1 knob to 4, and the adjustable range for station knob ID2 becomes 0x1_h~0xF_h. This mode is used to communicate with a Master PLC from other brand. See the detail in section 9.6.3. when the PDO data is mapped, AS00SCM-A can control the IO modules from its right side.
- Double-click the AS Series PLC, then in Device Setting click Function Card 2 Setting and set the function card 2 to AS-FCOPM, set to working mode to CANopen DS301.

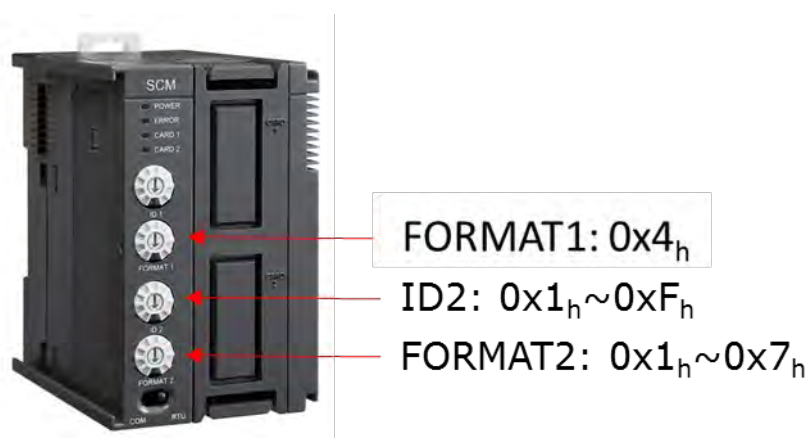

Steps for a quick setup

1. Set up the PLC: in AS Remote Communication Mode, connect AS series PLC to AS00SCM-A, refer to section 9.4.1.1 for more details.
2. Use AS series PLC to scan the I/O modules installed on the right-side of AS00SCM-A and download the parameters.
3. If using HWCONFIG to set up the node ID, you can use COM mode to connect AS00SCM-A to the right-side of AS series PLC directly and no I/O module behind it. Use AS series PLC's HWCONFIG to scan and add AS00SCM-A in and then double-click the module to set up its node ID and then download the parameters. After that, knob ID2 to 0.
4. Install the I/O module to the right side of AS00SCM-A and turn the working mode to RTU.
5. Turn FORMAT1 to 4 and use the CANopen cable to connect to the PLC, and then supply power to AS series PLC.
6. Follow master's CANopen setting method to install the slaves.

Refer to section 9.6.3 PDO examples, if you are using AH10COPM-5A as the CPU.

9.4.2 EtherNet/IP Mode

AS-FEN02 can be installed on AS00SCM-A (firmware V2.02 or later). However AS00SCM-A+AS-FEN02 can only be used in RTU mode. That means this set can NOT be installed on the right-side of AS/AH PLC CPU; AS00SCM-A+AS-FEN02 can connect to AS PLC CPU via internet connection. You can use Delta PLC or the 3rd party EtherNet/IP device to control the right-side modules of the AS00SCM-A.

	AS-FEN02	AS00SCM-A
Compatible firmware versions	V1.00	V2.02
	V1.02	V2.04
	V1.03	V2.06

It is suggested to use ISPSOft V3.13 or later versions when AS00SCM-A+AS-FEN02 is used in remote mode with AS or AH PLC CPU. Use HWCONFIG V4.0 to set up EtherNet/IP for AS PLC CPU and use EIP Builder to set up EtherNet/IP for AH PLC CPU.

When AS00SCM-A+AS-FEN02 is used with the 3rd party EtherNet/IP Scanner, you need to set up the remote IO modules in EIP Builder (V1.06 or later). Go to Delta Official Website [Delta | Download Center \(deltawww.com\)](http://deltawww.com) (steps: Select Product Category: Industrial Automation; Select Product Sub-Category: PLC- Programmable Logic Controllers; Select Series: AS Series; Filter: Electrical Parameter and click Submit and then find the EtherNet/IP EDS File: AS00SCM-RTU (AS-FEN02)) to download the EDS file and then install the downloaded EDS file in the EtherNet/IP software. Refer to the user manual of the 3rd party EtherNet/IP Scanner for more information.

Refer to section 10.2.7 for more details on the operations of AS-FEN02 installed on AS Series PLC.

9.4.2.1 LED Indicators

- AS00SCM-A acting as a remote module

LED Indicator	Description
CARD 1 LED indicator	Orange light blinking: when AS-FEN02 sends data to AS00SCM-A
CARD 2 LED indicator	Orange light blinking: when AS00SCM-A sends data to AS-FEN02
Error LED indicator (red)	Indicates if there is any error on the module OFF: the module is operating normally Blinking: an error has occurred or occurs on the module; refer to section 9.7 for more information.

- AS-FEN02 installed on AS00SCM-A

LED Indicator	Description
MS indicator	Indicates the status of the communication card Green light ON: the operation is normal Green light Blinking: the setting is not complete Red light ON: internal communication failure, NOT being able to recover Red light Blinking: internal communication timeout OFF: no power
NS indicator	Indicates the status of Ethernet connection Green light ON: a CIP connection is established Green light Blinking: a CIP connection is not established Red light ON: duplicated IP address, after fixing this issue, resupply the power

LED Indicator	Description
	Red light Blinking: communication timeout / CIP connection is established after power-on / IP address change OFF: no power / network cable is not connected
LINK indicator X1/X2	Indicates the status of Ethernet connection Green light ON: a network connection is established OFF: a network connection is not established
ACT indicator X1/X2	Indicates the status of Ethernet communication Orange BLINKING: data transmission OFF: no data transmission

9.4.2.2 IP Setting Tool

AS-FEN02 can be installed on AS00SCM-A (firmware V2.02 or later) so that AS00SCM-A can act as a remote module. When the knob is set to 0, the IP address is 192.168.1.3 by default. If there are more than one AS00SCM-A in the system, you need to set up the IP addresses for them. Three methods for you to set up the IP addresses for AS-FEN02 installed on AS00SCM-A.

- Using knobs: Highly suggested. You can use ID2 and FORMAT2 knobs to set up the IP address. Hexadecimal format is used and ID2 corresponds to $x16^1$ and FORMAT 2 to $x16^0$. The possible IP address is 192.168.1.x, $x=1\sim FE$ (1~254).
- Using **IP Manager Tool**: You can find IP Manager Tool in HWCONFIG (V4.0 or later). If you need to use an IP address that is NOT part of 192.168.1.x, you can use **IP Manager Tool** to set up the IP address. This tool uses MAC address to recognize the identities of different devices and thus the IP duplication is allowed. It is very useful when you need to edit the IP addresses of multiple devices at the same time, as long as you know the MAC address of each device. Check the sticker on the AS-FEN02 communication card for the MAC address.
 1. Open EIP Builder and add AS00SCM (RTU) + AS-FEN02 to your network. Make sure all four knobs on the AS00SCM-A (remote module) are turned to 0. And then connect to your computer via Ethernet.
 2. AS-FEN02 (FW V1.02.40 or later) supports **IP Manager Tool** from the **Tool** on the tool bar to scan for the device for IP address setup. You can also edit the devices in different network segments. For example, the IP address of the device by default is 192.168.1.3 but the IP address of the computer is 192.168.10.5. You can use **IP Setting Tool** to edit the device IP address.

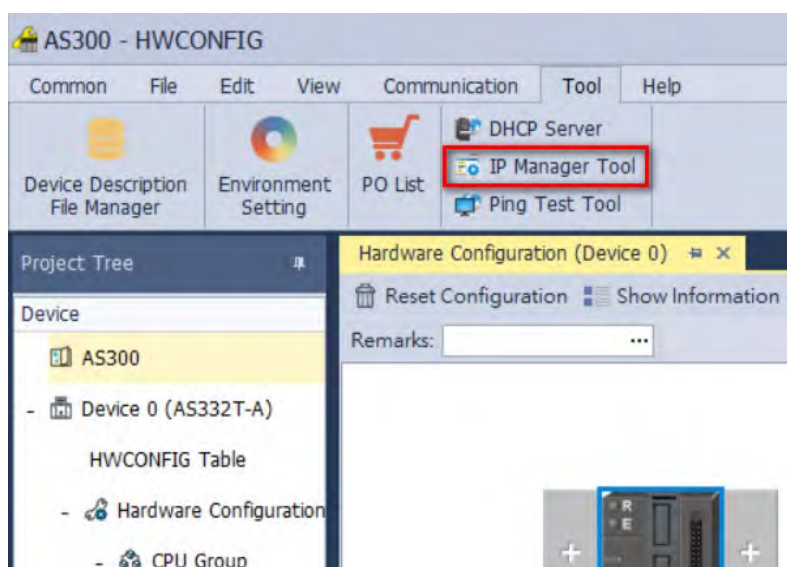

- If you are using a non Delta EtherNet/IP device as a scanner (master), you need to use EIP Builder. Open EIP Builder and select **IP Manager** from the **Tool** on the tool bar.

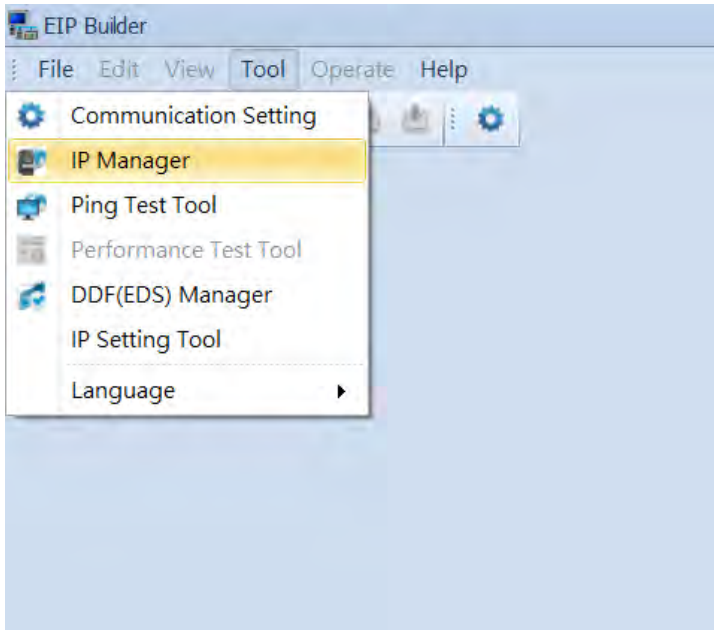

- Select the adapter type and click **IP Search** or **Broadcast Search** and then you can edit the parameters. After the editing is complete, select the device you'd like to download and then click **Download**.

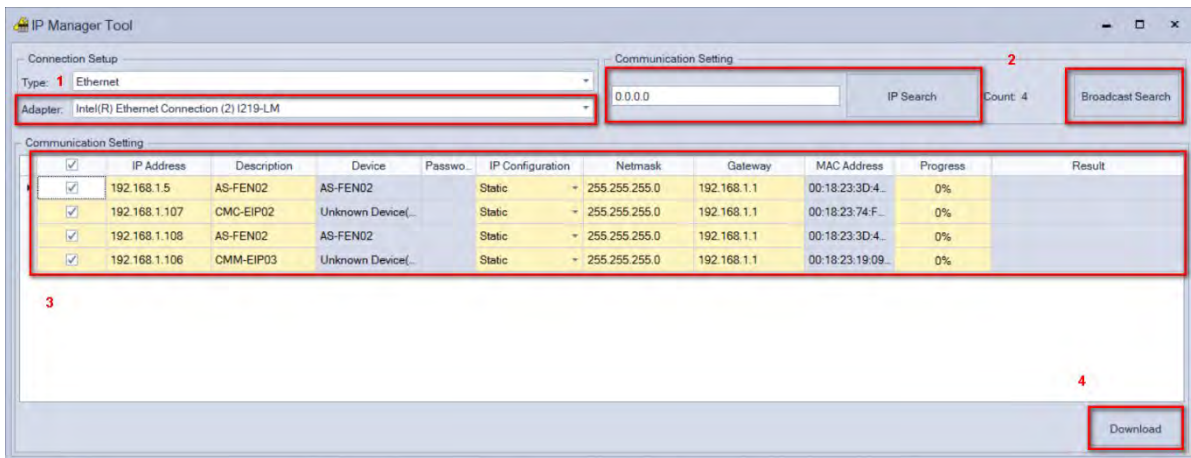

- Using **IP Setting Tool** to change the IP setting mode to DHCP. And after that you can go to **IP Manager** to set up the correspondences between the specific MAC address and specific IP address. Follow the steps below for DHCP setup.

- Using DHCP: Besides using **IP Manager Tool** to set the IP setting mode to DHCP mode, you can also use knob to set the mode to DHCP.
 1. When both ID1 and FORMAT 1 are set to 0 and both ID2 and FORMAT 2 are set to F, IP setting mode is in DHCP mode. And then use Ethernet to connect to your computer.
 2. Open EIP Builder and select **IP Manager** from the **Tool** on the tool bar.
 3. Click **Stop the Server** and then select a suitable **Network Interface**. Click **Start the Server** to complete the setting. After that, you need to turn the power OFF and then ON so that the devices will send DHCP requests to the computer.

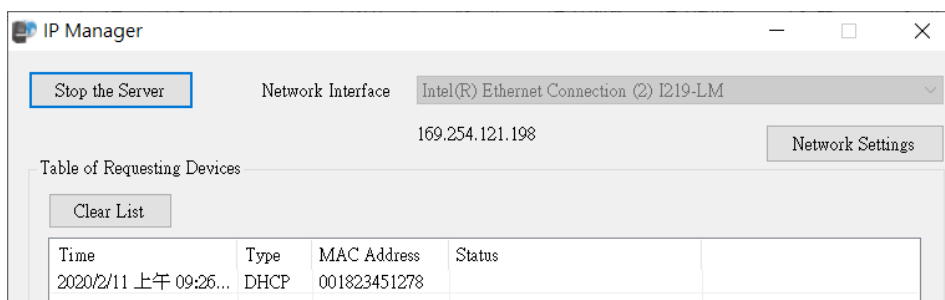

4. Check the device in the DHCP request form to assign the IP address to its corresponding MAC address. You can also export the corresponding table. After the assignment is complete, you can see the result in the status section.

Type	MAC Address	Status
DHCP	001823451278	IP assign success, IP : 192.168....

5. After IP setting is complete, you can decide whether to disable DHCP function or not. If the system is in the absence of a DHCP server (or use **IP Setting Tool** only for once), it is suggested to use **IP Setting Tool** to change the IP setting mode to static mode. If the system includes a DHCP server, it is suggested to keep the IP setting mode in DHCP mode. Whenever the power of the remote module is OFF, the system clears all the IP parameters and sends DHCP request out whenever the power of the remote module is ON to make sure the DHCP server is working.

9.4.2.3 Connecting to Delta PLC Scanner through ISPSOft

Through EIP Builder, an AS Series PLC (when acting as a scanner) can create an EtherNet/IP connection to AS00SCM-A when AS-FEN02 is installed (AS00SCM-A + AS-FEN02 = ASRTU). Below shows an example of AS Series PLC acting as a scanner to create an EIP connection via ISPSOft V3.13. It is suggested to use ISPSOft V3.13 or later or you can use EIP Builder to set up. Refer to section 9.6.4 for more information on Remote IO Applications (AS-FEN02).

1. Connect your AS PLC CPU, ASRTU and computer through EtherNet/IP. Set up the IP addresses for AS PLC CPU and ASRTU and make sure they are in the same network.
2. Open Project: Open HWCONFIG through ISPSOft and click AS PLC CPU to see the EtherNet/IP setting option. Click it to open the setting page.

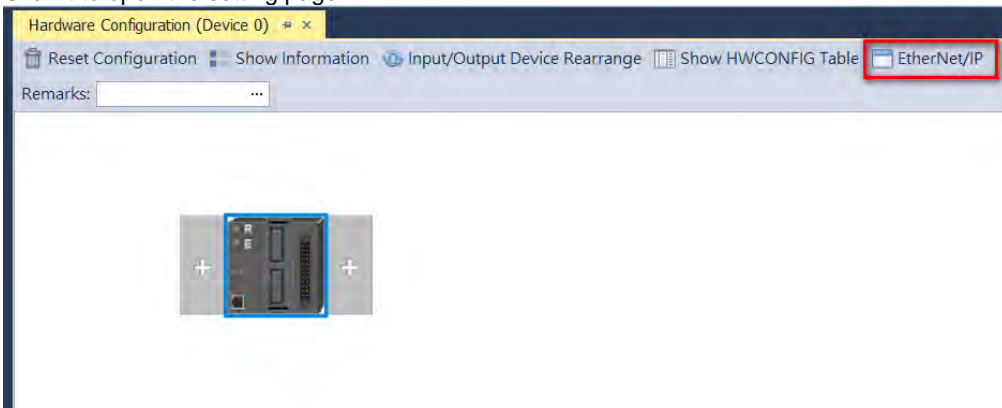

3. Scan the network to add ASRTU in EIP Builder.

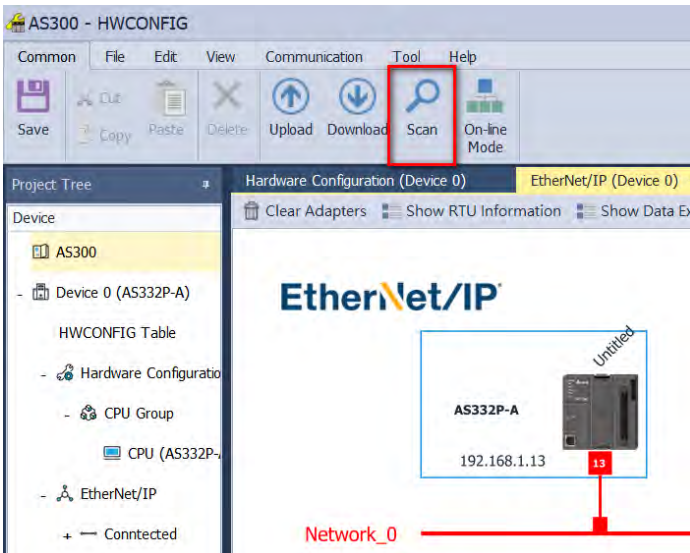

- Establish a connection: Right-click anywhere on the blank area to see the Fast Connect option and then click it to open the setting page. Click OK to connect. When ASRTU is connected to AS PLC CPU, its right side IO modules are also connected.

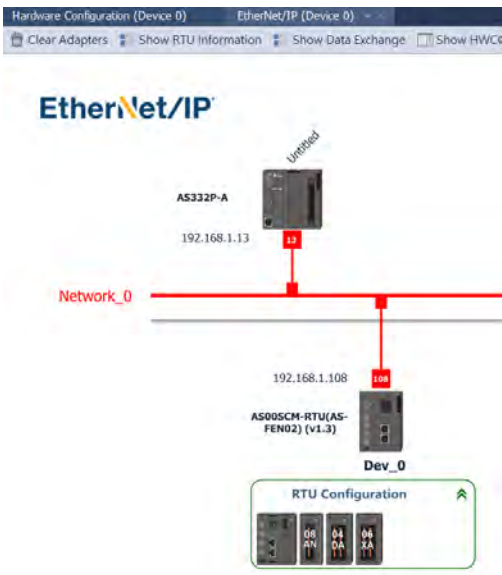
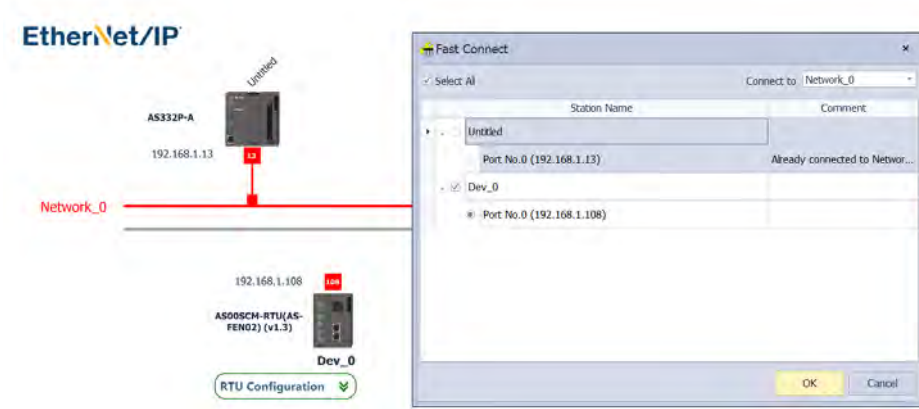

- Set up module: Go back to HWCONFIG and Click ASRTU to see the RTU Configuration (Dev_0) option and then click it to open the setting page for the right-side modules, ASRTU and the handlings after the connection lost. Refer to section 9.4.3 for more information on Remote Module Setting.

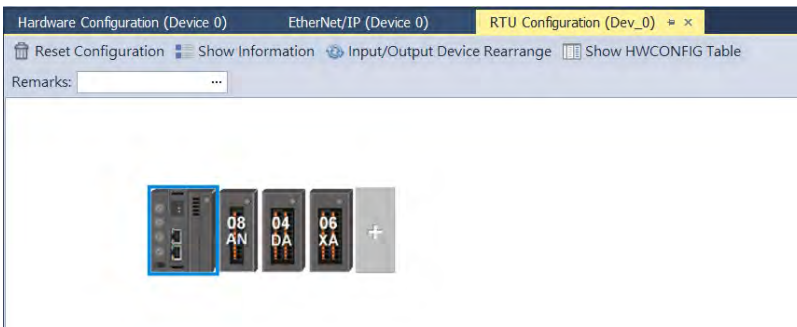

- Data Exchange: Go to EtherNet/IP setting page and click Show Data Exchange option to see the setting page.

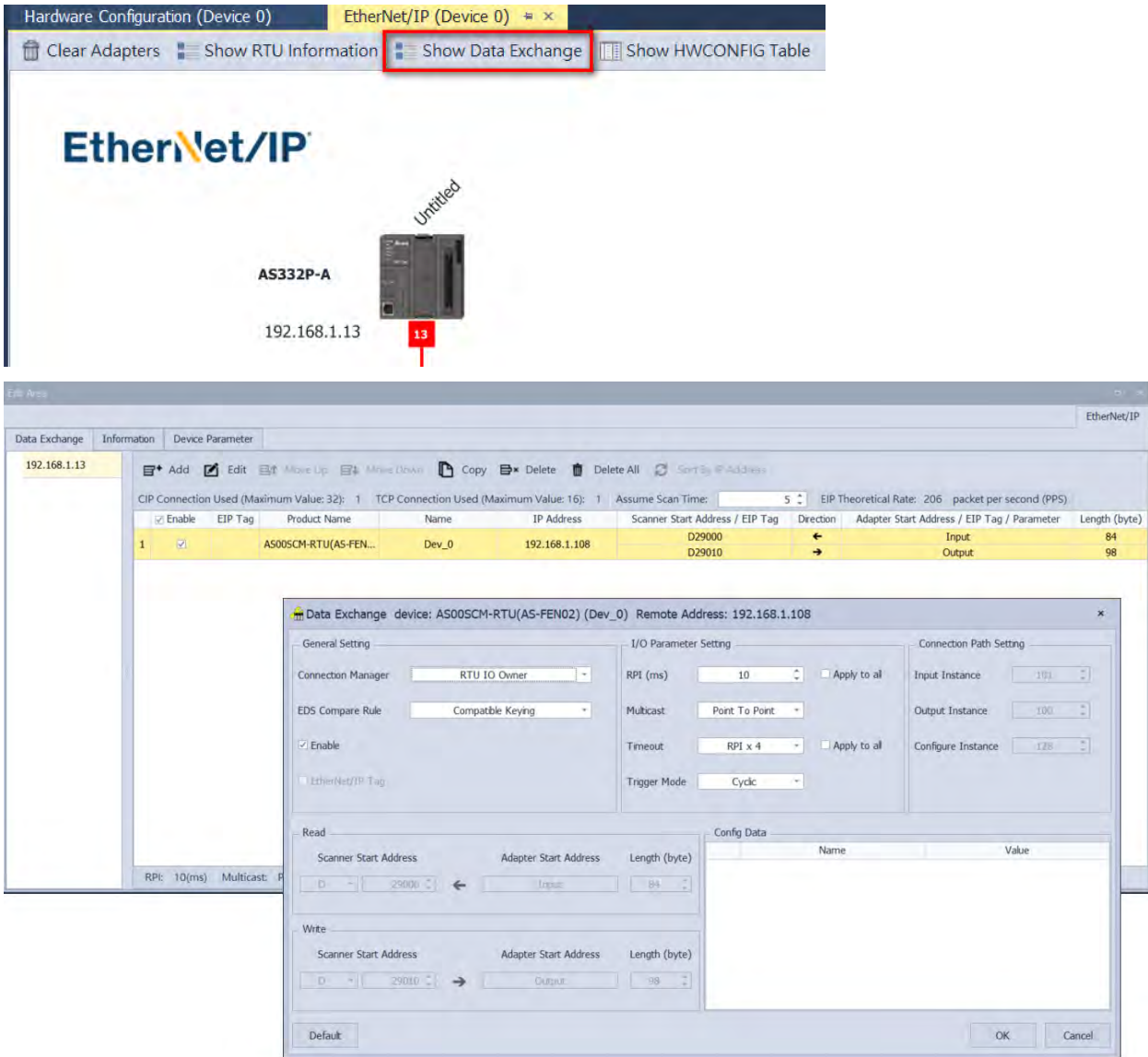

7. Download: Use the function button **Download** under the **Communication** tab in EtherNet/IP setting page to download the EtherNet/IP parameters. Make sure you are in the setting page of EtherNet/IP.
8. Check the connection: Click the function button **On-line Mode** under the **Communication** tab in EtherNet/IP setting to check the EtherNet/IP connection status.
9. HWCONFIG Table Synchronization: After setting is complete, you can synchronize the devices used by ASRTU with ISPSOft.
 - 1) Open HWCONFIG Table.
 - 2) You can edit the identifier one by one or click **Set All Identifiers** to set all identifiers at one time.

Description	Data Type	Device Range	Identifier
Hardware Configuration			
+ CPU Group			
- EtherNet/IP			
- Dev_0 (192.168.1.108)			
- Module:1 Device: AS00SCM-A			
RTU Error Code	WORD	D29000	NIO_Dev_0_1_0_RTU_Error_Code
IO Module Error Code	ARRAY [8] OF WORD	D29001 - D29008	NIO_Dev_0_1_0_IO_Module_Error_Code
RTU Operation Status	WORD	D29009	NIO_Dev_0_1_0_RTU_Operation_Status
- Module:2 Device: AS08AN01R-A			
CH0 ~ 7 Output status	ARRAY [8] OF BOOL	Y1.0 - Y1.7	DIO_Dev_0_1_1_CH0_7_Output_status
- Module:3 Device: AS04DA-A			
Error code	ARRAY [2] OF WORD	D29040 - D29041	AIO_Dev_0_1_2_Error_code
CH1 Output	ARRAY [2] OF WORD	D29042 - D29043	AIO_Dev_0_1_2_CH1_Output
CH2 Output	ARRAY [2] OF WORD	D29044 - D29045	AIO_Dev_0_1_2_CH2_Output
CH3 Output	ARRAY [2] OF WORD	D29046 - D29047	AIO_Dev_0_1_2_CH3_Output
CH4 Output	ARRAY [2] OF WORD	D29048 - D29049	AIO_Dev_0_1_2_CH4_Output
- Module:4 Device: AS06XA-A			
Error code	ARRAY [2] OF WORD	D29060 - D29061	AIO_Dev_0_1_3_Error_code
CH1 Input	ARRAY [2] OF WORD	D29062 - D29063	AIO_Dev_0_1_3_CH1_Input
CH2 Input	ARRAY [2] OF WORD	D29064 - D29065	AIO_Dev_0_1_3_CH2_Input
CH3 Input	ARRAY [2] OF WORD	D29066 - D29067	AIO_Dev_0_1_3_CH3_Input
CH4 Input	ARRAY [2] OF WORD	D29068 - D29069	AIO_Dev_0_1_3_CH4_Input
CH1 Output	ARRAY [2] OF WORD	D29070 - D29071	AIO_Dev_0_1_3_CH1_Output
CH2 Output	ARRAY [2] OF WORD	D29072 - D29073	AIO_Dev_0_1_3_CH2_Output

3) Go to ISPSOFT -> Global Symbols -> HWCONFIG Table: right-click anywhere on the blank area to see and click the option **Synchronize with HWCONFIG**. After the synchronization is complete, ASRTU devices are shown in array and available to be used in PLC program.

9.4.2.4 Parameters Used in Data Exchange

You can use parameters including RPI and Timeout to ensure a stabilized communication.

- **RPI (Requested Packet Interval):** The value here is to set how often to renew the data between the Scanner and Adapter cyclically and thus increase the value here can lower the risk of EtherNet/IP Scanner network overload. Whenever a connection lost error occurs, you can edit the setting here to troubleshoot.
- **Timeout:** Set the timeout time according to the RPI or the multiple of RPI (RPI*X). This is used to determine if the connection between the scanner/adapter and the remote device is lost. Increase the value here can longer the waiting time for the remote device to respond. It is useful when the remote device is busy. But by increasing the value here can NOT solve the problem of network overload.

9.4.2.5 Connecting to Delta AH PLC Scanner through ISPSOft

Through EIP Builder, an AH Series PLC (when acting as a scanner) can create an EtherNet/IP connection to AS00SCM-A when AS-FEN02 is installed (AS00SCM-A + AS-FEN02 = ASRTU). Below shows an example of AH Series PLC acting as a scanner to create an EIP connection via ISPSOft V3.13. It is suggested to use ISPSOft V3.13 or later or you can use EIP Builder to set up. Refer to section 9.6.4 for more information on Remote IO Applications (AS-FEN02).

1. Connect your AH PLC CPU, ASRTU and computer through EtherNet/IP. Set up the IP addresses for AH PLC CPU and ASRTU and make sure they are in the same network.
2. Open Project: Open HWCONFIG through ISPSOft and click AH PLC CPU to see the EtherNet/IP setting option. Click it to open the setting page.

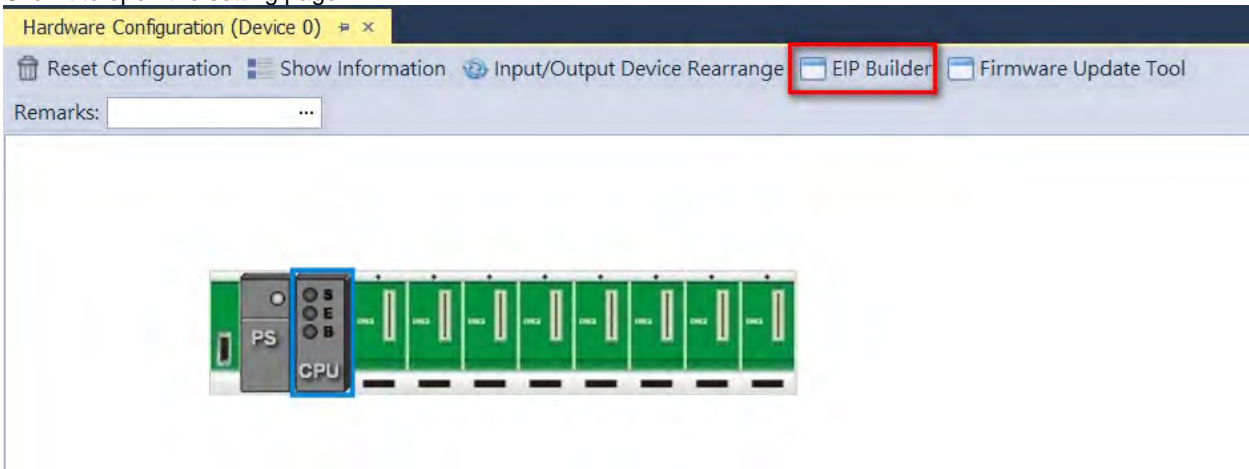

3. Scan the network to add ASRTU in EIP Builder. Drag the red block and drag it to the same network (Network_0) as the AH Series PLC does. Double-click ASRTU to open HWCONFIG and set the parameters for ASRTU.

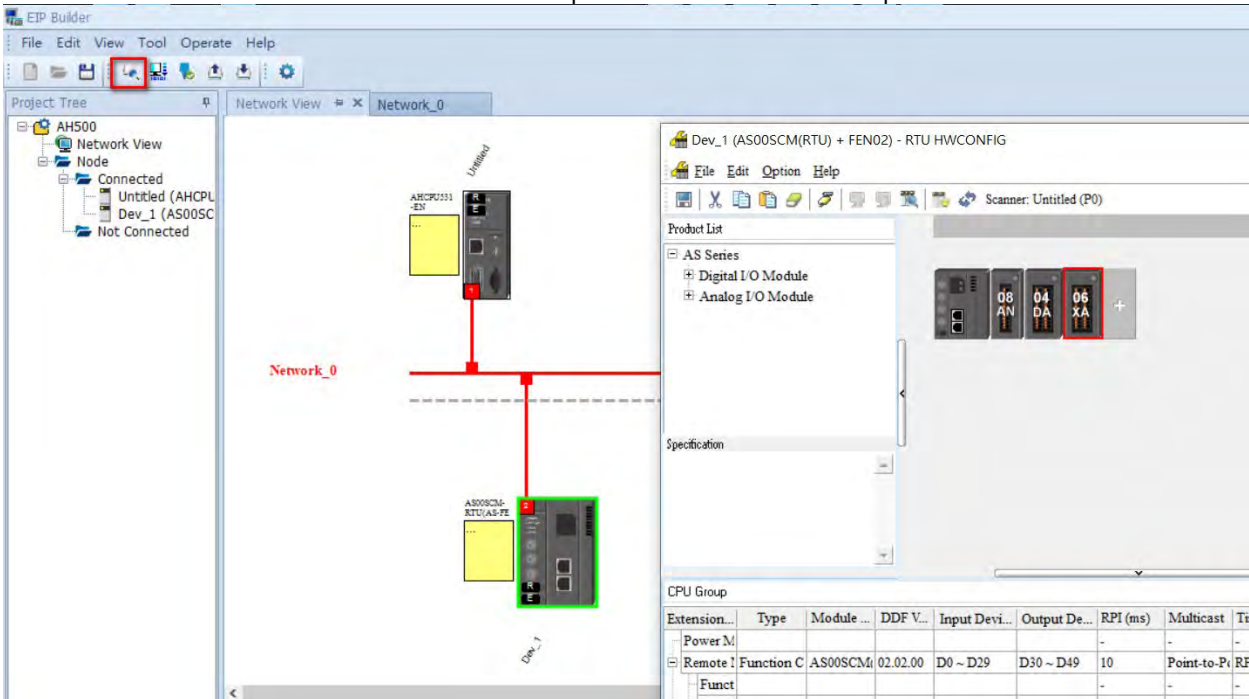

4. Data Mapping

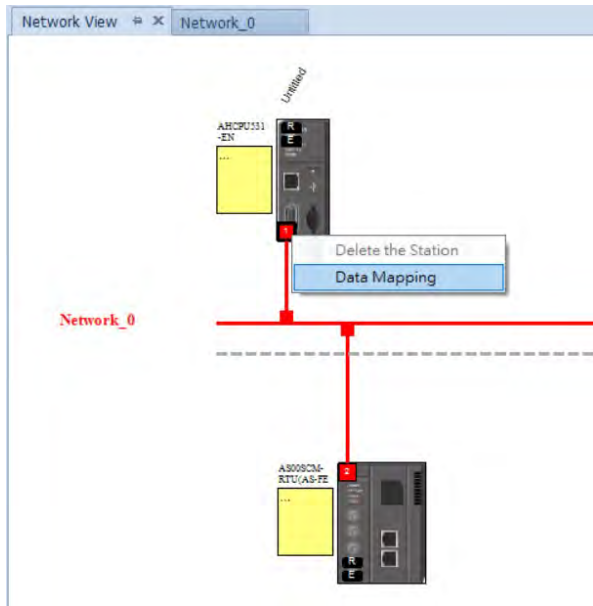

5. You can drag and drop ASRTU from the Product List on the right to add it into the Network View even when it is in off-line mode.

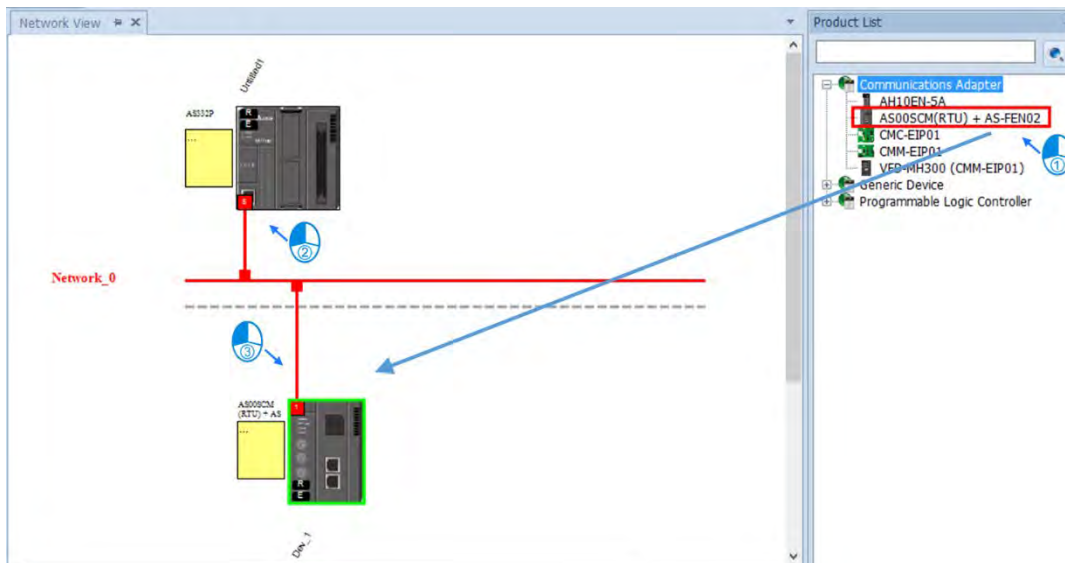

6. After the settings are complete, click the **Downloader** icon and then select the parameters that you'd like to download. Parameters include:
 - RTU parameters: all the parameters set in RTU-HWCONFIG in the previous step
 - Data Exchange: data mapped from the RTU right-side modules of AS00SCM-A to the PLC

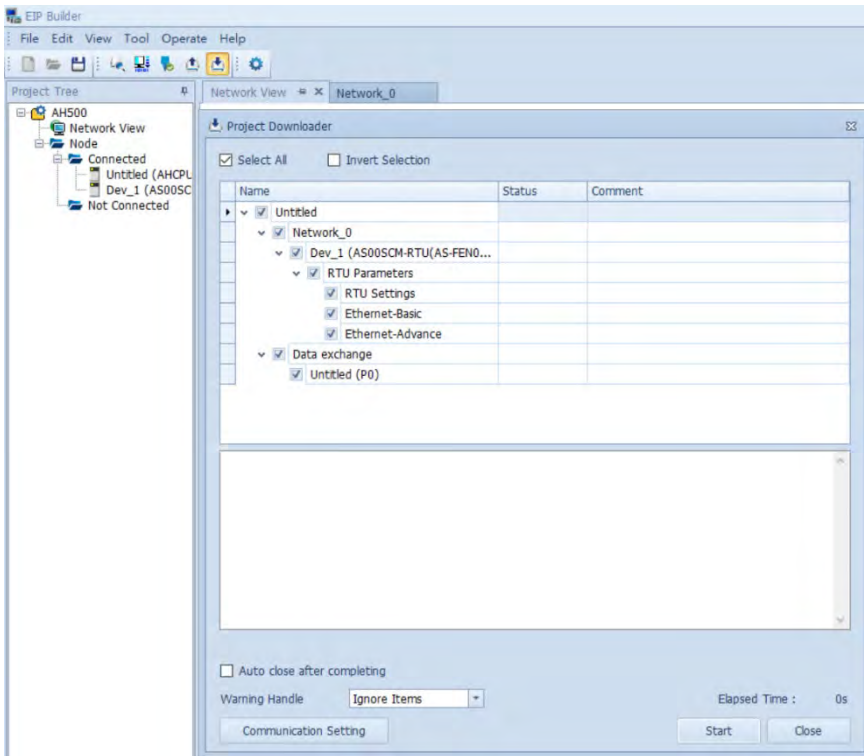

9.4.2.6 Connecting to 3rd Party PLC Scanner through EIP Builder

Through EIP Builder, a 3rd party PLC (when acting as a scanner) can create an EtherNet/IP connection to AS00SCM-A (when AS-FEN02 is installed). Use the 3rd party PLC to connect to the computer and open EIP Builder to edit the right side modules of AS00SCM-A.

- Editing via EIP Builder:
 1. You can manually or scan the network to add the AS00SCM (RTU) + AS-FEN02 to the network. Click the remote module to open RTU-HWCONFIG to scan and download the parameters of the right side modules of AS00SCM-A.

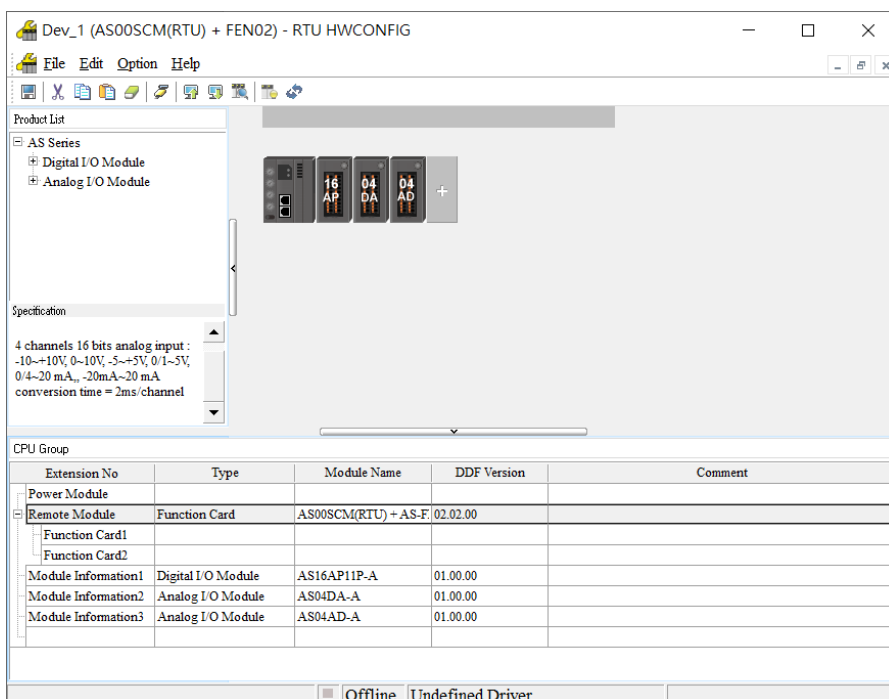
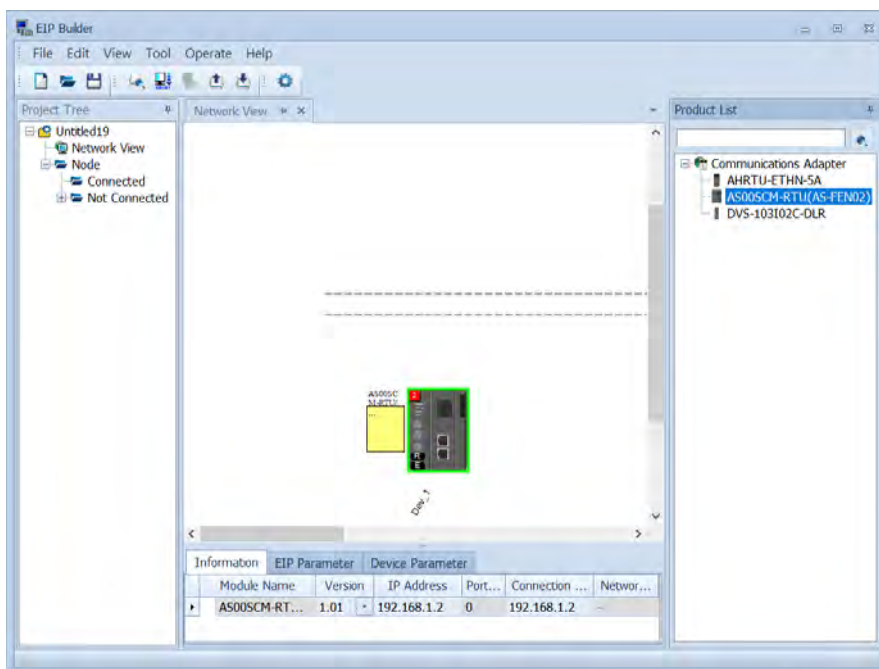

- Write down the information in Normal Exchange Area. This is the working order for the 3rd party device to perform the data exchange. Use AS04DA-A as an example, the first input value is the error code. (all of the module error codes are the input values; the exchange direction is from remote module inputs to scanner) the 1st value is the value in channel 1; the 2nd value is the value in channel 2 and so forth. The unit is the length of 2 words.

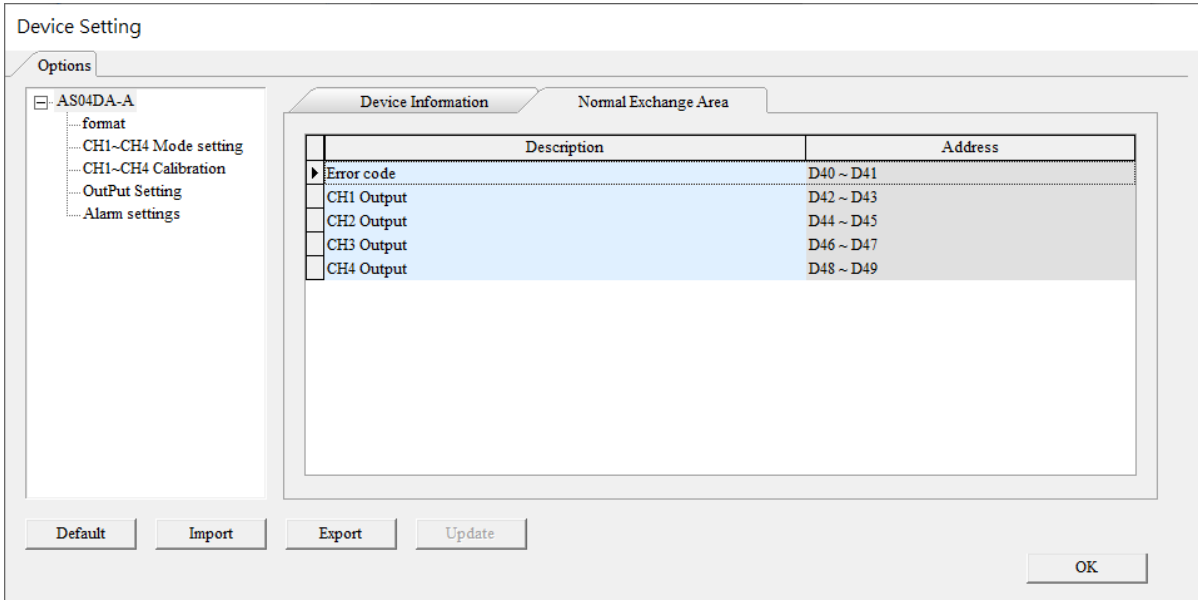

- Before you begin, you need to go to www.deltaww.com to download EDS file.
 - Use EDS Hardware Installation Tool to install the EDS file of ASCPU (AS-FEN02).
 - Right-click **Ethernet** to see the context menu and click **New Module** to add a new device in. After that, you can set up the parameters, including instance for input and output, data length and more. For AS-FEN02 with firmware V1.03 or later, you can open the ASRTU webpage to check the data.

EtherNet/IP information				
I/O Connection		Input	Output	
Instance		101	100	
Total size (INT)		54	39	
Extension No.	Module name	Input offset	Output offset	
RTU module	AS00SCM-A	0 - 29	0 - 19	
--Function card	AS-FEN02			
Module 1	AS08AM10N-A	30 - 30		
Module 2	AS16AP11R-A	31 - 31	20 - 20	
Module 3	AS04AD-A	32 - 51		
Module 4	AS04DA-A	52 - 53	21 - 38	

- After the setting is complete, you can use the module data according to the offset values shown in the webpage. Input data 0-29 and output data 0-19 are the parameters of AS00SCM-A. Refer to the Normal Data Exchange area from RTU-HWCONFIG for more corresponding data information.

9.4.2.7 Network Security

To enhance security and performance of the system, it is suggested to use closed network or LAN with firewall protection to prevent cyber-attacks.

9.4.3 Remote Module Setting

1. Double-click AS00SCM-A -> AS remote module in Device Setting and click **AS Serial Remote Module**. To set up the remote module in RTU mode, set the function card type 2 to AS-FCOPM, AS-FEN02 or AS-FPFN02.
2. For AS00SCM-A with firmware V2.04 or previous versions, parameter-downloading for ASRTU is connection lost. If the handling of lost connection is all the I/O modules stop running (default), you need to turn the power off and then on again after downloading is complete.

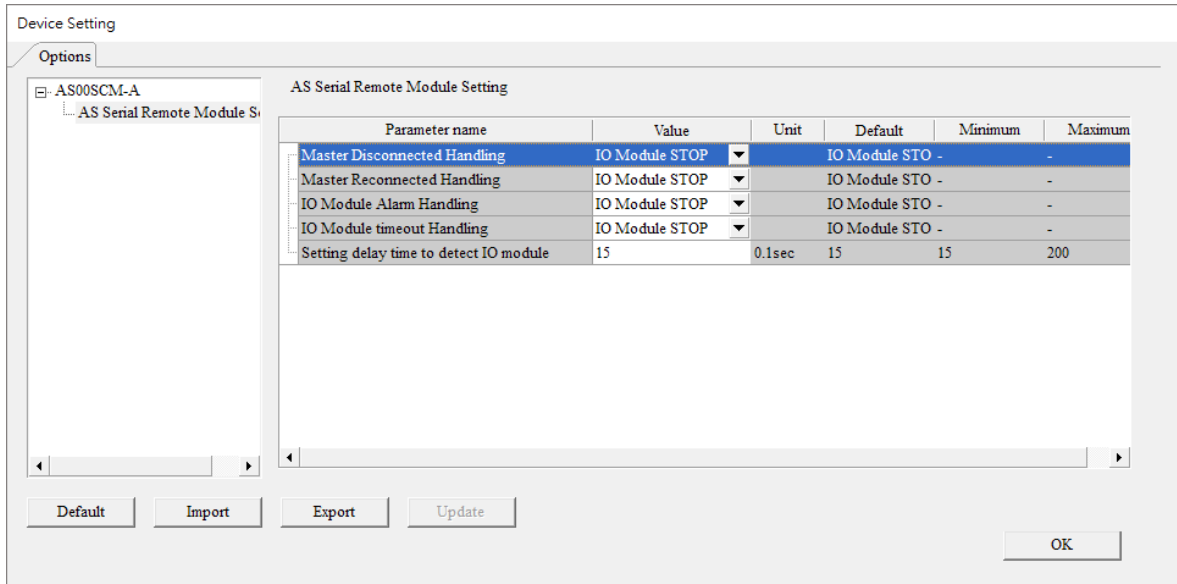

For the following four situations, you can either stop I/O module (all I/O modules stop running) or keep I/O module running (all I/O modules keep the same state).

- 1) When a Scanner (Master) connection is lost
 - I/O modules stop running: all I/O modules stop running
 - I/O modules keep the same state: all modules keep running
- 2) When a Scanner has reconnected after the connection lost
 - I/O modules stop running: all I/O modules stop running
 - I/O modules keep the same state: all modules keep running
- 3) When an alarm occurs in an I/O module
 - I/O modules stop running: all I/O modules stop running (after resupply power to resume running)
 - I/O modules keep the same state: all modules keep running
- 4) When an I/O connection is lost
 - I/O modules stop running: all I/O modules stop running (after resupply power to resume running)
 - I/O modules keep the same state: all modules keep running

Procedure	Settings (RTU)	Digital & Analog Input Modules	Digital Output Modules	Analog Output Module (I/O Module Settings)	
				Clear	Keep
Master connection lost	I/O module stops running	Cannot update data on the master	Output value = 0	Output value = 0	No change to the output value
	I/O module keeps the same state			No change to the output value	
Master has reconnected after connection lost.	I/O module stops running	Keep updating data on the master	Output value = 0	Output value = 0	No change to the output value
	I/O module keeps the same state			Output value = output value of the master	
Alarm in I/O module (Ex. module is broken)	I/O module stops running	No change to the output value	Output value = 0	Output value = 0	No change to the output value
	I/O module keeps the same state	Other functional modules: keep updating data on the master	Other functional modules: output value = output value of the master		
I/O connection lost (Ex. unstable connection)	I/O module stops running	No change to the output value	Output value = 0	Output value = 0	No change to the output value
	I/O module keeps the same state	Other functional modules: keep updating data on the master	Other functional modules: output value = output value of the master		

- Module configurations: refer to Section 9.1.2 in the AS Series Operation Manual.
- Module setups: refer to other chapters in the AS Series Module Manual.

9.5 Normal Exchange Area

1) COM mode

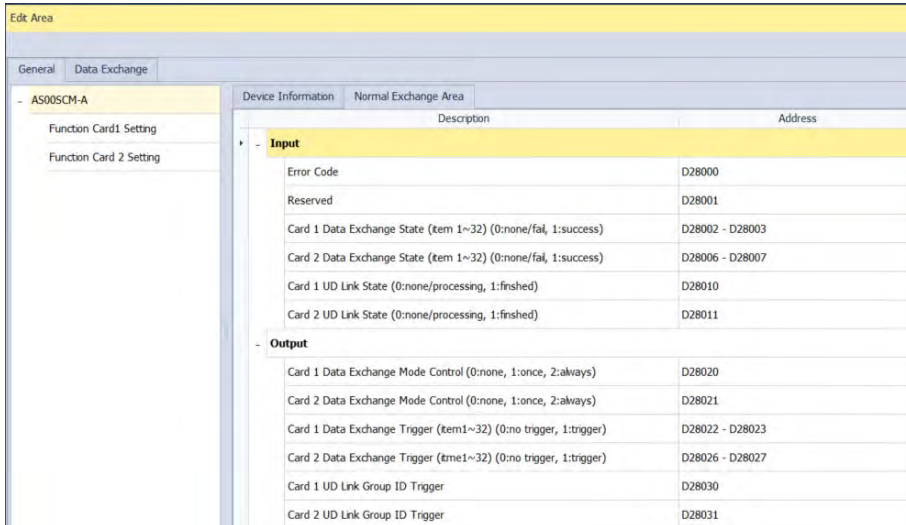

Description	Address
Input	
Error Code	D28000
Reserved	D28001
Card 1 Data Exchange State (tem 1~32) (0:none/fail, 1:success)	D28002 - D28003
Card 2 Data Exchange State (tem 1~32) (0:none/fail, 1:success)	D28006 - D28007
Card 1 UD Link State (0:none/processing, 1:finished)	D28010
Card 2 UD Link State (0:none/processing, 1:finished)	D28011
Output	
Card 1 Data Exchange Mode Control (0:none, 1:once, 2:always)	D28020
Card 2 Data Exchange Mode Control (0:none, 1:once, 2:always)	D28021
Card 1 Data Exchange Trigger (tem1~32) (0:no trigger, 1:trigger)	D28022 - D28023
Card 2 Data Exchange Trigger (tme1~32) (0:no trigger, 1:trigger)	D28026 - D28027
Card 1 UD Link Group ID Trigger	D28030
Card 2 UD Link Group ID Trigger	D28031

The examples above shows that AS00SCM-A is installed as the first module on the right side of AS PLC CPU; note that the Normal Exchange Area shows the corresponding data registers of the module and the PLC.

- Module Status: 0 = stop, 1 = run
- Error Code: refer to Section 9.7 for more information.
- Card 1 & Card 2 Data Exchange State: occupies 4 data registers (32-bit data); each bit 1–32 represents the state of the corresponding data point 1–32 to be exchanged: 0 = none/fail, 1 = success.
- Card 1 & Card 2 Data Exchange Mode Control: set the data register to 0: none, 1: once, 2: always.
- Card 1 & Card 2 Data Exchange Trigger: occupies 4 data registers; each bit 1–32 represents the state of the corresponding data point 1–32 to be exchanged: 0 = no trigger, 1 = trigger.
- Card 1 & Card 2 UD Link Group ID Trigger: set the group ID to be triggered.

2) RTU Mode: (AS Series PLC acting as a Scanner)

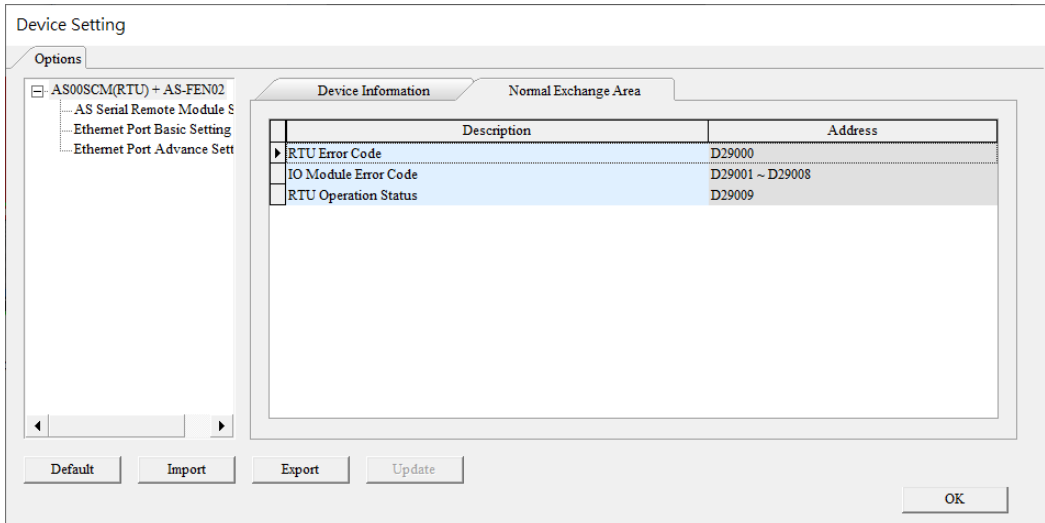

Description	Address
RTU Error Code	D29000
IO Module Error Code	D29001 - D29008
RTU Operation Status	D29009

- RTU Error Code: refer to Section 9.7 for more information.
- I/O Module Error Code: refer to the I/O module manual for more information.
- RTU Operation Status: 0 = communication module stop, 1 = communication module run

3) RTU Mode: (AH Series PLC acting as a Scanner)

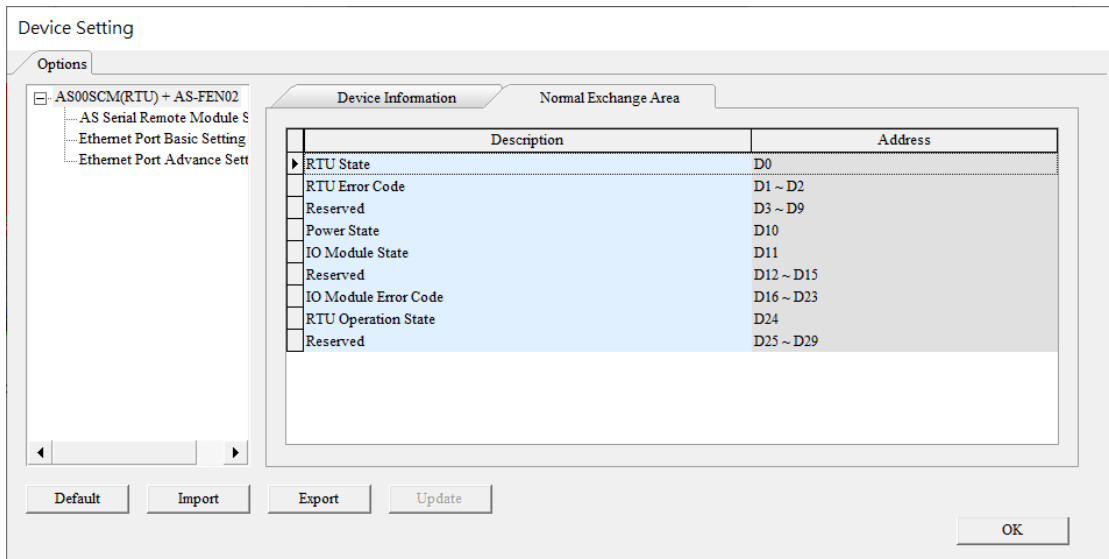

- RTU State: 0 = communication module is working fine, 1 = communication module is NOT working fine.
- RTU Error Code: refer to Section 9.7 for more information.
- Power State: 0 = power error, 1 = power normal
- I/O Module State: each I/O module uses 1 bit to show its status (0 = normal , 1 = not running normally)
- I/O Module Error Code: refer to the I/O module manual for more information.
- RTU Operation State: 0 = communication module stop, 1 = communication module run

9.6 Application

9.6.1 Modbus

This section introduces how to use the Modbus protocol to connect the AS00SCM-A to other Delta industrial products such as human-machine interfaces, temperature controllers, programmable logic controllers, AC motor drives, and servo motors.

9.6.1.1 Modbus Slave – Connection to Delta Products

The following table shows the slave station supports the following function codes and their corresponding addresses.

Function Code	Attribute	Addresses Supported
0x03 0x04	Read	16#0000–16#0063 16#0100–16#0163 16#0200–16#0263 16#0300–16#0363
0x06 0x10	Write	16#0000–16#0063 16#0200–16#0263
0x17	Read	16#0000–16#0063 16#0100–16#0163 16#0200–16#0263 16#0300–16#0363
	Write	16#0000–16#0063 16#0200–16#0263

The structures:

Example of a slave structure: HMI (master station) → AS-F485 + AS00SCM-A COM1 (slave station)

Product	Slave ID	Communication protocol	Device from which data is read	Register in the CPU module	Device into which data is written	Register in the CPU module
HMI	5	9600, RTU, 8, E, 1	16#0100	D26100	16#0000	D26000

If the AS00SCM-A functions as a Modbus slave, you need to set a slave ID and baud rate.

- 1) Drag to add AS00SCM-A in the system configuration area. Make sure the knob of AS00SCM-A is turned to COM mode and no power connected to it.

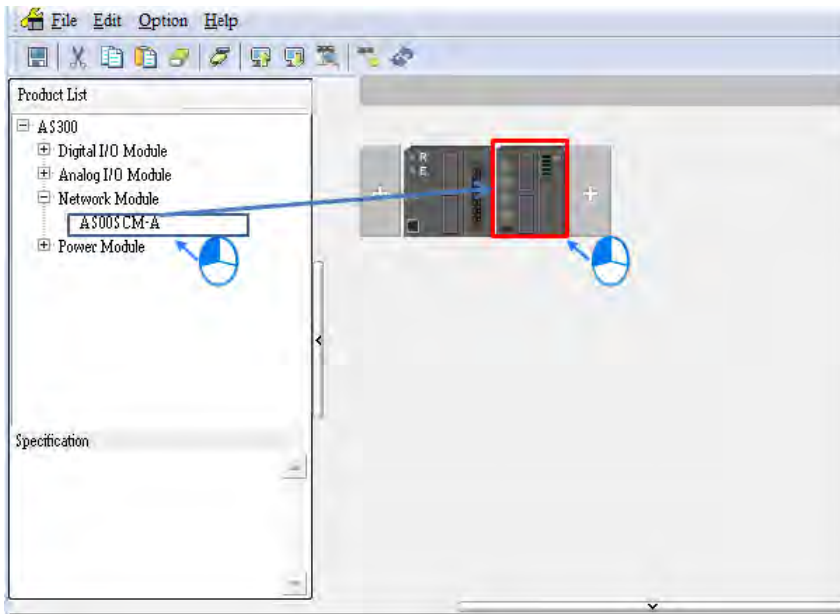

- 2) Click the I/O Scan button to make the system read the module's current configuration. The PLC assigns the input and output device ranges.

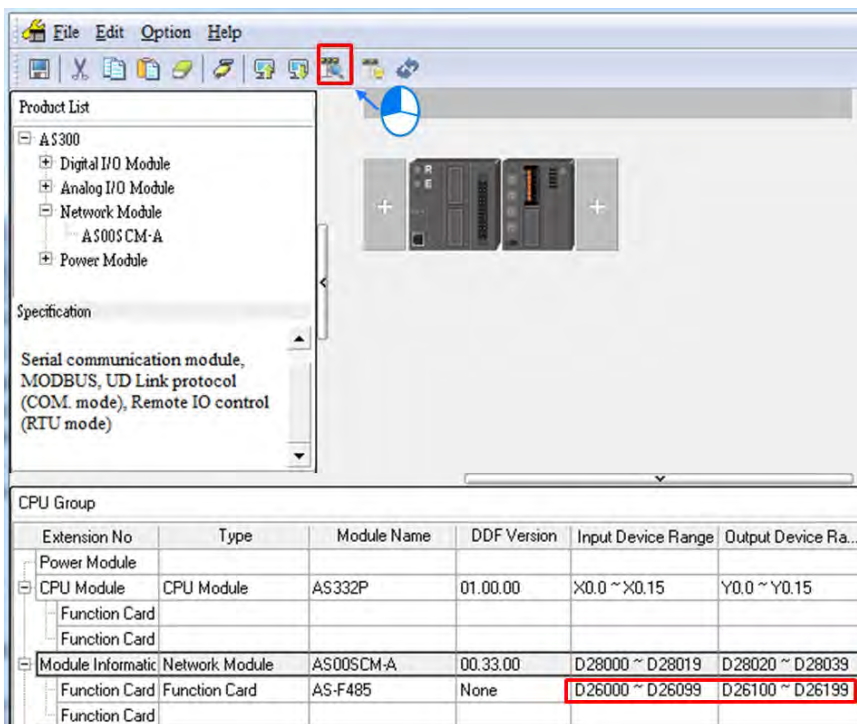

Function card	Device from which data is read	Register in the CPU module	Device into which data is written	Register in the CPU module
Function card 1	16#0000	D26000	16#0100	D26100
Function card 2	16#0200	D26200	16#0300	D26300

3) Double-click the SCM module to open the configuration settings.

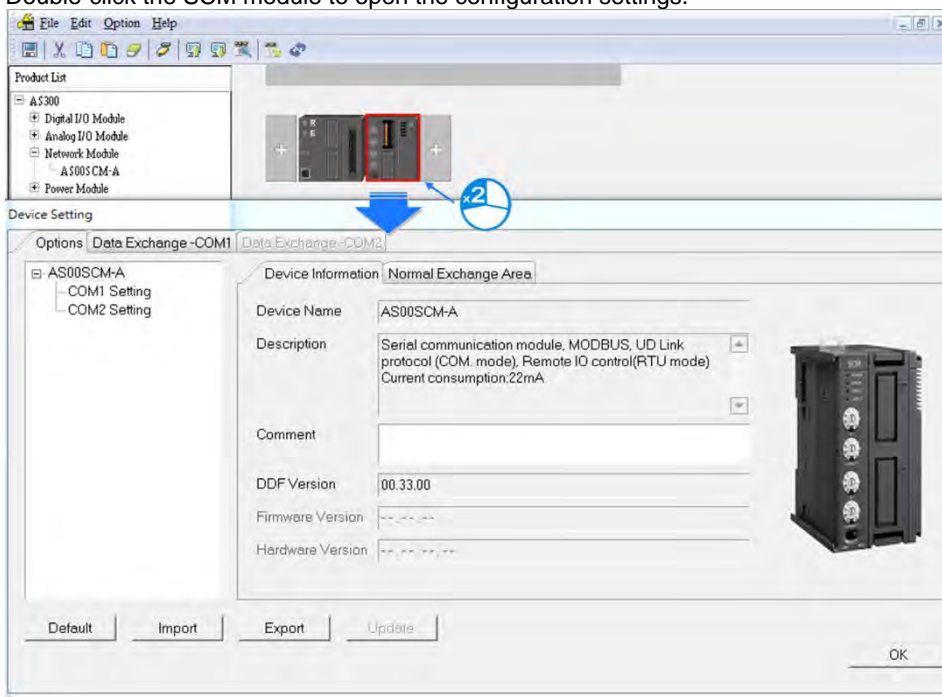

4) Set the communication protocol values for COM1 using the HMI settings.

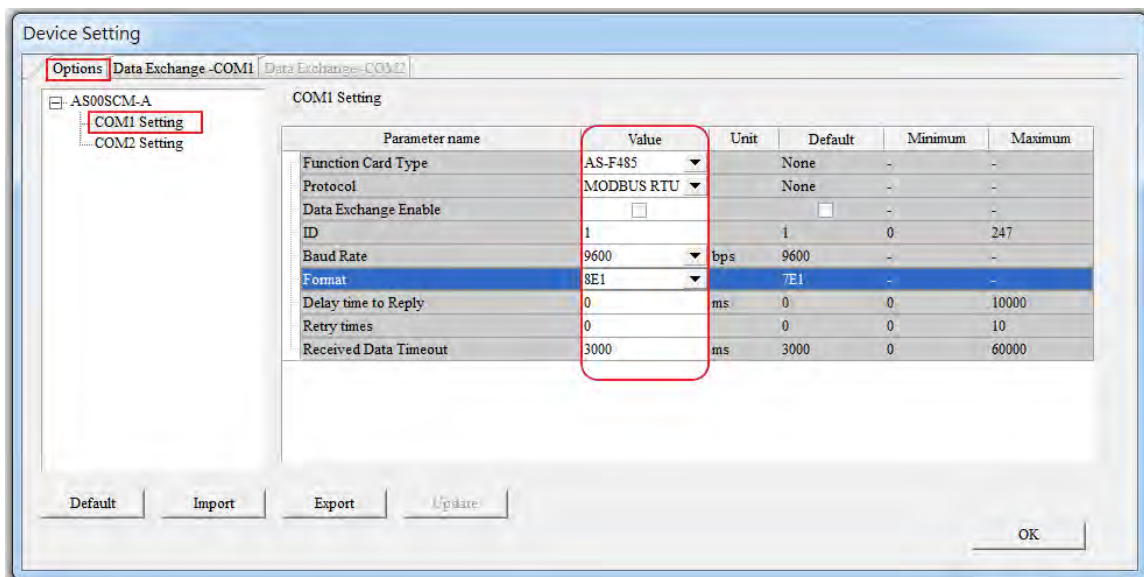

5) Click the Download button to download the parameters to the AS00SCM-A.

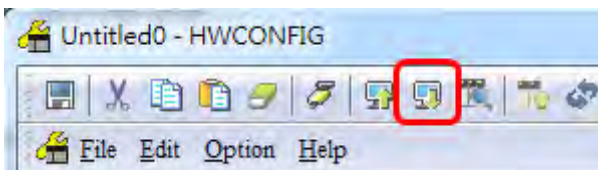

NOTE: Double-click the module to open the Device Setting dialog box to configure the parameters.

9.6.1.2 Modbus Master – Connection to Delta Products

This section introduces how to use COM2 to connect the AS00SCM-A to other Delta industrial products such as programmable logic controllers, AC motor drives, and servo motors.

The structures:

Example of a master structure: AS-F485 + AS00SCM-A COM2 (master station) → VFD, ASDA, and DVP series PLC

Product	Slave ID	Communication protocol	Device from which data is read	Register in the CPU module	Device into which data is written	Register in the CPU module
VFD	10	38400, ASCII, 7, E, 1	16#2103	D26200	16#2000 16#2001	D26300- D26301
ASDA	11	38400, ASCII, 7, E, 1	16#0101	D26210	16#0101	D26310
PLC	12	38400, ASCII, 7, E, 1	D100-D109	D26220- D26229	D200-D204	D26320- D26324

If the AS00SCM-A is functioning as a Modbus master, you need to set a slave ID and baud rate.

- 1) Drag to add AS00SCM-A in the system configuration area. Make sure the knob of AS00SCM-A is turned to COM mode and power connected to it.

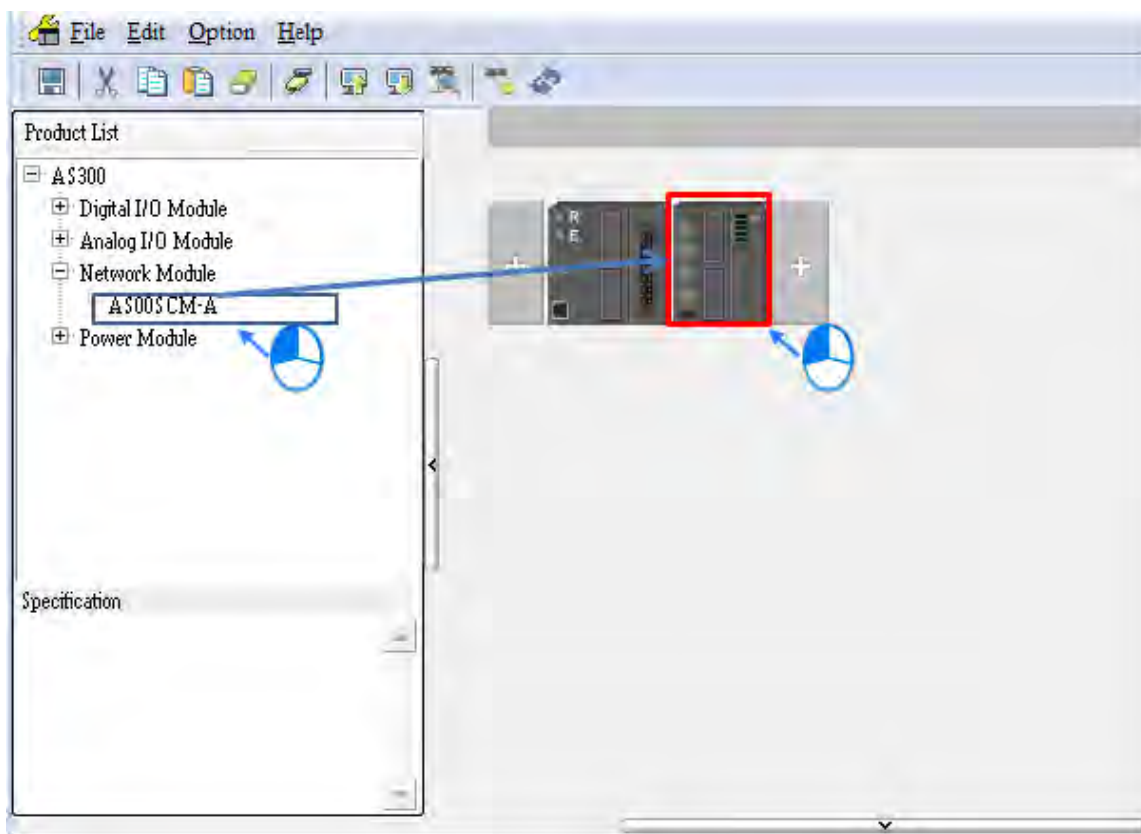

- 2) Double-click **COM2 Setting** and set the Function Card Type to **AS-F485**.

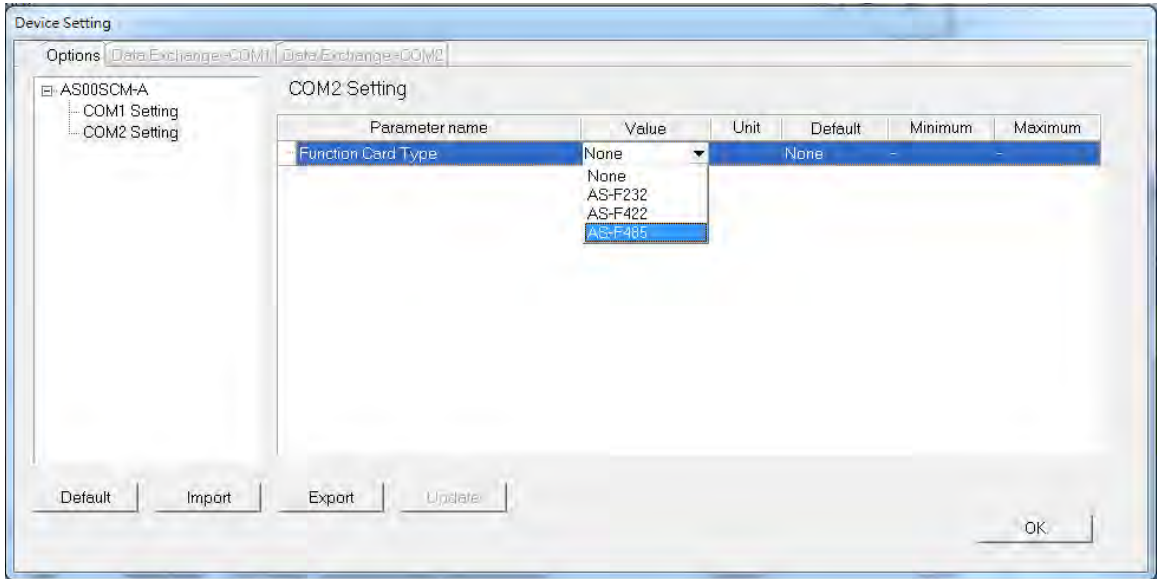

- 3) Click the I/O Scan button to make the system read the module's current configuration. The PLC assigns the input and output device ranges.

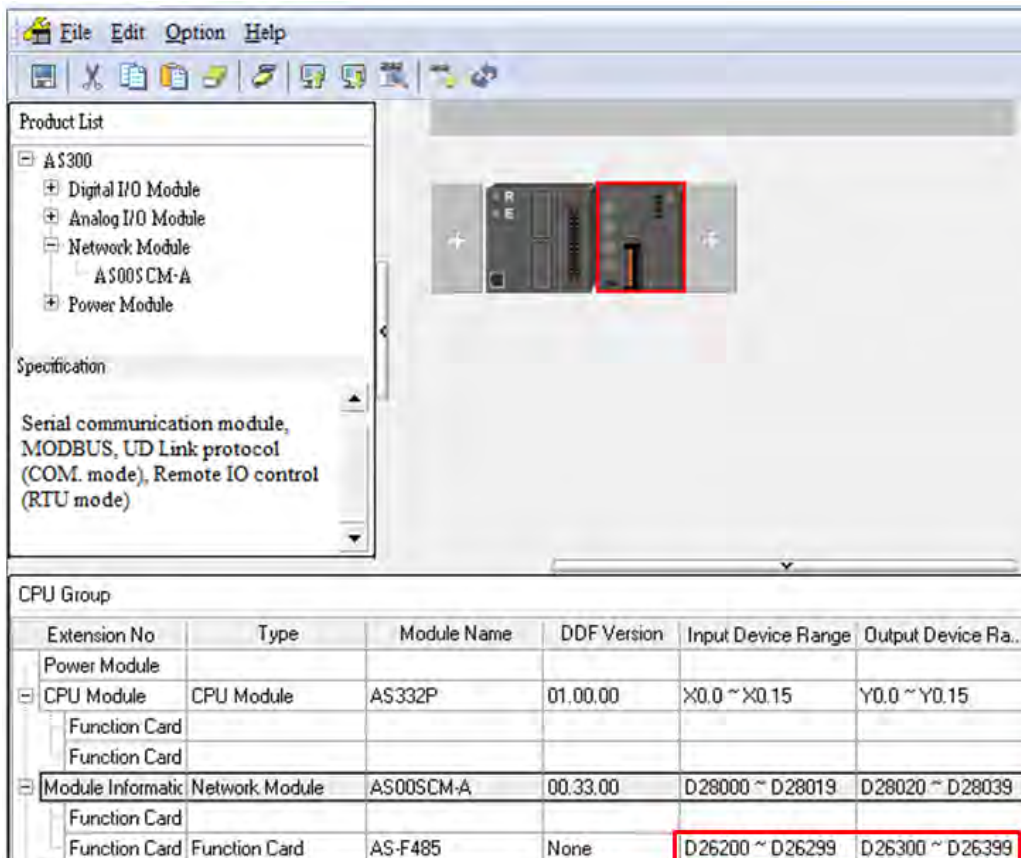

4) Double-click the SCM module to open the configuration settings.



5) Set the communication protocol values for COM2:

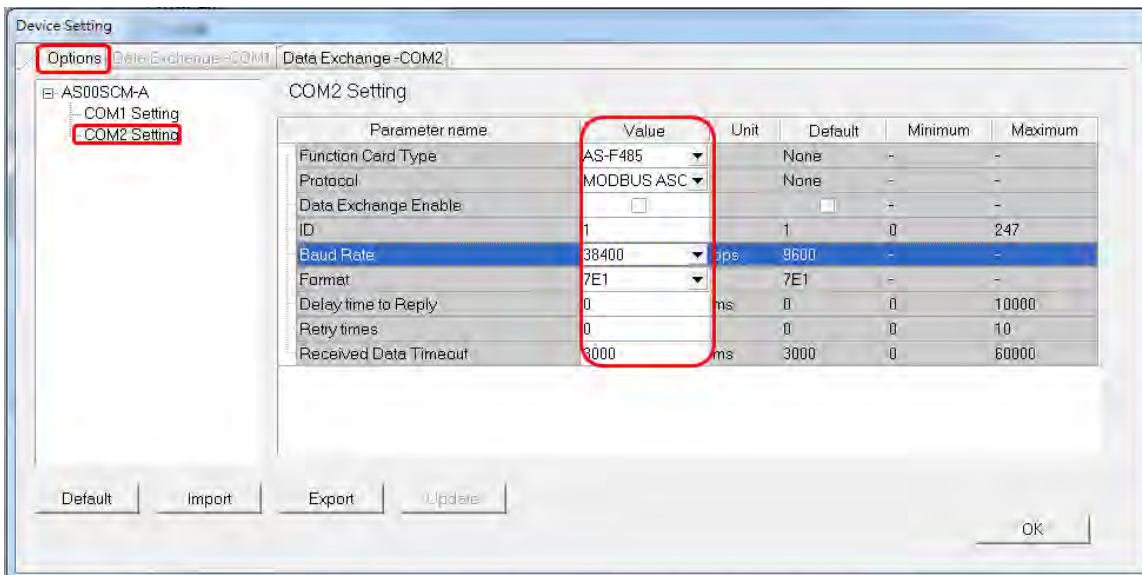

- 6) Set up the data exchange table: select **Data Exchange – COM2** and click **Add** to create a new Data Exchange Setup table.

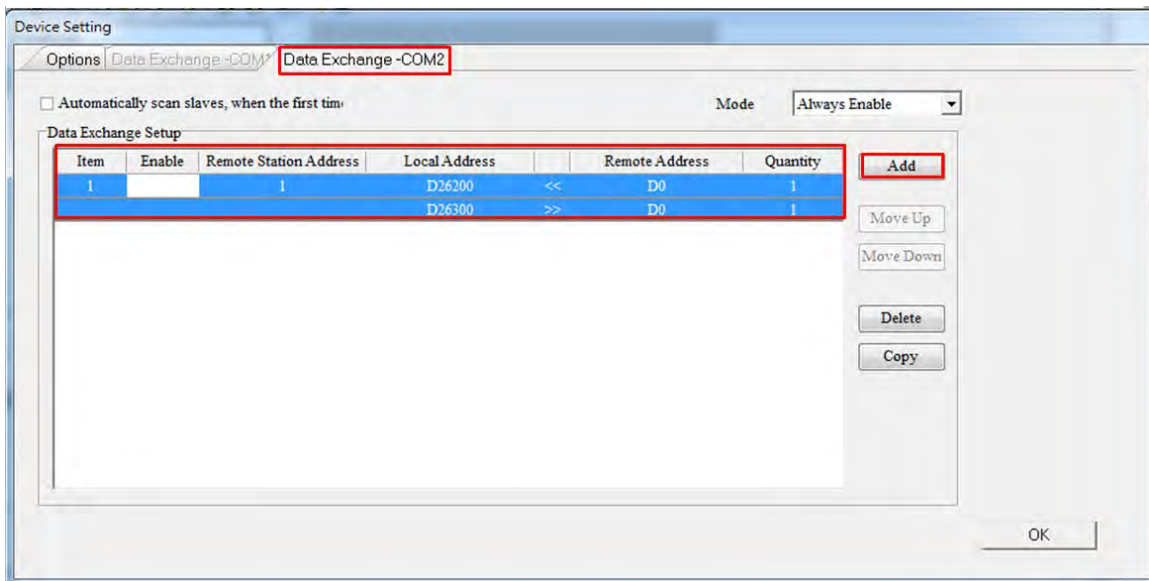

- 7) In the Data Exchange Setup table double-click an item to edit its settings.

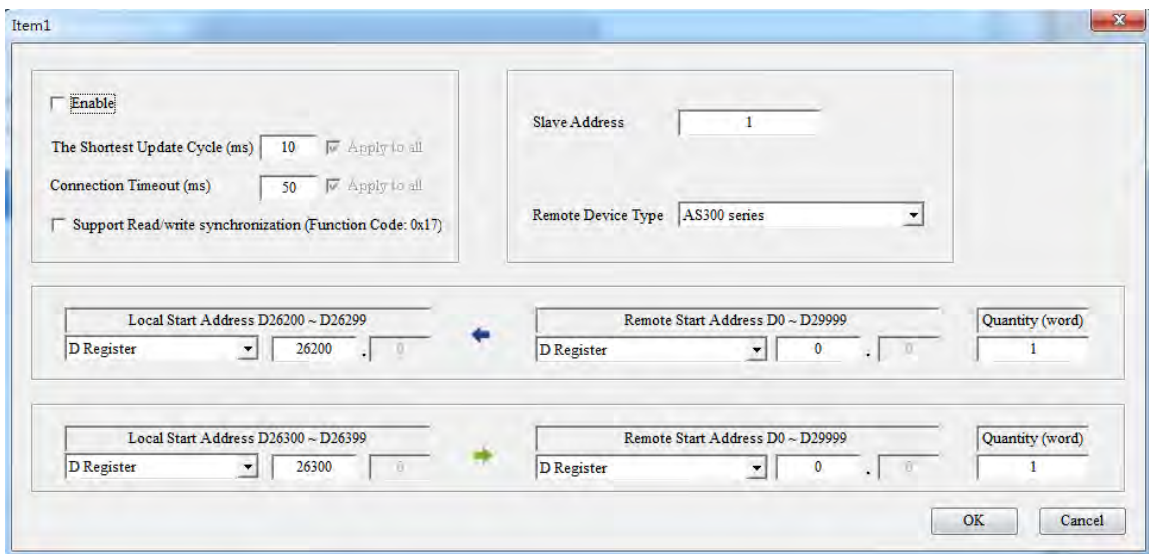

- Select **Standard Modbus Device** as the **Remote Device Type**, enter the parameters, and check **Enable**.

Product	Slave ID	Communication protocol	Device from which data is read	Register in the CPU module	Device into which data is written	Register in the CPU module
VFD	10	38400, ASCII, 7, E, 1	16#2103	D26200	16#2000 16#2001	D26300- D26301

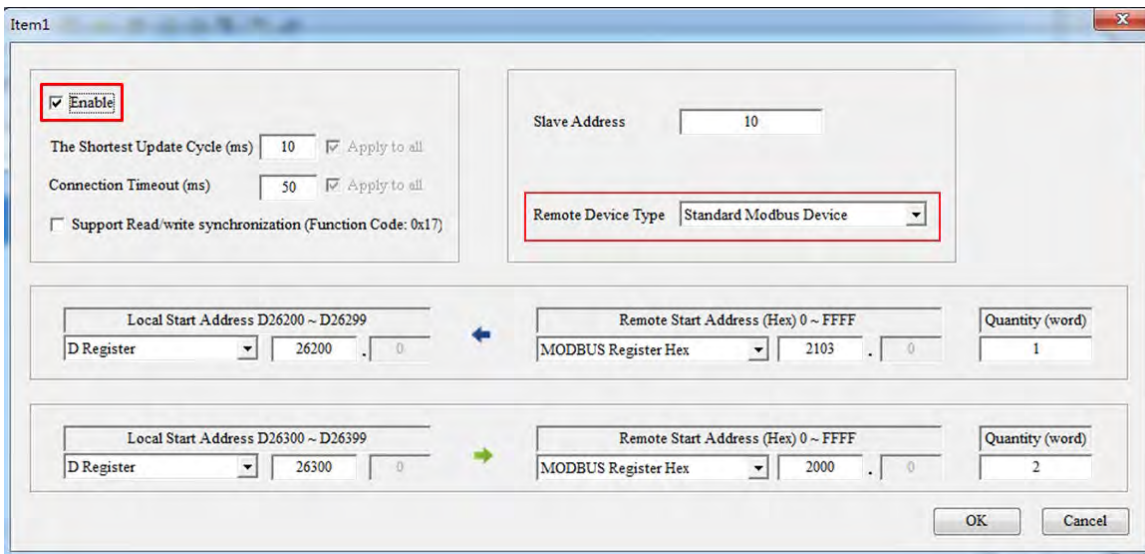

- Select **Standard Modbus Device** as the **Remote Device Type**, enter the ASDA parameters, and check **Enable**.

Product	Slave ID	Communication protocol	Device from which data is read	Register in the CPU module	Device into which data is written	Register in the CPU module
ASDA	11	38400, ASCII, 7, E, 1	16#0101	D26210	16#0101	D26310

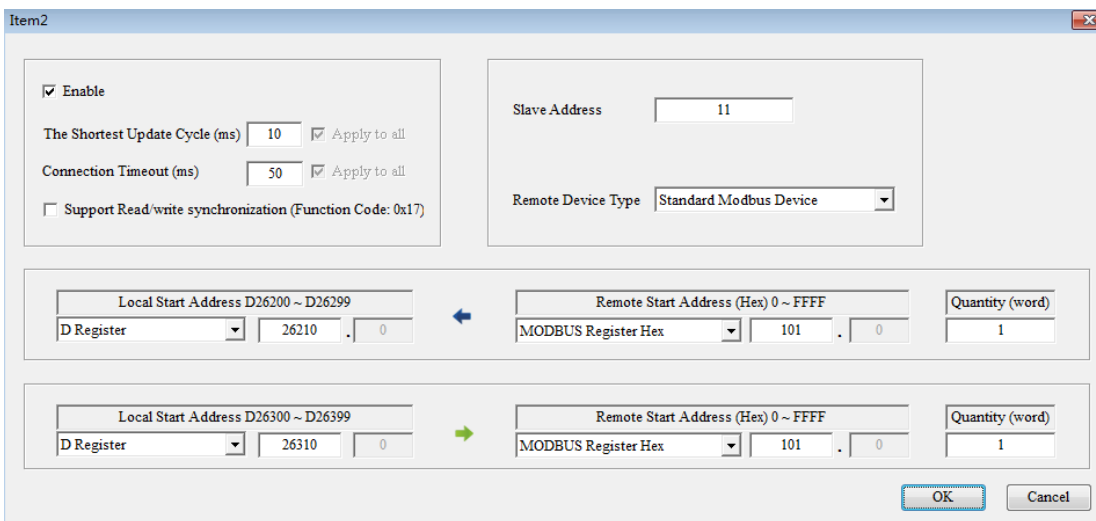

- Select **PLC devices** as the **Remote Device Type**, enter the PLC parameters, and check **Enable**.

Product	Slave ID	Communication protocol	Device from which data is read	Register in the CPU module	Device into which data is written	Register in the CPU module
PLC	12	38400, ASCII, 7, E, 1	D100-D109	D26220-D26229	D200-D204	D26320-D26324

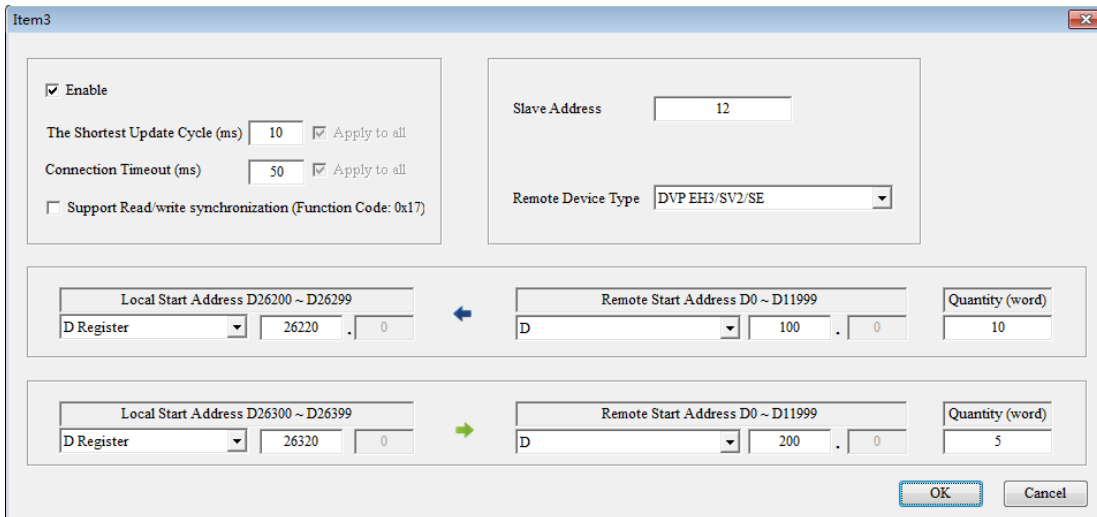

8) Select **Always Enable** in the Mode.

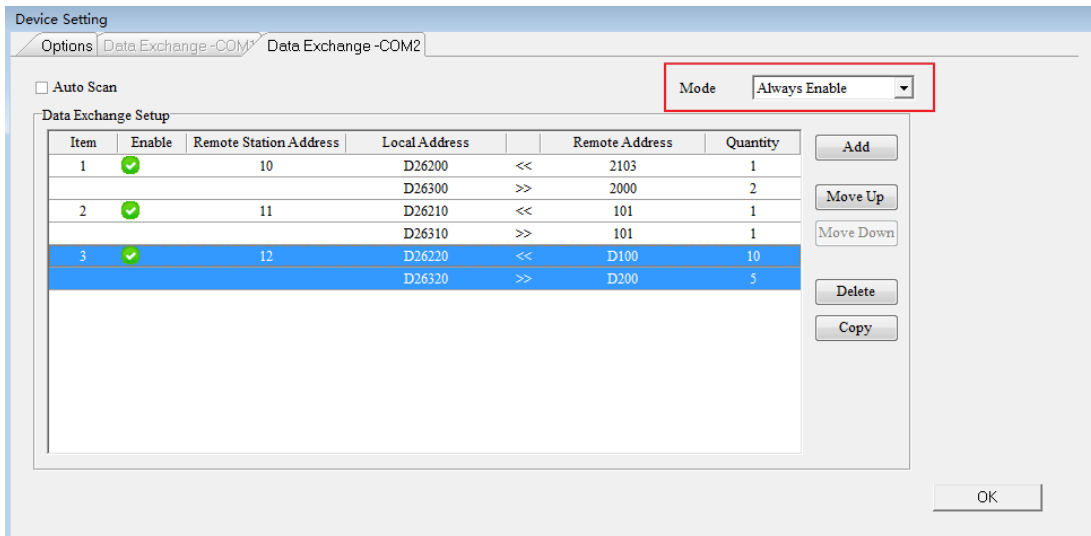

NOTE: If the Data Exchange Mode Control is set by the program, you can check and control the register address on the Normal Exchange Area page. The following example shows when writing "2: always" to D28021, it indicates Card 2 is always the one to perform data mapping.

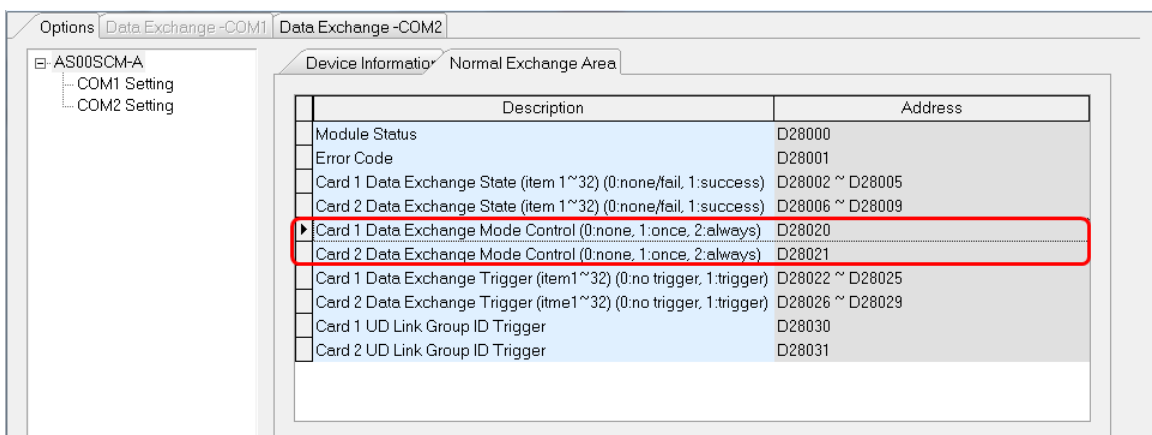

9) Download the parameters to the AS00SCM-A.

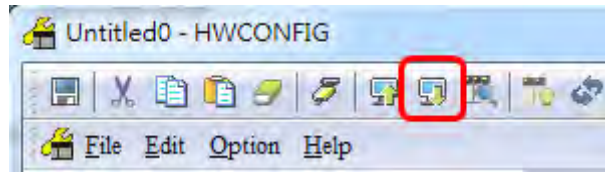

If you set Mode to Always Enable, the data exchange begins immediately after downloading the parameters.

If you set Mode to Program Control, the program starts the data exchange after downloading the parameters.

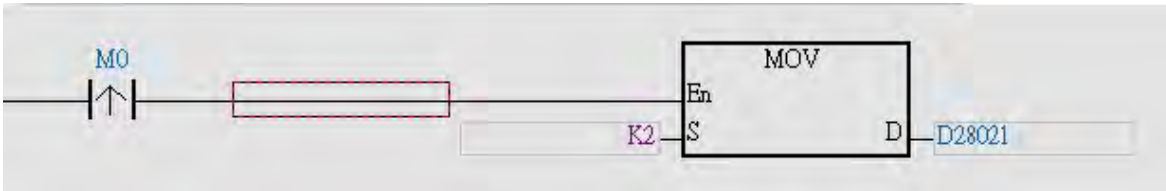

9.6.2 UD Link

This section introduces how to use a non-Modbus RS485 communication port on the AS00SCM-A to connect to other industrial products.

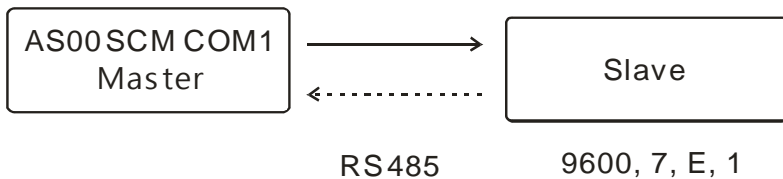

Communication with a slave

Packet to Send (→)	Packet to Receive (←)	Description
POS, xxx, yyy	POS, ACT	xxx and yyy are coordinates (0–999)

1) Drag to add AS00SCM-A in the system configuration area. Make sure the knob of AS00SCM-A is turned to COM mode and no power connected to it.

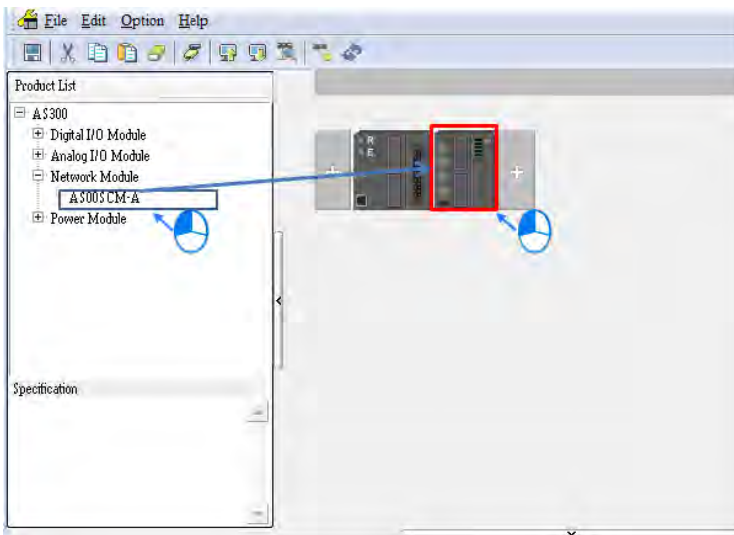

- 2) Double-click the SCM module to open the configuration settings.

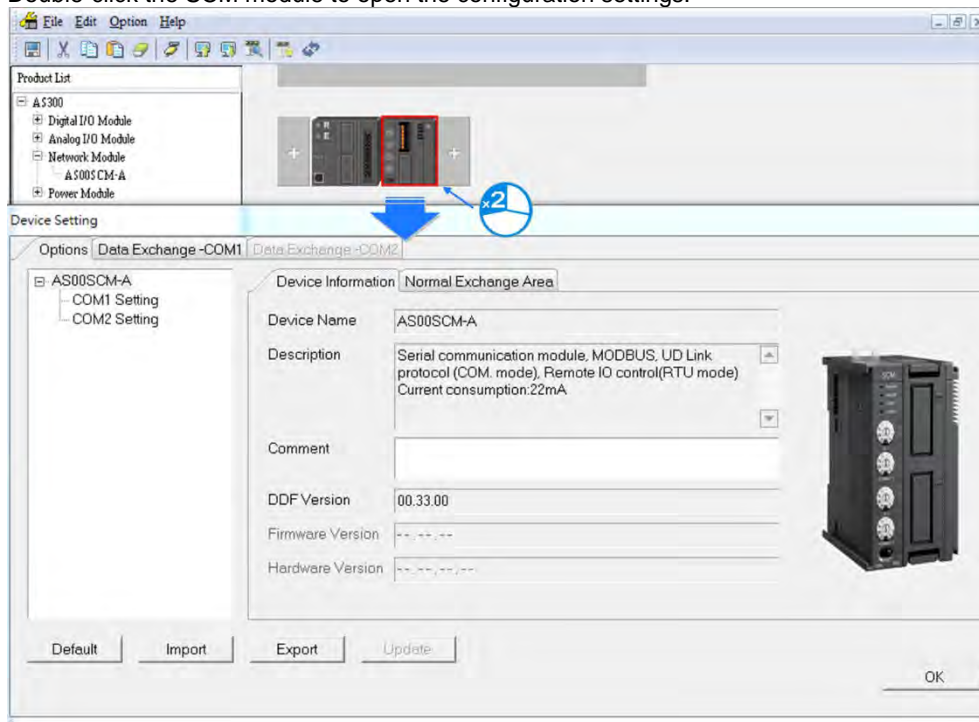

- 3) Select **AS-F485** as the **Function Card Type** for COM1.

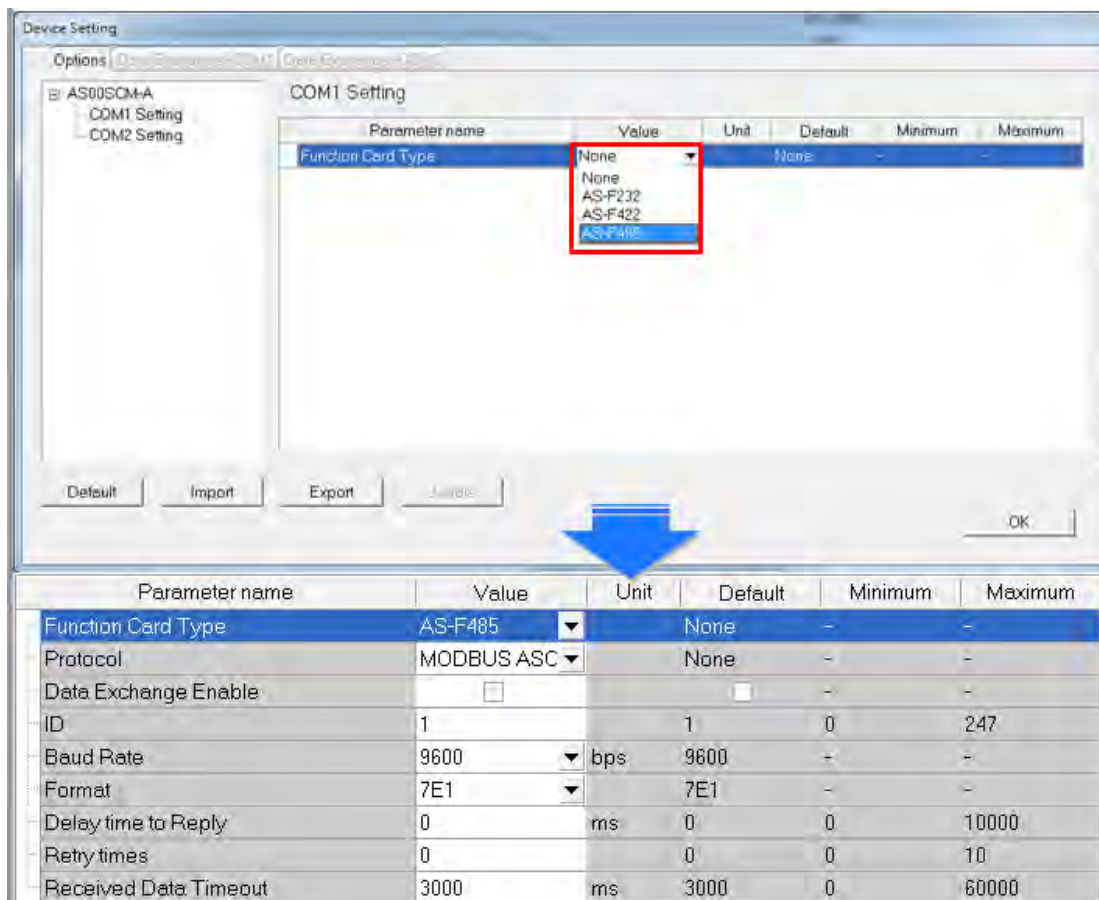

4) Select **UD Link** as the **Protocol**, set the **Baud Rate** and **Format**, and click **OK**.

Parameter name	Value	Unit	Default	Minimum	Maximum
Function Card Type	AS-F485		None	-	-
Protocol	UD LINK		None	-	-
Baud Rate	9600	bps	9600	-	-
Format	7E1		7E1	-	-

5) Right-click the AS00SCM-A and click **Communication Software** and then click **SCMSOft**.

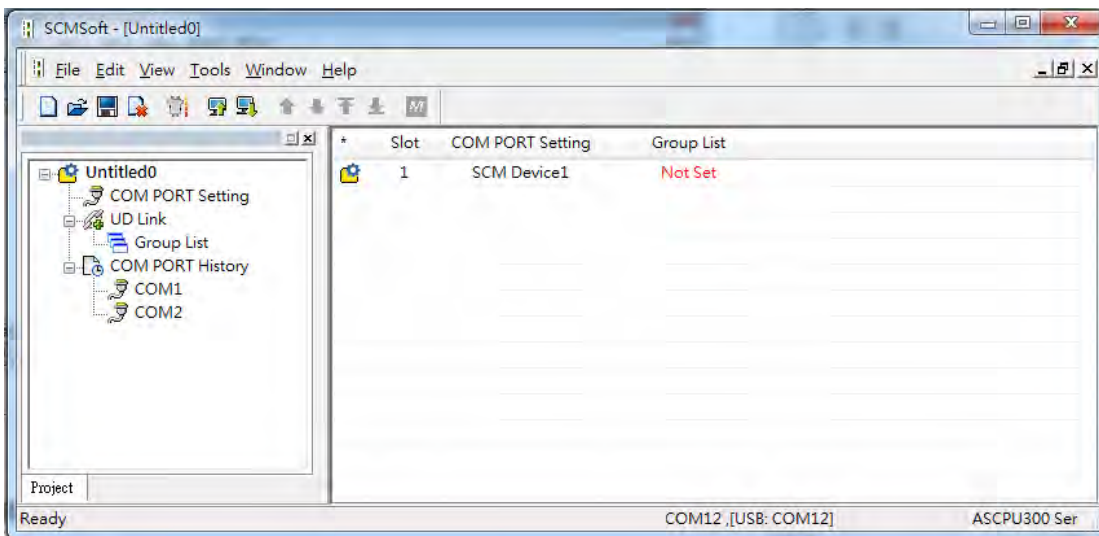
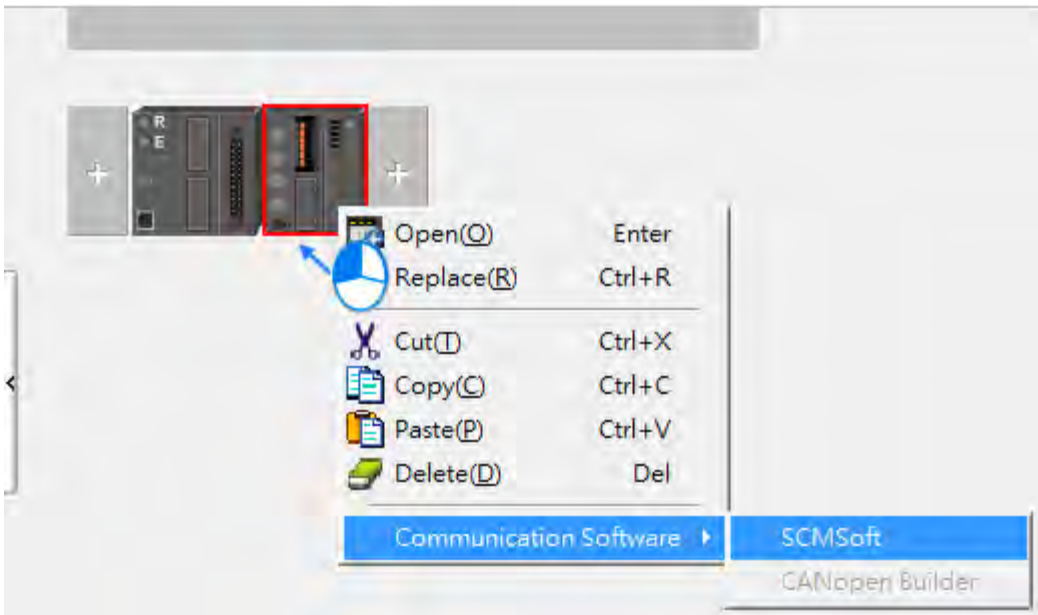

- 6) Right-click **Group List** and then click **Create Group List** to create a group list.

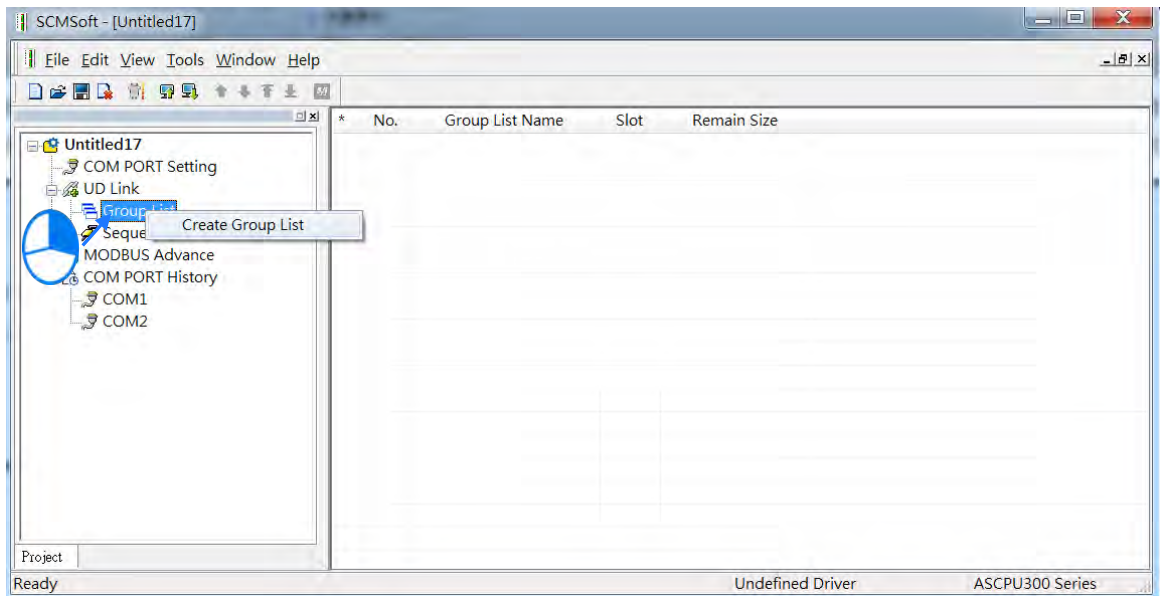

- 7) You can find a created Group List1. Double-click it to open an editing window to edit the Group List Name and the Slot.

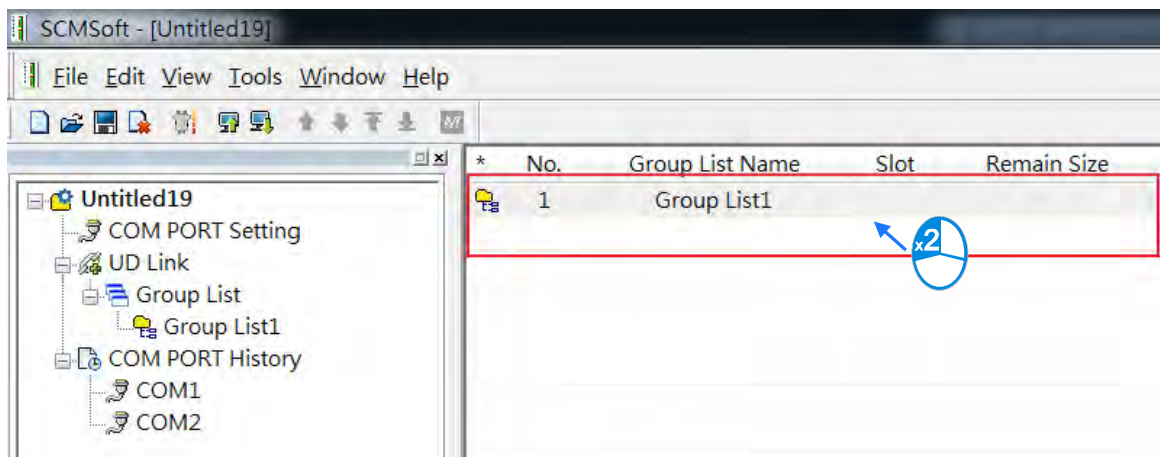

Give the group list a Name (this example uses "Slave_Simulation") and select 1 (COM1) as the **Slot** number.

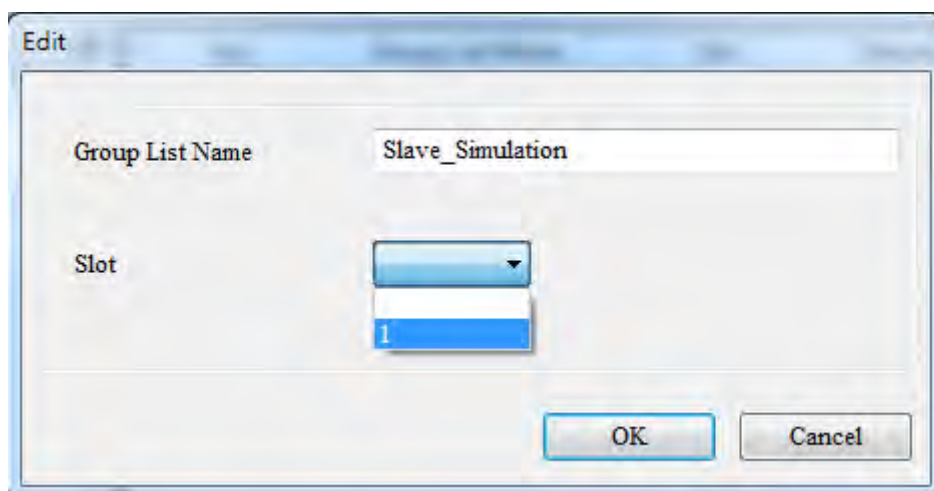

- 8) Right-click **Slave_Simulation** and click **Create Group List** to create a group list for the Slave_Simulation group.

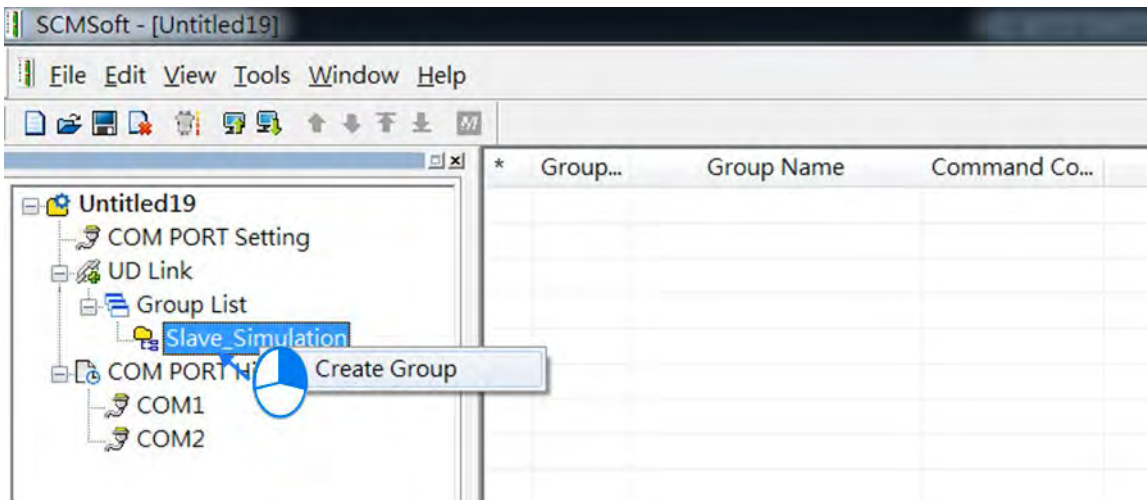

- 9) You can find a created Group List1. Double-click it to open an editing window to edit the Group List Name and the Slot.

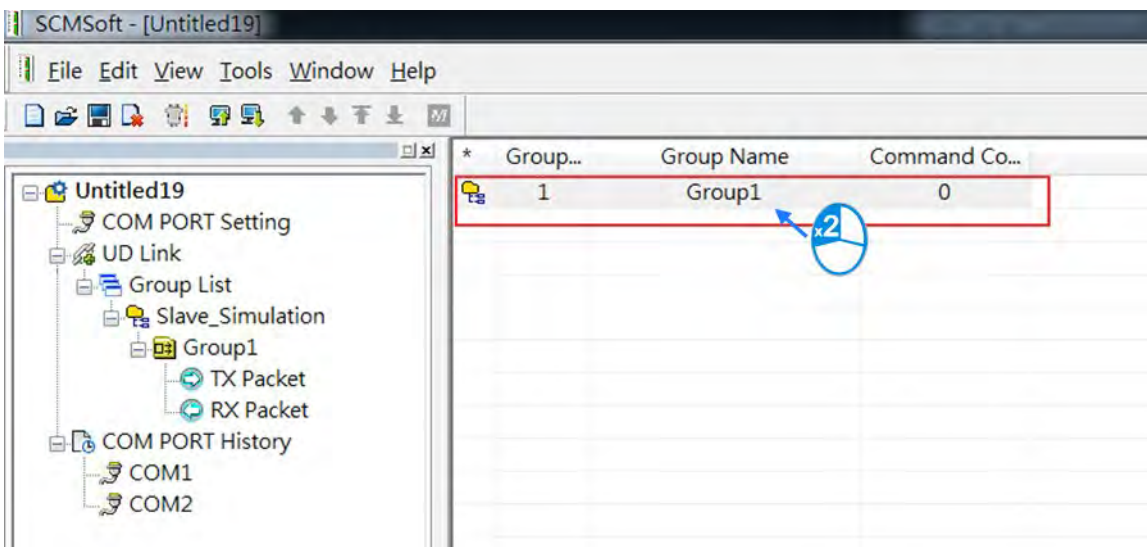

Create a group and name it "Master Send".

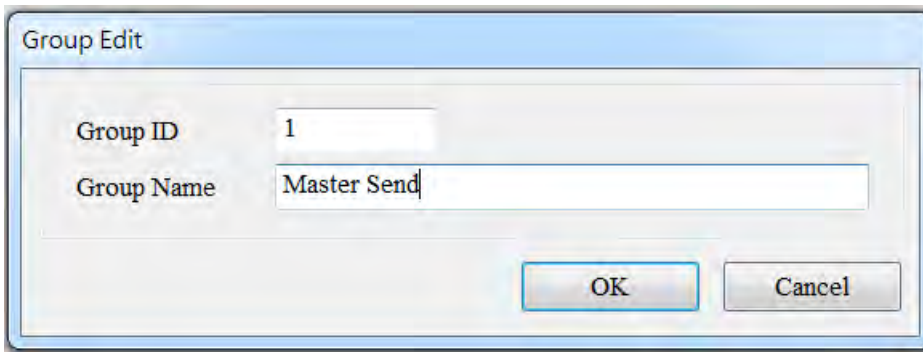

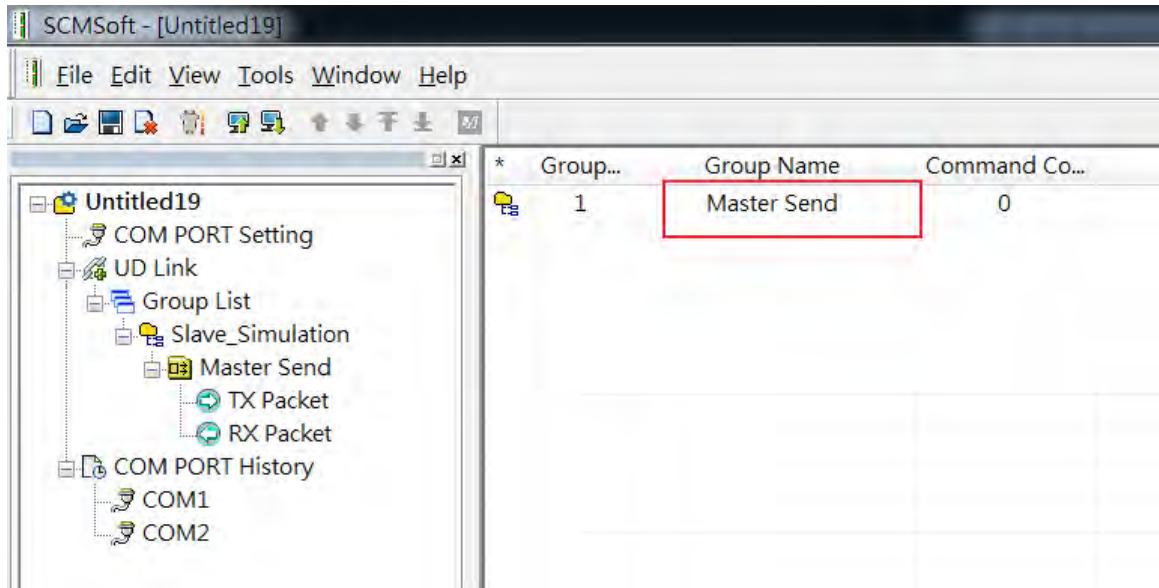

- 10) Right-click **TX Packet** and click **TX Packet** to create a TX Packet1.

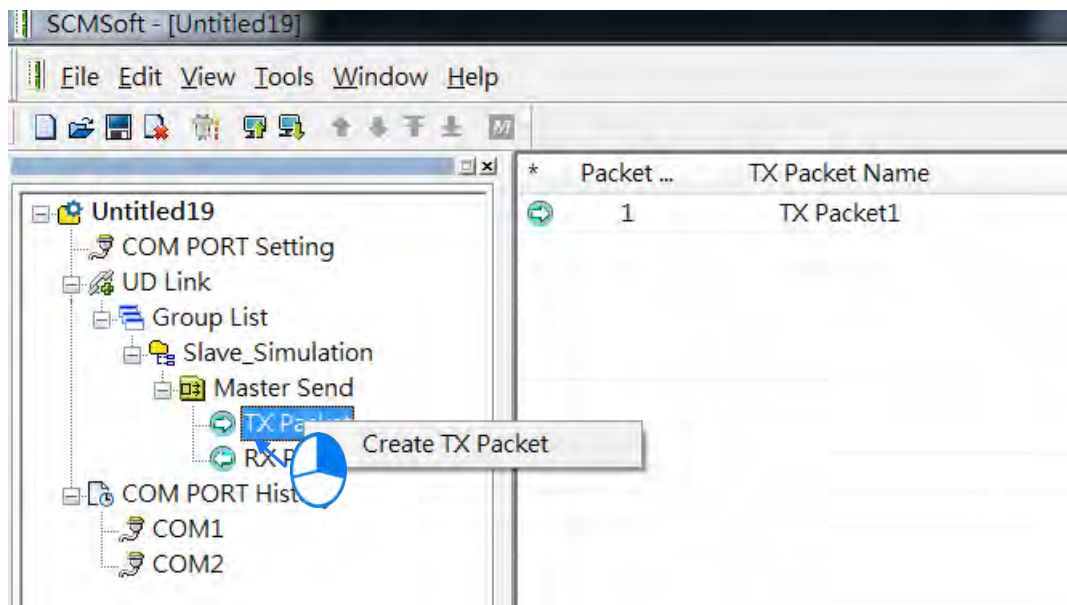

11) Double-click **TX Packet1** to open the **Packet Edit** form.

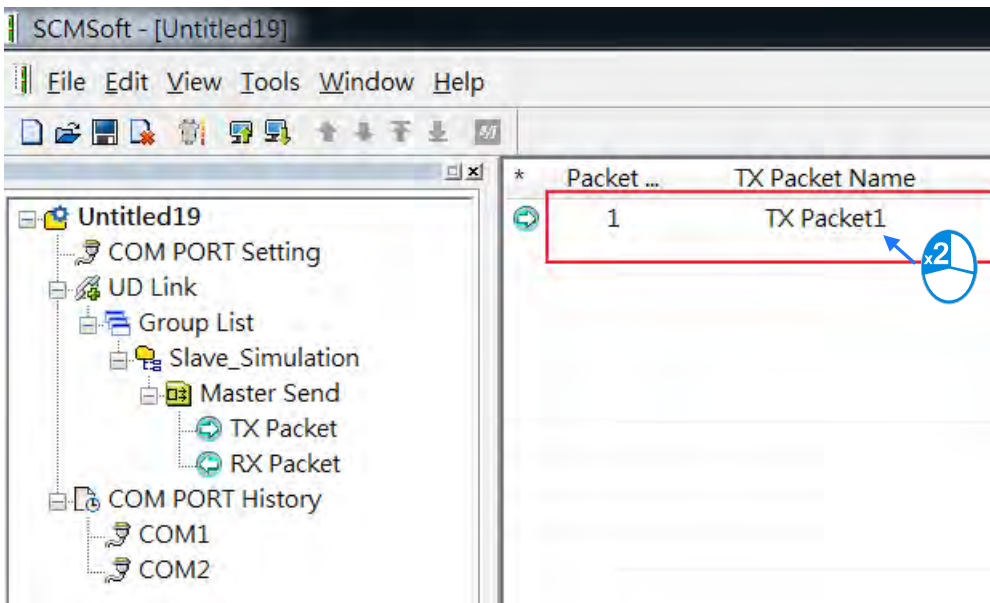

12) Give the Packet a Name (This example uses “TX POS Send”)

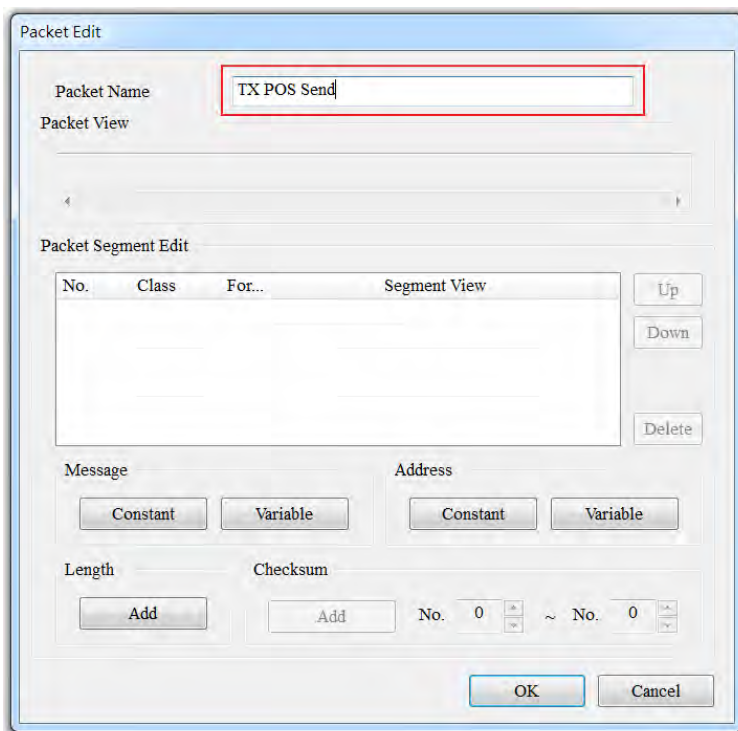

- 13) Edit the TX packet, "POS, xxx, yy" (The example below uses POS, 123, 123)
- 14) Click **Constant** in the Message area.

Packet Edit

Packet Name: TX POS Send

Packet View:

Packet Segment Edit:

No.	Class	Format	Segment View
-----	-------	--------	--------------

Message: **Constant** Variable

Address: Constant Variable

Length: Add sum

No. 0 ~ No. 0

OK Cancel

Enter "POS" in the Value area. Click **OK** and verify the packet contents in the Packet View.

Message Constant Edit

Format: ASCII

Value: POS

OK Cancel

- 15) [xxx] is a variable, so click **Variable** in the Message area to edit it. Use ISPSOft to get the value from data registers D26100–D26101. The example below uses D26100: 16#3132 and D26101: 16#3300 and the value is 123.

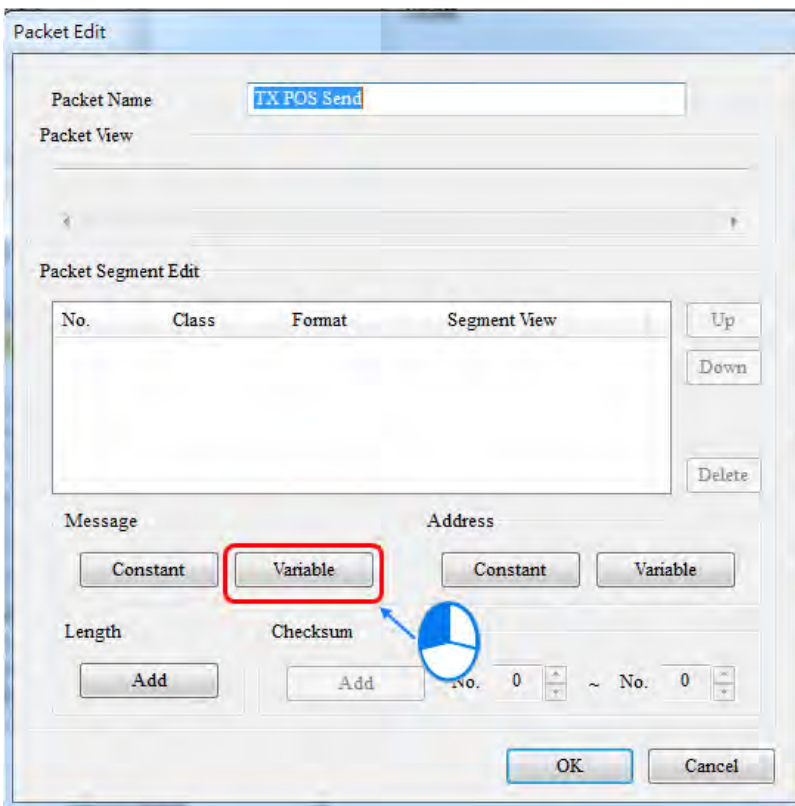

- 16) Enter the data register that contains the value you want to find. The example below uses D26100 and the value returned is 3. Use ISPSOft to get the value from data registers D26100–D26199.

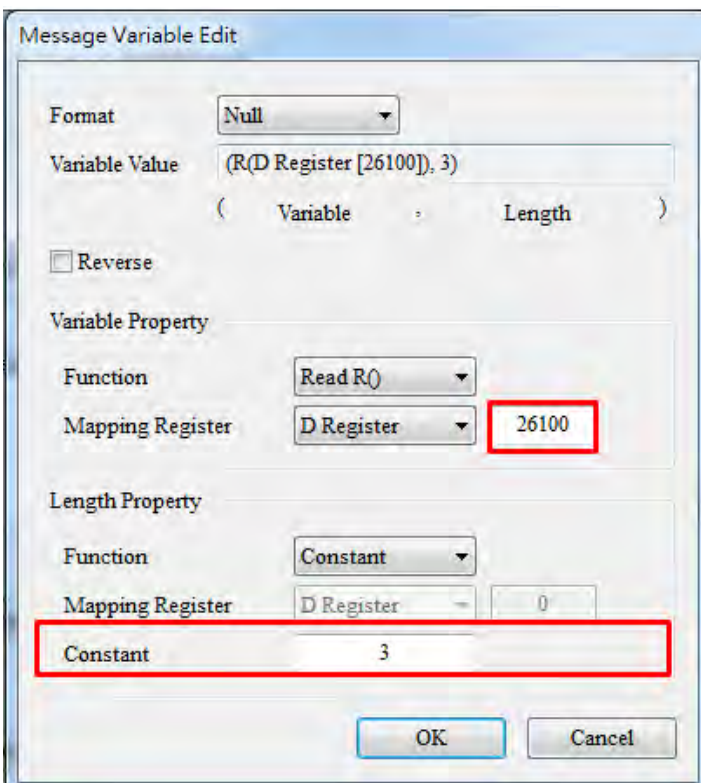

9

Click **OK** and verify the values ("POS,"+ (R (D Register [26100], 3)) in the Packet View.

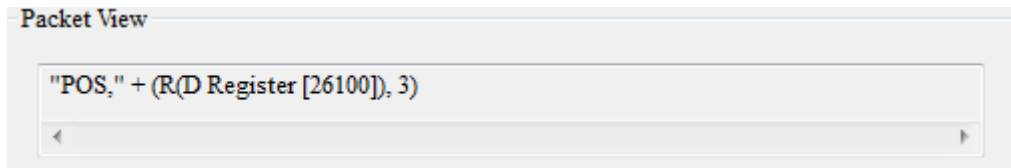

17) [·]: Use Address Constant to enter this Value and set the Format to ASCII.

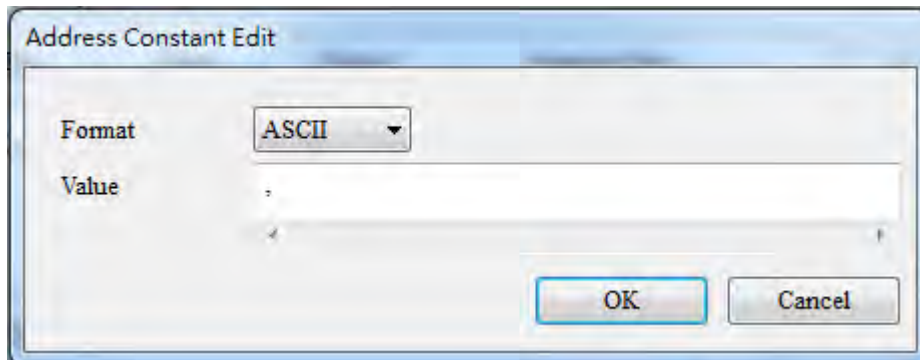

Click OK and verify the values ("POS,"+ (R (D Register [26100], 3)) in the Packet View.

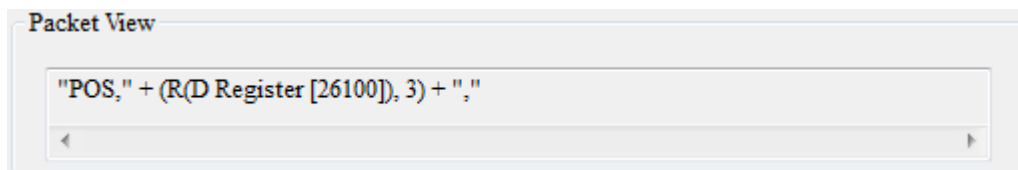

18) [yyy] is a variable, so click **Variable** in the Message area to edit it. Use ISPSOft to get the value from data registers D26102–D26103. The example below uses D26102: 16#3132 and D26103: 16#3300 and the value is 123.

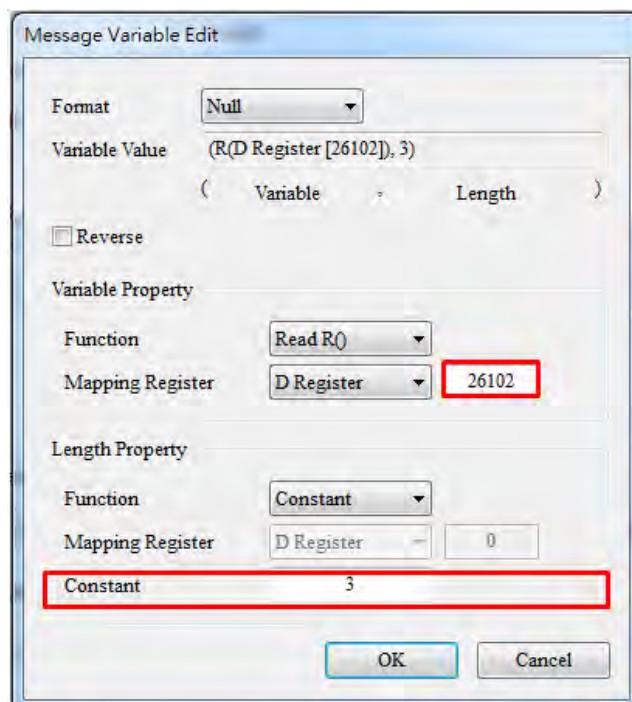

- 19) Enter the data register that contains the value you want to find. The example below uses D26102 and the value returned is 3. Use ISPSoft to get the value from the data registers D26100–D26199.

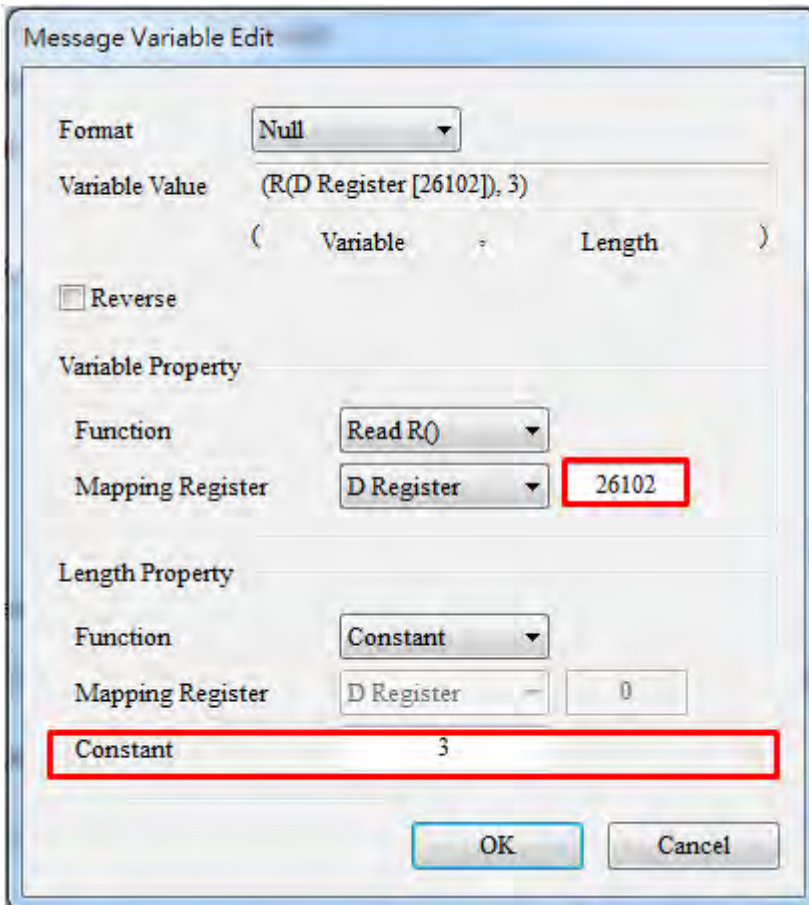

Click **OK** and verify the values ("POS,"+ (R (D Register [26102], 3)) in the Packet View.

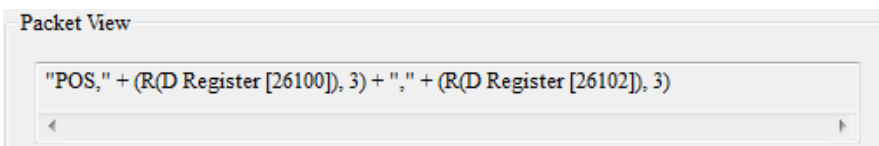

- 20) Edit the packet: Create a packet and name it "RX Result". Double-click it to open the editing window.

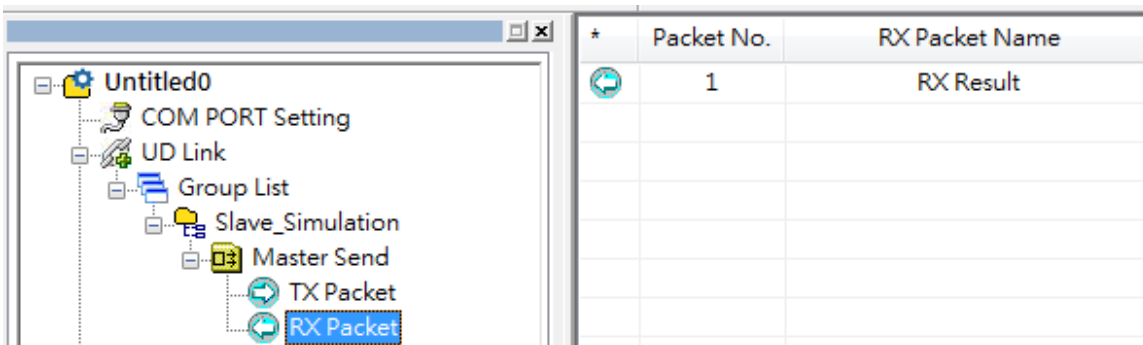

9

Enter the sending packet into the D26000 register of the AS300 CPU. "*" indicates that the length is not specified.

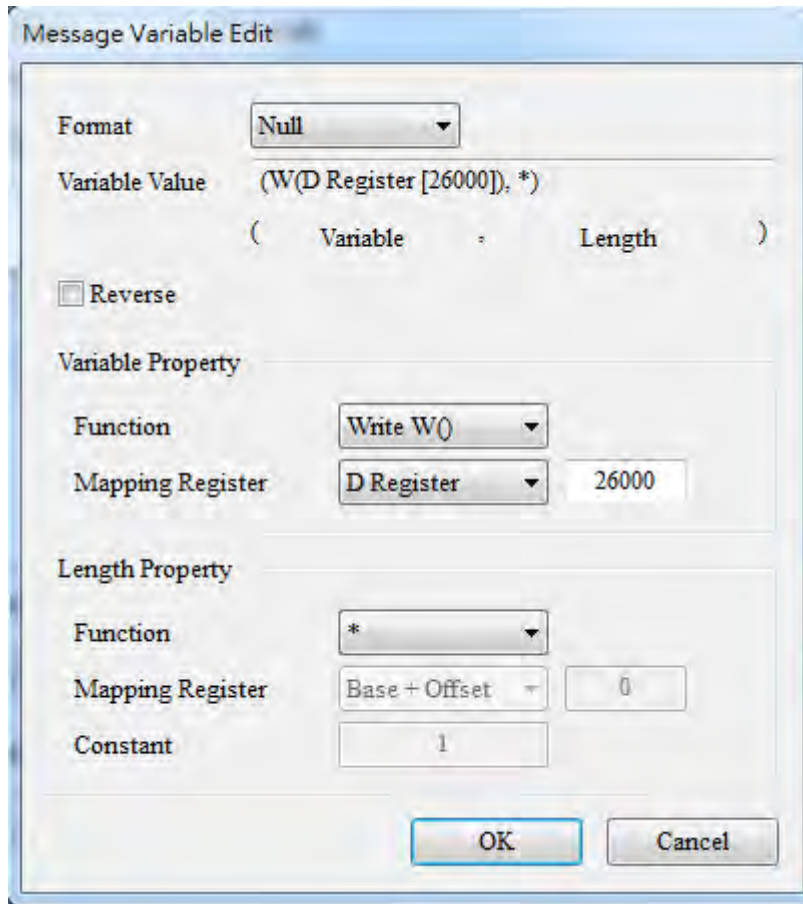

The packet should look like the example below.

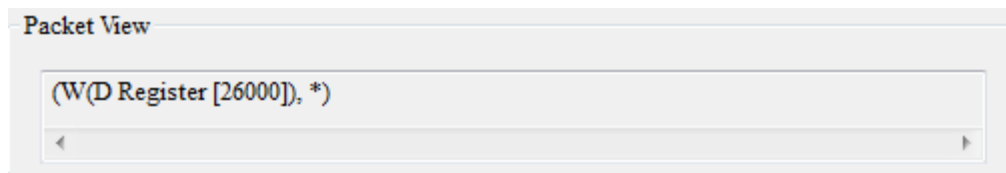

- 21) Create a command: Right-click **Master Send** and click the **Create Command**.

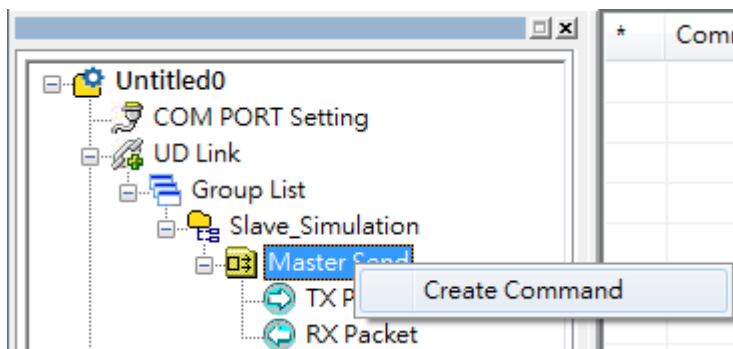

22) Double-click the new command on the list to open the Command Edit window.

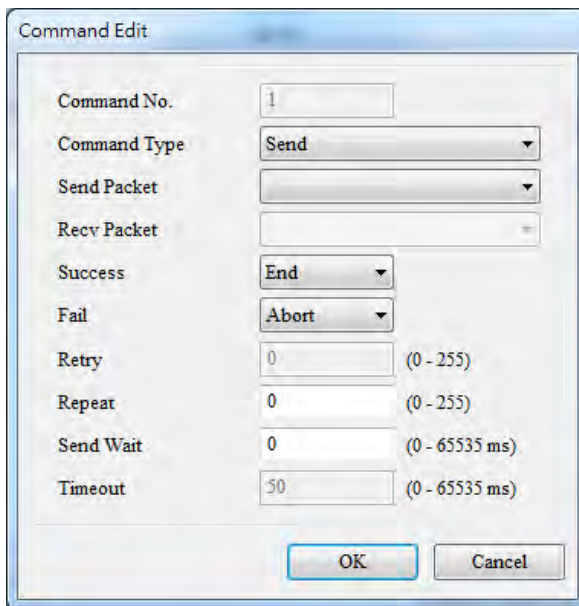
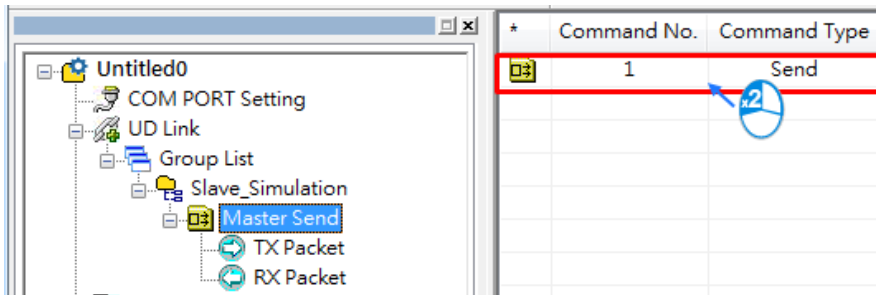

23) Set **Send Packet** to “TX POS Send” and set **Recv Packet** (received contents) to “RX Result”.

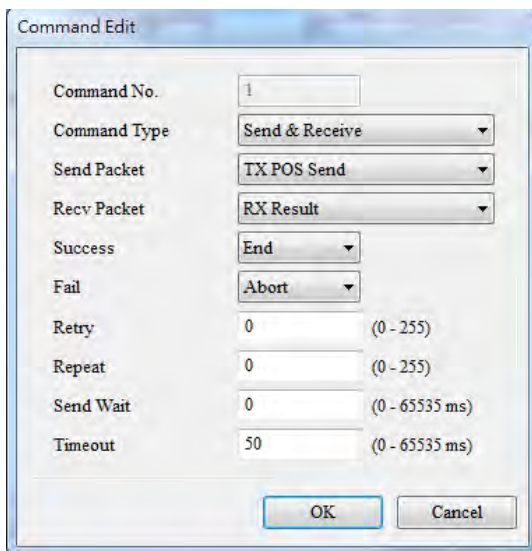

24) Make sure the Group is in slot 1 (COM1).

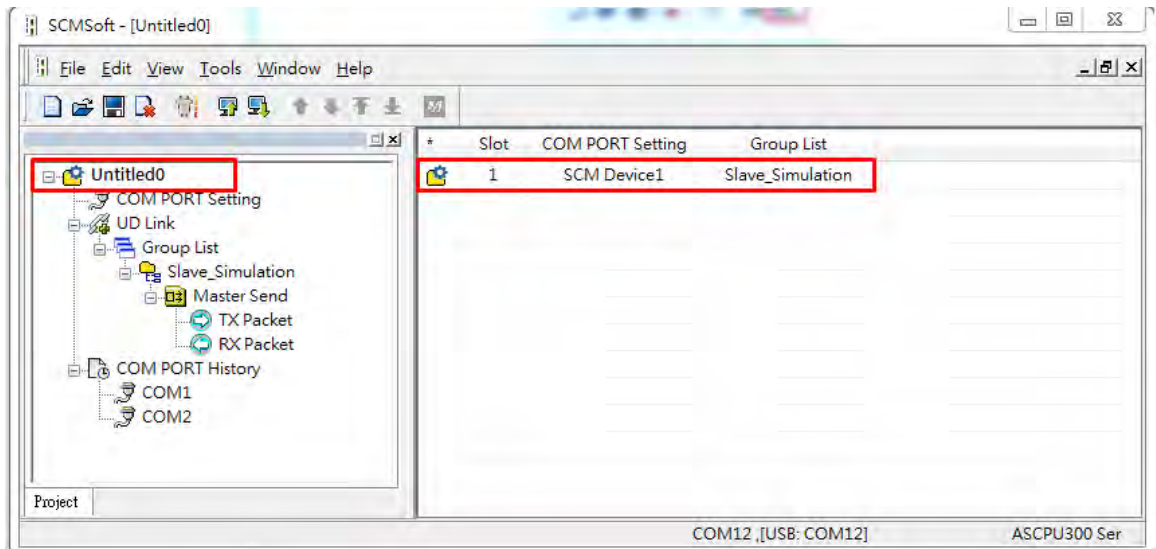

25) Click the Download button to download the parameters to the AS00SCM.

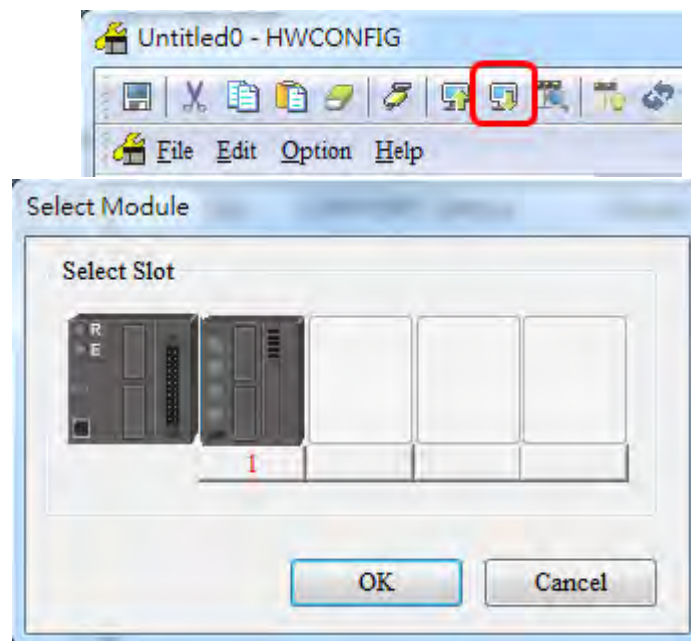

- 26) Set up the devices for the UD Link Group ID Trigger in HWCONFIG. Once you create the AS00SCM-A module, the system automatically assigns the corresponding addresses.

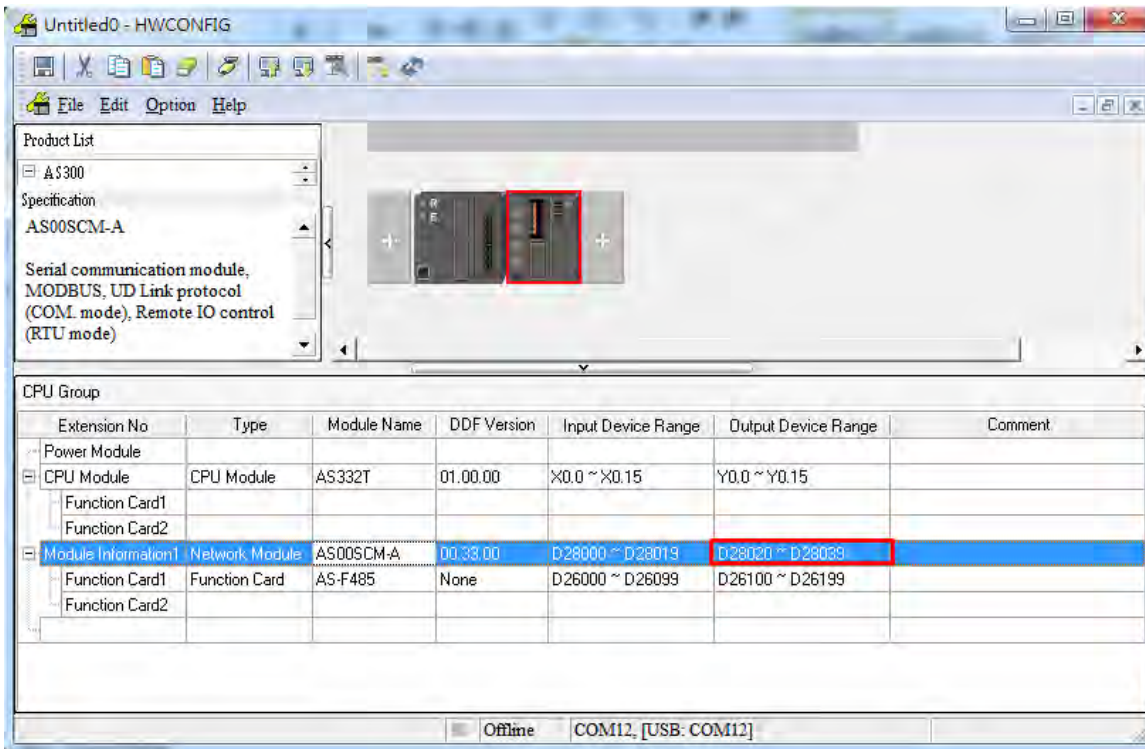

- 27) Double-click AS00SCM-A to open the Device Setting page. Verify that the Card 1 UD Link Group ID Trigger is set to D28030. Use ISPSOft to enter 1 into register D28030 to start the data exchange.

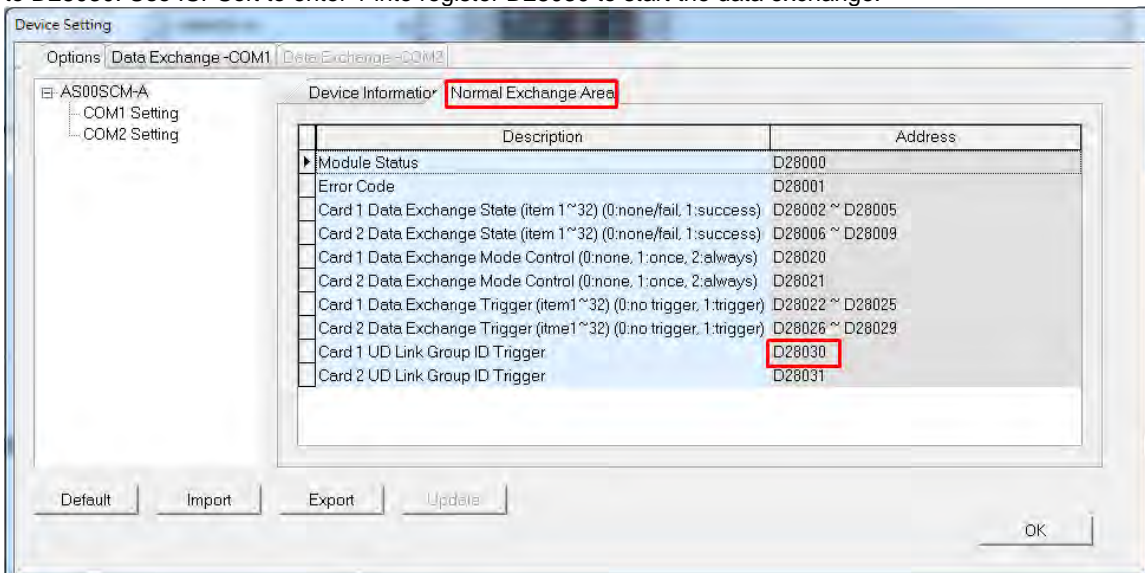

28) Use the monitor function in ISPSoft to verify that the transmission is working correctly.

D26100		12	123*	0.000	ASCII
D26101		3*	3*12	0.000	ASCII
D26102	Send	12	123*	0.000	ASCII
D26103		3*	3***	0.000	ASCII
D26000		PO	POS,	740081729536.000	ASCII
D26001	Receive	S,	S,AC	12.207	ASCII
D26002		AC	ACT*	2203402895360.000	ASCII
D26003		T*	T***	0.000	ASCII

29) In SCMSOft, right-click the item COM PORT History on the left and click the option “Upload COM History Data” to see the transmission history of COM1 and COM2 respectively. Under the item COM1 and COM2, you can view recent transmission history; however the shown recent history cannot be deleted or saved.

30) Select *Tools -> Return to Default* to clear the previous settings and have all the settings back to defaults. After this, turn the power off and on again.

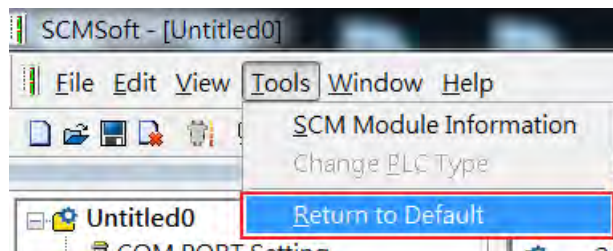

9.6.3 Remote IO Application (AS-FCOPM)

This example shows other series PLC, AH10COPM-5A, as a CANopen Master that controls four IO modules on the right side of AS00SCM-A that acts as a CANopen Slave. (You can use this method to connect to a 3rd party PLC.)

Device	Function
AS300	Scan and download AS00SCM-A (RTU mode), right side module configurations
AS00SCM-A + AS-FCOPM	CANopen Slave
AHCPU530-EN + AH10COPM-5A	CANopen Master
AS16AN10R-A	16 Digital outputs
AS16AM01N-A	16 Digital inputs
AS04DA-A	4 Analog channels for output
AS04AD-A	4 Analog channels for input

Step 1

Use AS300 to connect to AS00SCM-A through AS Remote Communication (RTU mode) and then use HWCONFIG to scan and download the parameters. If the Card 2 LED is blinking normally, with no error messages, and no need to download the PLC programs, the device power can be turned off. Refer to Section 9.4.1.1 for reference.

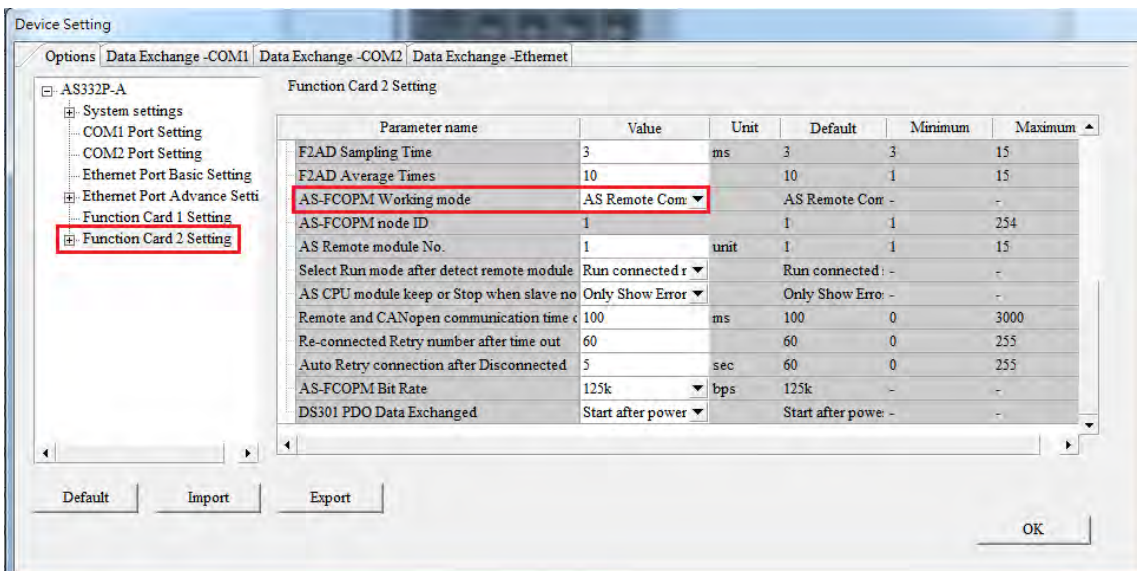
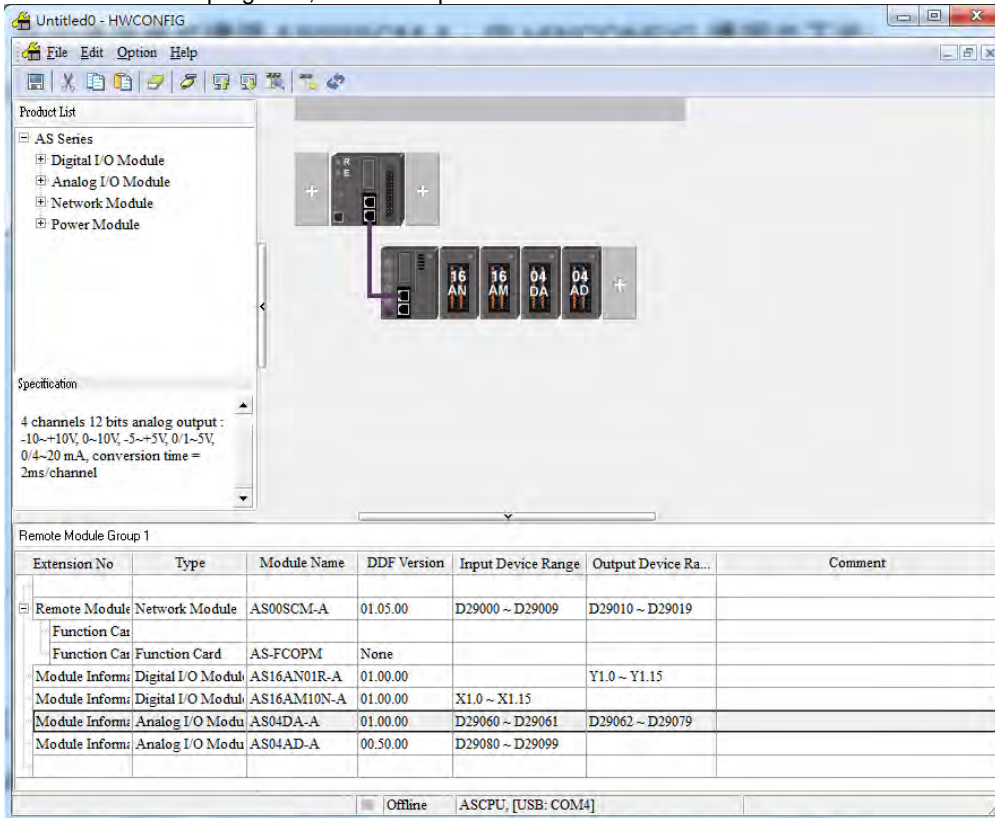

Step 2

Turn the Format 1 of AS00SCM-A to 4 (using CANopen DS301 mode) and turn Format 2 to 7 (setting the bit rate to 1000kbps) and then turn the power off and on again. After that wiring AH10COPM-5A and set the node ID to 2 and set the bit rate to 1000kbps. Use ISPSOft (V3.04 or later) and HWCONFIG to scan and download the parameters to AH500. Right click AH10COPM-5A and open **Intelligent Module Configuration** (CANopen Builder) from the menu.

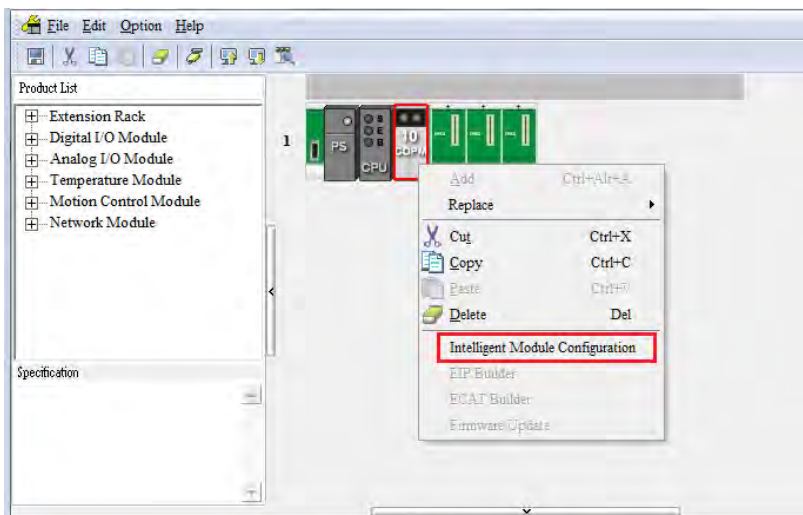

Step 3

Use CANopen Builder to scan the network. You should find Node ID 1 and its name to be AS00SCM-A RTU.

If not, check if you follow the first two steps right. And repeat the previous steps. Recommended to set the value in cycle period to 50 ms to ensure a more complete module functions. Double click the module to open the **Node Configuration** window and set up the PDO manually. RPDO is for DO/AO and TPDO is for DI/AI and error codes of RTU/IO.

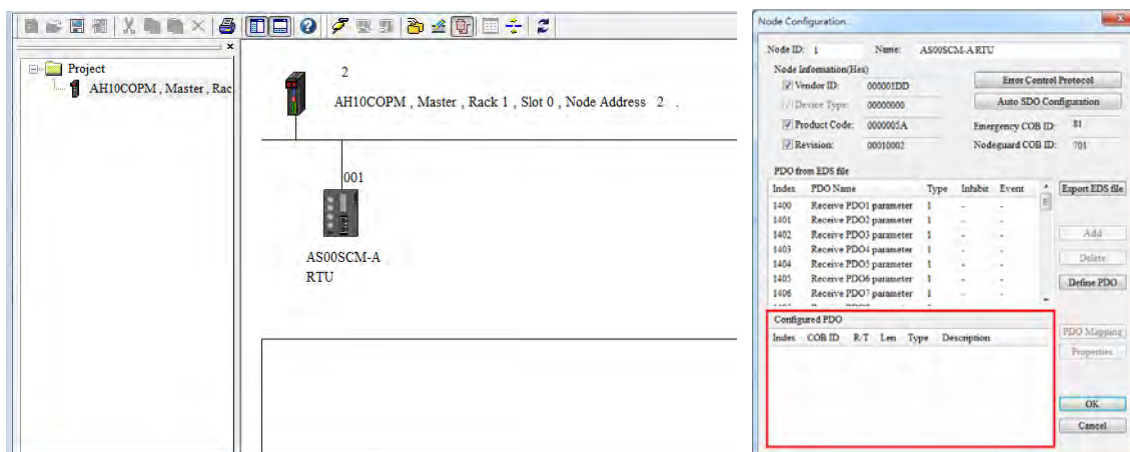

Step 4

Here uses a first right side digital output module (16 points) as an example.

1. Since it is the first one, here it corresponds to Receive PDO1 (index: 1400), indicating RTU receives data from Master through CANopen communication. (If this is an input module, it sends data to Master through CANopen communication.) Double click to add it in the table. Double click the table to open the PDO setting window.
2. Since it is the first one, here it corresponds to Rx_Module 1. It is a 16-point digital output module so that only the object of one word Rx_Module1_EDO0 (Index: 2000) should be selected. Click the arrow to add it into the data mapping parameter table and you have set up a PDO for the first module. If it is a 32-point digital output module, objects of 2 words Rx_Module1_EDO0 and Rx_Module1_EDO1 should be selected in numerical order.

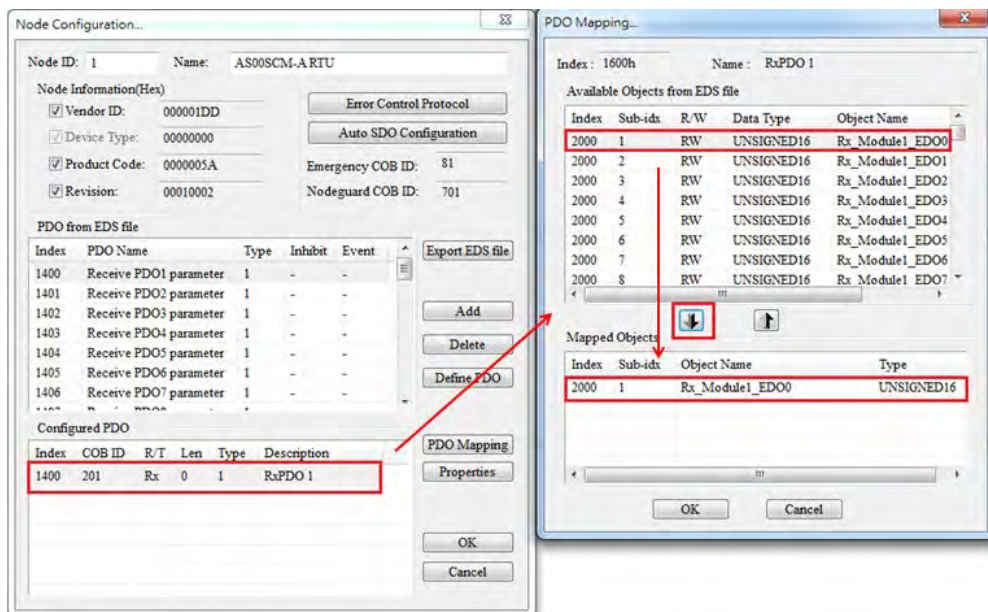

3. Follow the previous steps to set up more modules.

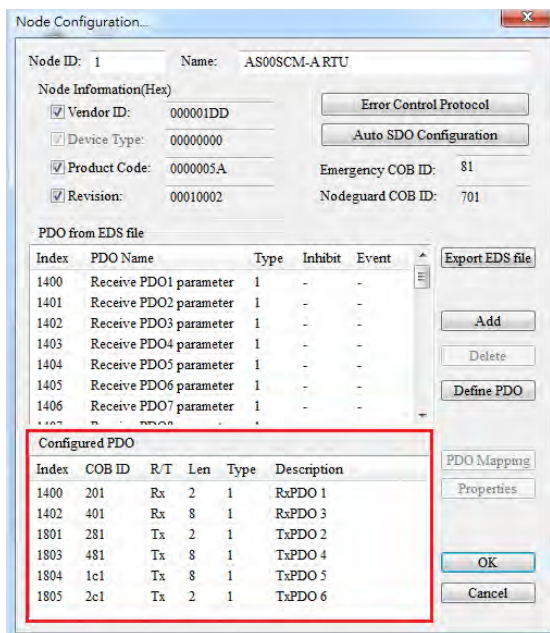

Device	Function	PDO	PDO Mapping	Mapping Registers
AS16AN01R-A	16 digital outputs	RxPDO1	Rx_Module1_EDO0	D6000
AS16AM01N-A	16 digital inputs	TxPDO2	Tx_Module2 EDI0	D5000
AS04DA-A	4 Analog channels for output (Integer format)*	RxPDO3	Rx_Module3_EDO0 Rx_Module3_EDO1 Rx_Module3_EDO2 Rx_Module3_EDO3	D6001 D6002 D6003 D6004
AS04AD-A	4 Analog channels for input (Integer format)*	TxPDO4	Tx_Module4 EDI0 Tx_Module4 EDI1 Tx_Module4 EDI2 Tx_Module4 EDI3	D5001 D5002 D5003 D5004
IO Module Error Code	-	TxPDO5	Tx_Module1_error_code Tx_Module2_error_code Tx_Module3_error_code Tx_Module4_error_code	D5005 D5006 D5007 D5008
RTU Error Code	-	TxPDO6	Tx_RTU_error_code	D5009

* Here the analog module uses integer format; if you need to use floating point format, two PDOs will be used per channel.

* Index 2002 to Index 200d are for system internal use only. Avoid using this range, when PDO is used.

* Only synchronization cycle is supported.

Step 5

Double click the PLC icon and select Node ID 001 from the available nodes and then use the **Right** arrow to add the selected one into the Node List. Output and Input tables are mapping registers for PDOs.

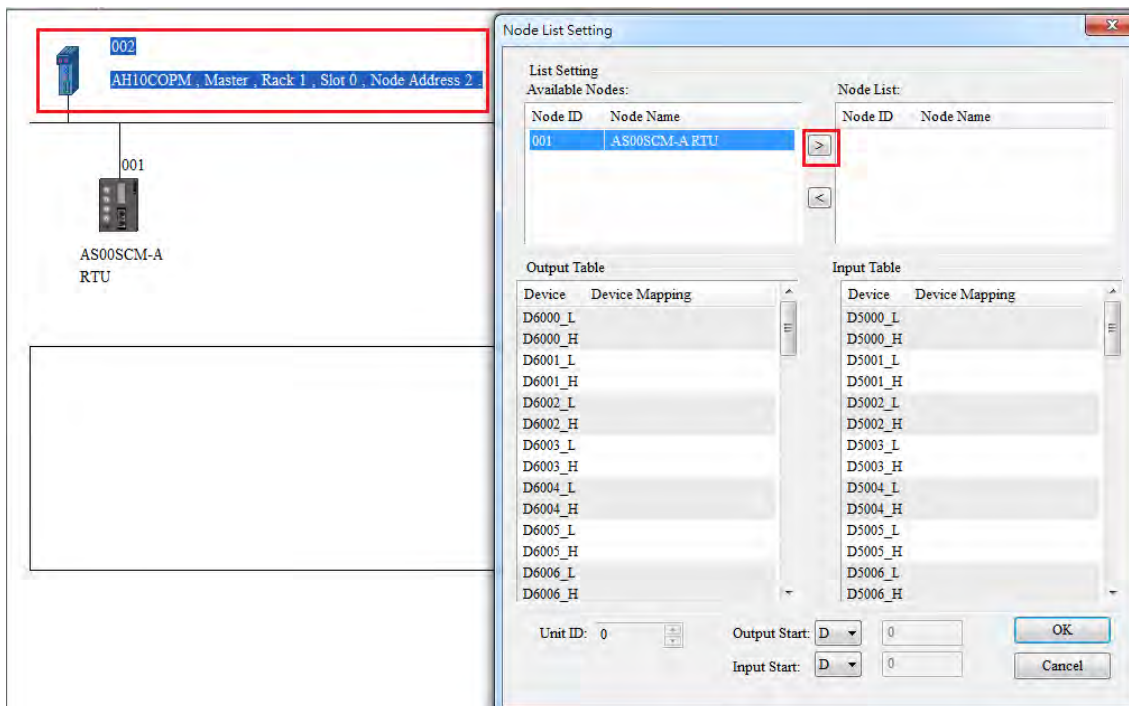

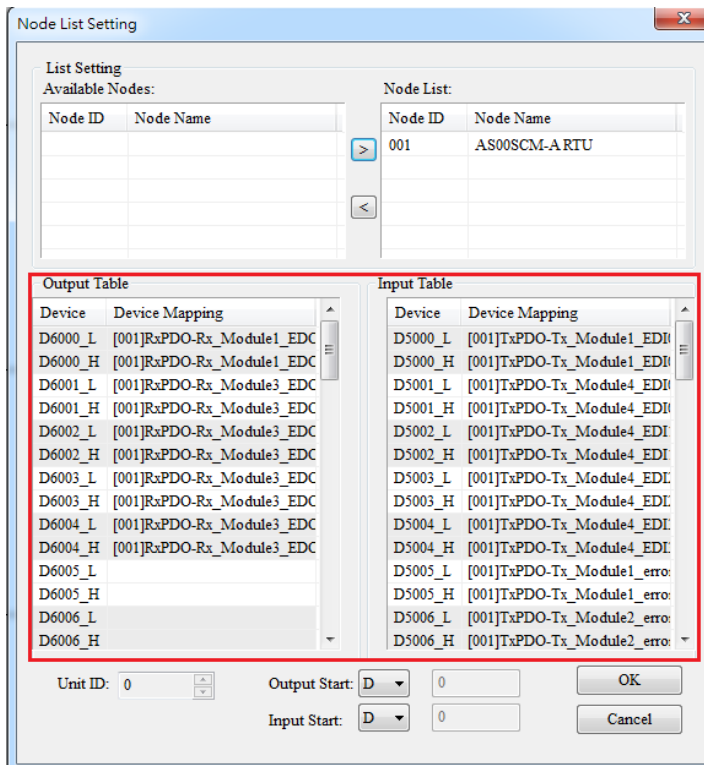

Step 6

Double click the module icon and the **Node Configuration** window appears. Click **Error Control Protocol** and then Error Control Setting windows appears. Select **Heartbeat** and set values for the **Master Consumer Timeout** and **Node Heartbeat Producer Timer**. Select AH10COPM Master from the Node List and click the **Down** arrow to add it to the list of Heart Consumer and then disconnection detection is now available for AS00SCM-A (RTU mode).

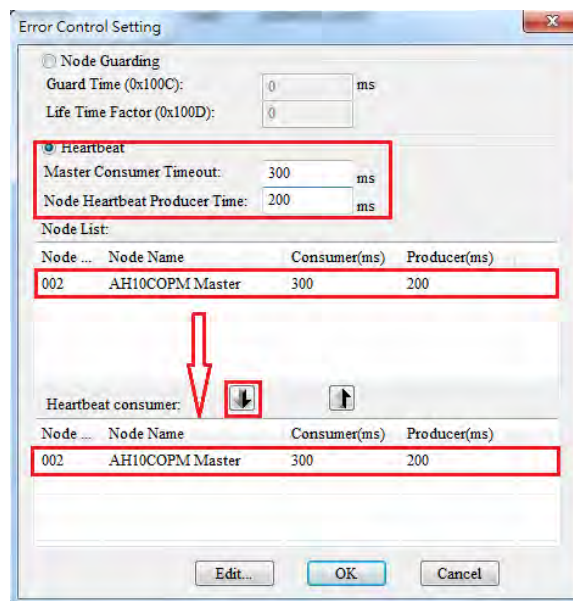
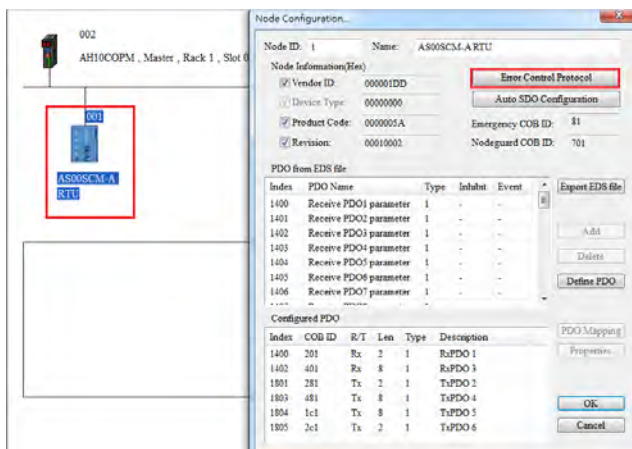

Click OK to confirm the setting. Download the parameters to the PLC. And then PLC can control the input/output of the IO module remotely.

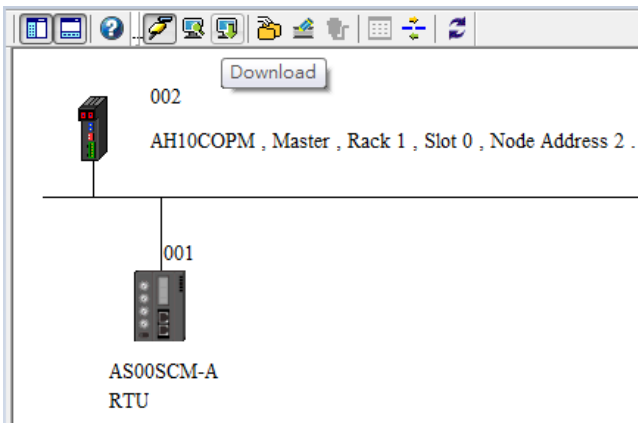

An example of using PLC to control the input/output of the IO module remotely:

Start ISPSOft and download the program from AH series PLC. Switch digital output module between 1 and 0 in every 0.5 seconds; change output values of the analog output module. Wire DI/DO modules to AI/AO modules and then you can see the changes of D6000 from D5000 and D6001-D6004 from D5001-D5004 as the example below shown. The module error codes are stored in D5005-D5009. Refer to relevant module manuals for error code definitions.

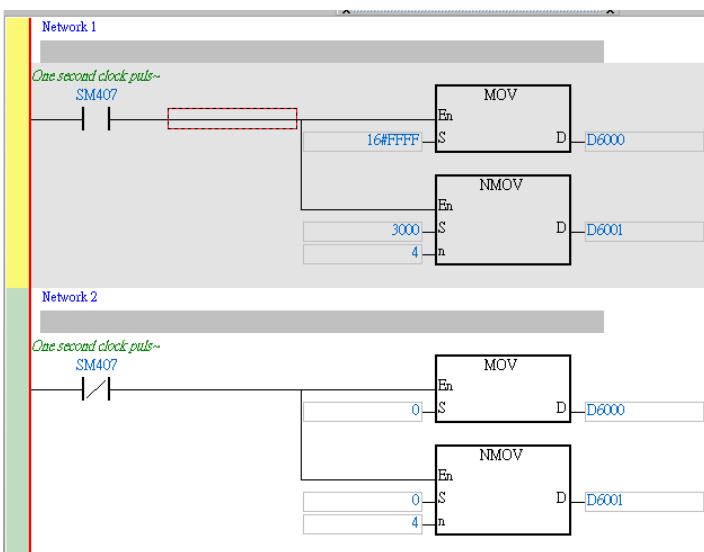

Device Name	Value (16bits)	Radix
D6000	FFFF	Hexadecimal
D5000	FFFF	Hexadecimal
D6001	3000	Signed Decimal
D5001	2994	Signed Decimal
D6002	3000	Signed Decimal
D5002	2983	Signed Decimal
D6003	3000	Signed Decimal
D5003	2992	Signed Decimal
D6004	3000	Signed Decimal
D5004	2985	Signed Decimal

9.6.4 Remote IO Application (AS-FEN02) Through EIP Builder

When the firmware is V2.02 or later, AS-FEN02 can be installed on AS00SCM-A (RTU mode) and then PLC can monitor right side IO modules remotely.

Here use EIP Builder to demonstrate. For ISPSOft V3.13 or later, there is no need to use EIP Builder, you can complete the settings in HWCONFIG. Refer to section 9.4.2.3 for more information.

Device	Function	IP Address / Location	Data Mapping Range
AS300	EtherNet/IP Master	192.168.1.5	D29000~D29019
AS00SCM-A + AS-FEN02	EtherNet/IP Slave	192.168.1.3	
AS08AM10N	Digital Input	right side of AS00SCM-A	X1.0~X1.15
AS08AN01T	Digital Output	right side of AS00SCM-A	Y1.0~Y1.15
AS04AD-A	Analog Input	right side of AS00SCM-A	D29060~D29079
AS04DA-A	Analog Output	right side of AS00SCM-A	D29080~D29099

Step 1

After setting up AS300 in ISPSOft and HWCONFIG. Open EIP Builder and scan the network to add AS00SCM-A (RTU) + AS-FEN02 to the Network. Double-click RTU module to open HWCONFIG and scan to obtain the configuration and mapped register addresses of the I/O module on the right side of AS00SCM-A. You can also edit the module configurations and write down the mapped register addresses. After saving, close HWCONFIG.

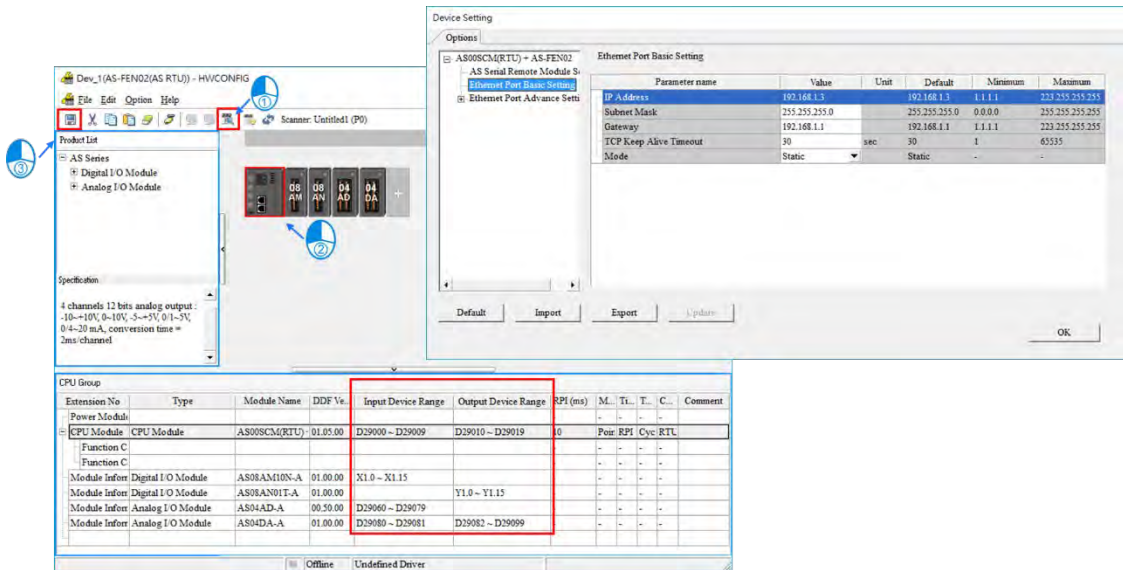

Step 2

You can see the IP address and the data length from the data mapping table in EIP Builder. The data mapping table can be downloaded and upload the mapped data to the device.

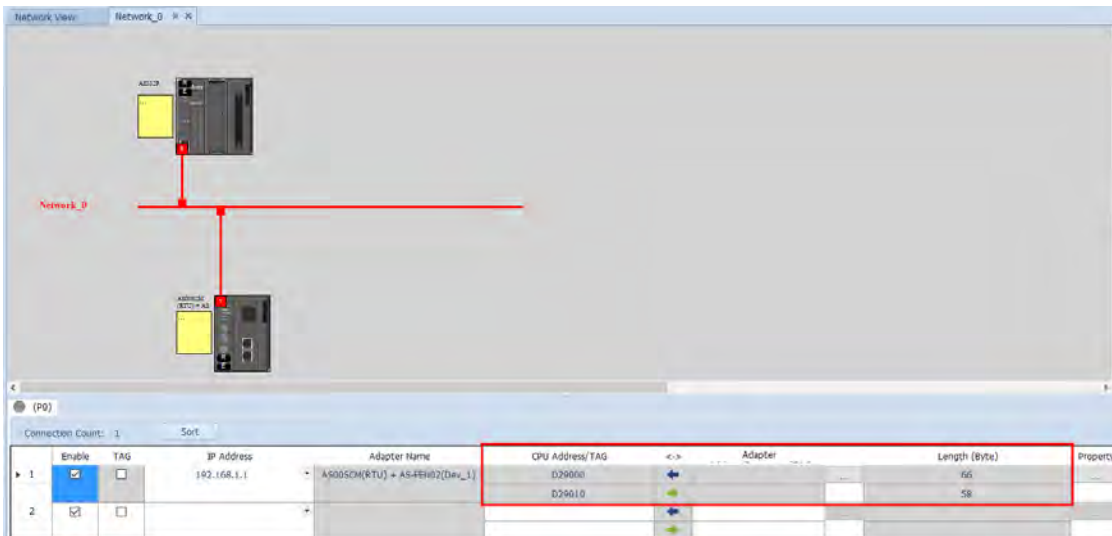

Step 3

An example of using PLC to control the input/output of the IO module remotely:

Start ISPSOft and switch digital output module between 1 and 0 in every 0.5 seconds and shift output values of the analog output module between 10 V and 5V. Wire DI/DO modules to AI/AO modules. Refer to Chapter 2, 3 and 4 in this manual for more details on module operation.

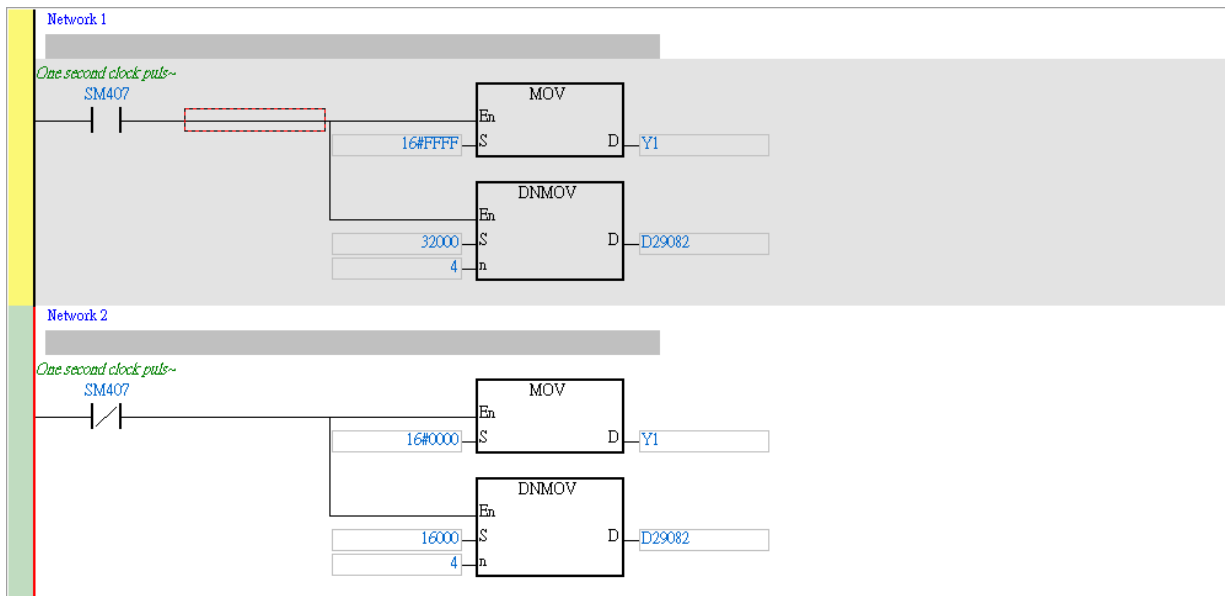

9.6.5 Remote IO Application (Multiple AS-FEN02)

When AS-FEN02 is installed on AS Series PLC, it can be used as the Ethernet port of the CPU.

The following example shows how to add multiple AS00SCM-A (RTU) + AS-FEN02 (hereafter referred to as the “RTU”) to an AS Series PLC in EIP connection. All IP addresses of RTU are set by the software.

Device	Function	IP Address	Data Mapping Area
AS200	EtherNet/IP master/scanner	192.168.1.5	
AS00SCM-A + AS-FEN02	EtherNet/IP slave/adaptor	192.168.1.30	D29540~D29559
AS00SCM-A + AS-FEN02	EtherNet/IP slave/adaptor	192.168.1.31	D29180~D29199
AS00SCM-A + AS-FEN02	EtherNet/IP slave/adaptor	192.168.1.32	D29360~D29379
AS08AN01T	Digital output	The right side of RTU	Y1.0~Y1.15
AS16AM10N-A	Digital input	The right side of RTU	X1.0~X1.15
AS08AM10N-A	Digital input	The right side of RTU	X2.0~X2.15

Step 1 Set up an IP address for the RTU

Turn all the knobs of the FORMAT 2 of the 3 new RTUs to 0. The default IP addresses are 192.168.1.3. Refer to section 9.4.2.2 for more information on using **IP Setting Tool** to set up the IP address.

Step 2

After the IP addresses of the 3 new RTUs are set, you can scan and add them in the network and connect to the AS Series PLC. Do not download the project before uploading the already set RTU values to the network.

Now you can set up the right-side module of RTU. Refer to section 9.6.4 for more details. Scan all the RTU and save the parameters. Make sure the data mapping table is updated and then download the project, including the parameters, configurations, and data mapping table to the AS Series PLC and the RTUs.

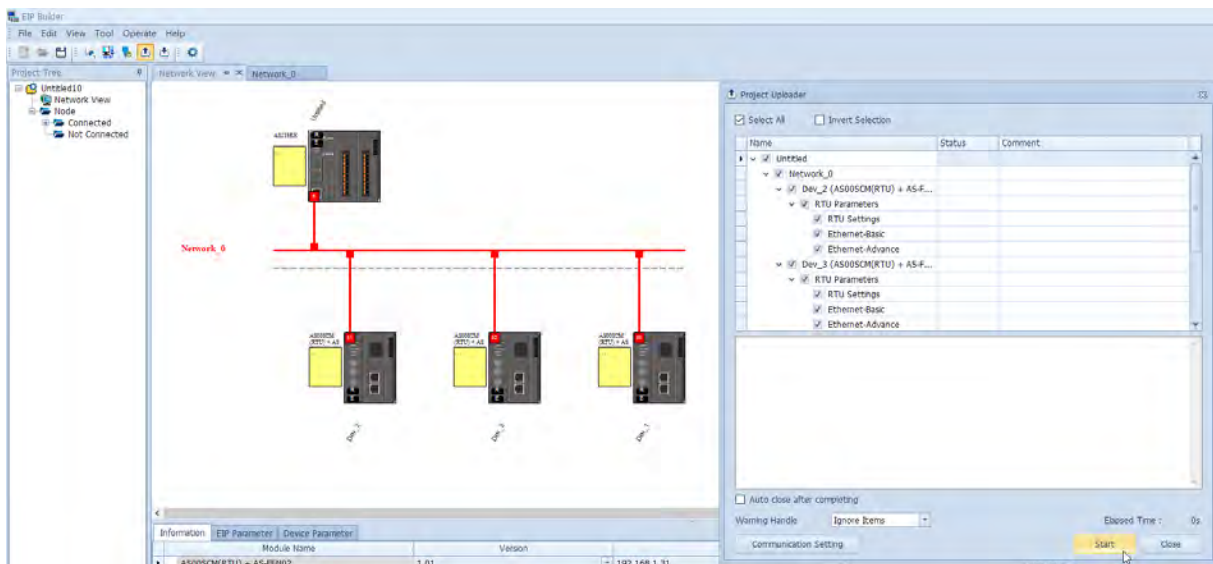

9.7 Error Codes

The error flags and the UD Link status codes are stored in data registers. You can modify the input device range as needed.

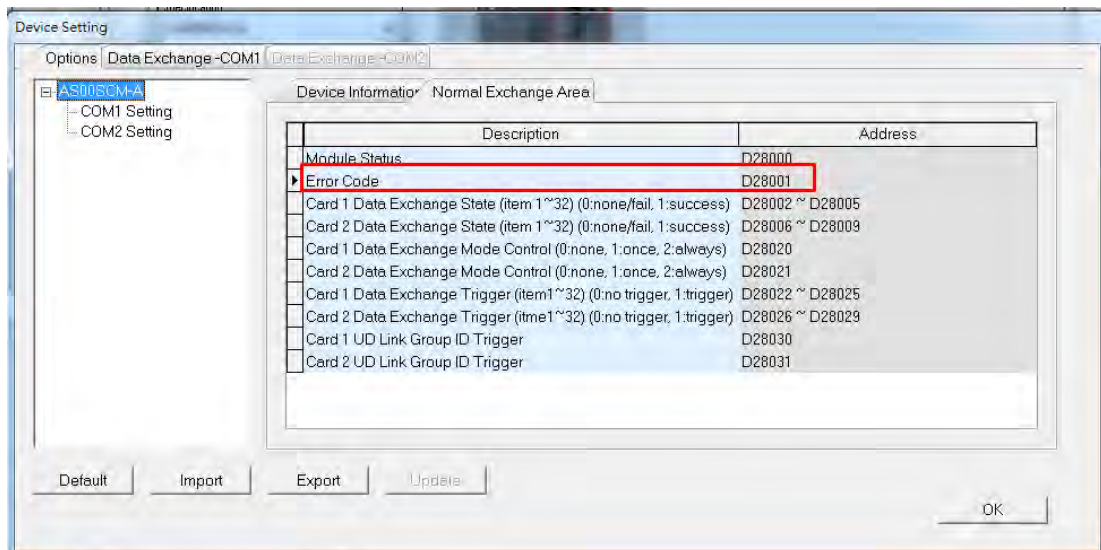
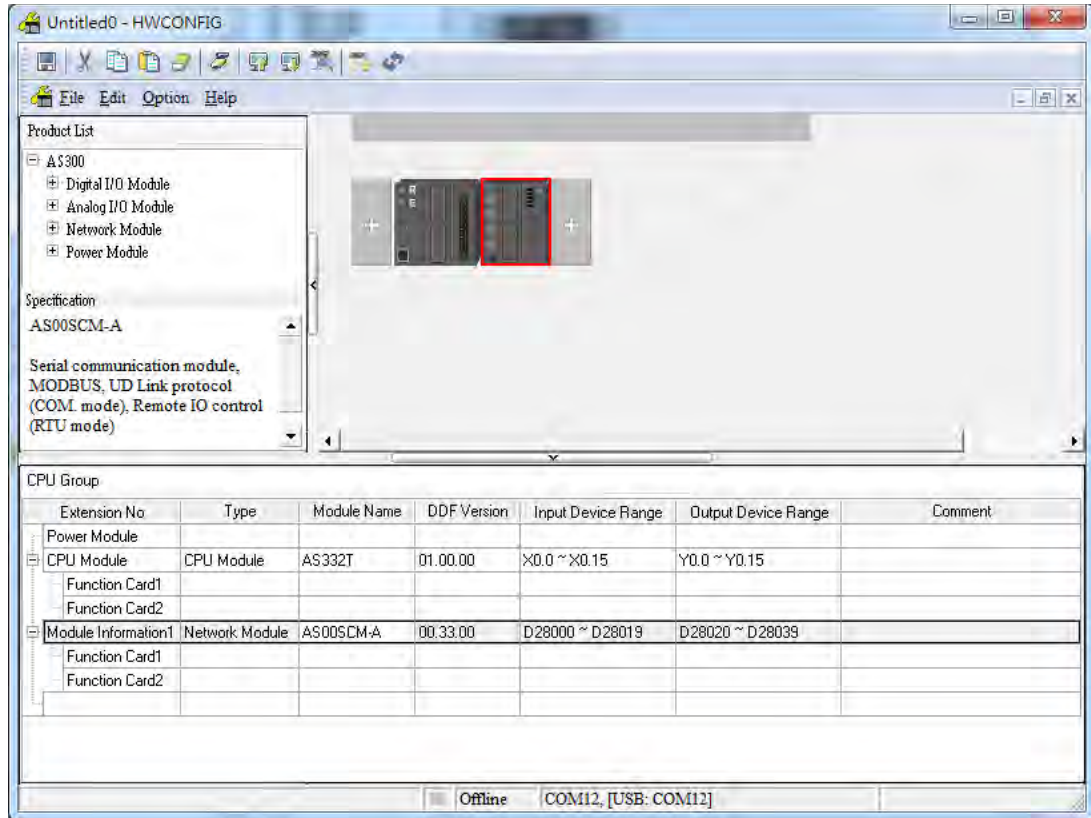

9.7.1 Troubleshooting for Module AS00SCM-A as a Communication Module

9.7.1.1 ERROR LED Indicators are ON

The following error codes indicate possible errors when the AS00SCM-A module is installed on the right side of the CPU module and is acting as a communication module.

Error Code	Description	Solution
16#1605	Hardware failure	<ol style="list-style-type: none"> 1. Check that the module is securely installed. 2. Install a new AS00SCM-A or contact the factory.
16#1606	The function card setting is incorrect.	<ol style="list-style-type: none"> 1. Check if the function card is securely installed. 2. Install a new function card or contact the factory. 3. Check if the setting in HWCONFIG is consistent with the function card setting. 4. Install a new AS00SCM-A or contact the factory.

9.7.1.2 ERROR LED Indicators Blinking Every 0.5 Seconds

The following error codes identify possible errors when the AS00SCM-A module is installed on the right side of the CPU module and acts as a communication module.

Error Code	Description	Solution
16#1802	Incorrect parameters	Check the parameter in HWCONFIG. Download the parameter again.
16#1803	Communication timeout	<ol style="list-style-type: none"> 1. Check whether the communication cable is properly connected. 2. Check if the station number and the communication format are correctly set. 3. Check if the connection with the function card is working correctly.
16#1804	The UD Link setting is incorrect.	<ol style="list-style-type: none"> 1. Check the settings of the UD Link. 2. Check the warning settings in the PLC.

The following error codes can only be viewed with SCMSOft; when the following errors occur, they are not shown on the LED indicators and the system does not send the error messages to the CPU module.

Error Code	Description	Solution
16#0107	The settings in HWCONFIG and manual settings are not consistent with function card 1.	Check the settings in HWCONFIG and manual settings for function card 1.
16#0108	The settings in HWCONFIG and manual settings are not consistent for function card 2.	Check the settings in HWCONFIG and manual settings for function card 2.
16#0201	Incorrect parameters	Check the parameter in HWCONFIG. Download the parameter again.
16#0301	Function card 1 communication timeout	<ol style="list-style-type: none"> 1. Check if the station number and the communication format are correctly set. 2. Check if the connection with the function card is working correctly.

Error Code	Description	Solution
16#0302	Function card 2 communication timeout	<ol style="list-style-type: none"> 1. Check if the station number and the communication format are correctly set. 2. Check if the connection with the function card is working correctly.
16#0400	Invalid UD Link Group ID for function card 1	<ol style="list-style-type: none"> 1. Check the UD Link settings. 2. Check the warning settings in the PLC.
16#0401	Invalid UD Link Group ID for function card 2	<ol style="list-style-type: none"> 1. Check the UD Link settings. 2. Check the warning settings in the PLC.
16#0402	Invalid UD Link Command for function card 1	<ol style="list-style-type: none"> 1. Check the UD Link settings. 2. Check the warning settings in the PLC.
16#0403	Invalid UD Link Command for function card 1	<ol style="list-style-type: none"> 1. Check the UD Link settings. 2. Check the warning settings in the PLC.

9.7.2 Troubleshooting for Module AS00SCM-A as a Remote Module

Errors from the remote modules are regarded as warnings for AS Series CPU modules. The LED indicator of the CPU module blinks and the CPU module can still operate. Use flag SM30 to manage error presentation in the remote modules.

9.7.2.1 ERROR LED Indicators Are ON

Error codes:

Error Code	Description	Solution
16#1301	Hardware failure	<ol style="list-style-type: none"> 1. Check if the module is securely installed. 2. Change and install a new AS00SCM-A or contact the factory.
16#1302	The function card setting is incorrect.	<ol style="list-style-type: none"> 1. Check if the function card is securely installed with the AS-FCOPM card. 2. Change and install a new function card or contact the factory. 3. Check if the setting in HWCONFIG is consistent with the function card setting. 4. Install a new AS00SCM-A or contact the factory.
16#1304	More than eight remote modules on the right side of the CPU module.	Check the total number of remote modules on the right side of the CPU module (maximum is 8).

9.7.2.2 ERROR LED Indicators Blinking Every 1 Seconds

Error Code	Description	Solution
16#1506	Remote module had been stopped. (available for firmware V2.06 or later)	This error code should work with AS Series Remote Module Setting in ISPSOft. When this error code shows up, it indicates the remote module had been stopped: Master Disconnected, Master Reconnected, IO Module Alarm, or IO Module Timeout. Check and clear the problem and then power-off and then power-on the remote module to refresh its state. Refer to section 9.4.3 in AS Series Module Manual for more details.

9.7.2.3 ERROR LED Indicators Blinking Every 0.5 Seconds

Error codes:

Error Code	Description	Solution
16#1500	Remote module communication timeout	Make sure the communication cable is well connected
16#1502	Incorrect parameters	Check the parameter in HWCONFIG. Download the parameter again. Or use the knob to restore the modules to the default settings.
16#1503	Remote extension module communication timeout	Make sure the communication cable is well connected and the module is properly connected to the CPU module and turn the modules on again.
16#1505	The actual placement of the extension modules is NOT the same as it is set.	Check if the parameter in HWCONFIG is the same as the actual placement.
16#1604	Extension module communication timeout	1. Make sure the module is properly connected to the CPU module and turn the modules on again. 2. If the problem persists, contact the local authorized distributors.

9.7.2.4 ERROR LED Indicators Blinking Every 0.2 Seconds

This happens when the 24 VDC power supply for the remote module is not sufficient. Check the power supply. If the power supply is normal, remove the extension module from the CPU module and then check if the SCM remote module is out of order. Error codes:

Error Code	Description	Solution
16#1303	24VDC power supply had not been sufficient before and then recovered from low-voltage that was less than 10 ms.	Check whether the 24 V power supply to the module is normal.

Chapter 10 Function Cards

Table of Contents

10.1 Introduction	10-2
10.2 Specification and Function	10-2
10.2.1 AS-F232.....	10-2
10.2.2 AS-F422.....	10-2
10.2.3 AS-F485.....	10-2
10.2.4 AS-F2AD	10-3
10.2.5 AS-F2DA	10-4
10.2.6 AS-FCOPM.....	10-4
10.2.7 AS-FEN02.....	10-5
10.2.8 AS-FPFN02	10-20
10.2.9 AS-FOPC02.....	10-27
10.2.10 AS-FFTP01.....	10-34
10.2.11 AS-FECAT	10-65
10.3 Profiles and Dimensions	10-74
10.3.1 AS-F232.....	10-74
10.3.2 AS-F422/AS-F485/AS-F2AD/AS-F2DA	10-74
10.3.3 AS-FCOPM	10-74
10.3.4 AS-FEN02.....	10-75
10.3.5 AS-FPFN02	10-76
10.3.6 AS-FOPC02.....	10-77
10.3.7 AS-FFTP01.....	10-78
10.3.8 AS-FECAT	10-79
10.4 Wiring	10-80
10.4.1 AS-F2AD	10-80
10.4.2 AS-F2DA	10-81
10.4.3 Topology of AS-FEN02, AS-FOPC02, AS-FPFN02 and AS-FECAT	10-82
10.4.4 Topology of AS-FFTP01	10-83
10.5 HWCONFIG in ISPSOft	10-84
10.5.1 Initial Setting.....	10-84

10.1 Introduction

Function cards are extension cards such as analog input/output (AI/AO) and communication cards for the AS Series PLC.

10.2 Specification and Function

10.2.1 AS-F232

The AS Series PLC is built with COM1 (RS-485) and COM2 (RS-485) ports. You can use the AS-F232 extension card for other communication interfaces such as RS-232, PC, and so on. Except for the communication interface, the communication functions and the isolation voltage are the same as the functions of the built-in ones. You can set up the communication port as either a slave or a master node. After installing the extension card, use HWCONFIG in ISPSOft to configure the communication.

■ Wiring example

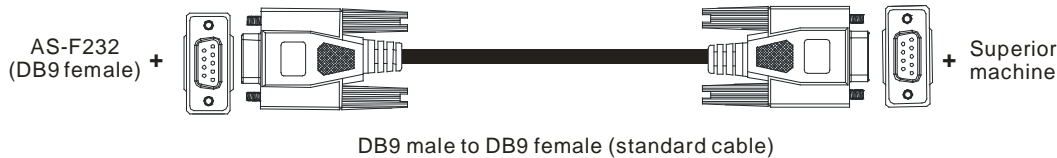

10.2.2 AS-F422

Use the AS-F422 extension card to communicate with Delta HMI devices or other devices that use an RS-422 communication port. Other than the different communication interface, the communication functions and the isolation voltage remain the same as the functions of the built-in ones. You can set the communication port as either a slave or a master node. After installing the extension card, use HWCONFIG in ISPSOft to configure the communication.

■ Wiring example for communication with Delta HMI DOPA series via COM2

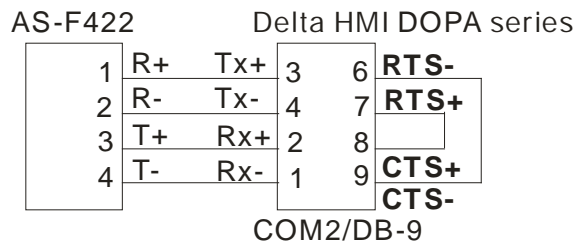

10.2.3 AS-F485

Other than the different communication interface, the communication functions and the isolation voltage remain the same as the functions of the built-in ones. With its own standalone communication port, the AS-F485 card can work independently and can be either a slave or a master node. After installing the extension card, use HWCONFIG in ISPSOft to configure the communication.

■ Wiring example

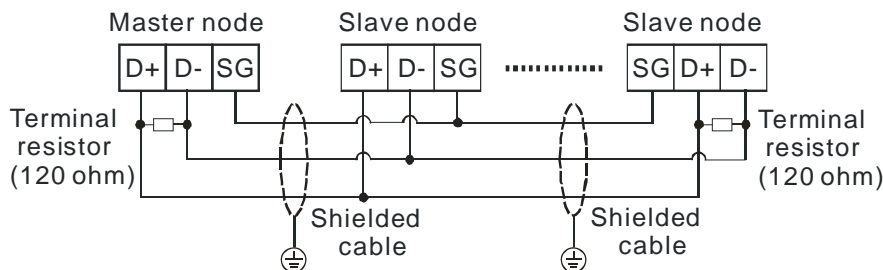

10.2.4 AS-F2AD

2 DC analog signal input channels:

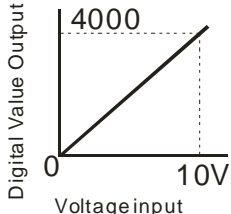
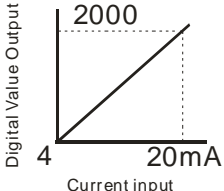
Item	Voltage Input	Current Input
Rated Input Range	0 V - 10 V	4 mA - 20 mA
Resolution	12-bit	11-bit
Digital Conversion Range	0 - 4000	0 - 2000
Hardware Input Limit*1	0V ~ +10.24V	4mA ~ 20.37mA (FW V1.00) 3.63mA ~ 20.37mA (FW V1.20 or later)
Digital Conversion Limit*2	0 ~ 4095	0 ~ 2047 (FW V1.00) - 48 ~ 2047(FW V1.20 or later)
Error Rate	room temperature: $\pm 0.5\%$; full temperature range: $\pm 1.0\%$	
Isolation voltage	An analog circuit is isolated from a digital circuit, but the channels are not isolated from one another. Isolation between an analog circuit and a digital circuit: 500 VC	
Input Impedance	2 M Ω	250 Ω
Conversion Time*3	3 ms / CH	
Characteristic Curve		
Digital Value Output*4	Card 1	SR168 (CH1), SR169 (CH2)
	Card 2	SR170 (CH1), SR171 (CH2)

*1: The input signal should NOT exceed the limit. If exceeding the limit, damage may occur.

*2: If the input signal exceeds the hardware input limit, the module only shows the maximum value. If the input signal is below the lower limit, it only shows the minimum value. If the input signal exceeds the hardware input limit, it also exceeds the digital conversion limit and a conversion limit error appears. For example in the current input mode (4 mA to 20 mA), when the input signal is 0 mA, exceeding the hardware lower limit, it also exceeds the conversion lower limit. The module uses the lower limit value (-48) as the input signal. If a disconnected analysis is required, you can check if the digital conversion value is -48.

*3: The conversion time is the time for each channel to convert signals to hardware input signals. If you need to calculate a complete conversion time, you need to add the PLC scan time.

*4: Use the program to read the values in SR to obtain the corresponding A/D conversion value for the channel.

Refer to section 2.2.16 from AS Programming Manual for more information on SM27 and SR27.

10.2.5 AS-F2DA

2 DC analog signal output channels:

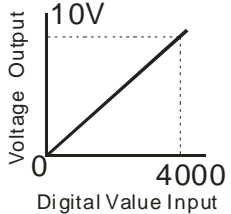
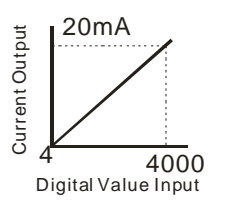
Item	Voltage Output	Current Output	
Analog Signal	0 V - 10 V	4 mA - 20 mA	
Resolution	12-bit	12-bit	
Digital Conversion Limit	0 - 4000	0 - 4000	
Error Rate	room temperature: $\pm 0.5\%$; full temperature range: $\pm 1.0\%$		
Isolation voltage	An analog circuit is isolated from a digital circuit, but the channels are not isolated from one another. Isolation between an analog circuit and a digital circuit: 500 VC		
Impedance Allowance	$\geq 1\text{ k}\Omega$	$\leq 500\ \Omega$	
Conversion Time*1	2ms / CH		
Characteristic Curve			
Digital Value Output*2	Card 1	SR172 (CH1)	SR173 (CH2)
	Card 2	SR174 (CH1)	SR175 (CH2)

*1: The conversion time is the time for each channel to convert signals to hardware input signals. If you need to calculate a complete conversion time, you need to add the PLC scan time.

*2: Use the MOV instruction to move the value to the SR to obtain the corresponding voltage output value.

10.2.6 AS-FCOPM

With its own standalone communication port, the AS-FCOPM card can work independently and can be either a slave or a master node. After installing the extension card, use HWCONFIG in ISPSOFT to configure the communication.

■ Wiring example

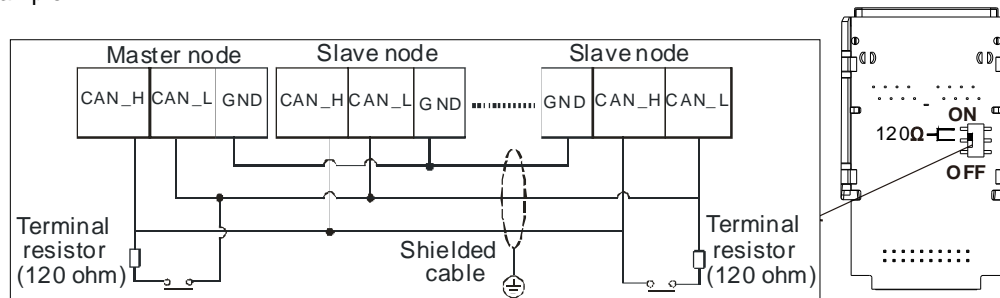

10.2.7 AS-FEN02

This communication card can work independently and does NOT occupy the communication port of PLC CPU. It can act as Modbus TCP Client or Modbus TCP Server and EtherNet/IP Adapter. After AS-FEN02 is installed, you can go to HWCONFIG from ISPSOFT for editing in the Function Card 2 section.

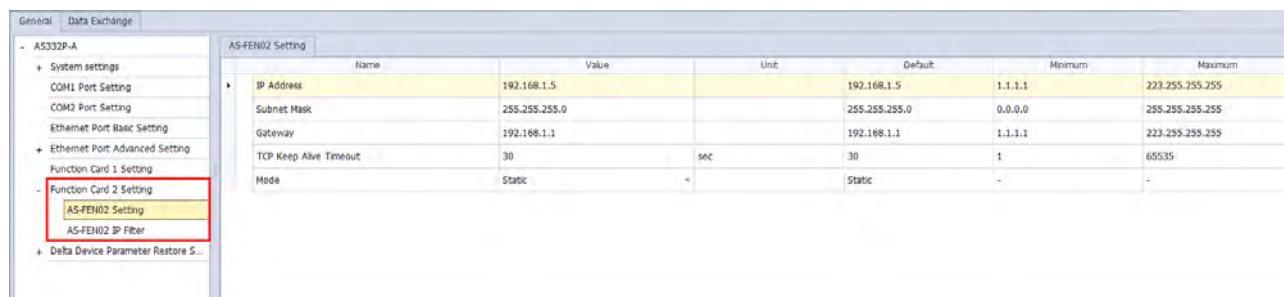

All the AS-FEN02 parameters are stored in AS300 PLC CPU or AS00SCM-A. If you need the IP address of AS-FEN02, you need to go to HWCONFIG from ISPSOFT to check its IP address in the Function Card 2 section. You can also use COMMGR to see the IP address of this device.

10.2.7.1 Supported Software and Firmware Versions

- The firmware of AS300 Series PLC should be V1.06 or later for AS-FEN02 to be installed on it. Use ISPSOFT V3.06 or later as the PLC editing software.
- The firmware of AS00SCM-A module should be V2.02 or later for AS-FEN02 to be installed on it. AS00SCM should be in RTU mode only, not supported when installed on the right-side of the AS PLC CPU.

	AS-FEN02	AS00SCM-A
Compatible firmware versions	V1.00	V2.02
	V1.02	V2.04
	V1.03	V2.06

- If using Delta AS/AH PLC CPU in RTU mode, it is suggested to use ISPSOFT V3.13 or later. Use HWCPNFIG V4.0 to set up EtherNet/IP for AS PLC CPU and use EIP Builder to set up EtherNet/IP for AH PLC CPU.
- If using the 3rd party EtherNet/IP Scanner in RTU mode, it is suggested to use EIP Builder V1.06 or later to set up the remote IO modules.

10.2.7.2 Features

- AS-FEN02 can be installed on AS300 Series PLC and AS00SCM-A (in RTU mode). But the firmware of AS00SCM-A module should be V2.02 or later for AS-FEN02 to be installed on it. AS00SCM should be in RTU mode only, not supported when installed on the right-side of the AS PLC CPU.
- This section introduces the operations when it is installed on AS300 Series PLC. For the operations when it is installed on AS00SCM-A, refer to Chapter 9 for more details.
- When AS-FEN02 is installed on AS300 Series PLC, it acts as a Client or Server of Modbus TCP connection. Go to HWCONFIG and click AS300 PLC CPU. Select Data Exchange in the editing area and if the AS-FEN02 is installed, you can find FEN02 in the function card section. Click it to edit the data exchange table. The rest is the same as using the built-in connection port for communication. Refer to Chapter 8 from AS Series Hardware and Operation Manual for more details.

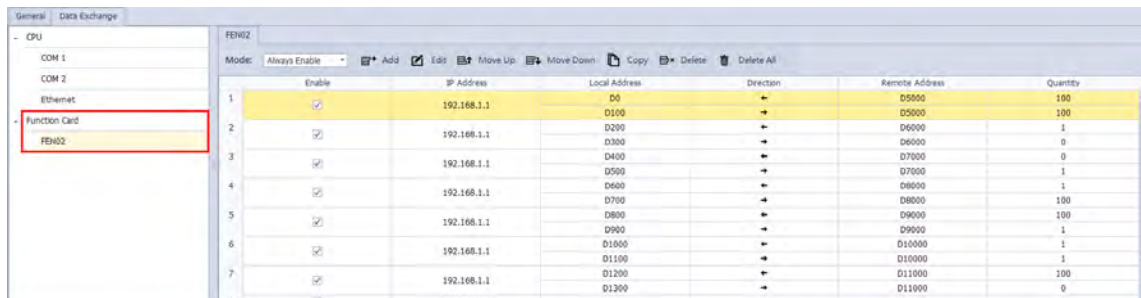

- When AS-FEN02 is installed on AS300 Series PLC, it acts as an Ethernet/IP Adapter but not Scanner for Ethernet/IP connection. When using Delta PLC CPU, you can use Ethernet/IP software to scan and add the device in.
- When AS00SCM-A+AS-FEN02 is used with the 3rd party Ethernet/IP Scanner, you need to set up the remote IO modules in EIP Builder (V1.06 or later). Go to Delta Official Website [Delta | Download Center \(deltaww.com\)](http://deltaww.com) (steps: Select Product Category: Industrial Automation; Select Product Sub-Category: PLC-Programmable Logic Controllers; Select Series: AS Series; Filter: Electrical Parameter and click Submit and then find the Ethernet/IP EDS File: AS00SCM-RTU (AS-FEN02)) to download the EDS file and then install the downloaded EDS file in the Ethernet/IP software. Refer to the user manual of the 3rd party Ethernet/IP Scanner for more information.

10.2.7.3 Specifications

- System Specifications

Item		Specification
General	Device type	Scanner, Adapter, and RTU communication interface
	Topology	Star and linear topologies are supported.
	IP Settings	<ul style="list-style-type: none"> ● When installed on AS300 PLC CPU, you can only use HWCONFIG from ISPSOft for editing. ● When installed on AS00SCM-A and used for RTU application, you can edit via software or hardware. <ul style="list-style-type: none"> ■ Software: Set the ID2 and FORMAT2 to 0x000 and use HWCONFIG from EIP Builder for editing. ■ Hardware: Use the ID2 and FORMAT2 to set IP address to 192.168.1.X (X=1~254) or turn ID2 and FORMAT2 to 0xFF to make it in DHCP mode.
	Availability	AS300 Series PLC AS00SCM-A (available only for RTU mode; NOT supported when installed on the right-side of the AS PLC CPU.)
Web	Max. connection number	8
	Functions	View device information Account management AS-FEN02 firmware update When installed on AS00SCM-A and in RTU mode, the module monitoring is supported.

- **MODBUS TCP Specifications (only available for CPU modules)**

Item		Specification
General	Device type	Server, Client
MODBUS TCP Server	Max. connection number	8
	Max. data length/per transmission	200 words
MODBUS TCP Client	Max. connection number	8
	Max. data length/per transmission	200 words

Note: The connection numbers of Server and Client are counted separately.

- **EtherNet/IP Specifications**

Item		Specification
General	Device type	Adapter
CIP Network I/O Connection	CIP connection number	8
	TCP connection number	8 (Servers)
	Requested Packet Interval (RPI)	1 ms~1000ms
	Max. Transmission Speed	10,000 pps
	Max. data length/per transmission	200 bytes
CIP Network Explicit Message	Class 3 (Connected Type)	Total 8 (Servers) (for both class 3 and UCMM connection types)
	UCMM (Non-Connected Type, only uses TCP connections)	
	CIP Objects	Identity Object (16#01) Message Router Object (16#02) Assembly Object (16#04) Connection Manager Object (16#06) Port Object (16#F4) TCP/IP Interface Object (16#F5) Ethernet Link Object (16#F6) Not supporting self-defined objects

10.2.7.4 IP Setting

- The IP address of AS-FEN02 is not stored on the function card. When you install AS-FEN02 onto AS300 PLC CPU or AS00SCM-A, the IP settings of AS-FEN02 will be obtained automatically.
- When installed on AS300 PLC CPU, you can go to *ISPSOft* -> *HWCONFIG* -> *Function Card 2 Setting* -> *Ethernet Port Basic Setting* to edit the parameters.

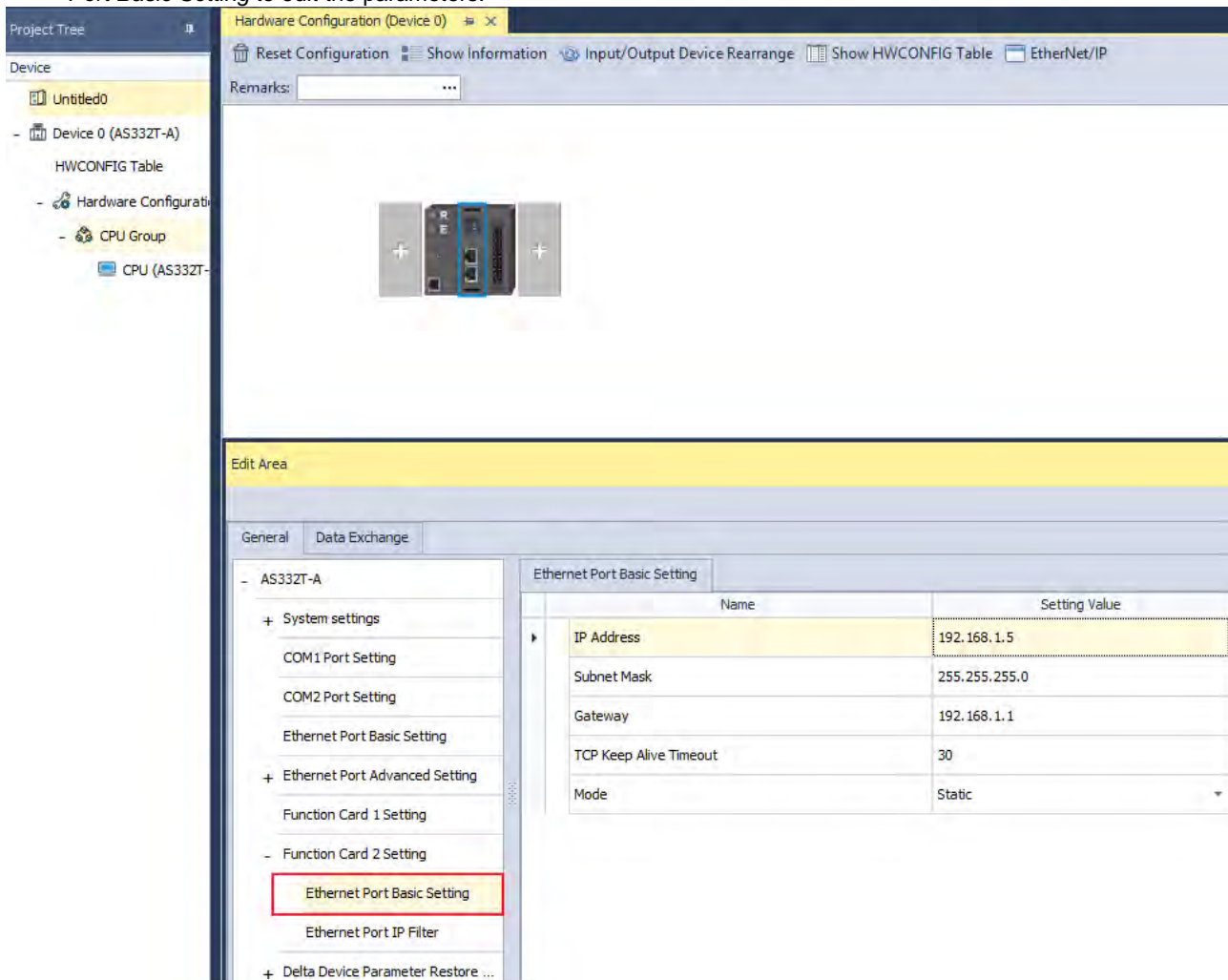

- AS-FEN02 can be installed on AS00SCM-A (firmware V2.02 or later) so that AS00SCM-A can act as a remote module. When the knob is set to 0, the IP address is 192.168.1.3 by default. Before setting up the remote IO module, you need to set up the IP settings. Two methods for you to set up the IP addresses for AS-FEN02 installed on AS00SCM-A.
 - Using knobs: Highly suggested. You can use ID2 and FORMAT2 knobs to set up the IP address. Hexadecimal format is used and ID2 corresponds to $x16^1$ and FORMAT 2 to $x16^0$. The possible IP address is 192.168.1.x, $x=1\sim FE$ (1~254). (DHCP mode)
 - Using **IP Manager Tool**: You can find IP Manager Tool in HWCONFIG (V4.0 or later). If you need to use an IP address that is NOT part of 192.168.1.x, you can use **IP Manager Tool** to set up the IP address.
 1. Open EIP Builder and add AS00SCM (RTU) + AS-FEN02 to your network. Make sure all four knobs on the AS00SCM-A (remote module) are turned to 0. And then connect to your computer via Ethernet.
 2. AS-FEN02 (FW V1.02.40 or later) supports **IP Manager Tool** from the **Tool** on the tool bar to scan for the device for IP address setup. You can use IP Search to search for one specific **IP Search** or use **Broadcast**

Search to scan all the AS-FEN02 in the network. This tool can be used when there is IP duplications, the IP addresses are in various network segments, or you need to edit the IP addresses of multiple devices at the same time.

3. Steps:

- 1) Select a network adapter for the computer.
- 2) Search for the function card you'd like to add through **IP Search** or **Broadcast Search**.
- 3) This tool uses MAC address to recognize the identities of different devices and you can use the MAC address of each device to edit the IP addresses of multiple devices at the same time.
- 4) Select one or multiple devices at the same time and click **Download**. After downloading, you can scan the devices again to check if the parameters are correct.

Note: You can use **IP Manager Tool**, when AS-FEN02 is installed on AS300 PLC CPU, but do not use it to set up the IP address to avoid conflicts with the parameters of AS300 PLC CPU project.

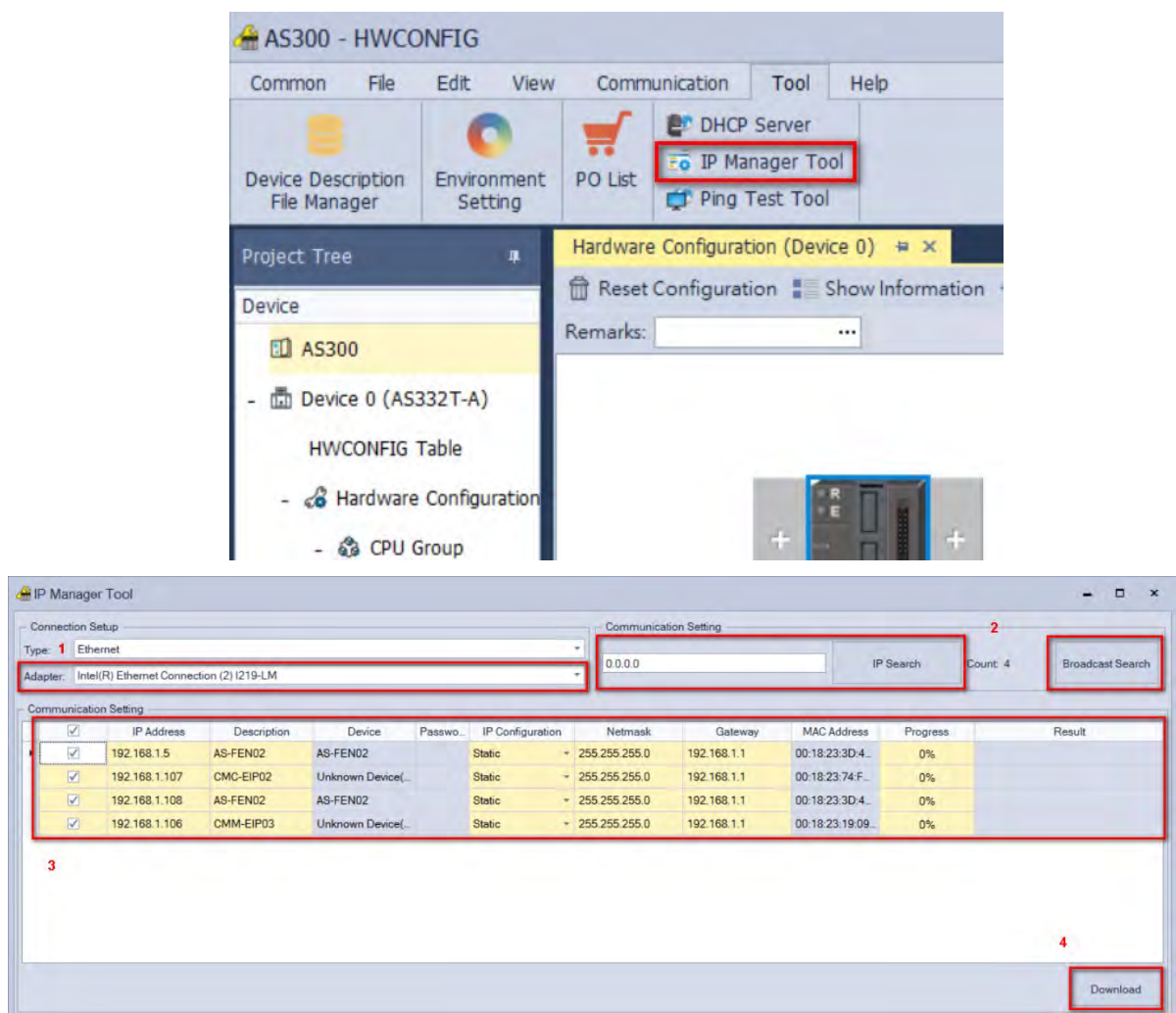

10.2.7.5 SM/SR

● Special Auxiliary Relays (SM)

SM	Function	AS300 Series	AS200 Series	OFF ↓ ON	STOP ↓ RUN	RUN ↓ STOP	Latched	Attribute	Default
SM1006	Data exchange through AS-FEN02 enabled by ISPSOft.	○	–	OFF	–	OFF	N	R/W	OFF
SM1008	Connection 1 for data exchange through AS-FEN02 started	○	–	OFF	–	–	N	R/W	OFF
SM1009	Connection 2 for data exchange through AS-FEN02 started	○	–	OFF	–	–	N	R/W	OFF
SM1010	Connection 3 for data exchange through AS-FEN02 started	○	–	OFF	–	–	N	R/W	OFF
SM1011	Connection 4 for data exchange through AS-FEN02 started	○	–	OFF	–	–	N	R/W	OFF
SM1012	Connection 5 for data exchange through AS-FEN02 started	○	–	OFF	–	–	N	R/W	OFF
SM1013	Connection 6 for data exchange through AS-FEN02 started	○	–	OFF	–	–	N	R/W	OFF
SM1014	Connection 7 for data exchange through AS-FEN02 started	○	–	OFF	–	–	N	R/W	OFF
SM1015	Connection 8 for data exchange through AS-FEN02 started	○	–	OFF	–	–	N	R/W	OFF
SM1016	Successful data exchange connection 1 through AS-FEN02	○	–	OFF	–	–	N	R	OFF
SM1017	Successful data exchange connection 2 through AS-FEN02	○	–	OFF	–	–	N	R	OFF
SM1018	Successful data exchange connection 3 through AS-FEN02	○	–	OFF	–	–	N	R	OFF
SM1019	Successful data exchange connection 4 through AS-FEN02	○	–	OFF	–	–	N	R	OFF
SM1020	Successful data exchange connection 5 through AS-FEN02	○	–	OFF	–	–	N	R	OFF
SM1021	Successful data exchange connection 6 through AS-FEN02	○	–	OFF	–	–	N	R	OFF
SM1022	Successful data exchange connection 7 through AS-FEN02	○	–	OFF	–	–	N	R	OFF
SM1023	Successful data exchange connection 8 through AS-FEN02	○	–	OFF	–	–	N	R	OFF
SM1024	Error in data exchange connection 1 through AS-FEN02	○	–	OFF	–	–	N	R	OFF
SM1025	Error in data exchange connection 2 through AS-FEN02	○	–	OFF	–	–	N	R	OFF
SM1026	Error in data exchange connection 3 through AS-FEN02	○	–	OFF	–	–	N	R	OFF
SM1027	Error in data exchange connection 4 through AS-FEN02	○	–	OFF	–	–	N	R	OFF
SM1028	Error in data exchange connection 5 through AS-FEN02	○	–	OFF	–	–	N	R	OFF
SM1029	Error in data exchange connection 6 through AS-FEN02	○	–	OFF	–	–	N	R	OFF

SM	Function	AS300 Series	AS200 Series	OFF ↓ ON	STOP ↓ RUN	RUN ↓ STOP	Latched	Attribute	Default
SM1030	Error in data exchange connection 7 through AS-FEN02	○	—	OFF	—	—	N	R	OFF
SM1031	Error in data exchange connection 8 through AS-FEN02	○	—	OFF	—	—	N	R	OFF

Special auxiliary relay	Refresh time
SM1006	After the parameters of data exchange are downloaded, you set the flag to ON or OFF.
SM1008~SM1015	After the parameters of data exchange are downloaded, you set the flag to ON or OFF.
SM1016~SM1031	The flag is ON, when the system is refreshed automatically.

● Special Data Registers (SR)

SR	Function	AS300 Series	AS200 Series	OFF ↓ ON	STOP ↓ RUN	RUN ↓ STOP	Latched	Attribute	Default
SR1520	Actual connection time for data exchange through the AS-FEN02 connection 1	○	—	0	—	—	N	R	0
SR1521	Actual connection time for data exchange through the AS-FEN02 connection 2	○	—	0	—	—	N	R	0
SR1522	Actual connection time for data exchange through the AS-FEN02 connection 3	○	—	0	—	—	N	R	0
SR1523	Actual connection time for data exchange through the AS-FEN02 connection 4	○	—	0	—	—	N	R	0
SR1524	Actual connection time for data exchange through the AS-FEN02 connection 5	○	—	0	—	—	N	R	0
SR1525	Actual connection time for data exchange through the AS-FEN02 connection 6	○	—	0	—	—	N	R	0
SR1526	Actual connection time for data exchange through the AS-FEN02 connection 7	○	—	0	—	—	N	R	0
SR1527	Actual connection time for data exchange through the AS-FEN02 connection 8	○	—	0	—	—	N	R	0
SR1528	The error code for data exchange through the AS-FEN02 connection 1	○	—	0	—	—	N	R	0
SR1529	The error code for data exchange through the AS-FEN02 connection 2	○	—	0	—	—	N	R	0
SR1530	The error code for data exchange through the AS-FEN02 connection 3	○	—	0	—	—	N	R	0
SR1531	The error code for data exchange through the AS-FEN02 connection 4	○	—	0	—	—	N	R	0
SR1532	The error code for data exchange through the AS-FEN02 connection 5	○	—	0	—	—	N	R	0
SR1533	The error code for data exchange through the AS-FEN02 connection 6	○	—	0	—	—	N	R	0
SR1534	The error code for data exchange through the AS-FEN02 connection 7	○	—	0	—	—	N	R	0

SR	Function	AS300 Series	AS200 Series	OFF ↓ ON	STOP ↓ RUN	RUN ↓ STOP	Latched	Attribute	Default
SR1535	The error code for data exchange through the AS-FEN02 connection 8	○	—	0	—	—	N	R	0
SR1536	AS-FEN02/FOPC02 TCP current connection number	○	—	0	—	—	N	R	0
SR1537	AS-FEN02 MODBUS/TCP Server connection number	○	—	0	—	—	N	R	0
SR1538	AS-FEN02 MODBUS/TCP Client connection number	○	—	0	—	—	N	R	0
SR1539	AS-FEN02/FOPC02 EtherNet/IP Adapter connection number	○	—	0	—	—	N	R	0

Special data register	Refresh time
SR1520~SR1535	Refresh after AS-FEN02 communication is done.
SR1536~SR1539	The flag is ON, when the system is refreshed automatically.

10.2.7.6 Example of AS Series PLC CPU (Scanner) Connects to AS Series PLC CPU + AS-FEN02 (Adapter)

When AS-FEN02 is installed on AS Series PLC, it can act as an EtherNet/IP adapter.

Use HWCONFIG to set the IP Address of AS-FEN02.

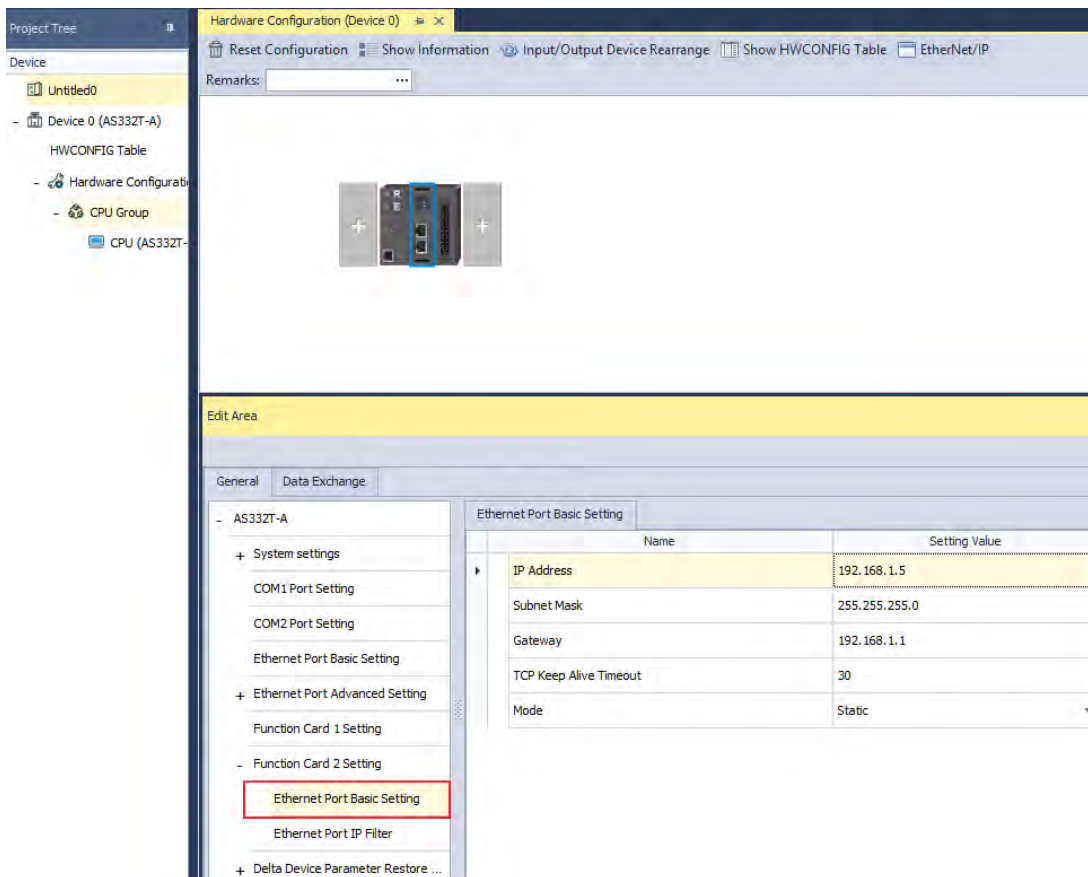

The below example uses PLC 1 and PLC 2 (with AS-FEN02) to connect to each other and perform data mapping through EtherNet/IP connection. When AS PLC CPU acts as a Scanner, you need to set the network to EtherNet/IP in ISPSOft. Refer to Chapter 9 in AS Series Hardware and Operation Manual for more details on AS Series PLC acting as EtherNet/IP Scanner.

Device	Function	IP Address	Data Mapping Area
PLC 1	EtherNet/IP Scanner	192.168.1.5	D100, D200
PLC 2	EtherNet/IP Adapter	192.168.1.3	D1000, D2000

Steps

- (1) Right-click AS PLC CPU of the PLC1 project in HWCONFIG and then go to *Communication Software* -> *EtherNet/IP*.

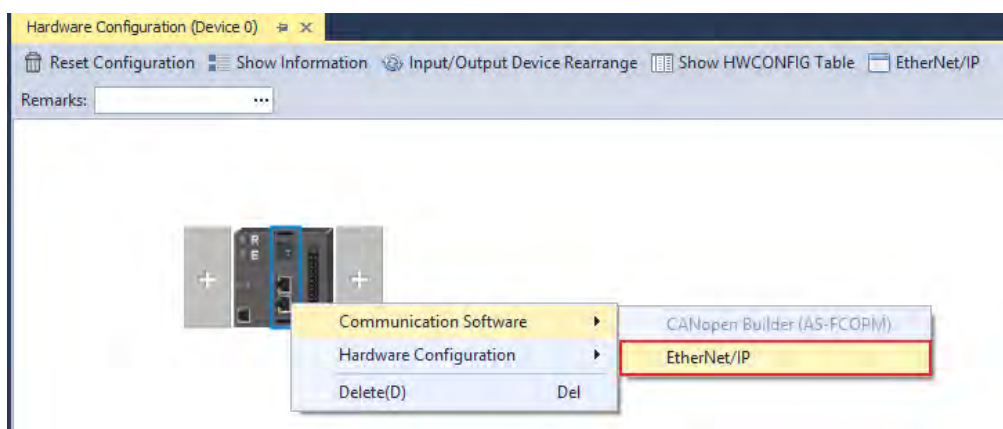

- (2) Scan the network or to add ASCPU(ASFEN02) (the latest version) manually. After adding the function card in, drag and drop it to the red dot of Network_0 to add it to the same network as the scanner's. Click Data Exchange tab to open the data exchange table and to edit the data mapping table, including Scanner Start Address, Adapter Starter Address, and Length for data mapping between the scanner and adapter; the unit for data length is word.

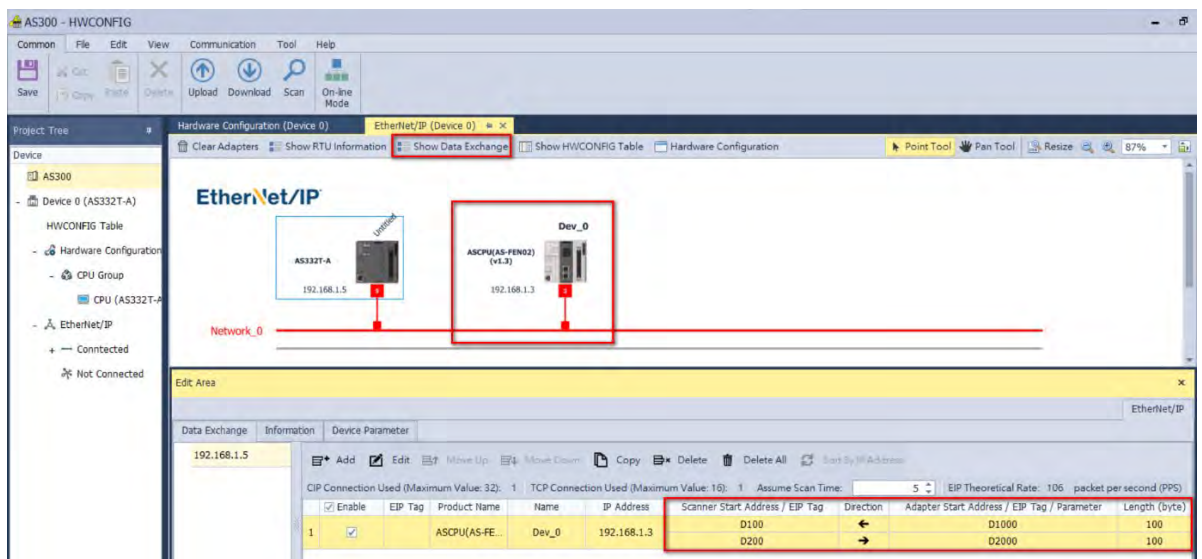

- (3) Click the **Download** on the tool bar and then start data exchange. Click the **On-line Mode** to check the connection status.

10.2.7.7 Example of A 3rd Party EtherNet/IP PLC CPU (Scanner) Connects to AS Series PLC CPU + AS-FEN02 (Adapter)

A 3rd party PLC (when acting as a scanner) can create an EtherNet/IP connection to AS300 Series PLC (when AS-FEN02 is installed). Before you begin, you need to go to www.deltaww.com to download EDS file. Go to Delta Official Website [\(Delta | Download Center \(deltaww.com\)\)](http://Delta | Download Center (deltaww.com)) (steps: Select Product Category: Industrial Automation; Select Product Sub-Category: PLC- Programmable Logic Controllers; Select Series: AS Series; Filter: Electrical Parameter and click Submit and then find the EtherNet/IP EDS File: AS00SCM-RTU (AS-FEN02)) to download the EDS file and then install the downloaded EDS file in the EtherNet/IP software. Refer to the user manual of the 3rd party EtherNet/IP Scanner for more information. The following uses EtherNet/IP Scanner from manufacturer A as an example.

- (1) Right-click **Ethernet** to see the context menu and click **New Module** to add a new device in.
- (2) Set up the parameters including device name, IP address and many more. For basic operation, you can use the default EDS file directly. No need to edit the EDS file. But you should change the data type to meet the system format. Click **Change** in the section of Module Definition on the General tab to change the data type according to your needs. Here the data type is INT, meaning when monitoring, data in each device is shown in one word (a D device).
- (3) Setting up the data mapping table

I: Input data (T->O), The Scanner reads data from the Adapter.

Ex. Connection 1 is corresponding to PLC D3000~D3099.

O: Output data (O->T), The Scanner writes data in the Adapter.

Ex. Connection 1 is corresponding to PLC D2000~D2099.

C: here corresponds to the configurations. You can edit the corresponding PLC addresses of input and output. After editing, you need to download the parameters to the 3rd party PLC and establish a connection to make the changes become effective.

I/O Message Connection				
Connection No.	Function	Instance Attribute	Length	Defaults
Connection 1	Input (T->O)	0x65	100 words	D3000~D3099
	Output (O->T)	0x64	100 words	D2000~D2099
	Configuration	0x80	8 words	Refer to the table below
Connection 2	Input (T->O)	0x67	100 words	D3100~D3199
	Output (O->T)	0x66	100 words	D2100~D2199
	Configuration	0x81	8 words	Refer to the table below
Connection 3	Input (T->O)	0x69	100 words	D3200~D3299
	Output (O->T)	0x68	100 words	D2200~D2299
	Configuration	0x82	8 words	Refer to the table below
Connection 4	Input (T->O)	0x6B	100 words	D3300~D3399
	Output (O->T)	0x6A	100 words	D2300~D2399
	Configuration	0x83	8 words	Refer to the table below
Connection 5	Input (T->O)	0x6D	100 words	D3400~D3499
	Output (O->T)	0x6C	100 words	D2400~D2499

	Configuration	0x84	8 words	Refer to the table below
Connection 6	Input (T->O)	0x6F	100 words	D3500~D3599
	Output (O->T)	0x6E	100 words	D2500~D2599
	Configuration	0x85	8 words	Refer to the table below
Connection 7	Input (T->O)	0x71	100 words	D3600~D3699
	Output (O->T)	0x70	100 words	D2600~D2699
	Configuration	0x86	8 words	Refer to the table below
Connection 8	Input (T->O)	0x73	100 words	D3700~D3799
	Output (O->T)	0x72	100 words	D2700~D2799
	Configuration	0x87	8 words	Refer to the table below

10.2.7.8 Example of AS Series PLC CPU (Modbus TCP Client) Connects to AS Series PLC CPU + AS-FEN02 (Server)

When AS-FEN02 is installed on AS Series PLC, you can create a connection by configuring the IP address and some relevant parameters to make it act as a Modbus TCP Server.

The following example shows two AS Series PLCs (one with AS-FEN02) to connect each other and one as Client and the other as Server (AS-FEN02) to perform data mapping through the Modbus TCP connection. For the support function codes and corresponding addresses, refer to AS Series Operation Manual for more details.

Device	Function	IP Address	Data Mapping Area
AS300	Modbus TCP Client	192.168.1.5	D100, D200
AS300+ AS-FEN02	Modbus TCP Server	192.168.1.3	D200, D300

Step 1

Double click AS Series PLC in HWCONFIG and the **Device Setting** window appears. Set up the IP Address of the AS300+AS-FEN02 to 192.168.1.3.

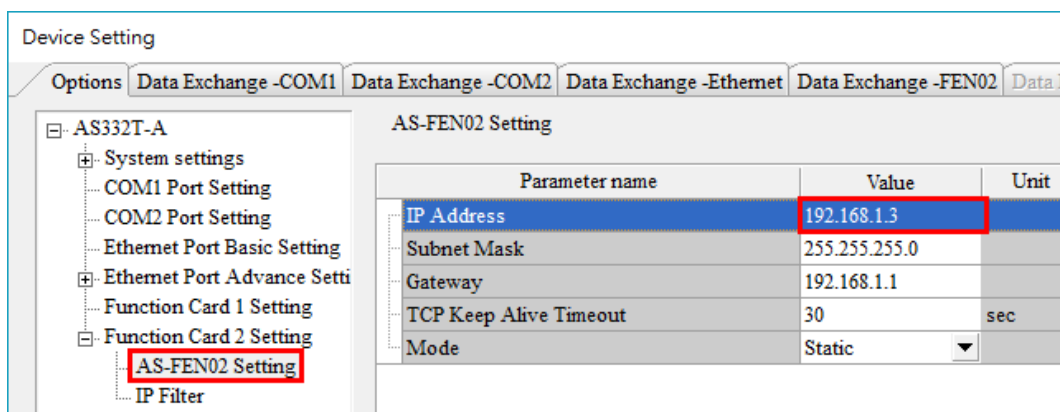

Step 2

Create a data mapping table in the Client and then perform data mapping with the Server (AS300+AS-FEN02).

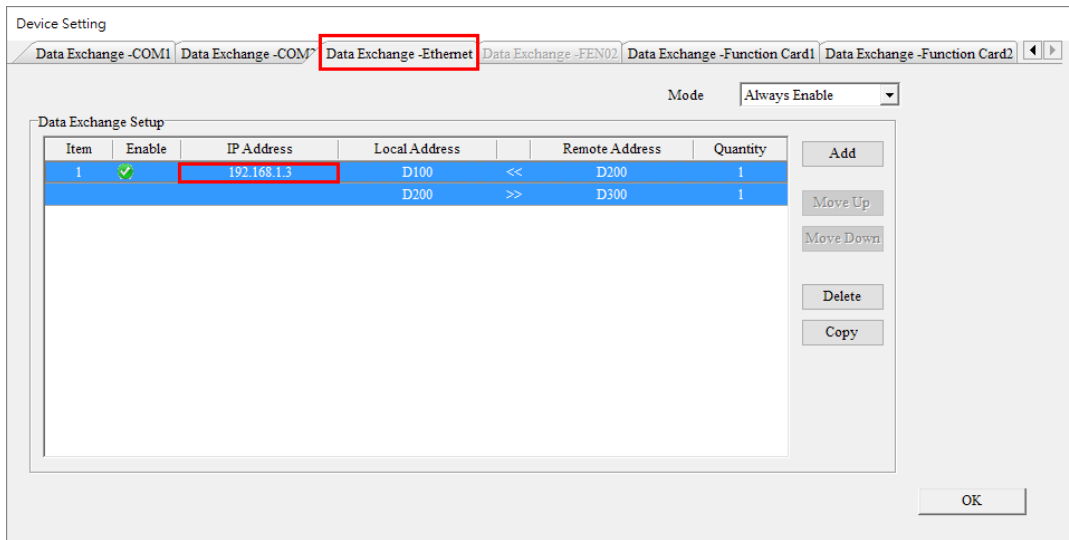

Step 3

Click the **Downloader** icon and then select the parameters that you'd like to download.

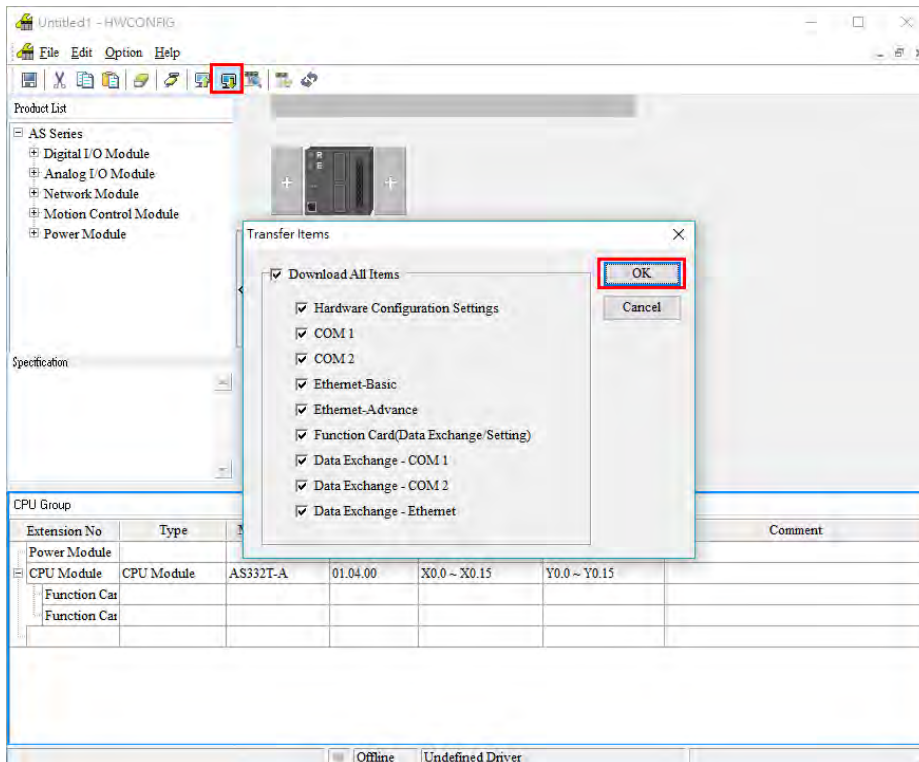

10.2.7.9 Web Server

When AS-FEN02 is installed on AS300 Series PLC or AS00SCM-A (RTU mode), you can enter AS-FEN02 IP address in the search bar of your browser to connect to your device. After that you can set up, update firmware and monitor AS-FEN02. The webpage displays differently, when AS-FEN02 is installed on AS300 Series PLC or AS00SCM-A (RTU mode). They will be explained in different sections.

List of browsers that support AS-FEN02 webpage:

Provider	Browser	Supported versions
Microsoft	Internet Explorer	V10.0 and later
Microsoft	Edge	V20 and later
Google	Chrome	V14 and later
Apple	Safari	V5.1 and later

- **When AS-FEN02 is installed on AS300 Series PLC**
 - a. After the setting IP address in HWCONFIG of ISPSOft. Open your browser and enter AS-FEN02 IP address in the search bar to connect to AS-FEN02. After the webpage appears, enter "Admin" in the User section and click Login without entering any password. You can set up the password after login.

The screenshot displays the web interface for AS-FEN02. At the top, there is a blue header with the DELTA logo and the slogan "Automation for A Changing World". Below the header, on the left, is a login section with fields for "User" and "Password", and a "Login" button. A sidebar menu shows "Information" and "Device information". The main content area is titled "Device information" and lists the following details:

Device name	AS-FEN02
Device description	
Firmware version	V01.00.00.30
IP address	192.168.1.5
MAC address	00:18:23:13:02:09
Serial number	

b. After login, you can check the items shown on the left section.

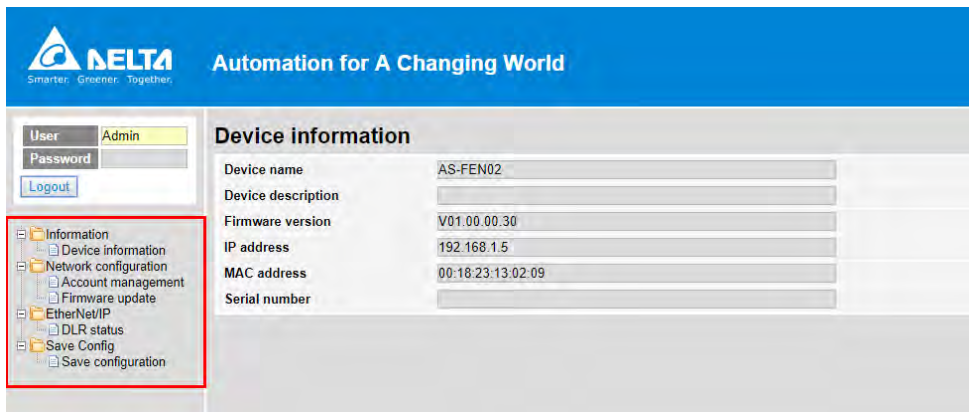

c. The menu shows data based on the permission of the current user.

Nodes	Permission	
	Administrator	Read
Device information	V	V
Account management	V	X
Firmware update	V	X
Save configuration	V	X

d. Account Management: You can set 2 kinds of access types, Administrator and Read. After the setting is done, click **Apply** and save the settings in Save configuration.

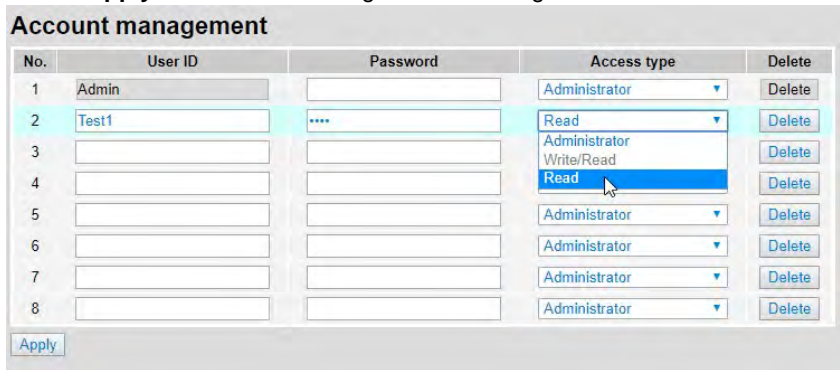

e. Firmware Update: You can update the firmware of AS-FEN02 via the webpage.

f. Save Configuration: After any setting is done, save the settings in Save Configuration to reflect the changes.

● **When AS-FEN02 is installed on AS00SCM-A**

a. Use the switches on AS00SCM-A to set the AS-FEN02 IP address. Open your browser and enter AS-FEN02 IP address in the search bar to connect to AS-FEN02. After the webpage appears, enter “Admin” in the User section and click Login without entering any password. You can set up the password after login.

b. The menu shows data based on the permission of the current user. When it is installed on AS00SCM-A, you can monitor the right-side module (Hardware Status) and check the EtherNet/IP connection information.

Nodes	Permission	
	Administrator	Read
Device information	V	V
Account management	V	X
Firmware update	V	X
Hardware status*	V	V
EtherNet/IP information**	V	V
Save configuration	V	X

Note:

* AS00SCM-A is recognizable for AS-FEN02 FW V1.13 or later, AS00SCM-A FW V2.06 or later.

** AS-FEN02 firmware V1.13 supports webpage monitoring function.

- c. Hardware Status: you can monitor the connected right-side I/O modules, including their module names, the current values, statuses and error codes. You can edit the values in the Refresh Cycle to update the cycle.

Hardware status		Refresh cycle (1s ~ 60s):	Value	Floating format setting: 3	Status	Error code
Extension No.	Module name					
Power module						
RTU module	AS00SCM-A					
---Function card	AS-FEN02					
Module 1	AS08AM10N-A	X0	0 1 2 3 4 5 6 7 8 9 10 11 12 13 14 15			
Module 2	AS16AP11R-A	X0	0 1 2 3 4 5 6 7 8 9 10 11 12 13 14 15			
		Y0				
Module 3	AS04AD-A	Input CH1	-0.003			
		Input CH2	-0.002			
		Input CH3	-0.001			
		Input CH4	0.001			
Module 4	AS04DA-A	Output CH1	0.000			
		Output CH2	0.000			
		Output CH3	0.000			
		Output CH4	0.000			

- d. EtherNet/IP Information: when using a 3rd party device as an EtherNet/IP Scanner, you can check this page for more information on connection parameters. Refer to Chapter 9 for more information on AS00SCM-A.

EtherNet/IP information			
I/O Connection		Input	Output
Instance		101	100
Total size (INT)		54	39
Extension No.	Module name	Input offset	Output offset
RTU module	AS00SCM-A	0 ~ 29	0 ~ 19
---Function card	AS-FEN02		
Module 1	AS08AM10N-A	30 ~ 30	
Module 2	AS16AP11R-A	31 ~ 31	20 ~ 20
Module 3	AS04AD-A	32 ~ 51	
Module 4	AS04DA-A	52 ~ 53	21 ~ 38

10.2.7.10 Network Security

To enhance security and performance of the system, it is suggested to use closed network or LAN with firewall protection to prevent cyber-attacks.

10.2.8 AS-FPFN02

When AS-FPFN02 is installed on AS300 PLC CPU, this communication card can work independently and does NOT occupy the communication port of PLC CPU. AS-FPFN02 can act as a PROFINET device and connect to a PROFINET controller to exchange data on the PROFINET Network (PN). When AS-FPFN02 is installed on AS00SCM-A, Delta AS Series I/O modules can be used remotely, and only available in RTU mode; NOT supported when installed on the right-side of the AS PLC CPU). Delta software does NOT support PN network configuration, you can use software from the PN controller for editing the PN parameters. After editing, you need to download the updated parameters to the controller and then the controller transfers the settings to AS-FPFN02.

10.2.8.1 Supported Firmware Versions

- When installed on AS300 series PLC CPU, it can be a PROFINET remote device:
The firmware of AS300 Series PLC should be V1.08 or later.
The firmware of AS-FPFN02 should be V1.00 or later.
- When installed on AS00SCM-A, it can be a PROFINET remote IO module:
The firmware of AS00SCM should be V2.06 or later.
The firmware of AS-FPFN02 should be V2.00 or later.
- It can work with Siemens PLC CPU: S7-1500, S7-1200, S7-300 and so forth. (TIA Portal V15.1 or later)
- To upgrade the hardware of AS-FPFN02 to version 2.00 is not supported.

10.2.8.2 Features

- When AS-FPFN02 is installed on AS300 PLC CPU or AS00SCM-A in RTU mode, it acts as a PROFINET device and exchanges data with PROFINET (PN) Controller. But AS00SCM-A that can be installed on the right-side of AS PLC CPU is NOT supported.
- Architecture: you can use software from the PN controller for editing the PN parameters. After editing, you need to download the updated parameters to the controller and then the controller transfers the settings to AS-FPFN02.

PROFINET Solution

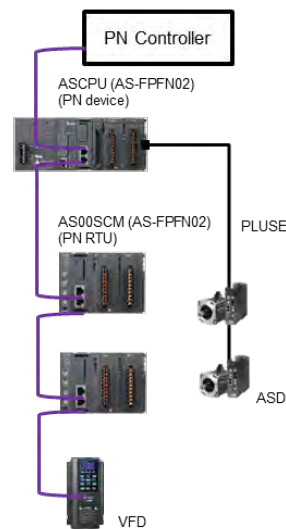

10.2.8.3 Specifications

Item	Specification	
Installed on PLC	AS300	AS00SCM-A
Communication Protocol	PROFINET RT	
EtherNet/IP Interface	100 Mbit with 2 x RJ45	
Fieldbus	PROFINET Devices	
Network Cable Length	100 meter	
Error Indicator	System Fail (SF): Red; Bus Fail (BF): Red	
Max. IO Slot Supported	17	9
Devices to Read and Write	AS300 series data registers	RTU IO modules
Minimum Time for Data Exchange to Operate	10 ms	
Maximum Data Length/Per Transmission	Input: 250 words Output: 250 words (Data of the module information is included, see the sections below.)	
PROFINET Configuration	Download PROFINET Configurations from PN Controller	

10.2.8.4 Configuring the Data Length for I/O Module (Works with AS300)

The module and IO module mentioned in here and other 10.2.8 sections indicates a unit of PN controller and AS300 for data exchange. And each module is treated as one data exchange.

When AS-FPFN02 communication card is installed on AS300 Series PLC, up to 500/500 bytes of I/O address area are available. From the following table you can create various kinds of data exchanges – different data length and functions (e.g. 32 word in- and output).

Set up the corresponding I/O module addresses to the AS300 data register addresses from the software of the upper computer. Refer to Section 10.2.8.8 for more reference.

Data Length (word)	1, 2, 4, 8, 10, 16, 32, 64, 100
Data Type	Input, Output, In- and Output

The total data size and the number of modules used are relevant. The total usage of I/O address area should also include IO Production Status (IOPS), IO Consumption Status (IOCS) of each module, also Device Access Point (DAP) and the bytes for information.

Module Type (for both DIO and AIO modules)	Additional Input Data Length (IOPS / IOCS)	Additional Output Data Length (IOPS / IOCS)
Slot 0 (DAP)	4 bytes	4 bytes
Input module	1 byte	1 byte
Output module	1 byte	1 byte
I/O module	2 bytes	2 bytes

From the following table, you can see that users need to count the module information in, otherwise, if exceeding the total size, PLC editing software would prompt an error message while compiling.

Slot	Module	In (byte)			Out (byte)			
		Data Size	IOPS / IOCS	Total	Data Size	IOPS / IOCS	Total	
0	AS300-CPU (DAP)*	0	4	4	0	4	4	
1	Status Register**	8	1	9	0	1	1	
2	100 Word In- and Output_1	200	2	202	200	2	202	
3	100 Word In- and Output_2	200	2	202	200	2	202	
4	16 Word In- and Output_1	32	2	34	32	2	34	
5	16 Word In- and Output_2	32	2	34	32	2	34	
6	04 Word Output	0	1	1	8	1	9	
Total Size					486			486

Note:

* DAP should be counted in the data of input and output module.

** Status Register is counted as the data of input module.

10.2.8.5 Status Register (Works with AS300)

When AS-PPFN02 is installed on AS300 Series PLC CPU, Slot 1 is used as status register to show the communication card status. Up to 8 bytes of status registers can be used for displaying the status of PN Device.

Status Register (Siemens S7-1500)	Name	Description
%I0.0	Input Data Available	If the value is TRUE, the input data to be sent to PN Controller is valid. If the value is 0, the input data to be sent to PN Controller is invalid.
%I4.0 - %I4.7	Connection Status	Indicates PN connection status of Slot 2 ~ Slot 9. If the value is TRUE, the Slot is with a working PN connection (with IO module) If the value is FALSE, the Slot is without a working PN connection.
%I5.0 - %I5.7		Indicates PN connection status of Slot 10 ~ Slot 17. If the value is TRUE, the Slot is with a working PN connection (with IO module) If the value is FALSE, the Slot is without a working PN connection.

- Determine whether the input data is valid.

You can check the first bit of the bytes %I0.0 (device register) to see if the data exchange is started; this can be used when the PN device starts to work. You can determine if the input data is valid by checking %I0.0 (device register); if it says TRUE, the input data is valid and data exchange can begin.
- Determine if the Slot is with a working PN connection.

You can check the corresponding registers %I4.0~%I4.7 and %I5.0~%I5.7 to see if the Slot 2~17 is with a working PN connection.

The following example shows the values in the corresponding registers %I4.0~14.22 are TRUE and that indicates Slot 2~4 are with PN connections respectively.

10.2.8.6 I/O Module Selection (Works with AS00SCM-A)

When AS-FPFN02 communication card is installed on AS00SCM-A, you can use PN Controller's Software to configure the modules. You can drag and drop the I/O modules to Slot 2 ~ 9. And then you can double-click the module to open the setting page and configure the module parameters.

Available for the following modules	
Digital modules	AS08AM10N-A, AS16AM10N-A, AS32AM10N-A, AS64AM10N-A, AS08AN01P-A, AS08AN01R-A, AS08AN01T-A, AS16AN01P-A, AS16AN01R-A, AS16AN01T-A, AS32AN02T-A, AS64AN02T-A , AS16AP11P-A, AS16AP11R-A, AS16AP11T-A
Analog modules	AS04AD-A, AS08AD-B, AS08AD-C, AS04RTD-A, AS06RTD-A, AS04TC-A, AS08TC-A, AS04DA-A, AS06XA-A

● Digital module addresses

Type	Module Name	Length to be used (bit)		Length is being used (bit)	
		In (I)	Out (Q)	In (I)	Out (Q)
Digital input	AS08AM10N-A	16	0	8	0
	AS16AM10N-A	16	0	16	0
	AS32AM10N-A	32	0	32	0
	AS64AM10N-A	64	0	64	0
Digital output	AS08AN01P-A AS08AN01R-A AS08AN01T-A	0	16	0	8
	AS16AN01P-A AS16AN01R-A AS16AN01T-A	0	16	0	16
	AS32AN02T-A	0	32	0	32
	AS64AN02T-A	0	64	0	64
Digital input/output	AS16AP11P-A AS16AP11R-A AS16AP11T-A	16	16	16	16

● Analog module addresses

- (1) The first two words of the input data head is the error code for the module.
- (2) Each channel takes two words of length, starting from channel 1, in numerical order.

Type	Module Name	Length to be used (word)		Length is being used (word)		
		In (I)	Out (Q)	In (I)		Out (Q)
				Error code	Data in channel	Data in channel
Analog input	AS04AD-A AS04RTD-A AS04TC-A	20	0	2	8	0
	AS06RTD-A	20	0	2	12	0
	AS08AD-B AS08AD-C AS08TC-A	20	0	2	16	0
Analog output	AS04DA-A	2	18	2	0	8
Analog input/output	AS06XA-A	10	10	2	8	4

● **Example**

Use S7-1500 as a Controller and AS remote module as the 1st Device. The address starts from 0. The actual used address for the module is from the starting address of each module shown on the software. For those unused addresses are reserved by the system. The unit is byte. For example, 20 to 21 is seen as a word and for the next word, it will be 22 to 23. The image shown below is the grouped module.



Slot	Module Name	Arrangement shown on the software		Device numbering in program editing		Explanation
		I	Q	I	Q	
1	AS00SCM-A (AS-FPFN02)	0~19	0~19	0~13	--	Status register Refer to the next section for more details
2	AS08AM10N-A	20~21	--	20.0~20.7	--	8 input points
3	AS16AM10N-A	22~23	--	22.0~23.7	--	16 input points
4	AS08AN01P-A	--	20~21	--	20.0~20.7	8 input points
5	AS16AP11P-A	24~25	22~23	24.0~24.7	22.0~22.7	8 input points, 8 point output
6	AS04AD-A	26~65	--	26~29	--	Module error code
				30~33		Channel 1
				34~37		Channel 2
				38~41		Channel 3
				42~45		Channel 4

10.2.8.7 Status Register (Works with AS00SCM-A)

When AS-FPFN02 is installed on AS00SCM-A, and Slot 1 is used as status register. The input data length of I address is 10 words for storing the current status of AS00SCM-A. Q address occupies 10 words and reserves for output data.

Status Register (Siemens S7-1500)	Name	Description
%IW0	Operation Status	0: STOP 1: RUN
%IW2	Error Code	For AS00SCM-A; refer to AS00SCM-A for more information
%IW4 - %IW18		For Slot 2 to slot 9; refer to its corresponding module chapter

The unit for the address series is byte. The data size for each status register is one word; %IW0 indicates from the address of 0 byte to read a length of word (%IB0 & %IB1) and the next word is %IW2 (%IB2 & %IB3) and so forth.

Select Slot 1 to set up when to Stop I/O module remotely. Double-click AS00SCM-A -> AS remote module in Device Setting and click **AS Serial Remote Module** in HWCONFIG. Refer to Section 9.4.3 from AS Module Manual for more information.

When the extension module is disconnected, the error code shown on AS00SCM-A is 16#1503. The address of the extension module that is disconnected from the AS00SCMA is shown 16#1604.

10.2.8.8 Example of AS-FPFN02 Acting as A PROFINET Device

This section shows using Manufacturer S software to create a PROFINET IO from S7-15XX and PLC, using the function card AS-FPFN02 to read data registers in Delta AS300 Series PLC.

1. The connection is established by Ethernet communication. The IP addresses of your PC and PN controller (S7-15XX) should be in the same network segment. The IP address of S7-15XX can be edited by its panel. The IP address of your PN device (AS-FPFN02) can be edited by PN Controller; see the steps below.
2. Create a new project.
 - Add a new device
 - Select a PN Controller Model
 - Select the Project View or click **Device & Network** to enter the Project View.
3. Install the GSDML file and add the device in.
 - Go to Delta Official Website Delta | Download Center ([Delta | Download Center \(deltawww.com\)](http://deltawww.com)) (steps: Select Product Category: Industrial Automation; Select Product Sub-Category: PLC- Programmable Logic Controllers; Select Series: AS Series; Filter: Electrical Parameter and click **Submit** and then find the **AS-FPFN02 (CPU) GSDML file**. Or if AS-FPFN02 is installed on the AS00SCM-A in RTU mode, find the **AS-FPFN02 (RTU) GSDML file**.
 - Download the GSDML file and then install the downloaded GSDML file in the Manufacturer S software.
 - After the installation is complete, go to *Project tree -> Device Configuration -> Network View*.
 - Find and select the just-installed device from the **Hardware Catalog** on the right and drag and drop the selected device to **Device View** on the left.
 - * ASCPU (AS-FPFN02): *Other field devices-> PROFINET IO-> PLCs & CPs-> Delta Electronics, Inc.-> PLC*
 - * AS00SCM-RTU (AS-FPFN02): *Other field devices-> PROFINET IO-> I/O-> Delta Electronics, Inc.-> RTU*
 - Drag the green block of S7-15XX to connect AS-FPFN02 together. Click AS-FPFN02 image to open the setting page and edit its IP address. *Properties-> General-> PROFINET interface-> Ethernet address*. The IP addresses of your PC and PN controller (S7-15XX) should be in the same network segment.
4. Define PN Device Name
 - Go to *Project tree-> Online access*, find the name of the function card and that is the PROFINET device name. The name for AS-FPFN02 is as it was saved from the last use. The default name is as-fpfn02.
 - Click **Online & diagnostics** and select **Assign PROFINET device name**. You can enter a new PROFINET device name and after that click **Assign name** to save the change.
 - Go back to the Network View and click the AS-FPFN02 image to enter the setting page to edit the device name to have it the same as you have set in the last step. *Properties -> General -> Name*.
5. Establish a connection

Click the S7-15XX image and go to Online-> Download to device. The IP address of AS-FPFN02 will be set as what you have set in the previous step. Compile and download the project.
6. Check the connection status

Go to *Online-> Go Online*, to check the connection status in the Project tree. If the project is downloaded successfully, the operation is normal and the basic configurations are complete, you can check signs in Local modules and Distribute I/O. You can also check the communication status of AS-FPFN02, if the indicators of SF and BF are OFF, the communication is normal.

7. Data Exchange

The range of data registers in AS300 PLC CPU that an AS-FPFN02 can read/write is between D0 and D29999. The data to be outputted is from PN controller to PN device. The data to be inputted is from PN device to PN controller.

8. Configuring the data length for I/O module

Select a right-side module and then configure the data length for it. Up to 250 bytes of data length is available for input and output respectively. Double click to add in order or drag and place it to the preferable position to add. If exceeding the limit, the parameters cannot be used. Refer to Section 10.2.8.4 for more details.

9. Setting up the starting address of the data register to exchange data.

Select an added module and enter the starting address in Module Parameters for data exchange. For example set the value "08 Word In- and Output_1" in Slot 2 and click the name in the Module to set the starting register address of the corresponding AS300: *Properties -> General-> Module parameters-> IO Address*.

When entering 100 in Input D Register and 200 in Output D Register and using a 8 Word In/Out module, the PN Controller reads values starting from D100 to D107 and writes the values in the data register starting from D200 to D207.

- PN Controller transmits 8 Words of data (Q0~Q15) to the data register D200~D207 in AS300 PLC CPU.
- AS-FPFN02 transmits 8 Words of data (D100~D107) to the data register I8~I23 in S7-15XX.
- The data exchange can only begin when the Bit Input Data Available is TRUE. Refer to Section 10.2.8.5 for more details.
- Apply the same setting procedure when AS-FPFN02 is installed in AS00SCM-A in RTU mode. But you need to pay attention on the IO modules in the software that should be consistent to the actual placement of the right-side of AS00SCM-A in RTU.

10.2.8.9 Network Security

To enhance security and performance of the system, it is suggested to use closed network or LAN with firewall protection to prevent cyber-attacks.

10.2.9 AS-FOPC02

AS-FOPC02 can be installed on AS300 PLC CPU. Communication can be done independently and that does NOT occupy the communication port of PLC CPU. It can act as an OPC UA Server. After AS-FOPC02 is installed, you can go to HWCONFIG from ISPSOFT to do the editing in Ethernet Port Basic Setting and Ethernet Port IP Filter.

All the AS-FOPC02 parameters are stored in AS300 PLC CPU. Go to HWCONFIG from ISPSOFT to check AS-FOPC02 IP address in the Function Card 2 section. You can also use COMMGR to see the IP address of this device.

10.2.9.1 Supported Firmware Versions

- The firmware of AS300 Series PLC should be V1.10.00 or later for AS-FOPC02 to be installed on it.
- AS00SCM-A does NOT support AS-FOPC02. You can NOT install AS-FOPC02 on AS00SCM-A.
- ISPSOFT version should be V3.13 or later.

10.2.9.2 Features

- When AS-FOPC02 is installed on AS300 Series PLC, it can act as OPC UA Server. The tag settings are the same as the network communication settings for AS Series; refer to Chapter 9 from AS Series Hardware and Operation Manual for more information.
- For PLC CPU with firmware version 1.10 or previous versions, before scanning to add AS-FOPC02 in, remember to change the setting “Setting delay time to detect I/O Module” to 3 seconds and then download the settings to PLC CPU.

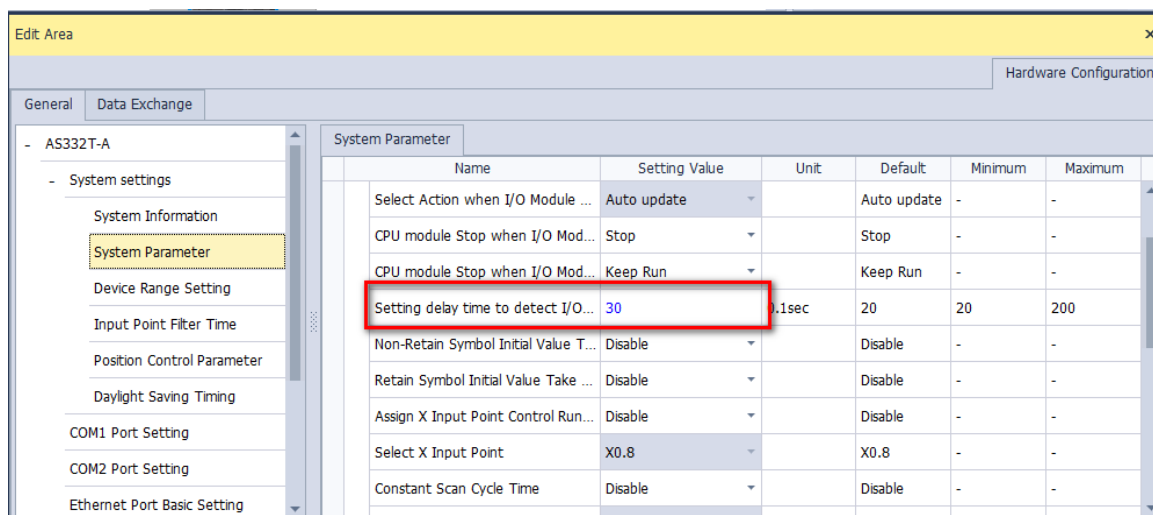

10.2.9.3 Specifications

- System Specifications

Item		Specification
General	Device type	Server
	Topology	Star and linear topologies are supported.
	IP Settings	When installed on AS300 PLC CPU, you can use HWCONFIG from ISPSOft for editing
	Availability	AS300 Series PLC
Web	Max. connection number	8
	Functions	View device information Account management AS-FOPC02 firmware update

- Modbus TCP Specifications

Item		Specification
General	Device type	Server (TCP port: 502)
Modbus TCP Server	Max. connection number	8
	Max. data length	200 words

- OPC UA Specifications

Item		Specification		
General	Device type	Server (TCP port: 4840)		
OPC UA Server	Max. sessions	6 (Clients)		
	Max. tags	1000		
Security policy		None		
Authentication		Anonymous		
Default endpoint/port		opc.tcp://192.168.1.5:4840/		
Transport protocol / encoding		opc.tcp / binary		
Supported profiles		UA v1.03 Nano Embedded Device Server Profile		
Sampling rate (ms)		100, 200, 300(default), 400, 500, 600...50000		
Publish interval (ms)		100, 200, 300, 400, 500(default), 600...50000		
Supported data type		Int16, UInt16, Int32, UInt32, Float, Boolean		
Max. subscription per session		2		
Max. monitored items		3000 (including all sessions)		
Session timeout (ms)		5000 ~ 30000		
Subscription keep alive count		1~1000ms		
Restrictions	1) Maximum data size of monitor items for all sessions < 50000bytes			
	1~500	Monitor Items	Total Data size of monitor items (Bytes)	Sampling and Publish interval time (second)
			1~10000	1
		10001~20000	2	
		20001~30000	3	
		30001~40000	4	
	501~1000	Monitor Items	Total Data size of monitor items (Bytes)	Sampling and Publish interval time (second)
			1~10000	2
		10001~20000	3	
		20001~30000	4	
		30001~40000	5	
	40001~50000	6		

Item	Specification		
	1001~1500	1~10000	3
		10001~20000	4
		20001~30000	5
		30001~40000	6
		40001~50000	7
	1501~2000	1~10000	4
		10001~20000	5
		20001~30000	6
		30001~40000	7
		40001~50000	8
	2001~2500	1~10000	5
		10001~20000	6
		20001~30000	7
		30001~40000	8
		40001~50000	9
	2501~3000	1~10000	6
		10001~20000	7
		20001~30000	8
		30001~40000	9
		40001~50000	10
2) Maximum tag array elements = 512 or data size < 400Bytes			
3) Maximum tag name length = 40bytes			

10.2.9.4 Special Data Registers (SR) for AS300 Series Only

SR	Function	AS300 Series	AS200 Series	OFF ↓ ON	STOP ↓ RUN	RUN ↓ STOP	Latched	Attribute	Default
SR913	Total data of ASFOPC02 monitor items; unit: bytes; low word	○	—	0	—	—	N	R	0
SR914	Total data of ASFOPC02 monitor items; unit: bytes; high word	○	—	0	—	—	N	R	0
SR1430	Connection number of AS-FOPC02 OPC UA Server	○	—	0	—	—	N	R	0
SR1537	Connection number of AS-FOPC02 Modbus/TCP Server	○	—	0	—	—	N	R	0

Special data register	Refresh time
SR913, SR914, SR1430, SR1537	The flag is ON, when the system is refreshed automatically.

10.2.9.5 OPC UA Server

When AS-FOPC02 is installed on AS300 Series PLC, it can act as an OPC UA Server. Follow the steps below to create Tags on AS300 Series PLC via OPC UA variables.

- (1) Open ISPSOft and create a new project and then double-click **Global OPC UA Variables** under the **Global Symbols** node to open the **Global OPC UA Variables** setting table.



The screenshot shows the 'Global OPC-UA Variables' configuration window. It contains a table with the following columns: Class, Identifiers, Address, Type, Initial Value, and Identifier Comment. The table is currently empty.

Class	Identifiers	Address	Type	Initial Value	Identifier Comment

- (2) Right-click on the **Global OPC UA Variables** setting table to see the context menu. Click **Add a Symbol** to open the setting page.

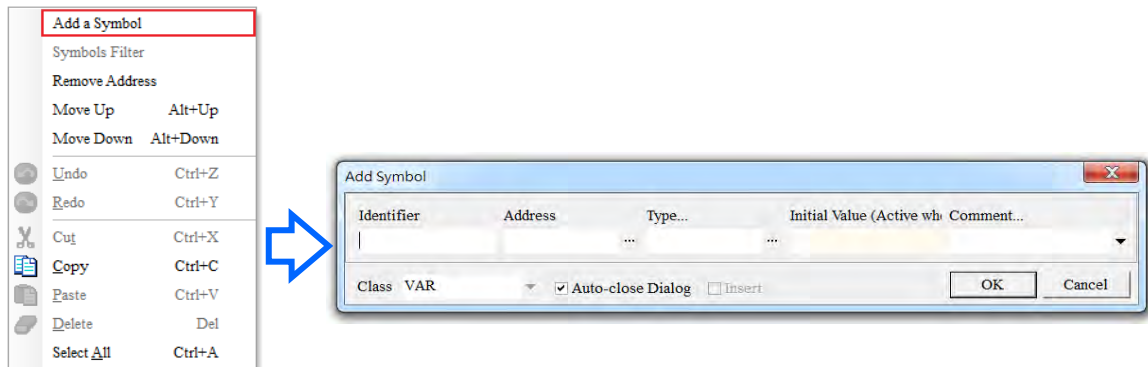

- (3) Set up the OPC UA tag. See the following example for reference.
Supported data types are: WORD, DWORD, INT, DINT, REAL, and ARRAY; supported data types in ARRAY are BOOL, WORD, DWORD, INT, DINT, and REAL.

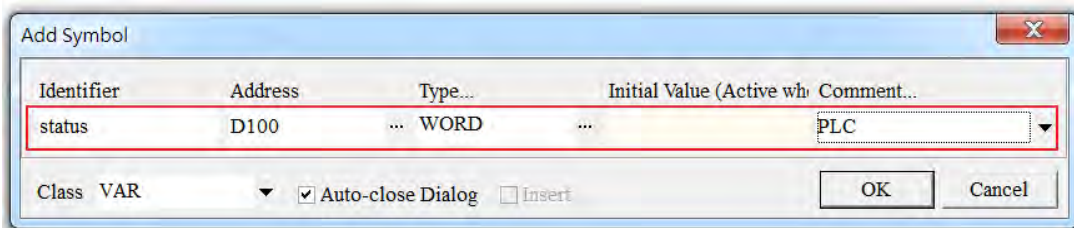

- (4) After the settings are complete, download the settings to PLC. After that devices can read/write the Tag. The way to connect to the Tags varies in different brands. Refer to the specific device manual for more information on using tags to connect.

10.2.9.6 Setting UTC Time in OPC UA Server

When AS-FOPC02 is installed on AS300 PLC CPU. You can create a connection through OPC UA and then the AS300 PLC CPU can be an OPC UA Server. Follow the steps below to set up the RTC and the time zone of OPC UA UTC.

(1) Set up the AS300 RTC

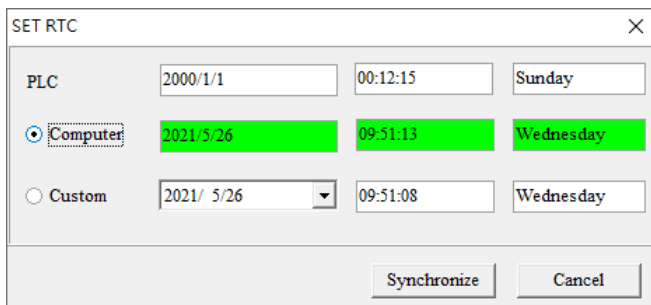
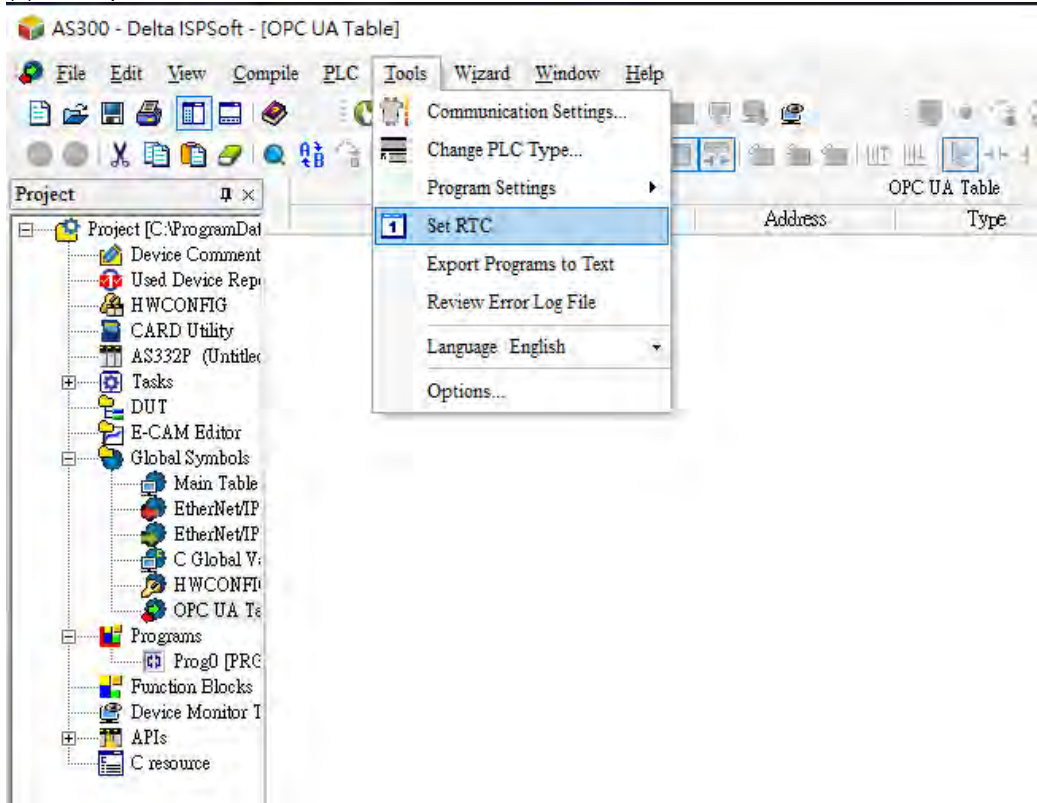

(2) Set up the time zone.

Edit Area

General Data Exchange

Device Range Setting

Input Point Filter Time

Position Control Parameter

Daylight Saving Timing

COM1 Port Setting

COM2 Port Setting

Ethernet Port Basic Setting

- Ethernet Port Advanced Setting

IP Filter

NTP

+ Email

+ Socket

Name	Setting Value	Unit
NTP Client Function Enable	<input type="checkbox"/>	
NTP Server	1.1.1.1	
Update Cycle	30	min
Time Zone	(GMT-12:00) Eniwetok, Kwajalein	

10.2.9.7 Network Security

To enhance security and performance of the system, it is suggested to use closed network or LAN with firewall protection to prevent cyber-attacks.

10.2.9.8 The copyright information about the Used External Software Sources

- lwIP TCP/IP stack
Copyright (c) 2001-2004 Swedish Institute of Computer Science.
All rights reserved.

Redistribution and use in source and binary forms, with or without modification, are permitted provided that the following conditions are met:

1. Redistributions of source code must retain the above copyright notice, this list of conditions and the following disclaimer.
2. Redistributions in binary form must reproduce the above copyright notice, this list of conditions and the following disclaimer in the documentation and/or other materials provided with the distribution.
3. The name of the author may not be used to endorse or promote products derived from this software without specific prior written permission.

THIS SOFTWARE IS PROVIDED BY THE AUTHOR ``AS IS AND ANY EXPRESS OR IMPLIED WARRANTIES, INCLUDING, BUT NOT LIMITED TO, THE IMPLIED WARRANTIES OF MERCHANTABILITY AND FITNESS FOR A PARTICULAR PURPOSE ARE DISCLAIMED. IN NO EVENT SHALL THE AUTHOR BE LIABLE FOR ANY DIRECT, INDIRECT, INCIDENTAL, SPECIAL, EXEMPLARY, OR CONSEQUENTIAL DAMAGES (INCLUDING, BUT NOT LIMITED TO, PROCUREMENT OF SUBSTITUTE GOODS OR SERVICES; LOSS OF USE, DATA, OR PROFITS; OR BUSINESS INTERRUPTION) HOWEVER CAUSED AND ON ANY THEORY OF LIABILITY, WHETHER IN CONTRACT, STRICT LIABILITY, OR TORT (INCLUDING NEGLIGENCE OR OTHERWISE) ARISING IN ANY WAY OUT OF THE USE OF THIS SOFTWARE, EVEN IF ADVISED OF THE POSSIBILITY OF SUCH DAMAGE.

10.2.10 AS-FFTP01

AS-FFTP01 can only be installed on AS Series PLC CPU. Communication can be done independently and that does NOT occupy the communication port of PLC CPU. It supports IIoT related protocols. After AS-FFTP01 is installed, you can go to HWCONFIG from ISPSOft for editing.

The AS-FFTP01 basic parameters (IP address and other parameters) are stored in AS Series PLC CPU. Other parameters are stored in the SD card. After AS-FFTP01 is installed on AS Series PLC CPU, you can use the following steps to obtain the parameters and make sure the IP address of AS-FFTP01 is correct.

1. Go to HWCONFIG from ISPSOft to upload the AS Series PLC CPU parameters and to check the IP address of AS-FFTP01.
2. If the IP address is a dynamic one, use COMMGR to scan and check the IP address of this device.

10.2.10.1 Supported Firmware Versions

- The firmware of AS Series PLC should be V1.12 or later for AS-FFTP01 to be installed on it.
- AS00SCM-A does NOT support AS-FFTP01. You can NOT install AS-FFTP01 on AS00SCM-A.
- ISPSOft version should be V3.16 or later.

10.2.10.2 Specifications

● System Specifications

Item	Specification
Device Type	IIoT module
Availability	AS Series PLC
Topology	Star and linear (end point) topologies are supported.
IP Settings	When installed on AS Series PLC CPU, you can use HWCONFIG from ISPSOFT for editing
Storage Interface	Micro SD (up to 32GB supported)

● Supported Protocols

Name	Description
OPC UA Server	It can act as an OPC UA Server. AS-FFTP01 and AS-FOPC02 share the same OPC UA symbols table in ISPSOFT.
FTP Server	File Transfer Protocol (FTP); enter the IP address or the network name and the port number (default 21) in FTP Client and then enter username and password to log in. The read/write permission varies according to different users. You can set up the parameters and the user permission in HWCONFIG.
Data Log	You can save data in .csv file format, save user-defined contents in a table, and design triggering conditions. The data log will be saved in the SD card on AS-FFTP01 and which can be retrieved from the SD card or obtained through FTP Server.
MQTT Client	MQTT Client supported; you can use APIs of PLC and message broker to create connections, publish and subscribe messages. For AS-FFTP01 with firmware version 1.00 or previous version, only Amazon Web Services (AWS) is supported.
Web Server	Web page function is supported. (AS Series PLC CPU has its own independent web page.) You can monitor the diagnosis of the communication card and update firmware through the webpage. Node-RED Dashboard is supported, you can use Node-RED editor to read/write data from the AS Series registers.
Modbus TCP Server	Modbus TCP communication supported; the upper computer of Modbus TCP can use AS-FFTP01 communication card to read/write AS Series PLC CPU; up to 8 connections are supported simultaneously.

● Modbus TCP Specifications

Item	Specification
Device type	Modbus TCP Server
Communication port	502
Maximum connection number	8
Maximum data length	200 words

● Standard Modbus device address

Device	Type	Format	Range	Modbus address (Dec)	AS Series Address (Hex)
X	Bit	DD.DD	X0.0~X63.15	124577~125600	6000~63FF
	Word	DD	X0~X63	332769~332832	8000~803F
Y	Bit	DD.DD	Y0.0~Y63.15	040961~041984	A000~A3FF
	Word	DD	Y0~Y63	440961~441024	A000~A03F
M	Bit	DDDD	M0~M8191	000001~008192	0000~1FFF
SM	Bit	DDDD	SM0~SM4095	016385~020480	4000~4FFF

SR	Word	DDDD	SR0~SR2047	449153~451200	C000~C7FF
D	Word	DDDDD	D0~D29999	400001~430000	0000~752F
S	Bit	DDDD	S0~S2047	020481~022528	5000~57FF
T	Bit	DDD	T0~T511	057345~057856	E000~E1FF
	Word	DDD	T0~T511	457345~457856	E000~E1FF
C	Bit	DDD	C0~C511	061441~061952	F000~F1FF
	Word	DDD	C0~C511	461441~461952	F000~F1FF
HC	Bit	DDD	HC0~HC255	064513~064768	FC00~FCFF
	DWord	DDD	HC0~HC255	464513~464768	FC00~FCFF
E	Word	DD	E0~E9	465025~465039	FE00~FE09

● **Standard Modbus function codes and range**

Function code	Description	Applicable to devices	Supported device range
01	Read multiple bit devices	X, Y, M, SM, S, T, C, HC	1~1600
02	Read multiple bit devices	X, Y, M, SM, S, T, C, HC	1~1600
03	Read multiple word devices	X, Y, SR, D, T, C, HC, E	1~100, but for HC: 1~50
04	Read multiple word devices	X	1~100
05	Write the status in a single bit device	Y, M, SM, S, T, C, HC	1
06	Write data in a single word device	Y, SR, D, T, C, HC, E	1
0F	Write the status in multiple bit devices	Y, M, SM, S, T, C, HC	1~1600
10	Write the status in multiple word devices	Y, SR, D, T, C, HC, E	1~100, but for HC: 1~50
17	Read/write the status from/in multiple word devices	Y, SR, D, T, C, HC, E	1~100, but for HC: 1~50

10.2.10.3 Before You Begin

- **Setting up IP Address**

1: Scan to add AS-FFTP01 in (recommended) or set the Function Card 2 to AS-FFTP01 in HWCONFIG.

2: Go to *Function Card 2 Setting* -> *Ethernet Port Basic Setting* to set up the IP address for AS-FFTP01.

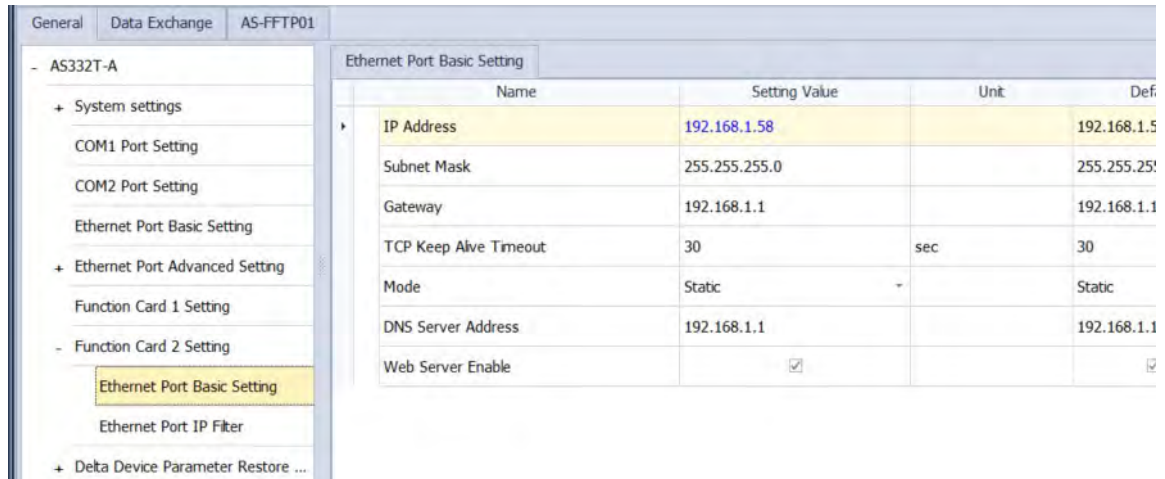

3. After setting is done, download the parameters from HWCONFIG. And the Ethernet settings will be stored in AS Series PLC CPU. If you replace the AS-FFTP01 communication card with another one, there is no need to set up the IP address again.

4. After connecting to AS-FFTP01 via Ethernet, you can use COMMGR to scan for AS-FFTP01 and check its IP address.

- **Setting up NTP (RTC and Time Zone)**

It is required to have accurate time for AS-FFTP01. And AS-FFTP01 time is synchronizing with the time of AS Series PLC CPU. There it is necessary to check the time accuracy of AS Series PLC CPU.

1. Go to *HWCONFIG* -> *Ethernet Port Advanced Setting* -> *NTP*.

2. If there is a NTP Server, you can enable NTP Client Function.

3. If there is no NTP Server, you can go to *ISPSOFT* -> *Tool* -> *Real Time Clock* to set up the time for AS Series PLC CPU.

4. After setting up the Time Zone and the RTC, power off and then power on AS Series PLC CPU. AS-FFTP01 time will synchronize with the time of AS Series PLC CPU.

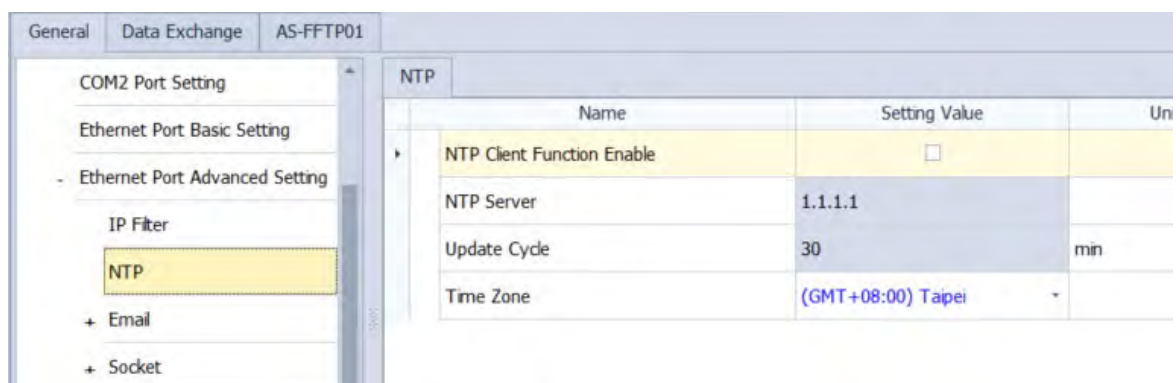

• **Setting up the parameters**

1. Go to *HWCONFIG* -> *AS-FFTP01* setting page to set up. You will need to use Upload and Download buttons on this page to upload/download the parameters set for AS-FFTP01. The upload/download function on the PLC CPU setting page does not include the parameters of AS-FFTP01.
2. Use the Upload and Download buttons on the AS-FFTP01 setting page to upload/download the parameters to the project. This will not alter the AS PLC CPU parameters in the project.
3. Note: After powering on or downloading the parameters, AS-FFTP01 will begin initializing. After the initialization is done, the upload/download can be executed again. Once AS-FFTP01 is ready, the MS LED will be ON. (Green LED).
4. Password: A password can be created or changed to protect AS-FFTP01. This password should be different from other projects or webpages. It is required to enter the created password whenever you need to upload/download AS-FFTP01 in HWCONFIG. You can delete the old password by leaving the new password field blank and press the enter key.
5. Restore to default settings: This only restores the AS-FFTP01 parameters to defaults. AS PLC CPU parameters will not be affected.

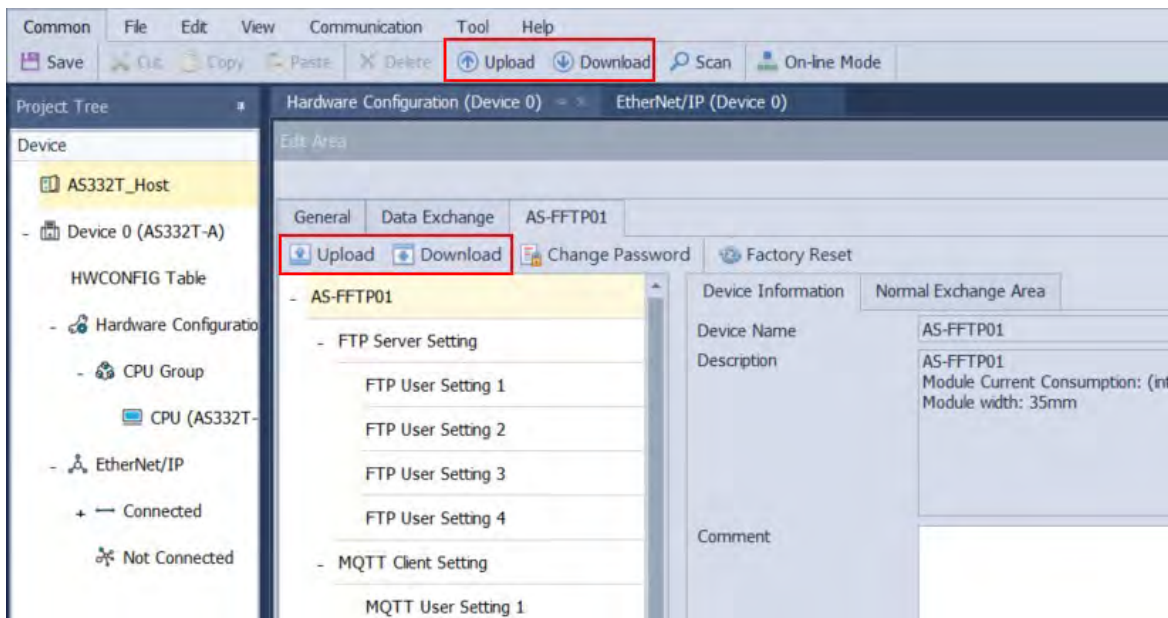

10.2.10.4 OPC UA Server

- OPC UA Specifications

Item	Specification
Device Type	OPC UA Server
TCP Port	4840
Maximum Sessions	6 (Clients)
Maximum Tags	1000
Security policy	None, Basic128Rsa15 – Sign, Basic128Rsa15 - Sign & Encrypt Basic256 – Sign Basic256 - Sign & Encrypt
Authentication	Anonymous Sign
Default endpoint/port	opc.tcp://192.168.1.5:4840/
Transport protocol / encoding	opc.tcp / binary
Supported profiles	UA v1.03 Nano Embedded Device Server Profile
Sampling rate (ms)	100, 200, 300(default), 400, 500, 600...50000
Publish interval (ms)	100, 200, 300, 400, 500(default), 600...50000
Supported data type	Int16, UInt16, Int32, UInt32, Float, Boolean
Max. subscription per session	2
Max. monitored items	3000 (including all sessions)
Session timeout (ms)	5000 ~ 30000
Subscription keep alive count	1~1000ms

When AS-FFTP01 is installed on AS PLC CPU, OPC UA clients can create connections through OPC UA and AS-FFTP01 to read and write OPC UA tags of AS PLC CPU. It is required for AS-FFTP01 to communicate with an OPC UA client certificate; communication without OPC UA client certificate is not supported. Set up the related parameters in HWCONFIG.

Refer to the following steps and examples for more information.

- Enable / disable OPC UA Server
As long as there is OPC UA tags created in ISPSOft, OP UA Server is enabled. If you need to disable OPC UA Server, all you need to do is clear all the OPC UA tags.
- Create OPC UA Tags in ISPSOft. (Refer to sections 10.2.9.5 and 10.2.9.6.)
- Make sure if the IP address, time and time zone are accurate in AS-FFTP01.
- Create an username and password.
 - Go to *HWCONFIG* -> *AS-FFTP01* -> *OPC UA Server Setting*: You can use anonymous to login by ticking the option **Allow Anonymous Login**. Otherwise, you will need to create a username and a password.

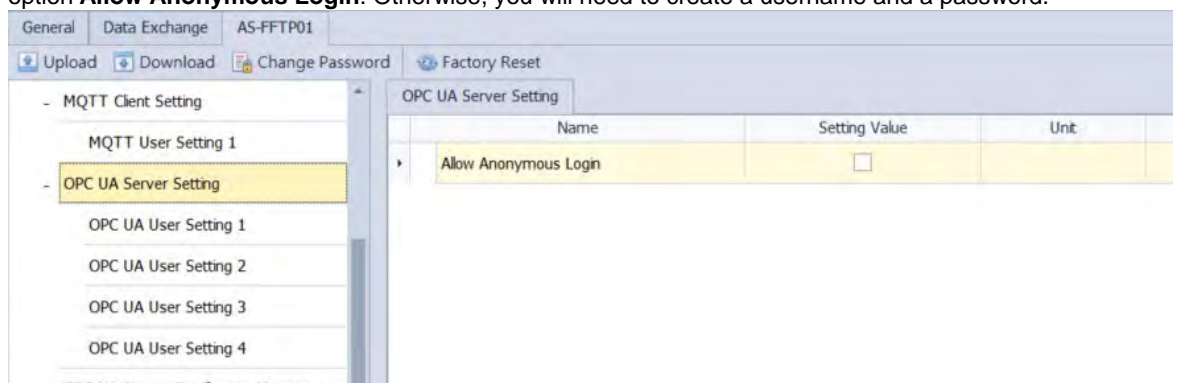

- (2) Go to *HWCONFIG -> AS-FFTP01 -> OPC UA Server Setting -> OPC UA User Setting 1*: Create an User name and a Password. Up to 4 unique user names can be created.

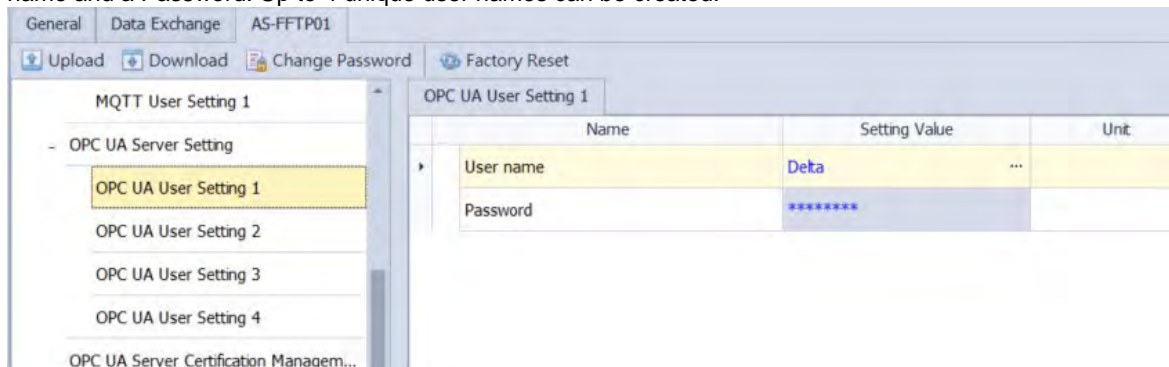

- (3) Download the AS-FFTP01 parameters.

5. Client Certificate: Since communication without a client certificate is not supported, you will need to create one. The followings demonstrate how to create a Client Certificate by using VTScada.

- (1) Establish a VTScada connection.
 - i. Create a communication port.

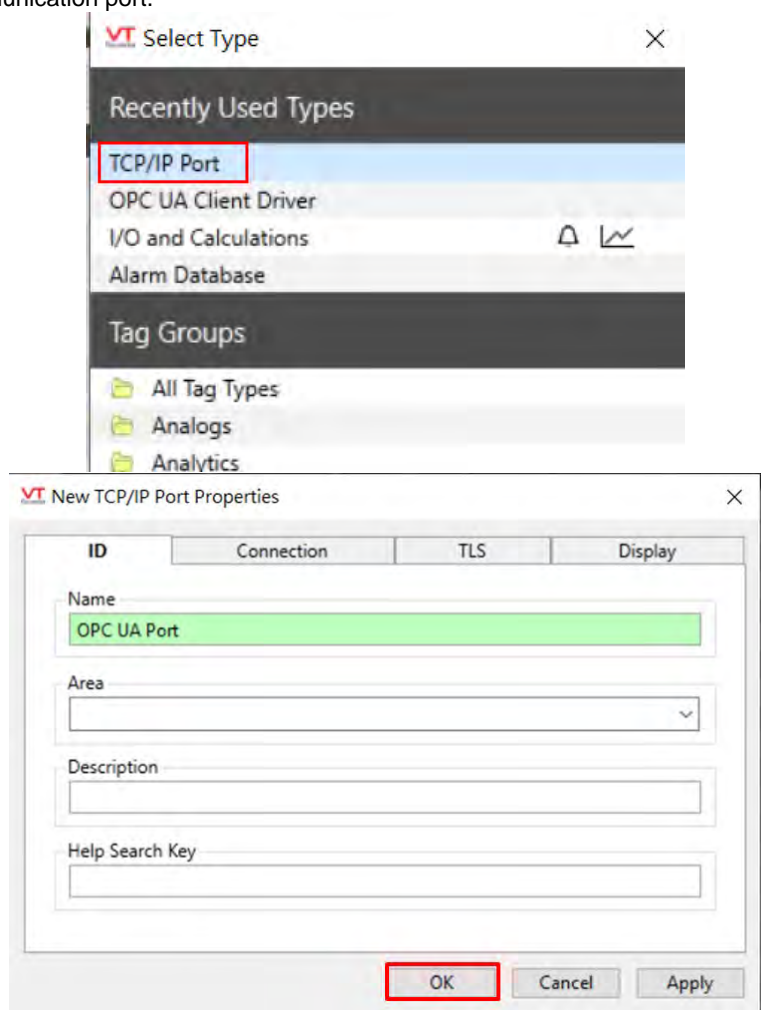

- ii. Create a connection.

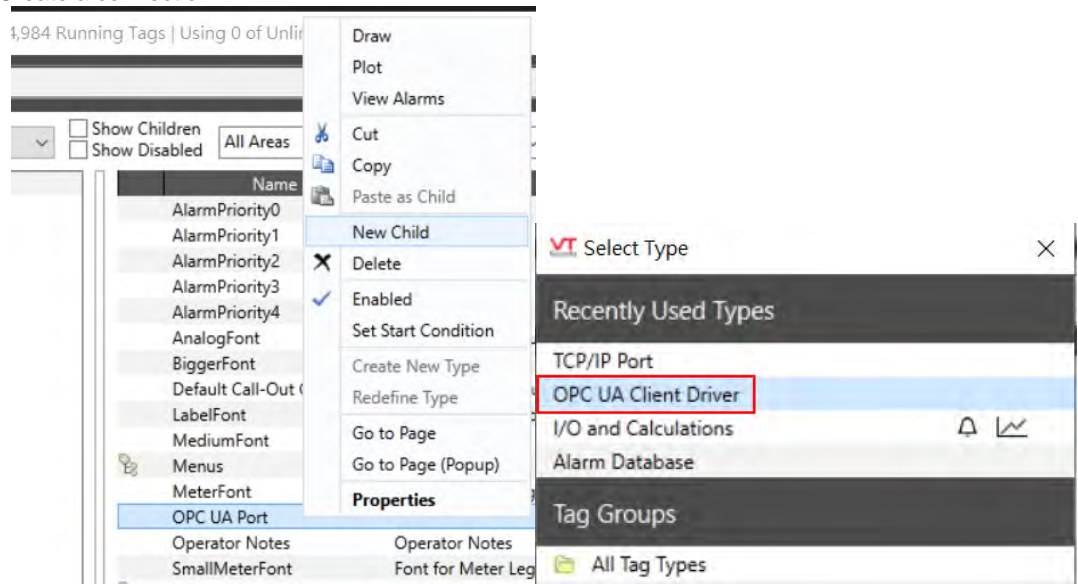

- iii. Enter the Endpoint URL: Use the format: **opc.tcp://AS-FFTP01 IP Address:4840**

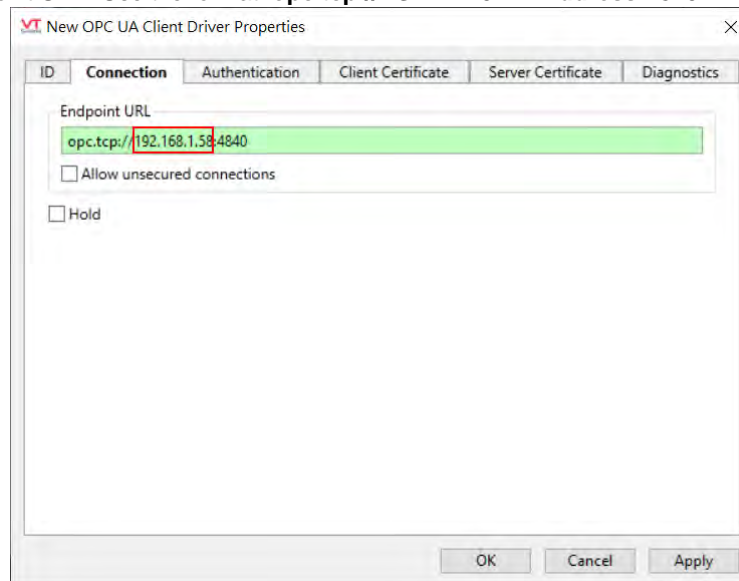

- iv. Enter the username and password

You can select **Anonymous** if you have ticked the option **Allow Anonymous Login** in the OPC UA Server Setting. If not, you need to select Username and then enter the username and password you have created.

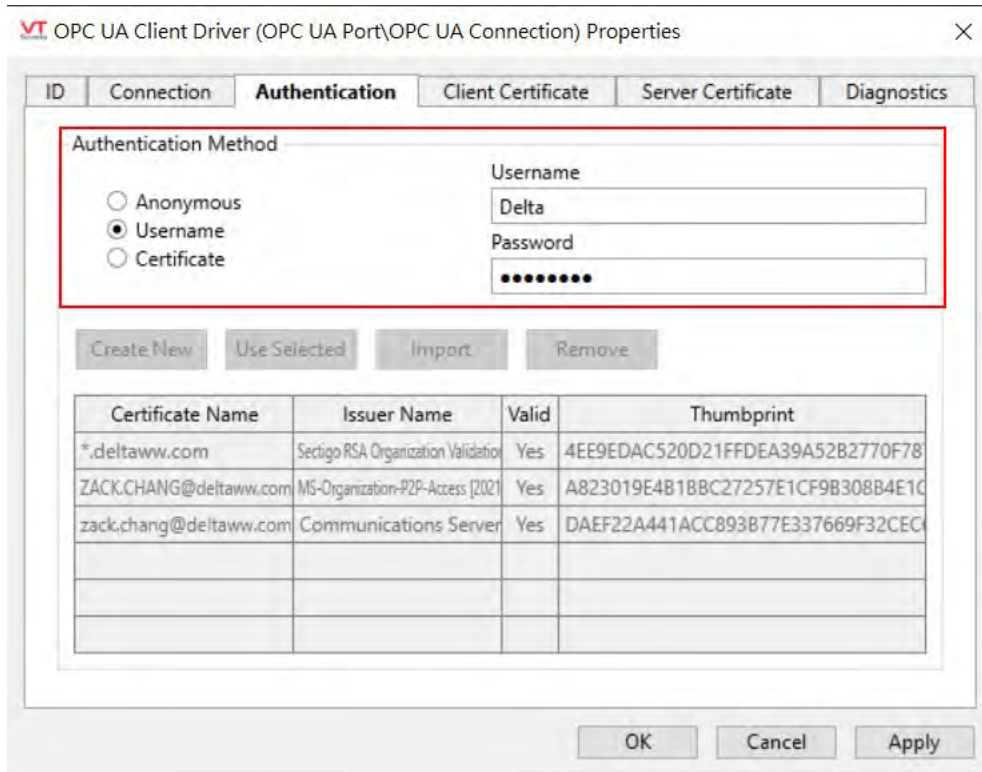

(2) Client Certificate

- i. Set up the Client Certificate: Under the **Client Certificate** tab, select the valid one from the list and click **Use Selected** and then click **Apply**.

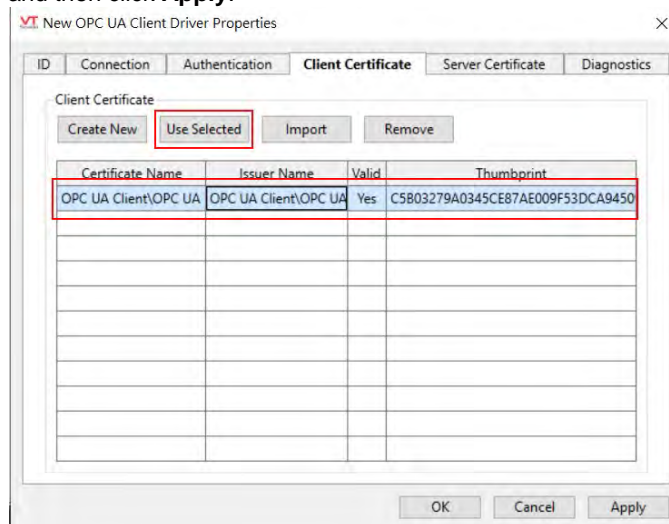

- ii. Make sure AS-FFTP01 is connected through EtherNet. Go to Server Certificate page and use **Add Trust** button to add all the valid ones to the Trust list.

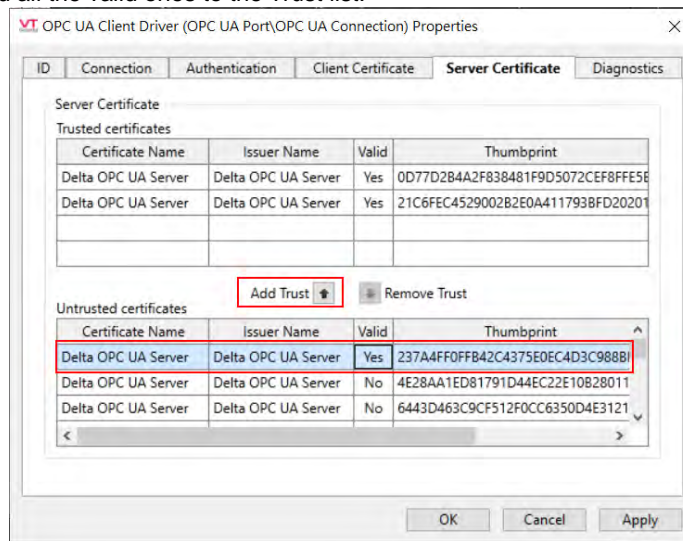

- iii. AS-FFTP01 will renew its Client Certificate automatically if any of the following executions is performed, RTC adjust, time zone adjust, firmware update or restoring back to defaults. If you have problem connecting to OPC UA Client, follow the previous steps to set up the Client Certificate again.
- (3) Set up OPC UA Server Certification for AS-FFTP01.
- i. After setting up Client Certificate in VTScada, you need to upload parameters on AS-FFTP01 to HWCONFIG.
 - ii. After that, go to *HWCONFIG -> AS-FFTP01 -> OPC UA Server Setting -> OPC UA Server Certification Management*.

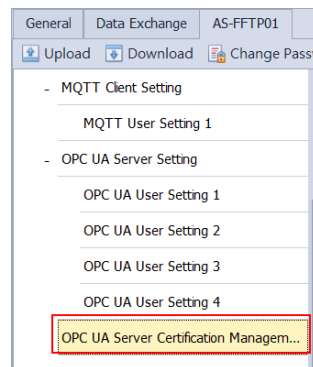

- iii. Select the certificates from the right and then click the directional button (to the right) to add the selected ones to the Trust List on the left.

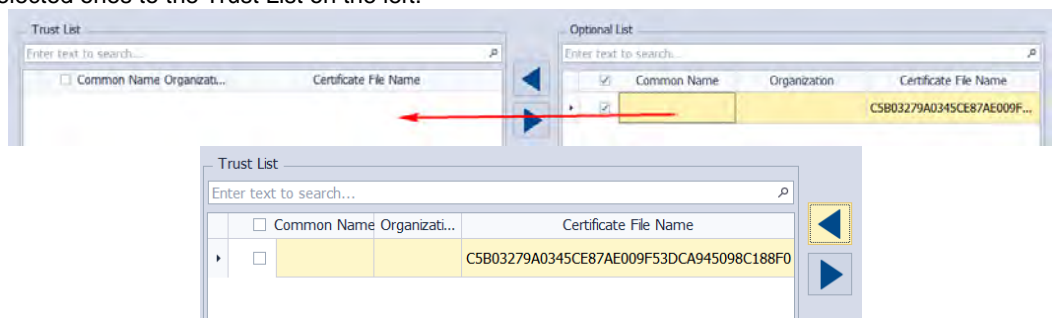

- iv. Download AS-FFTP01 parameters.
- v. If you need to clear the unwanted certificates, you need to synchronize the certificates in HWCONFIG and AS-FFTP01 by using **Upload** and **Download** buttons. After that, select the option **Clear all optional certificates** to remove unwanted certificates.

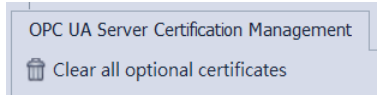

After the initialization is done, the MS LED will be ON. (Green LED). Upload the AS-FFTP01 parameters and the certificate list is updated and the unwanted certificates are cleared.

(4) Connection

- i. After setting up the client certificates for AS-FFTP01, click **Restart Comms** to restart connection in VTScada.

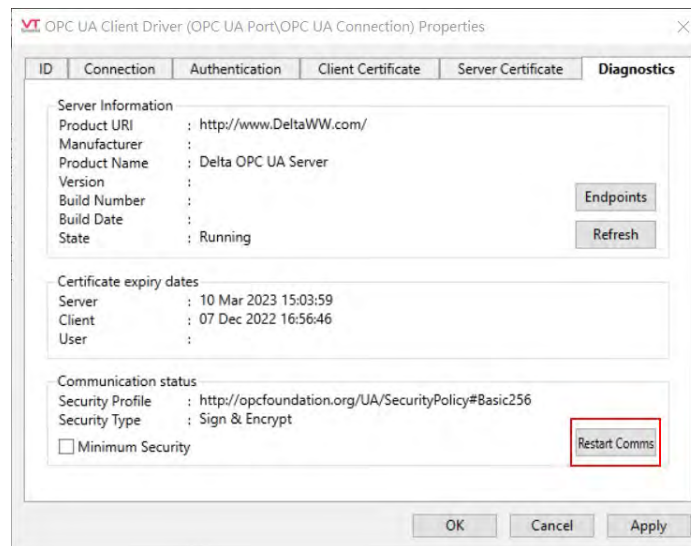

- ii. Check the OPC UA Connection. If the value is 0, that means the connection is working fine. If the value is any other number, you will need to check the VTScada manual to see what that error code indicates.



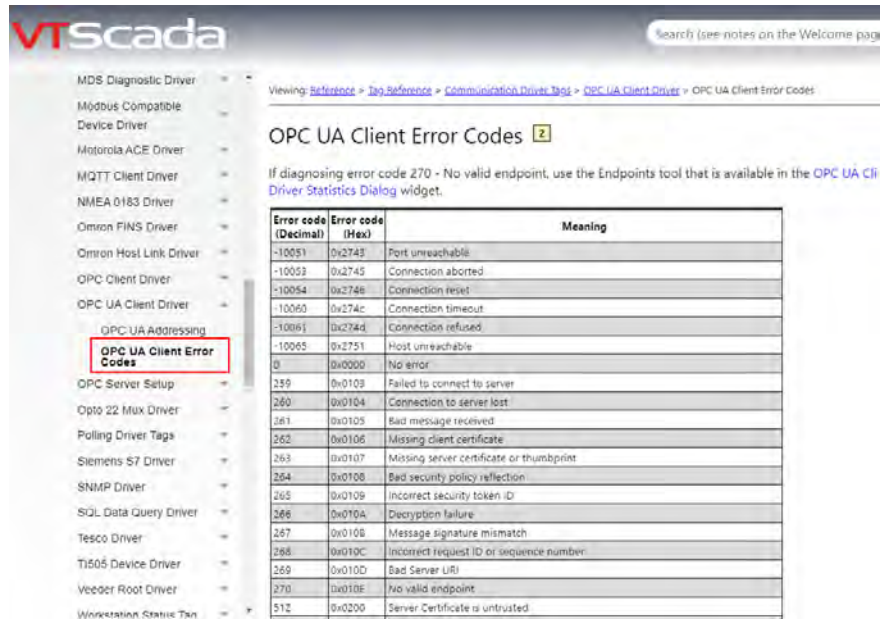

- (5) Create Tags
 - i. Select **I/O and Calculations**.

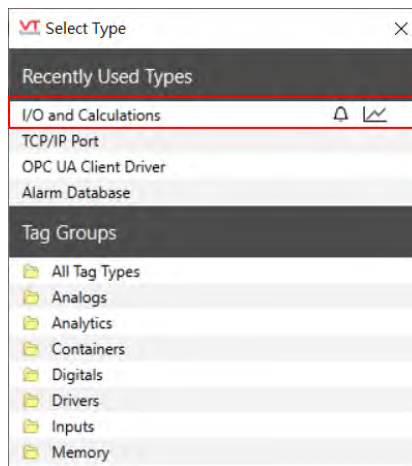

- ii. Set up Data Type.

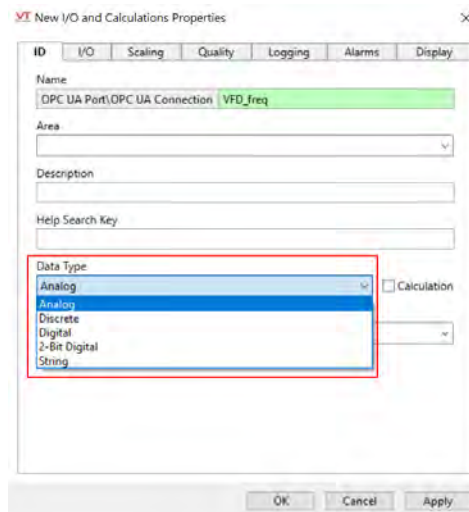

- iii. Click **OPC UA** under **I/O** tab to open the setting page. And OPC UA tags created in ISPSOft will appear in here for selection.

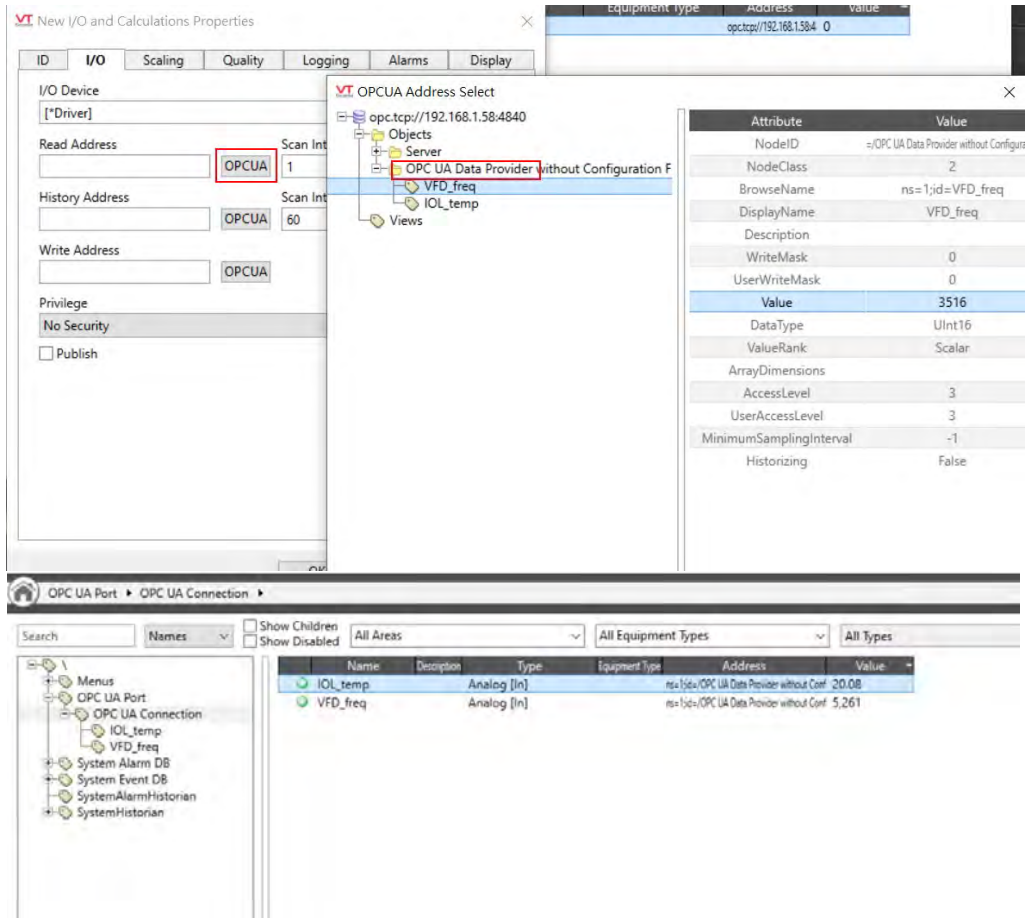

6. Application Diagnostic - OPC UA

- (1) Connection error
 - i. Make sure the client end and server end are in each other's trust list.
 - ii. Make sure the username and password are correct.
 - iii. If the MS LED is green and blinking, that means OPC UA server is initializing or starting up. You will need to reconnect once the MS LED is green and ON.
 - iv. If MS LED is red and ON / blinking, power off and power on the device. And then check the error code stored in SR38 of AS Series PLC CPU.
- (2) Log in to the webpage and then go to *Diagnostic* -> *Application diagnostic* to check the OPC UA Server status. If its status is in error, you can use **Reboot** button to restart the OPC UA Server.

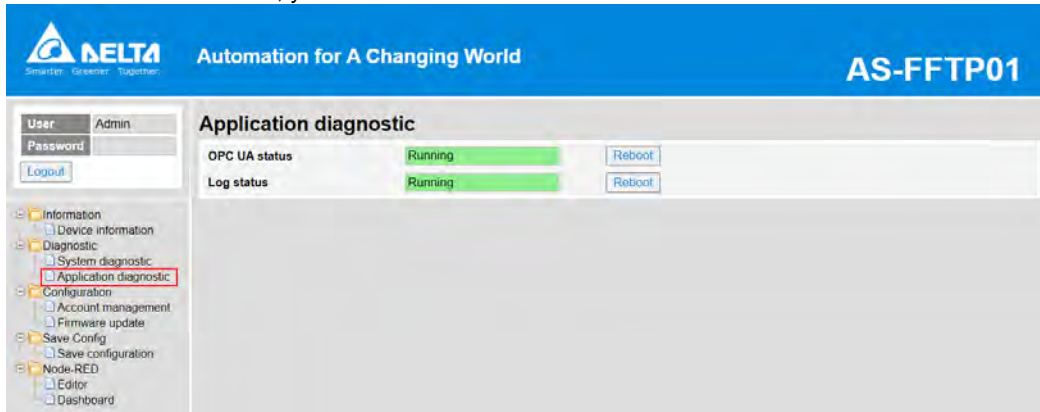

10.2.10.5 FTP Server

- **FTP Specifications**

Item	Specifications
Device type	FTP Server
Communication port	21 (default)
Maximum user accounts	4 (at least one user should be created)
Data storage	SD card

It is required for AS-FFTP01 to have a SD card inserted to use FTP function. SD card of AS-FFTP01 can be accessed by the FTP software. FTP server function is supported but not FTPS nor SFTP.

- When there is no card reader, FTP function can be used with Log function, and if necessary, system log output and firmware update functions on the webpage can be used together. Refer to the following sections for more details.
- Set up the related parameters in HWCONFIG. Refer to the following steps and examples for more information.
 1. Make sure the IP address, time and time zone of AS-FFTP01 are accurate. (refer to section 10.2.10.4 for more information).
 2. Enable FTP Server.

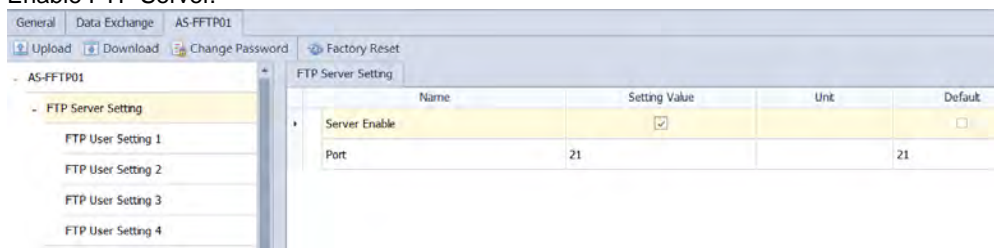

3. Make sure the port that FTP is going to use. (default: 21; no need to change it if there is no other concern).
4. Set up the user account and password for users to log in to FTP Server. Up to 4 unique users can be set. At least one user account should be created.



- Use FTP Client from your computer to connect to AS-FFTP01. Enter the followings:
 1. IP address of the communication or the network name.
 2. Port number (default: 21)
 3. User account and password

After that AS-FFTP01 is connected and you can upload/download data on the SD card of AS-FFTP01.

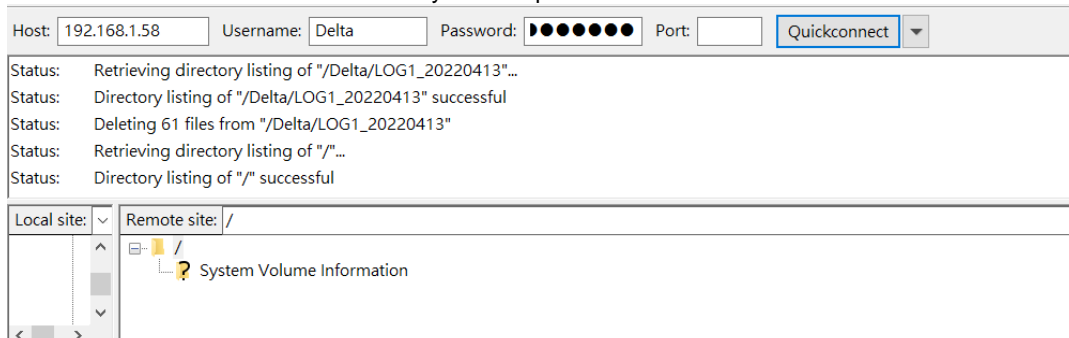

- The following folders and zip files are for system use. Do not edit or remove them. If the files are deleted accidentally, you can download the AS-FFTP01 parameters again from HWCONFIG.

Filename	Filesize	Filetype	Last modified	Permissions	Owner/G...
..					
System Volume Information		File fold...	1/14/2022 1:11:00 A...	drwxrwxrwx	0 0
iot.zip	1,263	Compre...	4/13/2022 2:57:00 P...	-rwxrwxrwx	0 0
uasave.zip	3,937	Compre...	4/13/2022 2:57:00 P...	-rwxrwxrwx	0 0

10.2.10.6 Log

- Log Specifications

Item	Specification
Device Type	Registers M and D
Supported Format	BOOL, INT16, UINT16, INT32, UINT32, Float
Supported User Account	4
Log Mode	<ul style="list-style-type: none"> PLC Run Always Enable Program Control
Creating a new subdirectory when any of the conditions is met.	<ul style="list-style-type: none"> Over 500 pieces of data Every self-defined date (cyclic) Every self-defined month (cyclic)
Creating a new file when any of the conditions is met.	<ul style="list-style-type: none"> Self-defined minutes (1-1440) Self-defined hours (1-168) Self-defined days (1-31) Over 10000 pieces of data
Data storage	SD card

You can save the data to the SD card in .csv file that is installed on AS-FFTP01. Up to four groups of logs (Log1 to Log4) can be set. Each group of log can set its own triggering conditions to log data. You can retrieve data from the SD card or through FTP to download data.

- Before you begin:
 - Make sure a SD card is installed in AS-FFTP01.
 - Make sure the IP address, time and time zone of AS-FFTP01 are accurate. (refer to section 10.2.10.4 for more information).

- Set up the related parameters in HWCONFIG. Refer to the following steps and examples for more information.

1. Log Setting

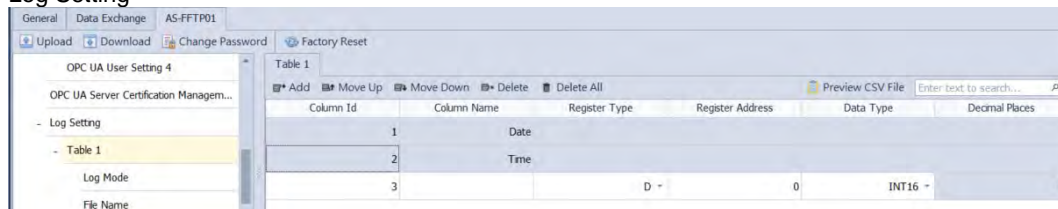

On the Log Setting page, row 1 and row 2 are fixed for date and time. For other rows, one row corresponds to one register. Click **+Add** to create a new row in the .csv file and up to 60 rows can be added. The following parameters can be set here on the Log Setting page.

- Name: user-defined, the maximum length is 64 characters.
- Register Type: Registers D and M
- Register Address: Register number
- Data Type: INT16, UINT16, INT32, UINT32, and Float can be used. After the file is saved in the log, the

corresponding data type and acceptable data length will be applied.

- Decimal Places: Up to 5 decimal places can be used for the use of floating-point data type.

2. Log Mode



(1) Log Mode:

- **Disable:** Not using this log function
- **Program Control:** Work with Record_Trigger instruction (API2305); the execution of instruction is used for PLC to control the log recording timing. For more details, refer to AS Series Programming Manual.
- **PLC Run:** When PLC starts running, the log function is enabled. When PLC stops running, the log function is disabled.
- **Always Enable:** Once PLC starts running, the log function is enabled. The log function is enabled, even if the PLC stops running.

(2) Log Cycle:

- When Log Mode is **PLC Run** or **Always Enable**: The triggering time to record log is set here; the interval unit is 0.1 second.
- When Log Mode is **Program Control**: The triggering time to record log is defined by PLC program.

3. File Name

Data log can only be saved on the SD card. You can define the directory name and the file name, for instance, a created file name looks like this: 'SD card/Delta/MyLog_20220425/Device_log_20220425_184031.csv'.

File Name				
	Name	Setting Value	Unit	Default
▶	Parent directory Name (SD Card/)	Delta		
	Subdirectory Name	MyLog		LOG1
	Automatically Appended Subdirectory Name	Date ▼		Disable
	File Name (.csv)	Device_log		log1
	Automatically Appended File Name	Data + Time ▼		Disable

- (1) Parent directory name (SD Card): Set up the parent directory name.
- (2) Subdirectory name: Set up the subdirectory name.
- (3) Automatically Appended Subdirectory Name: Disable, Date, Date + Time
If Date or Date + Time is selected, the date or date + time will be added right after your set subdirectory name. Make sure you have set up the real time correctly in AS PLC CPU before selecting Date or Date + Time option.
- (4) File name (.csv): Set up the file name. Do not leave this field blank.
- (5) Automatically Appended File Name: Disable, Date, Date + Time
If Date or Date + Time is selected, the date or date + time will be added right after your set filename. Make sure you have set up the real time correctly in AS PLC CPU before selecting Date or Date + Time option.

4. Parameter Settings

Parameter Settings						
	Name	Setting Value	Unit	Default	Minimum	Maximum
	New Directory Creating Timing	Automatically create a new...		Automatically creat...	-	-
	New Directory Creating Parameter	1		1	1	31
	New File Creating Timing	Overwrite existing file		Overwrite existing file	-	-
	New File Creating Parameter	10000		10000	1	10000
	Save to SD Card Timing	Count		Count	-	-
	Save to SD Card Parameter	100	Count	100	1	500

- (1) New Directory Creating Timing: New subdirectories can be created according to the following selections. Up to 500 subdirectories can be created in one directory.
 - Automatically create a new directory: when the number of the files in the subdirectory has reached to 500, a new subdirectory will be created.
 - Date, Month: When selecting the cycle unit, date or month the system will create a new subdirectory and save the data in the new subdirectory when the saving condition is met.
- (2) New Directory Creating Parameter: Up to 500 files can be created in a subdirectory.
- (3) New File Creating Timing: New files can be created according to the following selections. Up to 10000 files can be created in one subdirectory.
 - Overwrite existing file: When the number of the data in the file is reached to the maximum number (up to 10000), the file will be overwritten.
 - Minute, Day, Month: When selecting the cycle unit, minute, day, or month, the system will create a new file and save the data in the new file when the saving condition is met. Up to 10000 pieces of data can be saved; if exceeding the limit, the system will create a new file for recording.
 - Set maximum records of created file: You can set a maximum number for records in a file. The set maximum of records can be saved, if exceeding the limit, the system will create a new file for recording.
- (4) New File Creating Parameter: Up to 10000 pieces of data can be created in a file.
- (5) Save to SD Card Timing: The system saves data from the registers to the files in the SD card by counts or by seconds.
 - Count, second: Set the number of counts or seconds. When the number is reached, the system saves data from the registers to the files on the SD card. The less the setting value is, the sooner, the data will be saved and data loss is prevented. But the frequency of writes on the SD card will be increased and the working life of the SD card may be decreased.
- (6) Save to SD Card Parameter: Up to 500 files from the registers can be saved on a SD card. When the setting value is set to 0 or less than the recording cycle, the system saves data automatically. When the data in the register is more than 60% full, the system saves data to the SD card immediately.

5. Example

- Make sure a SD card is installed in AS-FFTP01.
- Make sure the RTC and time zone are set accurately.
- Setting up the parameters.
 - (1) There are two pieces of data stored in register D and their data types are INT16 and Float respectively.

Column Id	Column Name	Register Type	Register Address	Data Type	Decimal Places
1	Date				
2	Time				
3	VFD frequency	D	2103	INT16	0
4	Temperature	D	0	Float	2

(2) Log Mode

- Log Mode: PLC Run
- Log Cycle: The triggering time to record log is recording 1 piece of data every second; the interval unit is 0.1 second.

Log Mode			
	Name	Setting Value	Unit
▶	Log Mode	PLC Run	
	Log Cycle	10	0.1 sec

(3) File Name

- Parent directory name: Delta
- Subdirectory name: MyLog
- Automatically Appended Subdirectory Name: Date
- File Name: Device_log
- Automatically Appended File Name: Date + Time

File Name	
	Setting Value
▶ Parent directory Name (SD Card/)	Delta
Subdirectory Name	MyLog
Automatically Appended Subdirectory Na...	Date
File Name (.csv)	Device_log
Automatically Appended File Name	Date + Time

(4) Parameter Settings:

- The system will create a new subdirectory and save the data in the new subdirectory daily.
- The system will create a new file every 10 minutes.
- The system will save the file to the SD card every 10 seconds.

Parameter Settings						
	Name	Setting Value	Unit	Default	Minimum	Maximum
▶	New Directory Creating Timing	Daily	-	Automatically creat...	-	-
	New Directory Creating Parameter	1	Daily	1	1	31
	New File Creating Timing	Minute	-	Overwrite existing file	-	-
	New File Creating Parameter	10	Minutely	1	1	1440
	Save to SD Card Timing	Second	-	Count	-	-
	Save to SD Card Parameter	10	Second	10	1	120

(5) Download data through FTP

- Enter the IP address, the username and password in FTP software to log in.
- Data is recorded under the folder with the name “/Delta/MyLog_20220325”.
- After downloading, the .csv file can be opened for reviewing.

Filename	Filesize	Filetype	Last modified
Device_log_20220325_163018_0000.csv	43,252	Microso...	3/25/2022 4:39:00
Device_log_20220325_164008_0000.csv	44,288	Microso...	3/25/2022 4:49:00
Device_log_20220325_165009_0000.csv	43,474	Microso...	3/25/2022 4:59:00
Device_log_20220325_170000_0000.csv	44,288	Microso...	3/25/2022 5:09:00
Device_log_20220325_171000_0000.csv	15,576	Microso...	3/25/2022 5:13:00

(6) Log status

Log in to the webpage of AS-FFPT01 and then go to *Diagnostic* -> *Application diagnostic* to check the Log status. If its status is in error, you can use **Reboot** button to restart the Log.

Application diagnostic		
OPC UA status	Running	Reboot
Log status	Crashed	Reboot

10.2.10.7 Web Server

- **Web Specifications**

Item		Specification
Communication port		80
Maximum connection number		8
Function		<ul style="list-style-type: none"> ● Check the device information ● System diagnostic and Application diagnostic ● Management on the permission of users ● Firmware update ● Built-in Node-RED
Node-RED	Version	V0.18.5
	Communication port	1880

You can enter AS-FFTP01 IP address in the search bar of your browser to connect to your device. After that you can monitor the operation, diagnose the problem and reboot the system if necessary. Node-RED is also supported.

To enable web server, go to *HWCONFIG -> Function Card 2 Setting -> Ethernet Port Basic Setting -> Web Server Enable*.

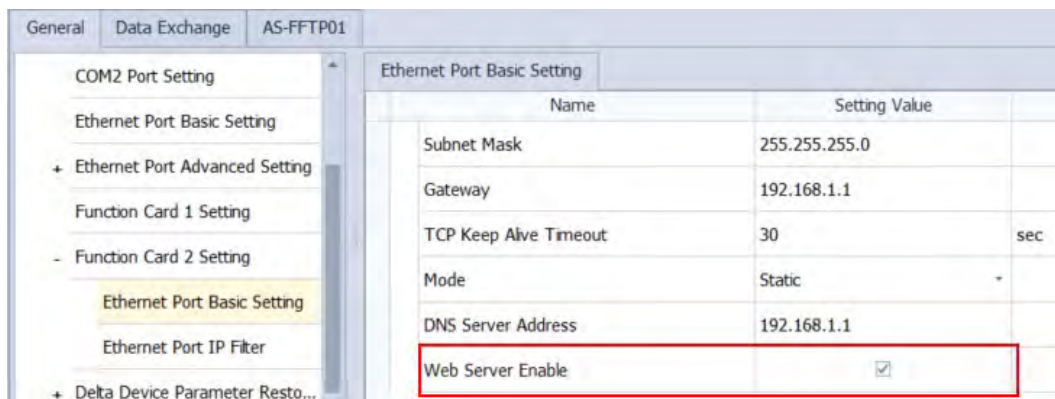

- List of browsers that support AS-FFTP01 webpage:

Provider	Browser	Supported versions
Microsoft	Internet Explorer	V10.0 and later
Microsoft	Edge	V20 and later
Google	Chrome	V14 and later
Apple	Safari	V5.1 and later

- **Log in**

After the setting up IP address in HWCONFIG of ISPSOft. Open your browser and enter AS-FFTP01 IP address in the search bar to connect to AS-FFTP01. After the webpage appears, enter "Admin" in the User section and click Login without entering any password. You can set up the password after login.

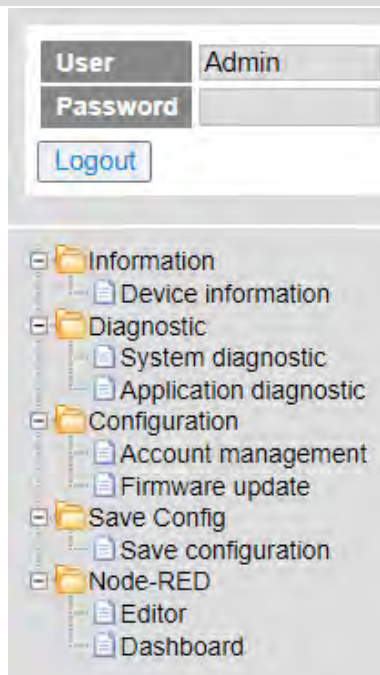

- **Diagnostic:** Use this page to execute **System diagnostic** and **Application diagnostic**.

- **System diagnostic:** The system diagnostic can be exported. Click **Export** button to export the system status to the SD card. If something went wrong on the function card, your local authorized distributor can use the system diagnostic as reference to solve the problem. Once the Export status shows *Finished*, you can take out the SD card and use a card reader or FTP software to check the message.zip file from the SD card.

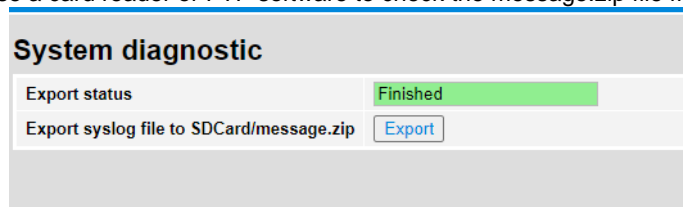

Filename	Filesize	Filetype	La
..			
System Volume Information		File fold...	1/
iot.zip	1,263	Compre...	4/
message.zip	752,913	Compre...	4/
uasave.zip	3,937	Compre...	4/

- Application diagnostic:** You can use this page to check the OPC UA status and Log status. If the status is in error, you can use **Reboot** button to restart the OPC UA or Log.

Application diagnostic

OPC UA status	Running	Reboot
Log status	Running	Reboot

- **Configuration**

- Account management**

There is only one account; that is Admin. For its password, you can edit the password and then click **Apply** button. After that go to **Save Configuration** page to save the change. This password will be used in this webpage and Node-RED editor.

Account management

No.	User ID	Password	Access type	Delete
1	Admin	*****	Administrator	Delete

[Apply](#)

- **Firmware update**

Store the firmware on SD card of AS-FFTP01 via a card reader or FTP function and then you can use this page to update the firmware. After firmware update is complete, power off and then power on your PLC to have the new firmware to take effect.

Firmware update

Start firmware update mode	Start
Update status	Ready

- **Save configuration:** After settings are done, you need to save the changes in this page to make the changes effective.

Save configuration

Save configuration

Saving all applied changes will cause all changes to configuration panels that were applied, but not saved, to be saved, thus retaining their new values.

[Save](#)

- **Node-RED Editor:** You can create flow charts to make components and to read/write data from PLC data registers.

- (1) You can use Modbus TCP communication to access to AS Series PLC CPU in Node-RED editor. The IP address is 127.0.0.1. And then you can see the data from the AS PLC CPU on this page.
- (2) Click the **Click** button and then enter the fixed account name "Admin" and your password (default: Admin) to open the editor.

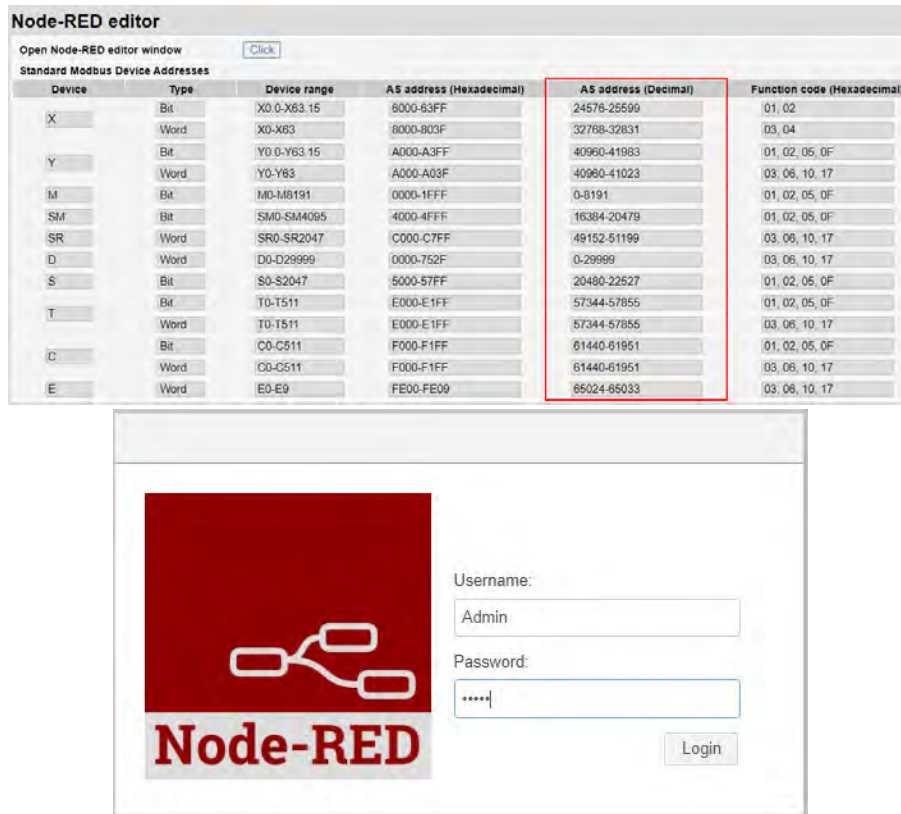

- Node-RED dashboard: Once you click it, a new window will be opened and a compiled Node-RED dashboard will be shown visually.
- Users cannot create new nodes for AS-FFTP01 V1.00.
- Example
The Demo-page can be opened if this is your first time to use AS-FFTP01 function card or you just restore AS-FFTP01 to its default settings.

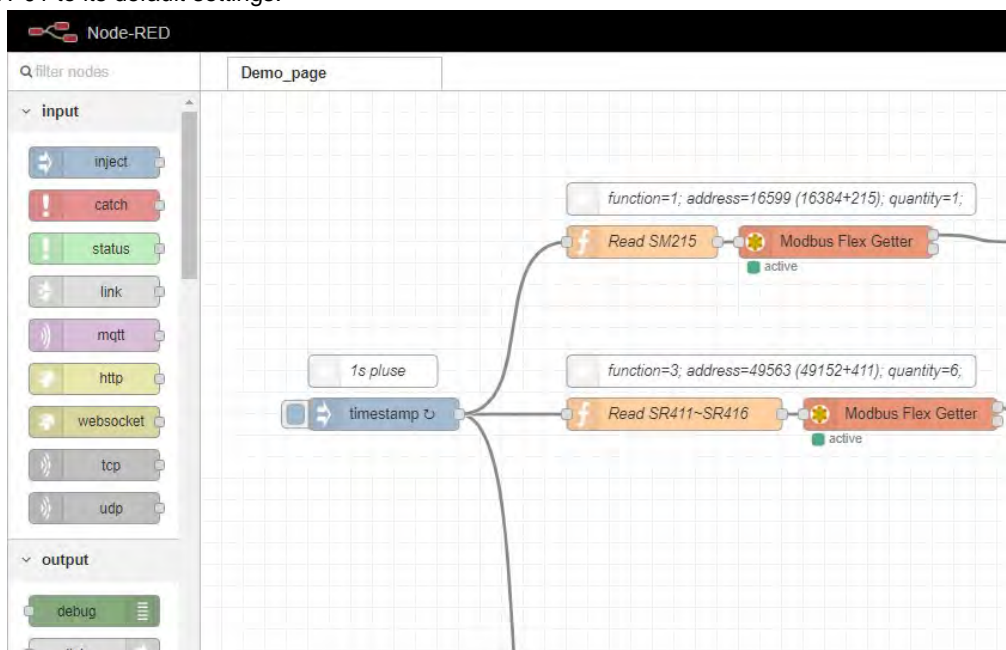

- (1) The SM, SR, M, D devices of AS Series PLC CPU can be transferred to nodes of the dashboard in different formats. For example, the D500 is read and shown in floating-point format. Follow the steps below.

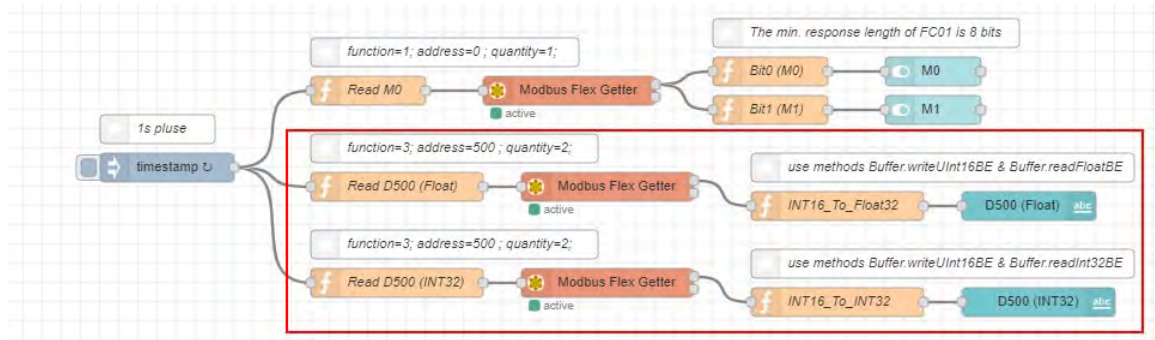

- i. Create an inject node and set the timestamp for transferring to one second.
- ii. Use Function nodes to send out msg.payload (Modbus TCP commands are included) to the node of Modbus TCP as the example shown below. The function code 03, address 500 (in decimal format), and quantity 2 are set.

Name:

Function:

```

1 var fc=3;
2 var address=500;
3 var quantity=2;
4 msg.payload = { value: msg.payload, 'fc': fc, 'unitid'
5 return msg;

```

- iii. Create a server in the node of Modbus. IP address is 127.0.0.1.

Name:

Type:

Host:

Port:

TCP Type:

Unit-Id:

- iv. Now the data is being processed in the node of Function. After the data is converted to the floating-point format, it will be presented in nodes shown in the dashboard. For more details, refer to the reference in Node-Red editor.

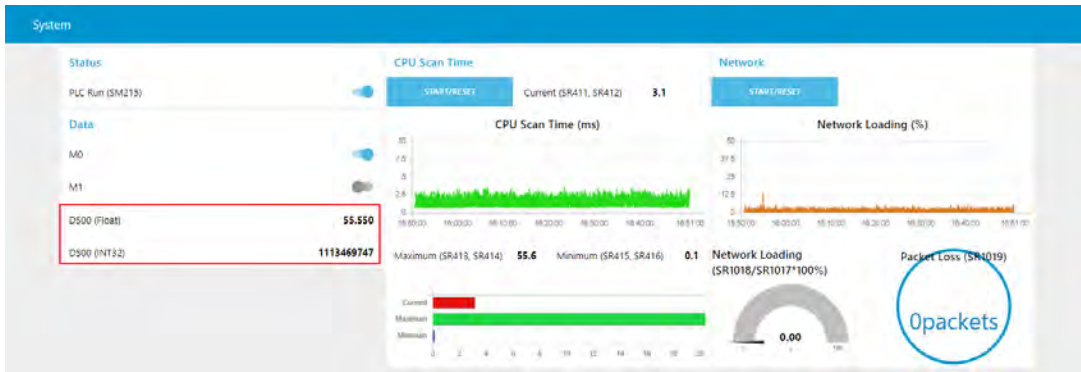

- Backup and Restoration
 - (1) If the AS-FFTP01 is restored to its defaults, only the demo page will be shown. Thus it is important to back up your Node-RED data after editing is done.
 - (2) Click any nodes in the editor to open the function list on the upper-right corner of the screen. Select *Export* -> *Clipboard* and then you can select the sections to be backed up. After that, click **Export to clipboard** to copy the codes and then save them in any textbook. And then a copy of your codes is made.

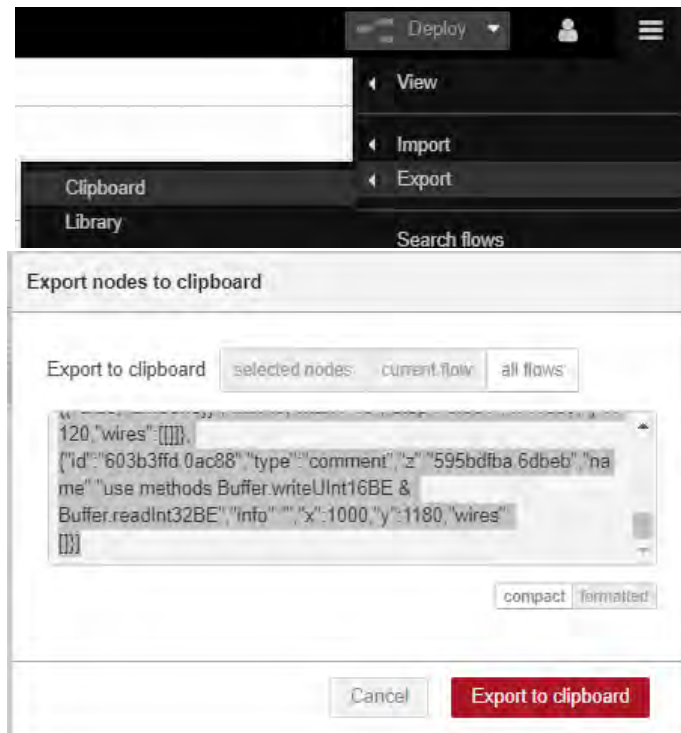

- (3) For restoration, select *Import* -> *Clipboard* from the upper-right corner of the screen to import your copied codes and then your codes can be used again.

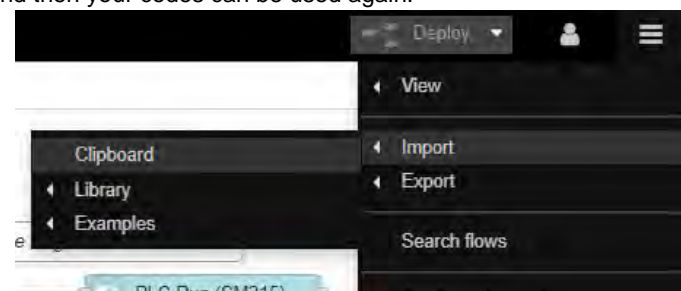

- For more information, go to <https://nodered.org/docs/user-guide/editor/>

10.2.10.8 MQTT Client

- MQTT Specifications

Item	Specifications
Device type	MQTT Client
Supported platform	Amazon Web Service
Communication port	8883
Maximum connection number	1
Maximum connection number to be recorded	1
Quality of Service (QoS)*	0, 1
Section to be read	Register D
Maximum data length in Publish	128 words
Maximum data length in Subscribe	128 words
Application command	MQTT_Connect MQTT_Publish MQTT_Subscribe

*Note: QoS (Quality of Service): There are 3 QoS levels in MQTT. But for AS-FFTP01 V1.0, only 0 and 1 are supported. For more details, refer to the instructions, including MQTT_Connect (API2214), MQTT_Publish (API2215) and MQTT_Subscribe (API2216) from AS Programming Manual.

AS-FFTP01 V1.00 supports **Amazon AWS IoT Core for MQTT**. You can use the MQTT feature **Publish** to publish messages to the specific topic on the cloud where the MQTT Broker designed. For example, you can update the status of the PLC registers to the specific topic on the cloud. Up to 5 topics can be subscribed at the same time. Users can use the MQTT feature **Subscribe** to subscribe the specific topic and after the subscription is complete, they can receive the published messages that they subscribed or the status of the PLC registers.

Before the connection is established, you will need to set up AWS IoT Core.

1. Log in AWS IoT Core and create things.

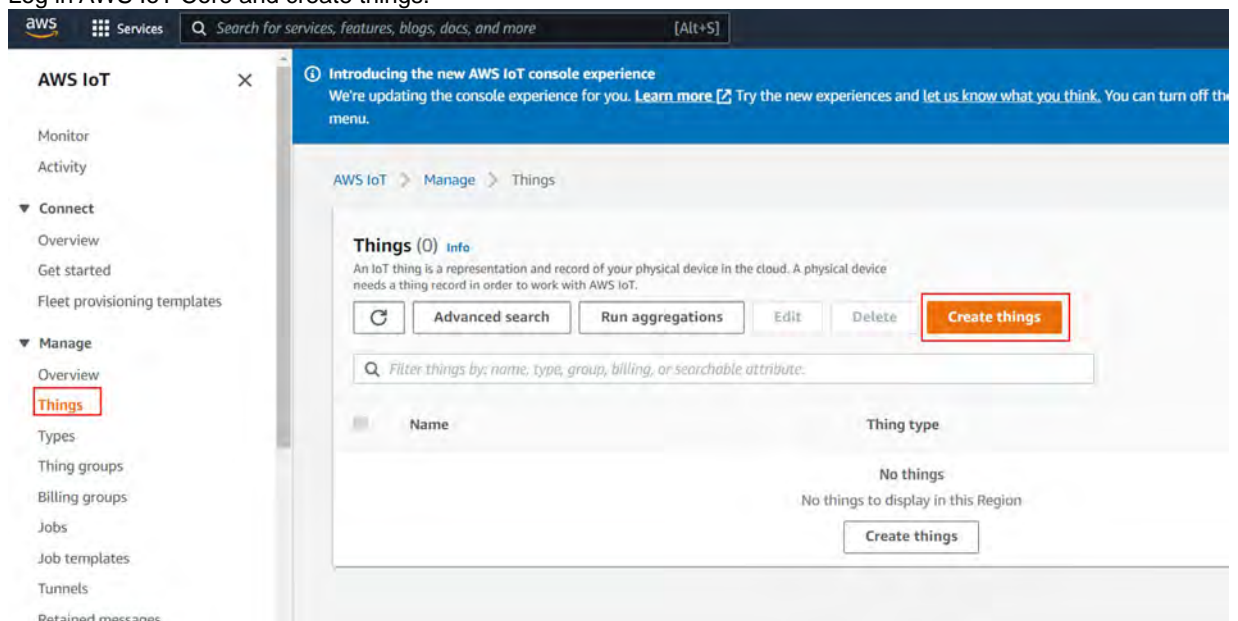

2. Select the **Create single thing** and click **Next**. On the next page, provide the to-be-created thing with a name and then click **Create thing type**. On the next page, provide the to-be-created thing type with a name and then click **Create**.

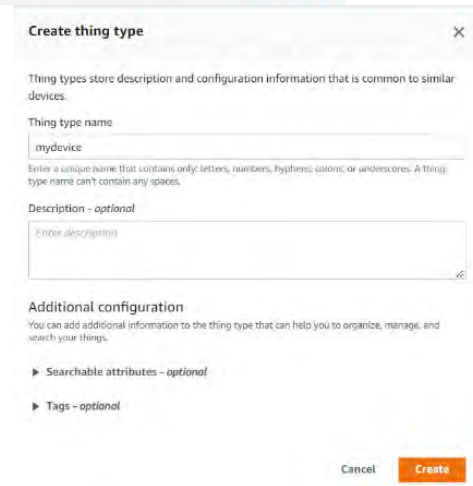
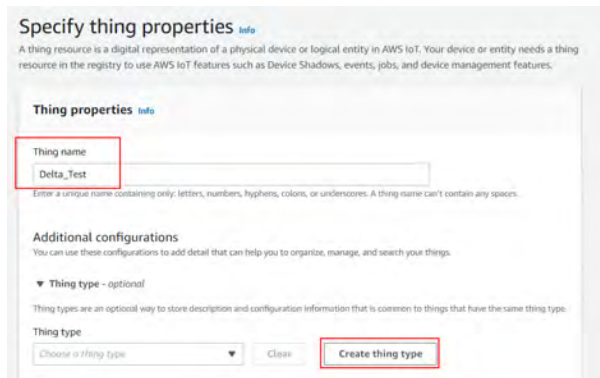
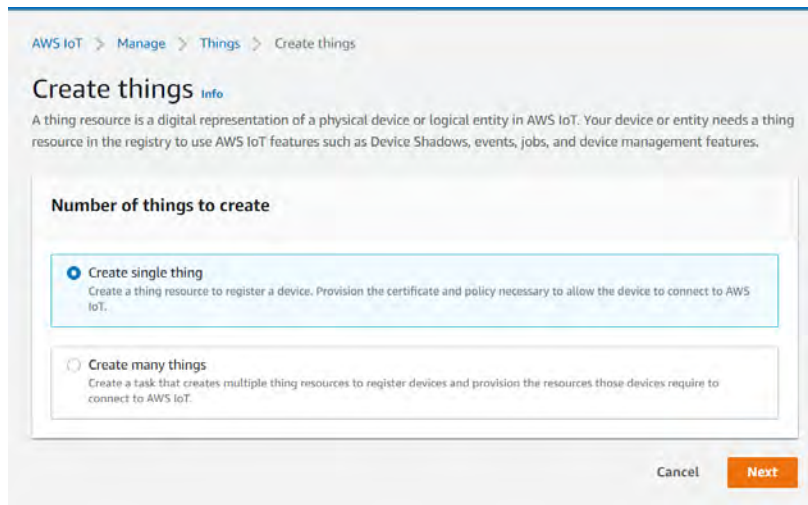

3. Select Auto-generate a new certificate (recommended) and click **Next**.

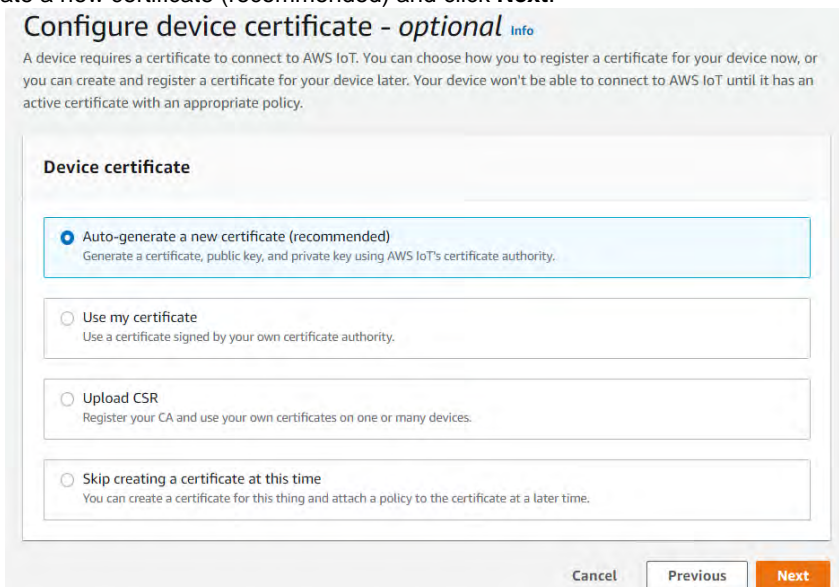

4. Click **Create policy** to manage AWS IoT actions and then click **Create**.

The image shows two screenshots from the AWS IoT console. The top screenshot is titled "Attach policies to certificate - optional" and shows a "Policies (0)" section with a "Create policy" button highlighted in a red box. The bottom screenshot is titled "Create policy" and shows the "Policy properties" section with "MyDevice" entered in the "Policy name" field, highlighted in a red box. A dropdown menu for "MQTT policy actions" is open, showing various actions like "iot:Connect", "iot:Publish", "iot:Receive", "iot:GetRetainedMessage", "iot:ListRetainedMessages", and "iot:RetainPublish". The "Policy effect" is set to "Allow" and the "Policy resource" is highlighted in a red box. The "Builder" and "JSON" tabs are visible at the bottom right.

5. After that, attach policies to certificate and then click **Create thing**.

The image shows a screenshot of the "Attach policies to certificate - optional" section in the AWS IoT console. The "Policies (1/1)" section shows that one policy, "MyDevice", has been attached to the certificate. The "MyDevice" entry is highlighted in a blue box. The "Create thing" button is visible at the bottom right.

6. Download all the certificates and keys. We will need the followings for the set up.

- Root certificate (Root CA1)
- Device certificate (.crt)
- Private key

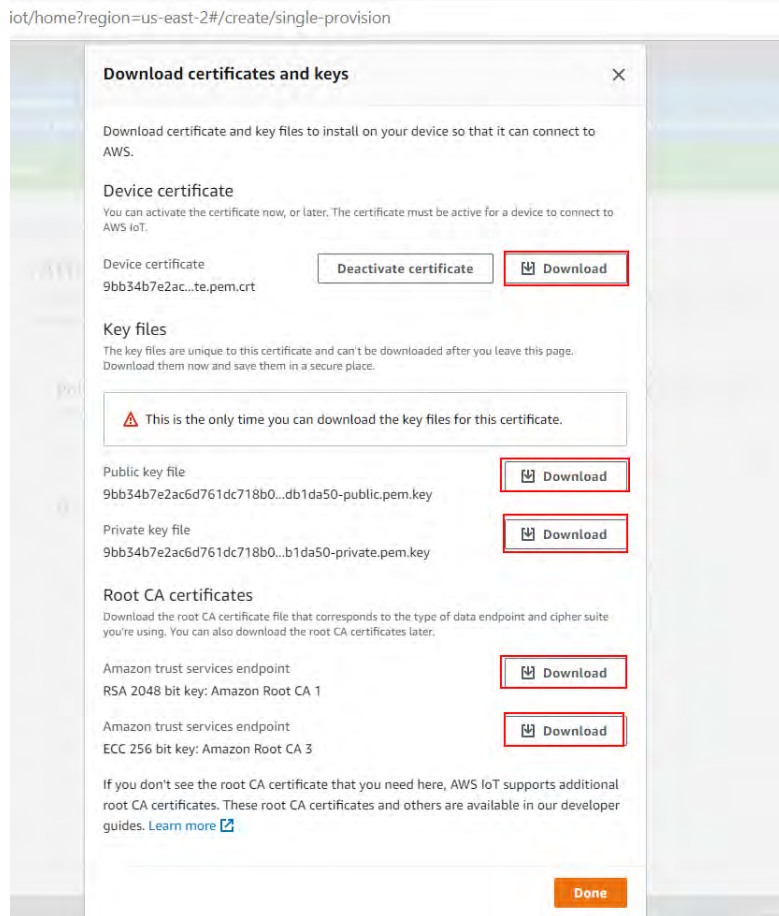

7. Go to the setting page to copy the Endpoint address. You will need to use this address later in HWCONFIG.

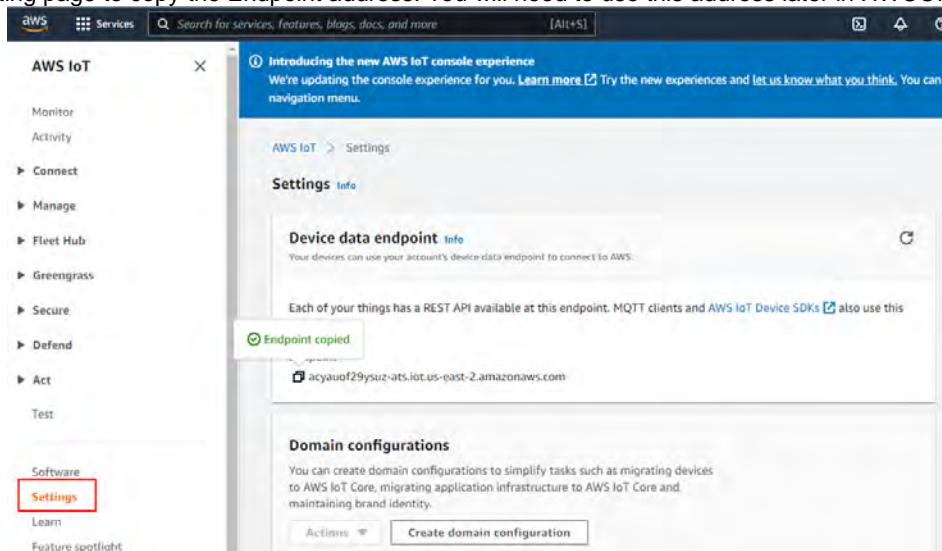

Setting up MQTT in HWCONFIG:

1. Go to MQTT User Setting 1 page.
2. Cloud: Select **AWS**.
3. Server Mode: Select **Domain Name**.
4. Server Domain Name: Paste the Endpoint address that you've just copied from AWS setting page.
5. Port number: 8883

6. Import the AWS provided **RootCA1, Certification (.crt)** and **Private Key** file.

MQTT User Setting 1						
Name	Setting Value	Unit	Default	Minimum	Maximum	
Cloud	AWS		AWS	-	-	
TLS/SSL	Enable		Enable	-	-	
Port	8883		8883	1	65535	
Server Mode	Domain Name		Domain Name	-	-	
Server Domain Name	acyaouf29ysuz-ats.iot.us-eas...			-	-	
User name	...			-	-	
Password	...			-	-	
Root Certificate	AmazonRootCA1.pem	...		-	-	
Certificate	certificate.pem.crt	...		-	-	
Key	private.pem.key	...		-	-	

7. After the connection is established, you can use the PLC instruction MQTT_Connect (API2214) to establish connections.
8. After connected, use the PLC instructions MQTT_Publish (API2215) and MQTT_Subscribe (API2216) to publish and subscribe messages.
9. Refer to AS Programming Manual for more details on instruction executions.

10.2.10.9 Network Security

To enhance security and performance of the system, it is suggested to use closed network or LAN with firewall protection to prevent cyber-attacks.

10.2.10.10 Error Codes

AS-FFTP01 uses SM38 as an error flag and stores error codes in SR38.

- Any error occurs, the flag SM38 will be ON.
- The error codes will be stored in SR38. When there are more than one error occur at the same time, only the one with higher priority will be shown in SR38. For example, if the errors 16#9001 and 16#900F occur at the same time, only 16#9001 will be shown in SR38. The following error codes are numbered according to their priorities. The higher the priority is, the sooner it will be presented in this table.

Error Code	Description	Solution
16#9000	A firmware update is undergoing now.	After the firmware update is complete, power off and power on your PLC CPU to restart.
16#9001	Failed to communicate internally	<ol style="list-style-type: none"> Check if the function card is securely inserted into the slot. Check if the settings in HWCONIG are the same as the actual settings for function card. Power off and power on your PLC CPU to restart. If the problem persists, contact the local authorized distributors.
16#9002	Internal master communication stops working.	Power off and power on your PLC CPU to restart. If the problem persists, contact the local authorized distributors.
16#9003	Internal slave communication stops working.	Power off and power on your PLC CPU to restart. If the problem persists, contact the local authorized distributors.
16#9004	Modbus TCP slave stops working.	Power off and power on your PLC CPU to restart. If the problem persists, contact the local authorized distributors.
16#9005	MQTT client stops working.	Power off and power on your PLC CPU to restart. If the problem persists, contact the local authorized distributors.
16#9006	OPC UA server stops working.	<ol style="list-style-type: none"> Reboot OPC UA server on the diagnostic web page. Power off and power on your PLC CPU to restart. If the problem persists, contact the local authorized distributors.

Error Code	Description	Solution
16#9007	FTP server or Log function stops working.	Power off and power on your PLC CPU to restart. If the problem persists, contact the local authorized distributors.
16#9008	Web server function stops working.	Power off and power on your PLC CPU to restart. If the problem persists, contact the local authorized distributors.
16#9009	Internal communication stops working.	Power off and power on your PLC CPU to restart. If the problem persists, contact the local authorized distributors.
16#900B	Initialization on internal master communication failed	Power off and power on your PLC CPU to restart. If the problem persists, contact the local authorized distributors.
16#900C	Initialization on internal slave communication failed	Power off and power on your PLC CPU to restart. If the problem persists, contact the local authorized distributors.
16#900D	Initialization on Modbus TCP slave failed	Power off and power on your PLC CPU to restart. If the problem persists, contact the local authorized distributors.
16#900E	Initialization on MQTT client failed	Power off and power on your PLC CPU to restart. If the problem persists, contact the local authorized distributors.
16#900F	Initialization on OPC UA server failed	<ol style="list-style-type: none"> 1. Reboot OPC UA server on the diagnostic web page. 2. Power off and power on your PLC CPU to restart. If the problem persists, contact the local authorized distributors.
16#9010	Initialization on FTP server or Log function failed	Power off and power on your PLC CPU to restart. If the problem persists, contact the local authorized distributors.
16#9011	Initialization on Web failed	Power off and power on your PLC CPU to restart. If the problem persists, contact the local authorized distributors.
16#9012	Initialization on internal communication failed	Power off and power on your PLC CPU to restart. If the problem persists, contact the local authorized distributors.
16#9013	Initialization on RTC failed	Power off and power on your PLC CPU to restart. If the problem persists, contact the local authorized distributors.
16#9014	RTC function stops working.	Power off and power on your PLC CPU to restart. If the problem persists, contact the local authorized distributors.
16#9200	Internal communication timeout	<ol style="list-style-type: none"> 1. Check if the function card is securely inserted into the slot. 2. Power off and power on your PLC CPU to restart. If the problem persists, contact the local authorized distributors.
16#9201	Failed to store in SD card	Check if the SD card is functioning properly. And then download the HWCONFIG parameters again.
16#9202	Failed to back up	Power off and power on your PLC CPU to restart. And then download the HWCONFIG parameters again.
16#9203	Failed to read HWCONFIG parameters	Power off and power on your PLC CPU to restart. If the problem persists, contact the local authorized distributors.
16#9204	Failed to read parameter from OPC UA server	Power off and power on your PLC CPU to restart. If the problem persists, contact the local authorized distributors.
16#9205	Failed to restore to defaults	<ol style="list-style-type: none"> 1. Check if the function card is securely inserted into the slot. 2. Power off and power on your PLC CPU and try to restore the settings to defaults again. If the problem persists, contact the local authorized distributors.
16#9206	Failed to update firmware	Check if the SD card is functioning properly. Power off and power on your PLC CPU to restart. If the problem persists, contact the local authorized distributors.
16#9207	IP address conflict	Remove the device with the same IP address on the network or modify the IP address of AS-FFTP01.
16#92FF	Unknown error	Power off and power on your PLC CPU to restart. If the problem persists, contact the local authorized distributors.

10.2.11 AS-FECAT

This communication card can work independently and does NOT occupy the communication port of PLC CPU. It can act as Modbus TCP Server and EtherCAT Master. After AS-FECAT is installed, you can go to HWCONFIG from ISPSOft for editing in the Function Card 2 section.

For the AS-FECAT basic parameters (IP address and other parameters) are stored in AS300 Series PLC CPU. After AS-FECAT is installed on AS300 Series PLC CPU, you can use the following steps to obtain and make sure the IP address of AS-FECAT is correct.

1. Go to HWCONFIG from ISPSOft to upload the AS Series PLC CPU parameters to check the IP address of AS-FECAT
2. If the IP address is a dynamic one, use COMMGR to scan and check the IP address of this device.

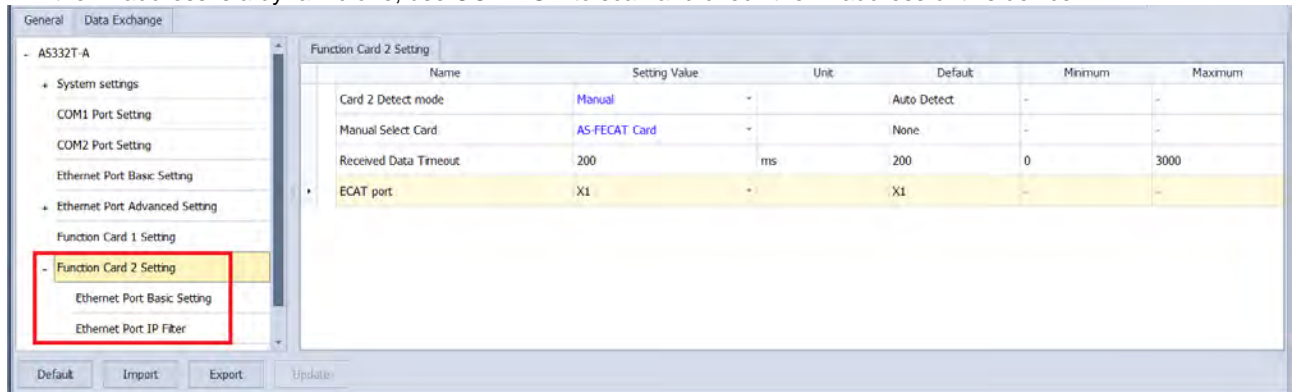

10.2.11.1 Supported Firmware Versions

- The firmware of AS300 Series PLC should be V1.14 or later for AS-FECAT to be installed on it.
- ISPSOft version should be V3.16 or later.
- Built-in ISPSOft, HWCONFIG, should be V4.06 or later.

10.2.11.2 Features

- AS-FECAT can be installed on AS300 Series PLC CPU.
- When AS-FECAT is installed on AS300 Series PLC CPU, it can act as a Server of Modbus TCP. The way to use AS-FECAT is the same as using the built-in connection port for communication.
- When AS-FECAT is installed on AS300 Series PLC CPU, you can use the INITEC instruction (API2820) to initialize EtherCAT communication and then set up one of the AS-FECAT port as the EtherCAT Master's port in HWCONFIG. As for the other port, it can be used by Server of Modbus TCP. The way to use the two communication ports is the same as using the built-in connection port for communication.

10.2.11.3 Specifications

- **System Specifications**

Item		Specification
General	Device type	Master and Slave
	Topology	Star and linear topologies are supported. Note: Once the EtherCAT communication is initialized via the INITEC instruction (API2820), the above mentioned topologies are not supported. There are two ports on AS-FECAT; one will be used as EtherCAT port and the other will be Ethernet port. Two ports work independently.
	Availability	AS300 Series PLC CPU
	IP Settings	<ul style="list-style-type: none"> ● When installed on AS300 PLC CPU, you can use HWCONFIG from ISPSOft for editing.
Web	Max. connection number	8
	Functions	View device information Account management AS-FECAT firmware update

- **MODBUS TCP Specifications (only available for CPU modules)**

Item		Specification
General	Device type	Server
Modbus TCP Server	Max. connection number	1
	Max. data length/per transmission	200 words

- **EtherNet/IP Specifications**

Item	Specification
Baudrate	100Mbps
Communication protocol	EtherCAT packet
Supported number of axis	16 Note: only available for Delta Servo drives, ASDA-A2-E, ASDA-A3-E, ASDA-B3-E and Delta inverters, C2000 and CH2000.

10.2.11.4 IP Setting

- The IP address of AS-FECAT is not stored on the function card. When you install AS-FECAT onto AS300 PLC CPU or AS00SCM-A, the IP settings of AS-FECAT will be obtained automatically.
- When installed on AS300 PLC CPU, you can go to *ISPSOft -> HWCONFIG -> Function Card 2 Setting -> Ethernet Port Basic Setting* to edit the parameters.

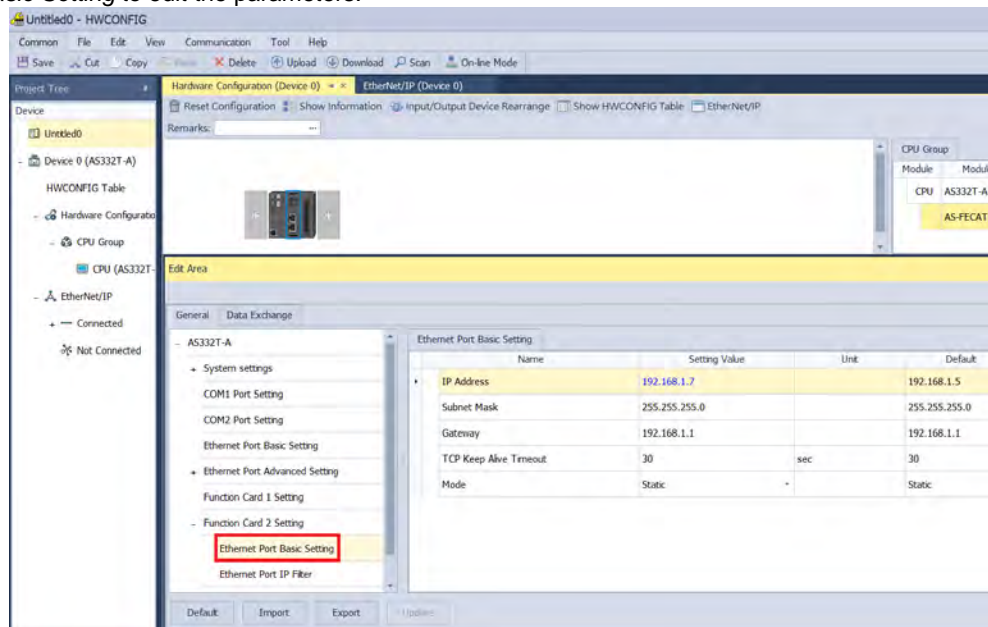

Note: You can use **IP Manager Tool**, when AS-FECAT is installed on AS300 PLC CPU, but do not use it to set up the IP address to avoid conflicts with the parameters of AS300 PLC CPU project.

10.2.11.5 Set up the ECAT Port

When AS-FECAT is installed on AS300 Series PLC CPU, you can use the INITEC instruction (API2820) to initialize EtherCAT communication and then set up one of the AS-FECAT port as the EtherCAT Master's port in HWCONFIG. As for the other port, it can be used by Server of Modbus TCP. Two ports work independently. If the EtherCAT communication is NOT initialized, the two ports of AS-FECAT can be used by Servers of Modbus TCP.

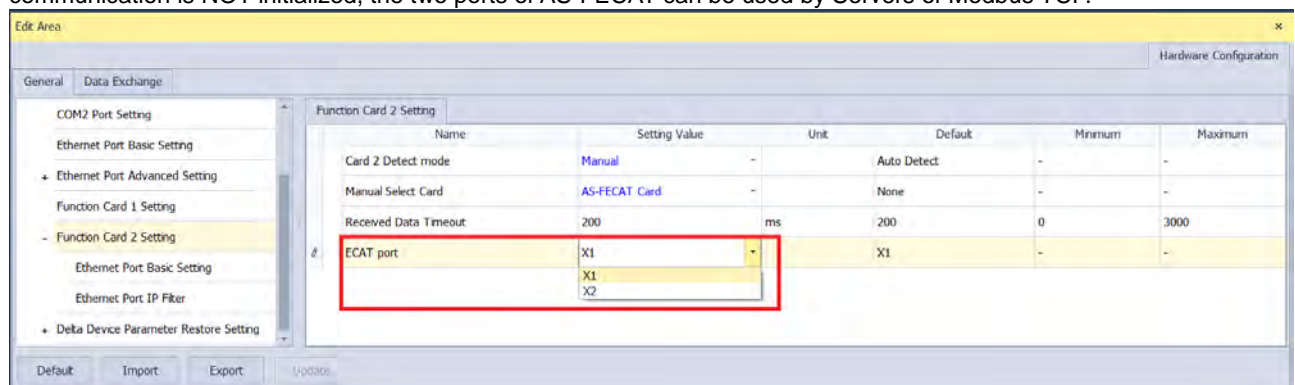

10.2.11.6 SM/SR

- The following table shows special flags (SM) and registers (SR) related to ECAT communication.

Flag	R/W	ID. 1 to ID. 16
Initialization and communication complete (INITC and CASD)	R	SM1681
Communication error	R	SM1682
Heartbeat error handling	R/W	SM1684 = OFF (default; when one goes down, all the drives are OFF.) SM1684 = ON (when one goes down, only the defective drive is OFF.)
ECAT SDO abort code (32-bit)	R/W	SR656 SR657
ID number with a communication error	R/W	SR658
Communication error code	R/W	SR659

Function	R/W	ID. 1	ID. 2	ID. 3	ID. 4	ID. 5	ID. 6	ID. 7	ID. 8
Servo Positioning complete ^{#1}	R/W	SM1631	SM1632	SM1633	SM1634	SM1635	SM1636	SM1637	SM1638
Servo Stop	R/W	SM1641	SM1642	SM1643	SM1644	SM1645	SM1646	SM1647	SM1648
Servo-ON, inverter-ON	R	SM1651	SM1652	SM1653	SM1654	SM1655	SM1656	SM1657	SM1658
Go-back/go-forth enabled Only DDRVAC is supported.	R/W	SM1661	SM1662	SM1663	SM1664	SM1665	SM1666	SM1667	SM1668
Go-back/go-forth direction indicator Only DDRVAC is supported.	R	SM1671	SM1672	SM1673	SM1674	SM1675	SM1676	SM1677	SM1678
Auto return communication control right. Only DDRVAC is supported.	R/W	SM1581	SM1582	SM1583	SM1584	SM1585	SM1586	SM1587	SM1588
Heartbeat error code ^{#2}	R/W	SM1691	SM1692	SM1693	SM1694	SM1695	SM1696	SM1697	SM1698

Function	R/W	ID. 9	ID. 10	ID. 11	ID. 12	ID. 13	ID. 14	ID. 15	ID. 16
Servo Positioning complete ^{#1}	R/W	SM1921	SM1922	SM1923	SM1924	SM1925	SM1926	SM1927	SM1928
Servo Stop	R/W	SM1931	SM1932	SM1933	SM1934	SM1935	SM1936	SM1937	SM1938
Servo-ON, inverter-ON	R	SM1621	SM1622	SM1623	SM1624	SM1625	SM1626	SM1627	SM1628
Go-back/go-forth enabled Only DDRVAC is supported.	R/W	SM1941	SM1942	SM1943	SM1944	SM1945	SM1946	SM1947	SM1948
Go-back/go-forth direction indicator Only DDRVAC is supported.	R	SM1951	SM1952	SM1953	SM1954	SM1955	SM1956	SM1957	SM1958
Auto return communication control right. Only DDRVAC is supported.	R/W	SM1601	SM1602	SM1603	SM1604	SM1605	SM1606	SM1607	SM1608
Heartbeat error code ^{#2}	R/W	SM1611	SM1612	SM1613	SM1614	SM1615	SM1616	SM1617	SM1618

#1: The timing for the servo positioning completion flag to be cleared to off automatically is when the outputting of the axis is enabled. If you need to use positioning instructions on a certain axis for several times in a row, you need to clear the servo positioning completion flag by yourself. If you do not clear the servo positioning completion flag and then use the positioning instruction again and again, it is possible that before the next positioning instruction is executed, a servo positioning completion flag is detected and then the execution of positioning instruction will be stopped.

2: Since the heartbeat is not available for ECAT communication, working counter (WKC) is used as a way to determine whether the connection of a slave is lost or not.

- The following table shows special flags (SM) and registers (SR) related to Servo ECAT communications.

Parameter Name (Number)	R/W	ID. 1	ID. 2	ID. 3	ID. 4	ID. 5	ID. 6	ID. 7	ID. 8
Servo PR command (P5-07) / Inverter status (index 6041H-00H)	R	SR661	SR662	SR663	SR664	SR665	SR666	SR667	SR668
Servo Alarm code (P0-01)	R	SR671	SR672	SR673	SR674	SR675	SR676	SR677	SR678
Servo DO state (P0-46)	R	SR681	SR682	SR683	SR684	SR685	SR686	SR687	SR688
Servo command position CMD_O (P0-09)	R	SR691 SR692	SR693 SR694	SR695 SR696	SR697 SR698	SR699 SR700	SR701 SR702	SR703 SR704	SR705 SR706
Servo target position CMD_E (P0-10)	R	SR711 SR712	SR713 SR714	SR715 SR716	SR717 SR718	SR719 SR720	SR721 SR722	SR723 SR724	SR725 SR726
Servo DI state (P4-07)	R	SR731	SR732	SR733	SR734	SR735	SR736	SR737	SR738
Current torque (P0-11)	R	SR741	SR742	SR743	SR744	SR745	SR746	SR747	SR748
Servo Self-defined (P0-12)	R	SR791 SR792	SR793 SR794	SR795 SR796	SR797 SR798	SR799 SR800	SR801 SR802	SR803 SR804	SR805 SR806
Positioning completion range setting	R/W	SR811	SR812	SR813	SR814	SR815	SR816	SR817	SR818

Parameter Name (Number)	R/W	ID. 9	ID. 10	ID. 11	ID. 12	ID. 13	ID. 14	ID. 15	ID. 16
Servo PR command (P5-07) / Inverter status (index 6041H-00H)	R	SR751	SR752	SR753	SR754	SR755	SR756	SR757	SR758
Servo Alarm code (P0-01)	R	SR761	SR762	SR763	SR764	SR765	SR766	SR767	SR768
Servo DO state (P0-46)	R	SR1191	SR1192	SR1193	SR1194	SR1195	SR1196	SR1197	SR1198
Servo command position CMD_O (P0-09)	R	SR1201 SR1202	SR1203 SR1204	SR1205 SR1206	SR1207 SR1208	SR1209 SR1210	SR1211 SR1212	SR1213 SR1214	SR1215 SR1216
Servo target position CMD_E (P0-10)	R	SR1221 SR1222	SR1223 SR1224	SR1225 SR1226	SR1227 SR1228	SR1229 SR1230	SR1231 SR1232	SR1233 SR1234	SR1235 SR1236
Servo DI state (P4-07)	R	SR781	SR782	SR783	SR784	SR785	SR786	SR787	SR788
Current torque (P0-11)	R	SR771	SR772	SR773	SR774	SR775	SR776	SR777	SR778
Servo Self-defined (P0-12)	R	SR1241 SR1242	SR1243 SR1244	SR1245 SR1246	SR1247 SR1248	SR1249 SR1250	SR1251 SR1252	SR1253 SR1254	SR1255 SR1256
Positioning completion range setting	R/W	SR1261	SR1262	SR1263	SR1264	SR1265	SR1266	SR1267	SR1268

- Special Data Registers (SR)

SR	Function	AS300 Series	AS200 Series	OFF ↓ ON	STOP ↓ RUN	RUN ↓ STOP	Latched	Attribute	Default
SR1536	AS-FEN02/FOPC02 TCP current connection number	○	—	0	—	—	N	R	0
SR1537	AS-FEN02 MODBUS/TCP Server connection number	○	—	0	—	—	N	R	0

Special data register	Refresh time
SR1536~SR1537	The flag is ON, when the system is refreshed automatically.

10.2.11.7 Example of Setting up EtherCAT Master

When AS-FECAT is installed on AS300 Series PLC CPU, you can set up one of the AS-FECAT port as the EtherCAT Master's port in HWCONFIG.

1. Set up the ECAT port x1 in HWCONFIG for AS-FECAT.

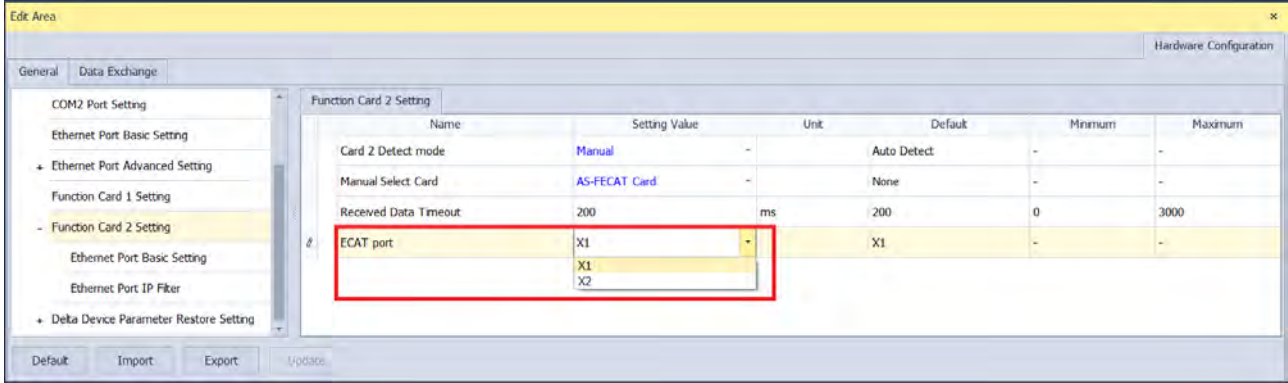

2. Use the INITEC instruction (API2820) to initialize EtherCAT communication. Refer to section API2820 from section 6.27 Delta CANopen Communication Instructions of AS Programming Manual for more details. After the initialization of EtherCAT communication is complete, port x1 can act as the port for an EtherCAT Master, and then communicate with Slaves.
3. After the initialization of EhterCAT communication is complete, port x2 can be used by a server of Modbus TCP or can be used by a webpage. But it is not suggested to use it to execute data exchange or monitoring for a long time.
4. After the initialization of EhterCAT communication is complete, if PLC switches from RUN to STOP, port x1 will no longer be used as a port for an EtherCAT Master. And then two ports, port x1 and port x2 can both be used by servers of Modbus TCP or can be used by a webpage.

10.2.11.8 Example of Setting up Modbus TCP Server

When AS-FECAT is installed on AS300 PLC CPU, you can create a connection by configuring the IP address and some relevant parameters to make it act as a Modbus TCP server.

The following example shows two AS300 PLC CPUs (one with AS-FECAT) to connect to each other and one as Client and the other as Server (AS-FECAT) to perform data mapping through the Modbus TCP connection. For the support function codes and corresponding addresses, refer to AS Series Operation Manual for more details.

Device	Function	IP Address	Data Mapping Area
AS300	Modbus TCP Client	192.168.1.5	D100, D200
AS300+ AS-FECAT	Modbus TCP Server	192.168.1.3	D200, D300

Step 1

Double click AS 300 PLC CPU in HWCONFIG and set up the IP Address of the AS-FECAT to 192.168.1.3

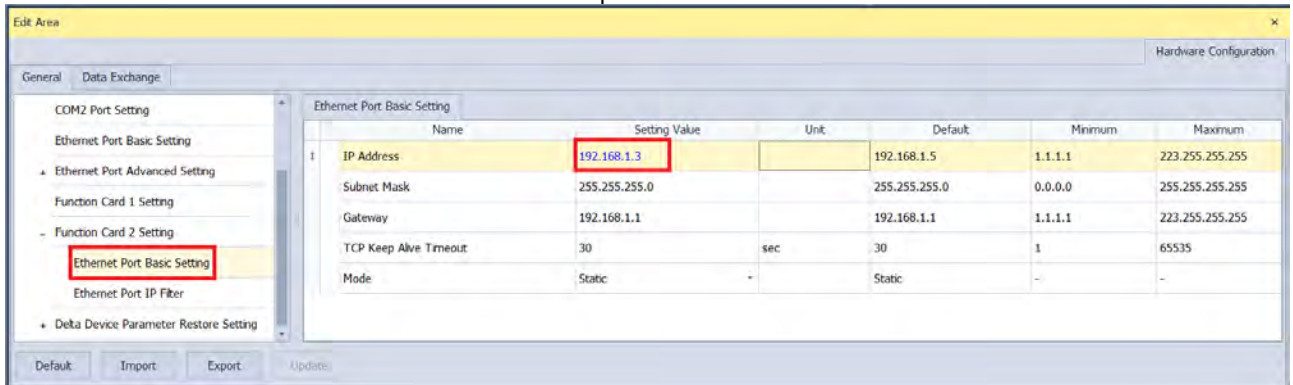

Step 2

Create a data mapping table in the Client and then perform data mapping with the Server (AS-FECAT).

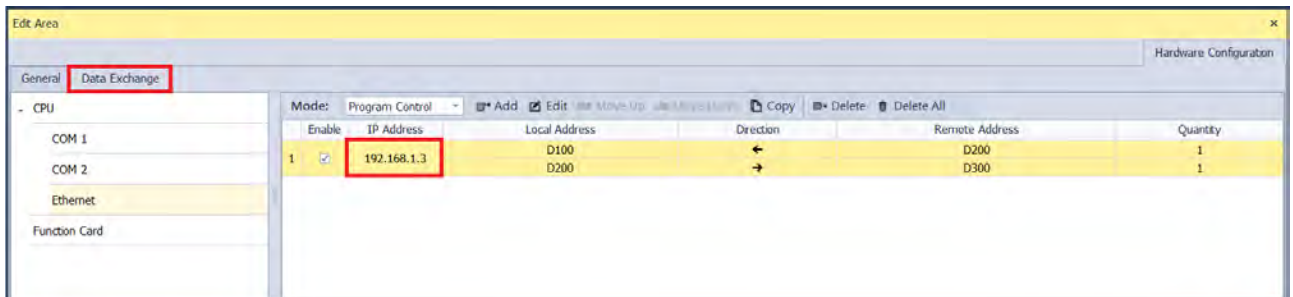

Step 3

Click the **Downloader** icon and then select the parameters that you'd like to download.

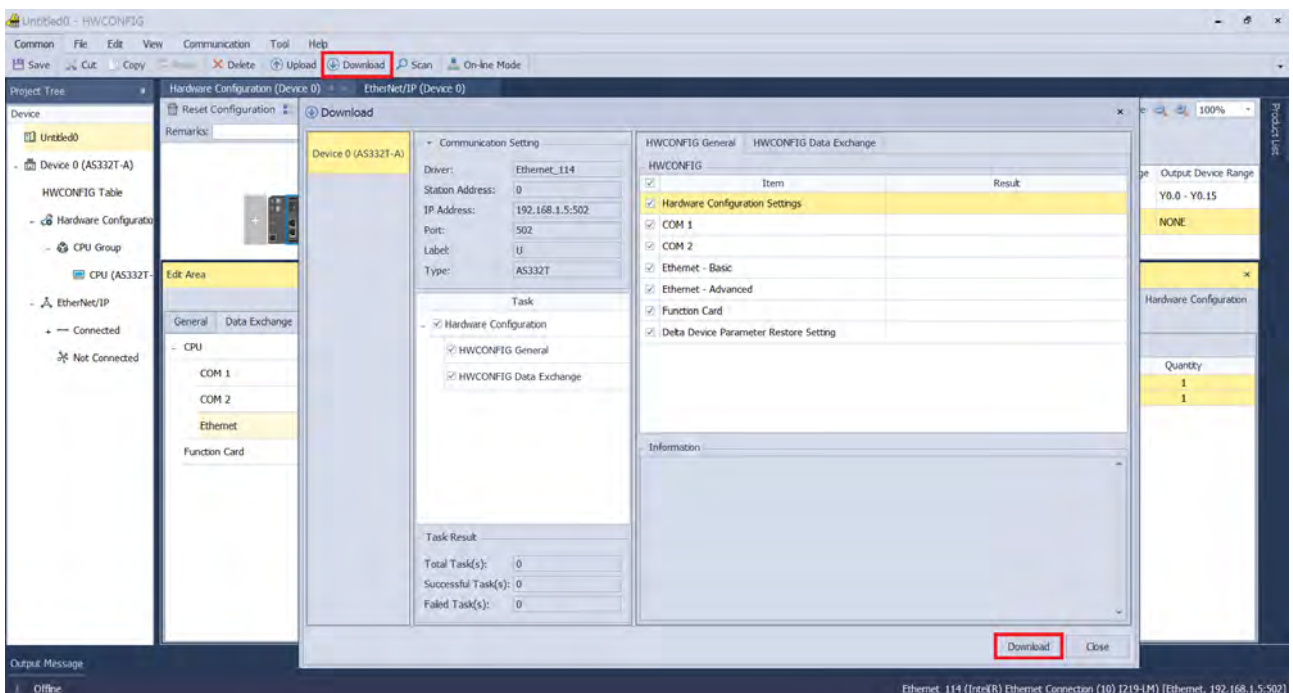

10.2.11.9 Web Server

When AS-FECAT is installed on AS300 Series PLC, you can enter AS-FECAT IP address in the search bar of your browser to connect to your device. After that you can set up, update firmware and monitor AS-FECAT. List of browsers that support AS-FECAT webpage:

Provider	Browser	Supported versions
Microsoft	Internet Explorer	V10.0 and later
Microsoft	Edge	V20 and later
Google	Chrome	V14 and later
Apple	Safari	V5.1 and later

- **When AS-FECAT is installed on AS300 Series PLC CPU**

- After the setting IP address in HWCONFIG of ISPSOft. Open your browser and enter AS-FECAT IP address in the search bar to connect to AS-FECAT. After the webpage appears, enter “Admin” in the User section and click Login without entering any password. You can set up the password after login.

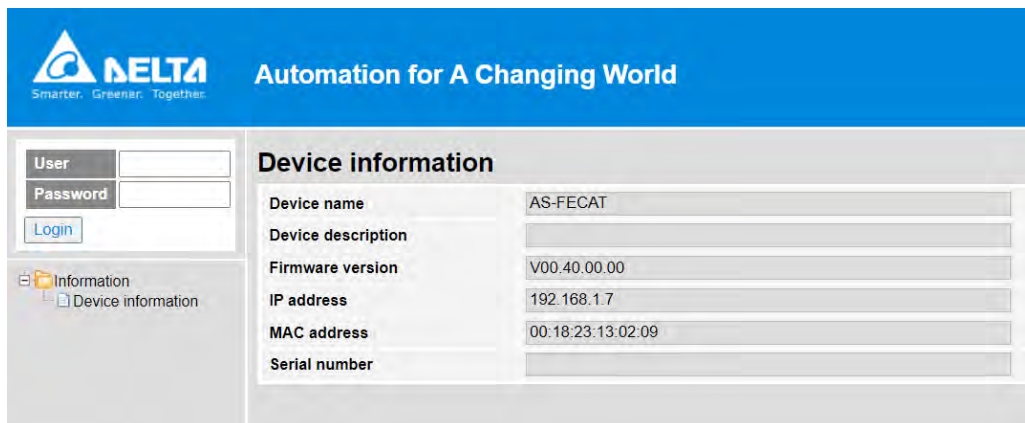

- After login, you can check the items shown on the left section.

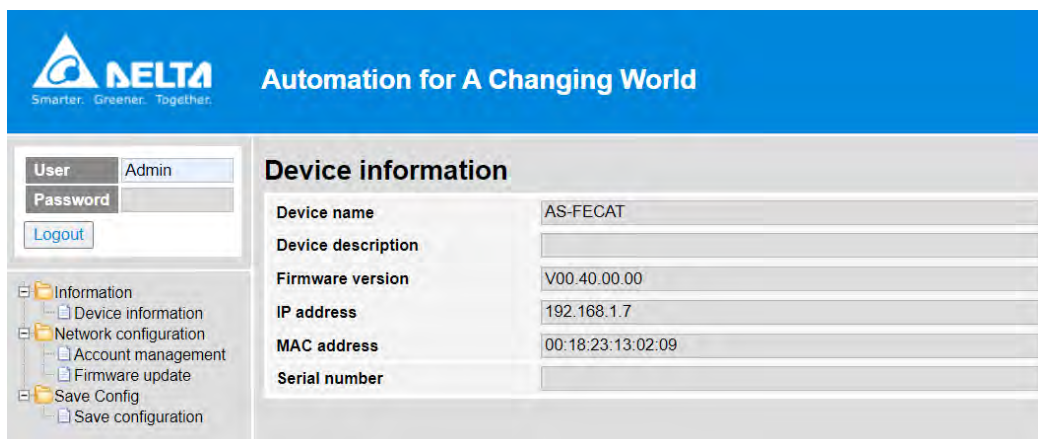

- c. The menu shows data based on the permission of the current user.

Nodes	Permission	
	Administrator	Read
Device information	V	V
Account management	V	X
Firmware update	V	X
Save configuration	V	X

- d. Account Management: You can set 2 kinds of access types, Administrator and Read. After the setting is done, click **Apply** and save the settings in Save configuration.

Account management

No.	User ID	Password	Access type	Delete
1	Admin		Administrator	Delete
2	Test1	****	Read	Delete
3			Administrator	Delete
4			Write/Read	Delete
5			Read	Delete
6			Administrator	Delete
7			Administrator	Delete
8			Administrator	Delete

Apply

- e. Firmware Update: You can update the firmware of AS-FECAT via the webpage.
 f. Save Configuration: After any setting is done, save the settings in Save Configuration to reflect the changes.

10.2.11.10 Network Security

To enhance security and performance of the system, it is suggested to use closed network or LAN with firewall protection to prevent cyber-attacks.

10.3 Profiles and Dimensions

10.3.1 AS-F232

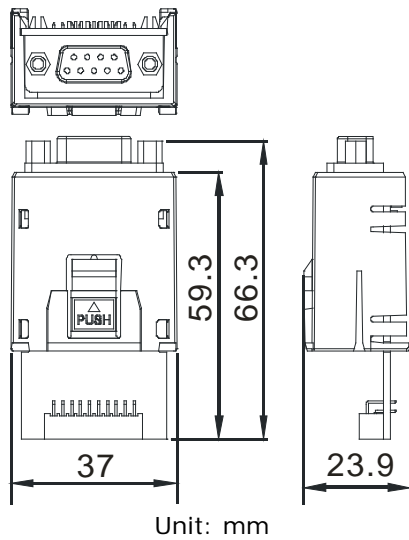

10.3.2 AS-F422/AS-F485/AS-F2AD/AS-F2DA

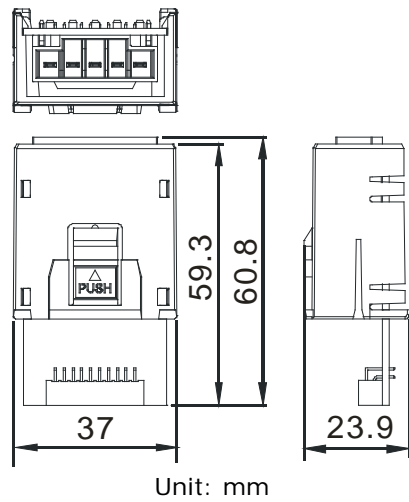

10.3.3 AS-FCOPM

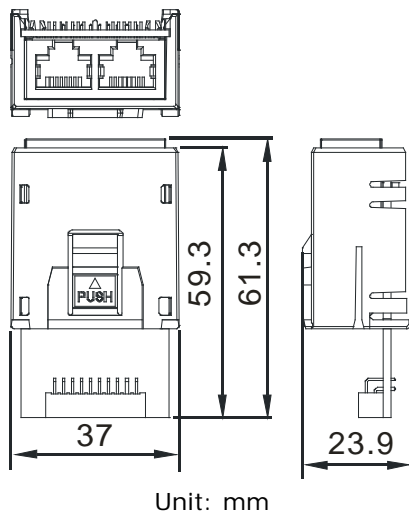

10.3.4 AS-FEN02

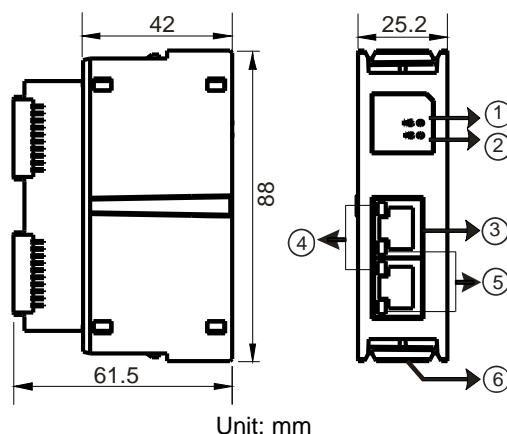

Number	Name	Description
1	MS indicator	Indicates the status of the communication card Green light ON: the operation is working normal Green light BLINKING: the setting is not complete Red light ON: internal communication fail, can NOT be recovered Red light BLINKING: internal communication timeout OFF: no power
2	NS indicator	Indicates the status of Ethernet connection Green light ON: a CIP connection is established Green light BLINKING: a CIP connection is not established after power-on Red light ON: duplicated IP address Red light BLINKING: communication timeout (a CIP connection has been established after power-on) / IP address change OFF: no power / network cable is not connected
3	RJ-45 port X1/X2	For network connections
4	LINK indicator X1/X2	Indicate the status of Ethernet connection Green light ON: a network connection is established OFF: a network connection is not established
5	ACT indicator X1/X2	Indicate the status of Ethernet communication Orange BLINKING: data transmission OFF: no data transmission
6	Clip ring	Secures AS series

RJ-45 Pin Definition

Pin No.	RJ-45
1	TX+
2	TX-
3	RX+
4	N/C
5	N/C
6	RX-
7	N/C
8	N/C

8-1

10.3.5 AS-FPFN02

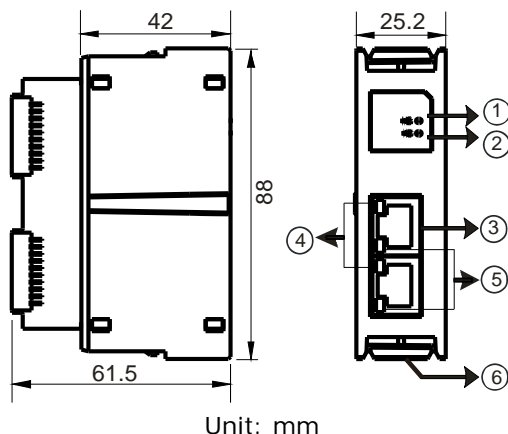

Number	Name	Description
1	SF indicator	System Fault Indicator Red light ON: an error occurs in the topology or RTU module OFF: no system error
2	BF indicator	Bus Fault Indicator Red light ON: no PROFINET connection Red light BLINKING: the connection is working fine but the communication with PROFINET Controller is NOT normal. OFF: the connection with PN-Controller is working fine.
3	RJ-45 port X1/X2	Uses for network connections
4	LINK indicator X1/X2	Indicates the status of Ethernet connection Green light ON: a network connection is established OFF: a network connection is not established
5	ACT indicator X1/X2	Indicates the status of Ethernet communication Orange BLINKING: data transmission OFF: no data transmission
6	Clip ring	Secures AS series

RJ-45 Pin Definition

Pin No.	RJ-45
1	TX+
2	TX-
3	RX+
4	N/C
5	N/C
6	RX-
7	N/C
8	N/C

8 ← 1

10.3.6 AS-FOPC02

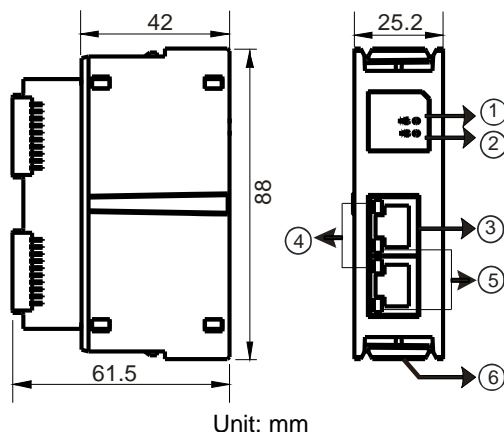

Number	Name	Description
1	MS indicator	Indicates the status of the communication card Green light ON: the operation is working normal Green light BLINKING: the setting is not complete Red light ON: powering on, or internal communication fail, can NOT be recovered Red light BLINKING: internal communication timeout OFF: no power
2	NS indicator	Indicates the status of Ethernet connection Green light ON: an OPC UA connection is established Green light BLINKING: an OPC UA connection is not established after power-on Red light ON: duplicated IP address Red light BLINKING: communication timeout (OPC UA connection has been established after power-on) / IP address change OFF: no power / network cable is not connected
3	RJ-45 port X1/X2	For network connections
4	LINK indicator X1/X2	Indicate the status of Ethernet connection Green light ON: a network connection is established OFF: a network connection is not established
5	ACT indicator X1/X2	Indicate the status of Ethernet communication Orange BLINKING: data transmission OFF: no data transmission
6	Clip ring	Secures AS series

RJ-45 Pin Definition

Pin No.	RJ-45
1	TX+
2	TX-
3	RX+
4	N/C
5	N/C
6	RX-
7	N/C
8	N/C

8-1

10.3.7 AS-FFTP01

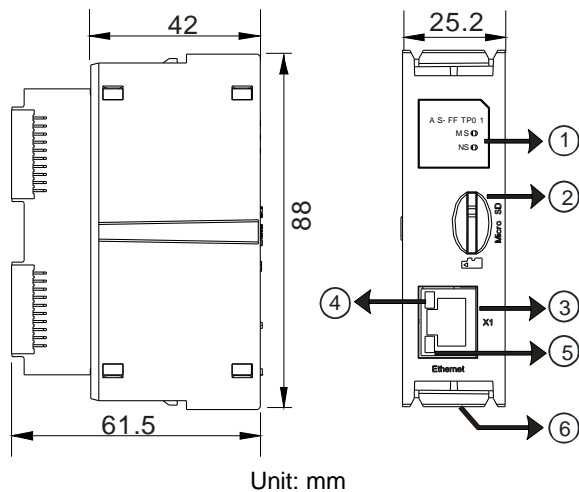

Number	Name	Description
1	MS indicator	Indicates the status of the communication card Green light ON: the communication card operation is working normal Green light BLINKING: communication card is initializing Red light ON: powering on or internal communication fail, can NOT be recovered Red light BLINKING: internal communication timeout; reboot is required. OFF: no power
	NS indicator	Red light ON: IP address conflict; remove the device with the same IP address on the network
2	Micro SD card slot	For Micro SD card
3	RJ-45 port	For network connections
4	LINK indicator	Indicate the status of Ethernet connection Green light ON: a network connection is established OFF: a network connection is not established
5	ACT indicator	Indicate the status of Ethernet communication Orange BLINKING: data transmission OFF: no data transmission
6	Clip ring	Secures AS series

RJ-45 Pin Definition

Pin No.	RJ-45
1	TX+
2	TX-
3	RX+
4	N/C
5	N/C
6	RX-
7	N/C
8	N/C

8-1

10.3.8 AS-FECAT

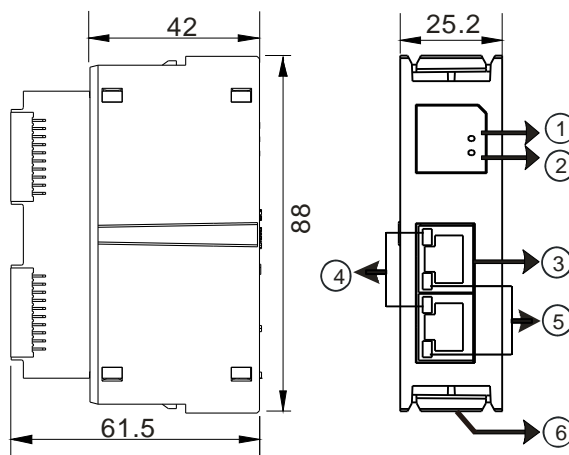

Unit: mm

Number	Name	Description
1	SYS indicator	Indicates the power status of the communication card and the status of the firmware update Green light ON: Power On Green light BLINKING: firmware updating OFF: no power or firmware updating is complete.
2	ECAT indicator	Indicates the status of EtherCAT communication Green light ON: the communication card operation is working normal (All slaves are in the operational state.) Red light ON: the network connection between master and slave is not established. Red light BLINKING (2s): the connection of slave is lost. Red light BLINKING (5s): the state of slave is not normal OFF: ECAT master function is not enabled. Going to state of firmware updating
3	RJ-45 ports x1, x2	For network connections
4	LINK indicators x1, x2	Indicate the status of Ethernet connection Green light ON: a network connection is established OFF: a network connection is not established
5	ACT indicators x1, x2	Indicate the status of Ethernet communication Orange BLINKING: data transmission OFF: no data transmission
6	Clip ring	Secures AS series

RJ-45 Pin Definition

Pin No.	RJ-45
1	TX+
2	TX-
3	RX+
4	N/C
5	N/C
6	RX-
7	N/C
8	N/C

10.4 Wiring

10.4.1 AS-F2AD

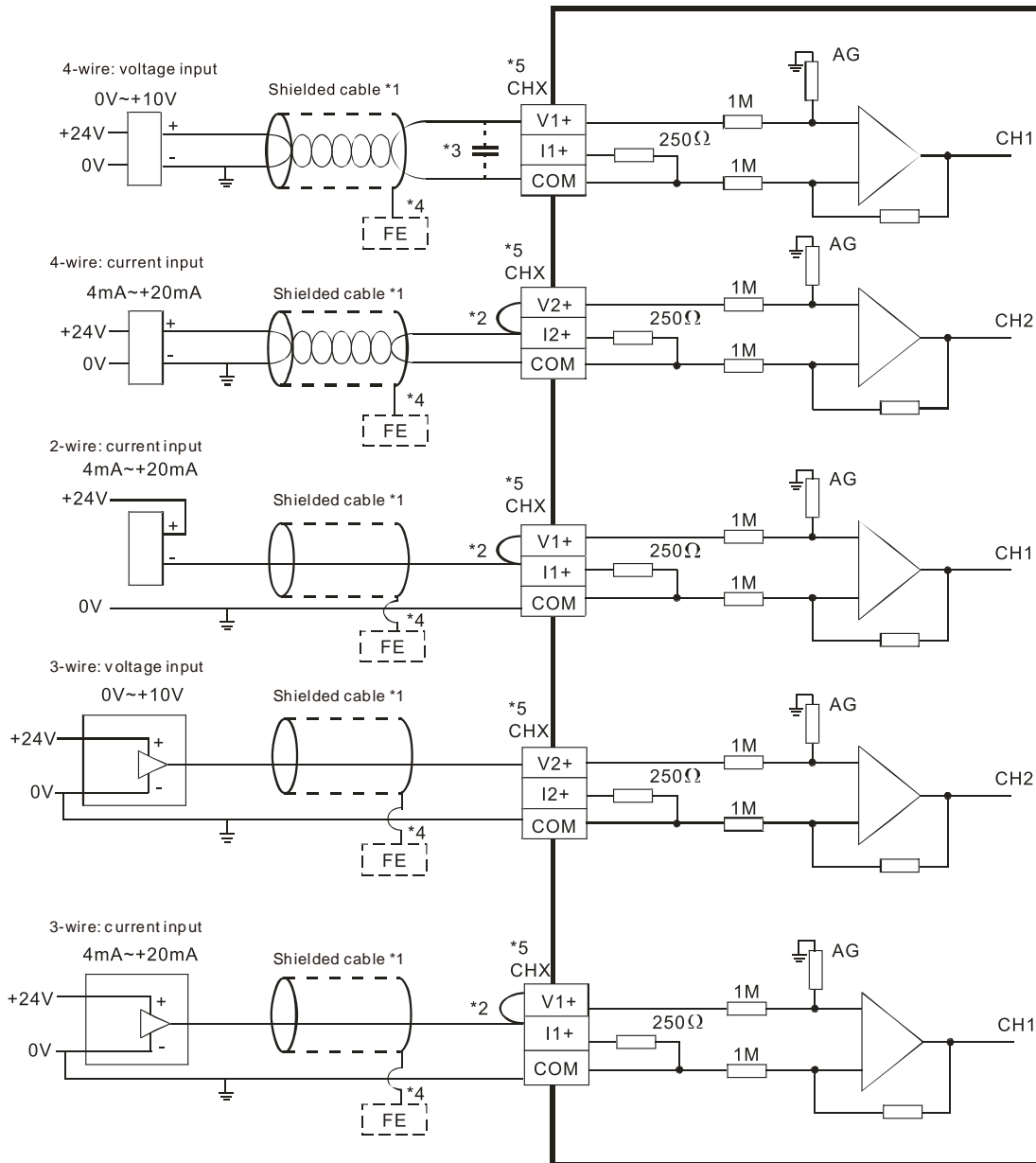

- *1. Use shielded cables to isolate the analog input signal cable from other power cables.
- *2. If the module is connected to a current signal, the terminals Vn and In+ (n=1-2) must be short-circuited.
- *3. If variability in the input voltage results in interference within the wiring, connect the module to a capacitor having a capacitance in the range of 0.1-0.47 μF and a working voltage of 25 V.
- *4. Connect the shielded cable to the terminal FE.
- *5. The wording "CHX" indicates that you can use the five wiring methods listed above for every input channel.

10.4.2 AS-F2DA

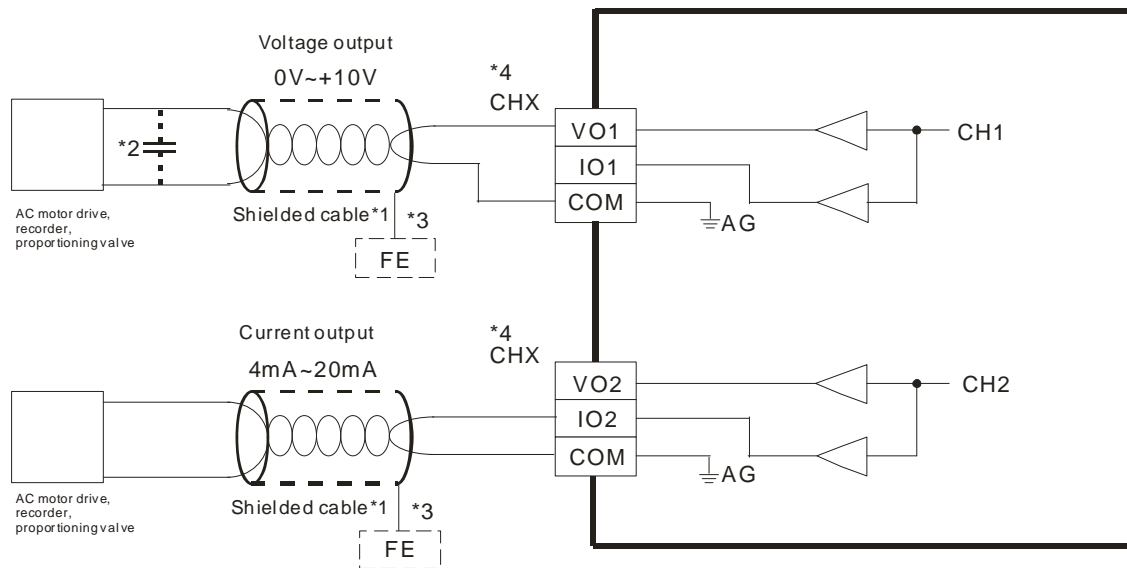

*1. Use shielded cables to isolate the analog input signal cable from other power cables.

*2. If variability in the input voltage results in interference within the wiring, connect the module to a capacitor having a capacitance in the range of 0.1–0.47 μF and a working voltage of 25 V.

*3. Connect the shielded cable to the terminal FE.

*4. The wording "CHX" indicates that you can use the two wiring methods listed above for every input channel.

10.4.3 Topology of AS-FEN02, AS-FOPC02, AS-FPFN02 and AS-FECAT

1. AS-FEN02, AS-FOPC02, AS-FPFN02, AS-FECAT (EtherCAT OFF)

- Linear Topology

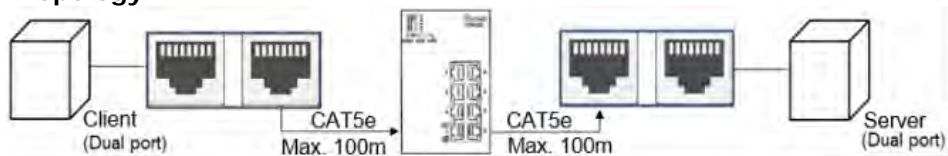

- Star Topology

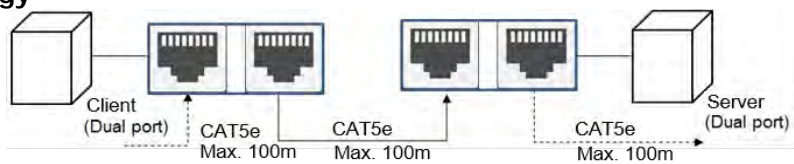

2. AS-FECAT sets EtherCAT Master Port via HWCONFIG (EtherCAT ON)

- Use Port x1 as EtherCAT Master

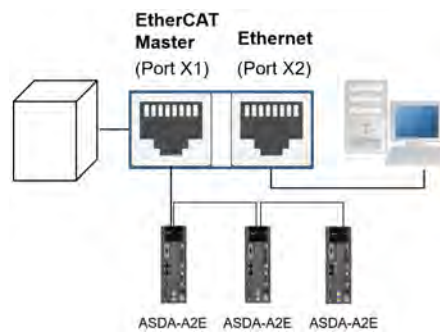

- Use Port x2 as EtherCAT Master

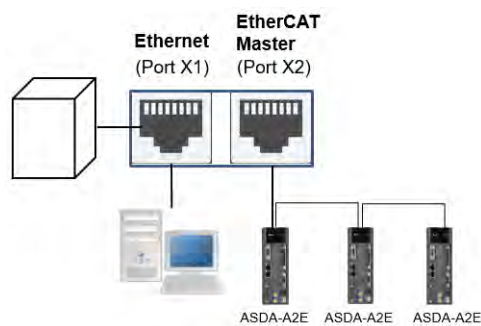

10.4.4 Topology of AS-FFTP01

- **Linear Topology**



- **Star Topology**

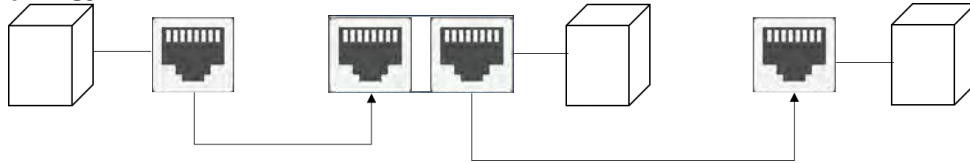

10.5 HWCONFIG in ISPSOft

10.5.1 Initial Setting

(1) Start ISPSOft and double-click **HWCONFIG**.

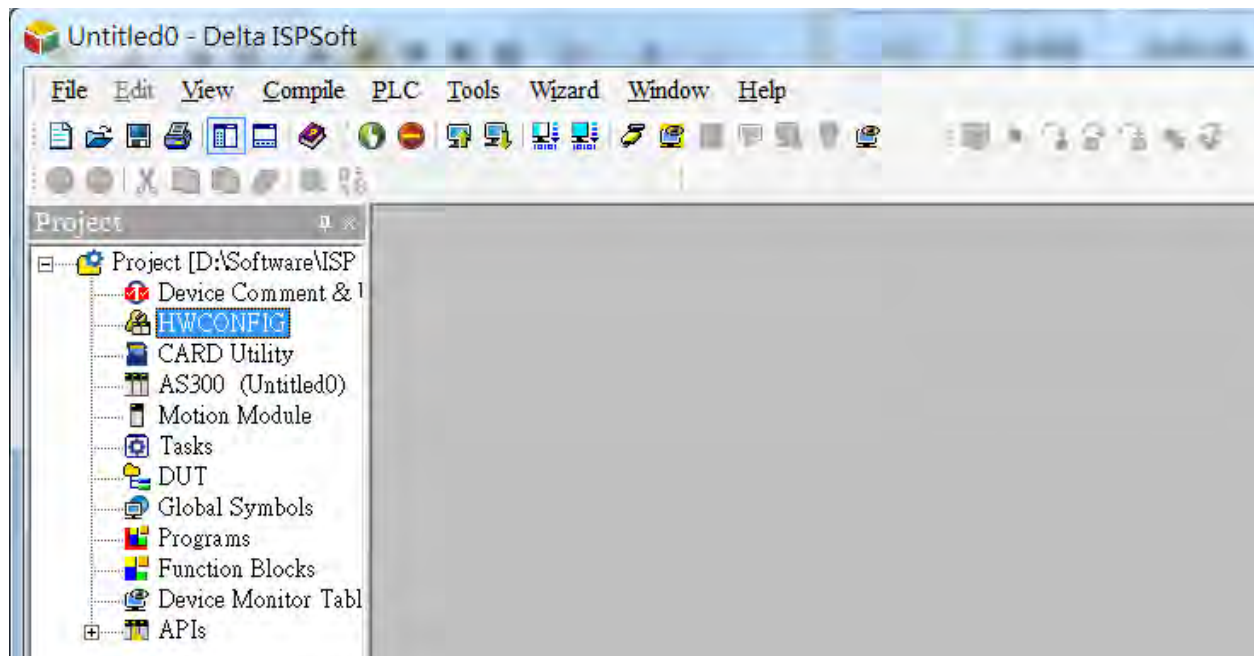

(2) Select a function card on the module.

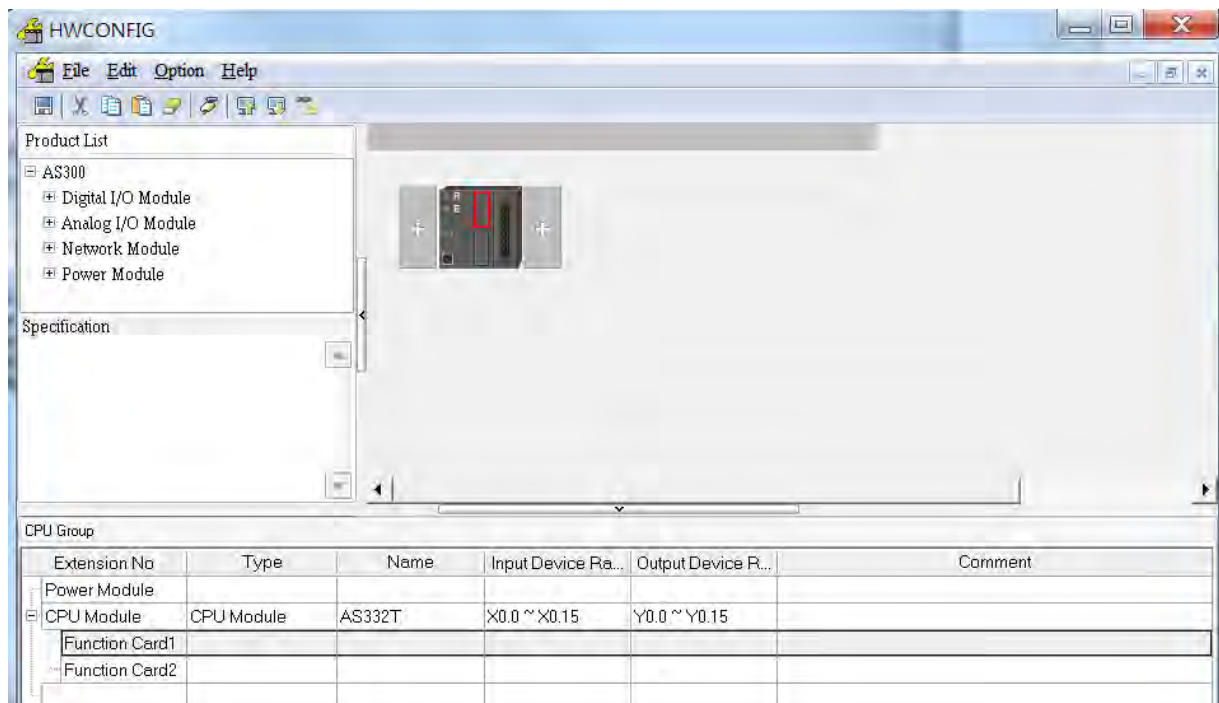

- (3) Double-click the function card to open the Device Setting page.

Card1 Detect mode: select Auto Detect or choose the function card model.

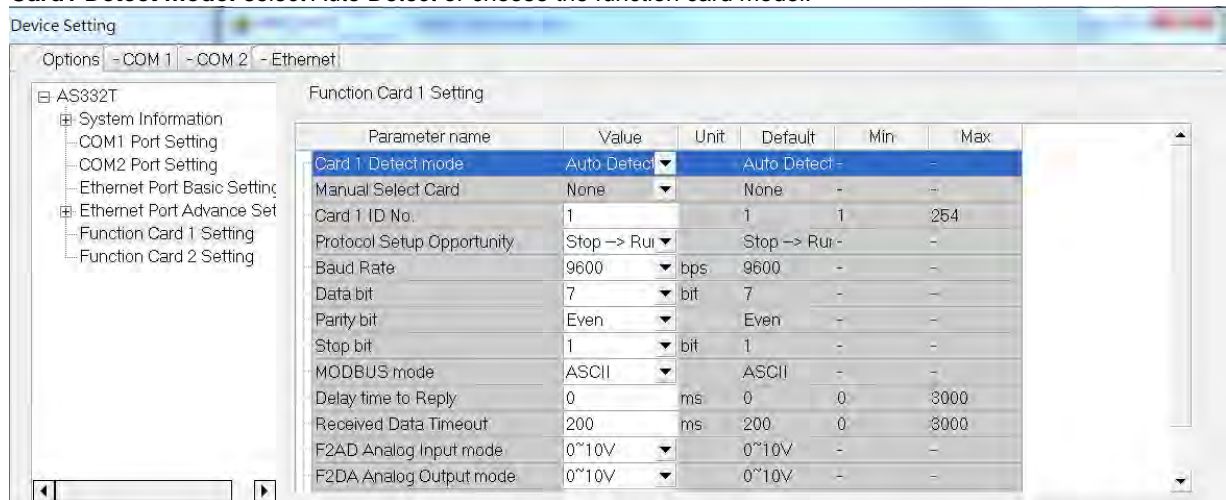

- (a) When the function card is an AS-F232, AS-F422, or AS-F485, configure the communication settings in the red box.

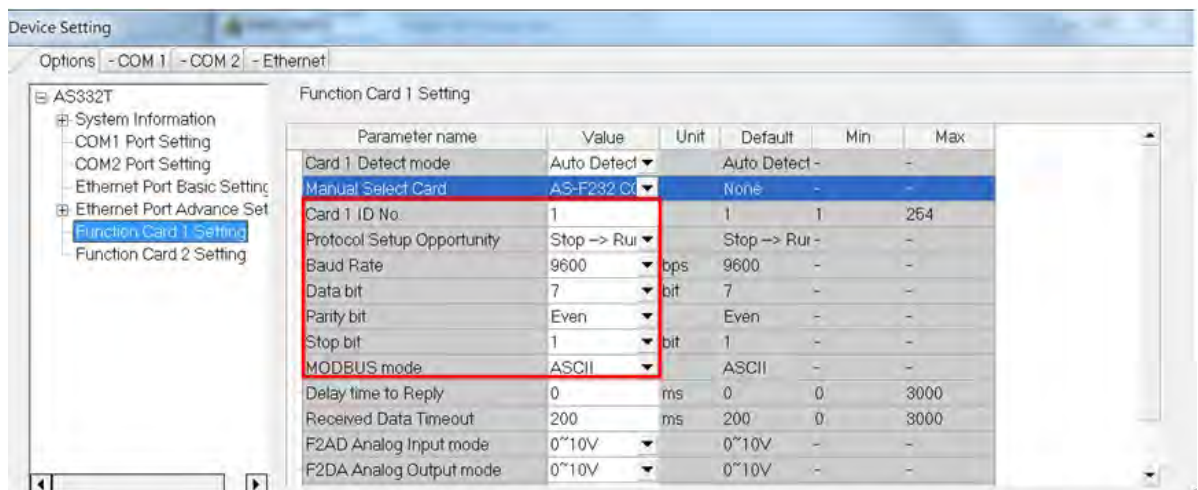

- (b) Function card AS-FCOM can only be installed in function card slot 2.

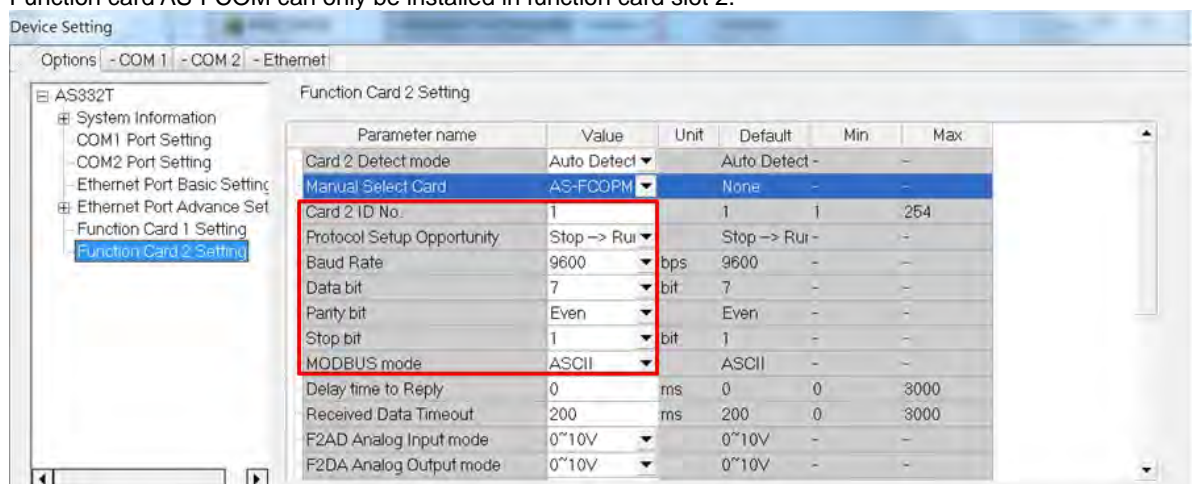

(c) Configure the communication settings in the red box.

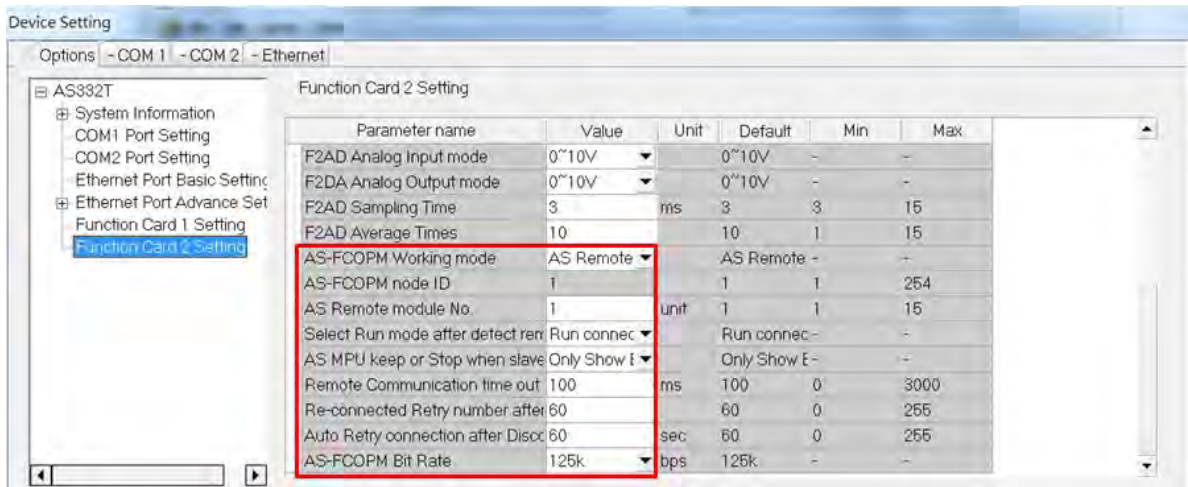

(d) When the function card is an AS-F2AD or AS-F2DA, configure the communication settings in the red box.

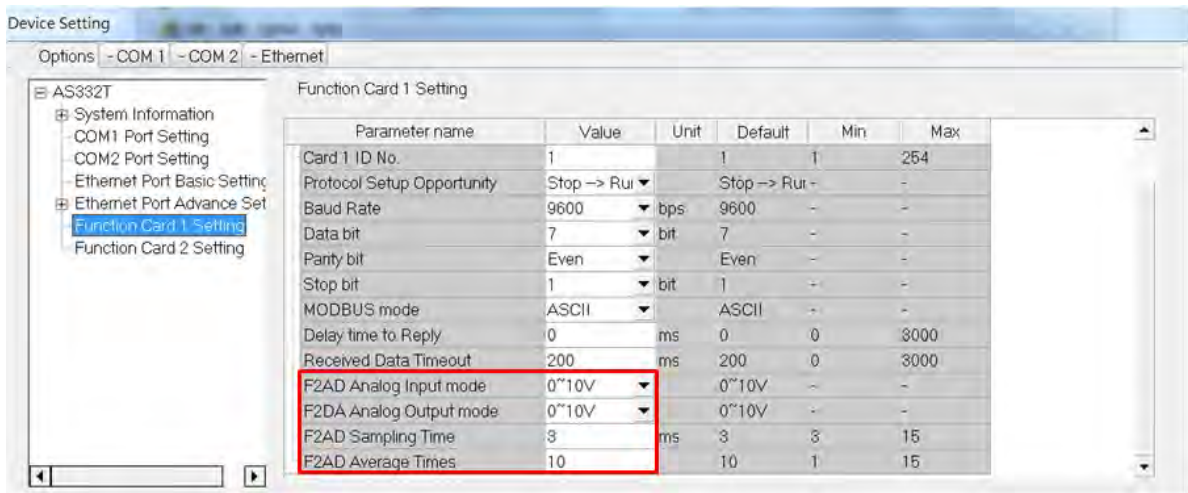

(e) When the function card is an AS-FEN02 or AS-FECAT, configure the communication settings in the red box.

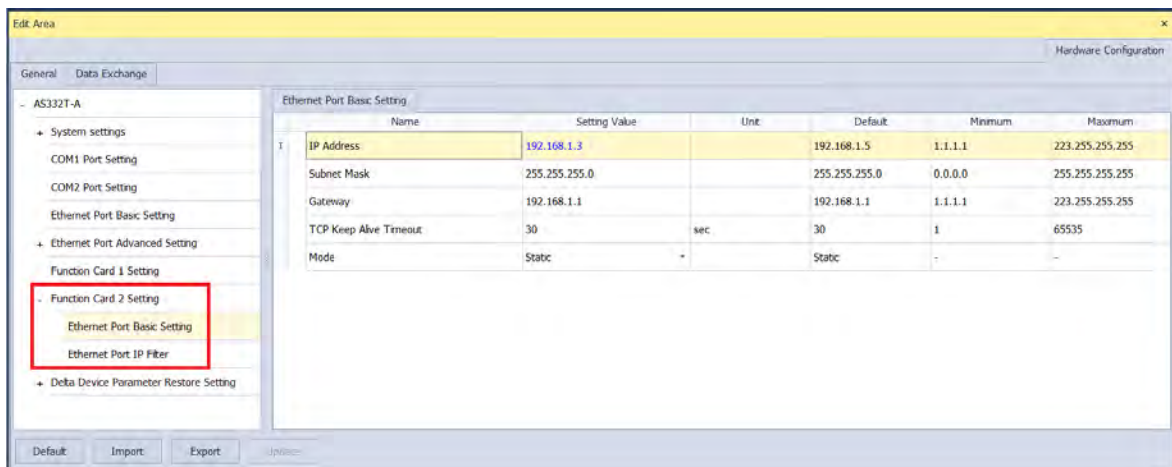

- (f) Click **OK** to confirm the settings.

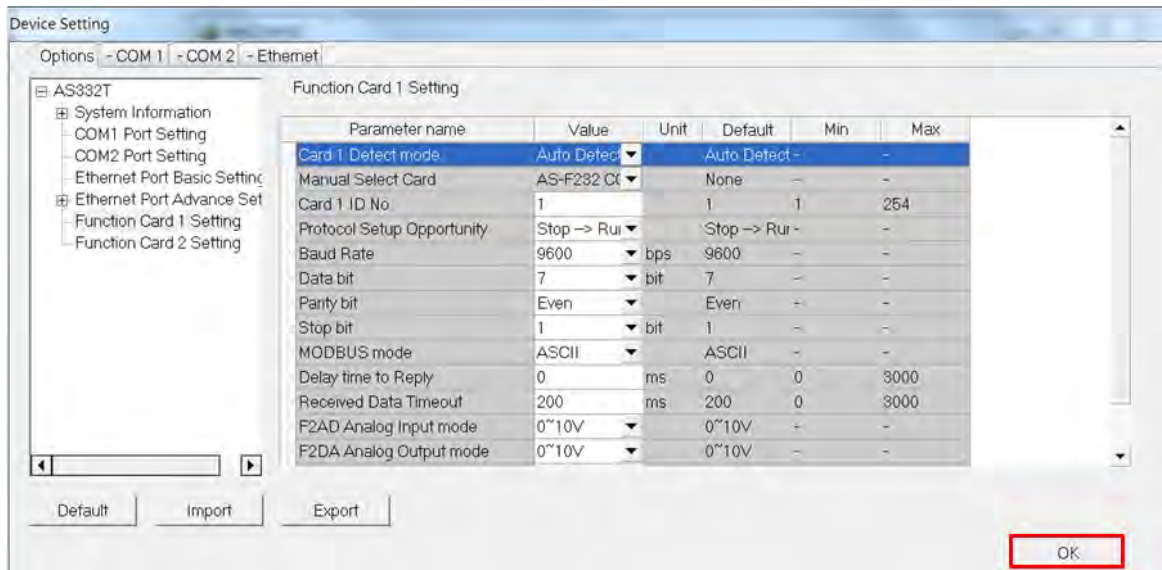

- (4) Click **Download** on the toolbar to download the parameters. Note that you cannot download the parameters while the CPU module is running.

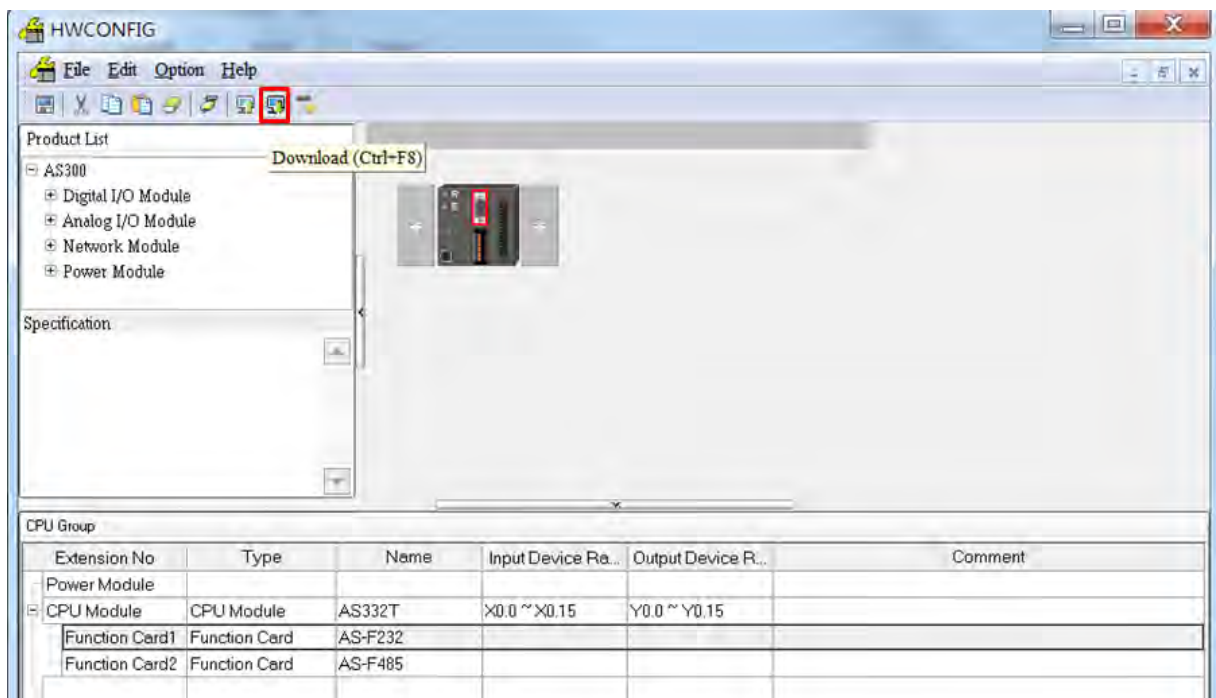

MEMO

Chapter 11 DeviceNet Master Scanner Module AS01DNET-A

Table of contents

11.1 Introduction o AS01DNET-A	11-3
11.1.1 Feature	11-3
11.1.2 Specifications	11-3
11.2 Components of AS01DNET-A	11-4
11.2.1 Profile and Dimensions	11-4
11.2.2 Components.....	11-5
11.2.3 Mode Toggle (RTU- Master/Slave)	11-5
11.2.4 DeviceNet Connector	11-5
11.2.5 Address Switch.....	11-6
11.2.6 Function Switch	11-6
11.2.7 Digital Displayer	11-6
11.3 DeviceNet Network Communication	11-7
11.3.1 Relationship between Transmission Distance and Baud Rate	11-7
11.3.2 DeivceNet Network Topology Structure.....	11-7
11.3.3 Choice and Purpose of a DeviceNet Terminal Resistor	11-11
11.3.4 DeviceNet Network Supply Power	11-12
11.4 Master /Slave Mode.....	11-13
11.4.1 Introduction of Master/Slave Mode	11-13
11.4.1.1. Scan List, Input Table and Output Table	11-13
11.4.2 Installation	11-14
11.4.2.1. Connecting AS01DNET-A Module to AS series PLC	11-14
11.4.2.2. Connecting the DeviceNet Communication Connector	11-14
11.4.3 IO Mapping for AS01DNET in AS PLC	11-15
11.4.3.1. Data Mapping between Modules and AS PLC.....	11-15
11.4.3.2. Tables of Input Mapping and Output Mapping areas.....	11-16
11.4.4 Bit-strobe Command	11-17
11.4.4.1. Bit-strobe Work Principle	11-17
11.4.5 Network Node Status Display.....	11-18
11.4.5.1. Scan-List Node Status Indication	11-18
11.4.5.2. Module Status Indication	11-18
11.4.6 Setting the Time for Data Exchange between Master and Slaves	11-18
11.4.7 Application Example	11-19
11.4.7.1. Constructing One DeviceNet Network	11-20

11.4.7.2. Using DeviceNet Builder to Configure a DeviceNet Network	11-21
11.4.7.3. DeviceNet Network Control.....	11-28
11.4.8 Sending Explicit Message through Ladder Diagram	11-29
11.4.8.1. Principle of Explicit Message Transmission	11-29
11.4.8.2. Explicit Message Transmission Instruction DNETRW.....	11-30
11.4.9 LED Indicators and Troubleshooting.....	11-36
11.4.9.1. NS LED.....	11-36
11.4.9.2. MS LED	11-37
11.4.9.3. Combination of MS LED and NS LED	11-37
11.4.9.4. Digital Displayer	11-37
11.4.10 Master-Slave Mode Switch and 8 Baud Rates Setting via Software	11-39
11.4.10.1. Setting AS01DNET-A to Slave Mode	11-39
11.4.10.2. Setting AS01DNET-A to Master Mode	11-42
11.4.10.3. Baud Rate Setting of When AS01DNET-A is in Slave Mode	11-45
11.4.10.4. Baud Rate Setting of When AS01DNET-A is in Master Mode	11-48
11.5 RTU Mode	11-51
11.5.1 Introduction of AS01DNET (in RTU Mode).....	11-51
11.5.2 AS-Series Extension Modules Connectable to AS01DNET (RTU)	11-52
11.5.3 Installation	11-53
11.5.3.1. Installing AS01DNET (in RTU Mode).....	11-53
11.5.3.2. Connecting the Cable to DeviceNet Connector	11-54
11.5.4 Configuring AS01DNET (in RTU mode)	11-55
11.5.4.1. Terms	11-55
11.5.4.2. Introduction of Software	11-56
11.5.4.3. DeviceNet Mapping Data	11-74
11.5.4.4. Connecting AS01DNET (RTU) to the Network	11-81
11.5.5 Application Example.....	11-82
11.5.5.1. Network Structure	11-82
11.5.5.2. Using DeviceNet Builder to Configure the Network.....	11-82
11.5.5.3. Using LD Program to Control the Entire Network.....	11-91
11.5.6 Error Diagnosis and Trouble Shooting	11-91
11.5.6.1. Indicator Diagnosis	11-92
11.5.6.2. Codes in Seven-Segment Displayer	11-93
11.5.6.3. Status Word Diagnosis.....	11-95
11.5.6.4. Software Diagnosis	11-96
11.6 How to Call DeviceNet Builder through ISPSOFT (AS-Series PLC)	11-97

11.1 Introduction of AS01DNET-A

- Thank you for choosing Delta AS01DNET-A. Please read this chapter carefully before use so as to ensure correct installation and operation of AS01DNET-A.
- The instruction is simply a guideline for operation of the product and the details on the DeviceNet protocol is excluded here. Please refer to relevant articles and literatures for more details on the DeviceNet protocol.
- AS01DNET-A, a DeviceNet network module can work in two modes: master /slave and RTU. The RTU-Master/Slave switch is used for selecting one of the two modes. When AS01DNET-A works in master/slave mode, it makes up the DeviceNet master or slave with AS-series PLC together. When working in RTU mode, AS01DNET-A needs an external 24VDC power supply and can connect AS-series I/O modules on its right side.

Refer to Section 11.4 and 11.5 for details about master/slave mode and RTU mode.

11.1.1 Feature

- Supports the Group 2 server slave and Group 2 only servers.
- Supports the explicit connection in the predefined master/slave connection and I/O polling connection.
- Able to work as a DeviceNet master or slave as well as a remote RTU connecting AS series I/O modules.
- The network configuration software DeviceNet Builder offers the graphical configuration interface.
- Supports the EDS file configuration in the DeviceNet network configuration tool.

11.1.2 Specifications

- **DeviceNet Connector**

Item	Specifications
Transmission method	CAN
Isolation voltage	500 VAC
Connector type	Removable terminal block with screws (5.08mm)
Communication cable	2 communication wires, 2 power wires and 1 shielded wire included.

- **DeviceNet Communication**

Item	Specifications
Message type	I/O polling connection, explicit connection
Baud rate	Standard: 125 kbps, 250 kbps and 500 kbps Extension: 10 kbps, 20 kbps, 50 kbps, 125 kbps, 250 kbps, 500 kbps, 800kbps and 1M bps.

- **Electrical Specification**

Item	Specifications
Voltage	The power wires of the communication cable provide 11 ~ 25 VDC.
Current	28mA (typical value), 125mA impulse current (24 VDC)

● Environment

Item	Specifications
Noise immunity	ESD (IEC 61131-2, IEC 61000-4-2): 8KV Air Discharge EFT (IEC 61131-2, IEC 61000-4-4): Power Line: 2KV, Digital I/O: 1KV Analog & Communication I/O: 1KV Damped-Oscillatory Wave: Power Line: 1KV, Digital I/O: 1KV RS (IEC 61131-2, IEC 61000-4-3): 26MHz ~ 1GHz, 10V/m
Operating Environment	-20°C ~ 60°C (Temperature); 5 ~ 95% (Humidity), no condensation; pollution degree: 2
Storage Environment	-40°C ~ 80°C (Temperature); 5~95% (Humidity), no condensation
Vibration/Shock resistance	International standard IEC 61131-2, IEC 68-2-6 (TEST Fc)/IEC 61131-2 & IEC 68-2-27 (TEST Ea)
Safety	Conforms to IEC 61131-2, UL508
Weight	128 g

11.2 Components of AS01DNET-A

11.2.1 Profile and Dimensions

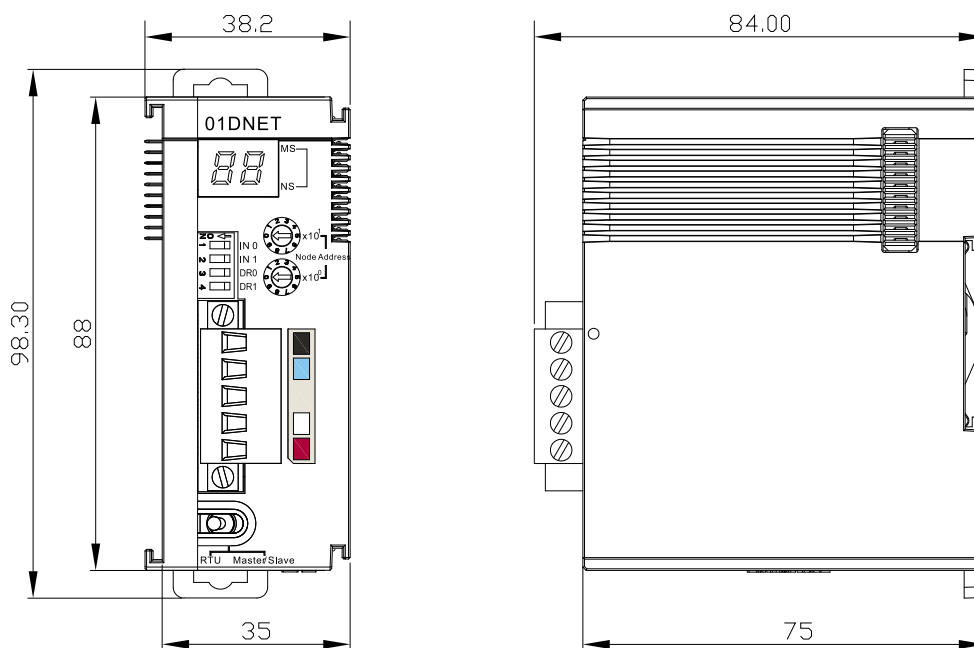

11.2.2 Components

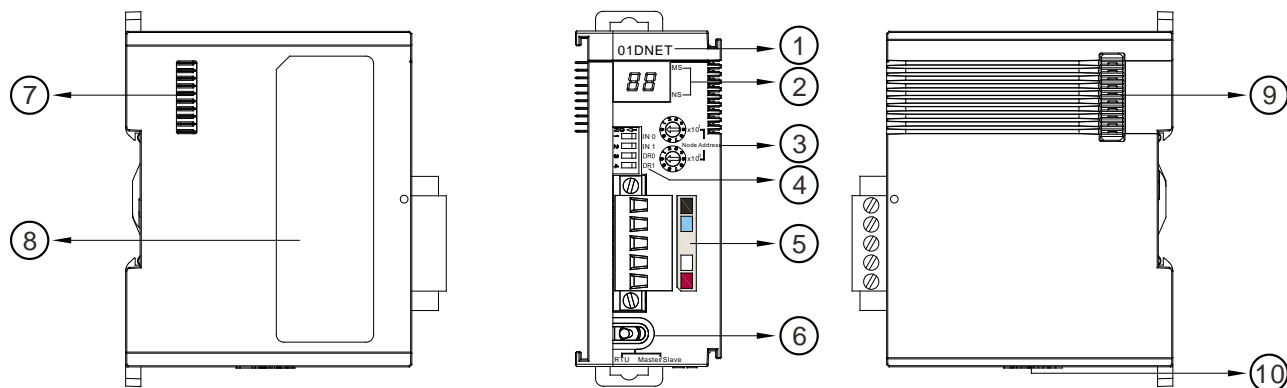

①	Model name	⑥	Mode toggle (RTU-Master/Slave)
②	State indicators	⑦	Left-side extension port
③	Address switch	⑧	Nameplate
④	Function switch	⑨	Right-side extension port
⑤	DeviceNet communication port	⑩	24V DC power input port for RTU mode

Note:

The power input port of the network module is required to connect an external 24VDC power supply only when the toggle (RTU- Master/Slave) is switched to RTU mode. Otherwise, the port does not need an external 24VDC power supply connected when the toggle (RTU- Master/Slave) is switched to Master/Slave mode.

11.2.3 Mode Toggle (RTU- Master/Slave)

Mode Selection	Description
Master/Slave	Works in master or slave mode and constitutes a DeviceNet master or slave without external power supply.
RTU	When working in remote (RTU) mode, AS01DNET-A is required to connect the external DC 24V power supply and can have AS series I/O modules connected on its right side.

11.2.4 DeviceNet Connector

The connector is used for the connection to DeviceNet. Wire by using the connector enclosed with AS01DNET –A.

Pin	Signal	Color	Description
1	V-	Black	0 VDC
2	CAN_L	Blue	Signal-
3	SHIELD	-	Shielded wire
4	CAN_H	White	Signal+
5	V+	Red	24 VDC

11.2.5 Address Switch

The switch is used for setting up the node address of AS01DNET-A in DeviceNet network. Range: 00~63 (64~99 are forbidden.)

Switch setting	Description	
0 ... 63	Valid DeviceNet node address	
64...99	Invalid DeviceNet node address	

Example: If users need to set the node address of AS01DNET-A to 26, simply switch the corresponding switch of x101 to 2 and the corresponding switch of x100 to 6.

Note:

- ✓ After the setup is completed, repower AS01DNET-A.
- ✓ While AS01DNET-A is working, changing the setting of the node address is invalid.
- ✓ Rotate the switch carefully with a slotted screwdriver to prevent damage to the switch.

11.2.6 Function Switch

- The function switches are used for:
 - Setting up the work mode (IN0)
 - Setting up the baud rate of DeviceNet network (DR0~DR1)

DR1	DR0	Baud Rate	
OFF	OFF	125 Kbps	
OFF	ON	250 Kbps	
ON	OFF	500 Kbps	
ON	ON	Entering the mode of extended baud rate	
IN0	ON	When the slave is off-line, the I/O data in the buffer area will be held.	
	OFF	When the slave is off-line, the I/O data in the buffer area will be cleared.	
IN1	Reserved		

Note:

- ✓ After the setup of the function switch is completed during power off, repower AS01DNET-A.
- ✓ While AS01DNET-A is working, changing the setting of the node address is invalid.
- ✓ Adjust the DIP switch carefully with a slotted screwdriver to prevent any damage to the switch.

11.2.7 Digital Displayer

- The digital displayer provides following functions:
 - Showing the node address of AS01DNET-A and error ID
 - Showing the error information about a slave

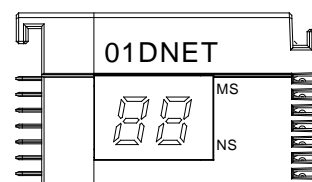

11.3 DeviceNet Network Communication

11.3.1 Relationship between Transmission Distance and Baud Rate

The transmission distance of a DeviceNet network is determined by the baud rate. The following table shows the corresponding maximum communication distance at different baud rates.

Baud rate (bits/s)	10K	20K	50K	125K	250K	500K	800K	1M
Max. transmission distance (M)	5000	2500	1000	500	250	100	50	25



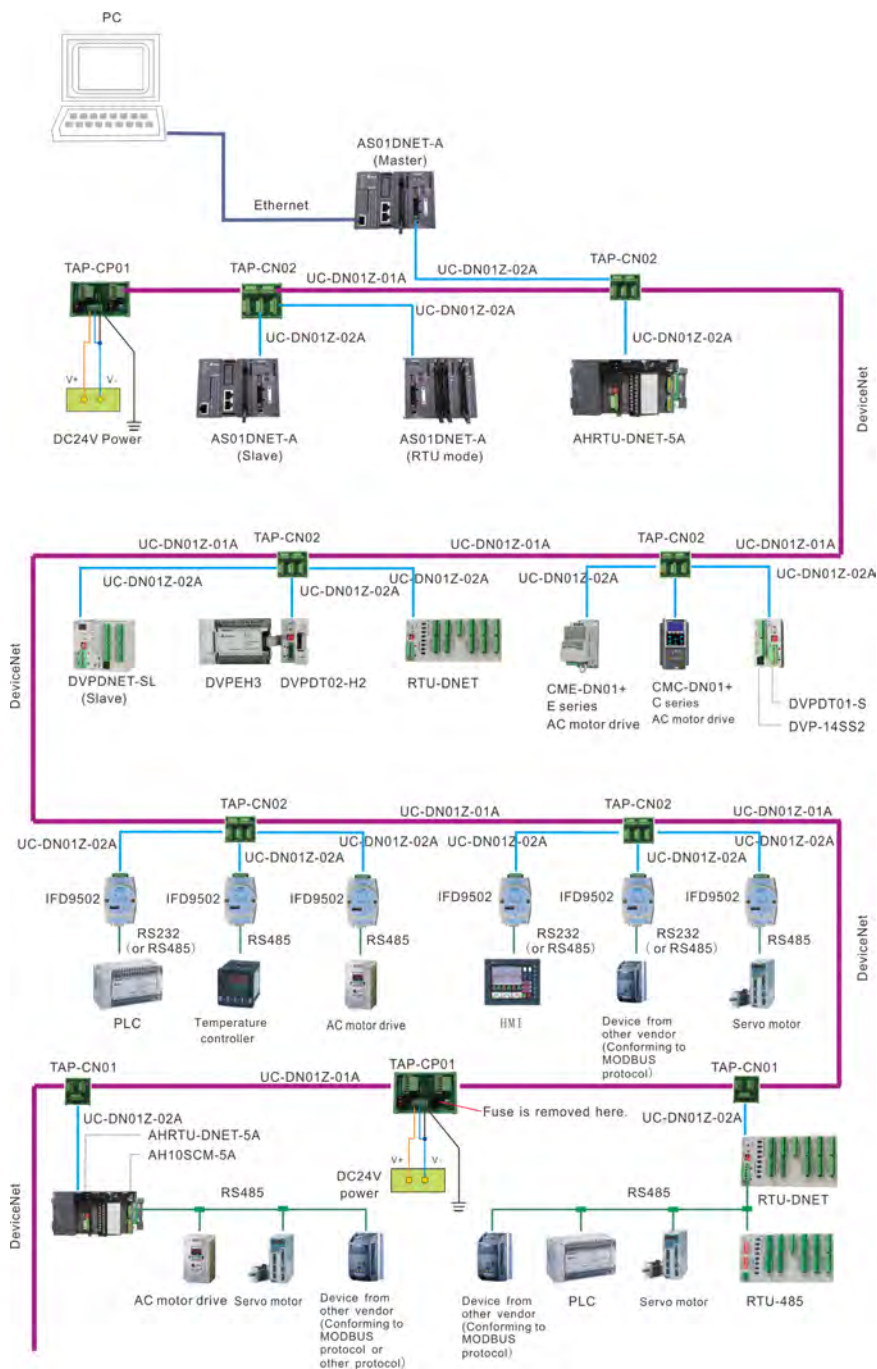



11.3.2 DeviceNet Network Topology Structure



List of Delta DeviceNet Fieldbus Network Products:

Product picture	Model	Function
	AS01DNET-A	<ol style="list-style-type: none"> 1. AS01DNET-A, a DeviceNet module running on the right of AS PLC can work as a DeviceNet master or slave. 2. AS01DNET-A can also be used as AS series remote IO module for connecting AS series DI/DO modules and AI/AO modules to DeviceNet network.
	AH10DNET-5A	AH10DNET-5A, a DeviceNet module, running on the right of AH500 series PLC can work as a DeviceNet master or slave.
	AHRTU-DNET-5A	AHRTU-DNET-5A, a remote I/O module of AH series, is used for connecting AH500 series DI/DO module, AI/AO module and 10SCM module to DeviceNet network.
	DVDPNET-SL	DVDPNET-SL, a DeviceNet module, running on the left of S series PLC can work as a DeviceNet master or slave.
	RTU-DNET	RTU-DNET, a remote I/O module of S series, is used for connecting S-series DI/DO module, AI/AO module and other device to DeviceNet network.

Product picture	Model	Function
	IFD9502	Used for connection of the DeviceNet network and electromechanical equipment such as AC motor drive, PLC, temperature controller, servo drive, HMI, user-defined device.
	IFD6503	A fieldbus data analysis tool, with one end: CAN interface and the other end: USB interface can be used for getting the CAN data or sending the data to the CAN node. It is used with the Netview Builder software together.
	E-series AC motor drive	Used for connecting AC motor drive to DeviceNet network via CME-DN01 card.
	CMC-DN01	Used for connecting C2000 series AC motor drive to the DeviceNet network.
	DN-02	Used for the connection of DeviceNet network and AC motor drive.
	DVPDT01-S	Used for the connection of DeviceNet network and S series PLC.

Product picture	Model	Function
	DVPDT02-H2	Used for the connection of DeviceNet network and DVP-EH2 series PLC.
	TAP-CP01	The distribution box for CAN topology, with the 120 ohm resistor enclosed which is controlled to take effect or not via its switch.
	TAP-CN01	The distribution box for CAN topology, with the 120 ohm resistor enclosed which is controlled to take effect or not via its switch.
	TAP-CN02	The distribution box for CAN topology, with the 120 ohm resistor enclosed which is controlled to take effect or not via its switch.
	UC-DN01Z-01A	UC-DN01Z-01A: DeviceNet trunk cable.
	UC-DN01Z-02A	UC-DN01Z-02A: DeviceNet branch cable.

11.3.3 Choice and Purpose of a DeviceNet Terminal Resistor

● Choice of a DeviceNet Terminal Resistor

A DeviceNet network requires two terminal resistors of 121 Ω connected at both ends of the trunk cable respectively.

The thick cable represents the trunk cable, the thin cable represents the branch cable and the yellow boxes at the two ends are terminal resistors in the following figure.

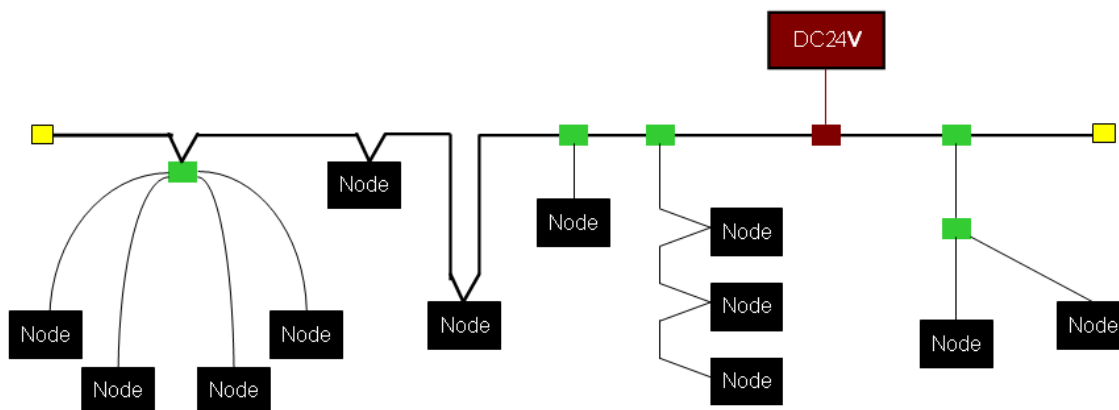

● Purpose of a DeviceNet Terminal Resistor

The terminal resistor is used for eliminating the signal reflection in the communication cable.

All signal transmission cables have the characteristic impedance. The characteristic impedance of Delta DeviceNet communication cable is about 121 Ω .

When being transmitted to the end of the communication cable, because the impedance of the end is different from the characteristic impedance, the signal will be reflected, which will interfere with the new signal and the signal wave form distortion will happen.

The phenomenon of the signal wave form distortion is not obvious in the short-distance transmission. But the wave form distortion will become severer in the increasingly long communication cable. Therefore, the two ends of the trunk cable must be installed with the terminal resistors respectively.

● Installation Position of Terminal Resistors

The DeviceNet communication cable consists of five wires such as red wire, blue wire, white wire, black wire and shielded wire as below.

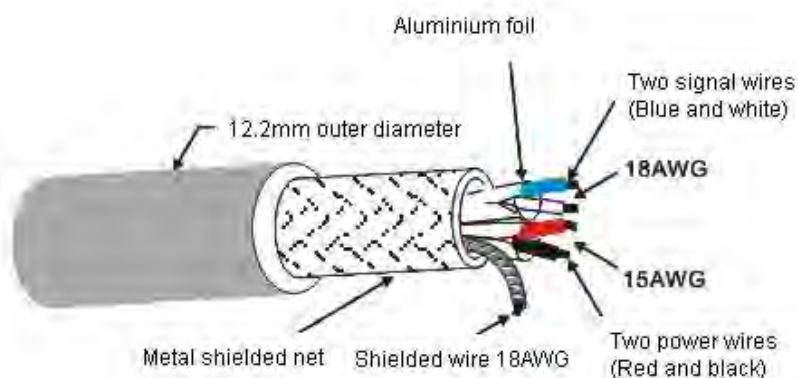

The terminal resistors must be installed to the two ends of the trunk cable only. Since the blue wire and white wire are for signal transmission, both of the terminal resistors must be installed between blue wire and white wire at the two ends of the main cable.

11.3.4 DeviceNet Network Supply Power

The network requires one or multiple supply powers to supply the power to each piece of network equipment via the bus cable.

11

Delta DeviceNet communication cable consists of five wires, among which the power cable and signal cable occupy two wires respectively and the one on the left is the shielded wire as the above figure shows.

The supply power for the bus is optional and could be a single supply power or multiple supply powers according to the actual demand.

- **Single Supply Power**

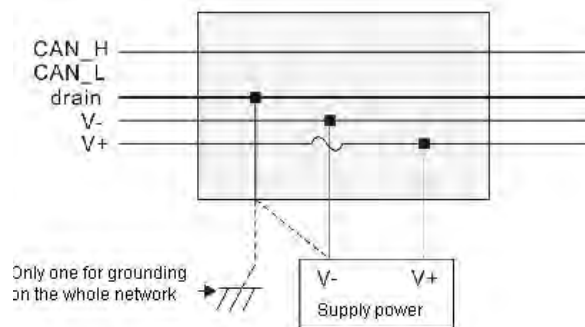

- **Multiple Supply Powers**

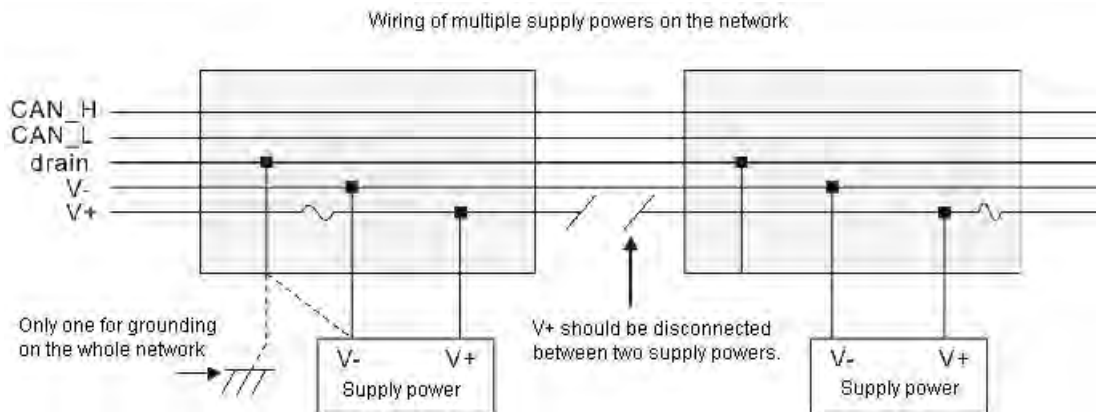

11.4 Master /Slave Mode

11.4.1 Introduction of Master/Slave Mode

AS01DNET-A can work as a DeviceNet master as well as slave with at most 4 AS01DNET modules connectable to the right side of AS PLC. Running on the right of AS-series PLC, AS01DNET-A with AS-series PLC together constitutes the DeviceNet master or slave. When working in Master/Slave mode, AS01DNET-A is required to switch the function toggle (RTU- Master/Slave) to Master/Slave mode and the DeviceNet Builder of version 2.04 and above is used for the setup.

For details about the setup, refer to Section 11.4.10.

- As a master, AS01DNET-A can provide the following function.
 - Supporting the Client function of Explicit message;
 - Supporting IO polling connection with slaves;
 - The network configuration software DeviceNet Builder provides graphic configuration interface.
 - Sending explicit messages to read and write the data in slave through the explicit message instruction DNETRW.
 - Automatically performing data exchange with the PLC module; users just need write a program for D register in the PLC without using FROM/TO instructions.
 - Offering 190 bytes of output data area and 190 bytes of input data area for exchanging data with the master.
- As a slave, AS01DNET-A can provide the following function.
 - Explicit message Server and Group 2 only server connection mode;
 - Polling connection;
 - Offering 200 bytes of input data area and 200 bytes of output data area for exchanging data with master;
 - Automatically exchanging data with the PLC. The user just need to write a program for D register in the PLC without using FROM/TO instruction.

11.4.1.1. Scan List, Input Table and Output Table

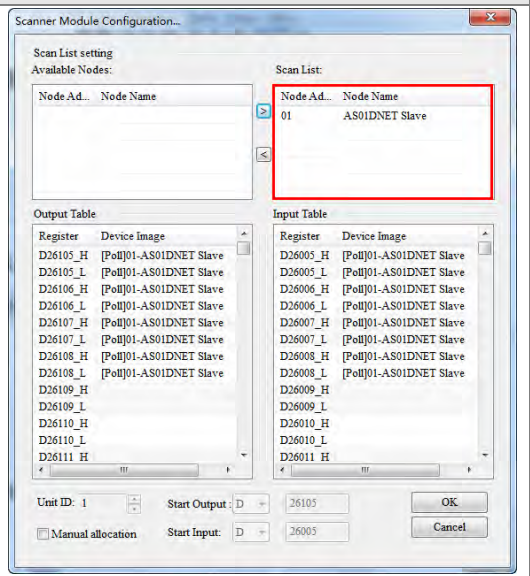
Item	Description	Figure
Scan List	<p>Before AS01DNET-A module works, the scan list must be configured through the configuration software. The scan list stores slave information including node address, I/O type, I/O size and etc. for data exchange. The scanner module manages the slaves in the scan list, makes a connection with slaves and exchange I/O data with them. For those slaves which have not been configured to the scan list, AS01DNET-A will not make a connection and I/O data exchange with them.</p>	

Input/output Table

The scanner module provides an input table of total size: 190 bytes and an output table of total size: 190 bytes for data exchange with slaves. When one slave is configured to the scan list, the configuration software will automatically assign corresponding size of I/O data exchange area to the slave. Input Table and Output Table are the interface for data exchange between the PLC of the master and slaves and show the mapping relationships between the D registers in the PLC of the master and the I/O data of slaves. After the configuration is finished, download the configuration data to the scanner module. Then the module will exchange I/O data with corresponding slaves according to the configuration. The data in the output table will be transmitted to slaves and the data returned from slaves will be filled in the input table.

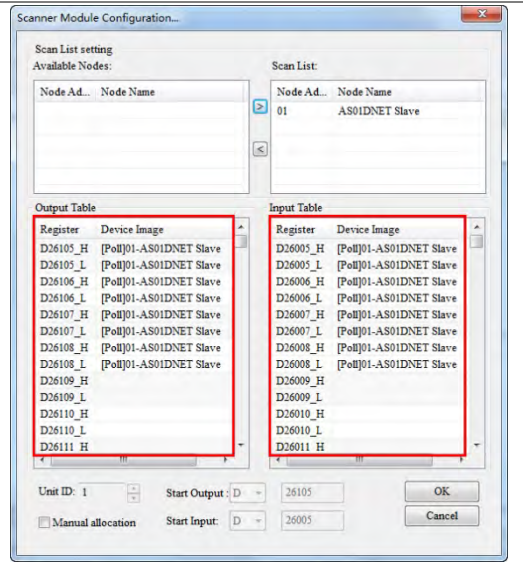

11.4.2 Installation

11.4.2.1. Connecting AS01DNET-A Module to AS series PLC

For the details on how AS01DNET-A (in Master/slave mode) is connected to AS series PLC, refer to Section 1.3.1 Installing a Module in AS Series Module Manual.

11.4.2.2. Connecting the DeviceNet Communication Connector

- Make sure that the color marks for the PINs of the DeviceNet connection port match the colors of the connection cables and the cable should be connected to the right PIN.
- Delta's power module is recommended as the power module in the communication.

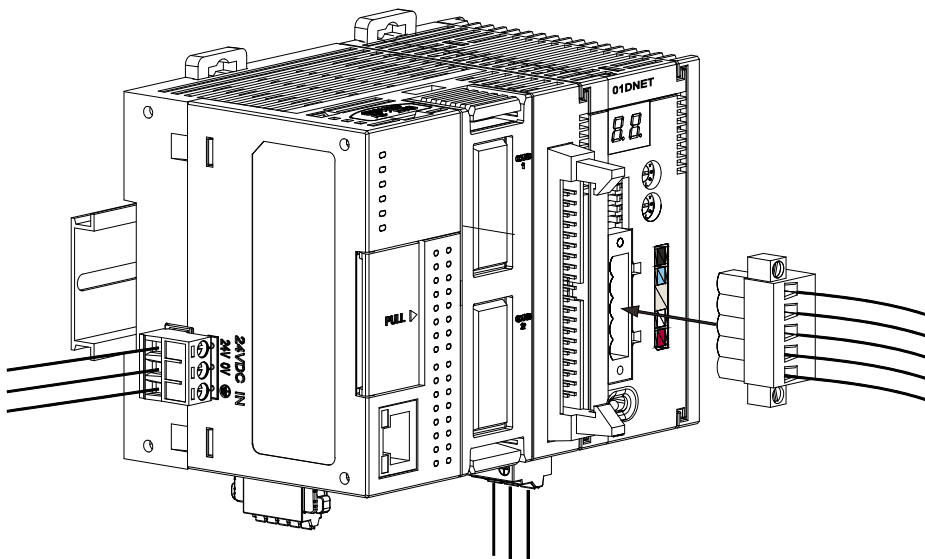

11.4.3 IO Mapping for AS01DNET in AS PLC

11.4.3.1. Data Mapping between Modules and AS PLC

Up to four AS01DNET modules can be connected to the right side of AS PLC at most. After AS01DNET modules and PLC are connected, PLC will assign data mapping areas to each module.

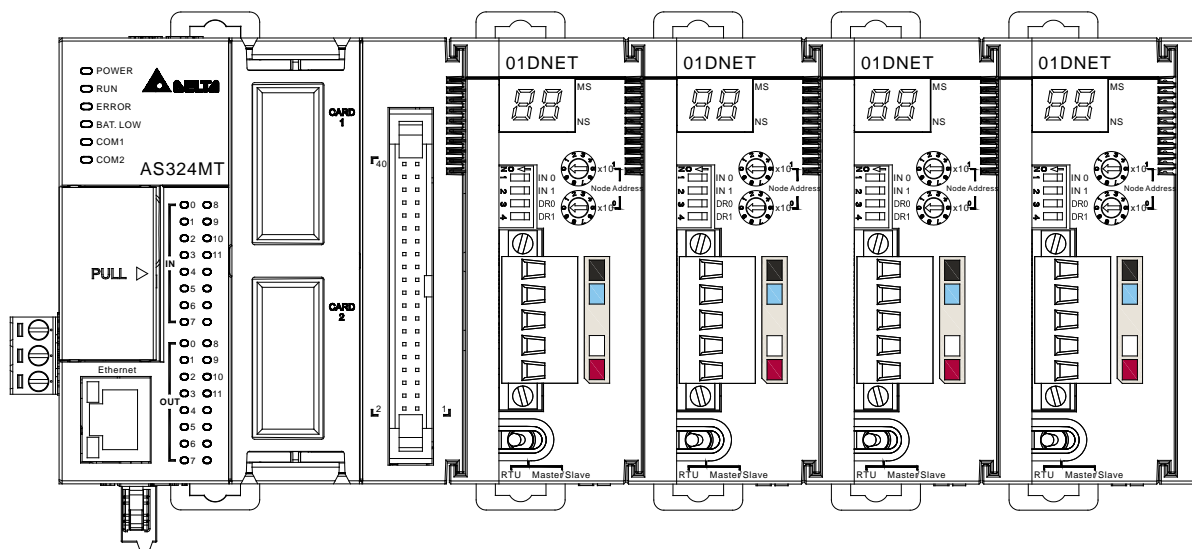

AS01DNET modules are connected to the right of the PLC. The position of the first module on the right of AS PLC is 1, the second module is 2, the third module is 3 and the fourth module is 4. The position is only defined for network modules such as AS01DNET and AS00SCM, instead of digital modules, analog modules, temperature modules, and weight-measurement modules. The positions of AS01DNET modules on the right of the PLC are shown in the following table where there are two arrangement ways of module connections.

Example 1		Example 2	
Position of AS01DNET on the right of the PLC	Arrangement order of AS PLC and modules on the right of the PLC	Position of AS01DNET on the right of the PLC	Arrangement order of AS PLC and modules on the right of the PLC
	AS PLC		AS PLC
1	AS01DNET	1	AS01DNET
	AS04AD		AS04AD
2	AS01DNET		AS00SCM
		3	AS01DNET

When AS01DNET is at different positions of the right of the PLC, the input and output mapping areas for the AS01DNET module in AS PLC are listed in the following table.

Position of AS01DNET on the right of the PLC	Output mapping area	Input mapping area
1	D26100 – D26199	D26000 – D26099
2	D26500 – D26599	D26400 – D26499
3	D26900 – D26999	D26800 – D26899
4	D27300 – D27399	D27200 – D27299

11.4.3.2. Tables of Input Mapping and Output Mapping areas

- When AS01DNET works in master mode, the input and output mapping areas for AS01DNET at different positions of the right of AS PLC are listed in the following table.

Position of AS01DNET on the right of the PLC	Output mapping area (for sending data to the slave)			Input mapping area (for receiving data from the slave)		
	D register	Mapping area	Data size	D register	Mapping area	Data size
1	D26100~D26103	Bit-strobe command area	4 words	D26000~D26003	Scan-list node status indication area	4 words
	D26104	Reserved	1 word	D26004	Module status indication area	1 word
	D26105~D26199	DeviceNet output data area	95 words	D26005~D26099	DeviceNet input data area	95 words
2	D26500~D26503	Bit-strobe command area	4 words	D26400~D26403	Scan-list node status indication area	4 words
	D26504	Reserved	1 word	D26404	Module status indication area	1 word
	D26505~D26599	DeviceNet output data area	95 words	D26405~D26499	DeviceNet input data area	95 words
3	D26900~D26903	Bit-strobe command area	4 words	D26800~D26803	Scan-list node status indication area	4 words
	D26904	Reserved	1 word	D26804	Module status indication area	1 word
	D26905~D26999	DeviceNet output data area	95 words	D26805~D26899	DeviceNet input data area	95 words
4	D27300~D27303	Bit-strobe command area	4 words	D27200~D27203	Scan-list node status indication area	4 words
	D27304	Reserved	1 word	D27204	Module status indication area	1 word
	D27305~D27399	DeviceNet	95	D27205~D27299	DeviceNet input	95

Position of AS01DNET on the right of the PLC	Output mapping area (for sending data to the slave)			Input mapping area (for receiving data from the slave)		
	D register	Mapping area	Data size	D register	Mapping area	Data size
		output data area	words		data area	words

Note: See Section 11.4.5 for further explanation of scan-list node status indication areas and module status indication areas. The input and output mentioned here are defined in the perspective of the master of the entire fieldbus system.

- When AS01DNET works in slave mode, the input and output mapping areas for AS01DNET at different positions of the right of AS PLC are listed in the following table.

Position of AS01DNET on the right of the PLC	Area for sending data to the master		Area for receiving data from the master	
	D register	Data length	D register	Data length
1	D26100~D26199	100 words	D26000~D26099	100 words
2	D26500 – D26599	100 words	D26400 – D26499	100 words
3	D26900 – D26999	100 words	D26800 – D26899	100 words
4	D27300 – D27399	100 words	D27200 – D27299	100 words

11.4.4 Bit-strobe Command

11.4.4.1. Bit-strobe Work Principle

Bit strobe is one of the standard DeviceNet I/O transmission methods. The command length is fixed to 8 bytes, i.e. 64 bits. (Maximum 64 stations exist in a DeviceNet network.) One bit corresponds to one node. The following table takes the first AS01DNET on the right of AS PLC for example.

Bit-strobe register	Corresponding network node					
	b15	b14	b13	b1	b0
D26100	Node 15	Node 14	Node 13	Node 1	Node 0
D26101	Node 31	Node 30	Node 29	Node 17	Node 16
D26102	Node 47	Node 46	Node 45	Node 33	Node 32
D26103	Node 63	Node 62	Node 61	Node 49	Node 48

When the value of bit0 of D26100 is 0, node 0 is selected and need return data to the master.

When the values of bit0 and bit1 of D26100 are both 0, node 0 and node 1 are selected and they need return data to the master.

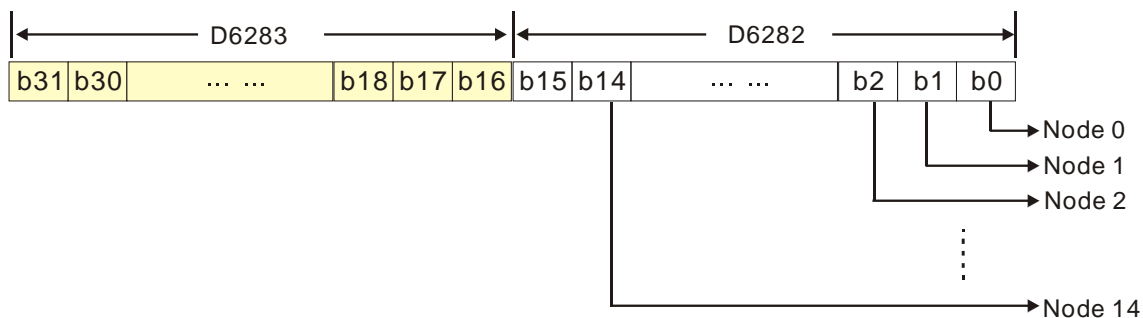

In the bit-strobe method, the master does not send control data to the slave node. However, the slave node need return I/O data to the master if the corresponding bit is set to 0. If the corresponding bit is set to 1, the slave node does not need to return I/O data to the master.

11.4.5 Network Node Status Display

11.4.5.1. Scan-List Node Status Indication

The following table takes the first AS01DNET on the right of AS PLC for example. AS01DNET master can monitor whether the configured slave is online or not in real time and have the status of the configured slave mapped to one bit. Users can get the status of network nodes by monitoring the contents in D26000~D26003. The corresponding relationships between devices in the PLC and network nodes are shown in the following table. If the node in Scan List is normal, the corresponding bit is OFF. If the node in Scan List is abnormal, the corresponding bit is ON.

Register in the PLC	Corresponding network node					
	b15	b14	b13	b1	b0
D26000	Node15	Node 14	Node 13	Node 1	Node 0
D26001	Node 31	Node 30	Node 29	Node 17	Node 16
D26002	Node 47	Node 46	Node 45	Node 33	Node 32
D26003	Node 63	Node 62	Node 61	Node 49	Node 48

11.4.5.2. Module Status Indication

The following table takes the first AS01DNET on the right of AS PLC for example. Users can get the status of the network node by monitoring the content in D26004. When the module works normally, the content in D26004 is 0. When the module is initializing, the content in the high byte of D26004 is 1 and the content in the low byte is 0. When an error occurs in the module, the content in the high byte of D26004 is 2 and the content in the low byte is an error code. For details on error codes, see Digital Displayer.

Register in the PLC	Description															
	b15	b14	b13	b12	b11	b10	b9	b8	b7	b6	b5	b4	b3	b2	b1	b0
D26004	Module status (0: Normal, 1: Initializing, 2: error)								Error code in the module							

11.4.6 Setting the Time for Data Exchange between Master and Slaves

When AS01DNET works in master mode, the period of time for a data exchange between master and all slaves need be set. Master and all slaves will periodically perform the data exchange based on the set time. See the following explanation for details. Click menu **Network >> Scanner Setting** on the DeviceNet Builder software page. The **Scanner Setting** window appears as below.

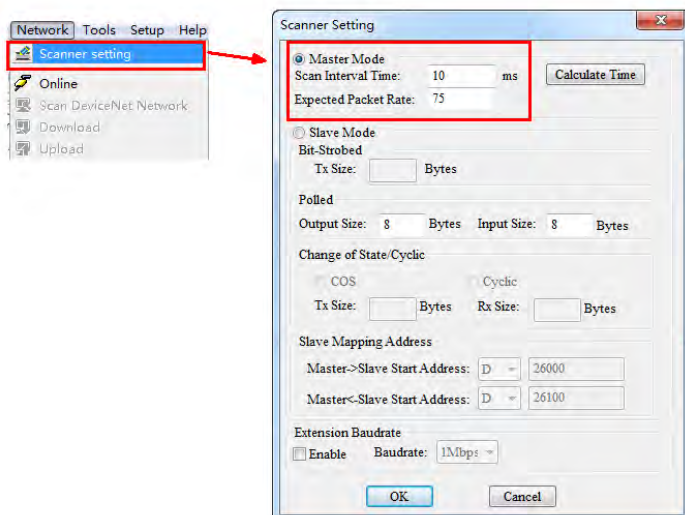

The explanation of **Scan Interval Time** and **Expected Packet Rate** is shown in the following table.

Scan Interval Time	The period of time needed for a data exchange between master and all slaves. Master and all slaves will periodically exchange data based on the set interval time.
Expected Packet Rate (EPR)	Sets the timeout time for connection of master and slaves. The calculation method: $4 \times \text{EPR}$ with the unit: ms. The default EPR is 75. The EPR for the connection of master and slaves is $4 \times 75 = 300\text{ms}$. The value indicates that the IO data exchange should be achieved once at least within 300 ms. Otherwise, the connection will fail due to communication timeout and then the connection will have to be re-made so that the IO data exchange can proceed.

11

Since most DeviceNet slaves only support polled IO data exchange, the EPR value is related to the value of **Scan Interval Time**. Make sure that the actual setting must meet the following condition.

$$\text{Scan Interval Time} < (4 \times \text{EPR})$$

We suggest users refer to the following condition while setting the value of **Scan Interval Time**.

$$\text{Scan Interval Time} < (4 \times \text{EPR}) / 5$$

Click the **Calculate Time** button. The **Calculate Scan Interval Time** dialog box comes out. Clicking the **Calculate** button, the values of **Total input size**, **Total output size** and **Scan Interval Time** are calculated. The value of **Scan Interval Time** is a value in theory. We suggest users should set the scan interval time to a value slightly greater than the actually calculated time. The scan interval time calculated here will not be filled in the **Scan Interval Time** box automatically and so users need enter the value manually.

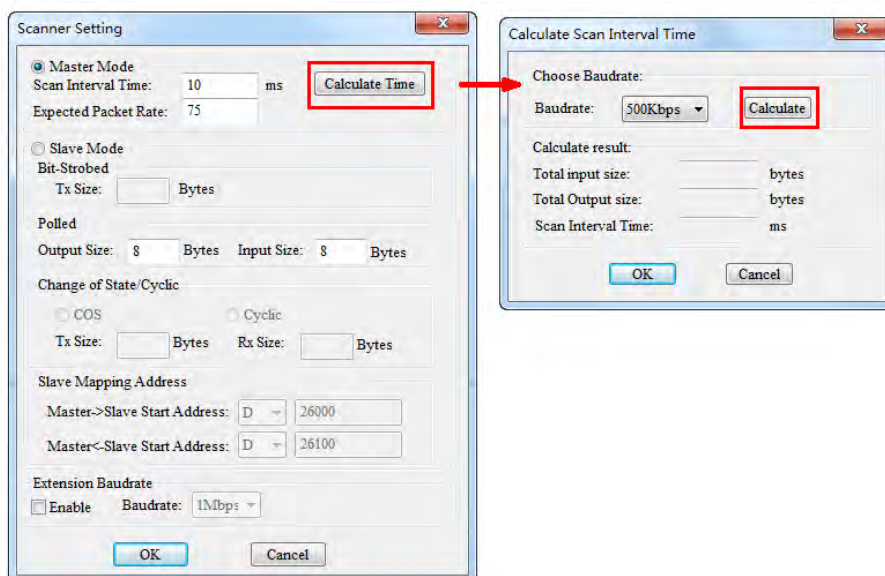

11.4.7 Application Example

To explain how to configure a DeviceNet network through an application example

Control requirement: AS PLC remotely monitors D26105~D26108 and D26005~D26008 in AS module through DeviceNet network to achieve the data exchange as AS01DNET-A works as master and slave respectively.

11.4.7.2. Using DeviceNet Builder to Configure a DeviceNet Network

- **Configuring DeviceNet slave**

1. Set the driver for the connection of AS PLC and PC. Clicking **Add**, the **Driver Properties** dialog box appears. Select the connection type for AS PLC and PC in the **Type** field. In this example, select Ethernet as the connection type. Click **Search** to search the PLC and then click **OK** after searching is finished.

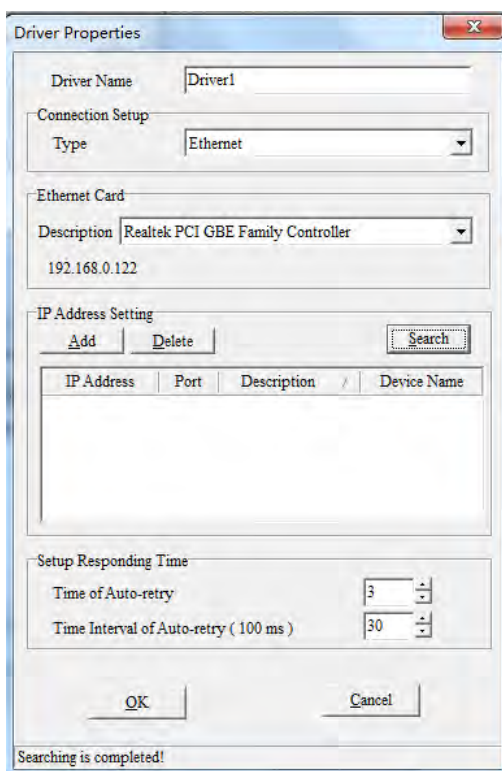
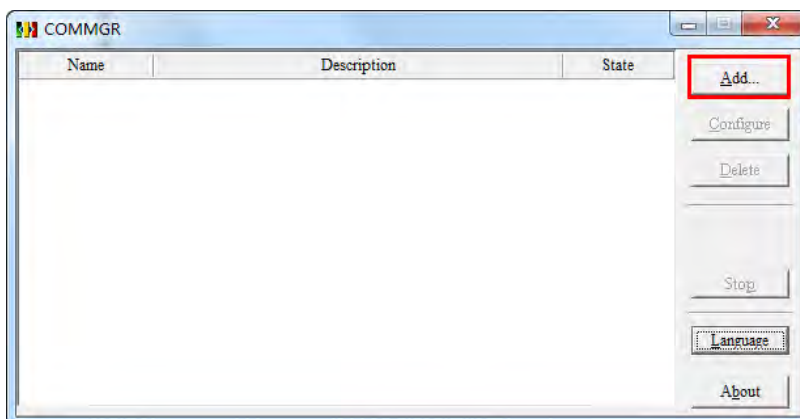
11

11

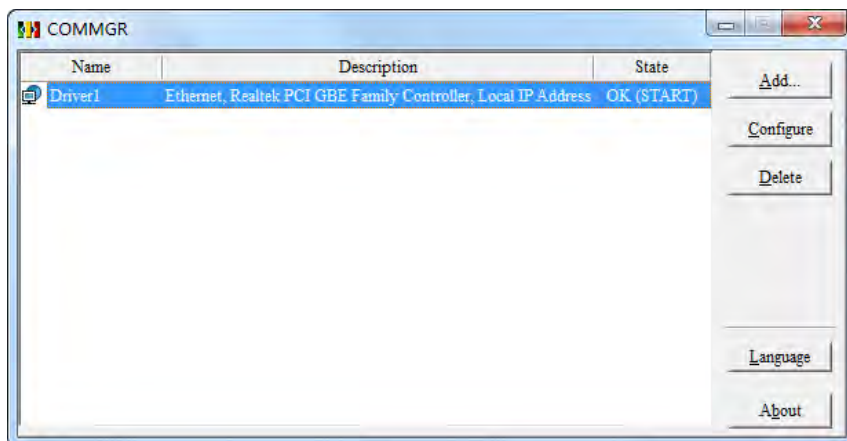

2. Opening the DeviceNet Builder software, the following window appears.

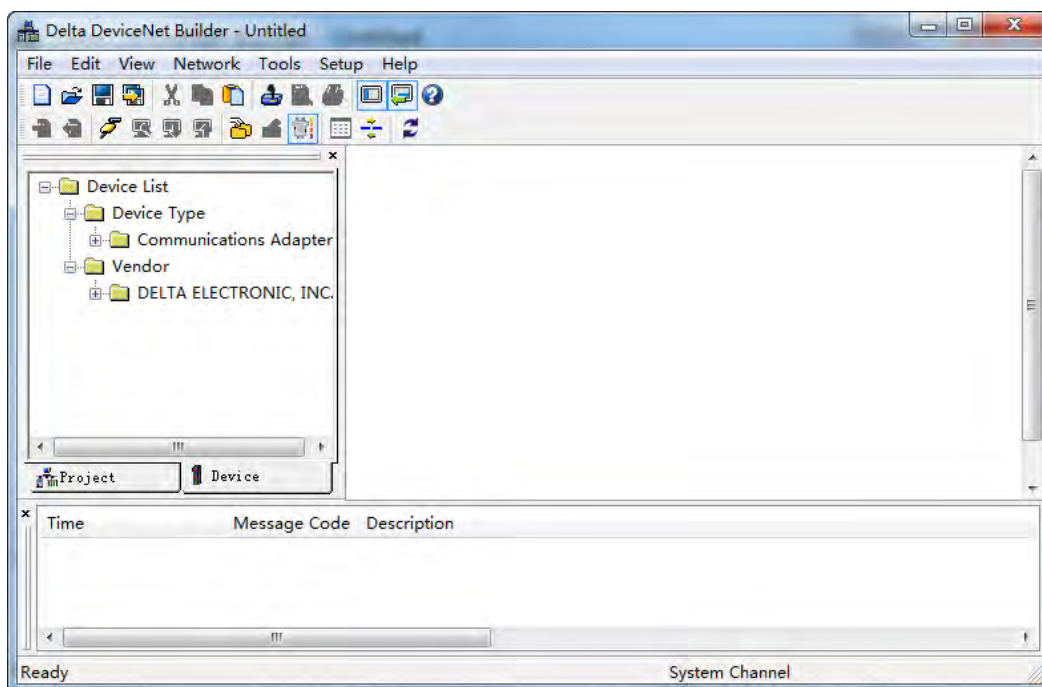

3. Selecting **Setup>> Communication Setting**, the following dialog box appears. Select the driver for connection of AS PLC and PC as below. Click **OK** to finish the selection of Driver.

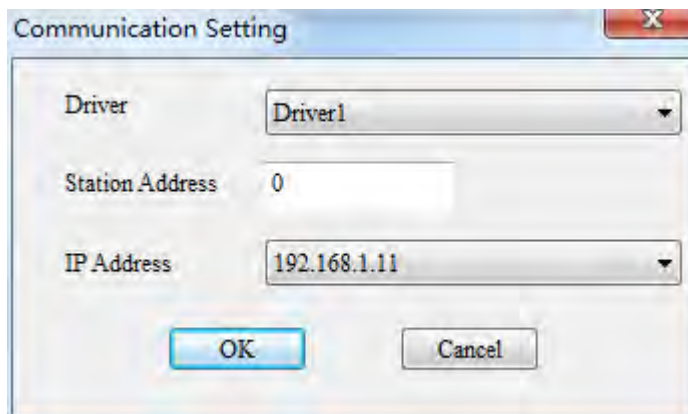

4. Click **Network >> Online** to scan the connected master.

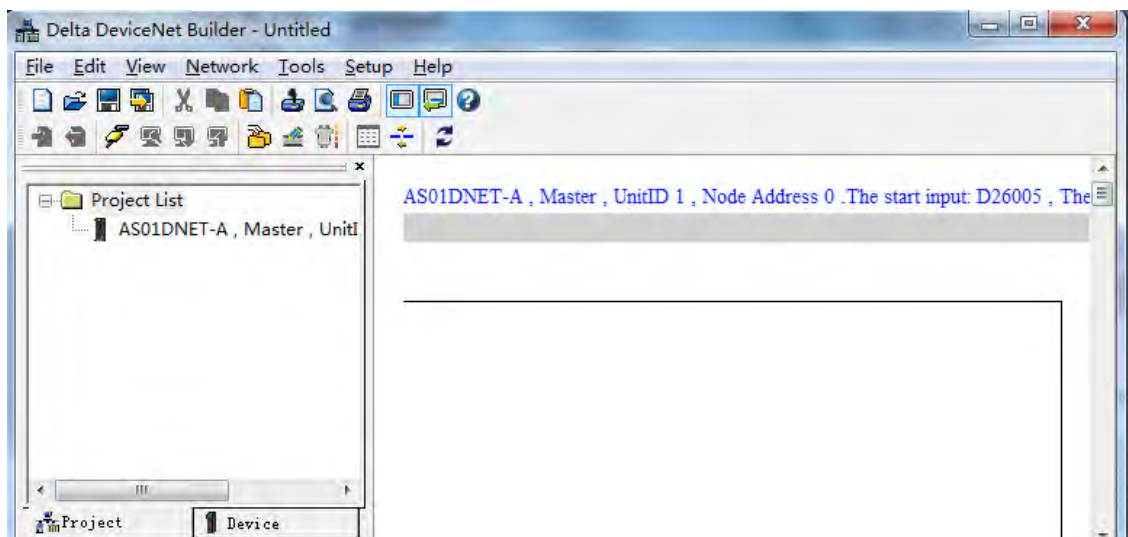

5. Click **Network>> Scan DeviceNet Network**.

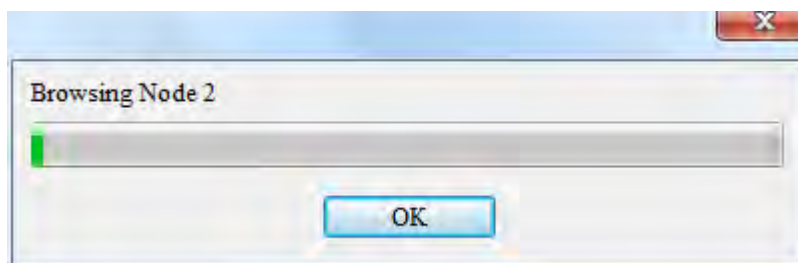

- After scanning is finished, all node icons and device names which have been scanned in the network will appear on the following interface. The node address of AS01DNET-A is 00 in this example.

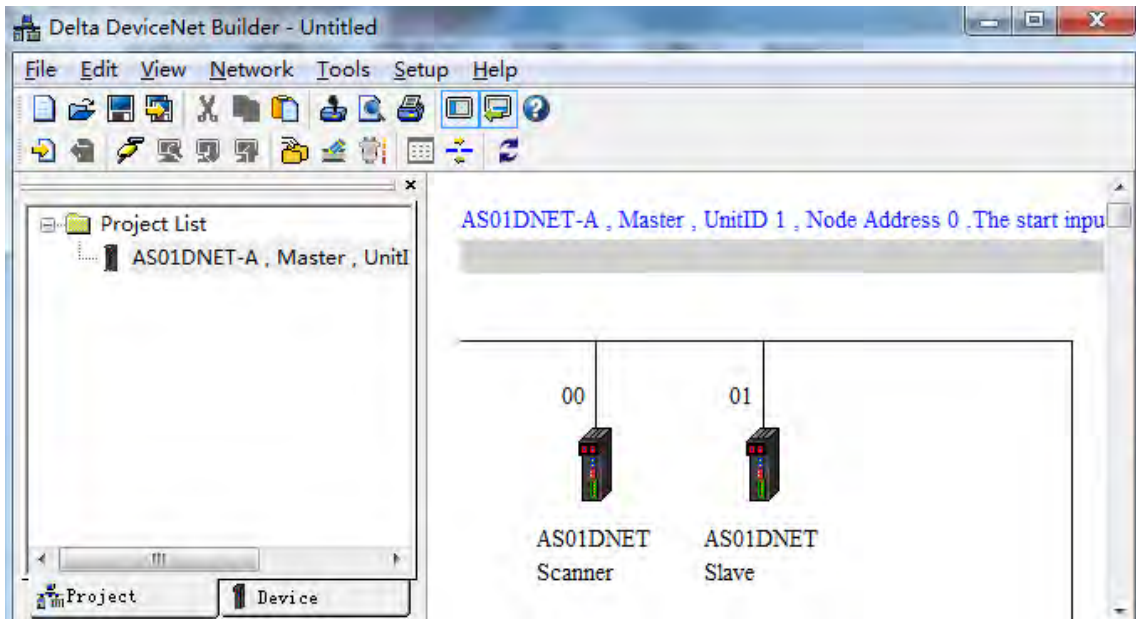

- Double click the icon of AS01DNET Slave. Then the **Node Configuration...** dialogue box appears. Input Size and Output Size are both set to 8 bytes. Click OK to finish the setting.

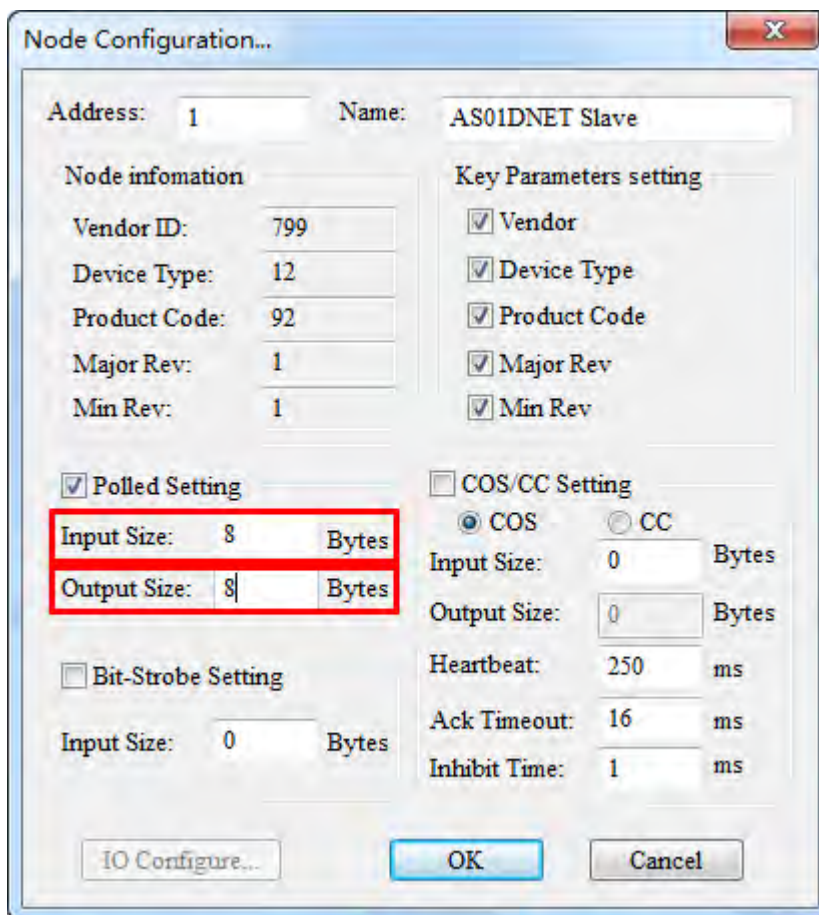

8. Right click the icon of AS01DNET Slave and click **Parameter Edit...** on the drop-down menu. The **Parameters Edit...** dialog box appears and **Polled Input Length** and **Polled Output Length** are both set to 8 bytes as shown in the following red box. Then click **Write** button. Click **OK** after writing is finished. Afterwards, repower AS01DNETSlave.

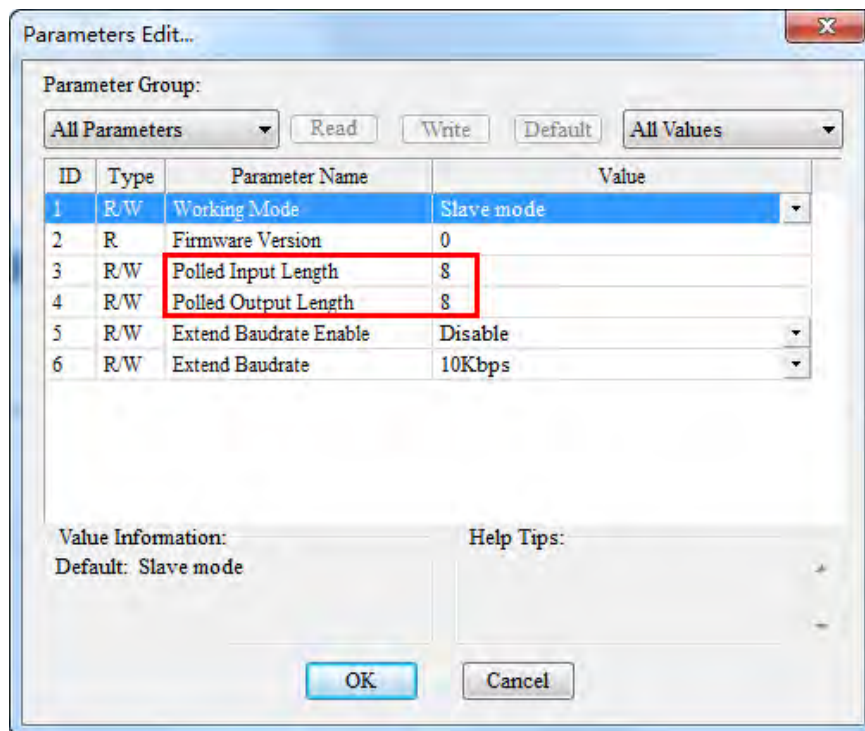
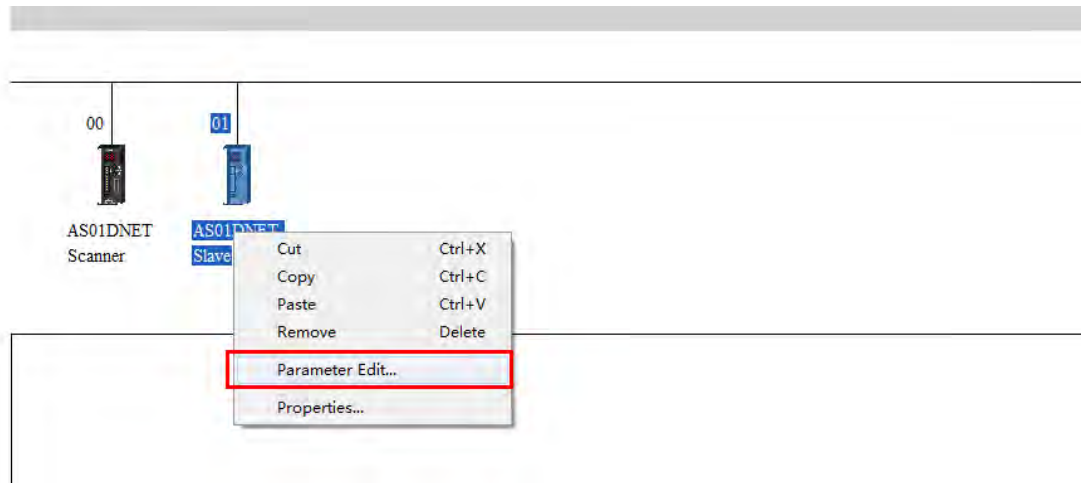

● **Configuring AS01DNET-A**

1. Double click the icon of AS01DNET Scanner (node 0). The **Scanner Module Configuration...** dialog box appears. The left list shows the current available node AS01DNET Slave and the right Scan List is empty as below.

11

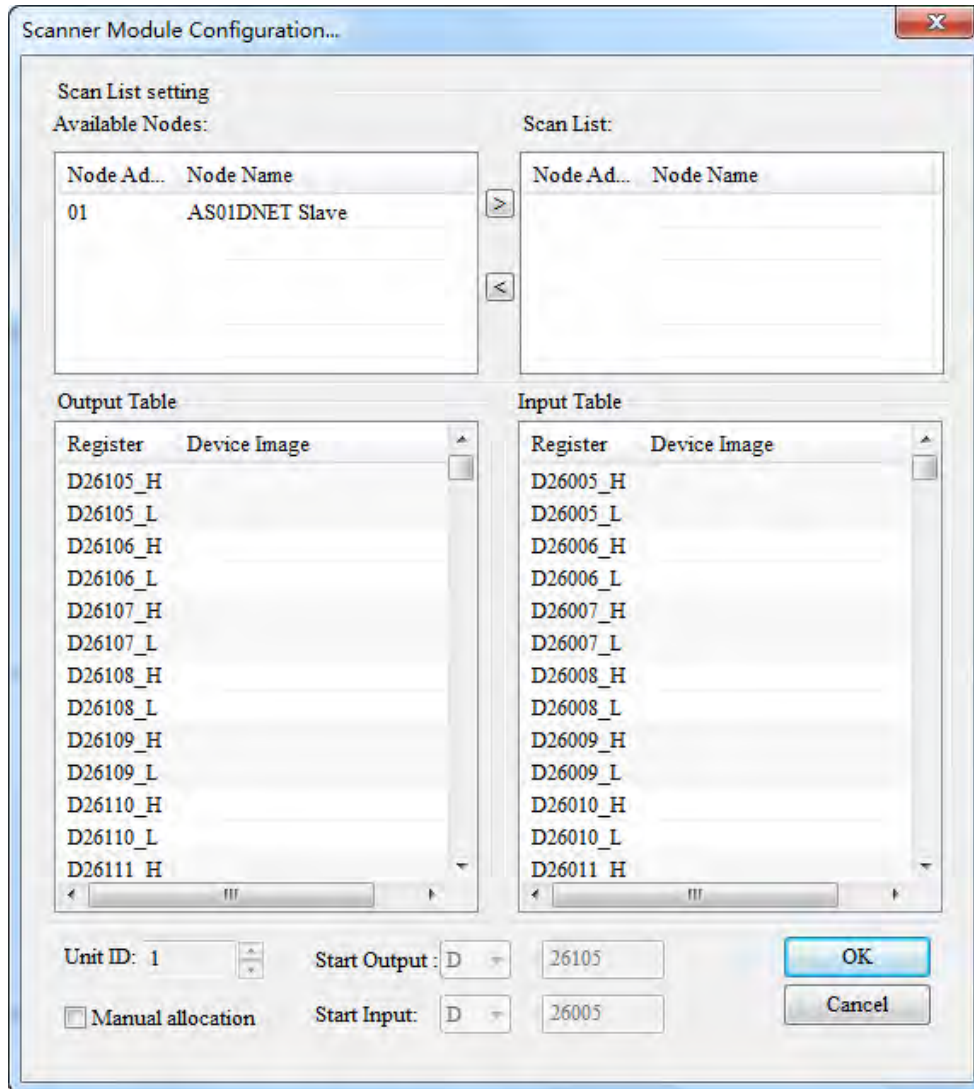

2. Move the DeviceNet slaves from the left list to Scan List of the right side. Follows the steps: Select one DeviceNet slave node and then click . Then the DeviceNet slave nodes are moved to the Scan List one by one.

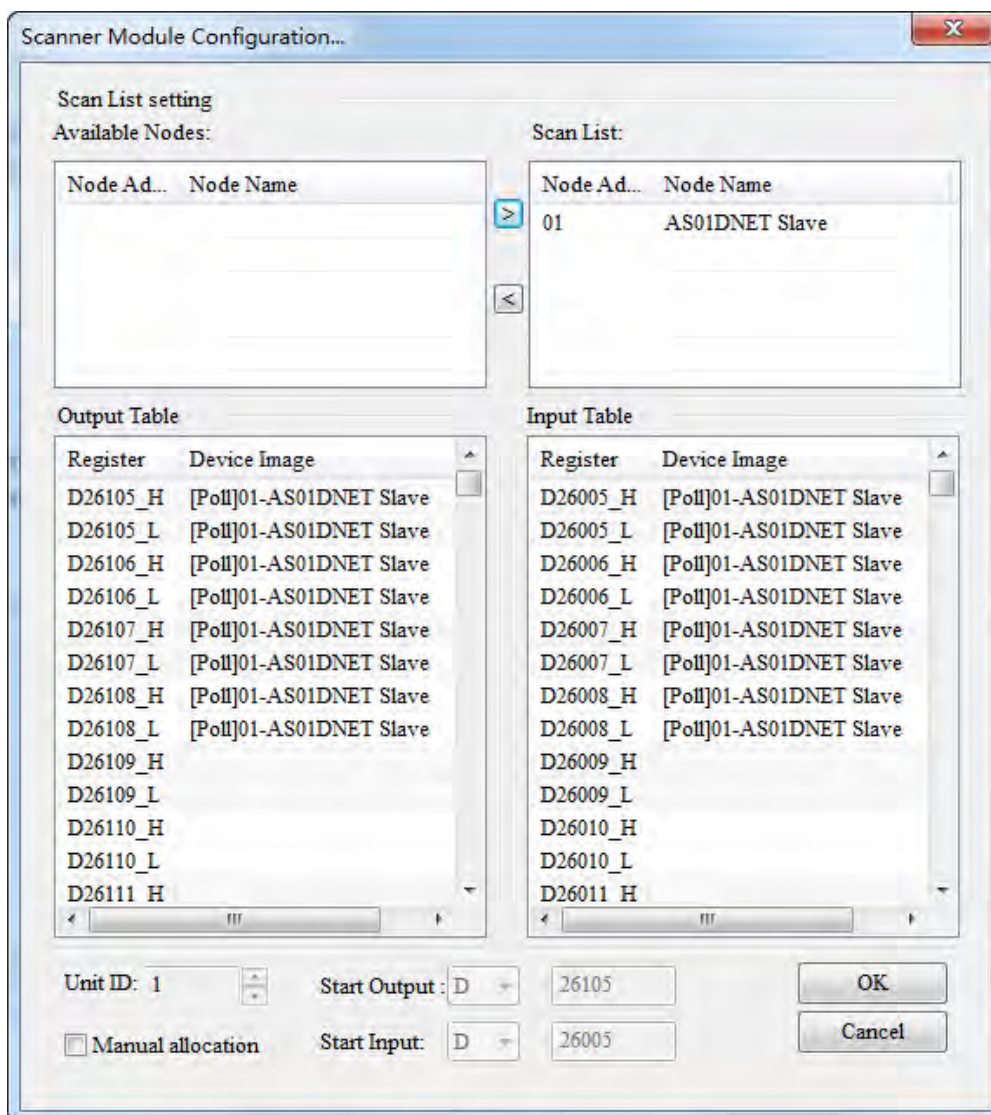

3. Click **OK** to finish the configuration above. Then download the configuration data to AS01DNET-A. During the download, the **Warning** dialog box will pop out if AS PLC is in RUN mode. Click **OK** to continue the download.

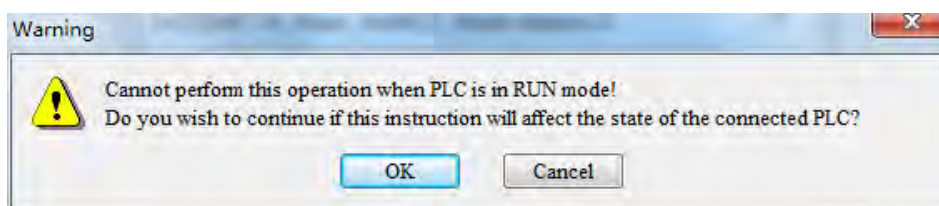

- Configure the DeviceNet network by following the steps above. The IO data mappings between AS01DNET-A and the slave are shown in the following tables.

■ AS01DNET-A → Slave

AS PLC	AS01DNET(Master)	AS01DNET(Slave)	AS PLC
D26105	⇒	⇒	D26000
D26106			D26001
D26107			D26002
D26108			D26003

■ Slave → AS01DNET-A

AS PLC	AS01DNET(Master)	AS01DNET(Slave)	AS PLC
D26005	⇐	⇐	D26100
D26006			D26101
D26007			D26102
D26008			D26103

- Saving configuration data

Select File>> Save to save current network configuration.

11.4.7.3. DeviceNet Network Control

This section describes how to write a ladder program to achieve the control requirement of the DeviceNet network.

- PLC Programs

- The program in the PLC connecting AS01DNET slave:



Program Explanation:

The contents in D26000~D26003 are the data received from the master and the contents in D26100~D26103 are the data transmitted to the master. SM400 is a normally open contact. The program above can make the contents in D26000~D26003 move to D26100~D26103.

- The program in the PLC connecting AS01DNET master:



**Program Explanation:**

1. When M0 changes to ON, the value 16#5555 is written to D26105~D26108 in AS PLC. The data are transmitted to the slave cyclically via DeviceNet Bus.
2. The contents in D26005~D26008 are the data which the master receives from the slave via DeviceNet Bus. When M1 changes to ON, the data in D26005~D26008 are moved to D0, D1, D2 and D3.

11.4.8 Sending Explicit Message through Ladder Diagram

AS01DNET-A supports the sending of explicit messages via DNETRW instruction.

11.4.8.1. Principle of Explicit Message Transmission

1. AS PLC transmits the explicit request message to AS01DNET-A master according to the user program.
2. AS01DNET-A transmits the explicit request message to the slave according to the user program.
3. The slave sends back the response message to AS01DNET-A master after handling data.
4. AS PLC gets back the response message from AS01DNET-A master. Then the explicit message transmission of this time is finished.

11.4.8.2. Explicit Message Transmission Instruction DNETRW

- DNETRW instruction:

API	Instruction code					Operand						Function				
1818	DNETRW					S ₁ · S ₂ · S ₃ · S ₄ · S ₅ · S ₆ · S ₇ · S ₈ · S ₉ · S ₁₀ · D ₁ · D ₂ · D ₃ · D ₄ · D ₅						Read and write DeviceNet communication data				
Device	X	Y	M	S	T	C	HC	D	FR	SM	SR	E	K	16#	"\$"	F
S ₁								●	●				○	○		
S ₂								●	●				○	○		
S ₃								●	●				○	○		
S ₄								●	●				○	○		
S ₅								●	●				○	○		
S ₆								●	●				○	○		
S ₇								●	●				○	○		
S ₈								●								
S ₉								●	●				○	○		
S ₁₀								●	●				○	○		
D ₁		●	●	●												
D ₂		●	●	●												
D ₃								●								
D ₄								●								
D ₅								●								

Data type	BOOL	WORD	DWORD	LWORD	UINT	INT	DINT	LINT	REAL	LREAL	TMR	CNT	STRING
S ₁		●			●	●							
S ₂		●			●	●							
S ₃		●			●	●							
S ₄		●			●	●							
S ₅		●			●	●							
S ₆		●			●	●							
S ₇		●			●	●							
S ₈		●			●	●							
S ₉		●			●	●							
S ₁₀		●			●	●							
D ₁	●												
D ₂	●												
D ₃		●			●	●							
D ₄		●			●	●							
D ₅		●			●	●							

Pulse Instruction	16-bit instruction	32-bit instruction
-	AS	AS

- **Symbol:**

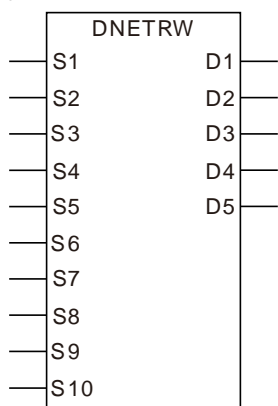

S1	The sequence number of the DeviceNet communication module
S2	DeviceNet node address (MAC ID)
S3	Service Code
S4	Class ID
S5	Instance ID
S6	Attribute ID
S7	Written-data size
S8	The start device where written data are stored
S9	Communication timeout time
S10	Times of re-transmission
D1	Completion flag
D2	Error flag
D3	Error code
D4	Read-data size
D5	The start device where read data are stored

- **Explanation:**

- **S1** is the sequence number of the module on the right of the PLC. The number of the first module is 1; the second module is 2 and so on. Any type of module need be numbered within the range of 1~32. If the number is out of the range, the instruction will take the minimum (1) or maximum (32) for operation.
- **S2** is a DeviceNet node address within the range of 0~63. Users can specify the node address of a slave which the master is to read and write. It also can be the node address of the master, which means to read and write the data in the master.

- S3 is DeviceNet service code:

Service code	Explanation
0x01	Get all attributes (Get_Attribute_All)
0x02	Set all attributes (Set_Attribute_All)
0x0E	Get one single attribute (Get_Attribute_Single)
0x10	Set one single attribute (Set_Attribute_Single)

- S4, S5 and S6 represent Class ID, Instance ID and Attribute ID respectively.
- S7 is the written-data size with the unit: Byte.
- S8 is the start device where written data are stored. The data are arranged in the order from low byte to high byte.
- S9 is the communication timeout time within the range: 1~100 and with the unit: 0.1 second.
- S10 is the times of re-transmission within the range: 0~3. When communication timeout occurs, the communication will be resent
- D3 represents the error codes to read and write.

Error Code		Explanation
Code 1 (High Byte)	Code 2 (Low Byte)	
XX	FF	Not conform to the DeviceNet standard
20	01	The target slave does not exist.
20	02	Unable to make the connection with the slave
20	03	Sending explicit message failed.
16	00	Explicit message response timeout.

- D4 is the read-data size with the unit: Byte.
- D5 is the start device where read data are stored. The data are arranged in the order from low byte to high byte.
- D1 and D2 are communication completion flag and error flag respectively.

● Application Example 1

Control requirement: when M0=ON, read the data of class1>>instance1>>attribute1 of the DeviceNet function card CMC-DN01.

■ Connection Figure

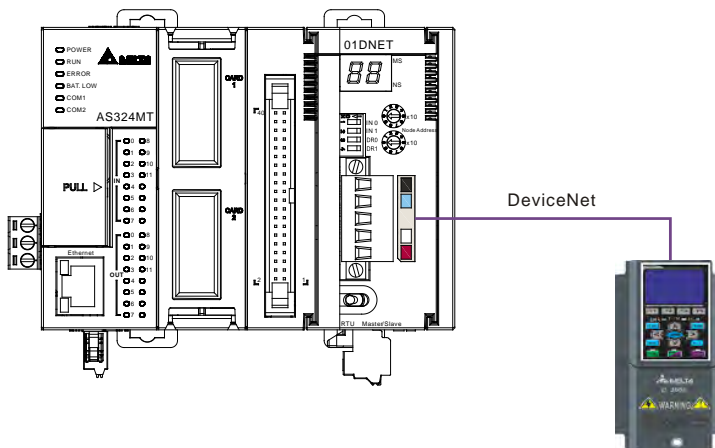

■ Parameters Setting and Device Explanation

➤ Setup for AS01DNET-A

Parameter	Setting value	Description
Node ID	00	Set the node ID of AS01DNET-A to 00.
Baud rate	500 kbps	Set the baud rate of AS01DNET-A to 500 kbps.

➤ Setup for VFD-C2000

Parameter	Setting value	Description
00-20	08	Frequency command source
00-21	05	Operation command source
09-30	0	Communication decoding method
09-70	01	Node ID of AC motor drive
09-71	02	Baud rate: 500Kbps

■ PLC Program

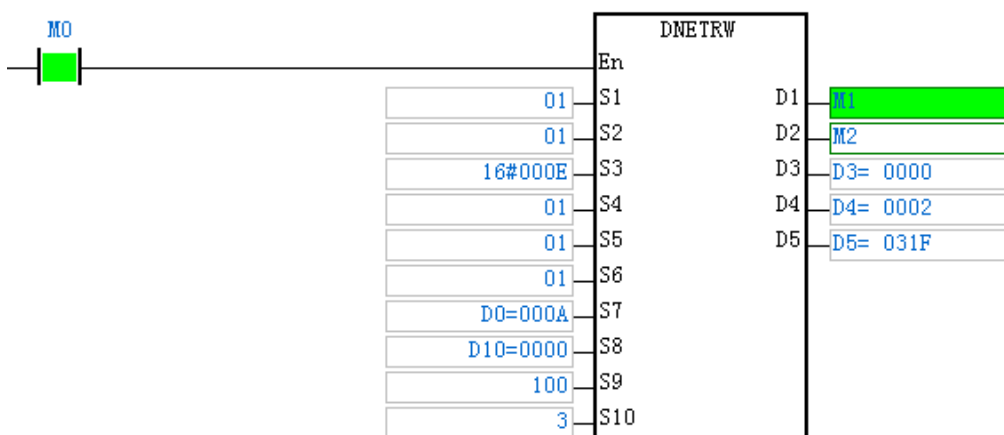

- S1: The number of the module sending DeviceNet communication. The first one of the right side is 01.
- S2 : DeviceNet node ID (MAC ID); Node ID of VFD-C2000: 01.
- S3 : Service code; 0X0E: read one single attribute content.
- S4 : Class ID; Class ID of CMC-DN01: 01;
- S5 : Instance ID; Instance ID of CMC-DN01: 01;
- S6 : Attribute ID; Attribute ID of CMC-DN01: 01 ;
- S7 : Write data size. When DNETRW instruction is used to read data, the value in S7 can be set to any data.
- S8 : The start device where the written data are stored. When DNETRW instruction is used to read data, the value in S8 can be set to any data.
- S9 : Communication timeout time
- S10 :Times of re-transmission. Times of re-sending communication when communication timeout occurs.
- D1 : Completion flag

- D2 : Error flag
- D3 : Error code
- D4 : Read data size
- D5: The start device where data are read.

■ Program Explanation

- When M0 changes to ON, execute the explicit message instruction DNETRW to read Class 1 >> Instance 1 >> Attribute 1 of the target equipment with node ID: 01. If the explicit message communication succeeds, the completion flag M1 changes to ON.
- When M0 changes to ON, AS01DNET-A sends out the request message only once. If the request message is to be resent, the instruction DNETRW need be re-triggered.
- If the data reading succeeds, the content of Class 1>> Instance1 >> Attribute 1 of CMC-DN01 will be stored in D5. In this example, the content in D5 should be 031FHex.

● Application Example 2

Control requirement: When M1 changes to ON, set the content of Class ID: 0x05>> Instance 1>>Attribute ID: 09 of CMC-DN01 to 000AHex.

■ Connection figure

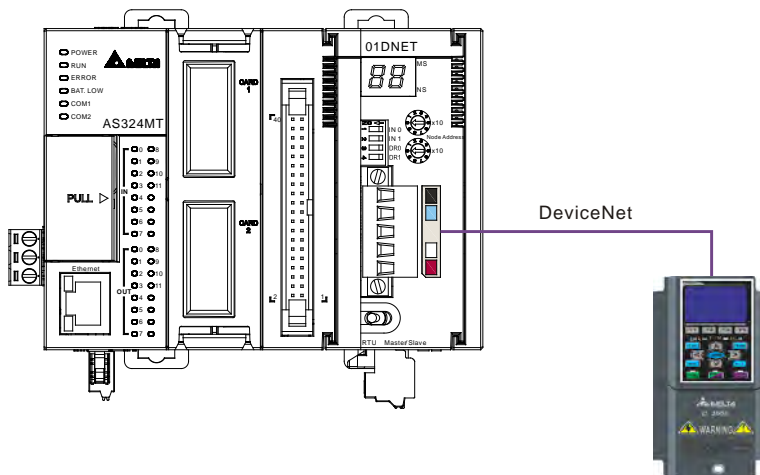

■ Parameters Setting and Device Explanation

➤ Setup for AS01DNET-A

Parameter	Setting value	Description
Node ID	00	Set the node ID of AS01DNET-A to 00.
Baud rate	500 kbps	Set the baud rate of AS01DNET-A to 500 kbps.

➤ Setup for VFD-C2000

Parameter	Setting value	Description
00-20	08	Frequency command source
00-21	05	Operation command source
09-30	0	Communication decoding method
09-70	01	Node ID of AC motor drive
09-71	02	Baud rate: 500Kbps

■ PLC Program

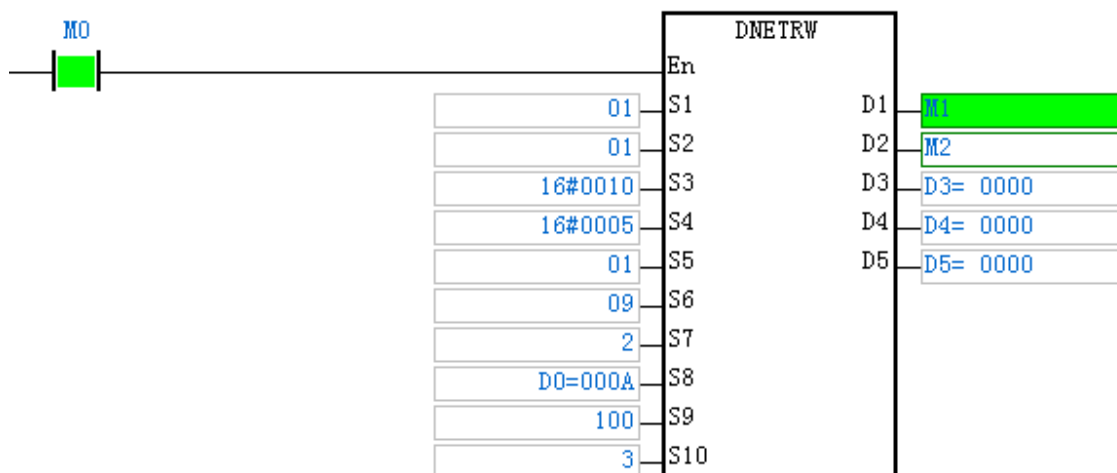

- S1 : The number of the module sending DeviceNet communication. The first one of the right side is 01.
- S2 : DeviceNet node ID (MAC ID); Node ID of VFD-C2000: 00.
- S3 : Service code; 0X10: read one single attribute content.
- S4 : Class ID; Class ID of CMC-DN01: 05.
- S5 : Instance ID; Instance ID of CMC-DN01: 01.
- S6 : Attribute ID; Attribute ID of CMC-DN01: 09.
- S7 : Write data size with the unit: Byte. The written-data size is 2 in this example.
- S8 : The start device where the written data are stored.
- S9 : Communication timeout time.
- S10 :Times of re-transmission. Times of re-sending communication when communication timeout occurs.
- D1 : Completion flag.
- D2 : Error flag.
- D3 : Error code.
- D4 : Read data size. When DNETRW instruction is used to write data, the value in D4 can be set to any data.
- D5 : The start device where read data are stored. When DNETRW instruction is used to write data, the value in D5 can be set to any data.

■ Program Explanation

- When M0 changes to ON, AS01DNET-A sends the request message and 000AHex is written to Class ID: 05>> Instance 1 >> Attribute ID: 09 of the target equipment with node ID: 01. If explicit message communication succeeds, the completion flag M1 changes to ON.
- When M0 changes to ON, AS01DNET-A sends out the request message only once. If the request message is to be resent, the instruction DNETRW need be re-triggered.

11

11.4.9 LED Indicators and Troubleshooting

AS01DNET-A has two LED indicators and one digital displayer. NS LED and MS LED display the connection status of AS01DNET-A. The digital displayer shows the node address and error information of AS01DNET-A as well as error information of the slave.

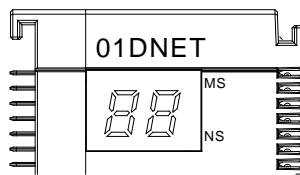

11.4.9.1. NS LED

LED status	Indication	Correction
OFF	No power; Or duplicate ID check has not been completed.	1. Check if AS01DNET-A is powered and the connection is normal. 2. Make sure that at least one node can communicate normally.
Green light blinking (ON:0.5s and OFF: 0.5s alternately)	The connection to the DeviceNet network failed.	No correction; Refer to Digital Displayer for troubleshooting.
Green light ON	Online; The connection to the DeviceNet network is normal.	No correction
Red light blinking (ON:0.5s and OFF: 0.5s alternately)	Communication error	Refer to Digital Displayer for troubleshooting.
Red light ON	Network trouble, duplicate node ID, no network power or Bus-OFF.	1. Make sure that all the devices in the network have their unique node addresses. 2. Check if the network installation is correct. 3. Check if the baud rates of the master and slave are same. 4. Check if the network power is normal.

11.4.9.2. MS LED

LED status	Indication	Correction
OFF	No power	Make sure that the power supply for AS01DNET-A is normal and the connection is proper.
Green light blinking (ON:0.5s and OFF: 0.5s alternately)	No module is configured.	Configure the scan list and then download the configuration to AS01DNET.
Green light ON	Input and output data are normal.	--
Red light blinking (ON:0.5s and OFF: 0.5s alternately)	When AS01DNET works as the master, the slave in Scan List can not work normally. When AS01DNET works as the slave, an error occurs in the configuration.	Refer to Digital Displayer. Make sure that the slave information in Scan List matches that of the actually connected slave.
Red light ON	An error inside AS01DNET	1. Check if the configuration is correct. 2. Return the module to factory for repair if the error still exists after repower ON.

11.4.9.3. Combination of MS LED and NS LED

LED status		Indication	Correction
NS LED	MS LED		
OFF	OFF	No power	Check if the power supply for AS01DNET-A is normal.
OFF	Green light ON	Duplicate ID check has not been completed.	Make sure that the baud rate of at least one node in the network is the same as that of the module and their communication is normal.
Red light ON	Green light ON	Duplicate ID check failed or Bus-OFF.	1. Ensure that the node ID of AS01DNET is unique. 2. Repower the module.
Red light ON	Red light blinking (ON:0.5s and OFF: 0.5s alternately)	No network power	1. Check if the network cable connection is proper. 2. Check if the network power supply is normal.
Red light ON	Red light ON	Hardware error	Return the module to the factory for repair.

11.4.9.4. Digital Displayer

Code	Explanation	Correction
0~63	Node address of AS01DNET-A (in normal operation)	--
80	AS01DNET-A is in STOP status.	Turn the PLC to RUN and start I/O data exchange
F0	The node ID of AS01DNET is the same as that of other node or exceeds the allowed range.	1. Ensure that the node address of AS01DNET is unique. 2. Re-power AS01DNET.
F1	No slave is configured in Scan List.	Configure the scan list and then download the configuration to AS01DNET.
F2	Too low voltage of the work power	Check if the power supply for AS01DNET and the PLC is normal.
F3	AS01DNET enters the test mode	Switch the function switch IN1 from On to Off and re-power AS01DNET-A.

Code	Explanation	Correction
F4	BUS-OFF	<ol style="list-style-type: none"> 1. Check if the network cable is normal and the shielded cable is grounded. 2. Check if the baud rates of all nodes in the network are same. 3. Check if the start and end of the network cable are both connected with a 121Ω terminal resistor. 4. Re-power AS01DNET-A.
F5	No network power	<ol style="list-style-type: none"> 1. Check if the network cable is normal. 2. Ensure that the network power is normal.
F6	Internal error; Flash or RAM check error	If the error still exists after re-power, send AS01DNET-A back to the factory for repair.
F8	Error produced in factory manufacturing	If the error still exists after re-power, send AS01DNET-A back to the factory for repair.
F9	Internal error; EEPROM access failure	If the error still exists after re-power, send AS01DNET-A back to the factory for repair.
FA	Invalid configuration data	<ol style="list-style-type: none"> 1. Configure the network correctly and re-download it to AS01DNET-A. 2. Check if the node address of one slave in the scan list is the same as that of AS01DNET-A.
E0	Identification parameters returned from the slave do not match the configuration data.	<ol style="list-style-type: none"> 1. Check if there is any change in node ID of the slave in the network. 2. Check if some node device in the network is replaced. 3. Re-configure the network.
E1	I/O Data size returned does not match that in the scan list.	Re-configure I/O data size of the slave, download the configuration to AS01DNET-A and run the PLC.
E2	The slave device in the scan list does not exist or is offline when AS01DNET-A is in master mode.	<ol style="list-style-type: none"> 1. Check if there is a change in the node address of the slave. 2. Check if the communication cable is disconnected or connected loosely. 3. Check if the bus cable length exceeds the maximum transmission distance. If so, the system may not be stable.
	The I/O connection between the slave AS01DNET-A and the master is broken when AS01DNET-A is in slave mode.	
E3	AS01DNET-A fails to transmit data.	<ol style="list-style-type: none"> 1. Make sure that the connection between AS01DNET-A and the network is normal. 2. Check if the baud rate of AS01DNET-A is the same as that of other node in the network.
E4	Error detected in sequence of fragmented I/O data from the slave device.	Check if the slave is operating normally.
E5	The slave device returns error when AS01DNET-A attempts to communicate with it.	Check if the slave is operating normally.
E6	IO data size returned from the slave is bigger than that configured in Scan List.	Check that the IO data size of the slave should be the same as that configured in Scan List.
E7	AS01DNET-A is checking MAC ID.	<p>If the code is displayed long, do the troubleshooting according to the following steps.</p> <ol style="list-style-type: none"> 1. Make sure that at least two nodes work normally in the network. 2. Check if either end of the network is connected with the terminal resistor of 121Ω. 3. Check if the baud rates of the node devices in the network are

Code	Explanation	Correction
		<p>same.</p> <ol style="list-style-type: none"> 4. Check if the communication cable is normal so as to avoid that the cable is disconnected or connected loosely. 5. Check if the bus cable length exceeds the maximum transmission distance. If so, the system may not be stable. 6. Check if the shielded wire of the network cable is grounded. 7. Re-power AS01DNET-A scanner module.

11.4.10 Master-Slave Mode Switch and 8 Baud Rates Setting via Software

AS01DNET-A can serve as a DeviceNet master or slave by modifying its mode. When the AS01DNET-A module works as a slave, the input and output data sizes are both 8 Bytes by default. The maximum input and output data sizes are both 200 Bytes.

Under standard mode, AS01DNET-A supports three baud rates: 125K, 250K and 500K. Under non-standard mode, AS01DNET-A supports eight baud rates: 10K, 20K, 50K, 125K, 250K, 500K, 800K and 1M.

11.4.10.1. Setting AS01DNET-A to Slave Mode

1. Build a driver through the COMMGR software.

Refer to Section 2.4 Communication Setting in the ISPSOFT User Manual for more details.

2. Call the DeviceNet Builder software through the ISPSOFT software.

Refer to Section 11.6 in this manual for details on how to operate.

3. The called DeviceNet Builder software interface is shown as below.

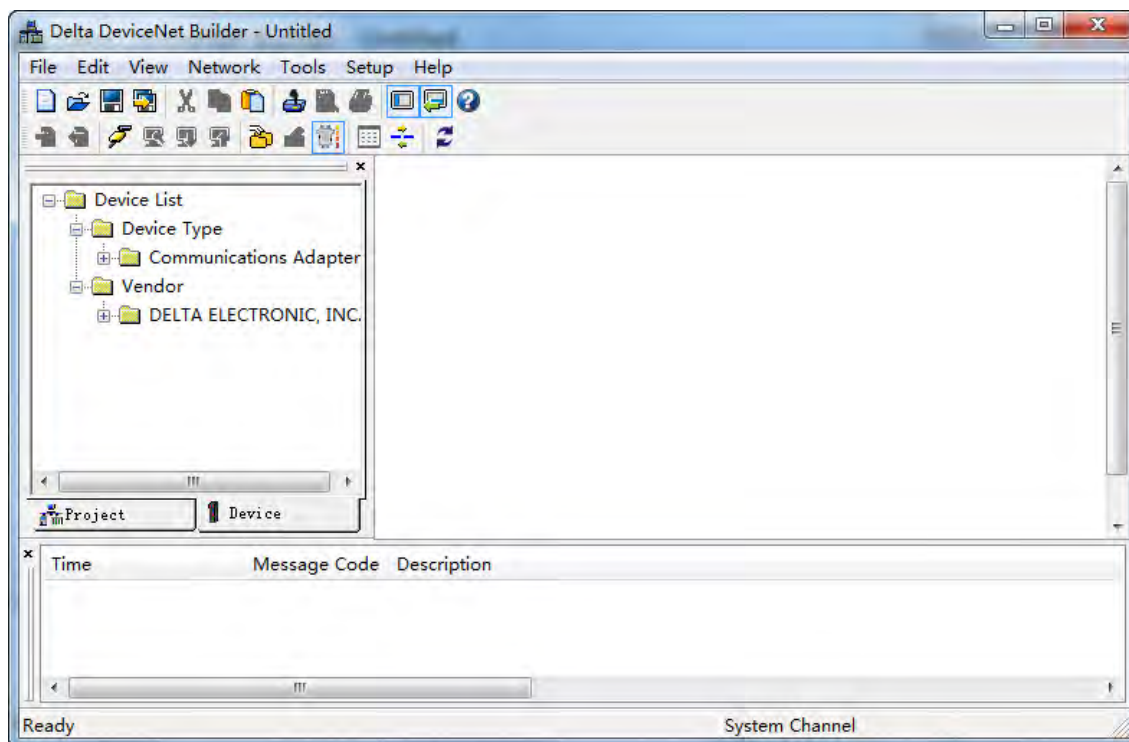

4. Selecting **Setup>> Communication Setting**, the following dialog box appears. Select the driver for connection of AS PLC and PC as below. Click **OK** to finish the selection of Driver.

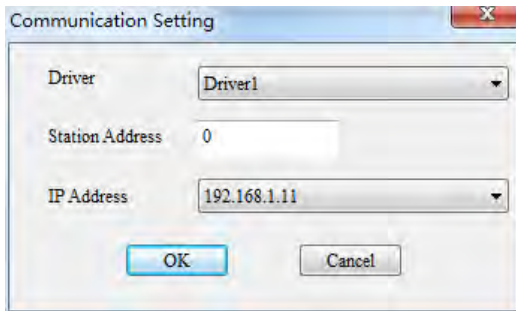

5. Click **Network >> Online** to scan the connected master.

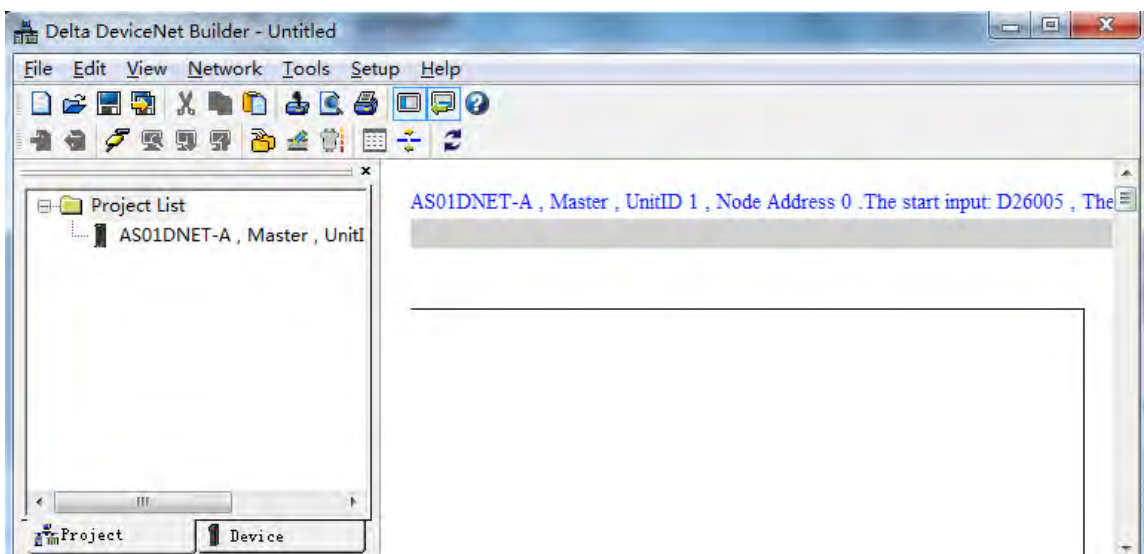

6. Click **Project List>>Properties**. Then the **Properties** dialog box appears. Select **Slave** mode and then click **OK**.

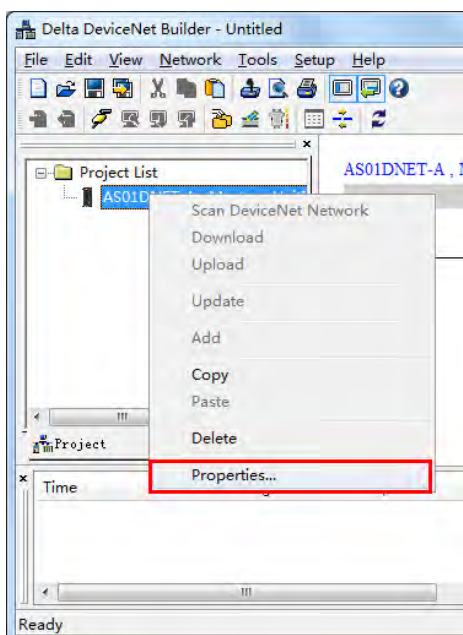

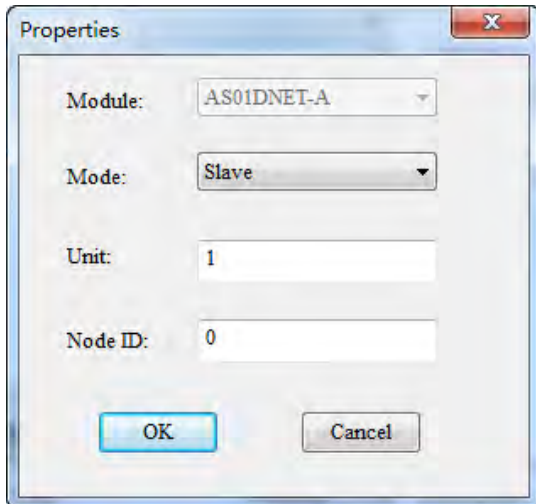

7. Click **Network >> Download**. If the PLC is in STOP state, the following dialog box will exist during the download. The dialog box will disappear automatically after the download is finished. AS01DNET-A will be in slave mode after repower ON.

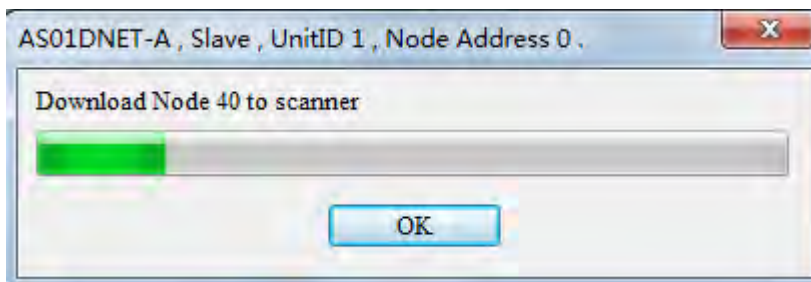

8. If the PLC is in RUN state, the **Warning** dialog boxes will pop out before and after the download. Users can click **OK** or **Cancel** according to actual situation.

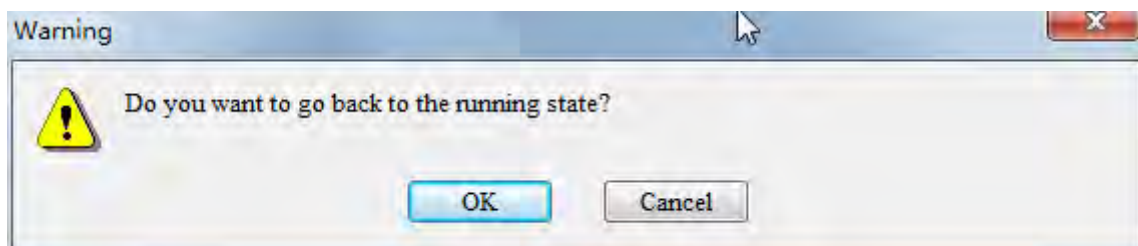
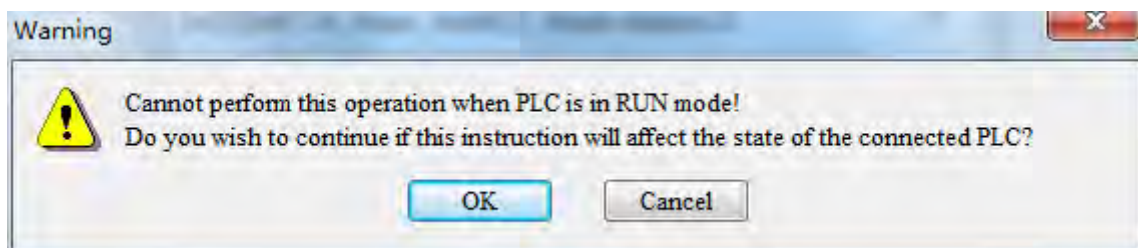

11.4.10.2. Setting AS01DNET-A to Master Mode

1. Build a driver through the COMMGR software.
Refer to Section 2.4 Communication Setting in the ISPSOFT User Manual for more details.
2. Call the DeviceNet Builder software through the ISPSOFT software.
Refer to Section 11.6 in this manual for details on how to operate.
3. The called DeviceNet Builder software interface is shown as below.

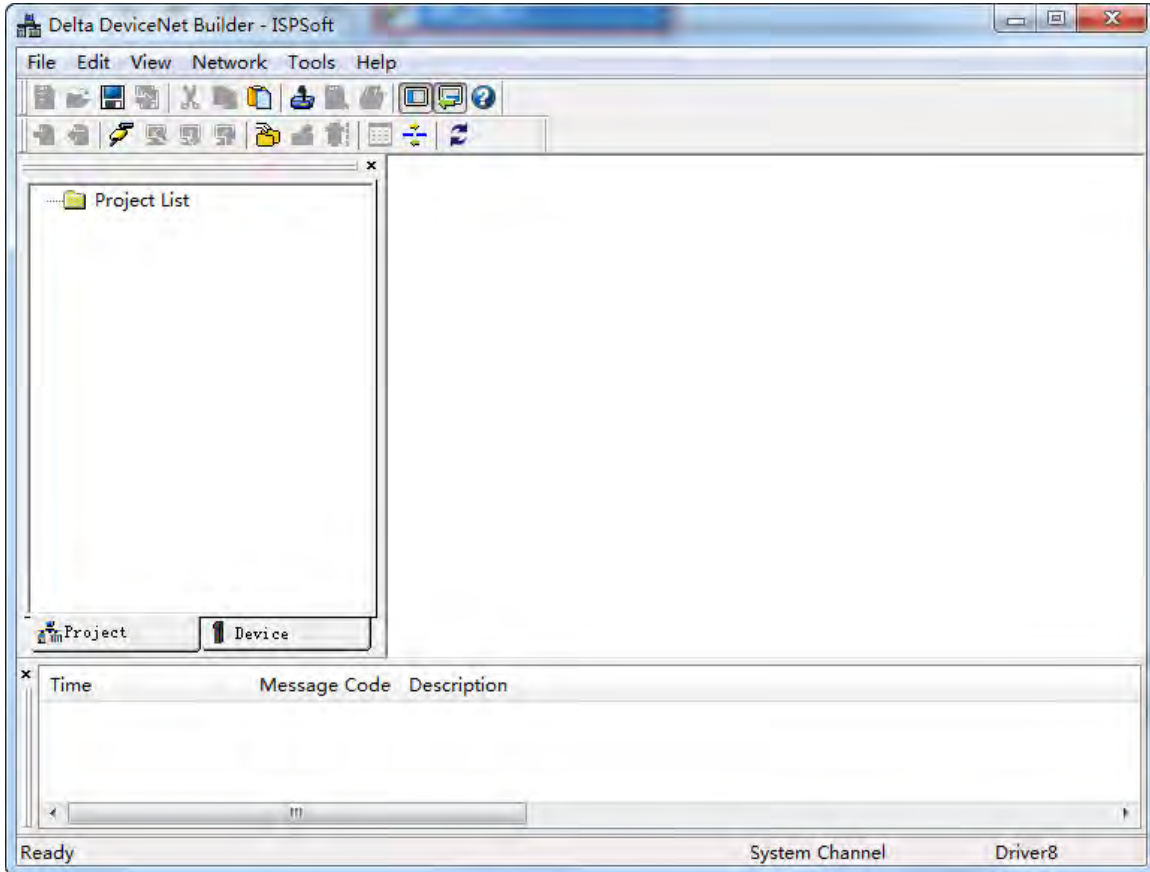

4. Selecting **Setup>> Communication Setting**, the following dialog box appears. Select the driver for connection of AS PLC and PC as below. Click **OK** to finish the selection of Driver.

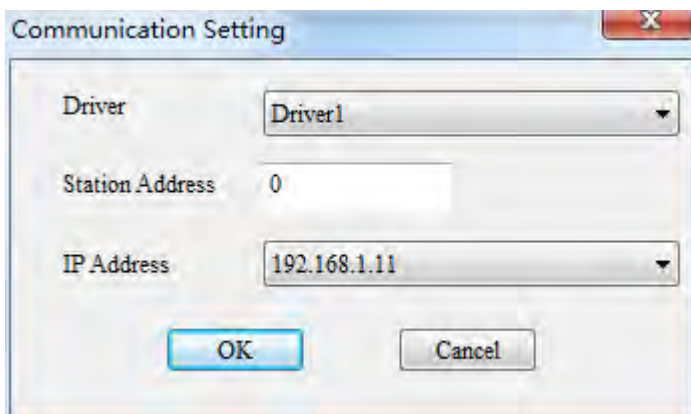

5. Click **Network >> Online** to scan the connected slave.

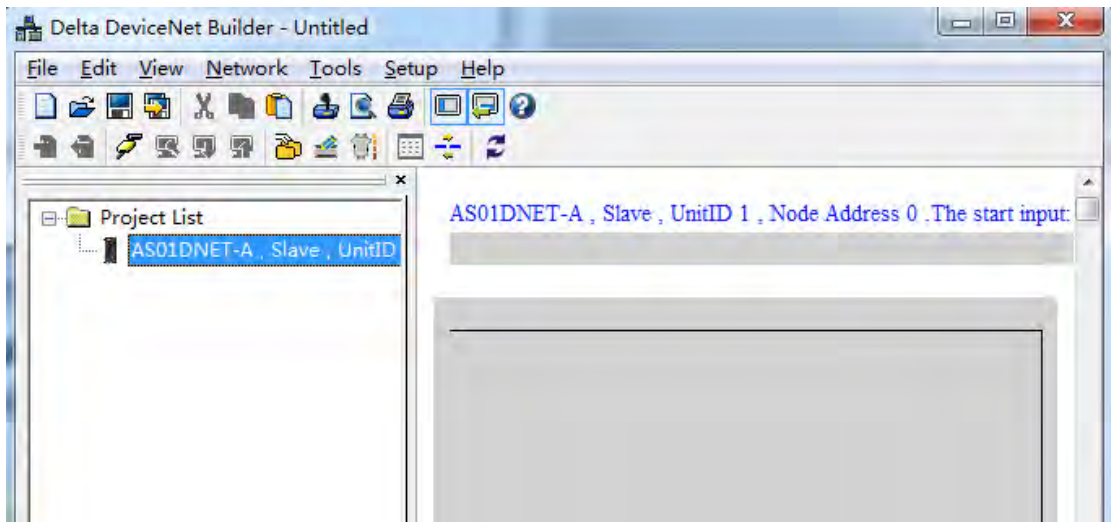

6. Click **Project List>>Properties** as below. Then the **Properties** dialog box appears. Select **Master** mode and then click **OK**.

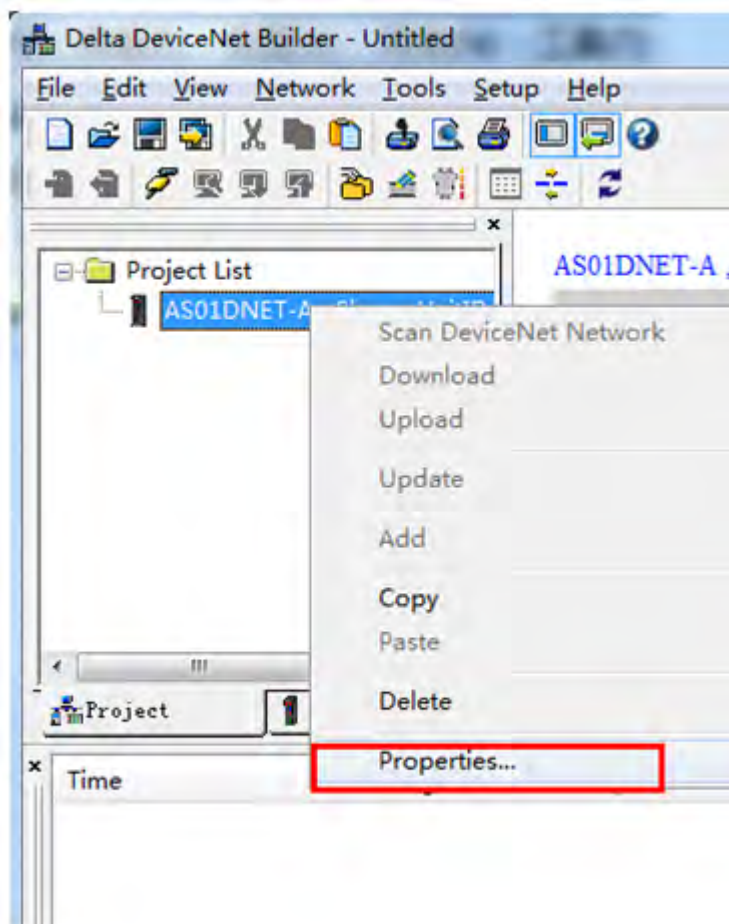

11

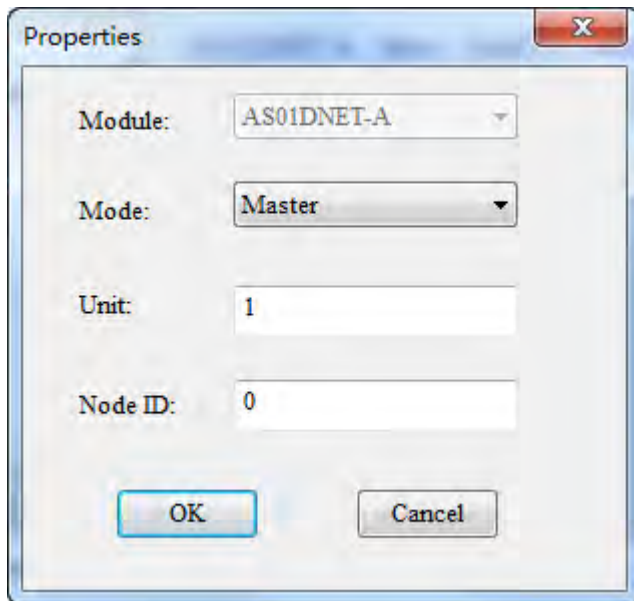

- Click **Network >> Download**. If the PLC is in STOP state, the following dialog box will exist during the download. The dialog box will disappear automatically after the download is finished. AS01DNET-A will be in master mode after repower ON.

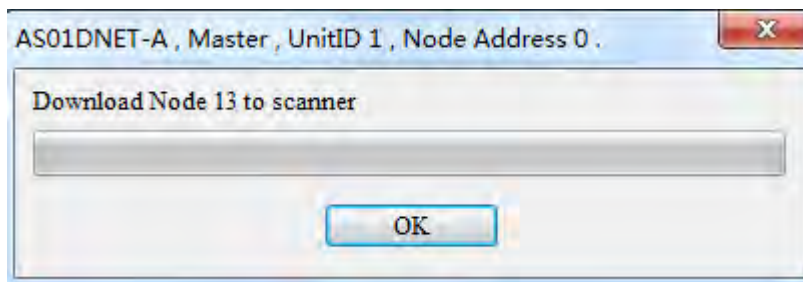

- If the PLC is in RUN state, the **Warning** dialog boxes will pop out before and after the download. Users can click **OK** or **Cancel** according to actual situation.

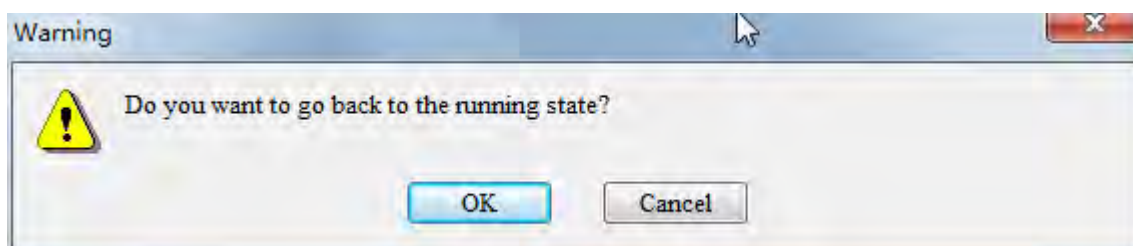
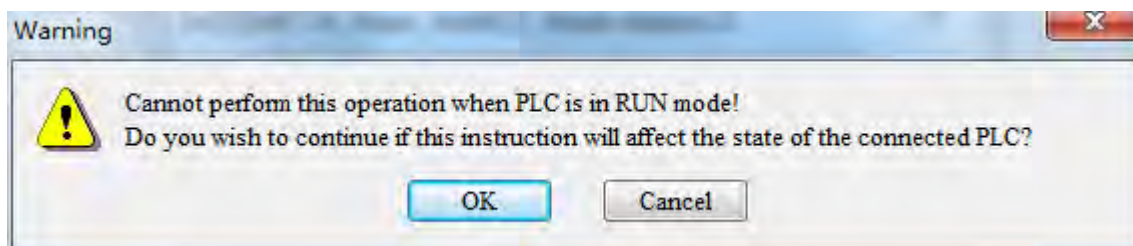

11.4.10.3. Baud Rate Setting of When AS01DNET-A is in Slave Mode

1. Opening the DeviceNet Builder software, the following window appears.

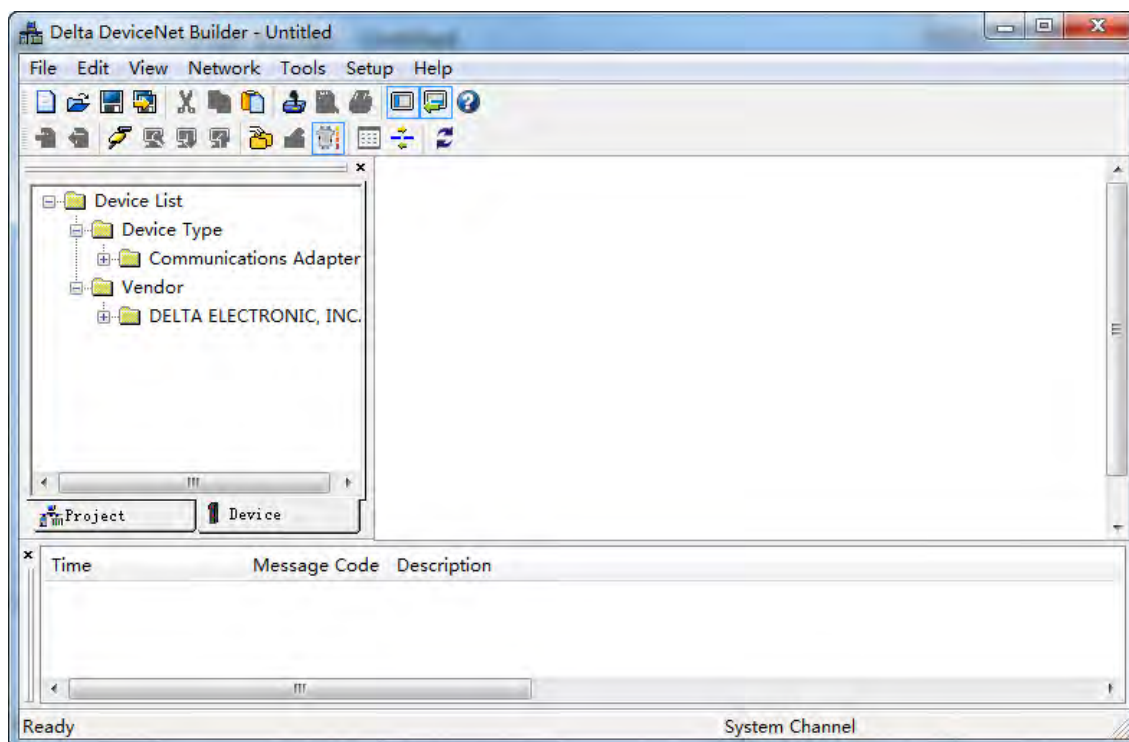

2. Selecting **Setup>> Communication Setting**, the following dialog box appears. Select the driver for connection of AS PLC and PC as below. Click **OK** to finish the selection of Driver.

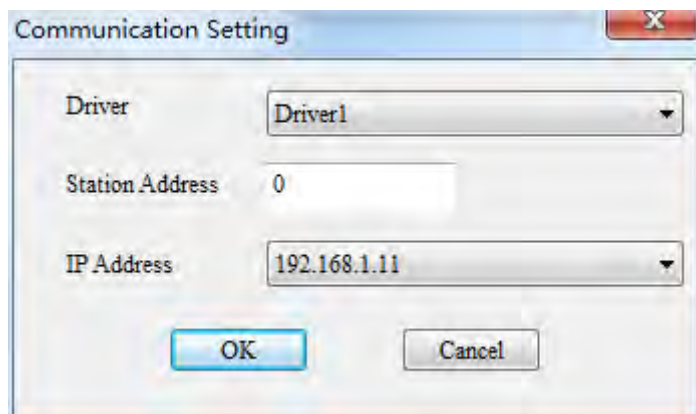

3. Click **Network >> Online** to scan the connected master.

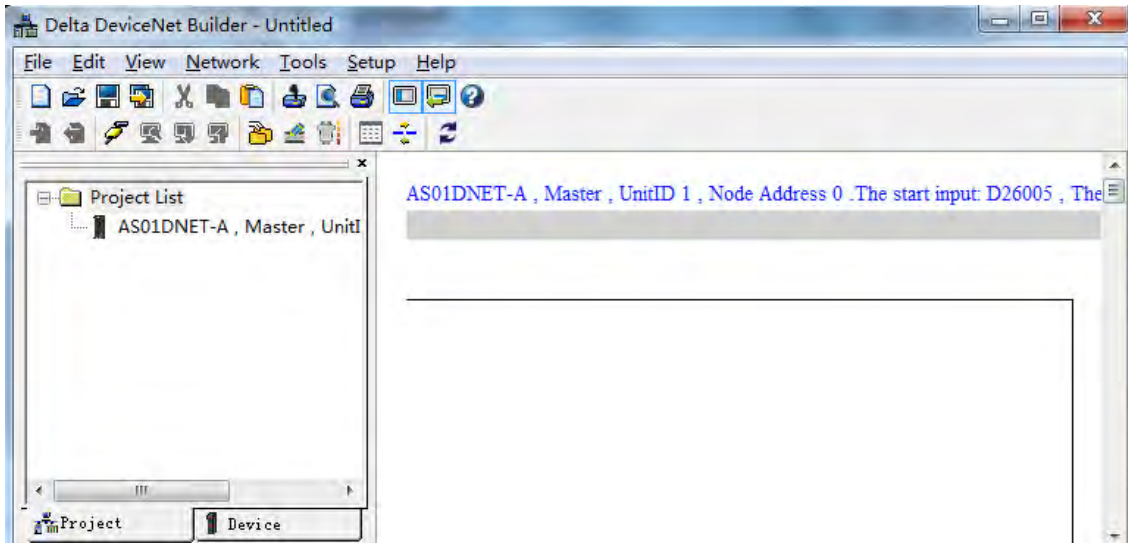

4. Clicking **Network>> Scan DeviceNet Network**, the DeviceNet Builder software starts to scan the whole network.

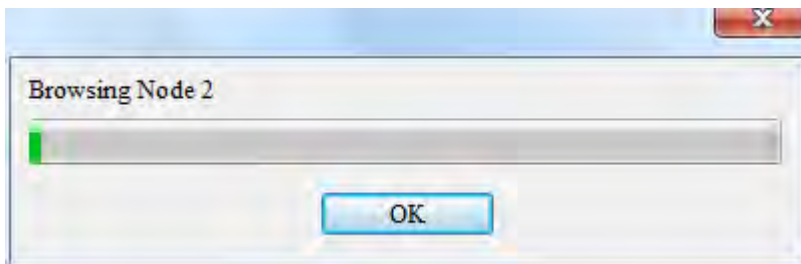

5. After scanning is finished, all node icons and device names which have been scanned in the network will appear on the following interface. The node address of AS01DNET-A is 01 in this example.

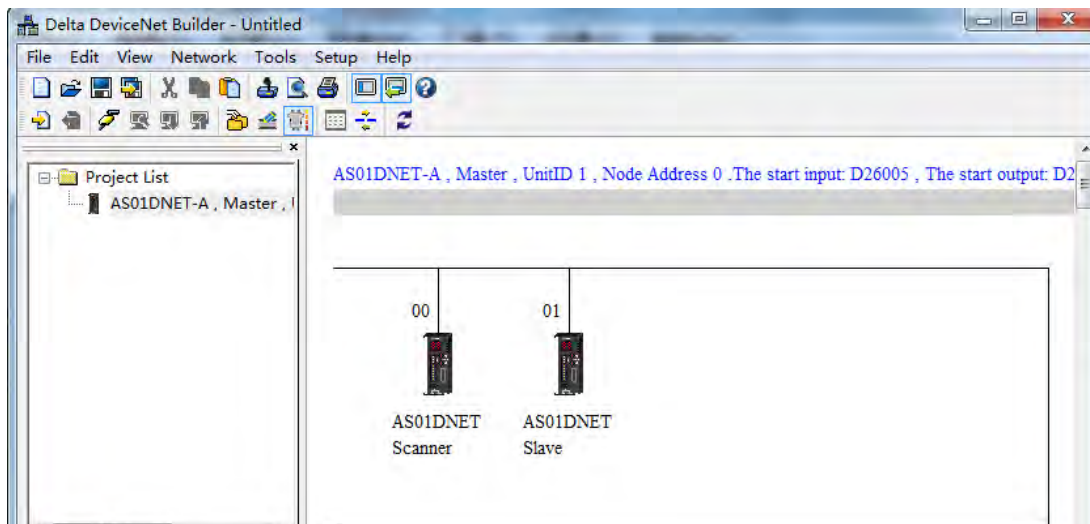

- Right-click AS01DNET(Slave), select **Parameter Edit...** on the drop-down menu to enter the **Parameter Edit** page.

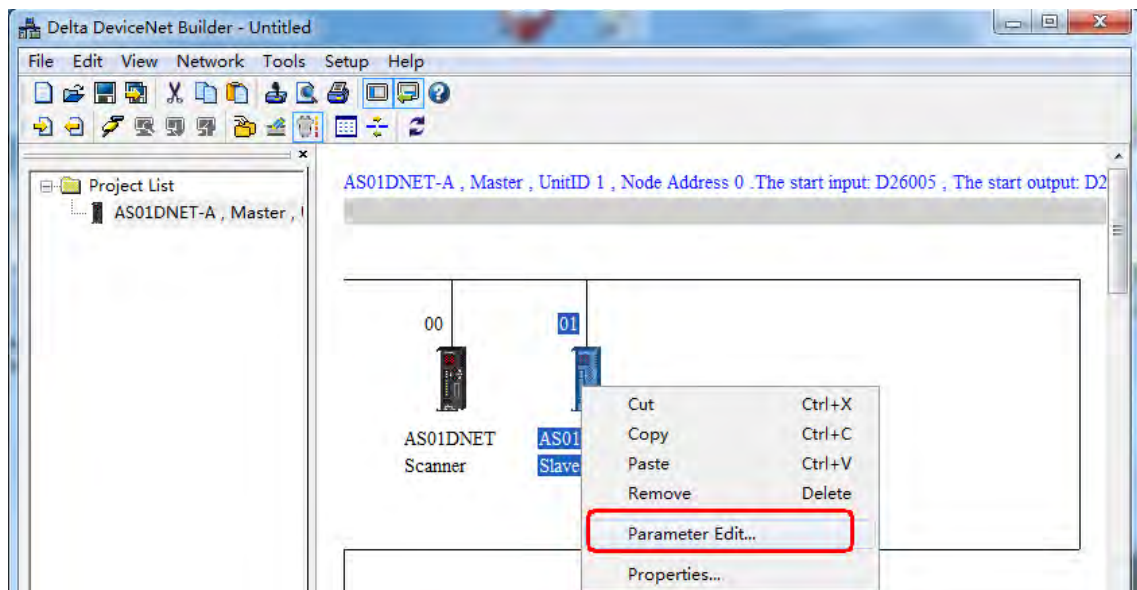

- Set **Extend Baudrate Enable** to **Enable** and then select the desired baud rate. Click **Write** button after setting is finished.

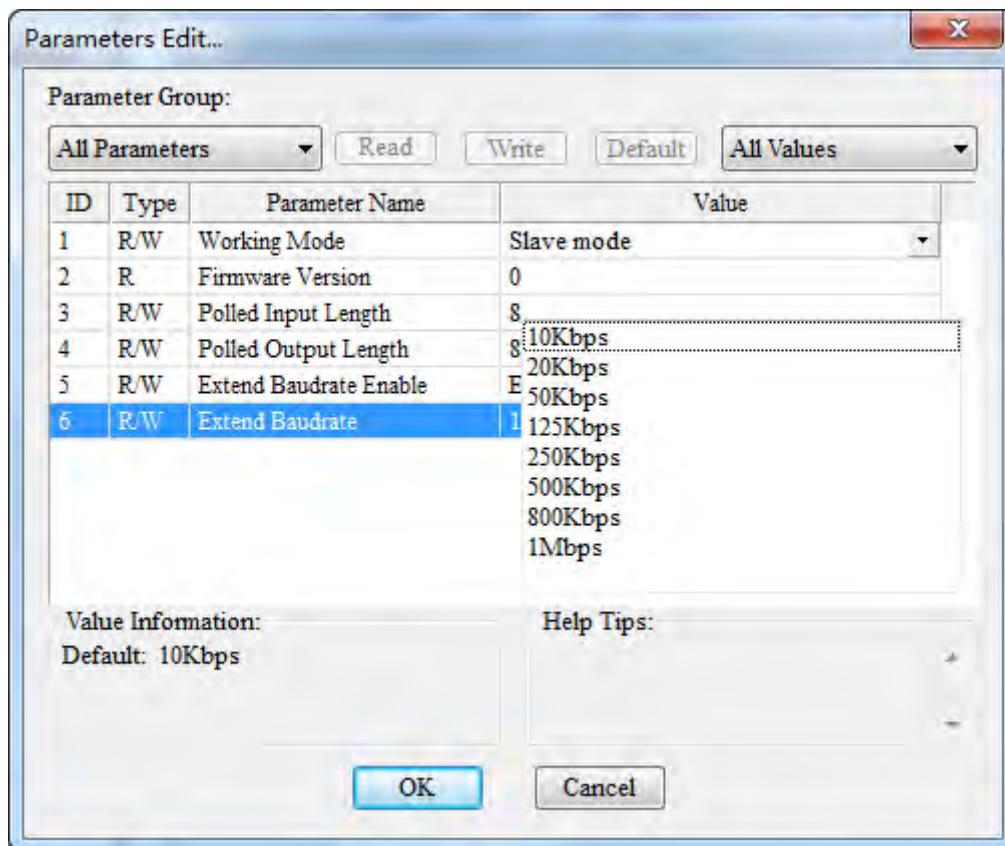

- After the download is completed, switch DR0 and DR1 of AS01DNET to ON. Finally, repower AS01DNET-A.

11.4.10.4. Baud Rate Setting of When AS01DNET-A is in Master Mode

1. Opening the DeviceNet Builder software, the following window appears.

11

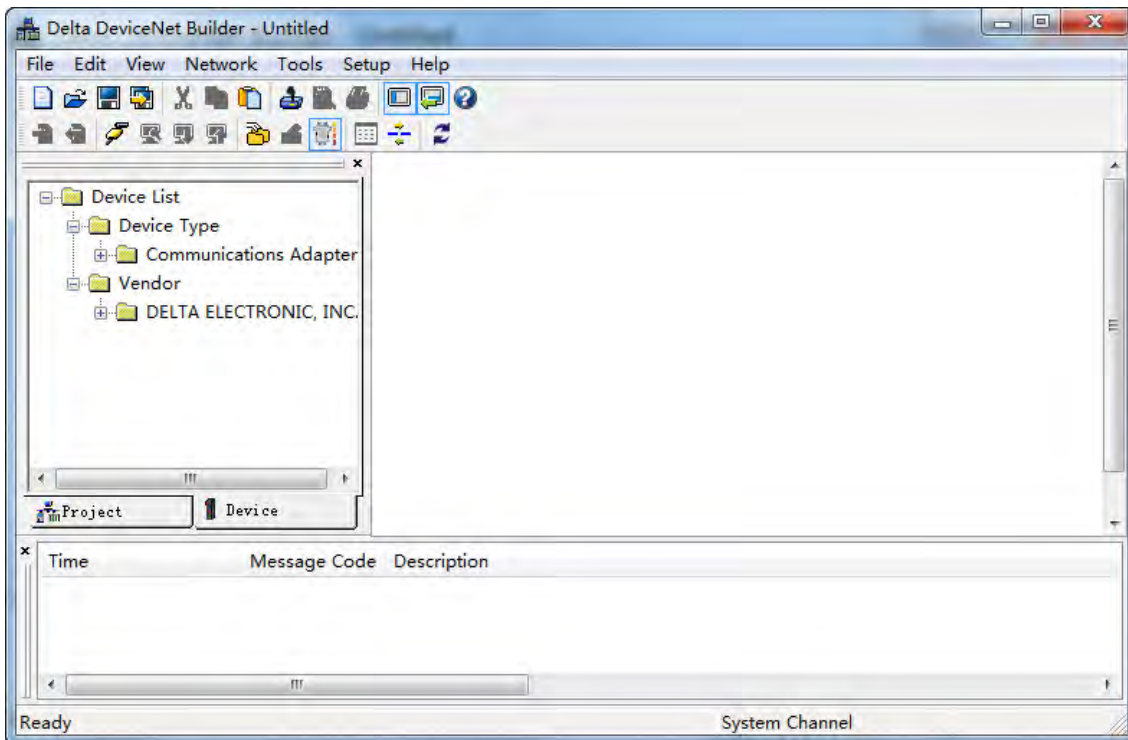

2. Selecting **Setup>> Communication Setting**, the following dialog box appears. Select the driver for connection of AS PLC and PC as below. Click **OK** to finish the selection of Driver.

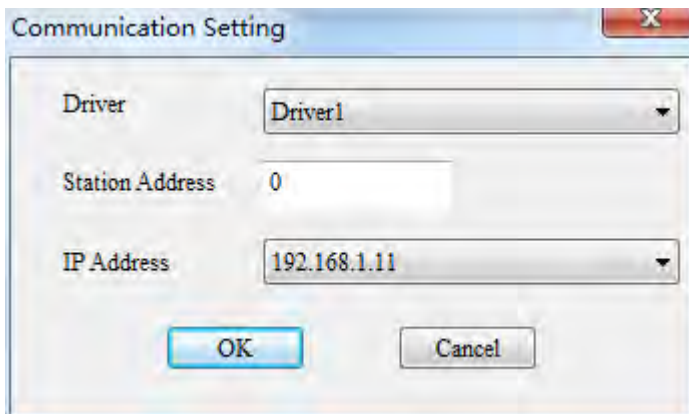

3. Click **Network >> Online** to scan the connected master.

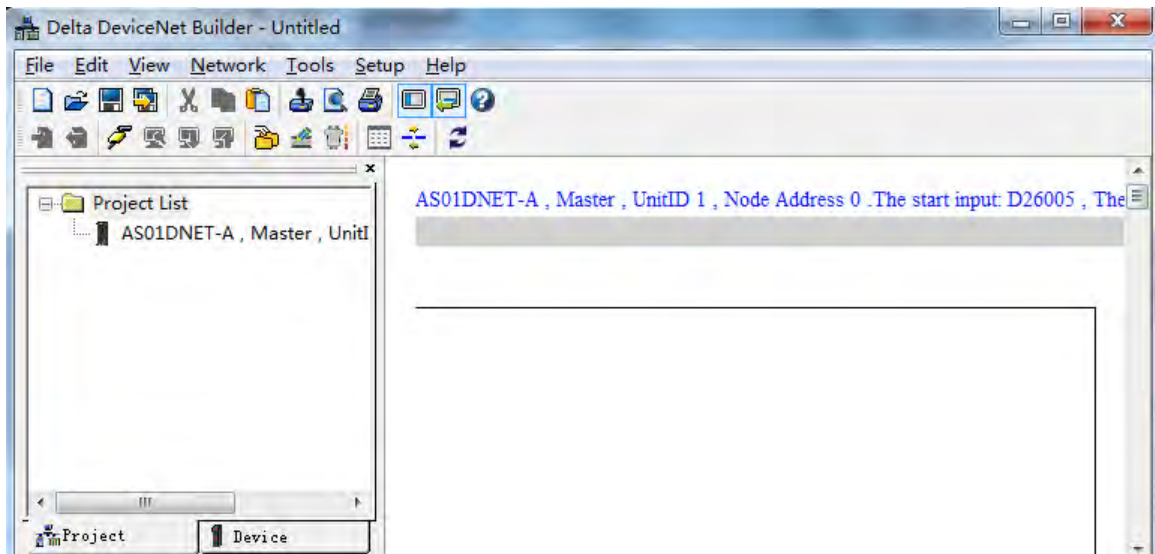

4. Clicking **Network>> Scan DeviceNet Network**, the DeviceNet Builder software starts to scan the whole network.

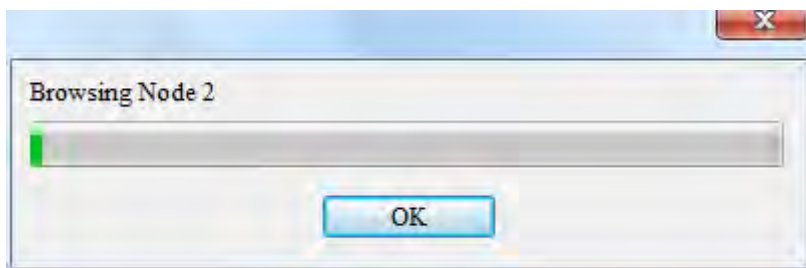

5. After scanning is finished, all node icons and device names which have been scanned in the network will appear on the following interface. The node address of AS01DNET-A is 00 in this example.

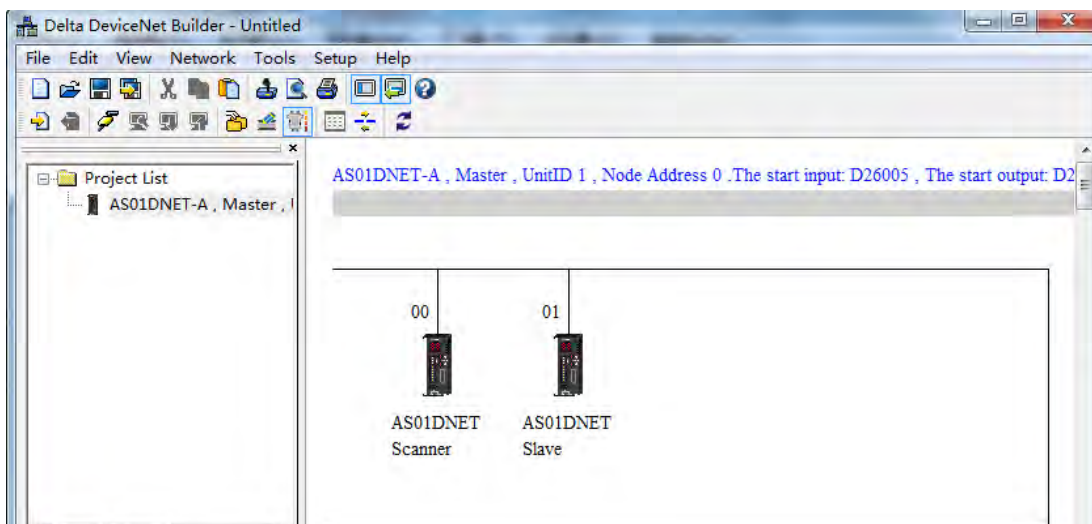

- Click **Network >> Scanner Setting**. The **Scanner Setting** dialog box appears. Select **Enable** under **Extension Baudrate** and the desired baud rate as below. Click **OK** after the setting is finished.

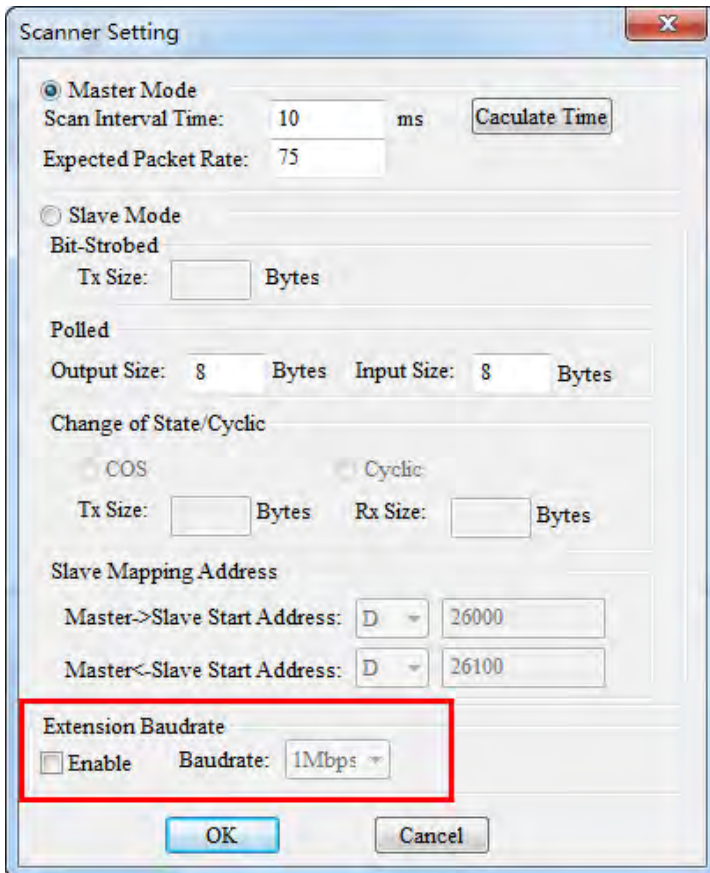

- Click **Network >> Download** to download the extension baud rate setting to the master. After the download is completed, switch DR0 and DR1 of AS01DNET-A to ON. Finally, repower AS01DNET-A.

11.5 RTU Mode

11.5.1 Introduction of AS01DNET (in RTU Mode)

- As DeviceNet slave, AS01DNET-A supports standard DeviceNet communication protocol.
- Supports explicit connection in the predefined master/slave connection and I/O polling connection.
- The network configuration software DeviceNet Builder provides graphic configuration interface, and supports auto scan and recognition of I/O modules, free mapping of special module parameters as I/O exchange data as well as the setting of exception handling and diagnosis of module error states.
- Users can choose to retain the data in registers or not when the network is disconnected according to actual need.
- AS01DNET (in RTU mode) can connect max. 8 AS-series extension modules including digital modules, analog modules, temperature modules and etc. The mapping length of digital modules is determined by number of digital points. The max. length of mapping parameters for input of other module is 20 words and the max. length of mapping parameters for output of other module is 20 words.
- Max lengths for output data and input data of AS01DNET (in RTU mode) are both 100 bytes.
- AS01DNET (in RTU mode) needs the external 24VDC power supply.

11.5.2 AS-Series Extension Modules Connectable to AS01DNET (RTU)

The model and specification of AS-series digital modules connectable to AS01DNET (in RTU mode):

Digital I/O module model	Length of I/O mapping data (Unit: words)	
	(Master→AS01DNET)	(AS01DNET→Master)
AS08AM10N-A	None	1
AS16AM10N-A	None	1
AS32AM10N-A	None	2
AS64AM10N-A	None	4
AS08AN01T-A	1	None
AS08AN01R-A	1	None
AS08AN01P-A	1	None
AS16AN01T-A	1	None
AS16AN01R-A	1	None
AS16AN01P-A	1	None
AS32AN02T-A	2	None
AS64AN02T-A	4	None
AS16AP11T-A	1	1
AS16AP11R-A	1	1
AS16AP11P-A	1	1

The model and specification of AS-series special modules connectable to AS01DNET (in RTU mode):

Special module model	Length of I/O mapping data (Unit: words)	
	DeviceNet→AS01DNET(RTU)	AS01DNET(RTU)→DeviceNet
AS04AD-A	6	None
AS04DA-A	2	4
AS06XA-A	10	4
AS02LC-A	7	1
AS04RTD-A	10	None
AS06RTD-A	14	None
AS04TC-A	10	None
AS08TC-A	18	None
AS08AD-B	18	None
AS08AD-C	18	None

Note:

The length of mapping data of the I/O modules connected to AS01DNET (in RTU mode) is fixed. The default mapping parameters of special modules must be chosen.

Besides default mapping parameter configuration, you can also choose other parameters for I/O mapping according to need when special modules are connected to AS01DNET (RTU). The max. input length and max. output length of default parameters and user-added mapping parameters of each special module are both 20 words.

11.5.3 Installation

11.5.3.1. Installing AS01DNET (in RTU Mode)

11.5.3.1.1. Connecting AS01DNET-A (in RTU Mode) and Extension Module on DIN Rail

- Please push the clips of AS01DNET-A (RTU) in the directions indicated by arrow ① until hearing a click. That means the DIN clips are interlocked each other. Then insert the module hooks at the bottom into the DIN rail mounting slot until hearing a click. That means AS01DNET-A (RTU) is connected to the DIN rail.
- To install the second module AS16AP11T, push the clips of AS16AP11T in the direction indicated by arrow ①. Then aim the left-side slot of AS16AP11T at the right-side slot of AS01DNET-A (RTU) and push AS16AP11T in the direction as illustrated by arrow ② until hearing a click. That means the module is on the DIN rail and is connected to AS01DNET-A (RTU). In the same way, install more IO modules on the right side of AS01DNET-A (RTU) and DIN rail one by one.

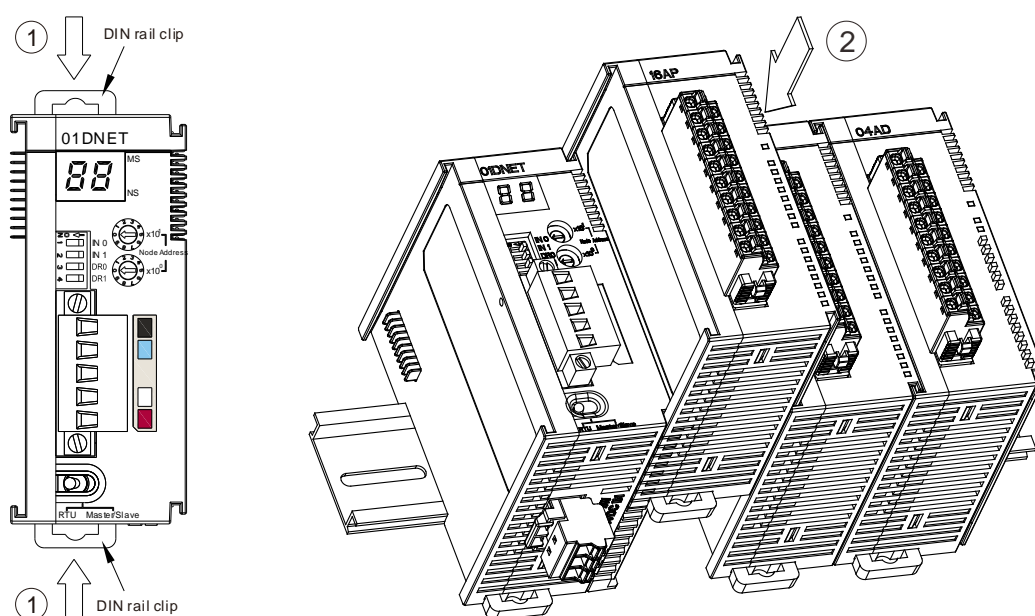

- Tighten the screws on the top of the module at the end of installing.

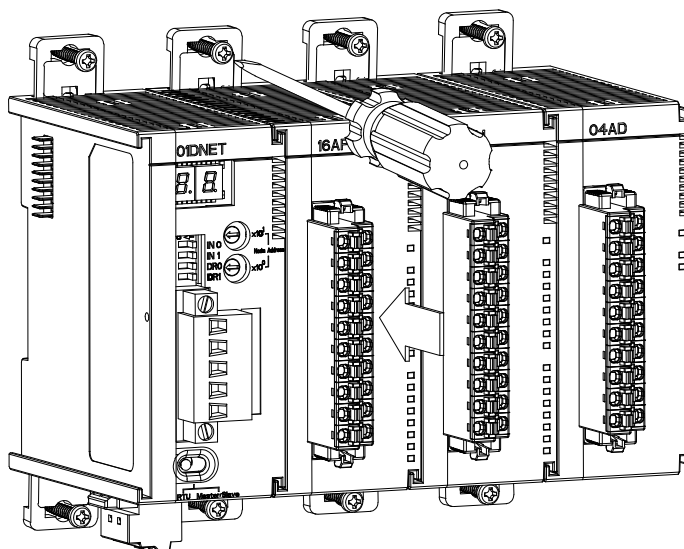

11.5.3.1.2. Connecting the DeviceNet Communication Connector

- The color marks on the communication connector match the colors of the connection cables. During the wiring, please check whether the colors of the connection cable and the color mark are same.
- Delta's power module is recommended as the power module in the communication.

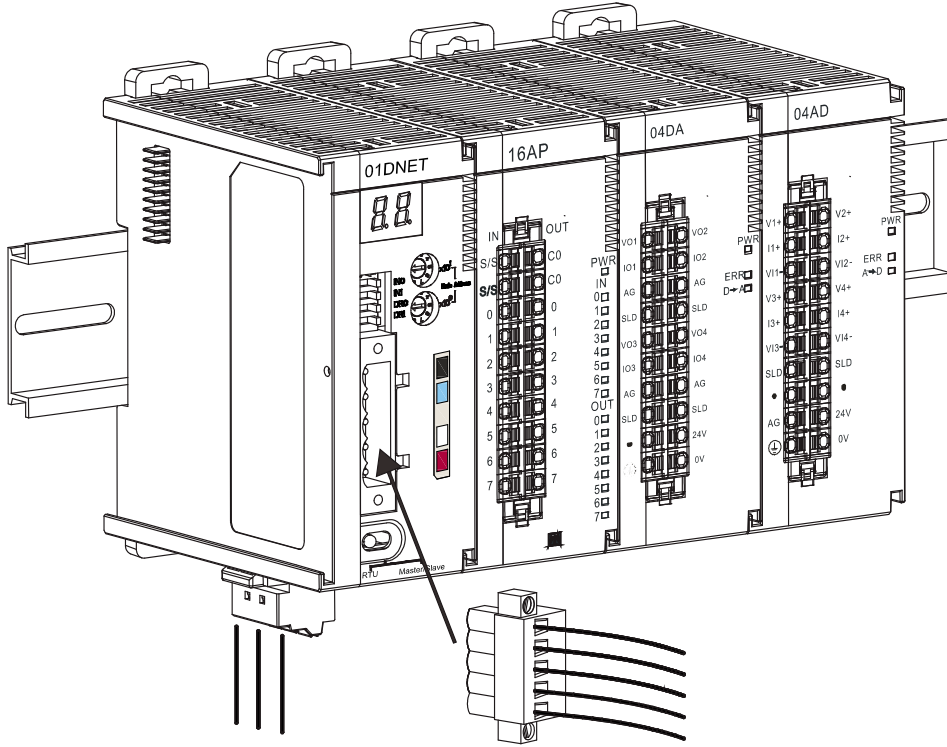

11.5.3.2. Connecting the Cable to DeviceNet Connector

- Use an efficient tool to peel the communication cable for approx. 30mm. DO NOT damage the shielded cable during the peeling.
- Peel off the metallic shielded net and foil, and you will see 2 power cables (red and black), 2 signal cables (blue and white) and 1 shielded cable.
- Peel off the exterior metallic shielded net, foil and the plastic cover of the power cable and signal cable for appropriate length.

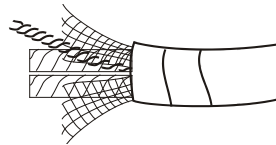
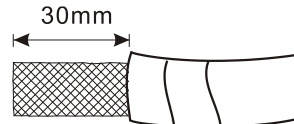

- Insert the peeled communication cables into the holes in the connector in correct order.

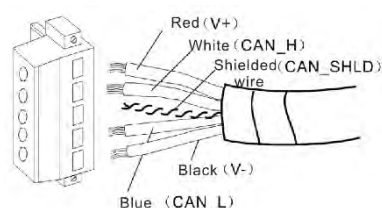

- Tighten the screws on the connector by a slotted screwdriver and fix the communication cables in the holes in the connector.

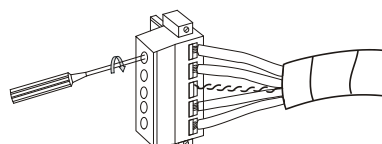

11.5.4 Configuring AS01DNET (in RTU mode)

As DeviceNet slave, AS01DNET (RTU) mainly achieves the data exchange between the master and AS-series I/O modules connected to AS01DNET.

- Transmits output data of DeviceNet master to I/O modules.
- Transmits input data from I/O modules to DeviceNet master.

11.5.4.1. Terms

No.	Name	Unit	Description
1	Control word	WORD	The first WORD for output data that the master assigns to AS01DNET is the control word of AS01DNET for setting the work mode of AS01DNET. When the content in the control word is set to 2, AS01DNET is in STOP mode. When the content in the control word is set to 1, AS01DNET is in RUN mode.
2	Status word	WORD	The first WORD for input data that the master assigns to AS01DNET is the status word of AS01DNET for displaying the operation state of AS01DNET. Refer to section 11.5.4.3.4 for more about status word.
5	Range of input data in modules	WORD	Determined by start input address and input mapping parameter length of each module.
6	Range of output data in modules	WORD	Determined by start output address and output mapping parameter length of each module.
7	Input data size	WORD	The sum of the size of status word of AS01DNET and the size of input data of the modules connected to it. The status word occupies one word. Digital input module takes 16 bits as one word. The input data length of analog I/O modules and temperature modules are determined by the default mapping parameter length and user-added parameter length, no more than 20 words.
8	Output data size	WORD	The sum of the size of control word of AS01DNET and the size of output data of the modules connected to it. The control word occupies one word. Digital output module takes 16 bits as one word. The output data length

No.	Name	Unit	Description
			of analog I/O modules and temperature modules are determined by the default mapping parameter length and user-added parameter length together, no more than 20 words.

11

11.5.4.2. Introduction of Software

Before the new version of DeviceNet Builder software is used for making a connection with PLC, make sure that the communication manager COMMGR has been installed.

(Refer to ISPSOFT user manual for details on COMMGR usage.)

11.5.4.2.1. Making a connection between DeviceNet Builder and PLC

Before making a normal connection between DeviceNet Builder and PLC, you have to do relevant setup for COMMGR software.

1. Build a driver through the COMMGR software.

Refer to Section 2.4 Communication Setting in the ISPSOFT User Manual for more details.

2. Call DeviceNet Builder via ISPSOFT

Refer to Section 11.6 for details on how to operate.

3. The called DeviceNet Builder is started as below.

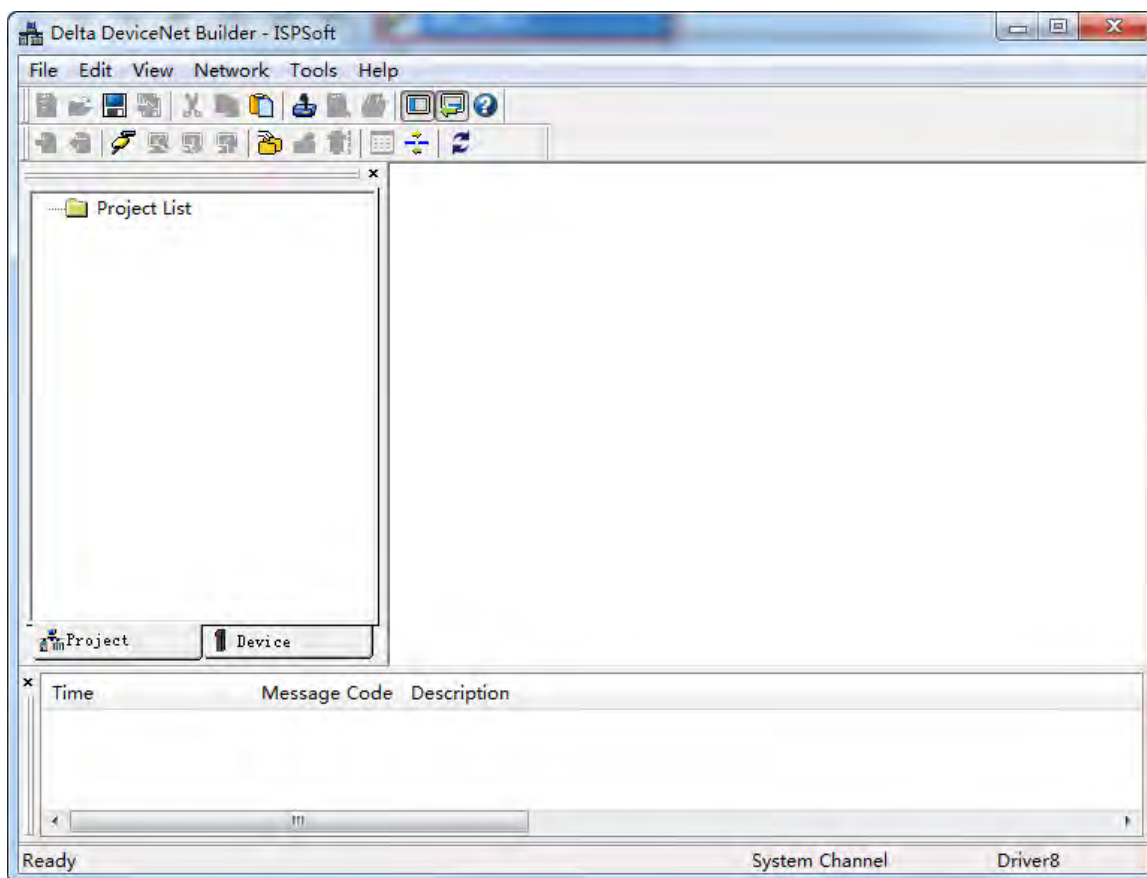

4. Click menu **Network>> Online**.

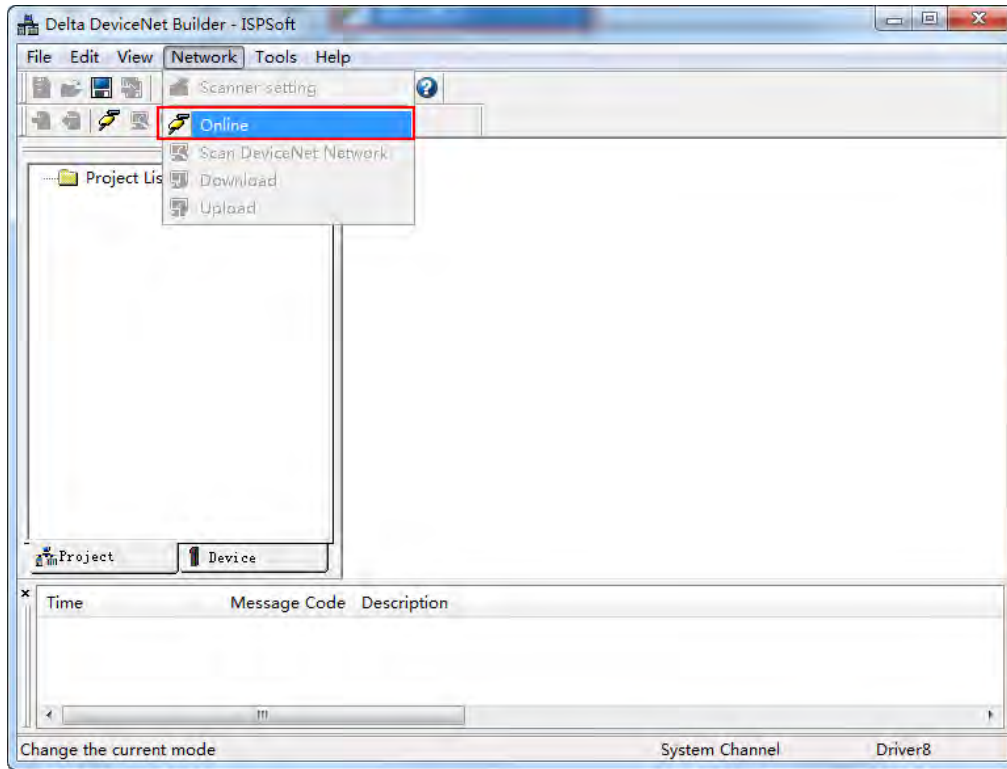

5. The master module AS01DNET-A which has been scanned is shown in the left-side Project List.

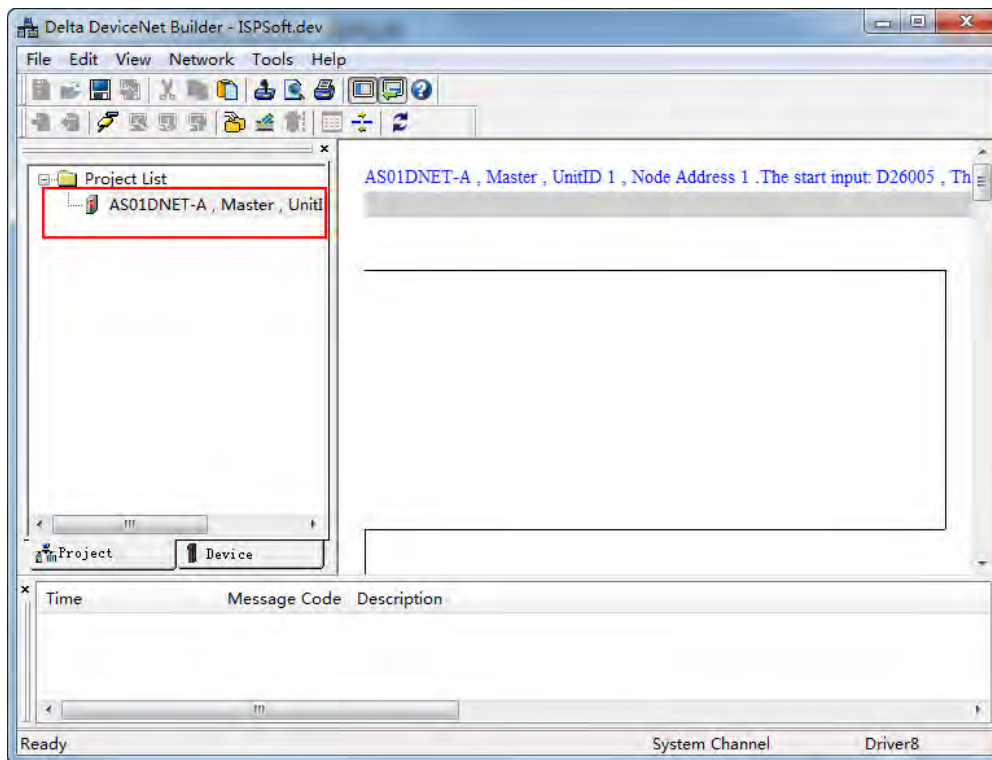

6. Click **Network >> Scan DeviceNet Network**.

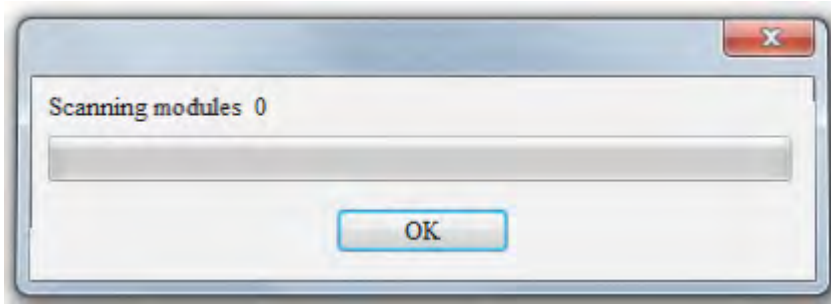

7. After online is implemented, click the **Scan DeviceNet Network** button to start scanning the nodes in the network.

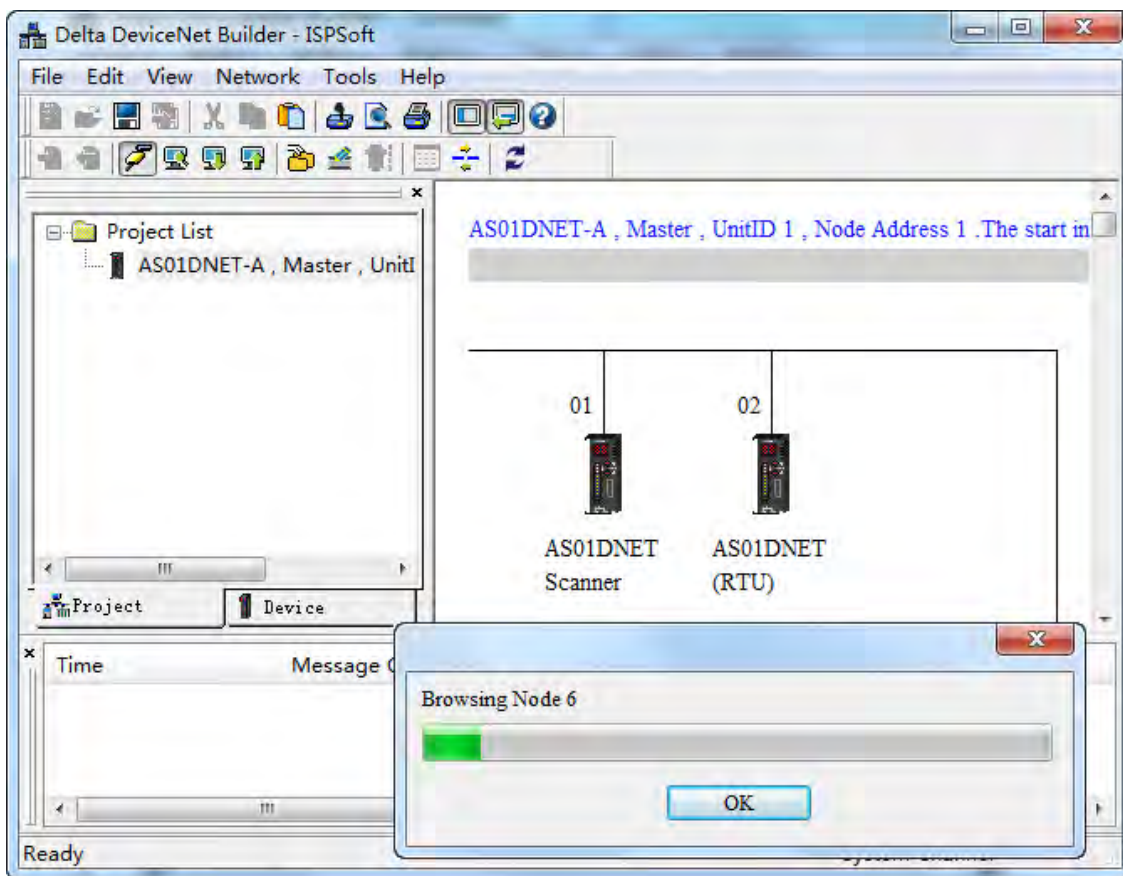

11.5.4.2.2. Main Configuration Page of AS01DNET (RTU)

1. After scanning is finished, double click the AS01DNET (RTU) node in the network. Then the **Node Configuration...** window comes out. The polled transmission is supported with default input data size of 2 bytes and output data size of 2 bytes which are mapping address lengths of control word and status word of AS01DNET (RTU) respectively.

Input Size and **Output Size** under **Polled Setting** mean the lengths of AS01DNET (RTU) parameters which are mapped in the master.

Node Configuration...

Address: 2 Name: AS01DNET (RTU)

Node information

Vendor ID: 799
Device Type: 12
Product Code: 12320
Major Rev: 1
Min Rev: 1

Polled Setting

Input Size: 2 Bytes
Output Size: 2 Bytes

Bit-Strobe Setting

Input Size: 0 Bytes

Key Parameters setting

Vendor
 Device Type
 Product Code
 Major Rev
 Min Rev

COS/CC Setting

COS CC

Input Size: 0 Bytes
Output Size: 0 Bytes
Heartbeat: 250 ms
Ack Timeout: 16 ms
Inhibit Time: 1 ms

IO Configure... OK Cancel

2. Click the **I/O Configure...** button in the **Node Configuration...** window. Then the main configuration page appears as below.

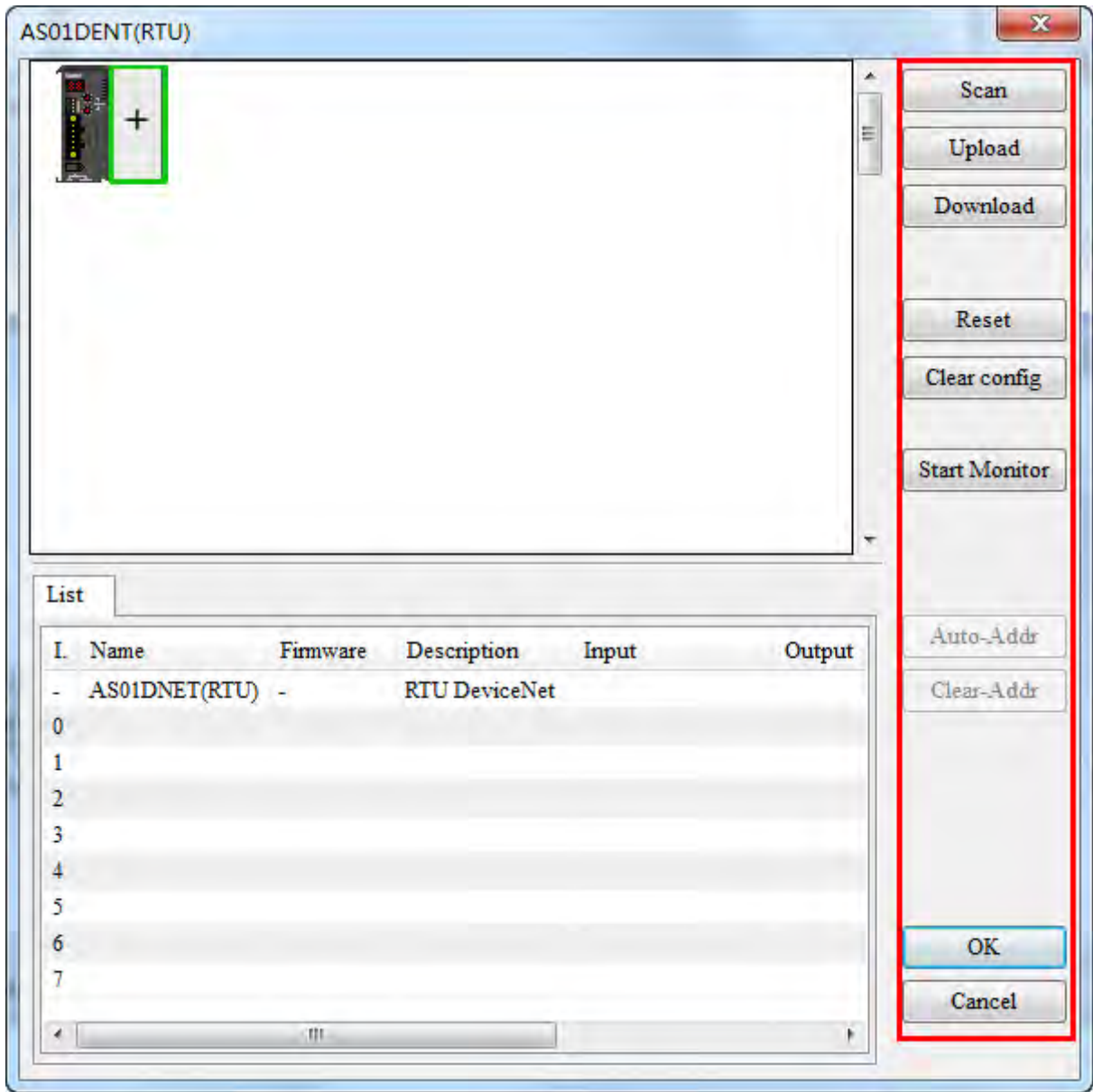

Explanation of parameters on the AS01DNET (RTU) configuration page

Item	Description
Scan	All I/O modules currently connected to the right side of AS01DNET (RTU) are scanned. The existing modules in the software will be compared with the actually connected I/O module. The mismatched one will be displayed in an abnormal icon.
Upload	Upload and show the configuration data including I/O list, I/O configuration, parameter mapping and basic control information in AS01DNET (RTU) in the software.
Download	Download current AS01DNET (RTU) configuration including I/O list, I/O configuration, parameter mapping and basic control information to AS01DNET (RTU), which is retained when the power is turned off.
Reset	Make the connected AS01DNET (RTU) restart.
Clear config	Clear the configuration data stored in the latched area and automatically reset the configuration. Then the indicator displays F1.

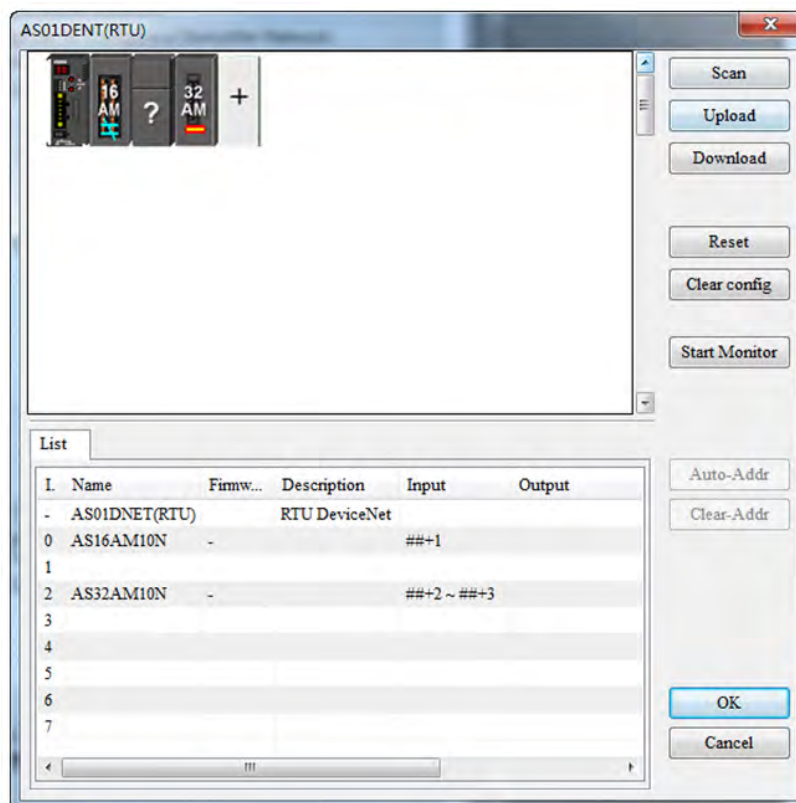

Item	Description
Start Monitor	Watch and set in real time the configured exchange data in current system; change output data, watch input data and use control word to control the operation state of AS01DNET (RTU) in real time.
Name	Name of each module
Firmware	Firmware version of each module. Choosing corresponding version of firmware, download the module parameter information which matches the firmware version.
Description	The description of basic information of each module.
Input	The mapping range of input data of each module, determined by start address offset of mapping input data and the size.
Output	The mapping range of output data of each module, determined by start address offset of mapping output data and the size.
Comment	Add a comment for each I/O modules
OK	The current configuration data will not be saved until you click the OK button to finish the configuration.
Cancel	Clicking the Cancel button to exit AS01DNET (RTU) configuration page, current configuration data will not be saved.

3. Clicking the **Scan** button on the page, the main AS01DNET (RTU) configuration page changes as below.



After the I/O modules connected to AS01DNET (RTU) are scanned, abnormal icons may appear.

Here is the list of abnormal icons.

	<p>The I/O module configured in the software does not match the current I/O module actually connected, e.g. the software configuration is AS32AM, but the actually connected module is AS16AP. So the abnormal icon such as left-side icon will appear after the scan. You can change it into current configuration icon with double clicks on it.</p>
	<p>The I/O module in the software configuration does not exist in the actual connection, e.g. the software configuration is AS32AM, but it has not been connected actually. So the abnormal icon such as left-side icon will appear after the scan. You can change it into current configuration icon with double clicks on it.</p>
	<p>AS01DNET (RTU) scans an unknown module. Right click current icon to select Change from the menu which appears to change it into a module icon which can be recognized for configuration.</p>

11.5.4.2.3. AS01DNET (RTU) Parameters Setup Page

After I/O modules are scanned, the main configuration interface changes as follows.

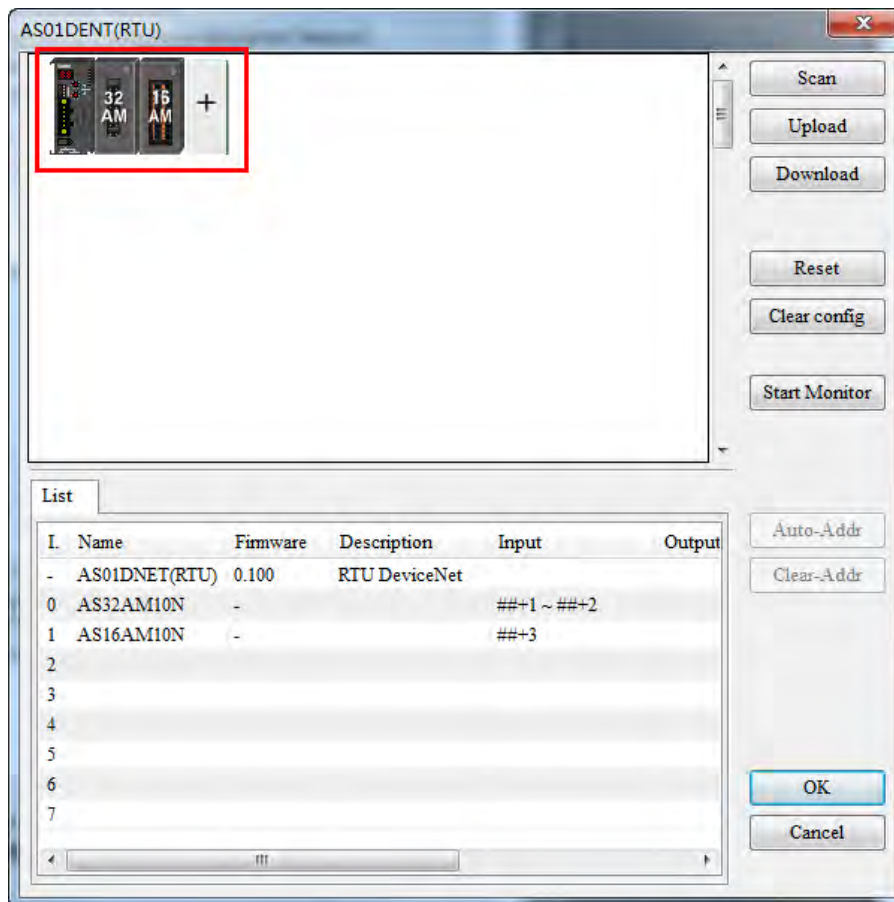

Double click **AS01DNET (RTU)** icon on the far left of the configuration page. Then the parameter setting interface of AS01DNET (RTU) comes out for setting the error handling method as follows.

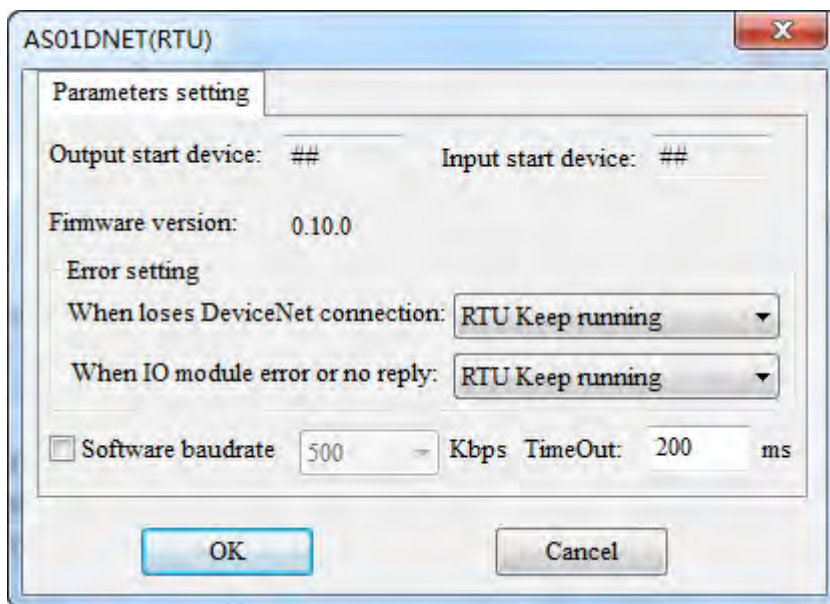

Explanation of AS01DNET (RTU) parameter setup:

Item	Description	Default
Output start address	The start output address of AS01DNET (RTU), occupying one word.	None
Input start address	The start input address of AS01DNET (RTU), occupying one word.	None
When loses DeviceNet connection	AS01DNET (RTU)'s error handling method when AS01DNET (RTU) and DeviceNet master are disconnected. "RTU keep running" and "RTU stop" are for option.	RTU keep running
When IO module error or no reply	AS01DNET (RTU)'s error handling method when an error occurs in any one of I/O modules connected to the right side of AS01DNET (RTU). "RTU keep running" and "RTU stop" are for option.	RTU keep running
Software baud rate	Chooses the extension baud rate of AS01DNET (RTU) after ticking the checkbox of it. The selected baud rate is stored in AS01DNET (RTU) after the download and it will not take effect until the hardware switch of AS01DNET (RTU): DR1 and DR0 are both ON. Refer to Section 11.2.6 for details on function switch.	None
Firmware version	Displays the firmware version of AS01DNET (RTU).	None

11.5.4.2.4. I/O Module Configuration Page

The mapping parameters of each module can be set through double clicks on the selected I/O module icon on the following interface.

11

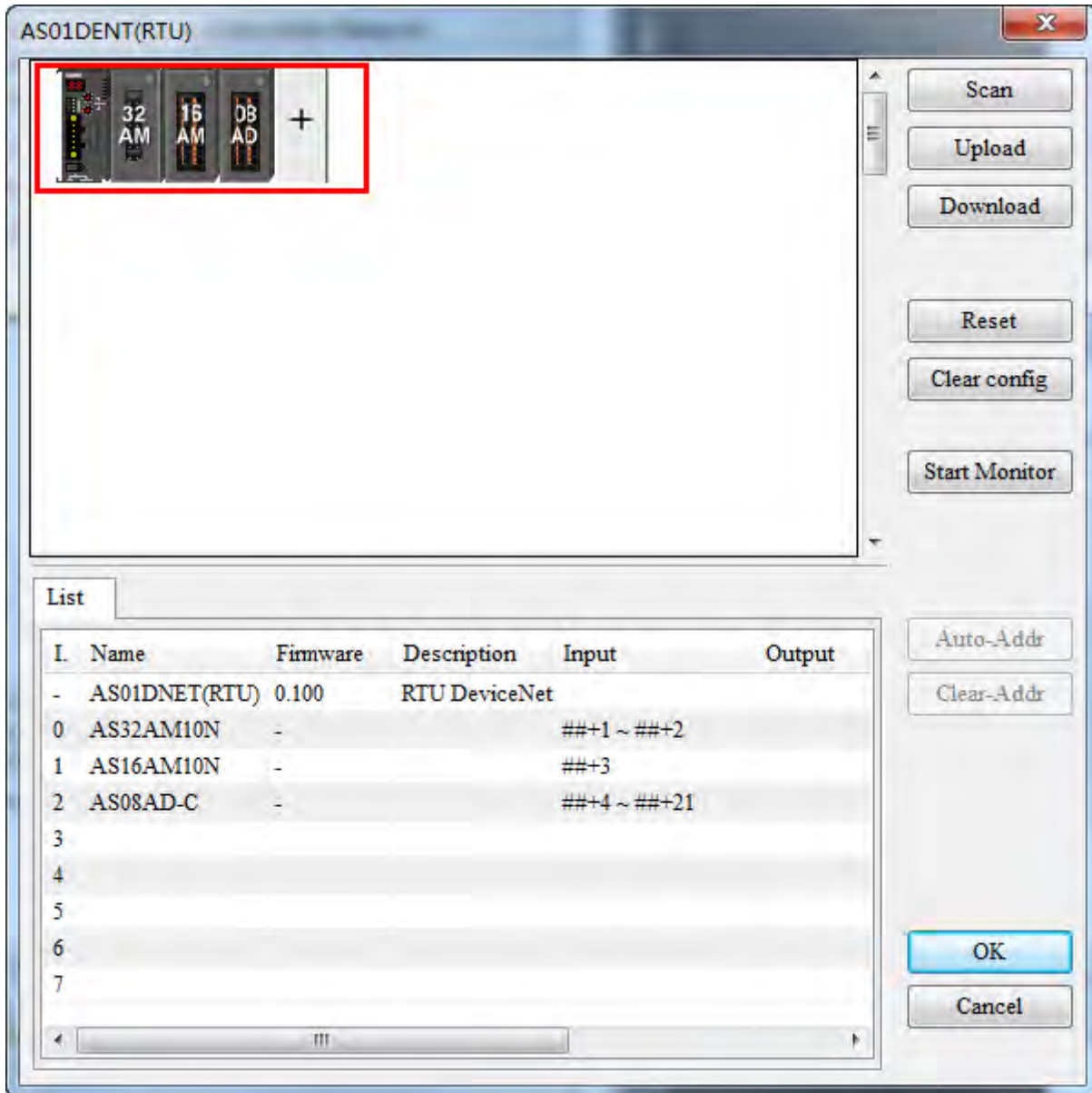

Double click the 08AD icon. Then the AS08AD-C configuration interface appears as below for configuration of parameter mapping of AS08AD-C module.

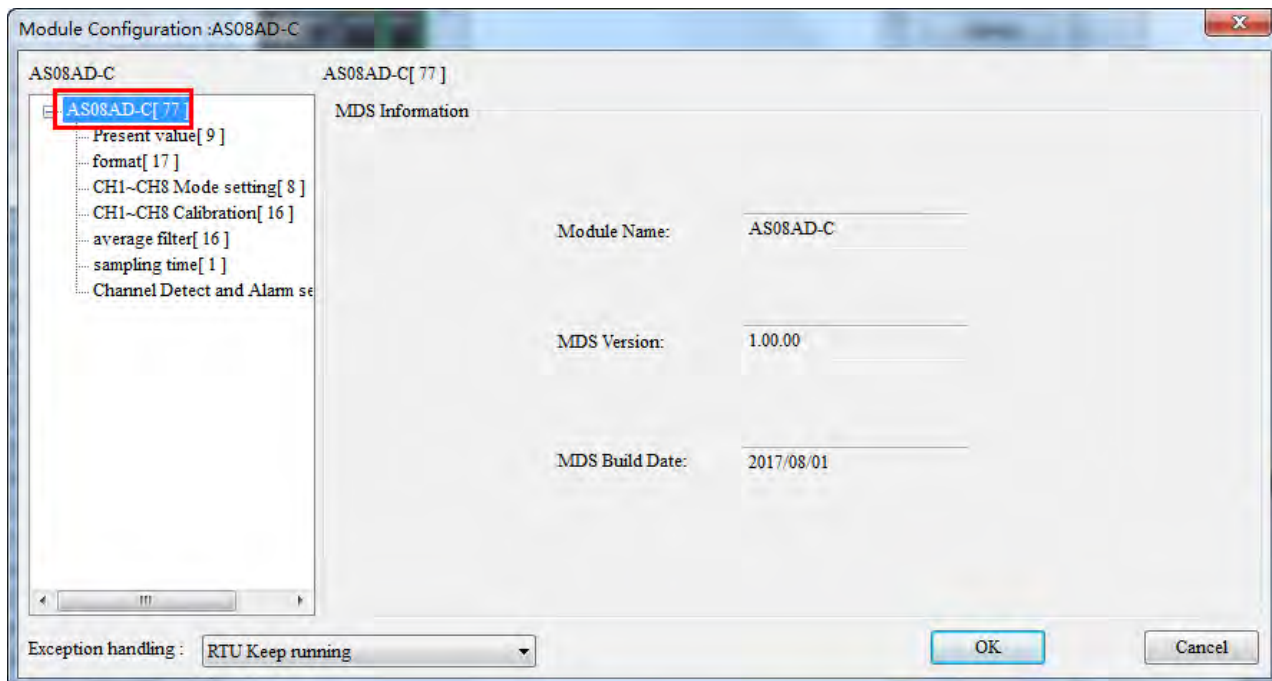

Explanation of I/O module configuration interface:

Item	Description
MDS information	Displays module name, MDS version and creation date. The module parameters will be shown in the left-side window based on the MDS file. For explanation of module parameters, refer to the relevant module manual.
I/O parameter list	Displays all module parameters read from the MDS file of the module. Set up these parameters to control the operation of the module.
Exception handling	The error handling of AS01DNET (RTU) when AS01DNET (RTU) detects that an error occurs in the module. "RTU keep running" or "RTU stop" can be selected as the solution to the error.

Generally, the settings for I/O module parameters and device mappings can be made in the following three cases.

Case 1: Select one appropriate parameter value from the drop-down list in the **Initial** column, e.g. select -20mA~+20mA as channel 1 input mode of AS08AD-C.

11

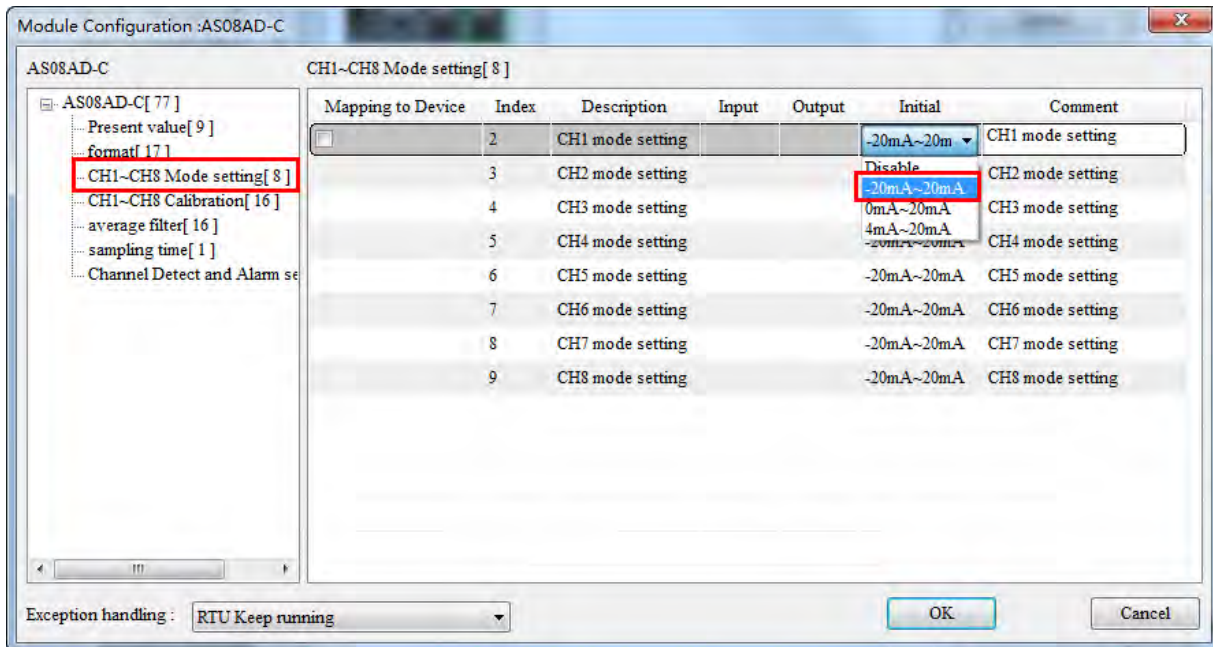

Case 2: Manually enter the value for the parameter to change in the Initial column, e.g. write 100 for CH1 Cal.Offset of AS08AD-C).

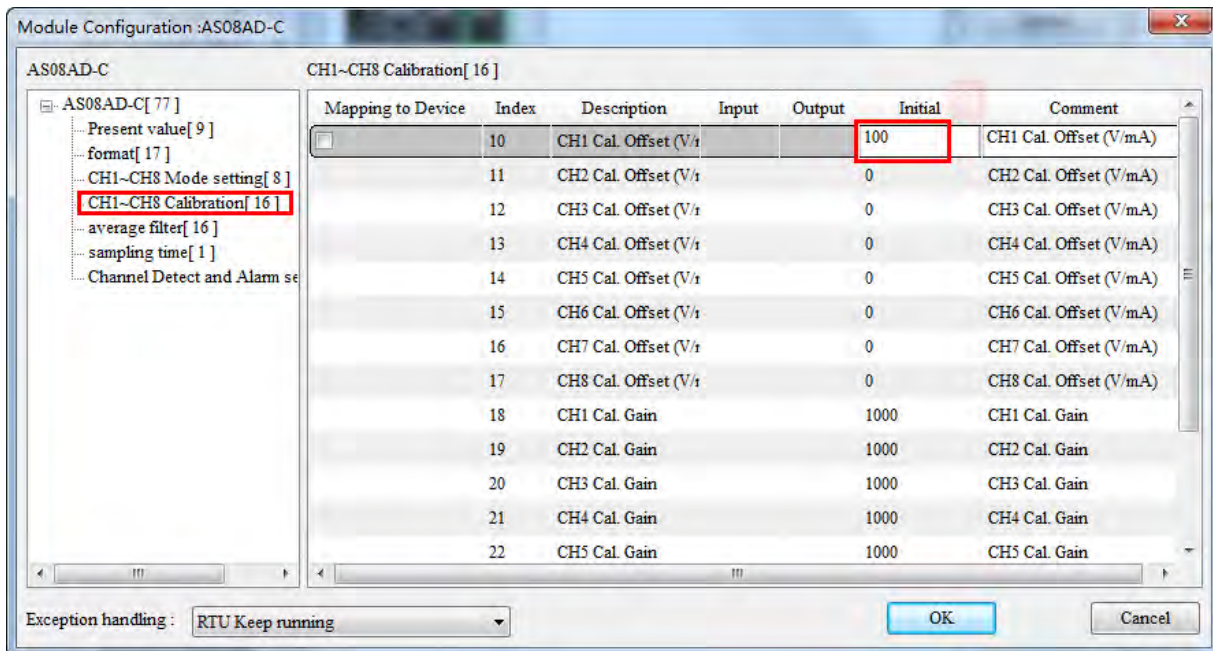

Case 3: For the module parameter which need be monitored in real time or need be modified in its value, tick the desired parameter in the **Mapping to Device** column and then the corresponding value of the parameter will map to the bus data for exchange i.e. the D registers in PLC. After the values of the ticked parameters in the **Mapping to Device** column go to the software monitor page, the current values of parameters can be monitored and modified in real time.

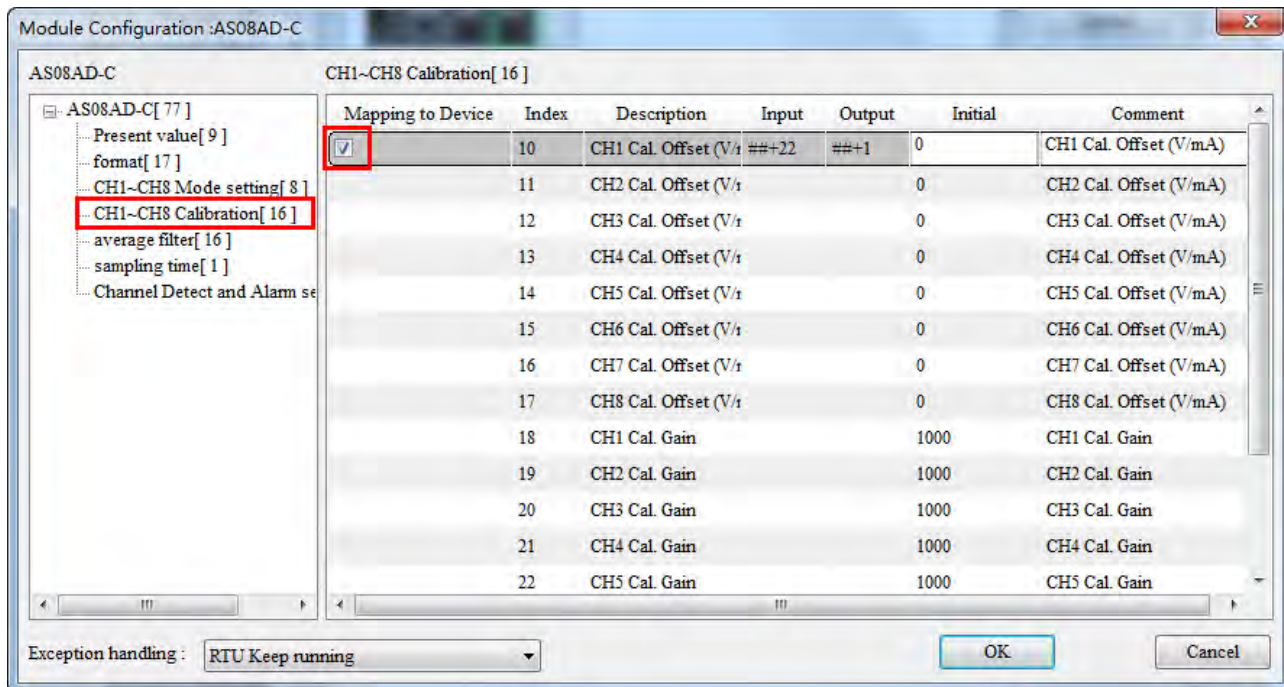

● **Explanation of IO module parameters**

Double click the icon of AS08AD-C module. Then the **Module Configuration: AS08AD-C** dialog box comes out as below.

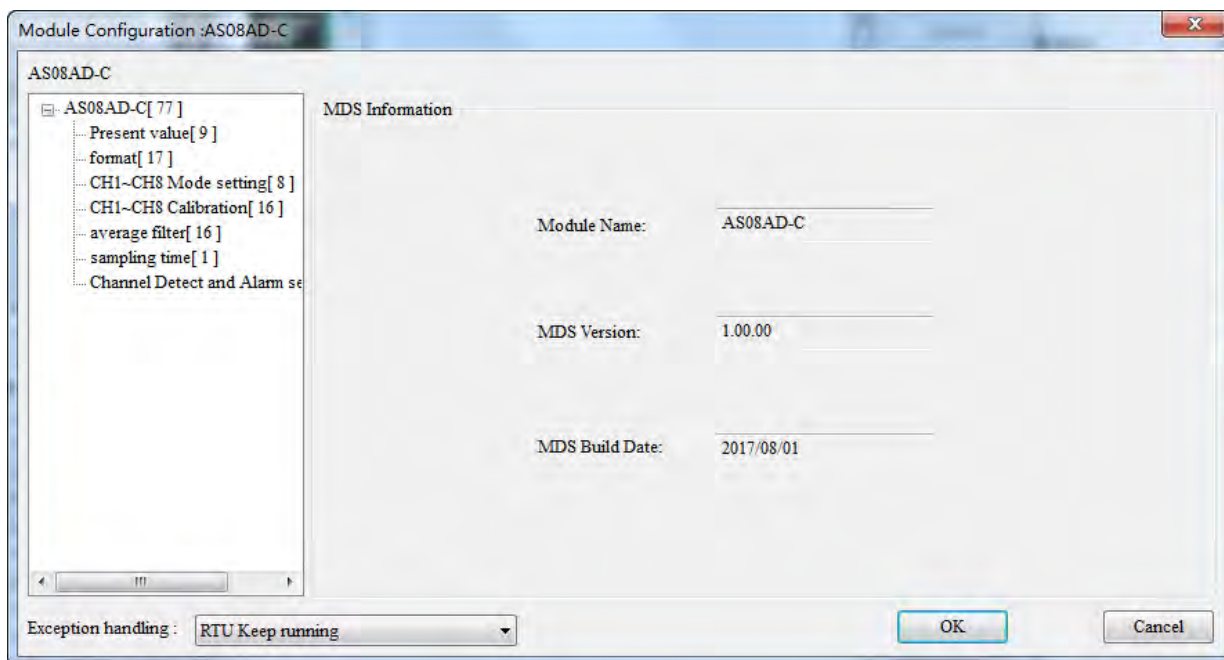

MDS information of AS08AD-C

11

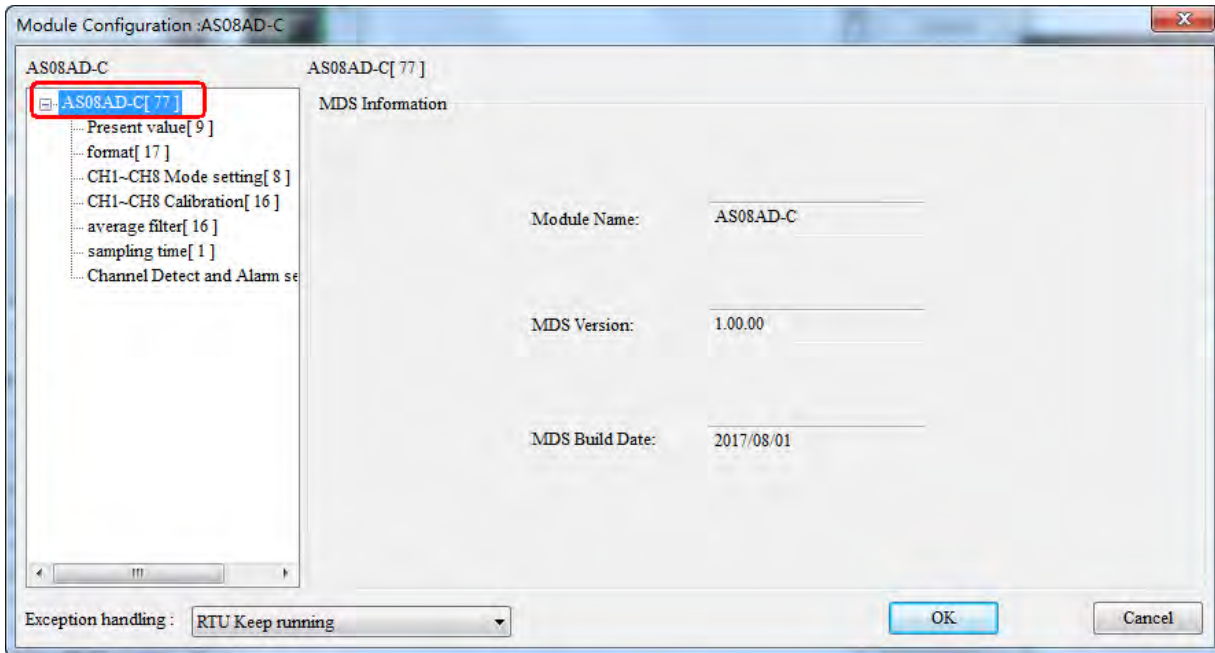

Present value setting

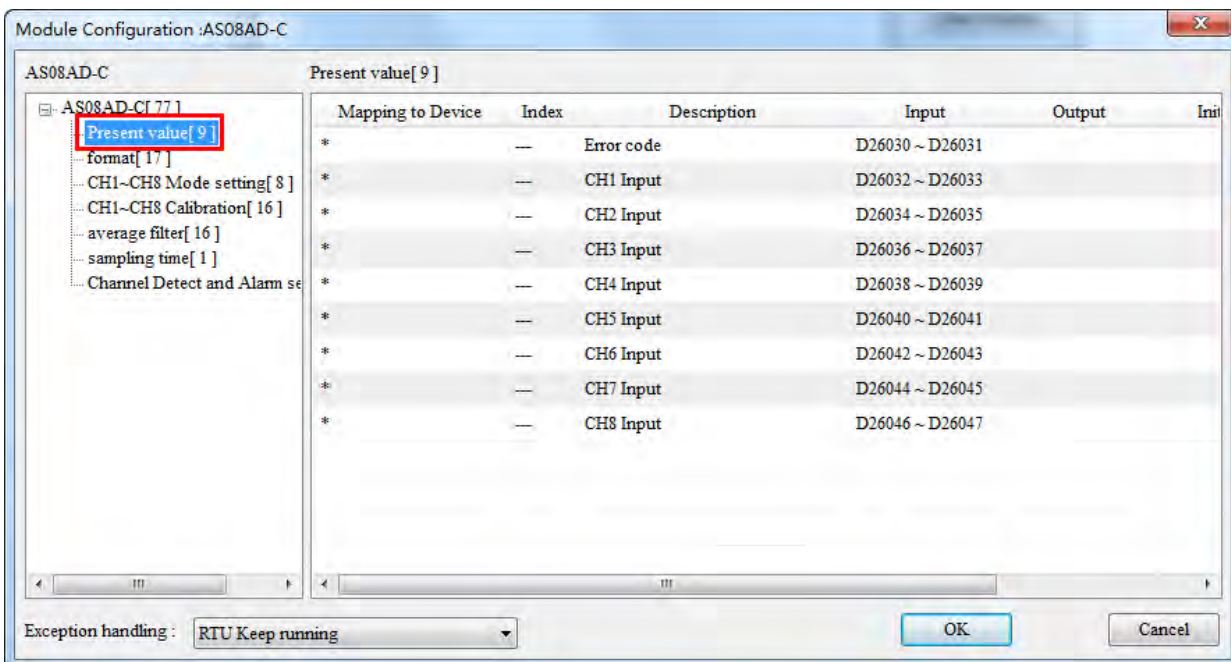

Format setting (Integer format and Float format for option)

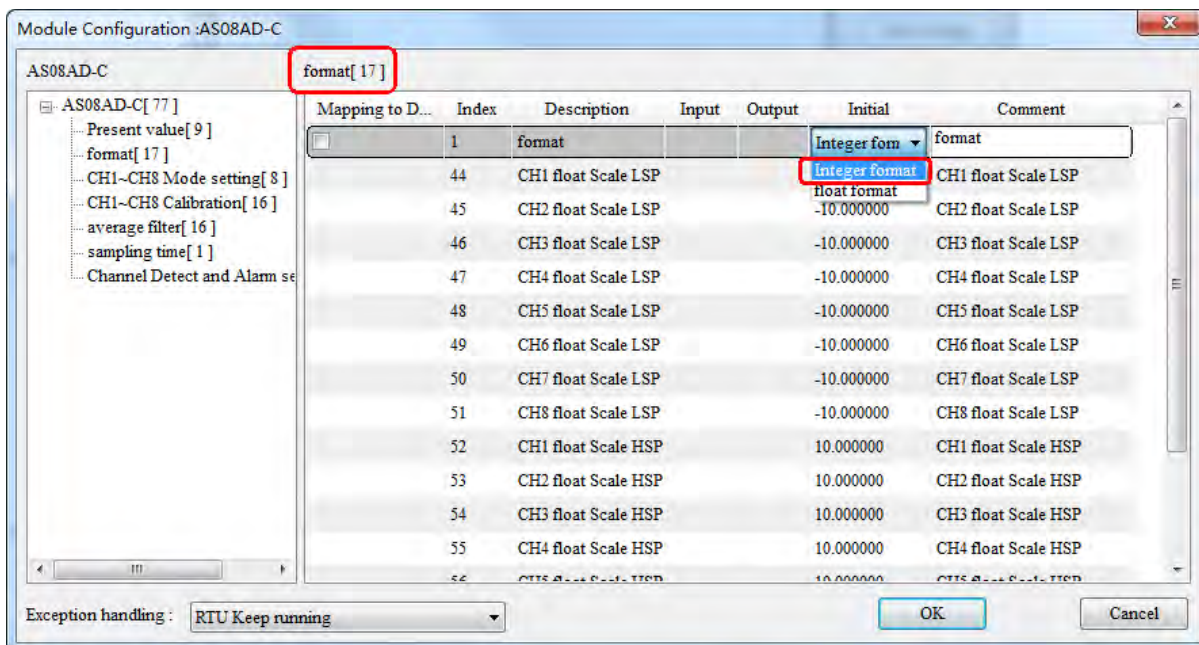

11

CH1~CH8 Mode setting 【8】

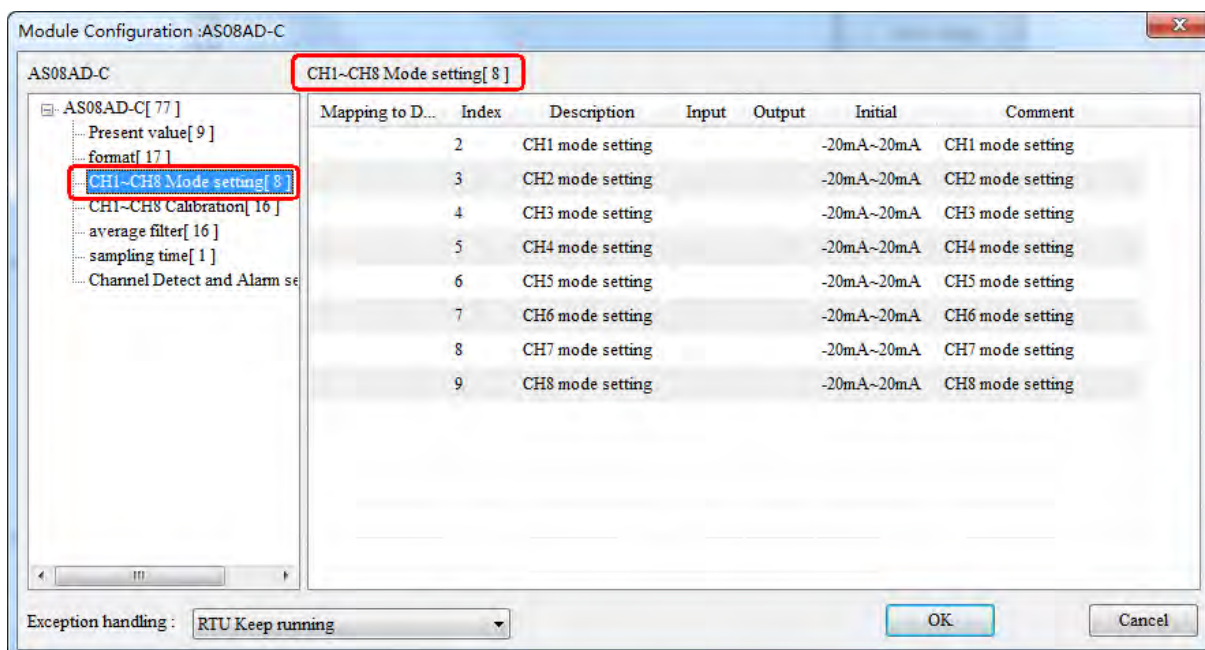

CH1~CH8 Calibration 【16】

11

Module Configuration :AS08AD-C

AS08AD-C

CH1-CH8 Calibration[16]

Mapping to D...	Index	Description	Input	Output	Initial	Comment
	10	CH1 Cal. Offset (V/mr)			0	CH1 Cal. Offset (V/m.A)
	11	CH2 Cal. Offset (V/mr)			0	CH2 Cal. Offset (V/m.A)
	12	CH3 Cal. Offset (V/mr)			0	CH3 Cal. Offset (V/m.A)
	13	CH4 Cal. Offset (V/mr)			0	CH4 Cal. Offset (V/m.A)
	14	CH5 Cal. Offset (V/mr)			0	CH5 Cal. Offset (V/m.A)
	15	CH6 Cal. Offset (V/mr)			0	CH6 Cal. Offset (V/m.A)
	16	CH7 Cal. Offset (V/mr)			0	CH7 Cal. Offset (V/m.A)
	17	CH8 Cal. Offset (V/mr)			0	CH8 Cal. Offset (V/m.A)
	18	CH1 Cal. Gain			1000	CH1 Cal. Gain
	19	CH2 Cal. Gain			1000	CH2 Cal. Gain
	20	CH3 Cal. Gain			1000	CH3 Cal. Gain
	21	CH4 Cal. Gain			1000	CH4 Cal. Gain
	22	CH5 Cal. Gain			1000	CH5 Cal. Gain
	23	CH6 Cal. Gain			1000	CH6 Cal. Gain

Exception handling : RTU Keep running

OK Cancel

Average filter setting 【16】

Module Configuration :AS08AD-C

AS08AD-C

average filter[16]

Mapping to D...	Index	Description	Input	Output	Initial	Comment
	26	CH1 average times			10	CH1 average times
	27	CH2 average times			10	CH2 average times
	28	CH3 average times			10	CH3 average times
	29	CH4 average times			10	CH4 average times
	30	CH5 average times			10	CH5 average times
	31	CH6 average times			10	CH6 average times
	32	CH7 average times			10	CH7 average times
	33	CH8 average times			10	CH8 average times
	34	CH1 filter Proportion			10%	CH1 filter Proportion
	35	CH2 filter Proportion			10%	CH2 filter Proportion
	36	CH3 filter Proportion			10%	CH3 filter Proportion
	37	CH4 filter Proportion			10%	CH4 filter Proportion
	38	CH5 filter Proportion			10%	CH5 filter Proportion
	39	CH6 filter Proportion			10%	CH6 filter Proportion

Exception handling : RTU Keep running

OK Cancel

Sampling time

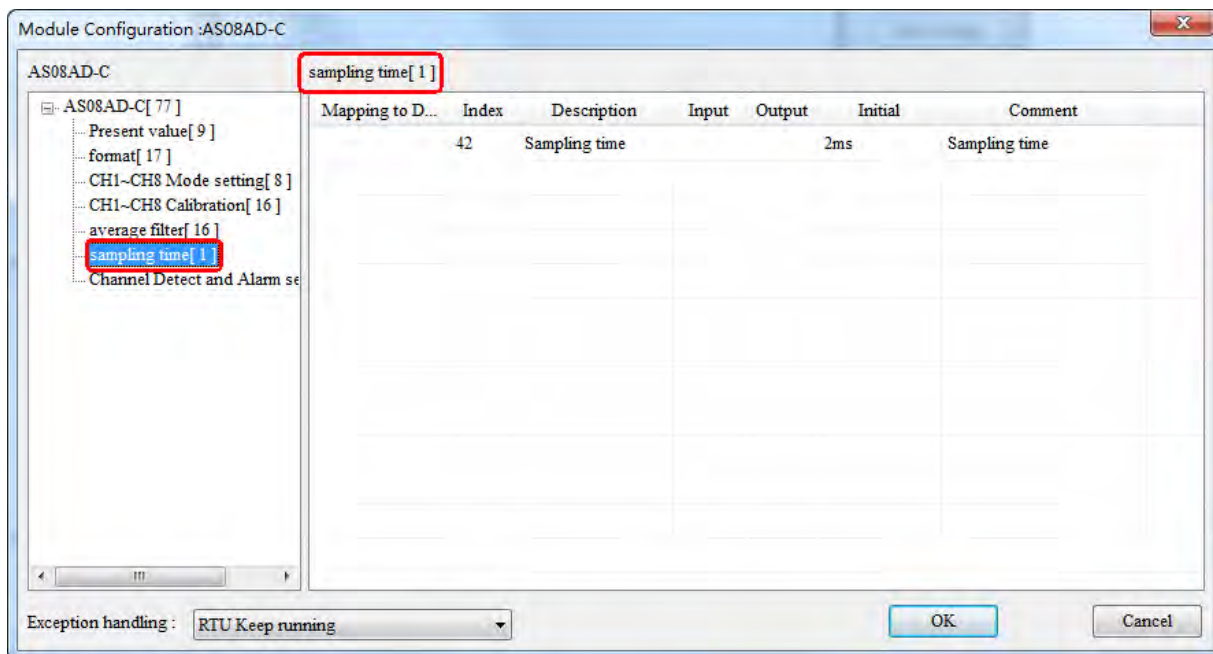

11

Channel Detect and Alarm settings

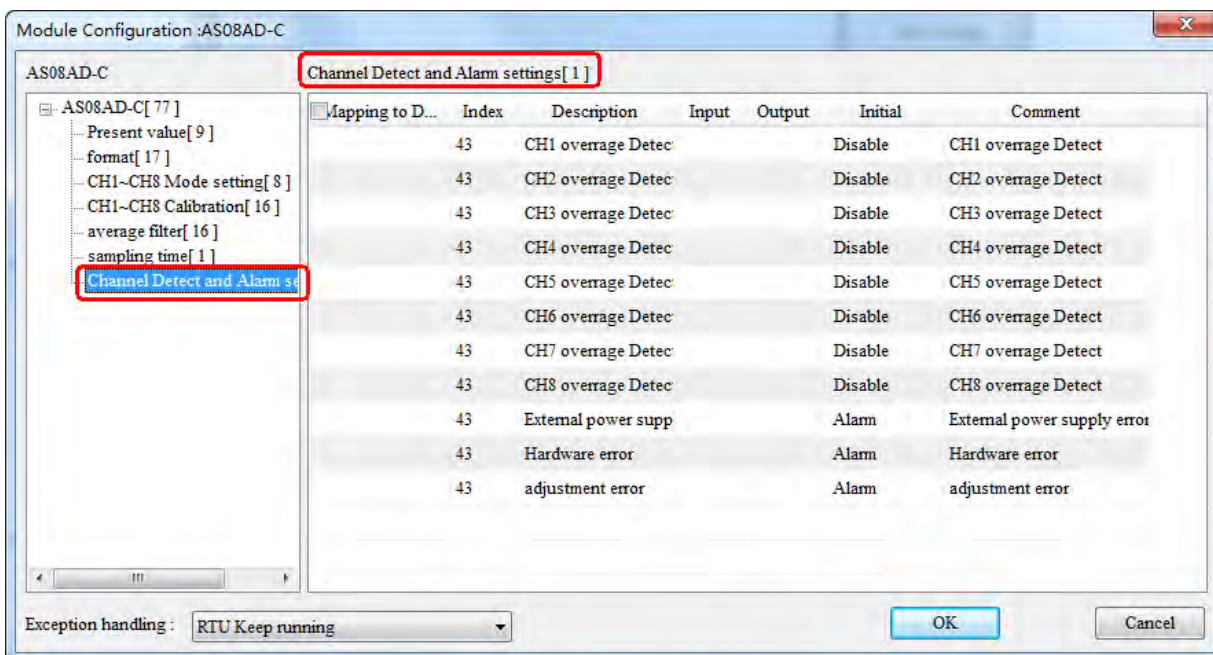



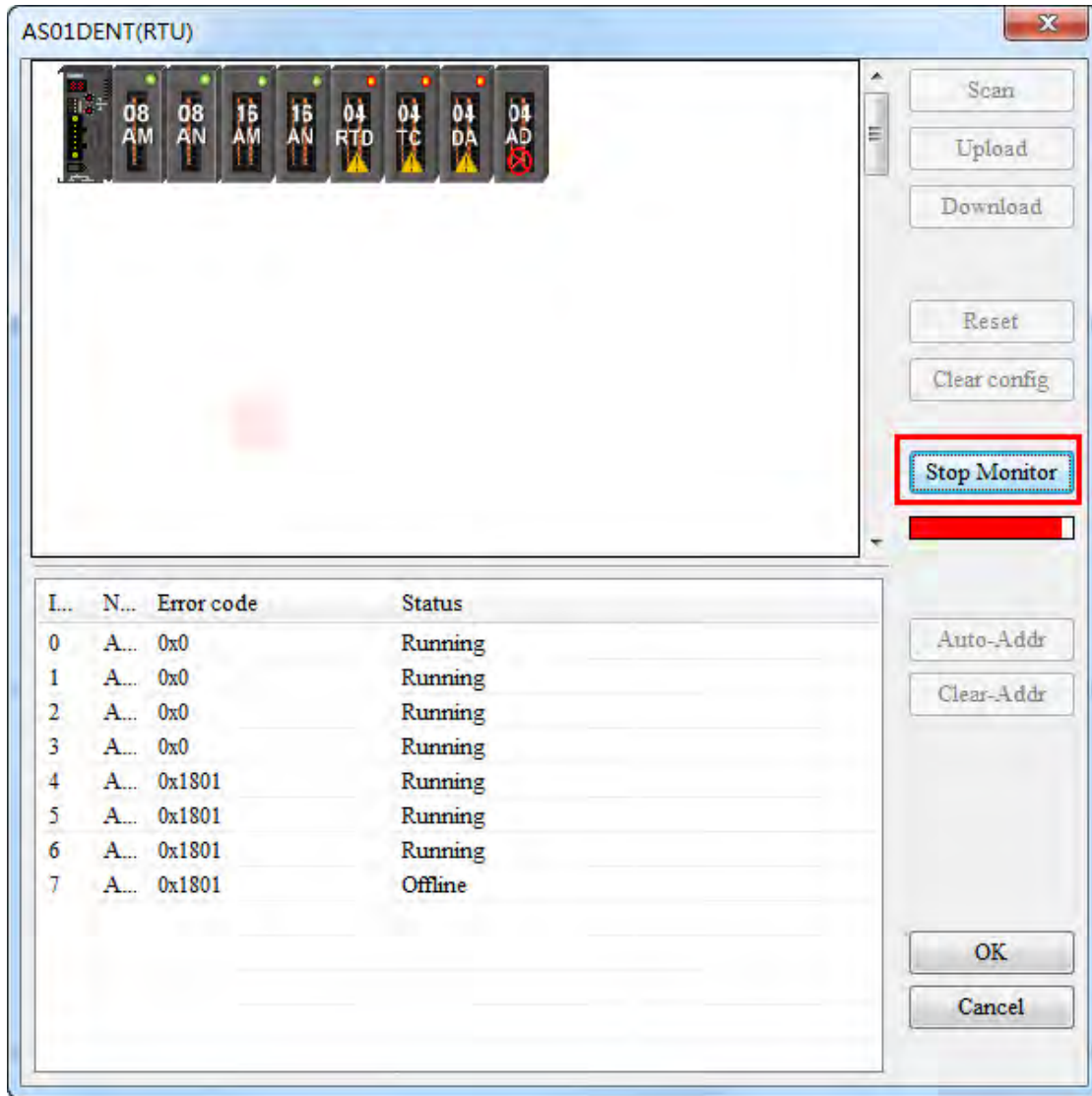

11.5.4.2.5. Monitor Function of the Software

When the software is in online mode and current configuration in AS01DNET (RTU) is the same as that stored in the software, click the **Start Monitor** button to enter the monitor interface and start to monitor the operation states of AS01DNET (RTU) and I/O modules in real time.

11



The list of operation state of modules:

	Indicates that the module is in the normal operation.
	Indicates that the module is in the Stop state.
	Indicates that the module is in the warning or error state. For details on errors, refer to explanation of error codes in the related product manual.
	Indicates that the actually connected module does not match the module configured in the software or currently configured module has been disconnected.

On the following interface, right click the selected module icon and select RUN or Stop from the drop-down box to change the operation state of the I/O module.

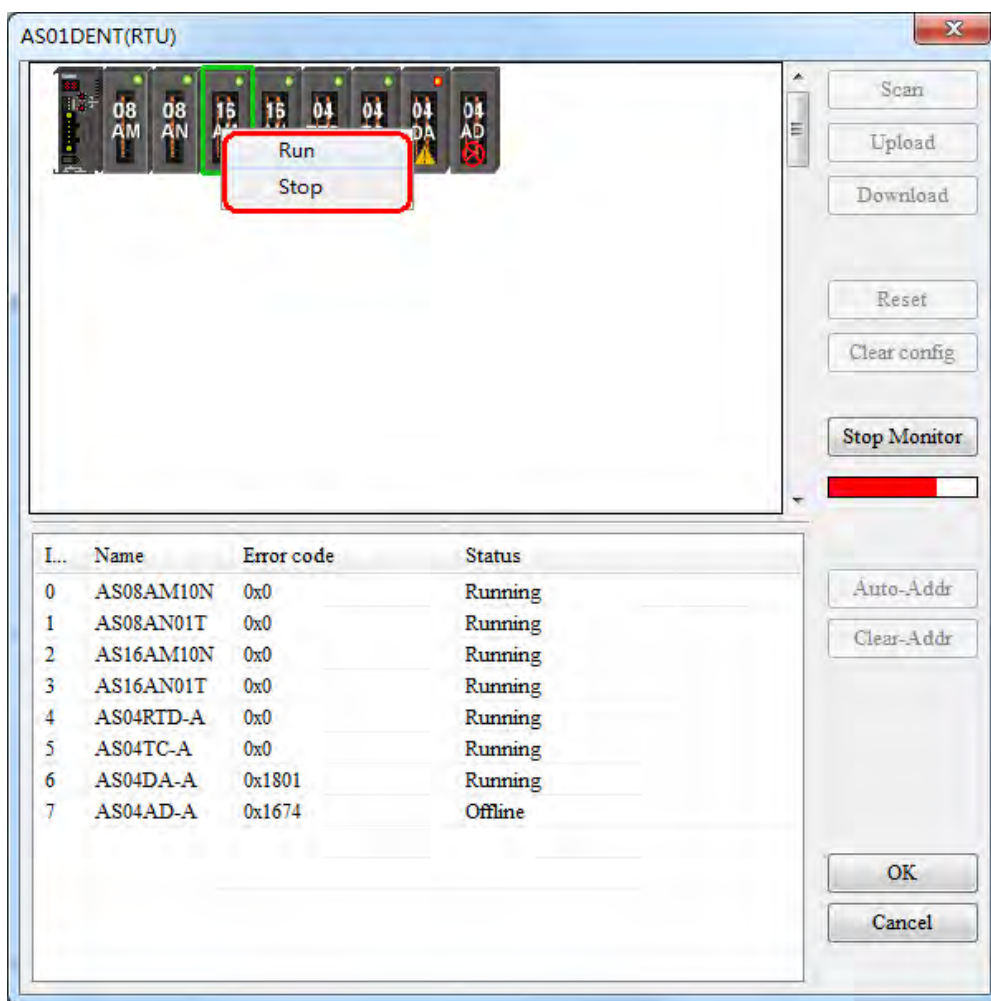

11.5.4.3. DeviceNet Mapping Data

The model of the entire mapping data exchange is displayed below and eventually data will map to the registers in the PLC of the master.

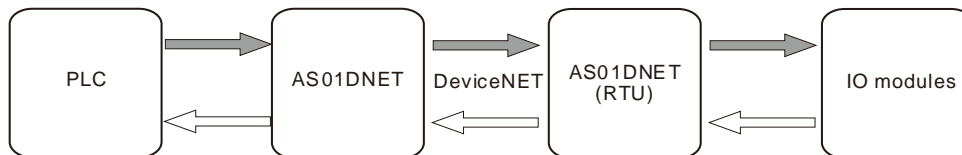

Note: All mapping addresses mentioned below means the D registers in the PLC.

The start input address and start output address of AS01DNET (RTU) are assigned automatically by the master when AS01DNET (RTU) is added to the master. The input mapping address length and output mapping address length of AS01DNET (RTU) are determined by the configuration of modules connected to AS01DNET (RTU).

The start input and output mapping addresses of one I/O module are assigned automatically by the software. Its input mapping address length and output mapping address length are determined by the configuration of the module. The range of input / output mapping address is limited by the input / output mapping address range of AS01DNET (RTU).

11.5.4.3.1. The Rule for Assignment of Mapping Addresses by AS01DNET Master

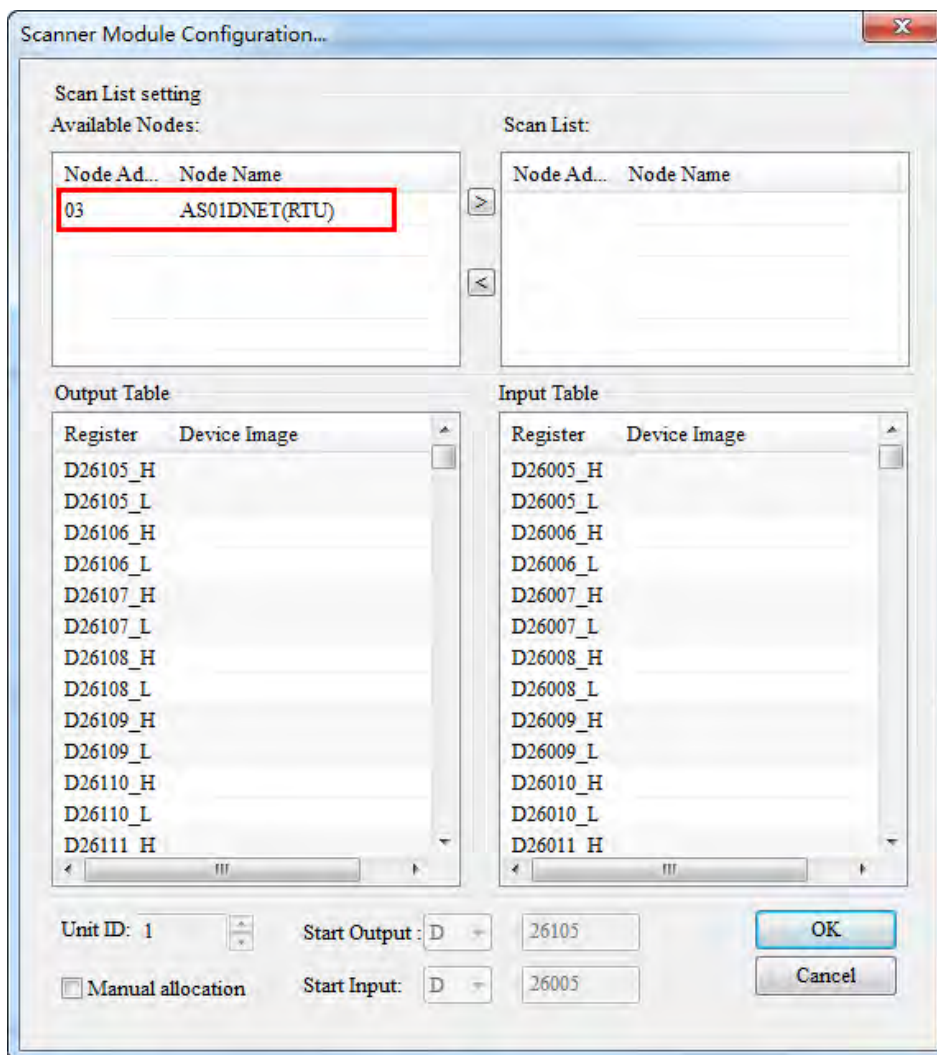

Data mapping areas are assigned according to the following table.

Input area: Slave ⇒ Master			Output area: Master ⇒ Slave		
Register in AS PLC	Purpose	Data size	Register in AS PLC	Purpose	Data size
D26000~D26003	Scan-list node state indication area	4 words	D26100~D26103	Bit-strobe command area	4 words
D26004	Scanner module state indication area	1 word	D26104	Reserved	1 word
D26005~D26099	DeviceNet input data area; for receiving state data back from slaves	95words	D26105~D26199	DeviceNet output area; the data in the registers will be sent to slaves as control data.	95 words

11

11.5.4.3.2. The Rule for Assignment of Mapping Addresses for AS01DNET (RTU)

The start input and start output mapping addresses of AS01DNET (RTU) are assigned automatically by the master when AS01DNET (RTU) is added to the master. The master assigns mapping addresses of AS01DNET (RTU) according to input mapping address length and output mapping address length. Input mapping address length and output mapping address length are determined by the configuration parameters of all modules connected to AS01DNET (RTU). The start addresses of AS01DNET (RTU) will not be assigned until AS01DNET (RTU) is added to the master and they are related to the order of adding slaves to the master.

When there are two slaves of AH10DNET and AS01DNET (RTU), the input size and output size of AH10DNET are both 4 bytes and the input size and output size of AS01DNET (RTU) are both 4 bytes. If AS01DNET (RTU) is added to the master before AH10DNET is added to the master, then the input mapping addresses and output mapping addresses of AS01DNET (RTU) are respectively D26005~D26006 and D26105~D26106 as below. D26005 and D26105 are respectively the start input mapping address and start output mapping address, i.e. status word and control word of AS01DNET (RTU). The registers after start input mapping address and start output mapping address are for mapping the configuration parameters of I/O modules.

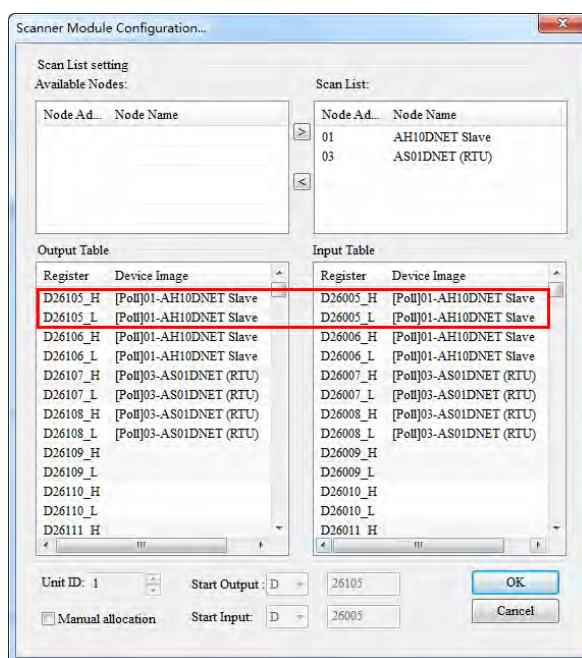

If AS01DNET (RTU) is added to the master after AH10DNET is added to the master, then the input mapping addresses and output mapping addresses of AS01DNET (RTU) are respectively D26007~D26008 and D26107~D26108 as below. D26007 and D26107 are respectively the start input mapping address and start output mapping address, i.e. status word and control word of AS01DNET (RTU). The registers after start input mapping address and start output mapping address are for mapping the configuration parameters of I/O modules.

11

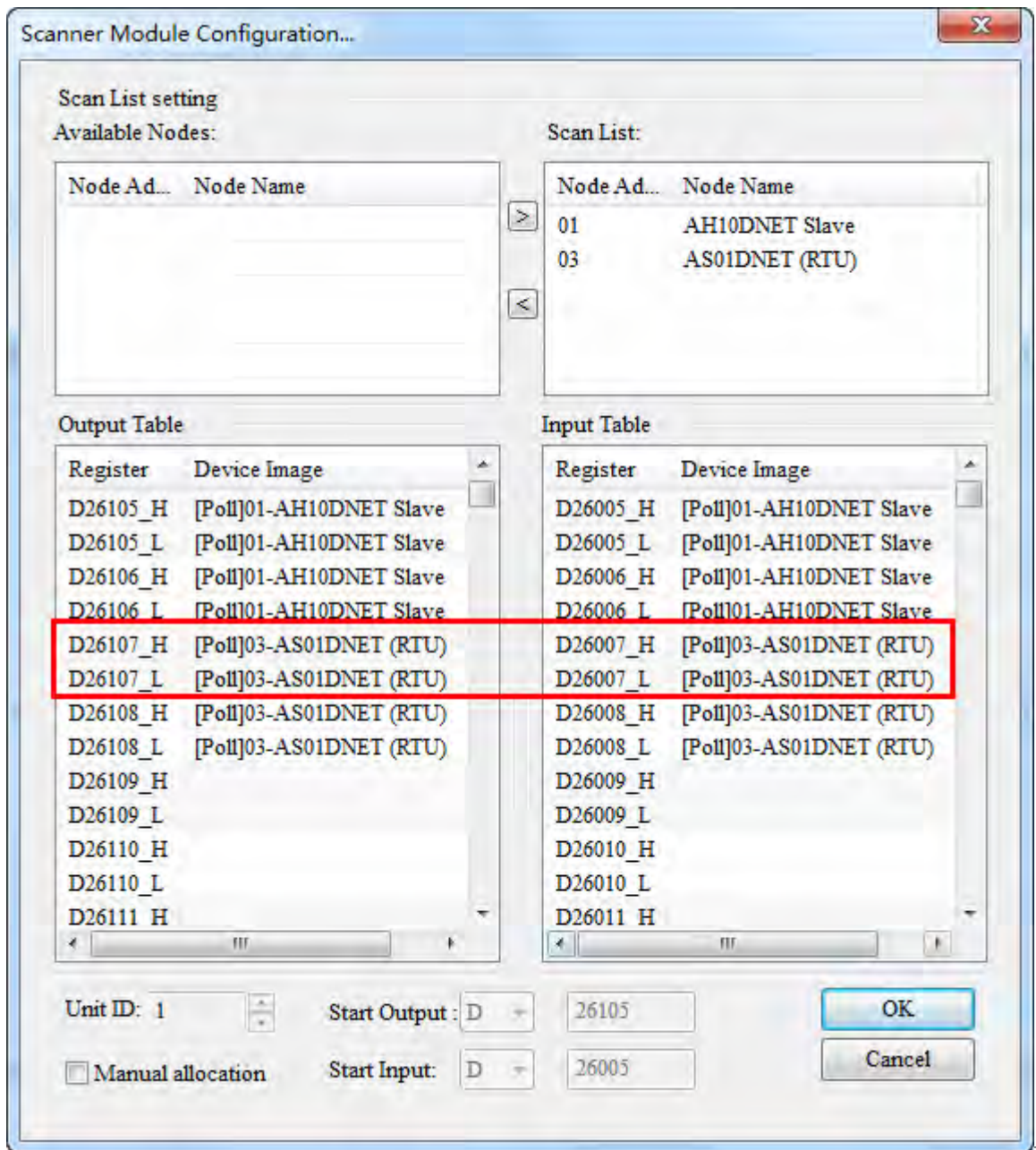

11.5.4.3.3. The Rule for Assignment of Mapping Addresses for I/O Modules

Each module has two forms of data mapping. When DeviceNet master has not assigned the start input mapping address and start output mapping address to AS01DNET (RTU), the contents in **Input** and **Output** in the following figure represent offsets based on start input or start output mapping address of AS01DNET (RTU). After DeviceNet master has assigned the start input mapping address and start output mapping address to AS01DNET (RTU), the contents in **Input** and **Output** in the following figure represent mapping addresses of parameters in the modules on the right of AS01DNET (RTU).

When AS01DNET (RTU) is added to **Scan List** on the page of **Scanner Module Configuration...**, DeviceNet master assigns start input and output mapping addresses to AS01DNET (RTU). When AS01DNET (RTU) is removed from **Scan List** on the page of **Scanner Module Configuration...**, the start input and start output mapping addresses of AS01DNET (RTU) are unknown.

Before the master assigns mapping addresses to AS01DNET (RTU), the device mappings of modules connected to the right side of AS01DNET (RTU) are displayed as below.

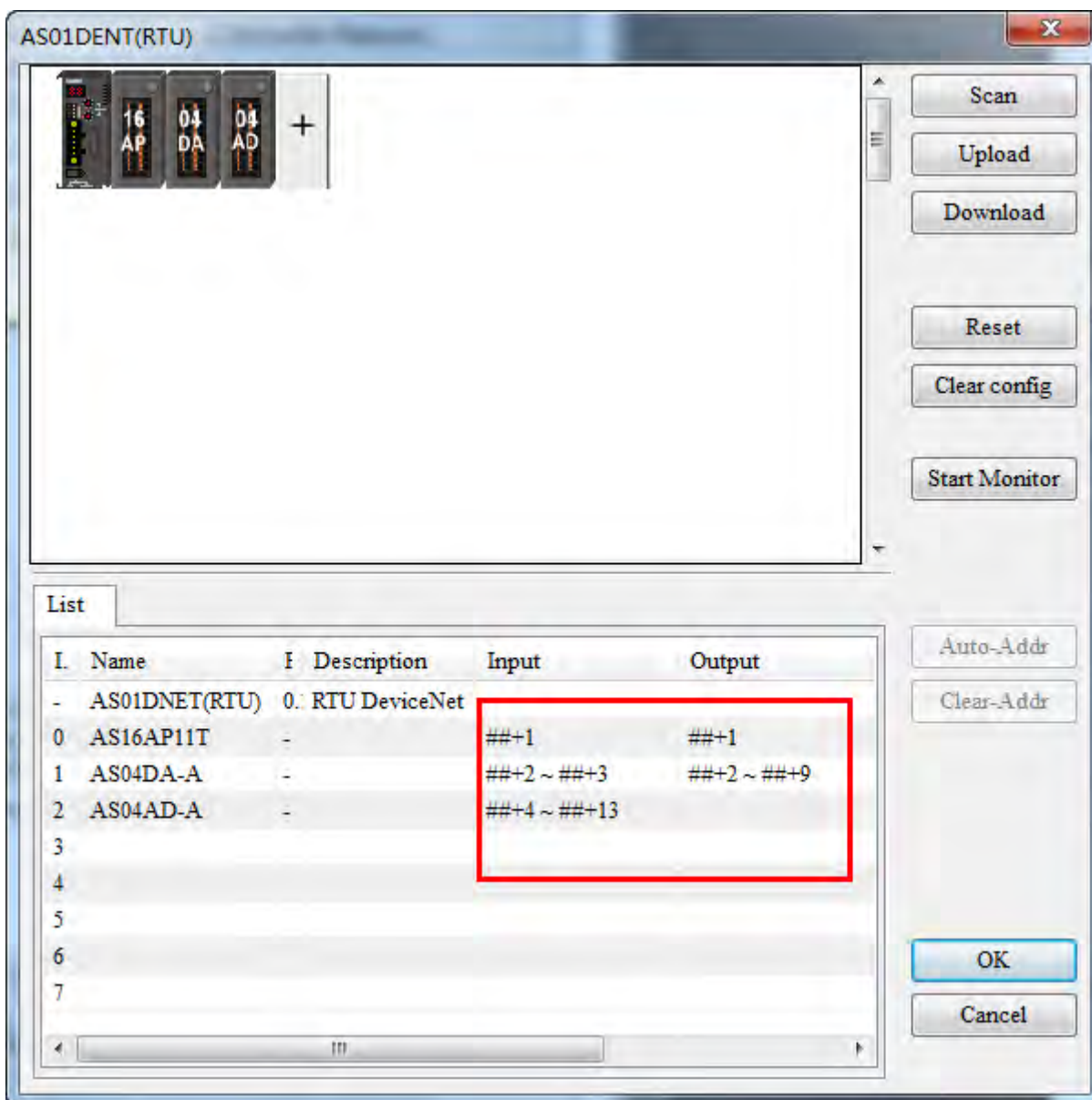

After AS01DNET (RTU) is pulled into **Scan List**, the mapping addresses that the master assigns to AS01DNET (RTU) are shown as below.

11

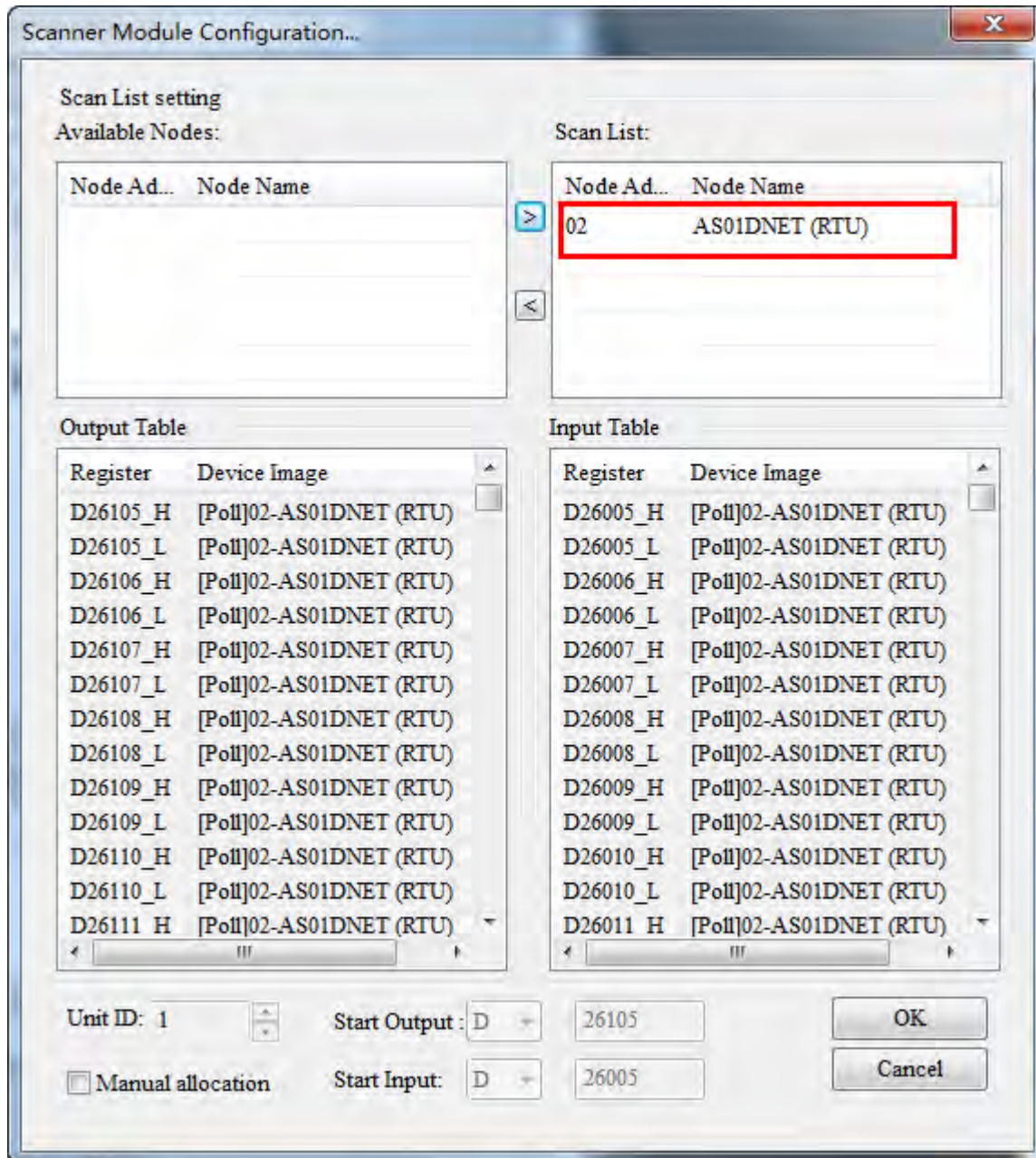

After the master assigns mapping addresses to AS01DNET (RTU), the mapping devices of the modules connected to the right side of AS01DNET (RTU) are shown as below.

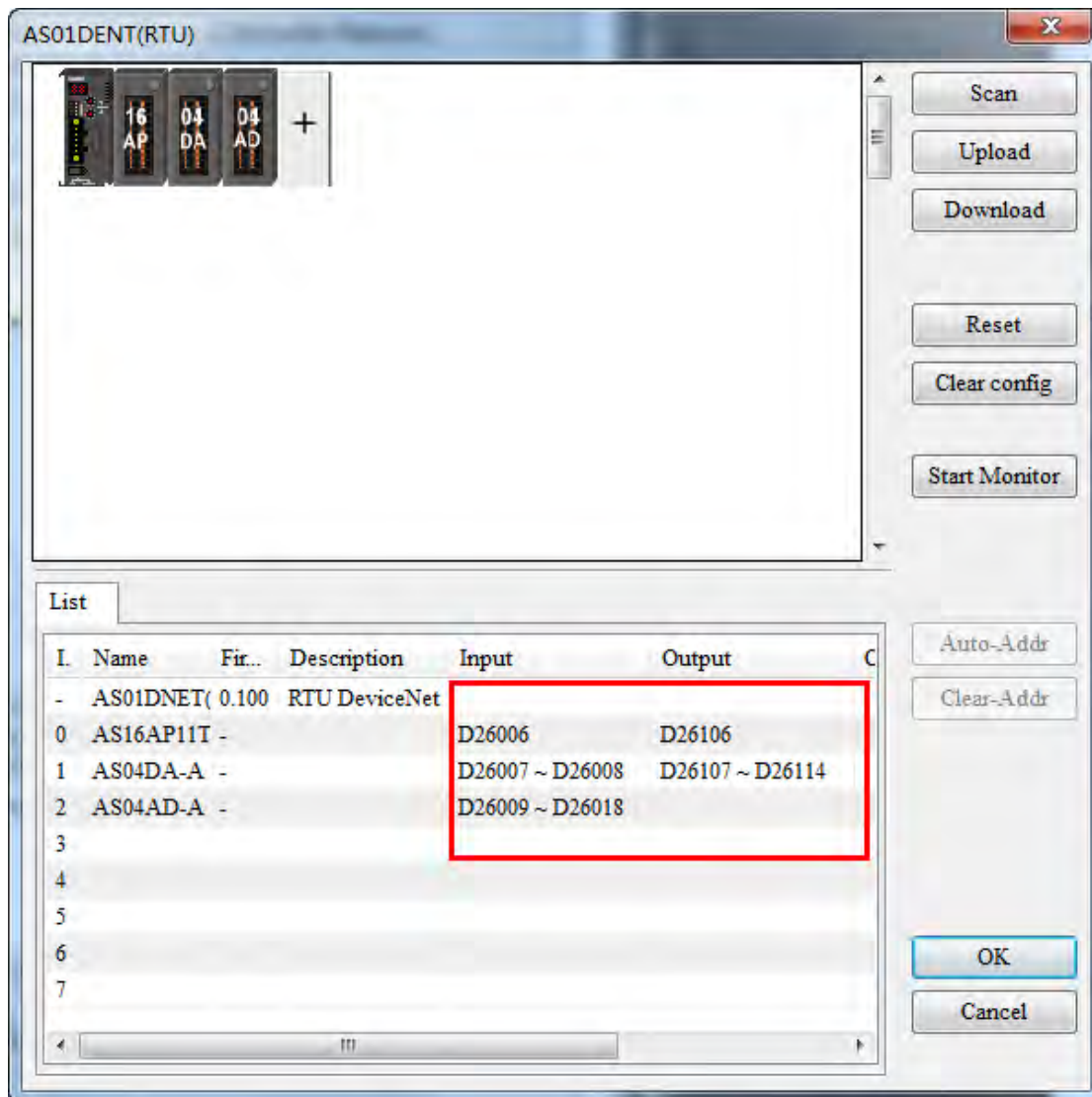

The software automatically assigns mapping addresses of module parameters in the arrangement order of modules connected to the right side of AS01DNET (RTU) from left to right.

Below is the table of configuration of one master AS01DNET and one slave AS01DNET (RTU) and mapping addresses that the software automatically assigns to each module. D26005 and D26105 are the control word and status word of AS01DNET (RTU).The input mapping address and output mapping address of AS16AP are D26006 and D26106 respectively. The input mapping addresses and output mapping addresses of AS04DA are D26007~D26008 and D26107~D26114 respectively. The input mapping addresses of AS04AD are D26009~D26018.

Auto Assignment	Input	Output
AS01DNET(RTU)	D26005 status word	D26105 control word
AS16AP	D26006	D26106
AS04DA	D26007~D26008	D26107~D26114
AS04AD	D26009~D26018	

The input and output mapping addresses of AS01DNET (RTU) are D26005~D26018 and D26105~D26114.

11.5.4.3.4. Status Word and Control Word of AS01DNET (RTU)

The start input address and start output address in the mapping areas of AS01DNET (RTU) are used as the status word and control word of AS01DNET (RTU) respectively with the detailed explanation in the following table.

11

● **Control word of AS01DNET(RTU)**

Bit	Status value	Description
bit0 ~ bit2	000	Make no control setting for the operation of AS01DNET(RTU)
	001	Set AS01DNET(RTU) to RUN mode
	010	Set AS01DNET(RTU) to STOP mode
	Other	Reserved
bit3	0	Reserved
	1	Restart AS01DNET (RTU)
bit4	0/1	Reserved
bit5	0/1	Reserved
bit6	0/1	Reserved
bit7	0/1	Reserved
bit8	0/1	Reserved
bit9	0/1	Reserved
bit10	0/1	Reserved
bit11	0/1	Reserved
bit12	0/1	Reserved
bit13	0/1	Reserved
bit14	0/1	Reserved
bit15	0/1	Reserved

● **Status word of AS01DNET(RTU)**

Bit	Status value	Description
bit0	0	AS01DNET (RTU) in RUN state
	1	AS01DNET (RTU) stops.
bit1	0/1	Reserved
bit2	0	No error occurs in I/O modules.
	1	An error occurs in I/O modules.
bit3	0/1	Reserved
bit4	0	Current connection matches the configuration.
	1	Current connection is inconsistent with the configuration.
bit5	0	AS01DNET (RTU) works normally.
	1	The voltage of the power supply for AS01DNET (RTU) is too low.
bit6	0/1	Reserved
bit7	0	AS01DNET (RTU) works normally.
	1	The number of points/ modules exceeds allowed range.
bit8	0/1	Reserved
bit9	0/1	Reserved
bit10	0/1	Reserved
bit11	0/1	Reserved
bit12	0/1	Reserved

Bit	Status value	Description
bit13	0/1	Reserved
bit14	0/1	Reserved
bit15	0/1	Reserved

11.5.4.4. Connecting AS01DNET (RTU) to the Network

To configure AS01DNET (RTU) successfully and make it work normally in the network, the following steps should be taken for the setup.

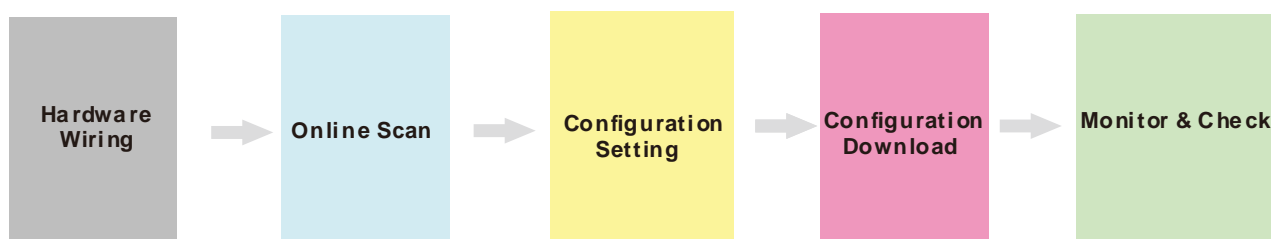

- **Hardware wiring**

During hardware wiring, notice that the standard cable should be used and two terminal resistors of 121Ω should be connected respectively to the two ends of the main line in the DeviceNet network. The node IDs of all nodes in the network bus can not be repeated and their baud rates should be consistent.

- **Online scan**

The online scan consists of two parts: scanning online network nodes and scanning I/O modules of AS01DNET (RTU). Before the scan, make sure that the communication channel selected is proper and the communication setup is normal in the communication manager COMMGR.

- **Configuration setting**

The configuration setting includes the master configuration and AS01DNET (RTU) configuration settings. The master configuration contains the master scanner module setting (configuration of master) and the scan list configuration setting. AS01DNET (RTU) configuration contains AS01DNET (RTU) setting and other I/O modules setting.

- **Configuration Download**

Configuration download consists of master configuration download and AS01DNET (RTU) configuration download. During the master configuration download, the seven-segment displayer of AS01DNET (RTU) shows 80 and its node ID alternately. During the AS01DNET (RTU) configuration download, the seven-segment displayer of AS01DNET (RTU) shows 83 and its node ID alternately.

- **Monitor and Check**

After the configuration is downloaded, check if AS01DNET (RTU) works normally. If AS01DNET (RTU) works normally, the digital displays of the master and AS01DNET (RTU) show their own node IDs and MS and NS indicators are ON in green.

11.5.5 Application Example

This section describes how to configure AS01DNET (RTU) and its right-side I/O module parameters in the DeviceNet Builder software through an application example. And how the parameters of the I/O modules connected to the right side of AS01DNET (RTU) are controlled and accessed through AS01DNET master is illustrated as well.

Control Requirement:

1. Connect the output point of AS16AP to the input point; turn on the output point to make the input point ON.
2. Write one value for channel 1 of AS04DA to change into analog signal and then convert the analog signal to digital signal to output via AS04AD.

11.5.5.1. Network Structure

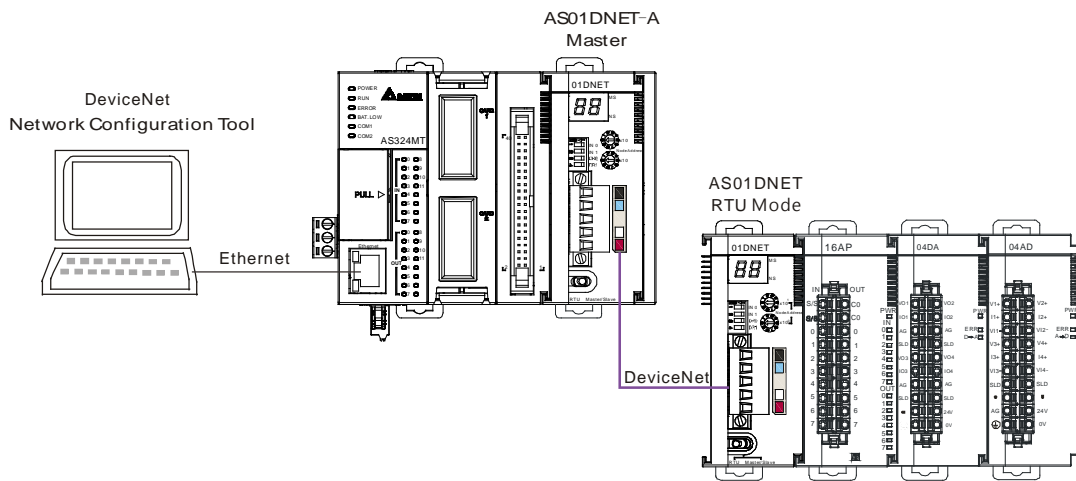

Note:

1. During the wiring, connect the voltage output of channel 1 of AS04DA to the voltage input of channel 1 of AS04AD. And add the 24 V power to AS04DA and AS04AD respectively.
2. Make sure that the baud rates of AS01DNET and AS01DNET (RTU) match.

Module	Node ID	Baud rate
AS01DNET	0	500Kbps
AS01DNET(RTU)	2	500Kbps

3. Connect the 24V network power module between V+ and V- and a terminal resistor of 121Ω between CAN_H and CAN_L.

11.5.5.2. Using DeviceNet Builder to Configure the Network

11.5.5.2.1. Building and Starting up Driver1 via COMMGR

Build driver1 in the COMMGR software.

Refer to Section 2.4 Communication Setting in the ISPSOft User Manual for more details.

11.5.5.2.2. Configuring AS01DNET (RTU)

1. Call DeviceNet Builder via ISPSOft.

Refer to Section 11.6 for details on the operation.

2. The called DeviceNet Builder is started as below.

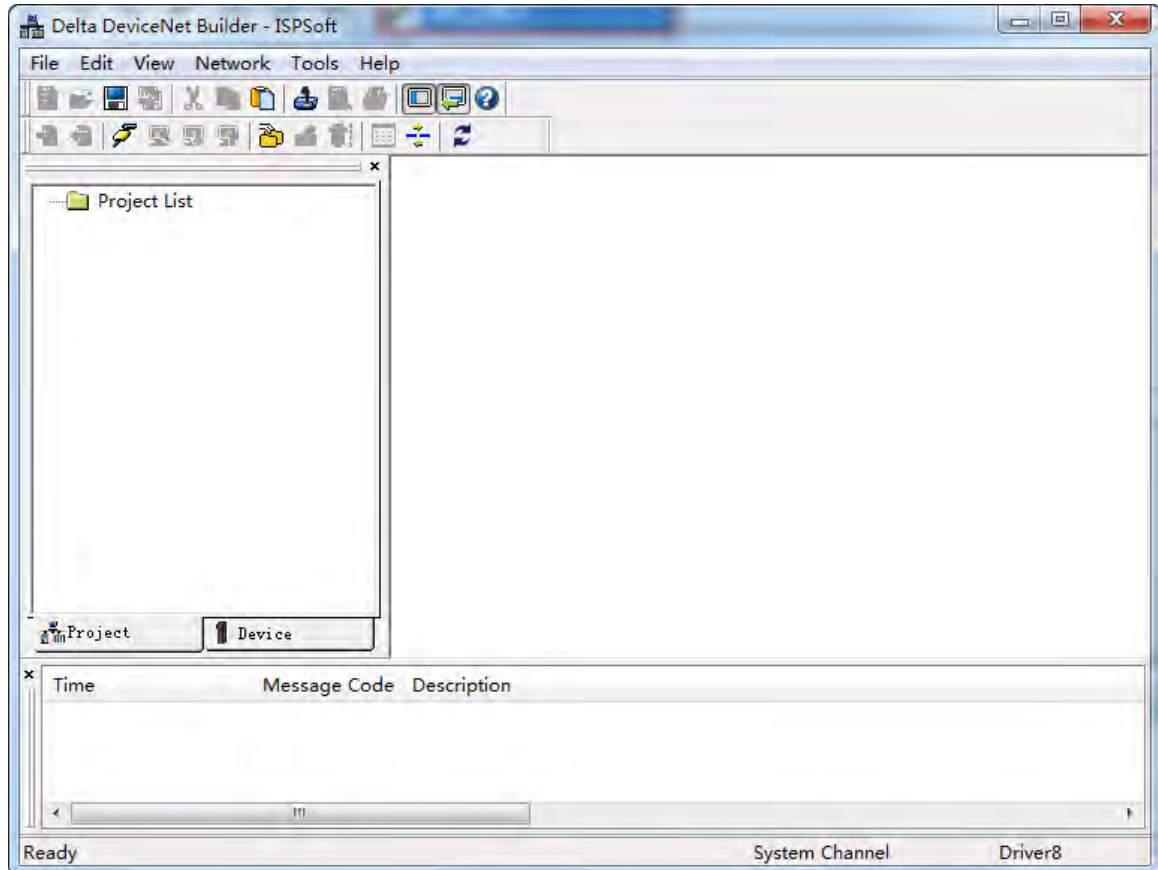

3. Click menu **Network>> Online**.

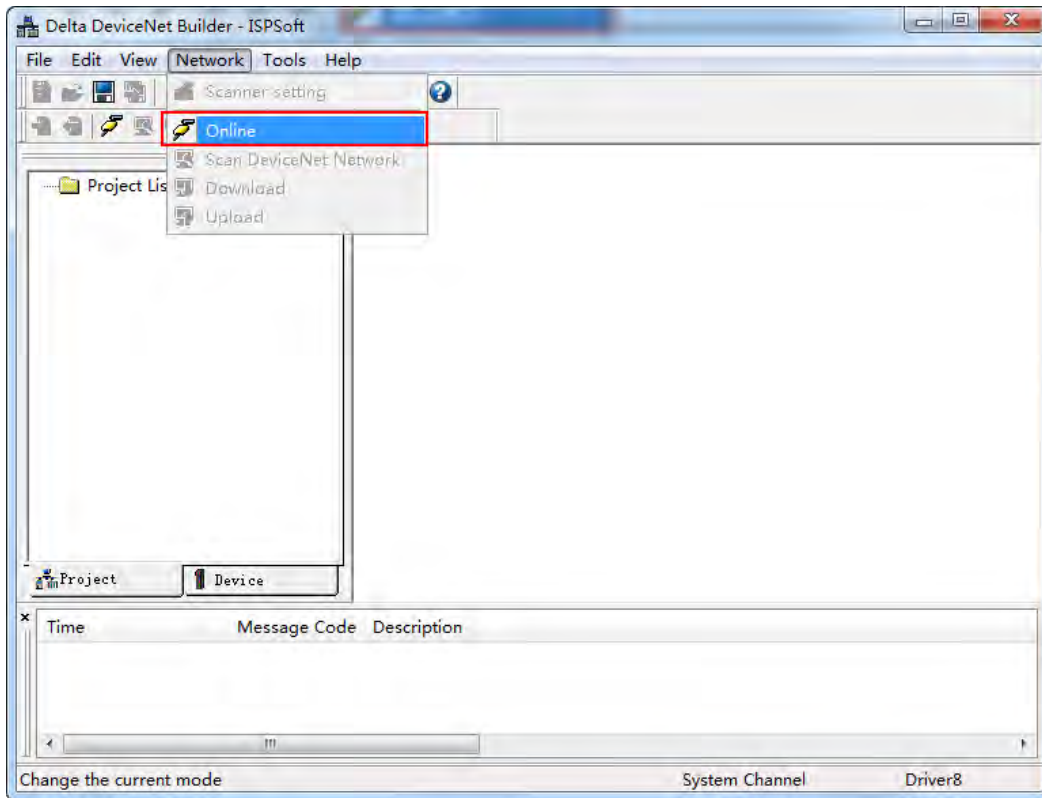

The AS01DNET-A master module which has been scanned is shown in the left-side Project List.

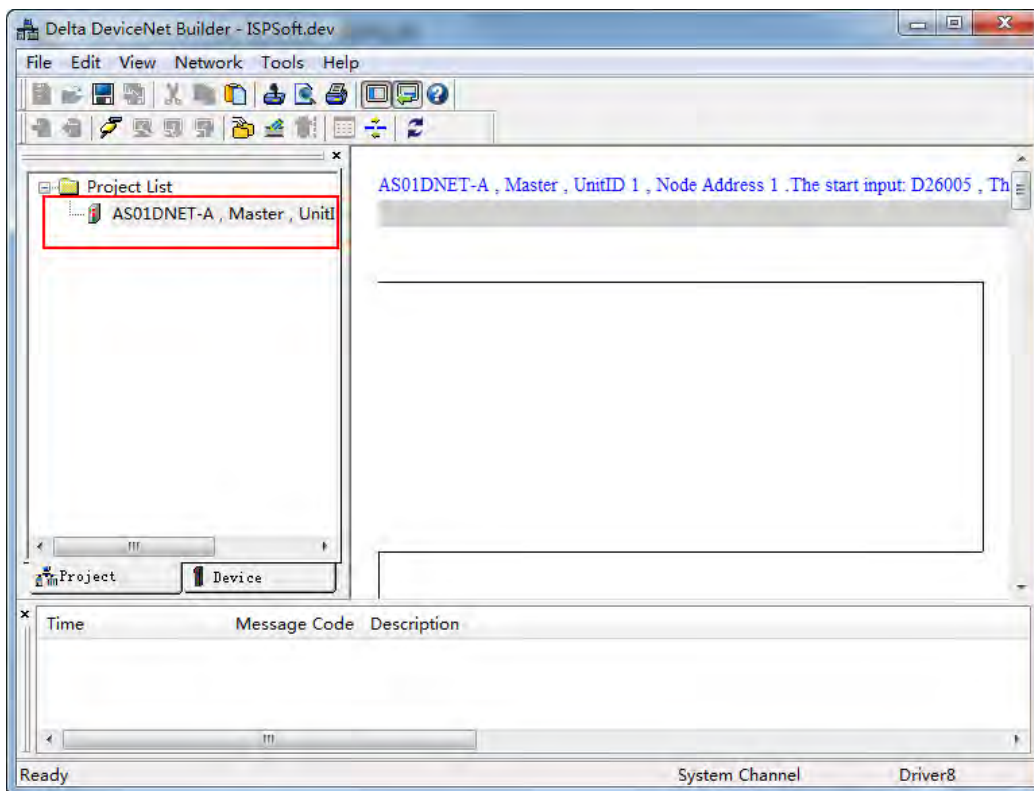

- Click menu **Network >> Scan DeviceNet Network**.

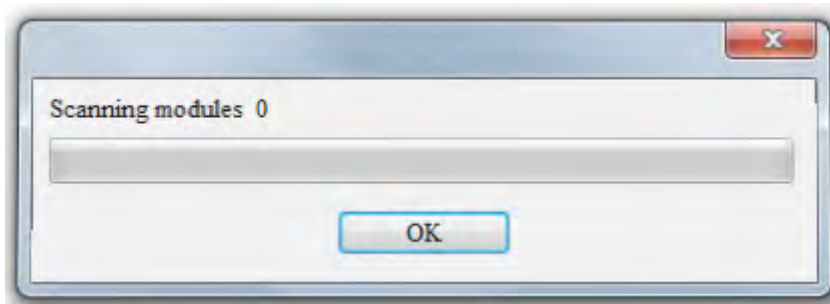

- The RTU slave in the DeviceNet network is scanned as follows.

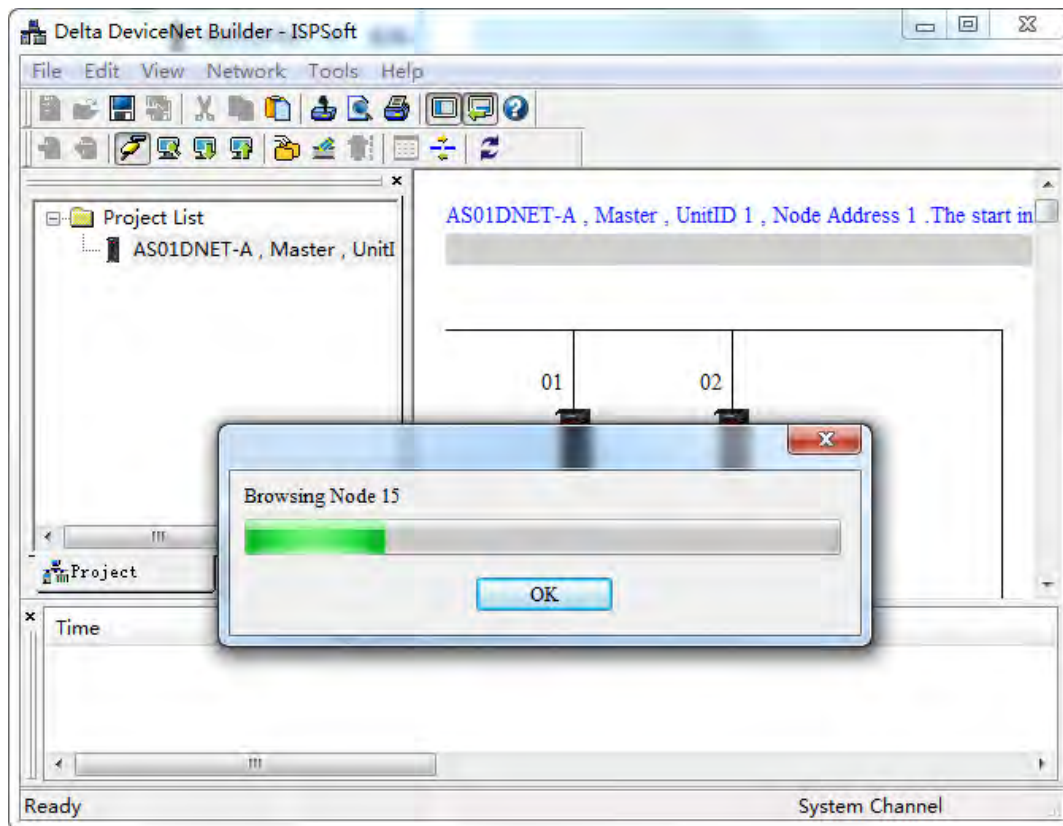

- Double click AS01DNET (RTU). Then the **Node Configuration...** dialog box appears. Click the **IO Configure...** button to make the **AS01RTU-DNET** interface appear, where to configure the modules connected to AS01DNET (RTU).

11

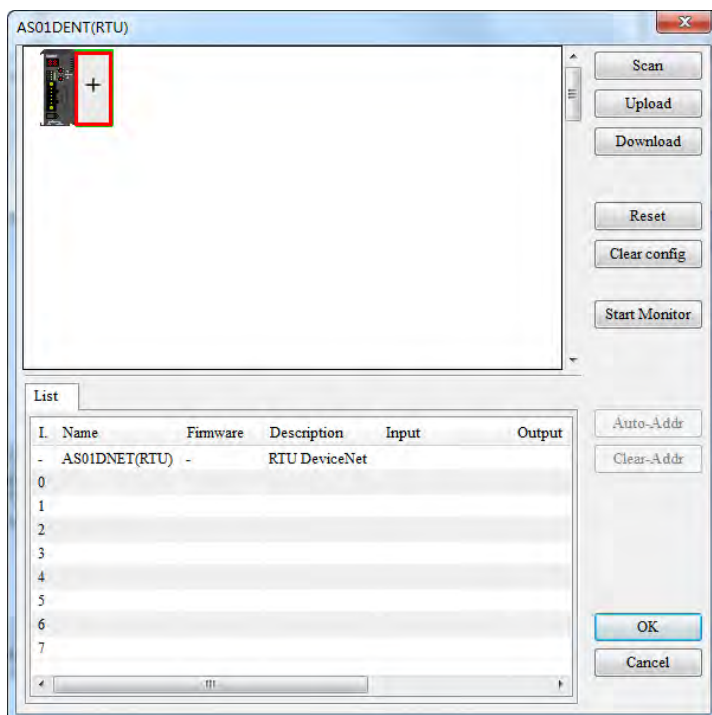
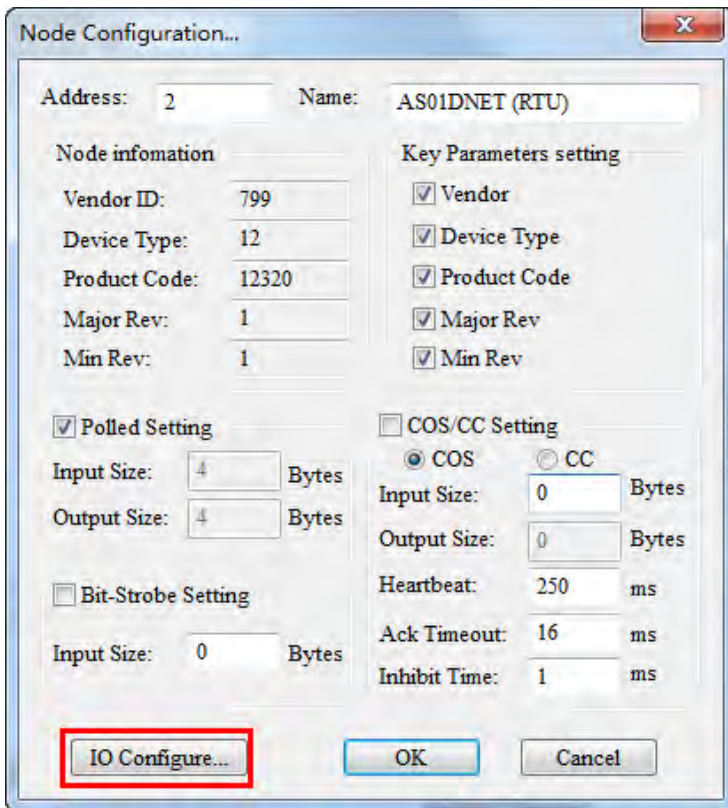

7. Click the **Scan** button to scan the I/O modules connected to the right side of AS01DNET (RTU).

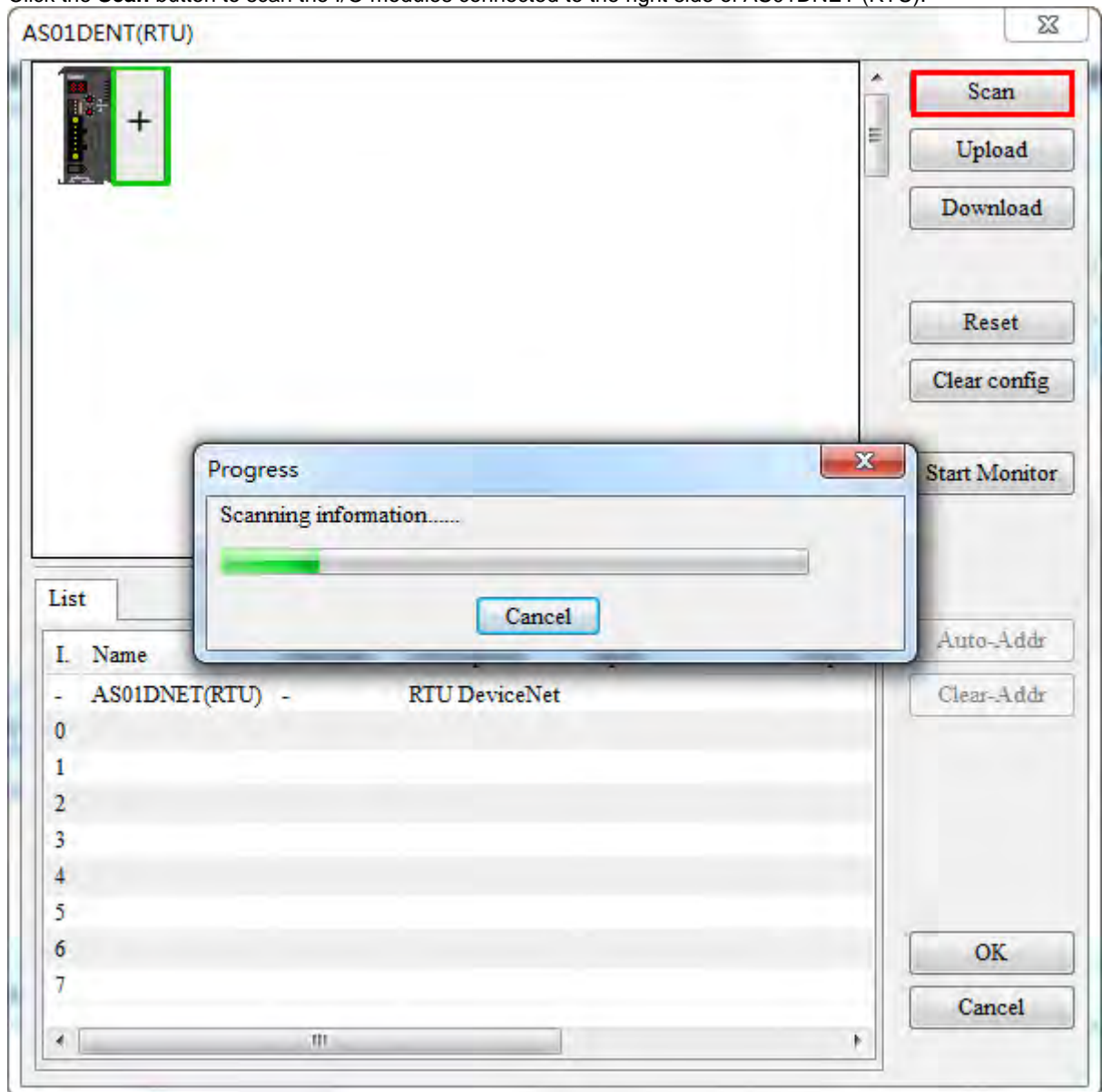

- After the module is scanned, configure module parameters. Double click AS04DA module and select “-10V~+10V” for channel 1 mode setting. Click the **OK** button to finish the setting. Use the same setting way for channel 1 mode setting of AS04AD and set it to “-10V~+10V” as well.

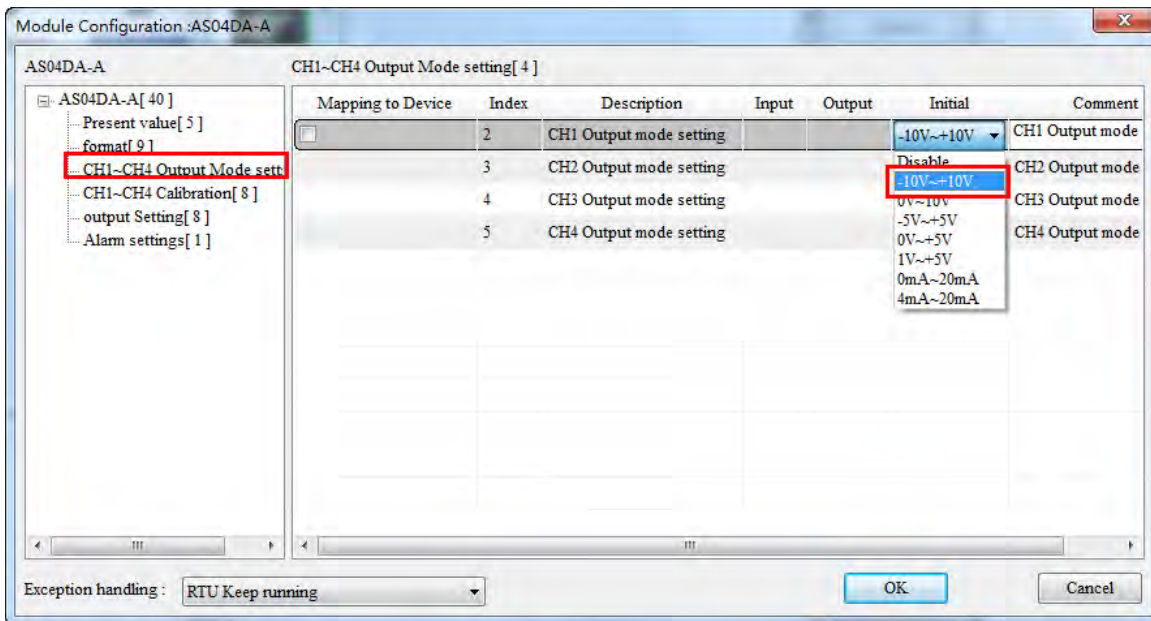

- After the configuration of modules is finished, click the **Download** button to download the configuration of I/O modules connected to the right side of AS01DNET (RTU) to AS01DNET (RTU).

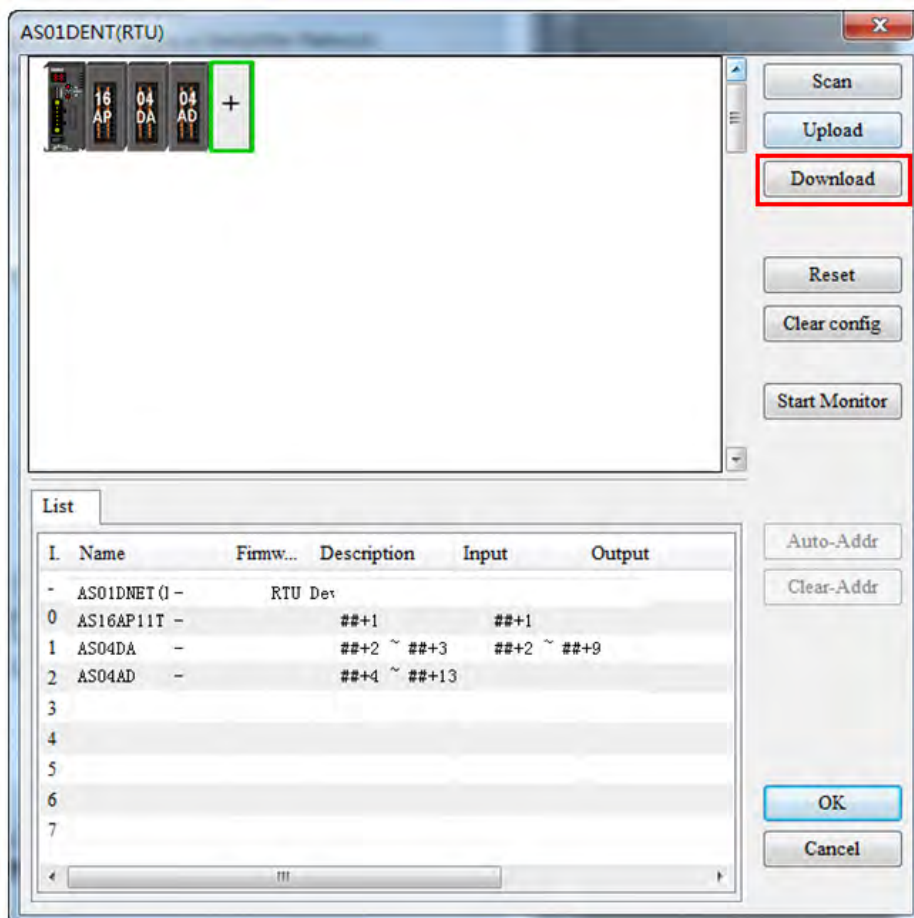

10. After the download, click the **OK** button to go back to the main page of the software. Double click AS01DNETScanner icon and then move the slave in **Available Nodes** to **Scan List** on the **Scanner Module Configuration** dialog box. Click the **OK** button to finish the setting.

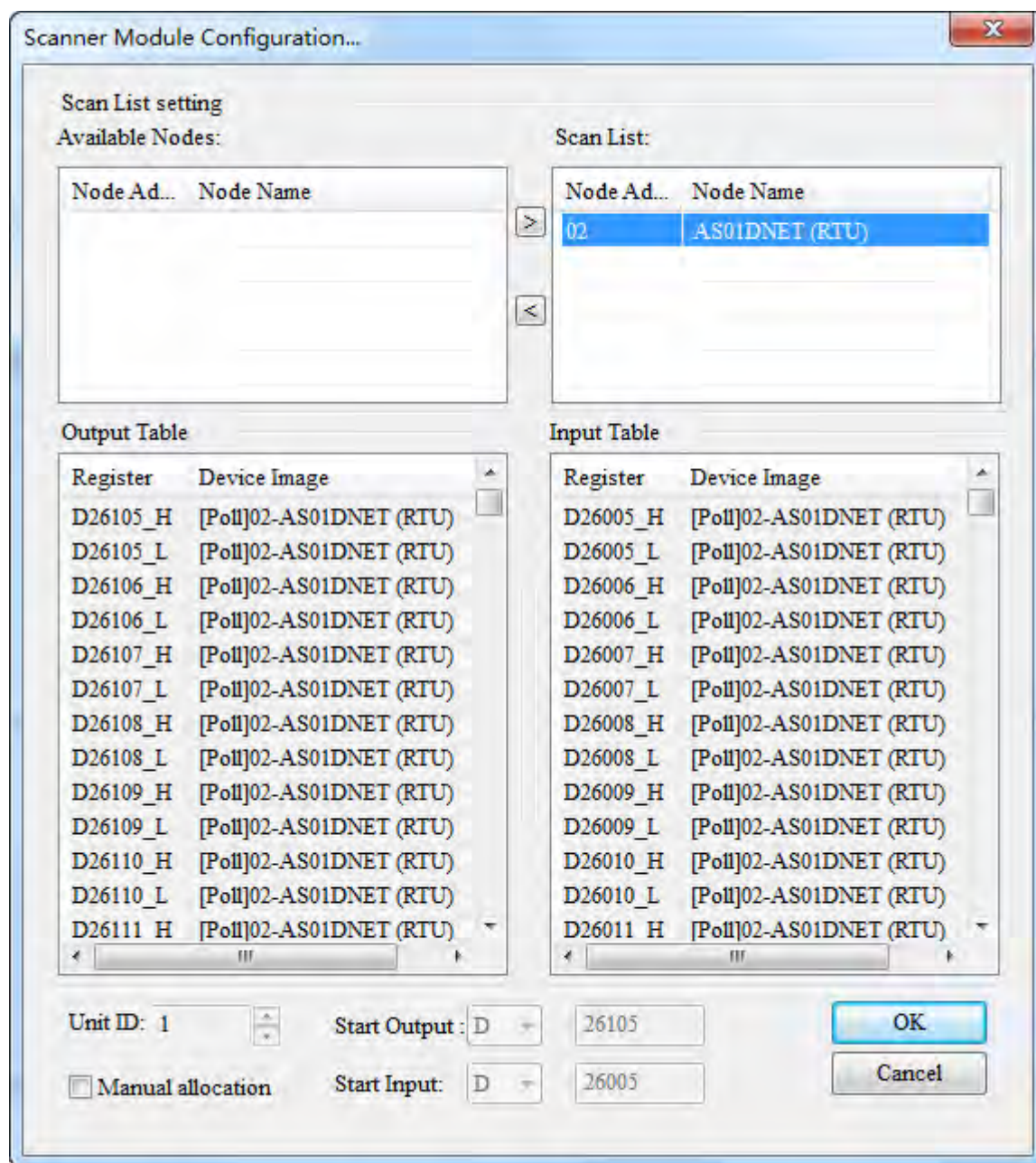

11. Click menu **Network >> Download** to download AS01DNET (RTU) configuration to the master.

The input mapping address D26005~D26018 and output mapping address D26105~D26114 are for AS01DNET (RTU). The start input address D26005 and start output address D26105 are respectively used as the status word and control word of AS01DNET (RTU). The parameter mappings of all modules connected to AS01DNET (RTU) are displayed below.

I..	Name	Firmware	Desc...	Input	Output
-	AS01DNET(RTU)	0.100	RTU Dev		
0	AS16AP11T	-		D26006	D26106
1	AS04DA-A	-		D26007 ~ D26008	D26107 ~ D26114
2	AS04AD-A	-		D26009 ~ D26018	
3					
4					
5					
6					
7					

I/O Module		Input	Output
AS16AP		D26006	D26106-
AS04DA	Status	D26007~D26008	
	Channel 1 output value		D26107~D26108
	Channel 2 output value	-	D26109~D26110
	Channel 3 output value	-	D26111~D26112
	Channel 4 output value	-	D26113~D26114
AS04AD	Status	D2609~D26010	
	Channel 1 input value	D26011~D26012	
	Channel 2 input value	D26013~D26014	
	Channel 3 input value	D26015~D26016	
	Channel 4 input value	D26017~D26018	

11.5.5.3. Using LD Program to Control the Entire Network

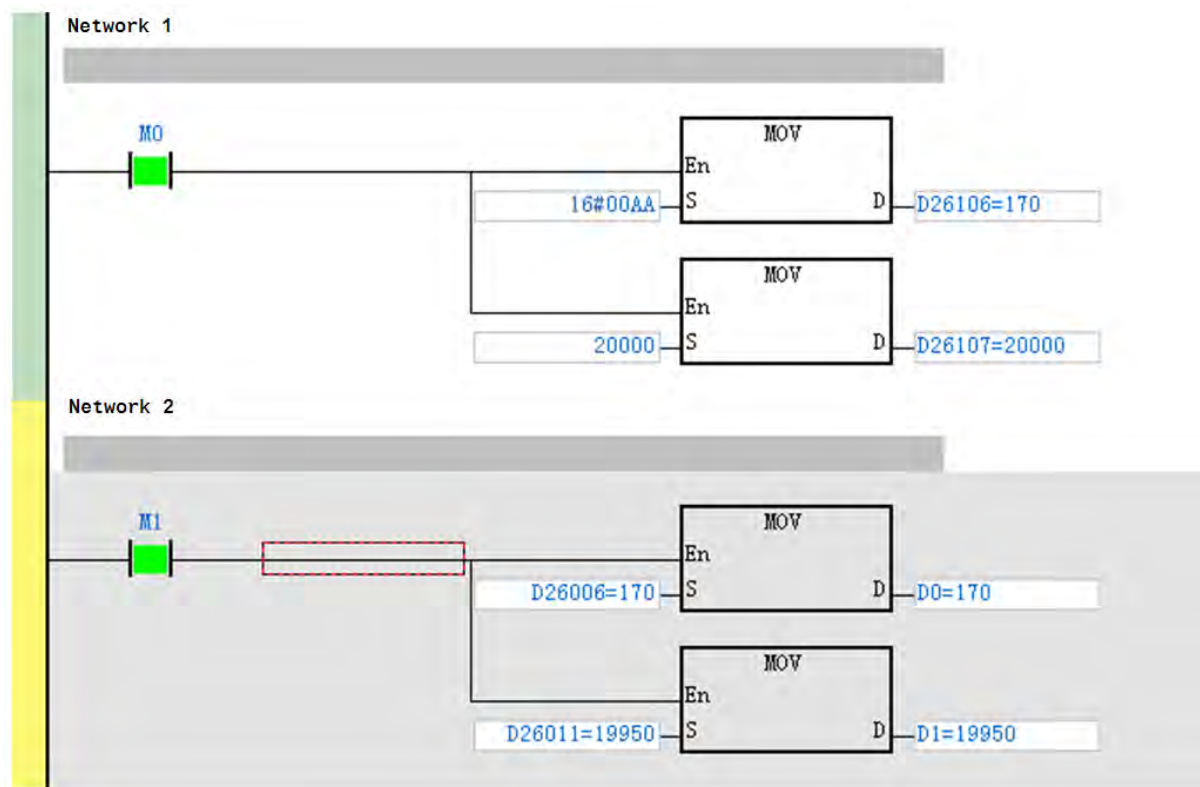

Program Explanation:

1. In network 1, write a value for the output of AS16AP and for the output of channel 1 of AS04DA when M0 changes to ON.
2. In network 2, move the input value of AS16AP to D0 and the input value of channel 1 of AS04AD to D1 when M1 changes to ON.

11.5.6 Error Diagnosis and Trouble Shooting

AS01DNET (RTU) provides four diagnosis methods such as LED indicator, seven-segment displayer, status word diagnosis and software diagnosis.

11.5.6.1. Indicator Diagnosis

● NS indicator

LED status	Indication	How to deal with
OFF	No power supply; Or the repeated node ID detection has not been completed.	<ol style="list-style-type: none"> 1. Check the power supply for AS01DNET (RTU) and the connection are normal. 2. Make sure that the baud rates of AS01DNET (RTU) and the master match.
Green light blinking (ON:0.5s and OFF: 0.5s alternately)	No connection between AS01DNET (RTU) and its right-side modules	Configure AS01DNET (RTU) in the DeviceNet software and download the configuration correctly.
Green light ON	Normal I/O data transmission between AS01DNET (RTU) and DeviceNet master	No correction needed
Red light blinking (ON:0.5s and OFF: 0.5s alternately)	I/O connection timeout between AS01DNET (RTU) and DeviceNet master	Refer to the error shooting in Codes in Seven-Segment Displayer below.
Red light ON	Network trouble; Repeated node ID; No network power; Or BUS-OFF.	<ol style="list-style-type: none"> 1. Ensure that the IDs of all nodes are unique on the bus. 2. Check if the network installation is normal. 3. Check if the baud rate of AS01DNET (RTU) is the same as that of the bus. 4. Check if the node ID of AS01DNET (RTU) is valid. 5. Check if the network power supply is normal.

● MS indicator

LED status	Indication	How to deal with
OFF	No power	Check if the power supply for AS01DNET (RTU) and connection are normal.
Green light blinking (ON:0.5s and OFF: 0.5s alternately)	<ol style="list-style-type: none"> 1. AS01DNET (RTU) is waiting for the I/O data from DeviceNet master. 2. No I/O data transmission between AS01DNET(RTU) and DeviceNet master 3. The PLC connected to DeviceNet master is in STOP state. 	<ol style="list-style-type: none"> 1. Configure AS01DNET (RTU) in the DeviceNet software and download the configuration correctly. 2. Switch the PLC to RUN state
Green light ON	Normal transmission of I/O data between AS01DNET (RTU) and DeviceNet master	No correction needed

LED status	Indication	How to deal with
Red light blinking (ON:0.5s and OFF: 0.5s alternately)	No network power supply; Configuration error; Module alarms.	<ol style="list-style-type: none"> 1. Check if the network power supply is normal; 2. Reset the internal parameters in AS01DNET (RTU); 3. Check if there is an error or alarm in the I/O modules connected to the right side of AS01DNET (RTU).
Red light ON	Hardware error	Return the product to factory for repair if the error still exists after re-power on.

11.5.6.2. Codes in Seven-Segment Displayer

Code	Indication	How to deal with
0~63	Node ID of the scanner module (When in RUN state)	No correction needed
F0	The node ID is repeated or exceeds allowed range.	<ol style="list-style-type: none"> 1. Ensure that the node ID of AS01DNET (RTU) is unique in the DeviceNet network within the range of 0~63. 2. Repower it on after changing the node ID.
F1	No I/O module is configured to AS01DNET (RTU) in the DeviceNet Builder software.	Add I/O modules in AS01DNET (RTU) in the DeviceNet Builder software and download the configuration data to AS01DNET (RTU) after the configuration is finished.
F2	The work voltage of AS01DNET (RTU) is too low.	Check if the power supply for AS01DNET (RTU) works normally.
F3	AS01DNET (RTU) enters the test mode.	Repower AS01DNET (RTU).
F4	AS01DNET (RTU) is the Bus-Off state.	<ol style="list-style-type: none"> 1. Check if the network communication cable is normal and the shielded cable is grounded. 2. Ensure the baud rates of all network nodes are same. 3. Check if the two ends of the network are both connected with a 120Ω terminal resistor. 4. Repower the scanner module.
F5	No network power supply for AS01DNET(RTU)	<ol style="list-style-type: none"> 1. Check if the network cable is normal. 2. Check if the network power supply is normal. (The external 24V DC network power supply is connected between red V+ and black V- of AS01DNET (RTU) .)
F6	Internal error; An error in the internal storage units of AS01DNET (RTU)	Return the product to factory for repair if the error still exists after re-power on.
F7	Internal error; An error in the data exchange units of AS01DNET (RTU)	Return the product to factory for repair if the error still exists after re-power on.
F8	Manufacture error	Return the product to factory for repair if the error still exists after re-power on.

Code	Indication	How to deal with
F9	Internal error; An error in the access of the Flash of AS01DNET (RTU)	Return the product to factory for repair if the error still exists after re-power on.
E4	Module error	Check if an error occurs in the modules connected to the right side of AS01DNET (RTU); Check if the module exists; Check if current module matches that configured in the software; Check if the unconfigured module is added.
E7	Repeated node ID detection	If the code has emerged for a long time, please shoot troubles in the methods below. 1. Ensure that there are at least two nodes working normally in the network. 2. Check if the two ends of the network are both connected with a 121Ω terminal resistor. 3. Ensure that the baud rates of all network nodes are same. 4. Check if the network cable has a problem such as being disconnected and loosened. 5. Check if the bus communication cable length exceeds maximum transmission distance. If the maximum transmission distance is exceeded, the stability of the system can not be ensured. 6. Check if the shielded wire of the network communication cable is grounded. 7. Turn on the power of AS01DNET (RTU) again.
E9	The number of I/O modules connected to AS01DNET (RTU) exceeds the maximum 8.	Check if the number of I/O modules connected to AS01DNET (RTU) is more than 8.
80	AS01DNET (RTU) is in STOP state.	1. Check if the RUN/STOP switch of the PLC connected to the DeviceNet master is turned to RUN. 2. Check if the value of control word of AS01DNET (RTU) is 1. For details, refer to Section 11.5.4.3.4.
83	The AS01DNET (RTU) configuration in the software is being downloading.	Wait until the download of AS01DNET (RTU) configuration data is completed.

When multiple errors exist, the seven-segment displayer of AS01DNET (RTU) will display error codes cyclically. For example, the error codes: E4 03 80 02 are displayed cyclically. See the detailed meaning as below.

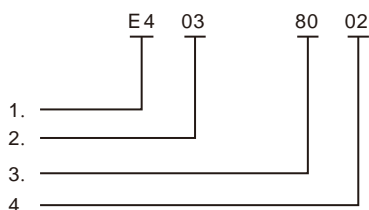

- ◆ E4 indicates a module error or offline. For details, see the explanation of codes above.
- ◆ 03 indicates the position of the module where an error occurs. The position of the first module connected to the right side of AS01DNET (RTU) is 1 and that of the second module is 2. Maximum 8 I/O modules are connectable to AS01DNET (RTU) within the range of 1~8.

- ◆ 80 means AS01DNET (RTU) is in STOP state.
- ◆ 02 is the node ID: 2 of AS01DNET (RTU).

11.5.6.3. Status Word Diagnosis

The status word of AS01DNET (RTU) shows the operation states of special modules and digital I/O modules. See the following table for status word diagnosis and disposal.

Bit	Status value	Description	Disposal
bit0	0	AS01DNET (RTU) is in RUN state	No correction needed
	1	AS01DNET (RTU) is in STOP state.	Restart AS01DNET(RTU)
bit1	0	Valid configuration data in AS01DNET(RTU)	No correction needed
	1	Invalid configuration data in AS01DNET (RTU)	Re-download the configuration data to AS01DNET (RTU) by using the DeviceNet Builder software.
bit2	Reserved	—	—
bit3	Reserved	—	—
bit4	0	Currently connected module matches the configuration in the software.	No correction needed
	1	Currently connected module is inconsistent with the configuration in the software.	<ol style="list-style-type: none"> 1. Check if currently connected module is consistent with the configuration in the software. 2. Change current module to match the configuration in the software or change the configuration in the software to match currently connected module.
bit5	0	AS01DNET(RTU) in normal operation	No correction needed
	1	AS01DNET(RTU) in low voltage	Check if the power supply for AS01DNET (RTU) is normal.
bit6	Reserved	—	—
bit7	0	AS01DNET(RTU) in normal operation	No correction needed
	Reserved	—	—
bit8	Reserved	—	—
bit9	Reserved	—	—
bit10	Reserved	—	—
bit11	Reserved	—	—
bit12	Reserved	—	—
bit13	Reserved	—	—
bit14	Reserved	—	—
bit15	Reserved	—	—

11.5.6.4. Software Diagnosis

Click the **Start Monitor** button on the AS01DNET (RTU) interface. The **Error code** column will show relevant contents as follows.

11

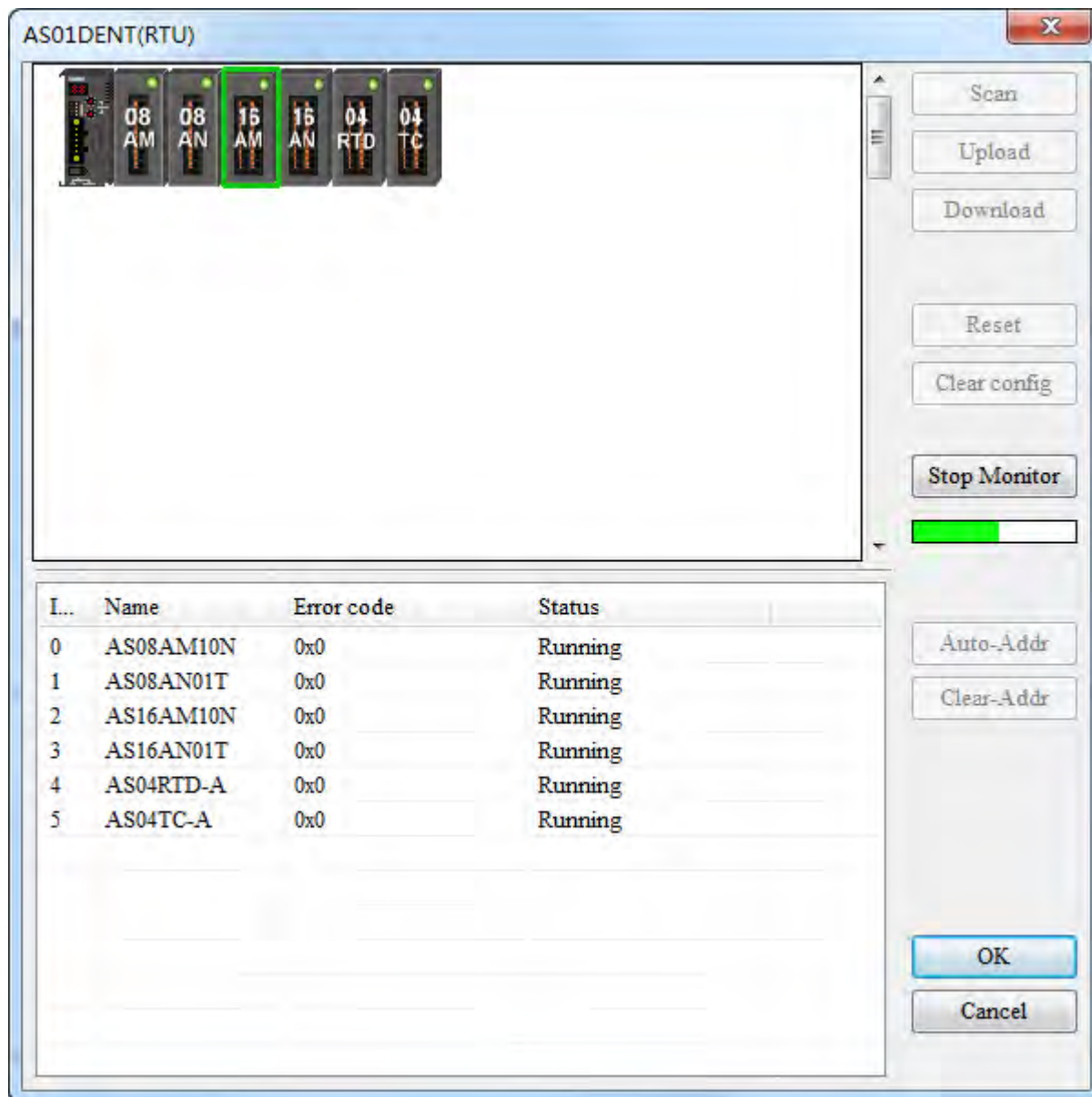

Error No.	Explanation	Solution
0x8001	AS01DNET (RTU) can not detect the configured module.	1. Check if the module is disconnected. 2. Check if the module is damaged.
0x8002	Current module is not consistent with the configured module.	Ensure that the actually connected module is the same as that configured in the software.

Note: For details on more error codes, refer to the explanation of Error ID in AS-series product manual.

Remark:

- The software diagnosis function can not be enabled until the DeviceNet Builder software is online.

11.6 How to Call DeviceNet Builder through ISPSoft (AS-Series PLC)

■ Network structure

Connect the devices according to the following figure. PC accesses AS-series PLC through Ethernet.

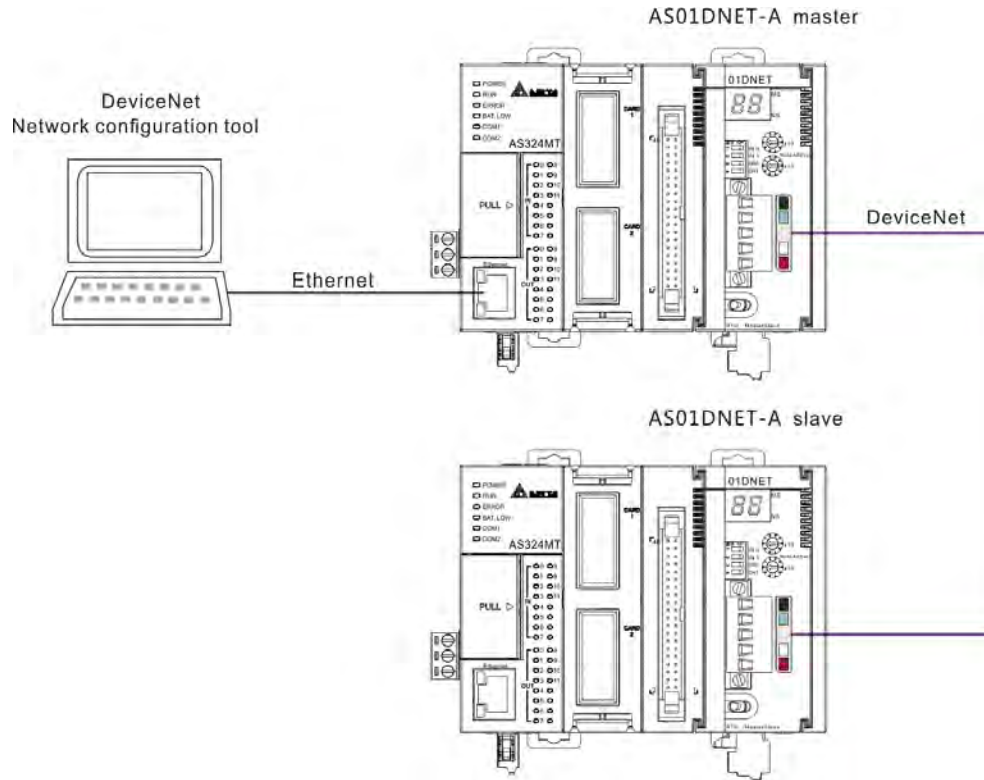

■ Operation of Software

1. Open the ISPSOft software and then select menu **File>> New>> New**. In the following dialog box which appears, select corresponding PLC type **AS** marked in the red box below.

11

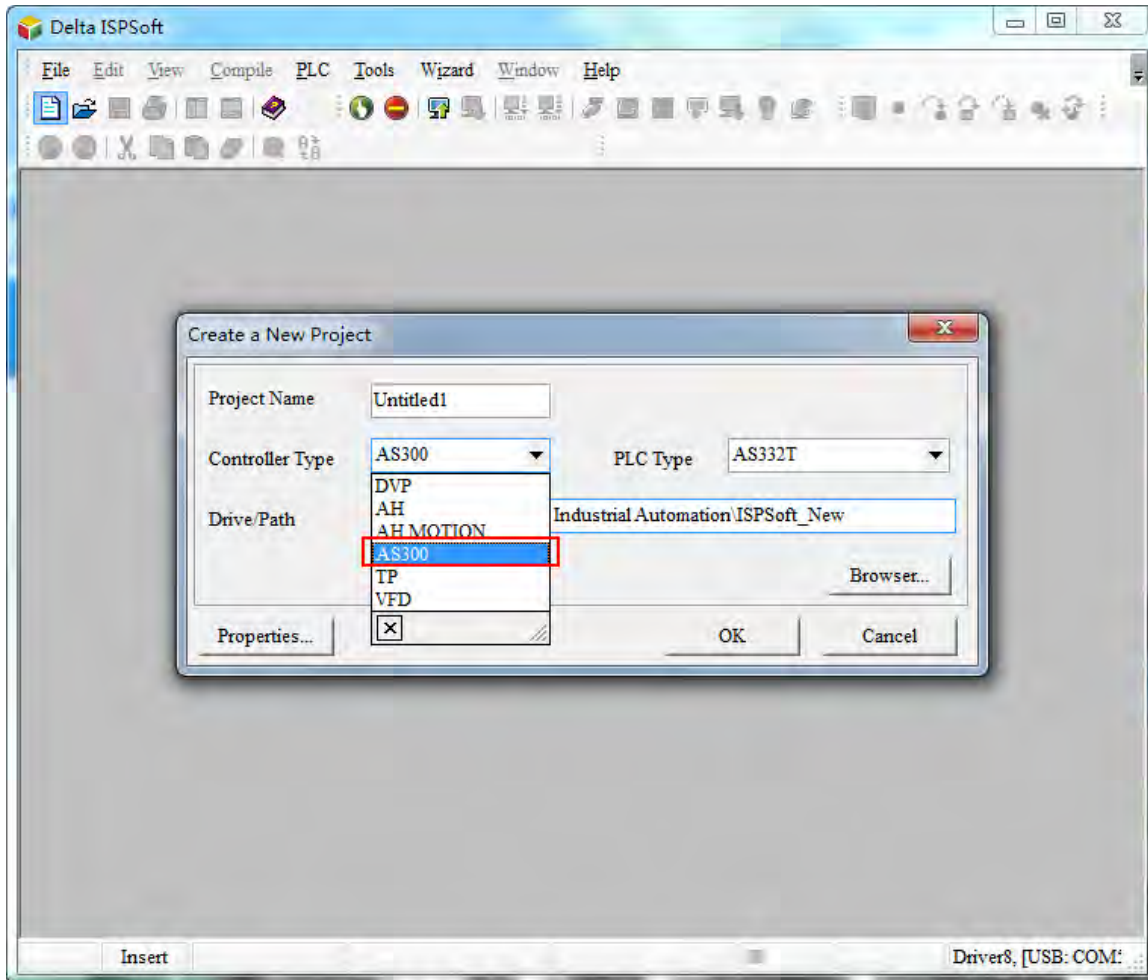

Note: The PLC type used in this section is AS332T-A.

- Click the **OK** button. Then the main interface of the ISPSOft software appears as below.

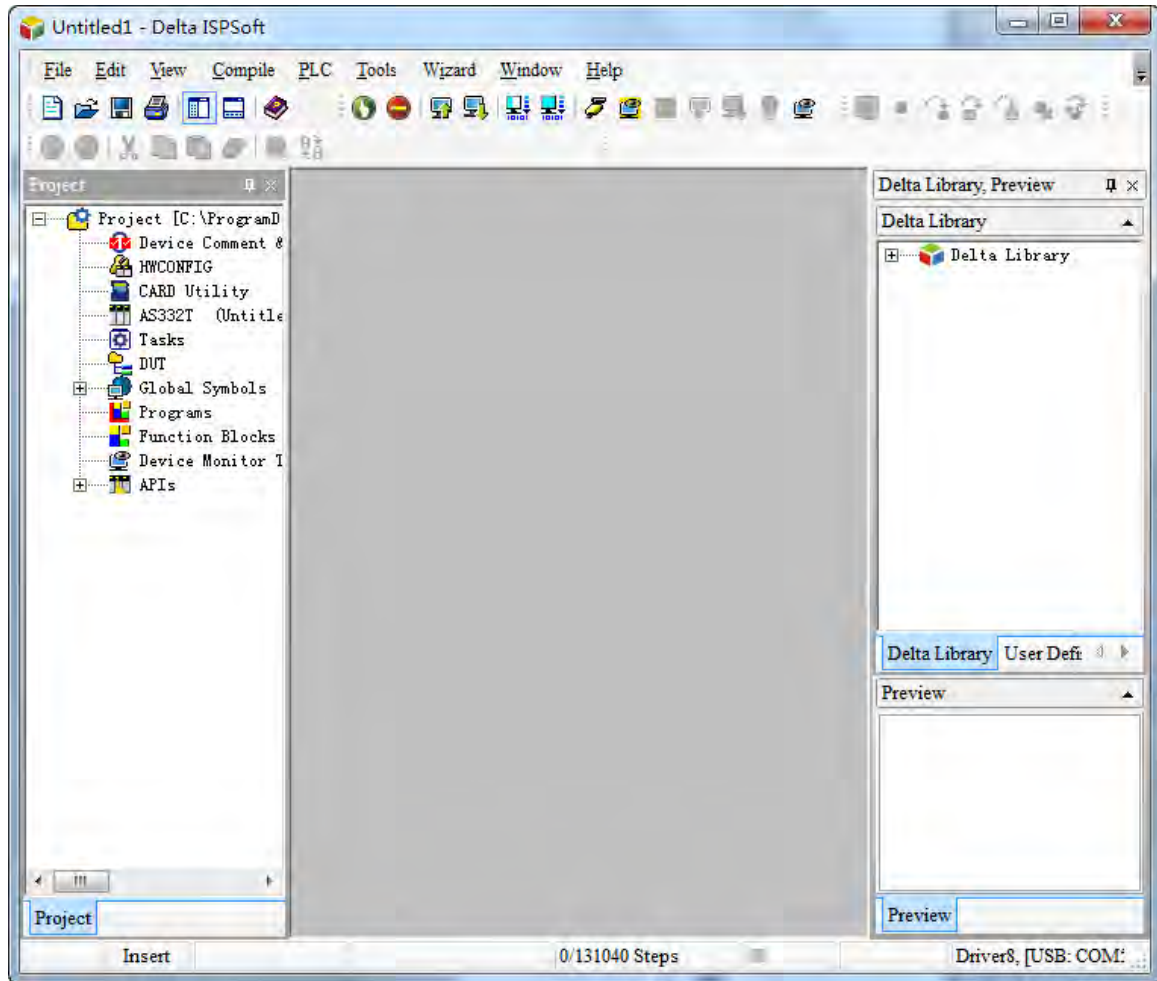

- Set up COMMGR communication. Refer to Section 2.4 Communication Setting in the ISPSOft User Manual for more details.

- After the setup of COMMGR communication is finished, select menu **Tools>> Communication settings...**

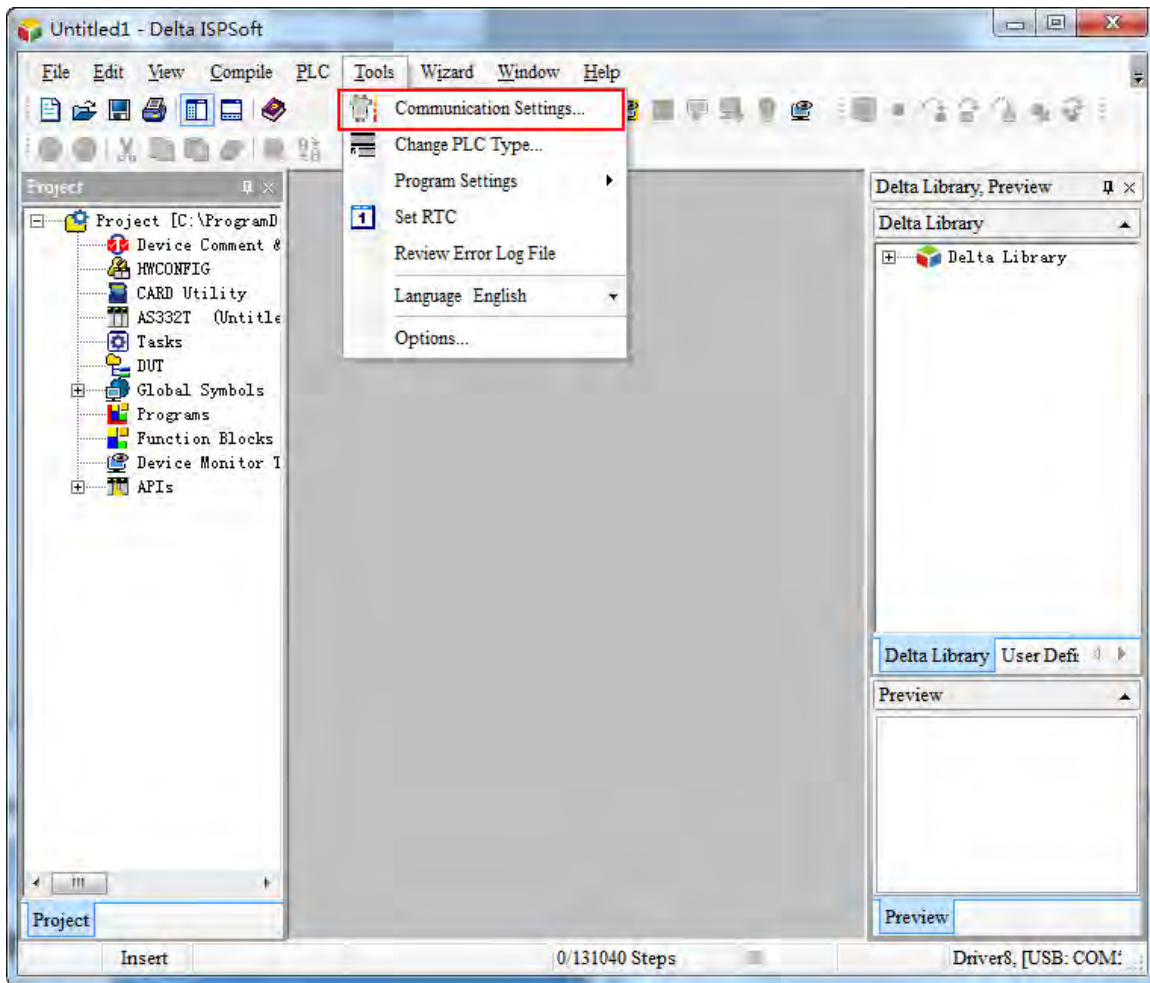

- The following dialog box appears. Select one desired driver which has been created and then click the **OK** button.

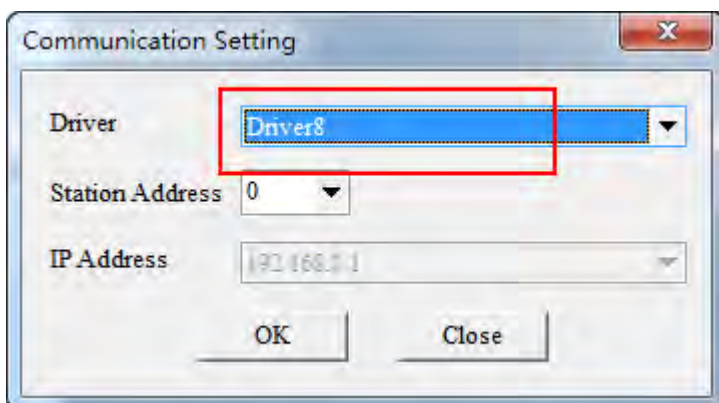

6. Double click **HWCONFIG** marked in the red box below.

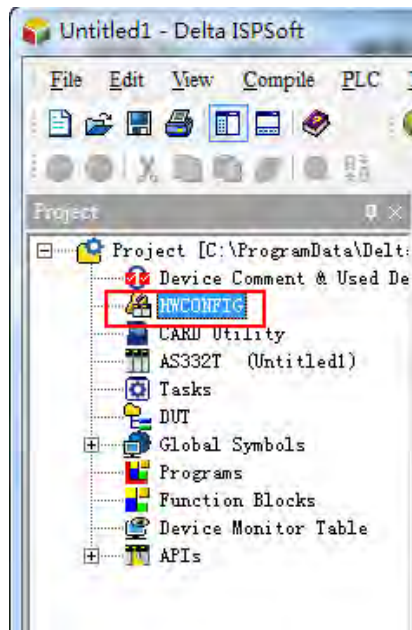

7. Select menu **Option>> I/O Scan** in the following window which pops up. Then the AS01DNET-5A icon will show up.

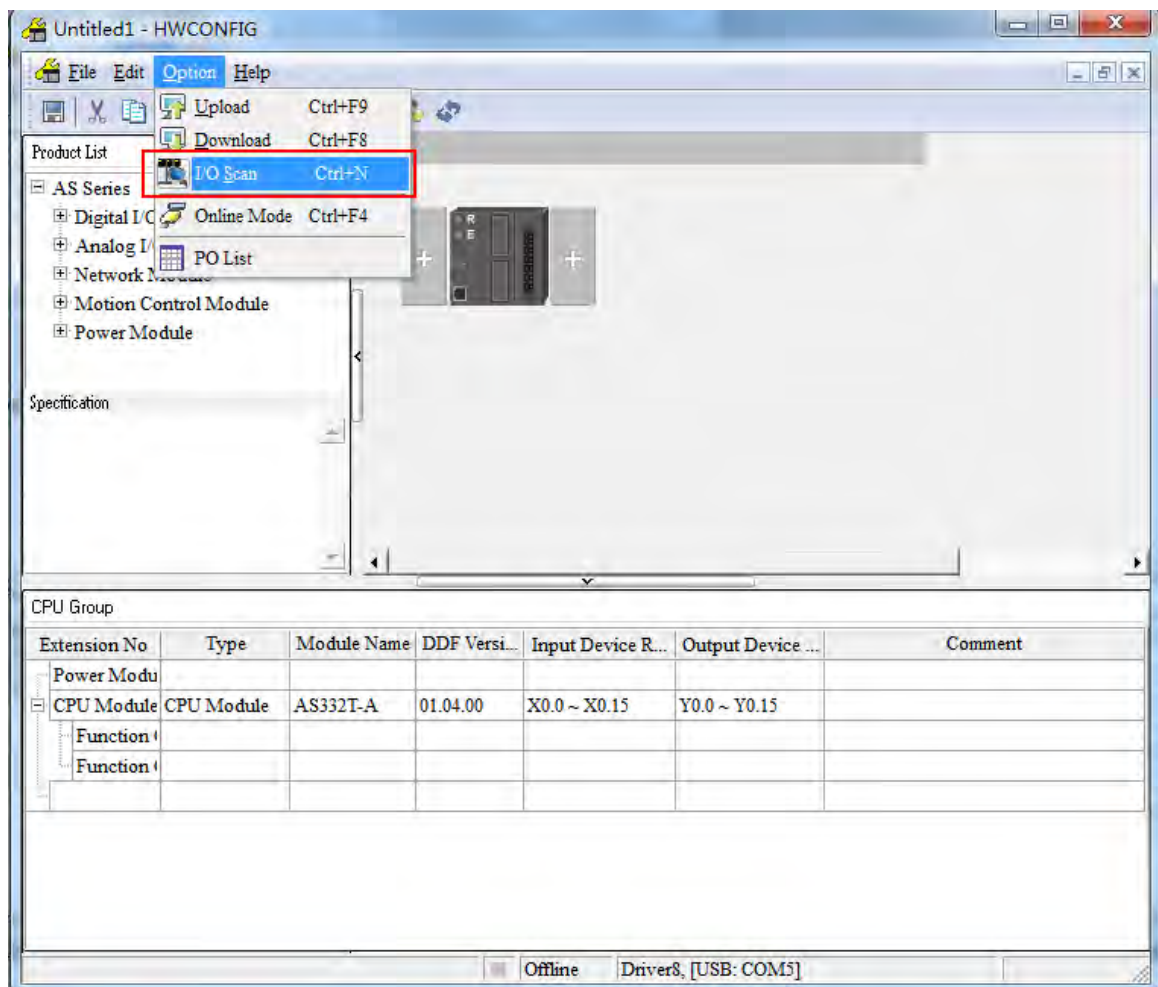

8. Select menu **Option>> Download** in the HWCONFIG window. Then the following dialog box appears. Select the checkbox of **Download All Items** or select the checkboxes of the items which are needed for download. Afterwards, click the **OK** button.

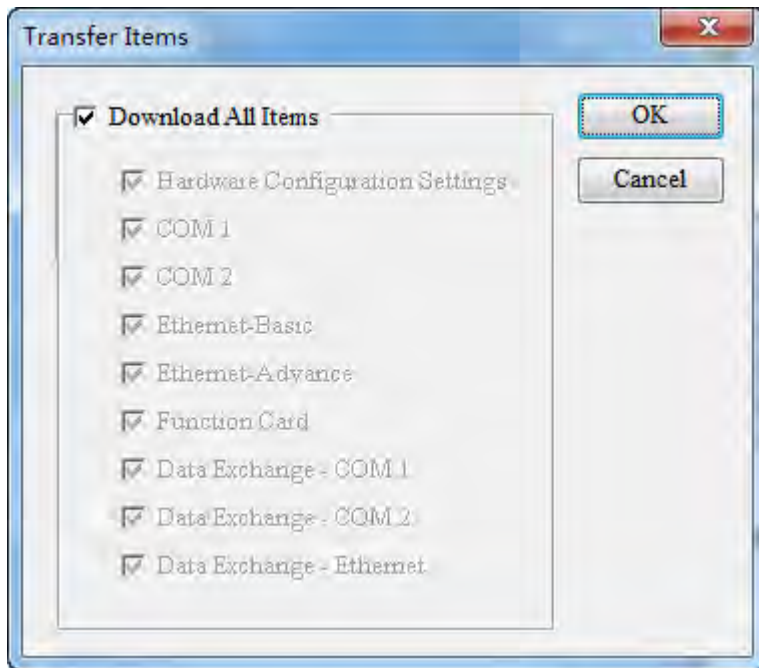

9. Then the following two dialog boxes of **HWCONFIG** and **PC=>AS** appear. Click **Yes** to perform the PC=>AS status.

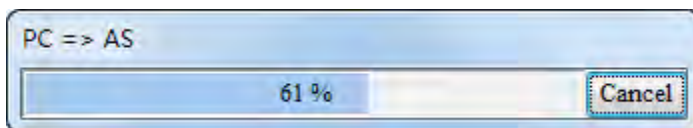
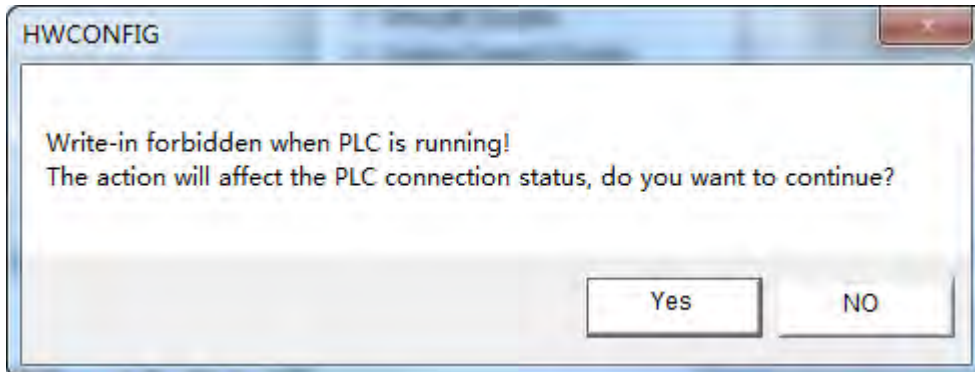

10. When the download is finished, the progress bar is shown as below.

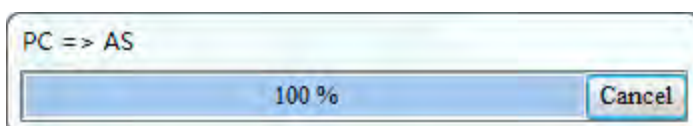

Meanwhile the following dialog box pops out. Click the **Yes** button.

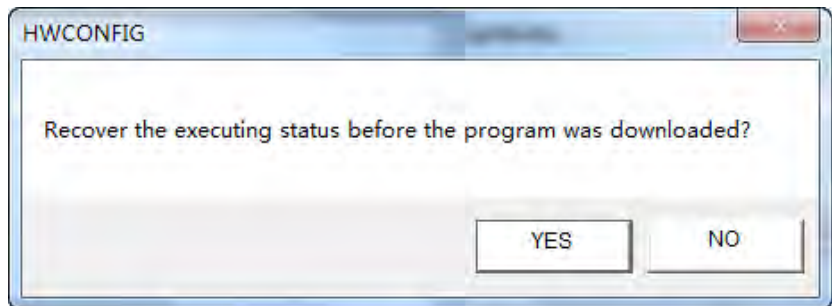

11. The following dialog box appears to show that the download has been finished.

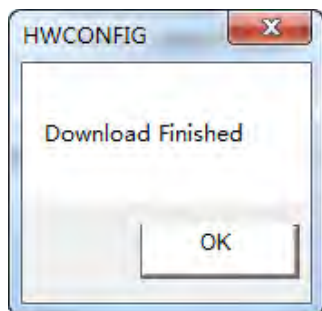

12. Return to the HWCONFIG window and right-click AS01DNET module to make the drop-down menu pop out. Select **Communication Software >> DeviceNet Builder** from the menu.

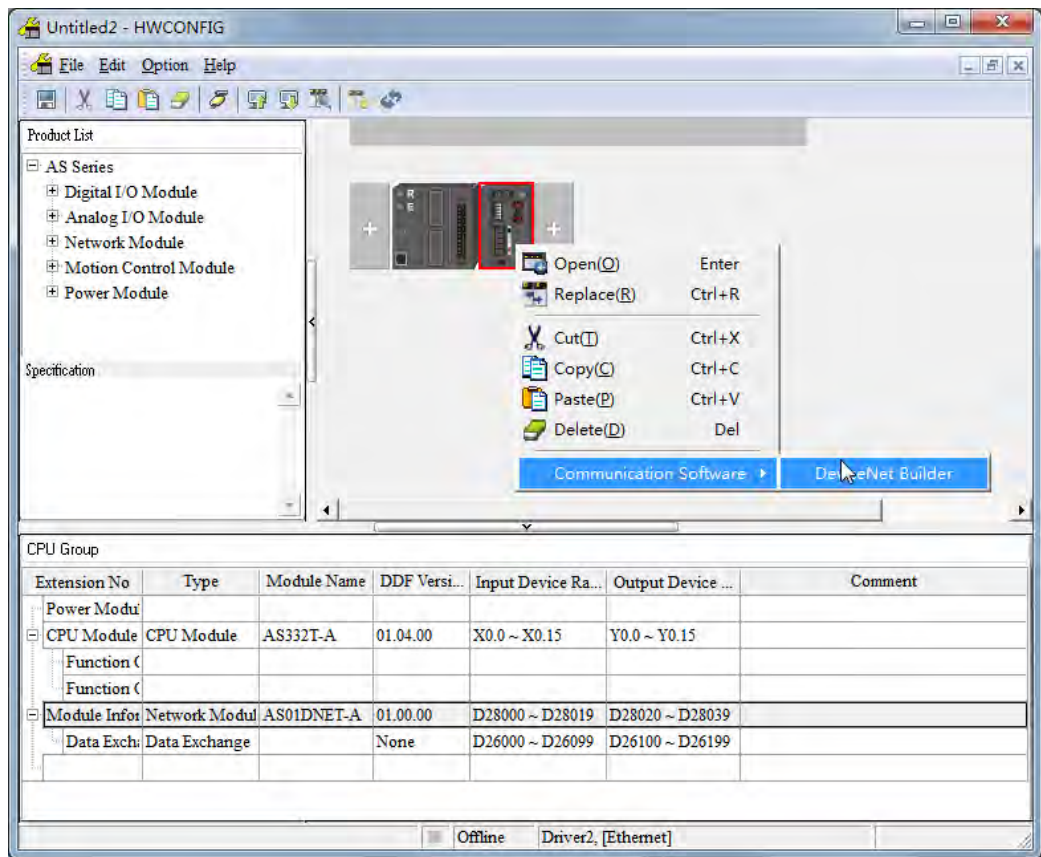

13. The following dialog box pops out. Click the **Yes** button there.

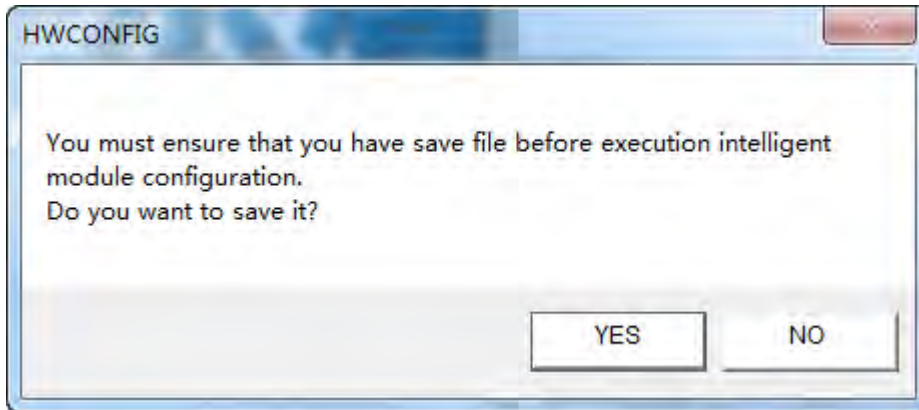

14. The DeviceNet Builder software is opened as below, which means the DeviceNet Builder software has been opened through the ISPSOft software.

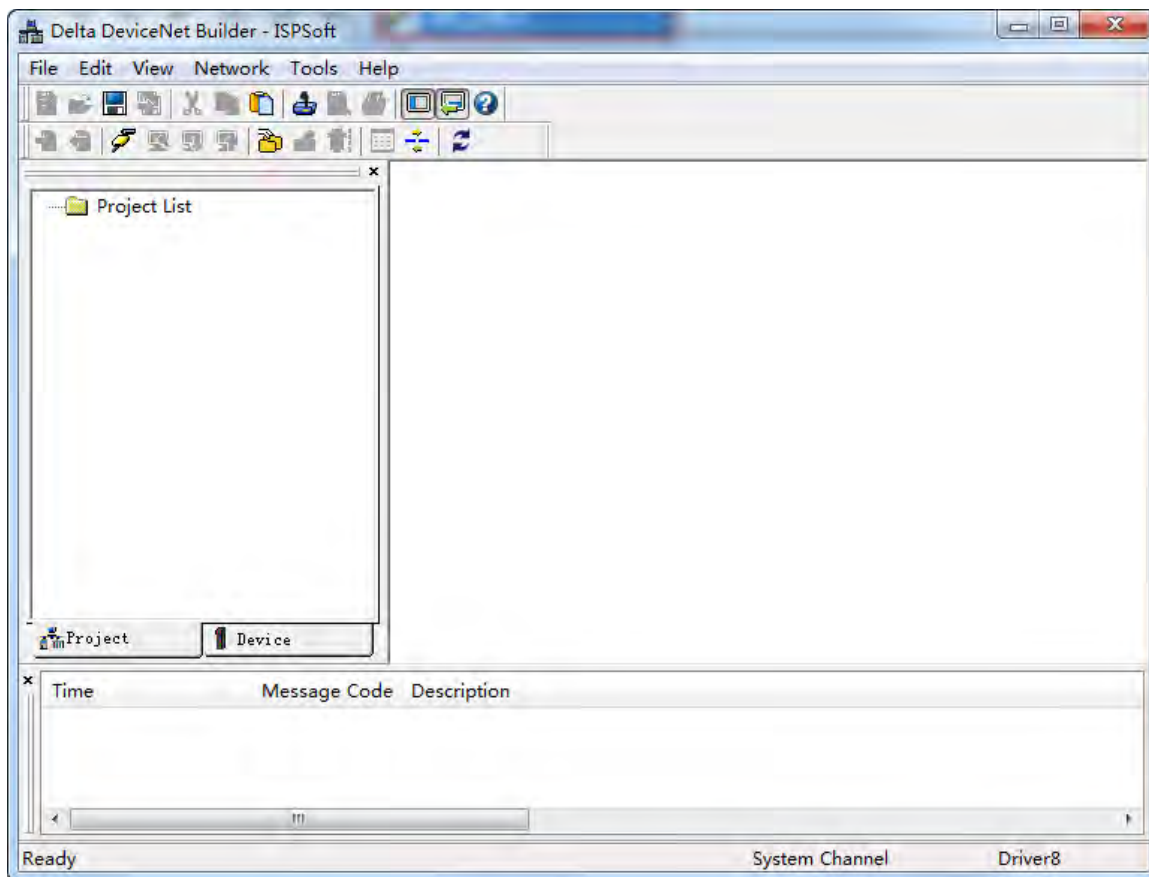

- Click menu **Network>> Online**.

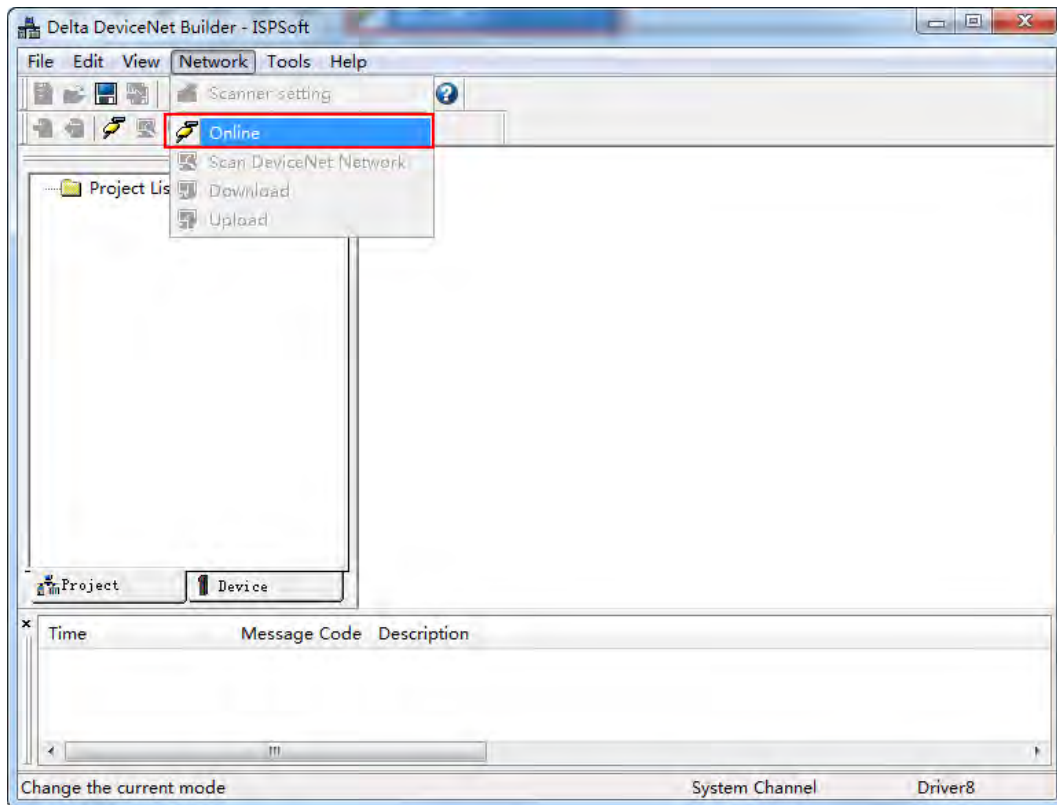

- The master module AS01DNET-A has been scanned as below.

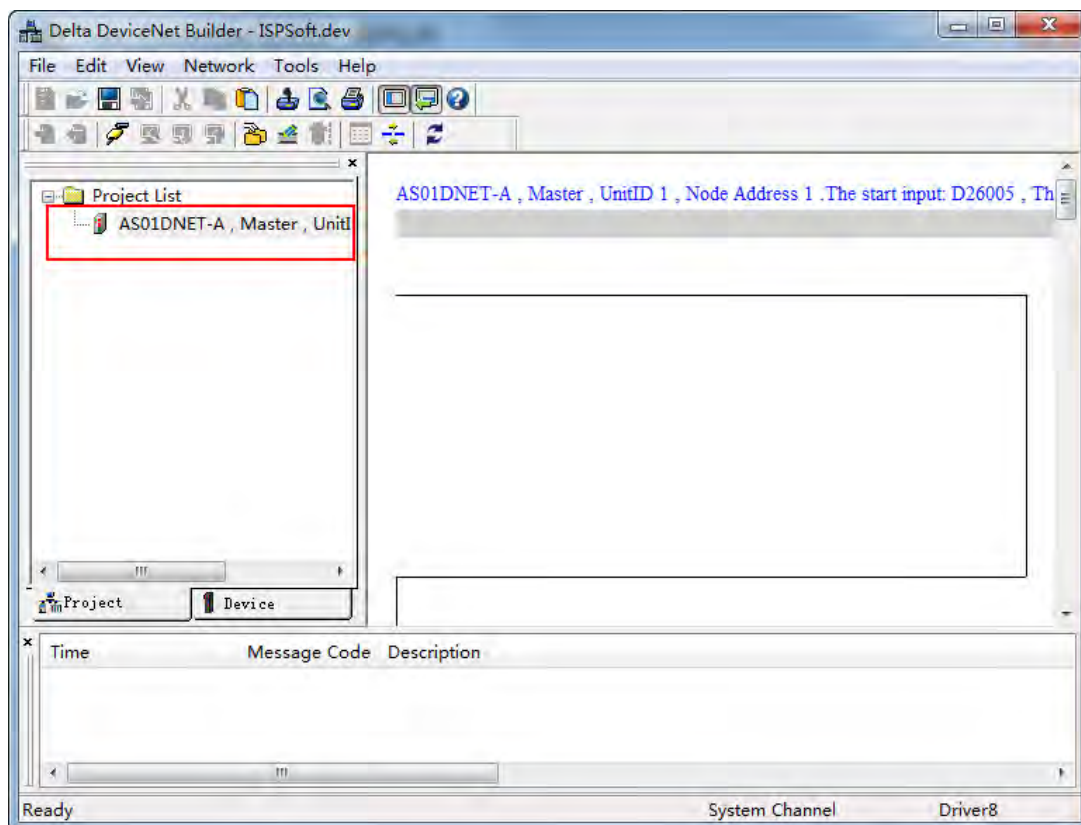

17. Right-click the master module AS01DNET-A under the left-side Project List. Then a drop-down list pops up. Click the option **Scan DeviceNet Network** from the list.

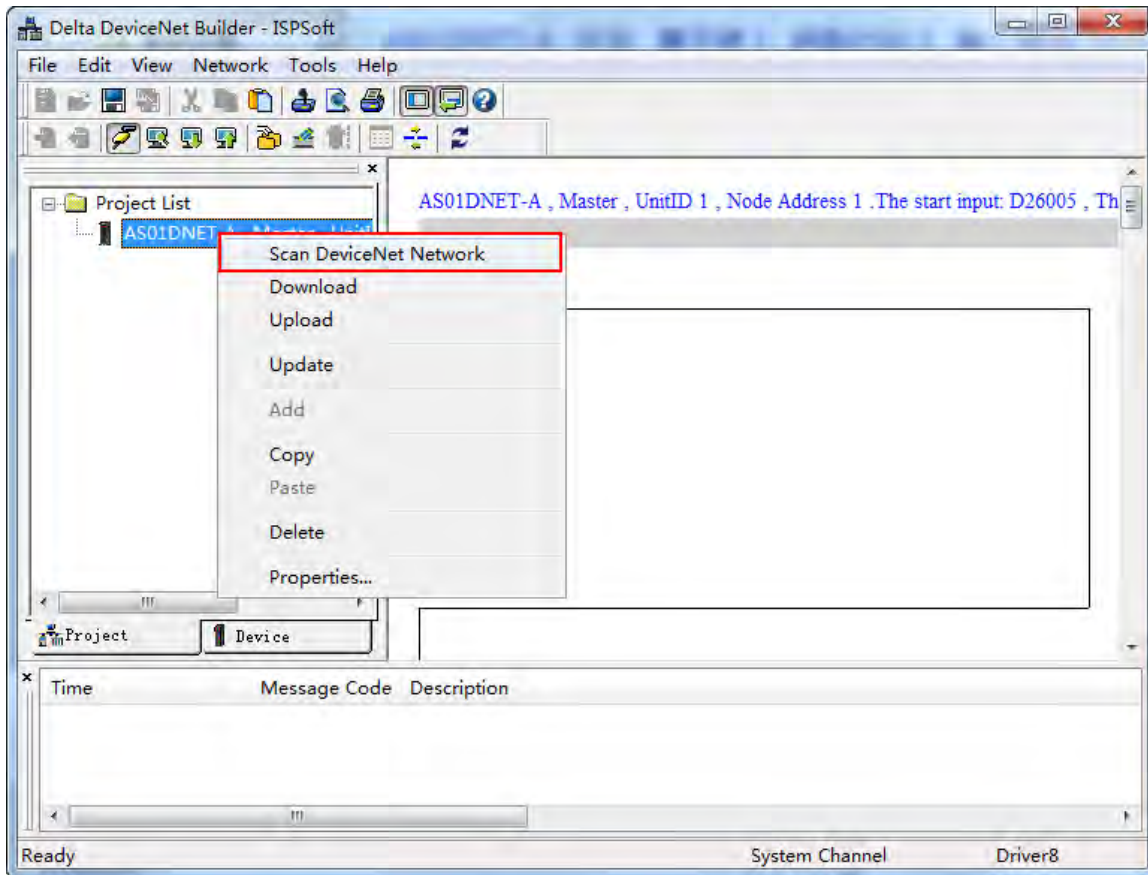

18. The following progress bar appears then.

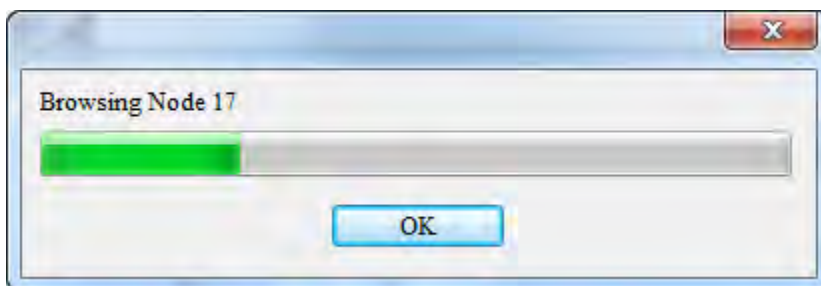

19. The master and slave which have been scanned both show up in the network.

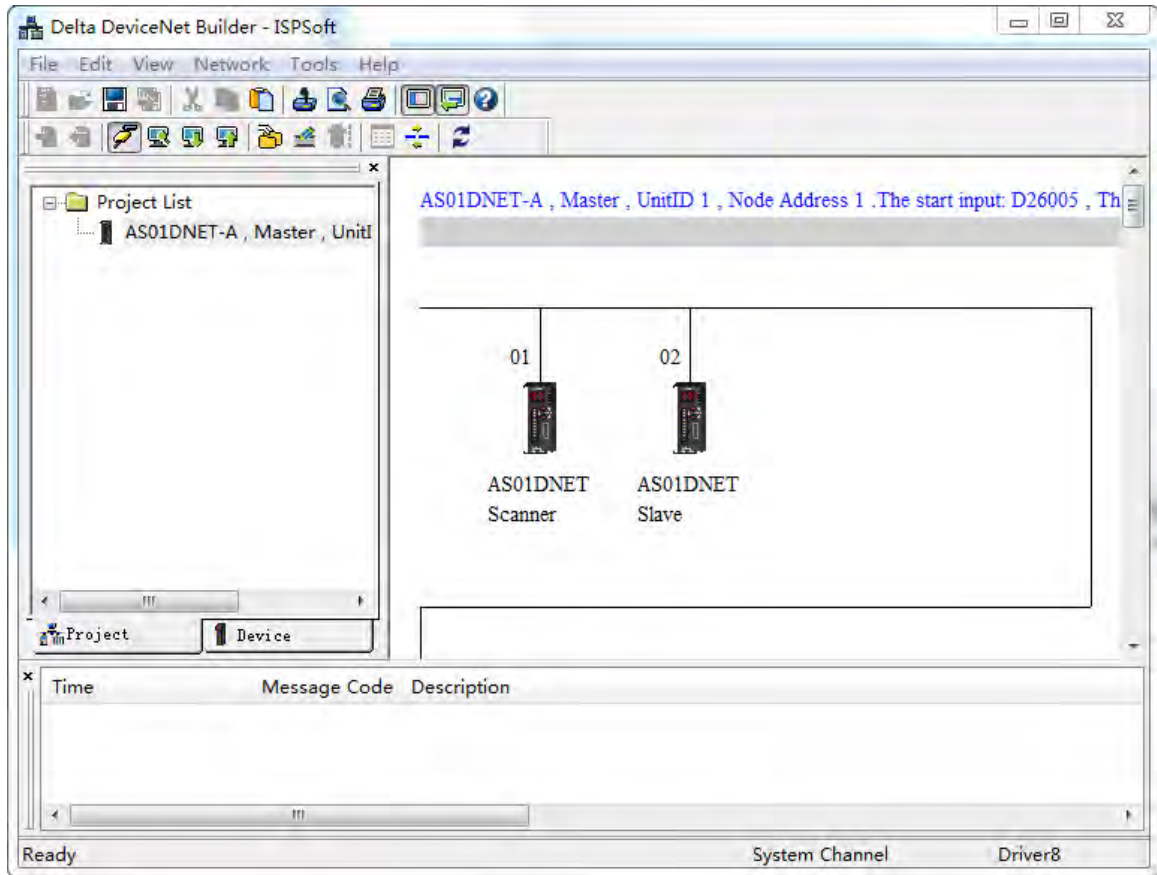

MEMO

11

Chapter 12 Positioning Module AS02/04

Table of Contents

12.1 Overview	12-2
12.1.1. Characteristics	12-2
12.2 Specifications and Functions	12-3
12.2.1. Specifications	12-3
12.2.2. Profile	12-5
12.2.3. Arrangement of Terminals	12-6
12.2.4. Special Features	12-8
12.2.5. Wiring	12-8
12.3 HWCONFIG in ISPSOft	12-11
12.3.1. Initial Setting	12-11
12.3.2. Checking the Version of a Module	12-13
12.3.3. Online Mode	12-15
12.3.4. Importing/Exporting a Parameter File	12-16
12.3.5. Parameters	12-18
12.3.6. Normal Exchange Area	12-20
12.4 Troubleshooting	12-21
12.4.1. Error Codes	12-21
12.4.2. Troubleshooting Procedure	12-21
12.4.3. State Codes (Axis 1 - 4)	12-21

12.1 Overview

This chapter describes the specifications for the positioning module, its operation, and its programming. On the analog input/output module, four channels receive analog signals (voltage or current), and converts those signals into 16-bit digital signals. In addition, the analog input/output module receives two blocks of 16-bit digital data from a CPU module, and converts the digital data into analog signals (voltage or current). The analog input/output module sends the analog signals by two channels. For software operation, ISPSOft, DIADesigner or DIADesigner-AX is what you need. If you are using AS Series PLC CPU, refer to ISPSOft User Manual or DIADesigner Manual for more information. The new software DIADesigner-AX only supports AX Series PLC CPU and AS Series modules now, refer to AX-3 User Manual for more information on software operation.

12.1.1 Characteristics

(1) **Use the AS02/04 PU-A module, based on its practical application.**

AS02PU-A: 2-axis differential output, 1 encoder

AS04PU-A: 4-axis NPN transistor (sinking) output

(2) **High-speed input/output**

AS02PU-A: high speed output frequency at 200 k Hz (A/B/Z phase) and 2-axis 200 k HZ differential output

AS04PU: 4-axis NPN transistor (sinking) output at 100 k Hz

(3) **Input/output**

AS02PU-A: 5 direct current input points (sinking or sourcing)

AS04PU-A: 6 direct current input points (sinking or sourcing)

(4) **Use the utility software to configure the module.**

The HWCONFIG utility software is built into ISPSOft. You can set modes and parameters directly in HWCONFIG of ISPSOft or Hardware Configuraition of DIADesigner without spending time writing programs to set registers to manage functions.

(5) **Specially designed instructions for the module**

You can use specially designed instructions to control the modules without spending too much time to figure out how to achieve the required applications.

12.2 Specifications and Functions

12.2.1. Specifications

- Electrical specifications for the inputs

Module Name		AS02PU-A		AS04PU-A
Input		High speed	Standard	Standard
Number of Input Points		3 (A+/A-, B+/B-, Z+/Z-)	5 (X0.0-X0.4)	6
Connector Type		Removable terminal block		
Input Form		Differential input	Direct current (sinking or sourcing)	Direct current (sinking or sourcing) Sinking: The inputs are NPN transistors whose collectors are open collectors. Sourcing: The inputs are PNP transistors whose collectors are open collectors.
Input Current		5-24 VDC, 5 mA	24 VDC, 5 mA	24 VDC, 5 mA
Action Level	OFF→ON	>3 VDC	>15 VDC	>15 VDC
	ON→OFF	<1.5 VDC	<5 VDC	<5 VDC
Response time		<2.5 μs	<0.5 ms	<0.5 ms
Maximum input frequency		200 k Hz (A+/A-, B+/B-, Z+/Z-)	10 k Hz	10 k Hz
Input impedance		4.7kΩ		
Input isolation voltage		500 VAC		
Input display		When the optocoupler is driven, the input LED indicator is ON.		
Weight		120 g		

- Electrical specifications for the outputs

Model		AS02PU-A	AS04PU-A
Item			
Number of outputs		Four (2-axis)	Eight (4-axis)
Connector type		Removable terminal blocks	
Output form		differential output	Transistor-T (sinking) (NPN)
Output current		5 VDC* ¹	5-30 VDC
Maximum load	Resistance	10 mA	0.1A
	Inductance	N/A	
	Bulb	N/A	
Maximum output frequency¹	Resistance	200 kHz	100 kHz
	Inductance	N/A	
	Bulb	N/A	
Maximum Response time	OFF→ON	0.1 μs	1.5 μs
	ON→OFF	0.1 μs	1.5 μs
Input isolation voltage		500 VAC	
Weight		120 g	

*1: Actual output: 4 VDC (high input impedance) to 3.3 VDC (10 mA)/output

12.2.2. Profile

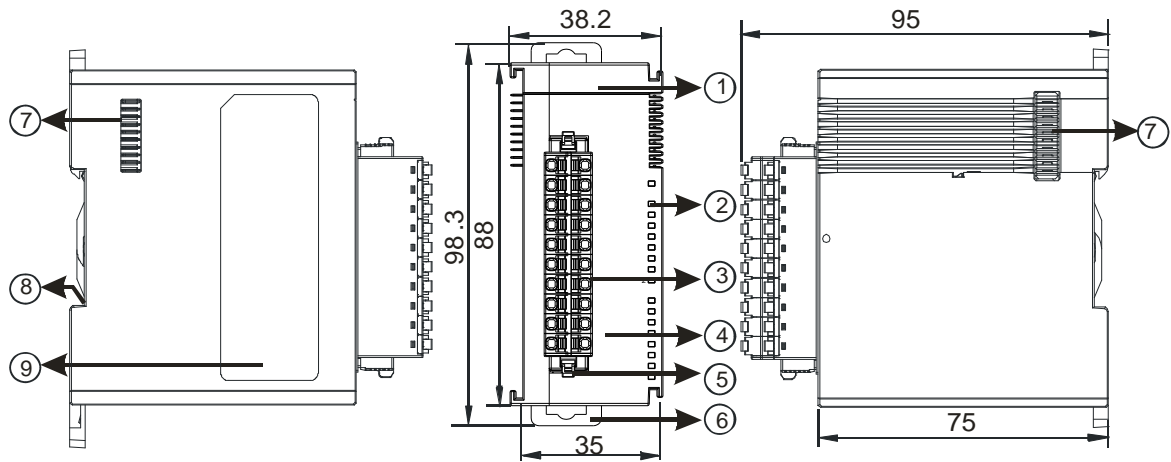

Unit: mm

Number	Name	Description
1	Model name	Model name of the module
2	POWER LED indicator (Blue)	Indicates the status of the power supply ON: the power is on OFF: no power
	Run LED indicator (Green)	Operating status of the module ON: the module is running and ready to accept instructions. OFF: the module is stopped and can NOT accept instructions.
	Error LED indicator (Red)	Error status of the module OFF: the module is normal. Blinking (0.2 seconds ON/OFF): hardware error occurs in the module, can NOT operate normally
	Input LED indicator (Red)	ON: Receives an input signal OFF: Receives no input signal
	Output LED indicator (Red)	ON: Receives an output signal OFF: Receives no output signal
3	Removable terminal block	The inputs are connected to sensors. The outputs are connected to loads to be driven.
4	Arrangement of the input/output terminals	Arrangement of the terminals
5	Terminal block clip	Removal of the terminal block
6	DIN rail clip	Secures the module onto the DIN rail

Number	Name	Description
7	Module connecting set	Connects the modules
8	Ground clip	On the DIN reail for grounding
9	Label	Nameplate

12.2.3. Arrangement of Terminals

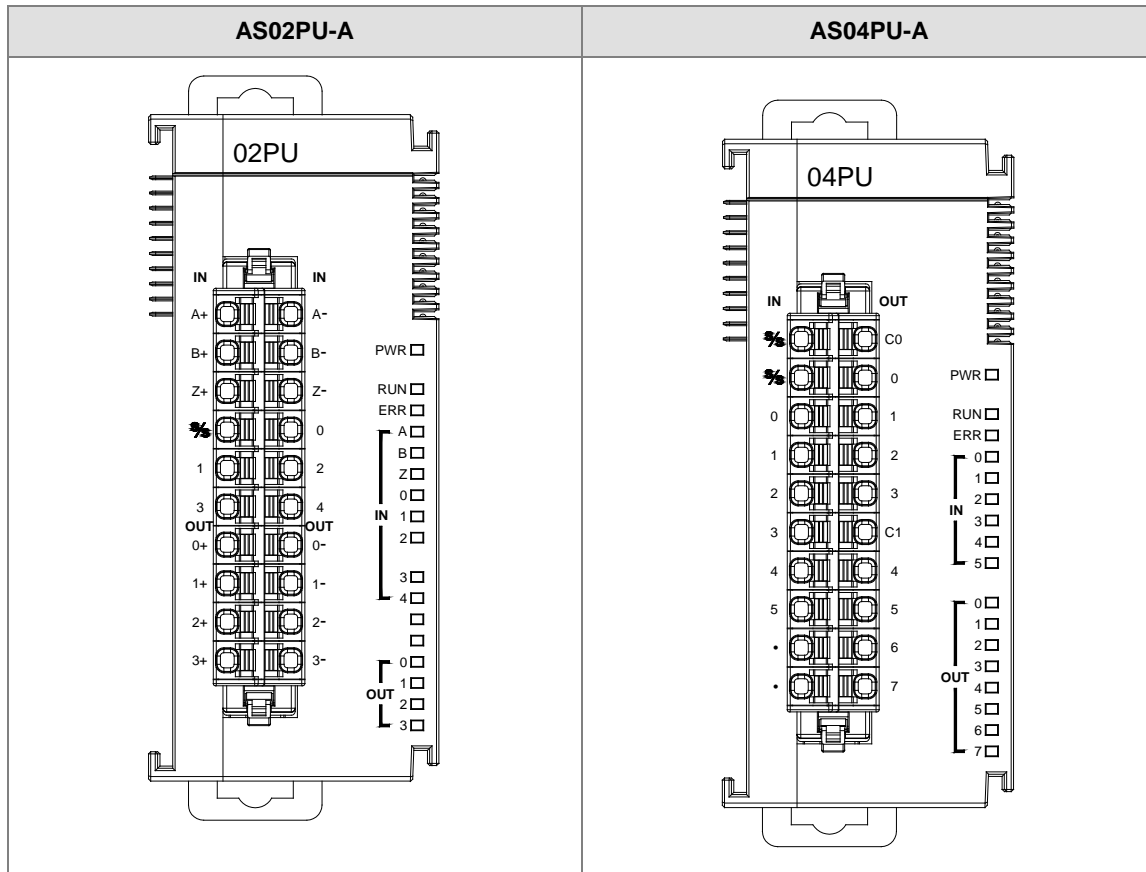

AS02PU-A				AS04PU-A			
Wordings with the same indications that are used on the terminal block and manual				Wordings with the same indications that are used on the terminal block and manual			
Manual	Terminal Block (left)	Manual	Terminal Block (right)	Manual	Terminal Block (left)	Manual	Terminal Block (right)
A+	A+	A-	A-	S/S	S/S	C0	C0
B+	B+	B-	B-	S/S	S/S	Y0.0	0
Z+	Z+	Z-	Z-	X0.0	0	Y0.1	1
S/S	S/S	X0.0	0	X0.1	1	Y0.2	2
X0.1	1	X0.2	2	X0.2	2	Y0.3	3
X0.3	3	X0.4	4	X0.3	3	C1	C1
Y0.0+	0+	Y0.0-	0-	X0.4	4	Y0.4	4
Y0.1+	1+	Y0.1-	1-	X0.5	5	Y0.5	5
Y0.2+	2+	Y0.2-	2-		•	Y0.6	6
Y0.3+	3+	Y0.3-	3-		•	Y0.7	7

12.2.4. Special Features

The following special instructions (API 14) are designed for AS Positioning Modules, for example, setting output control parameters, reading output status, pulse output (no acceleration), relative position output (with acceleration and deceleration), absolute addressing output (with acceleration and deceleration), homing, jog output, MPG output, and high-speed counter function. Refer to section 6.15 (API 14) in AS Programming Manual for more information.

12.2.5. Wiring

● Precautions

To ensure the positioning module functions well and reliably, the external wiring must prevent noise. Before you install the cables, follow the precautions below.

- (1) To prevent a surge and induction, the AC cable and the input signal cables that are connected to the AS02/04PU-A must be separate cables.
- (2) Do not install the cable near a main circuit, a high-voltage cable, or a cable connected to a load that is not a PLC. In addition, the cable must not be bound to a main circuit, a high-voltage cable, or a cable connected to a load which is not a PLC.
- (3) Ground shielded cables and hermetically sealed cables separately.
- (4) Terminals with insulation sleeves cannot be arranged as a terminal block, so you should cover the terminals with insulation tubes.
- (5) Use single-core cables or twin-core cables with a diameter of 24–22 AWG and with pin-type connectors smaller than 1 mm. The plastic jackets that are removed from the cables should be 8 mm to 10 mm long. Only use copper conducting wires which can withstand temperatures of 60° C /75° C or higher.

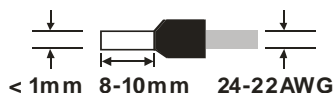

- (6) Note: use cables with the same length (less than 200 m) and use wire resistance of less than 100 ohm.
- (7) Notes on two-wire, three-wire, and four-wire connections:
 - Two-wire connection/three-wire connection (passive transducer): connect the transducer and the analog input module to the same power circuit.
 - Four-wire connection (active transducer): the transducer uses an independent power supply, so do not connect it to the same power circuit as the analog input module.

● External wiring

(1) AS02PU-A

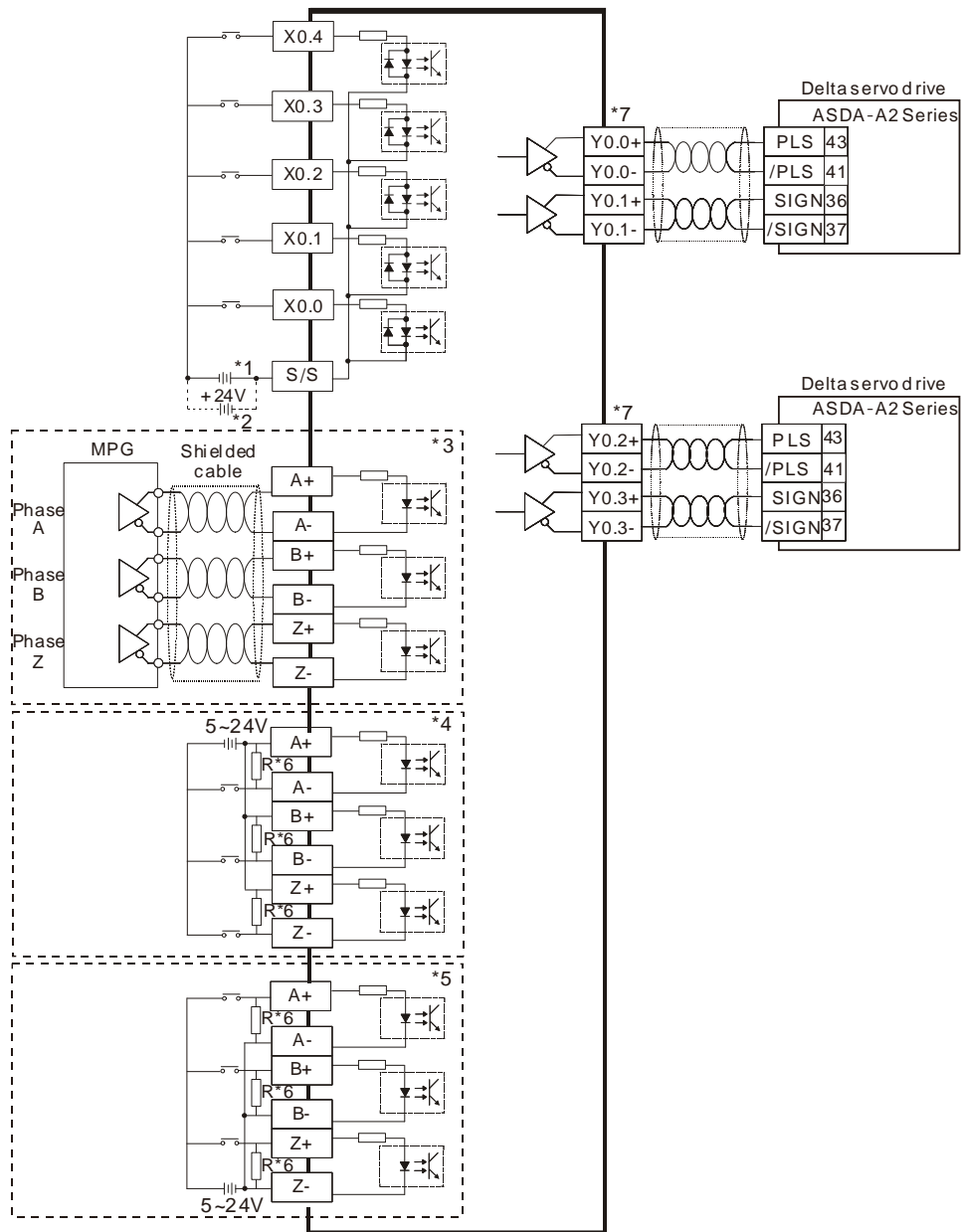

*1. Sinking

*2. Sourcing

*3. Differential input

*4. Open collector sinking

*5. Open collector sourcing

*6. Open collector sinking/sourcing to connect to phase A/B/Z and if the input frequency is higher than 100 kHz, add a 3W/470 ohm resistor between + the positive end and - the negative end.

*7. Refer to API1402 in AS Series Programming Manual and Delta Servo Drive Manual for more information on the output mode.

(2) AS04PU-A

12

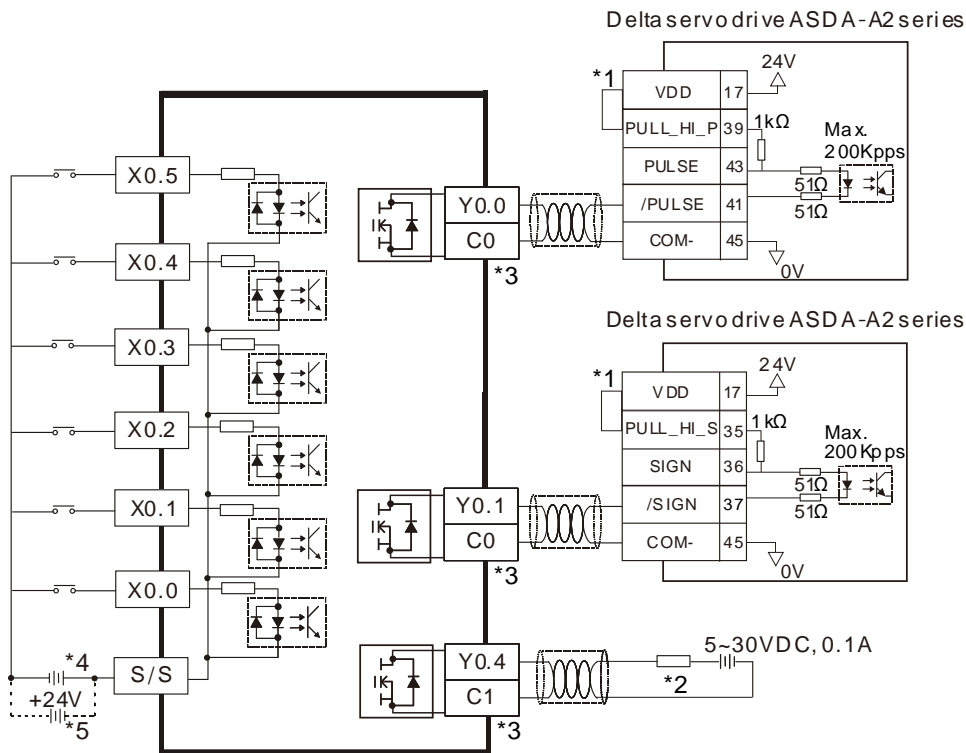

*1. VDD and COM are seen as a group and its power is provided by Delta servo drive.

*2. It is a load or an input point.

*3. Use the same power supply for the same COM group.

*4. Sinking

*5. Sourcing

12.3 HWCONFIG in ISPSOft

12.3.1. Initial Setting

- (1) Start ISPSOft and double-click **HWCONFIG**.

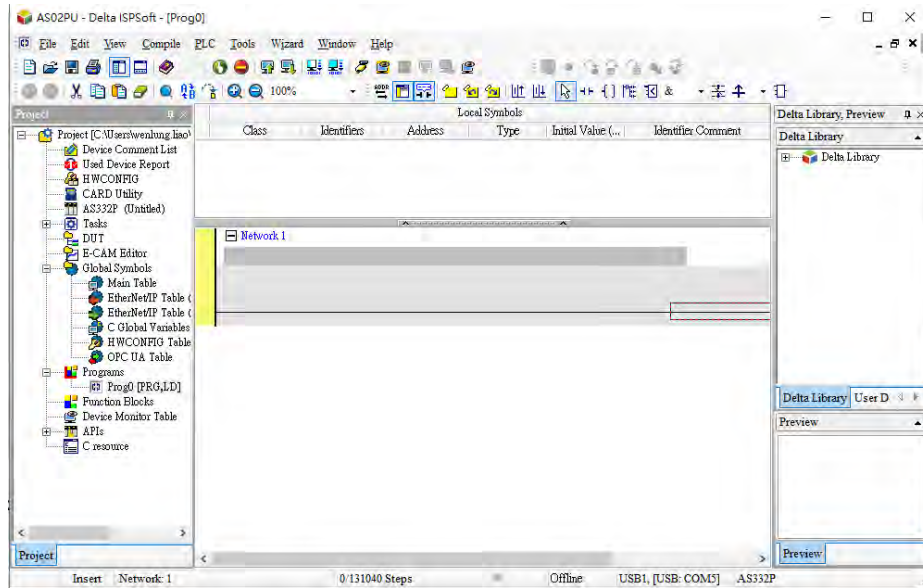

- (2) Select a module and drag it to the working area.

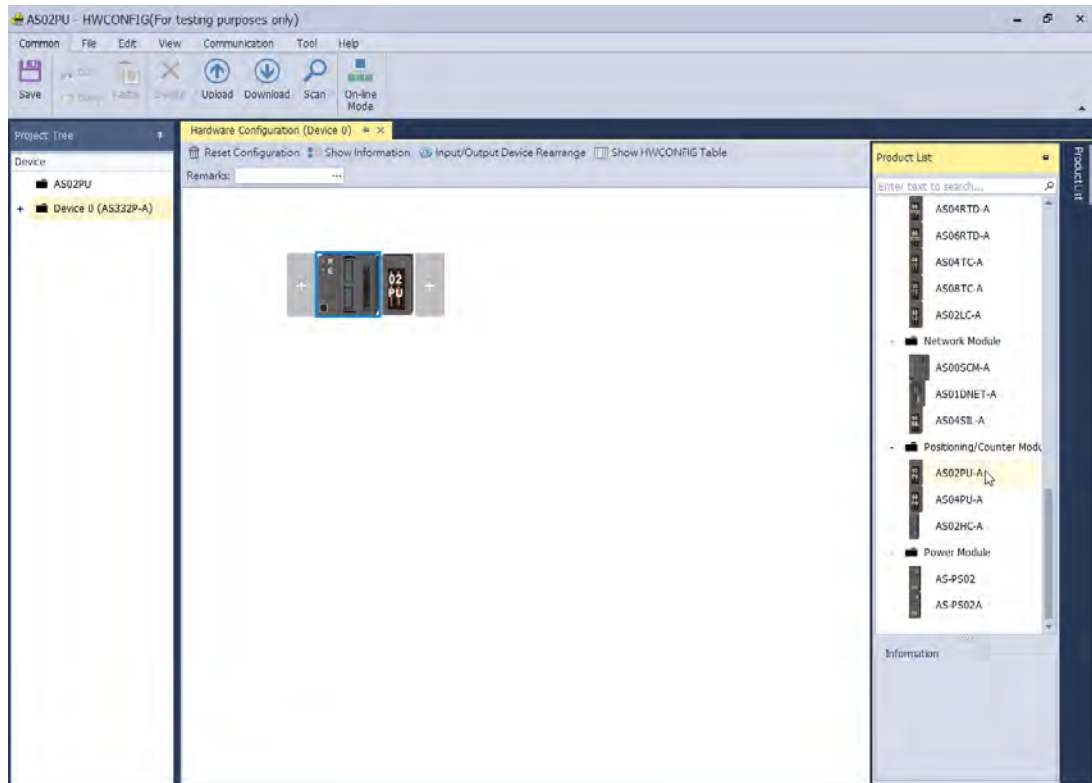

(3) Double-click the module in the working area to open the Setting page.

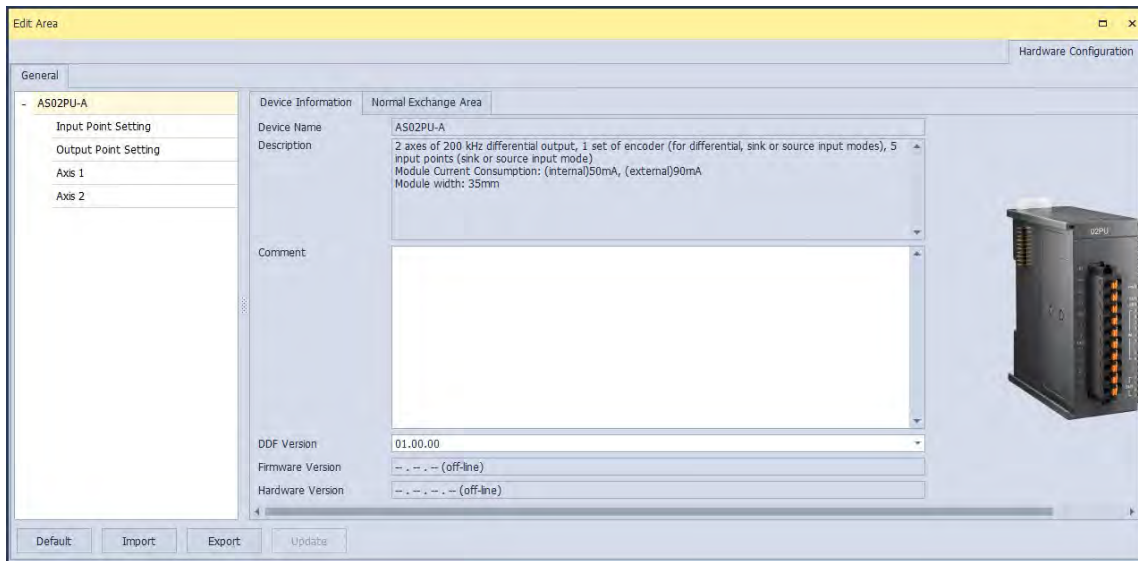

(4) Choose the parameter, set the values, and close the setting page.

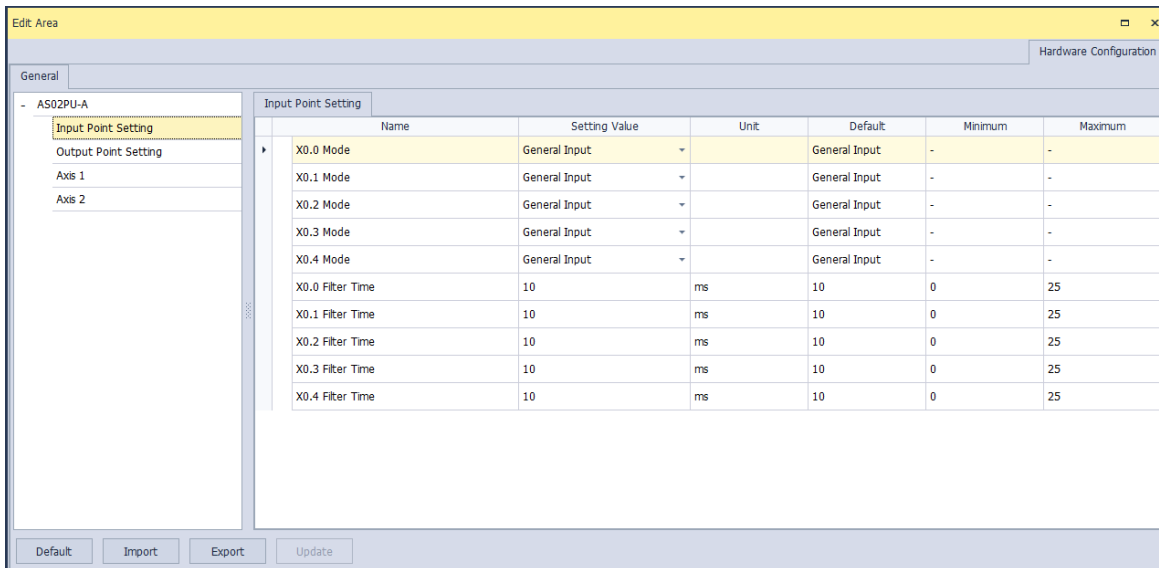

- (5) Click **Download** on the toolbar to download the parameters. Note that you cannot download the parameters while the CPU module is running.

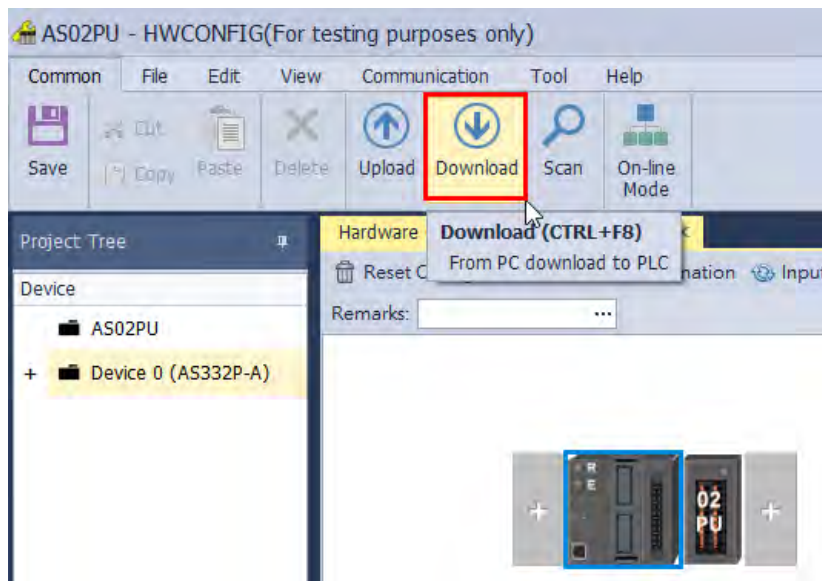

12.3.2. Checking the Version of a Module

- (1) On the **Common** menu, click **On-line Mode**.

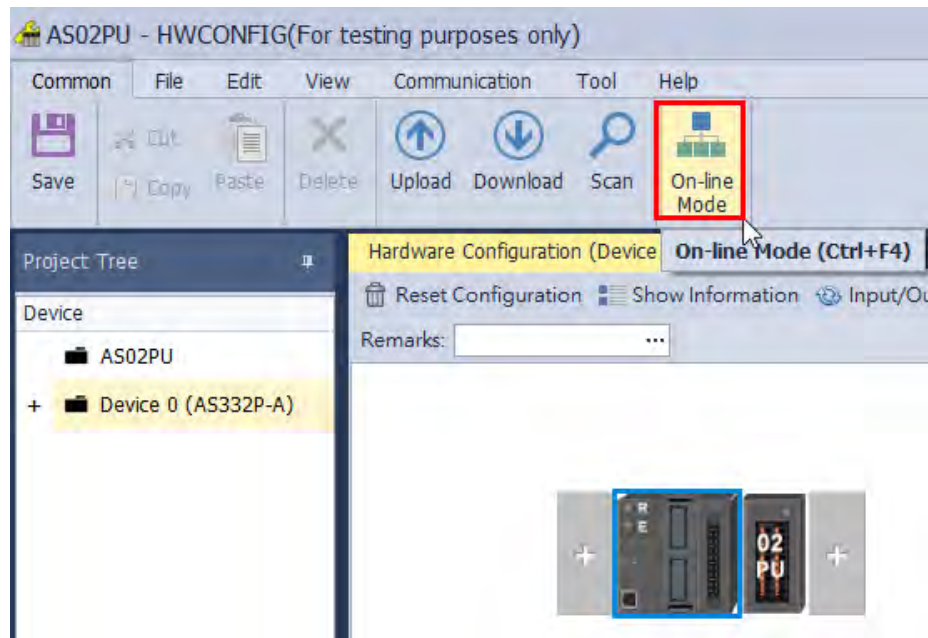

- (2) Double-click the module to open the Setting page. The versions of both the firmware and the hardware are displayed.



12

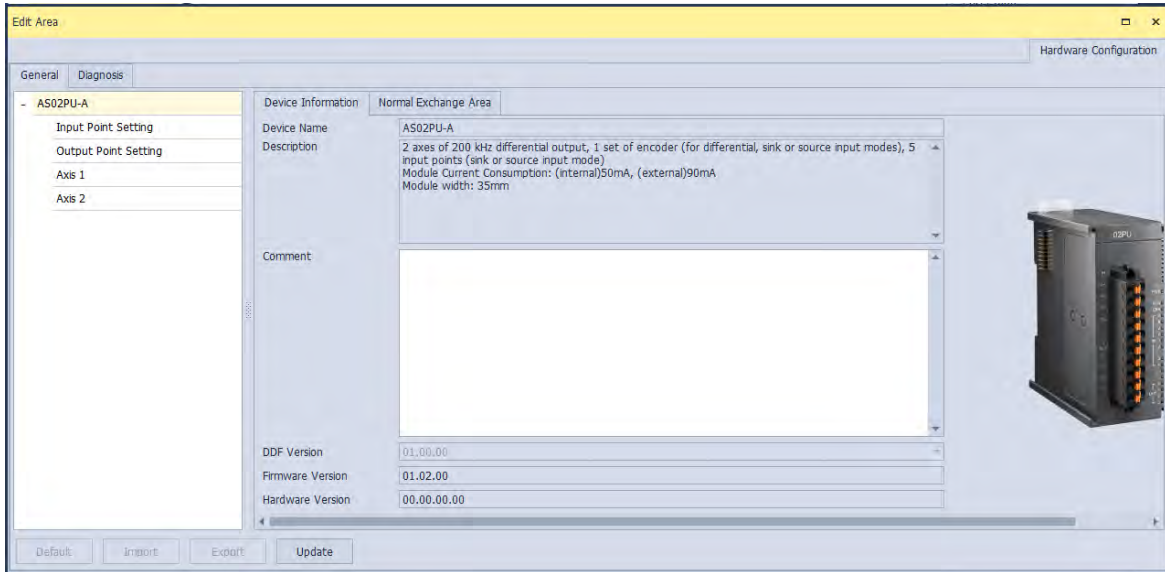

12.3.3. Online Mode

(1) On the **Option** menu, click **Online Mode**.

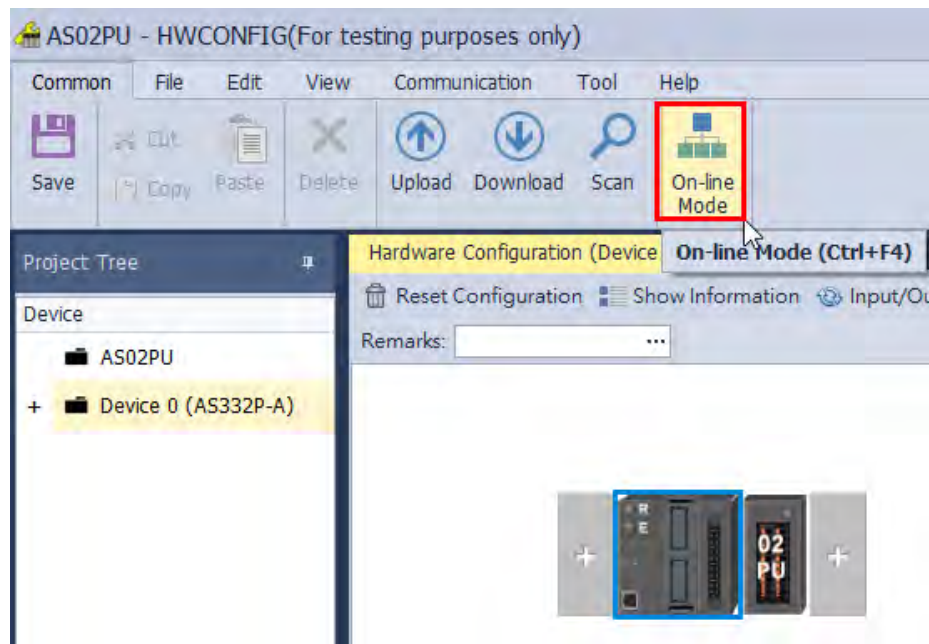

(2) Right-click the module and click **Module Status**.

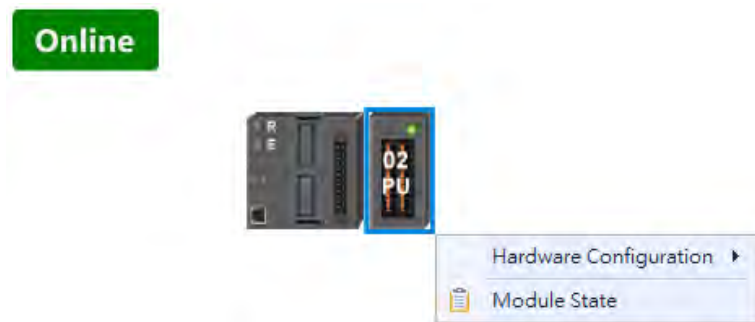

(3) View the module status.

Channel	Value (Decimal)
Error code	0
Axis 1 current position	-131731069
Axis 1 current speed	0
Axis 2 current position	-131731009
Axis 2 current speed	0
Input status	0
Status code(Axis 1 / Axis...	0
MPG input pulse	0
MPG input frequency	0

12

12.3.4. Importing/Exporting a Parameter File

(1) Click **Export** in the Device Settings dialog box to save the current parameters as a dep file (.dep).

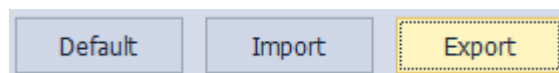

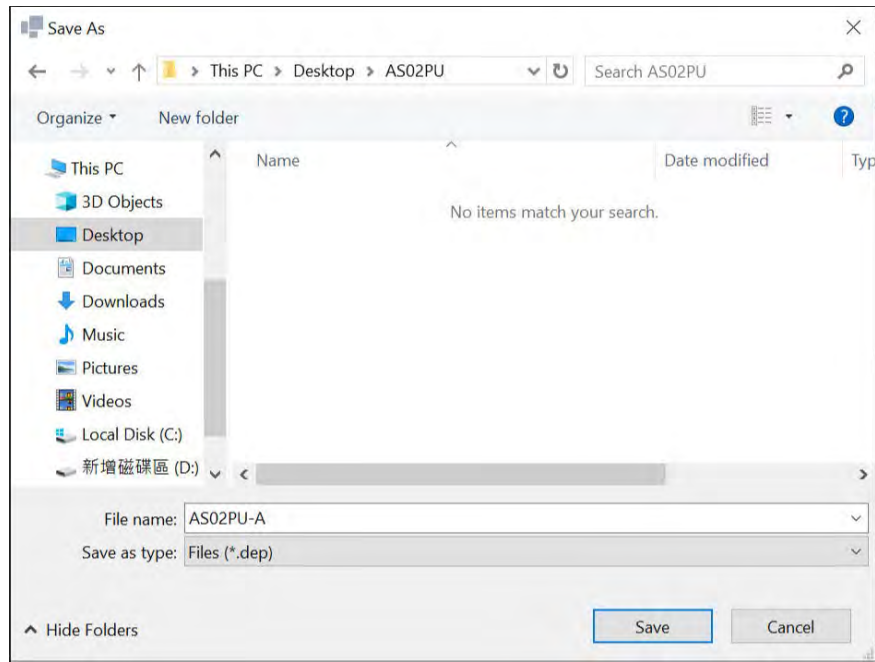

(2) Click **Import** in the Device Settings dialog box and select a .dep file to import saved parameters.

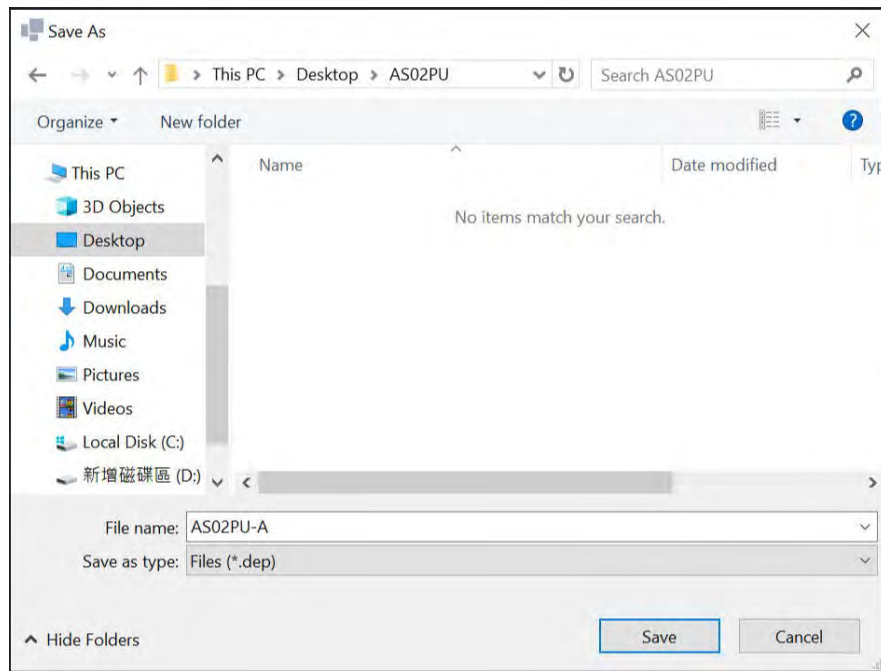
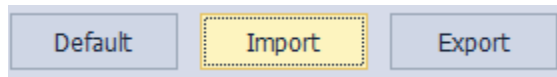

12.3.5. Parameters

- The input point settings

You can set values in the input points as the triggering conditions (phase Z, DOG, LSN, LSP) for the axis1 and axis 2 to position. Rising-edge and falling-edge can also be specified in the triggering conditions.

12

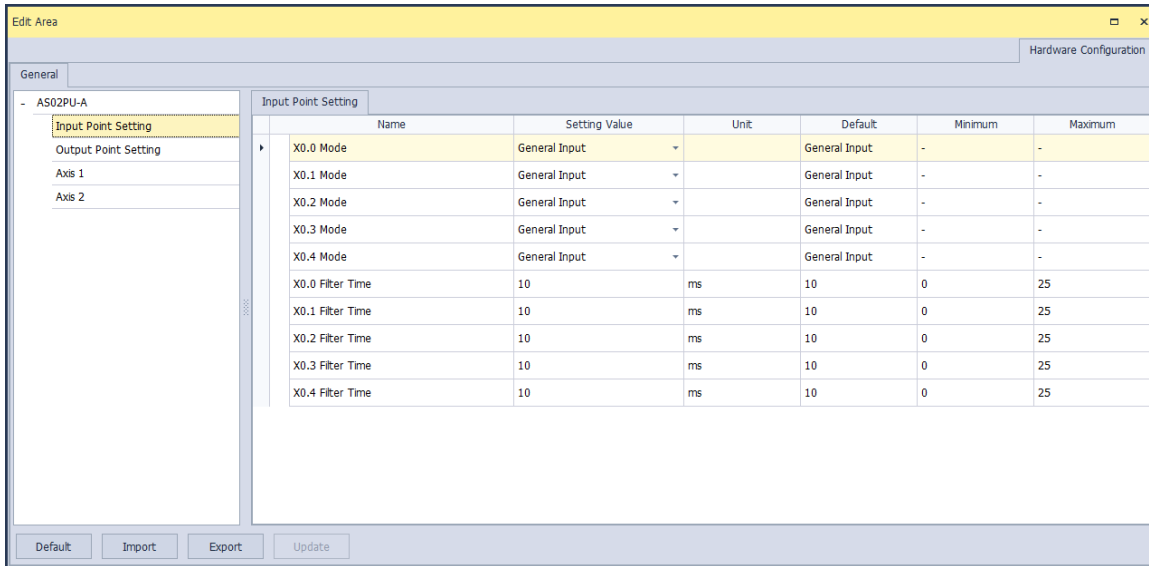

The example shows X0.0 is Axis 1 DOG falling edge triggered.

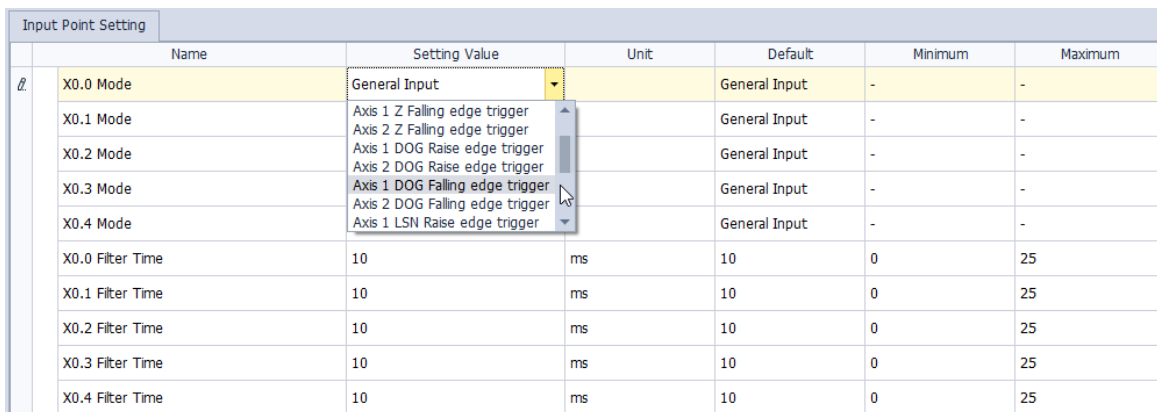

- Filter time settings

The default setting is 10 ms; the system filters out distortion and noises in a pulse width modulated transmission that is below 10 ms.

- The output point settings

You can set values in the output points (single pulse output, pulse + direction, CW+CCW, A phase + B phase). Refer to API1402 in AS Series Programming Manual for more information on output modes.

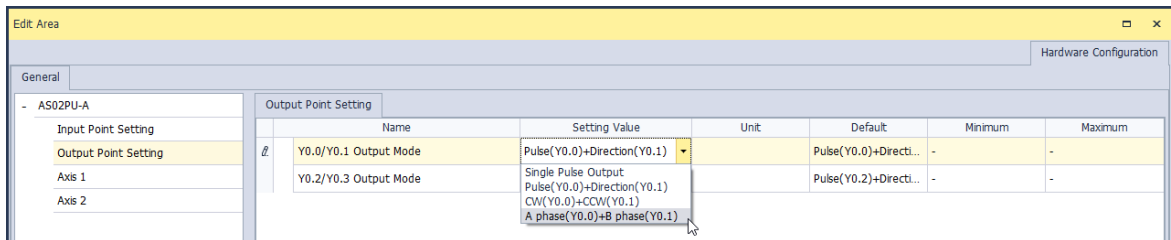

- Axis settings

You can set up the axis in HWCONFIG or through positioning instructions. Use API1402 to set up the followings starting speed, accelation time, deceleration time, max. speed, seeking the set number of Z phase after homing, output the offset position after homing. Use API1407 to setup homing mode. Refer to API1402 – 1410 in AS Series Programming Manual for more information on the settings of axis.

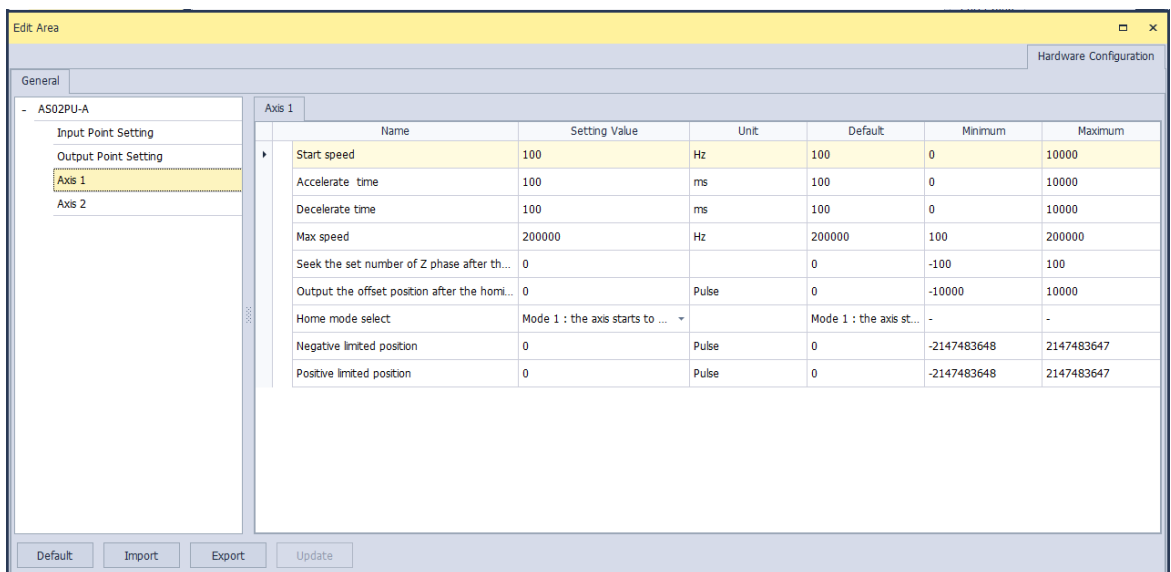

12.3.6. Normal Exchange Area

For data exchange among the CPU module and the modules, the system assign special devices for specified parameters.

- AS02PU-A

Edit Area		
General		
- AS02PU-A	Device Information	Normal Exchange Area
Input Point Setting	Description	
Output Point Setting	Address	
Axis 1	▶ - Input	
Axis 2	Error code	D28000
	Axis 1 current position	D28001 - D28002
	Axis 1 current speed	D28003 - D28004
	Axis 2 current position	D28005 - D28006
	Axis 2 current speed	D28007 - D28008
	Input status	D28009
	Status code(Axis 1 / Axis 2)	D28010
	MPG input pulse	D28011 - D28012
	MPG input frequency	D28013 - D28014

- AS04PU-A

Edit Area		
General		
- AS04PU-A	Device Information	Normal Exchange Area
Input Point Setting	Description	
Output Point Setting	Address	
Axis 1	▶ - Input	
Axis 2	Error code	D28020
Axis 3	Axis 1 current position	D28021 - D28022
Axis 4	Axis 1 current speed	D28023 - D28024
	Axis 2 current position	D28025 - D28026
	Axis 2 current speed	D28027 - D28028
	Axis 3 current position	D28029 - D28030
	Axis 3 current speed	D28031 - D28032
	Axis 4 current position	D28033 - D28034
	Axis 4 current speed	D28035 - D28036
	Input status	D28037
	Status code(Axis 1 / Axis 2)	D28038
	Status code(Axis 3 / Axis 4)	D28039

12.4 Troubleshooting

12.4.1. Error Codes

Error Code	Description	A↔D LED indicator	ERROR LED indicator
16#1802	Hardware failure	OFF	Blinking

12.4.2. Troubleshooting Procedure

Description	Procedure
Hardware failure	Return the module to the factory for repair.

12.4.3. State Codes (Axis 1 - 4)

State Code Byte #	Description	Axis 1-2	Axis 3-4
0	Error flag	Axis 1	Axis 3
1	The output is active.		
2	The output has stopped working.		
3	The instruction execution is complete.		
4	Pulse in positive direction not allowed		
5	Pulse in negative direction not allowed		
6	Current position value overflow		
7	Pulse direction (positive or negative)	Axis 2	Axis 4
8	Error flag		
9	The output is active.		
10	The output has stopped working.		
11	The instruction execution is complete.		
12	Pulse in positive direction not allowed		
13	Pulse in negative direction not allowed		
14	Current position value overflow		
15	Pulse direction (positive or negative)		

MEMO

Chapter 13 IO-Link Communication Module AS04SIL

Table of Contents

13.1 Overview	13-2
13.1.1 Firmware and Software Versions	13-2
13.2 Specification and Wiring	13-3
13.2.1 Specifications.....	13-3
13.2.2 Profile	13-5
13.2.3 Wiring.....	13-6
13.3 Functions	13-8
13.3.1 Basic Functions	13-8
13.3.2 Application Functions	13-14
13.4 Application Examples	13-16
13.4.1 Using AS Series CPU as Upper Device	13-16
13.4.2 Using AH Series CPU or Non-Delta Master PLC as Upper Device	13-17
13.4.3 Application of AS Special Remote Mode.....	13-18
13.4.4 Application of Delta Special Driver & AS Remote Mode	13-30
13.4.5 Application of CANopen DS301 Mode	13-32
13.5 IO-Link Event Code Table	13-39
13.6 Module Status Codes	13-41

13.1 Overview

Thank you for using the IO-Link master module AS04SIL-A. To ensure that your AS04SIL-A is installed and operated correctly, read this manual carefully before using the module.

The AS04SIL-A module is an AS series IO-Link communication module (hereafter referred to as “SIL” module) connected on the right side of AS CPU module or AS00SCM-A (RTU mode). When the communication card AS-FCOPM is being used together, they serve as a CAN remote device. SIL provides 4 channels, which can be separately configured in IO-Link master or standard I/O (SIO) mode. IO-Link master can freely connect with IO-Link devices and supports the hybrid use of IO-Link sensors and traditional sensors. Digital I/O of the SIL module can be extended with IO-Link hubs so that the sensors which do not support IO-Link can be connected to. Therefore it is pretty flexible to use the SIL module.

The setup software for AS04SIL-A is HWCONFIG 4.0 which is built in ISPSOft. Go to Delta official website to download and install ISPSOft.

13

13.1.1 Firmware and Software Versions

Firmware			
Model	AS series CPU	AS00SCM-A	AS04SIL-A
Version	V1.08.50 and later	V2.06 and later	V1.00 and later

Software			
Model	ISPSOft	HWCONFIG 4.0	AS00SCM-A CANopen EDS file (Remote DS301 Mode)
Version	V3.12 and later	V4.02 and later	V2.06 and later

13.2 Specification and Wiring

13.2.1 Specifications

- Unit Specification

Item		Specifications
Module type		IO-Link master
Model name		AS04SIL-A
Number of IO-Link ports		4
Communication	Baud rate	4.8kbps, 38.4kbps,230.4kbps
	Topology	1 : 1
	Compliant standards	<ul style="list-style-type: none"> ● IO-Link Interface and System Specification Version 1.1.2 ● IO-Link Tester Specification Version 1.1.2
Mode	IO-Link	Yes
	SIO (DI)	Yes
	SIO (DO)	Yes, up to 100 mA / channel
Cyclic communications		Min. 2 ms; dynamic, according to the valid data length
Input: data size in each communication port		Max. 32 bytes
Output: data size in each communication port		Max. 32 bytes
Input: data size in each module		Max. 128 bytes
Output: data size in each module		Max. 128 bytes
Input PDO data size		Max. 100 words
Output PDO data size		Max. 100 words
Backup		Yes
Cable specification	Type	Unshielded (can also apply to shielded ones)
	Length	Max. 20 m
	Electrostatic capacity between lines	Max. 3 nF
	Loop resistance	Max. 6 Ω
External connection terminals		Removable terminal block, clamping connector

● Electrical Specifications

Item		Specifications
Power supply to device in IO-Link mode or SIO (DI) mode	Rated voltage	24VDC (20.4VDC~ 28.8VDC) (-15%~+20%)
	Max. load current	0.2A/port
	Short-circuit protection	Yes
Digital inputs in SIO (DI) mode	Internal I/O common	NPN, PNP
	Input voltage/current	24VDC, 5mA
	ON voltage	>15VDC
	OFF voltage	<5VDC
	Filter time	0~65 ms (0: no filter)
Digital outputs in SIO (DO) mode	Internal I/O common	NPN, PNP
	Output voltage/current	24VDC (20.4VDC~ 28.8VDC),0.1A/port
	Short-circuit protection	Yes
	Leakage current	<0.1mA
	Residual voltage	<1.5VDC
Digital inputs for Pin2 in IO-Link mode	Internal I/O common	NPN, PNP
	Input voltage/current	24 VDC, 2mA
	ON voltage	>15VDC
	OFF voltage	<5VDC
	Filter time	0~65 ms (0: no filter)
Isolation voltage	500 VAC	
Power consumption	0.8W	
Weight	133g	

13.2.2 Profile

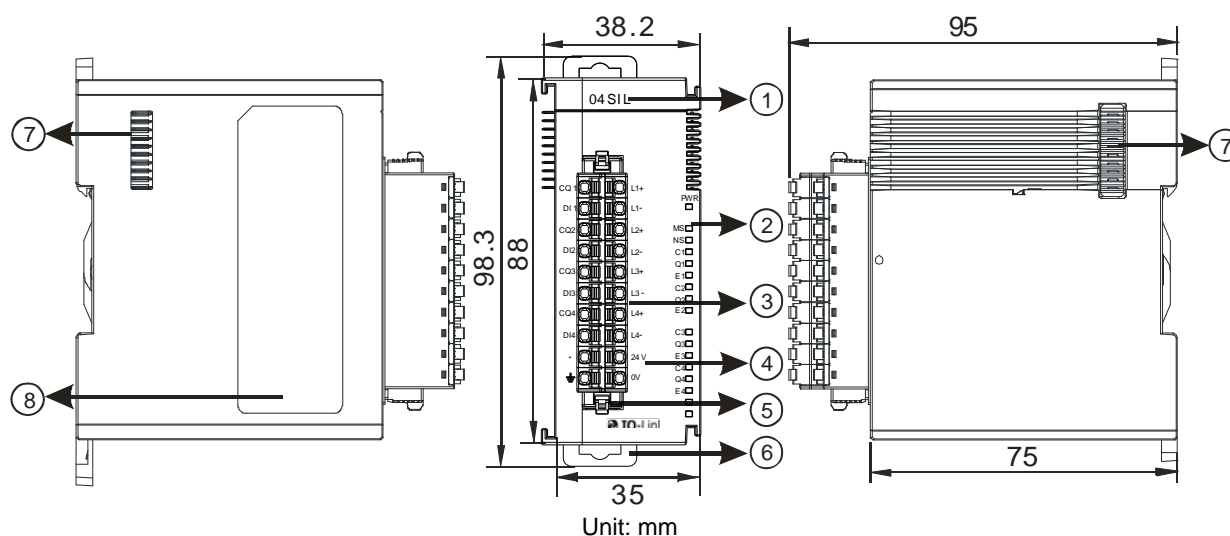

Unit: mm

Number	Name	Description
1	Model name	Model name of the module
2	POWER LED indicator (Blue)	Indicates the status of the power supply ON: the power is on OFF: no power or the power voltage is too low
	Module LED indicator (Red)	Error status of the module OFF: The module is normal. ON: The communication with its left-side PLC or RTU module fails. Blinking: 1. Module setting or communication error (blinks every 1 second) 2. Hardware or low voltage error (blinks every 0.2 second)
	Network LED indicator (Orange)	Error status of the network ON: No external power supply Blinking: Scanning is ongoing or the module is already configured and the diagnosis is done. OFF: The module has been configured but the diagnosis has not done yet.
	C1, C2, C3, C4 LED indicator (Orange)	IO-Link connection status of each communication port ON: The communication port is in IO-Link mode and a device is connected. Blinking: The communication port is in IO-Link mode but no device is connected or the device connected is not configured. OFF: The communication port is disabled or in SIO mode.
	Q1, Q2, Q3, Q4 LED indicator (Orange)	Indicates the status of input / output in SIO mode ON: The input/output is working in SIO mode. OFF: The communication port is disabled or in IO-Link mode.
3	E1, E2, E3, E4 LED indicator (red)	Indicates if any warning or error occurs in each communication port of the IO-Link connection. Blinking: A warning or an error occurs OFF: No warnings or errors
	Removable terminal block	IO-Link

Number	Name	Description
4	Arrangement of the input/output terminals	Arrangement of the terminals
5	Terminal block clip	Removal of the terminal block
6	DIN rail clip	Secures the module onto the DIN rail
7	Module connecting set	Connects the modules
8	Label	Nameplate

13.2.3 Wiring

13.2.3.1 IO-Link Mode Wiring for Power and Communication

Precautions:

1. Keep the input cables, output cables and power cable separate from one another. It is suggested to use independent power for AS04SIL-A. See the example below.

13

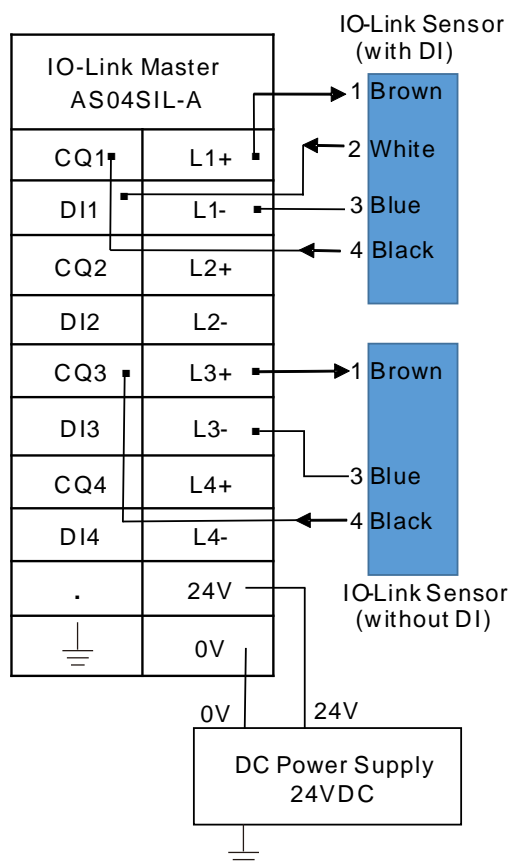

2. The 24 VDC cable should be twisted and connected to a module within a short distance.
3. Do not bundle 110 VAC cable, 220 VAC cable, 24 VDC cable, the (high-voltage high-current) main circuit, and the I/O signal cable together and keep the power cables away from the earth cable. It is suggested that the distance between adjacent cables should be more than 100 millimeters.
4. Connect a cable with a diameter of 14 AWG or higher to ground.
5. Use single-wire cables or two-wire cables with a diameter of 20 AWG to 14 AWG. Only use copper conducting wires with a temperature rating of 60/75°C.

13.2.3.2 Digital Input Wiring in SIO Mode

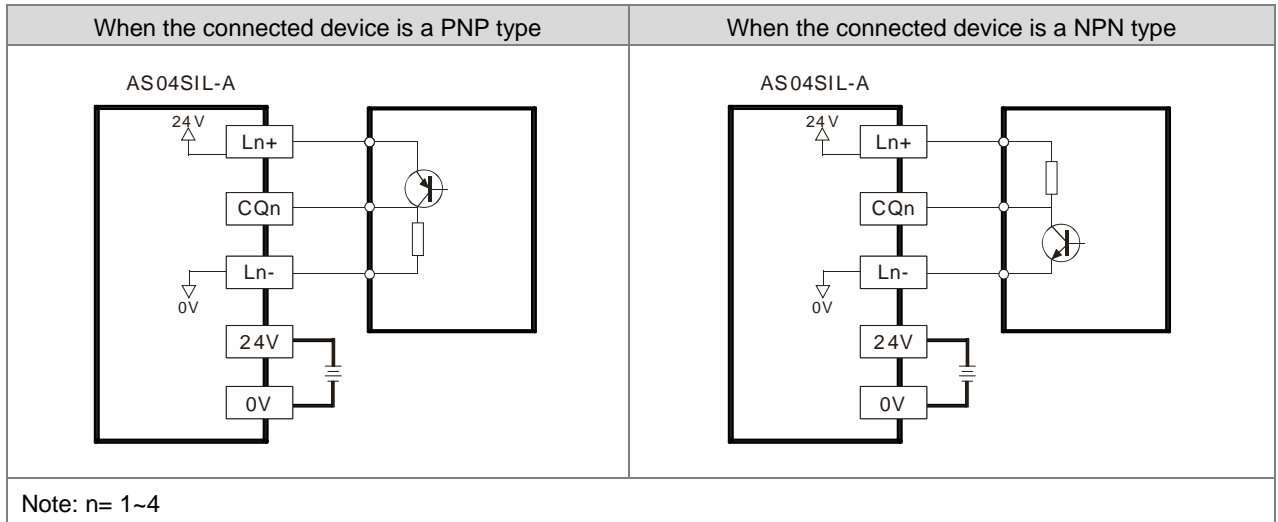

13.2.3.3 Digital Output Wiring in SIO Mode

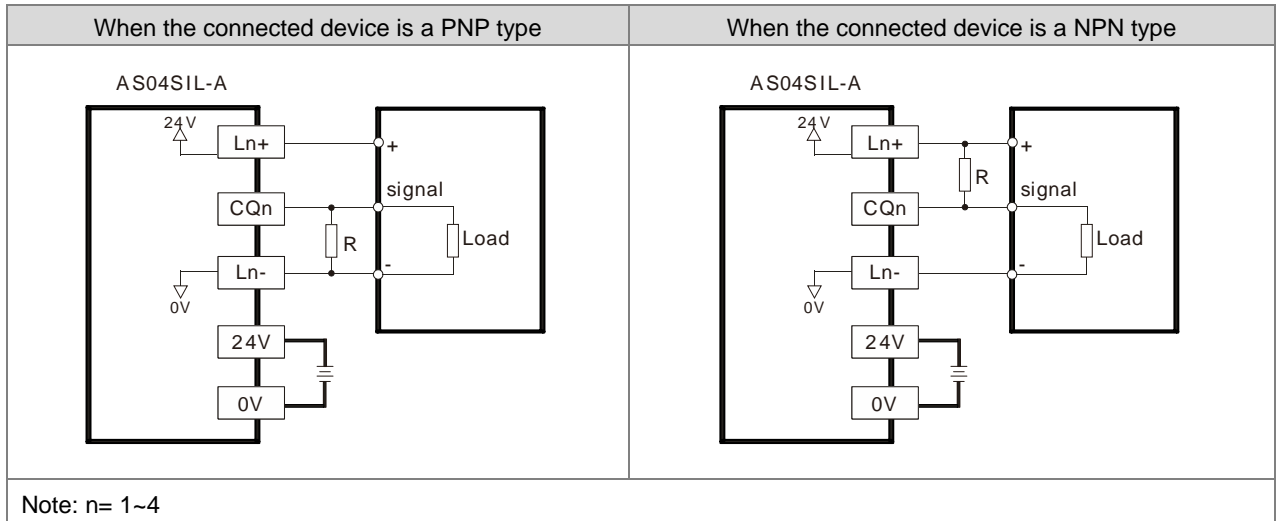

13.2.3.4 Digital Input Wiring

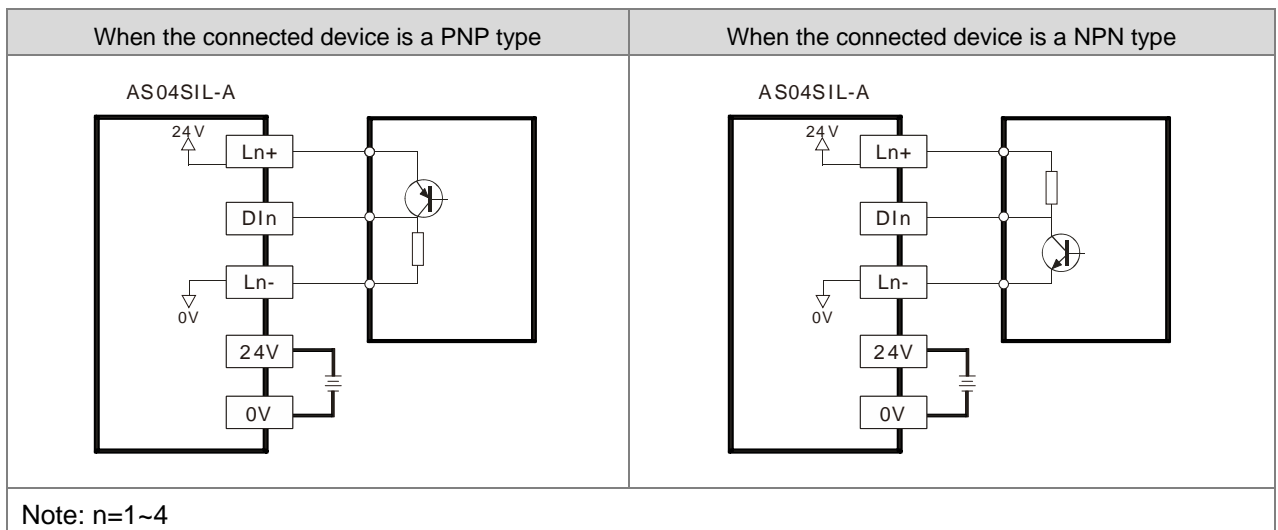

13.3 Functions

AS04SIL-A supports the IO-Link devices when it works as the IO-Link master. Between the master and the devices is the point-to-point connection adopting the reliable 3-wire technology and the unshielded standard cable to connect intelligent sensors/actuators which function as IO-Link devices. AS04SIL-A is compatible with traditional digital sensors/actuators. The designs for circuit status and data channels are both based on the reliable 24VDC technology.

13.3.1 Basic Functions

13.3.1.1 Cyclic Communication Function

I/O data (process data) in the IO-Link devices is cyclically exchanged with the IO-Link master module which operates as the IO-Link communication master. Meanwhile as the extension module of the upper device, AS04SIL-A can cyclically update the device data and status of the IO-Link master to the upper device.

For example, users can use cyclic communications to check the amount of incident light for photoelectric sensors, stability detection margins, and excessive proximity for proximity sensors, etc. as well as detect the amount of performance deterioration in devices and changes in usage conditions.

There are three modes for cyclic communications:

- (1) Asynchronous: AS04SIL-A and IO-Link device defines the cycle time for each port and uses the shortest update cycle time.
- (2) Fixed Value: the system uses what you have set for the update cycle time here. The value here should be within the cycle time range of the connected device and the minimum value should be a number bigger than the shortest cycle time that the connected device supports.
- (3) Synchronization: AS04SIL-A defines the update cycle time for all the selected communication ports synchronously. (You need to select at least two ports.) Since different device supports different update cycle time, the system uses the biggest time among all the shortest cycle times to have every device covered.

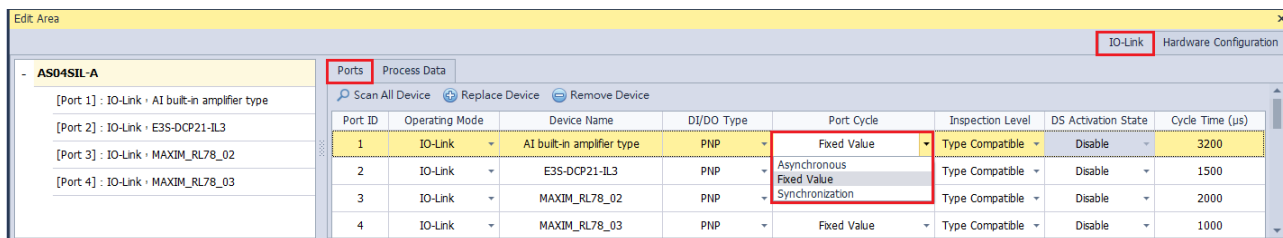

13.3.1.2 Message Communication Function

AS04SIL-A receives messages (non-cyclic) from PLC or ISPSOft, sends the data to IO-Link devices and sends back the response from IO-Link devices to AS04SIL-A. Non-cyclic data, including device parameters and events, uses specific index and sub-index for searching and data mapping. AS04SIL-A uses explicit message to read and write these data. It is very useful to use index or sub-index in reading and writing data.

For example, during operation you can use function blocks to change and adjust device parameters, such as threshold settings, execution tuning, and ON-delay time from a program as well as check the internal status, such as the operating time of devices. Refer to section 13.3.2.5 for more information.

You can select the data or parameter type, select one or all parameters to read or to write. See the setting image shown below for reference.

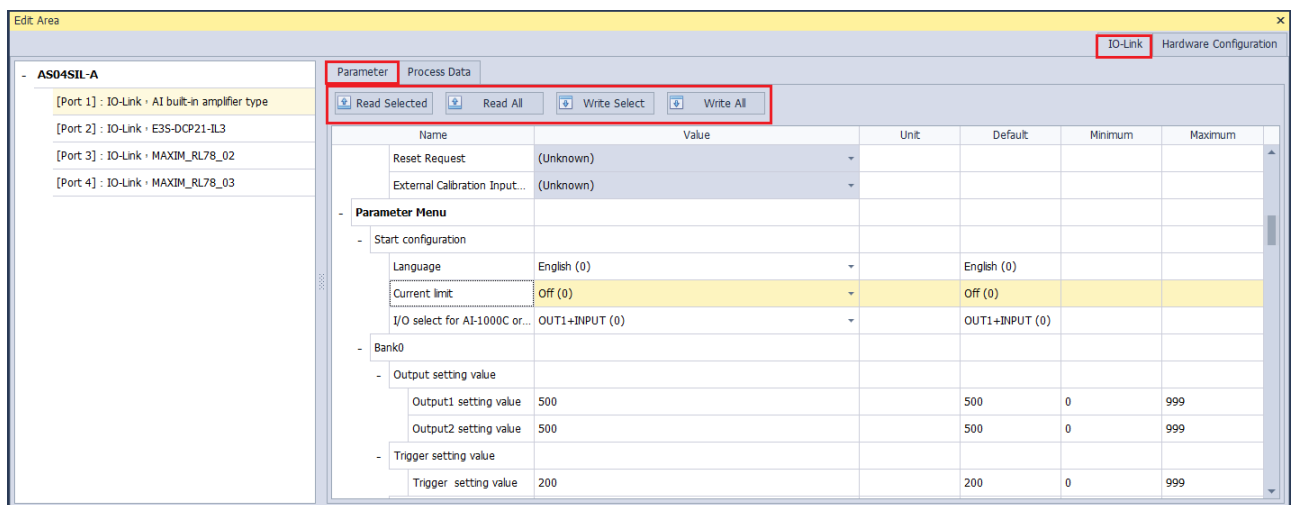

13

13.3.1.3 Communication Mode Setting

You can select one operating mode among the modes of Inactive, SIO (Digital Output, Digital Input) and IO-Link for each communication port on the following software page.

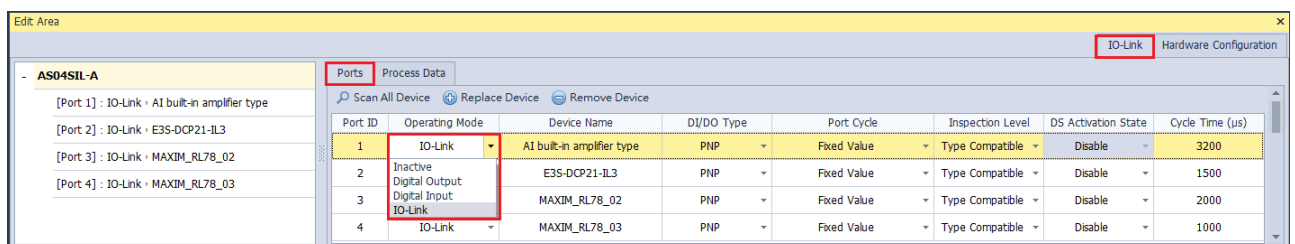

A mixture of IO-Link communication and digital I/O can apply to the same AS04SIL-A module.

13.3.1.4 Digital Input and Digital Output Function (SIO)

CQ1-CQ4 of AS04SIL-A can be used independently as the standard input or output. The DI/DO types of PNP and NPN are supported and can be set up separately on the IO-Link page.

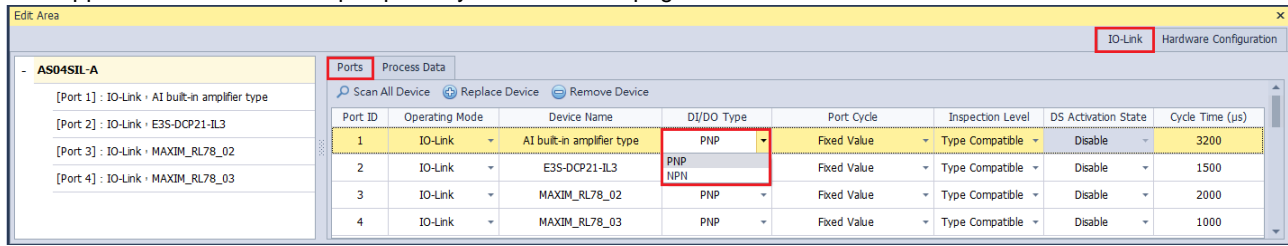

13.3.1.5 Automatic IO-Link Baud Rate Setting

AS04SIL-A can automatically match one of existing baud rates (4.8kbps, 38.4kbps and 230.4kbps) of IO-Link devices and communicate with them. Thus there is no need to set the baud rate at communication ports for connected devices.

13

13.3.1.6 Connected Device Verification

As long as the **Type Compatible** option under **Inspection Level** is enabled and the setting is downloaded, AS04SIL-A will check if the IO-Link device actually connected matches the product model of the configured device. If not matched, the status code of the communication port will show 16#8CA2 which indicates that the connected device is inconsistent with the configured one.

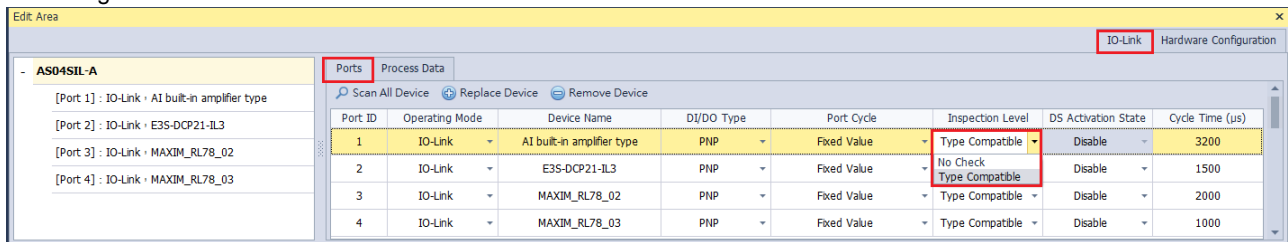

13.3.1.7 DI (Digital Input) Function of IO-Link Pin2

The IO-Link system may not respond fast enough for high-speed applications. When the connected IO-Link sensor supports the second output, connect the sensor's pin2 to DI of the port of AS04SIL-A. At this moment, the sensor can still be watched and set up via the sensor's pin4.

The real-time data can be monitored through **Port 1- 4 Pin2 value of Normal Exchange Area**. See the following figure as an example.

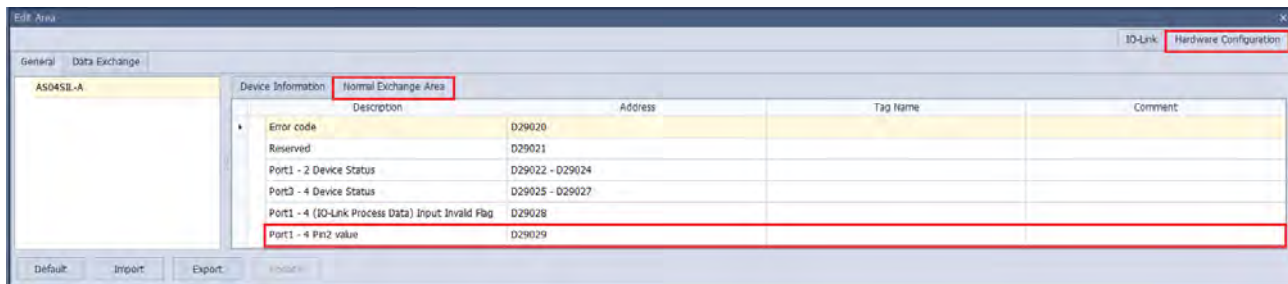

The mapped register for **Port 1- 4 Pin2 value of Normal Exchange Area** is D29029. For the pin2 input value, the addresses D29029.0~ D29029.3 correspond to port 1~ port 4 respectively.

Communication Port	Address
Port 1	D29029.0
Port 2	D29029.1
Port 3	D29029.2
Port 4	D29029.3

DI1-DI4 of AS04SIL-A can also be used separately as standard inputs.

13.3.1.8 IO-Link Communications Error Detection

This function detects I/O-Link cable breaks, disconnections from IO-Link device ports, error-level device events, device configuration verification errors, and IO-Link device malfunctions. See section 13.5 for IO-Link event codes.

13.3.1.9 Detection of Short-Circuits in I/O Cables

This function detects short-circuits in I/O cables. The status code for communication ports will show 16#8CA4 if an error occurs.

13.3.1.10 Event Log

The IO-Link event codes listed in section 13.5 are refreshed in the mapped devices for ports in the **Normal Exchange Area** section as below.



The device status for each port should be set to 3 bytes in length. See the following table of above device addresses corresponding to ports in order.

Description	Address
Port 1	D29022_H, D29022_L, D29023_H
Port 2	D29023_L, D29024_H, D29024_L
Port 3	D29025_H, D29025_L, D29026_H
Port 4	D29026_L, D29027_H, D29027_L

Device status consists of Event qualifier and Event Code as follows.

For event codes, see section 13.5.

Event Qualifier	Event Code	
Byte 0	Byte 1	Byte 2

The data frame of Event Qualifier:

MODE		TYPE		SOURCE	INSTANCE		
Bit 7	Bit 6	Bit 5	Bit 4	Bit 3	Bit 2	Bit 1	Bit 0

Bit 0~ Bit 2: INSTANCE

Value	Definition
0	Unknown
1-3	Reserved
4	Application
5-7	Reserved

Bit 3: SOURCE

Value	Definition
0	Device (Remote)
1	Master (Local)

Bit 4~ Bit 5: TYPE

Value	Definition
0	Reserved
1	Notification
2	Warning
3	Error

Bit 6~ Bit 7: MODE

Value	Definition
0	Reserved
1	Event single shot
2	Event disappears
3	Event appears

13.3.1.11 Notification of Input Data Invalidity

Input Invalid Flag is used to determine whether the process input data in the upper device is invalid for the IO-Link communication or not.

Whether the input data is invalid or not can be monitored by **Port1 – 4(IO-Link Process Data) Input Invalid Flag** of the **Normal Exchange Area** section. If the flag is 1, then the input data is invalid. If it is 0, the input data is valid.

See the example in the following figure.

The mapped register for **Port1 – 4(IO-Link Process Data) Input Invalid Flag** is D29028 and for the input invalid flag, D29028.0~ D29028.3 correspond to Port 1~Port 4 respectively as shown in the following table.

Communication Port	Address
Port 1	D29028.0
Port 2	D29028.1
Port 3	D29028.2
Port 4	D29028.3



13.3.1.12 IO-Link Device Scan Function

HWCONFIG 4.0 can enable AS04SIL-A to auto-identify all IO-Link devices at its communication ports via a click on **Scan** button.

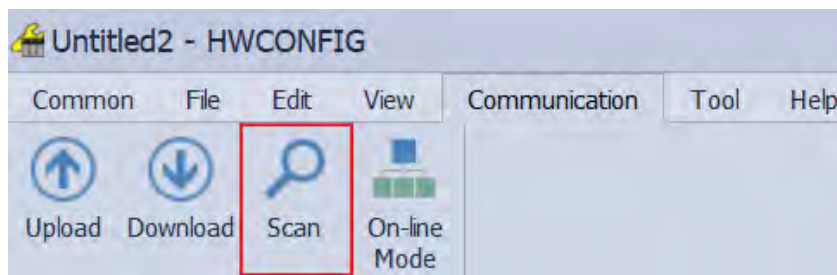

13

You can also select any AS04SIL-A module and then click **Scan All Device** to scan all the IO-Link devices connected to the communication port of AS04SIL-A.

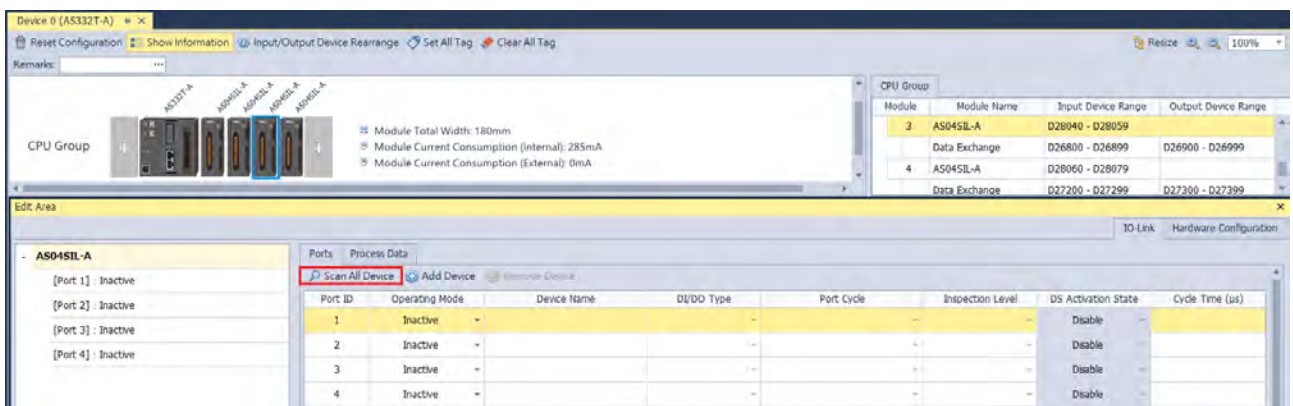

While SIL is auto-identifying devices, all IO-Link devices connected to IO-Link master need be restarted and therefore the devices will probably stop running for a short time.

13.3.2 Application Functions

13.3.2.1 Load Rejection for Upper Device Stop or Communication Error

When the upper device enters STOP state or the communication with the upper device fails in IO-Link or SIO mode, the output function of AS04SIL-A is disabled and all process data outputs are 0. This function is used to prevent the incorrect output from the upper device as a communications error occurs.

13.3.2.2 The Switch among Process Data Parameter Sets

IODD file allows IO-Link devices support several work modes, each of which corresponds to different Process Data parameter sets. Therefore SIL supports the switch among Process Data parameter sets if the IODD file of the configured device supports more than two work modes. However, the Process Data parameter set can not be changed if the IODD file of the configured device supports only one work mode.

13

For example, the IO-Link device configured for Port 1 supports four work modes in the following figure. The default work mode is Segment mode (0).

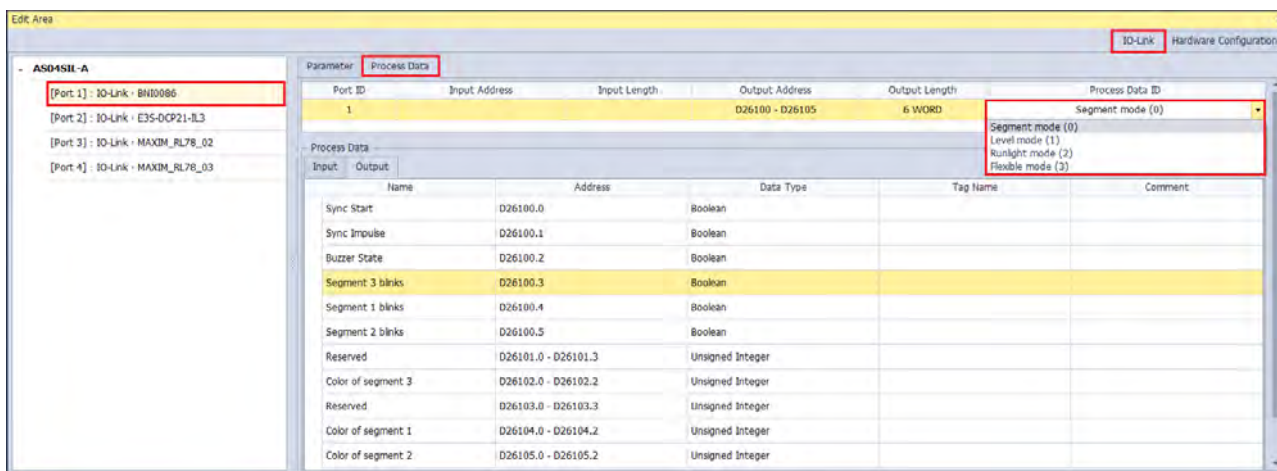

When Level mode (1) is switched to, a **Confirm** dialog box will appear to alert that the Process Data content will be changed.

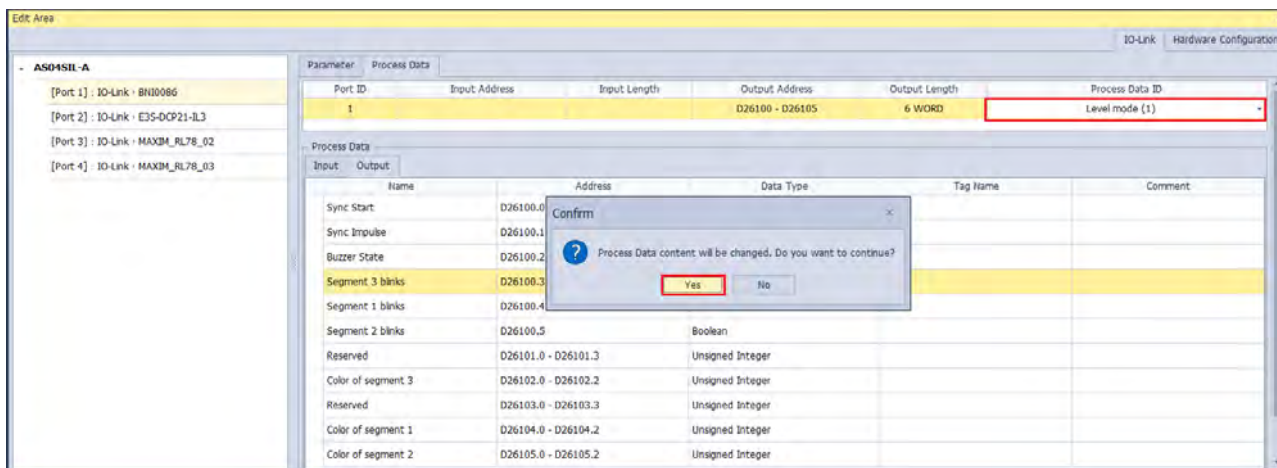

Clicking **Yes** button, the Process Data content will be refreshed in the software.

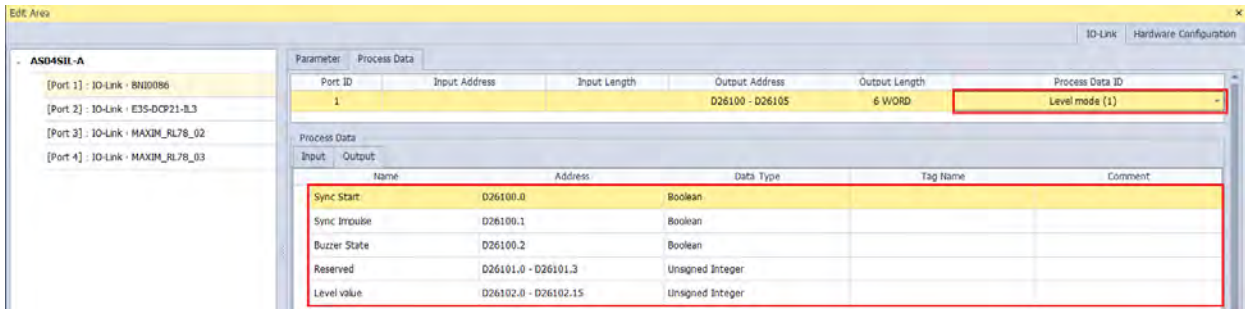

Click menu **Communication > Download**. The switch is completed once the download is done.

13.3.2.3 Backup and Restoration of Parameter Setup in IO-Link Devices

The V1.1 IO-Link devices support the Backup and Restore functions which are not necessary functions and are determined by their IODD files.

IO-Link device parameter settings are backed up to the IO-Link master or restored to IO-Link devices. When IO-Link devices are replaced, the communication can be resumed according to original settings instead of setting parameters once again. See the setting page below.

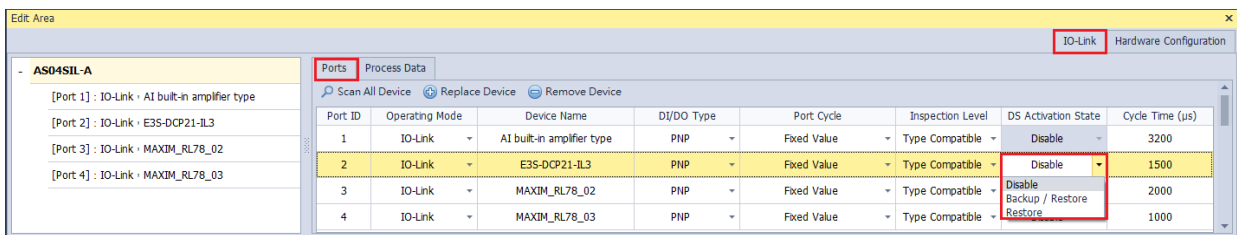

Option	Description
Disable	The backup function is disabled and the backed up process data is cleared.
Backup/Restore	The backup file is empty if no data exists. It is allowed to back up the parameters read from the connected device to the master and write the parameters to the connected device.
Restore	To write parameters to the connected device is allowed.

13.3.2.4 Digital Input Filter

You can use any DI or any CQ of the operation mode SIO (DI) as the standard input and use the input filter function to filter out noises. The filtering time of each channel can be set between 0 ~ 65 ms. 0 indicates no filtering. The setting page is as shown below.

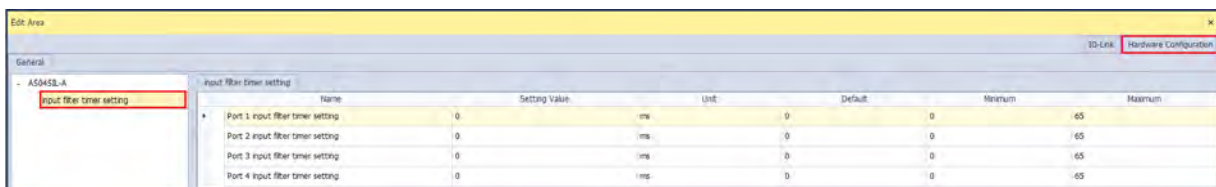

13.3.2.5 Application-specific API for Communications of IO-Link Devices

Once you complete the configurations for IO-Link devices via HWCONFIG. You can use ISPSOFT as well as specific API to read/write data from IO-Link devices to AS04SIL-A. Refer to the device manual or the IODD file for the index number, data type, data size of the parameters. And refer to AS Series Programming Manual for the detailed operation of API 14 instructions.

13.4 Application Examples

13.4.1 Using AS Series CPU as Upper Device

The AS04SIL-A module can be connected on the right side of AS series CPU or AS00SCM-A (RTU mode). If AS04SIL-A is placed on the right of AS00SCM-A (RTU mode), the AS-FCOPM communication card need be added to AS00SCM-A. AS04SIL-A supports three remote communication modes and communicates with the upper device via CAN port. When the upper device is an AS series CPU, the application situation is as illustrated in the following figure.

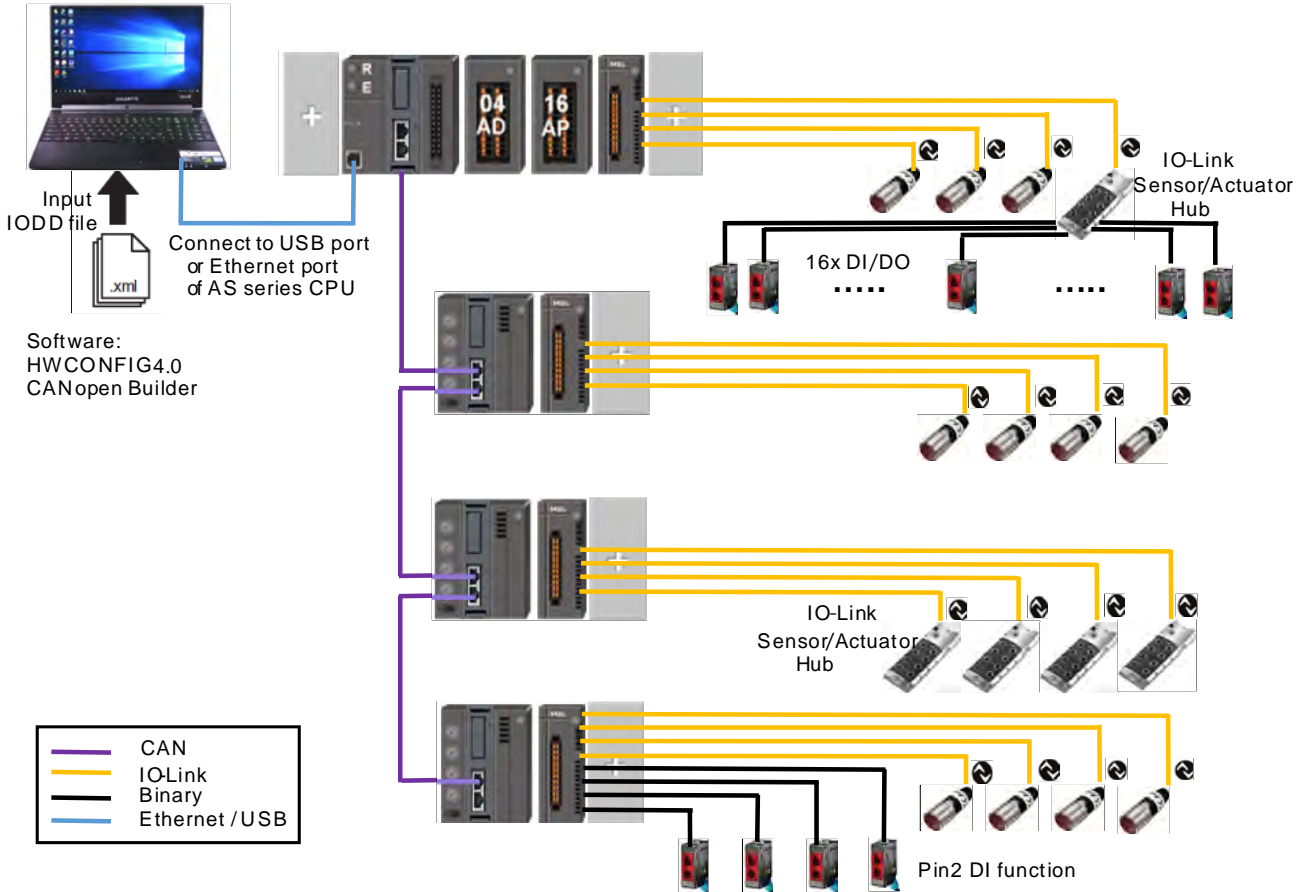

An AS04SIL-A module can connect with 4 IO-Link devices at most. If the hybrid use of the IO-Link devices and multiple traditional sensors (binary sensors) is needed, there are two connection methods based on the number of traditional sensors on site.

1. If there is only a small number of traditional sensors to be connected, each of AS04SIL-A module's ports can connect with one traditional sensor by using the DI function of Pin2 for each port.
2. If there are many traditional sensors to be connected, use the IO-Link hub from other brand to extend the connectable digital I/O devices.

There are three communication modes for AS00SCM-A plus AS-FCOPM.

Work mode	Description
AS Special Remote Mode	The AS04SIL-A module is a NIO module. The number of configurable modules is limited to AS series CPU including remote modules. 4 NIO modules can be configured at most. All SIL modules and IO-Link devices can be configured in HWCONFIG 4.0 and can be monitored online by the software.
Delta Special Driver & AS Remote Mode	
CANopen DS301 Mode	Here AS CPU is a CANopen master and AS00SCM-A is a CANopen slave. Up to 4 SIL modules can be configured on the right side of the slave AS00SCM-A (RTU). As many as 64 slaves can be connected to the AS CPU. CANopen Builder does not support the configuration of extension modules on the right side of AS00SCM-A and connected IO-Link devices. First make the connection in AS special remote mode, complete the configuration of all extension modules and IO-Link devices in HWCONFIG 4.0 and then switch the mode back to CANopen DS301 mode. Open CANopen Builder and configure PDO mapping according to the EDS file of AS00SCM-A with V2.06 or later. For details on operation, see section 13.4.5.

13.4.2 Using AH Series CPU or Non-Delta Master PLC as Upper Device

As CANopen master, AH series CPU need be used together with AH10COPM-5A module to communicate with the CANopen slave AS00SCM-A. See the application situation as illustrated in the following figure.

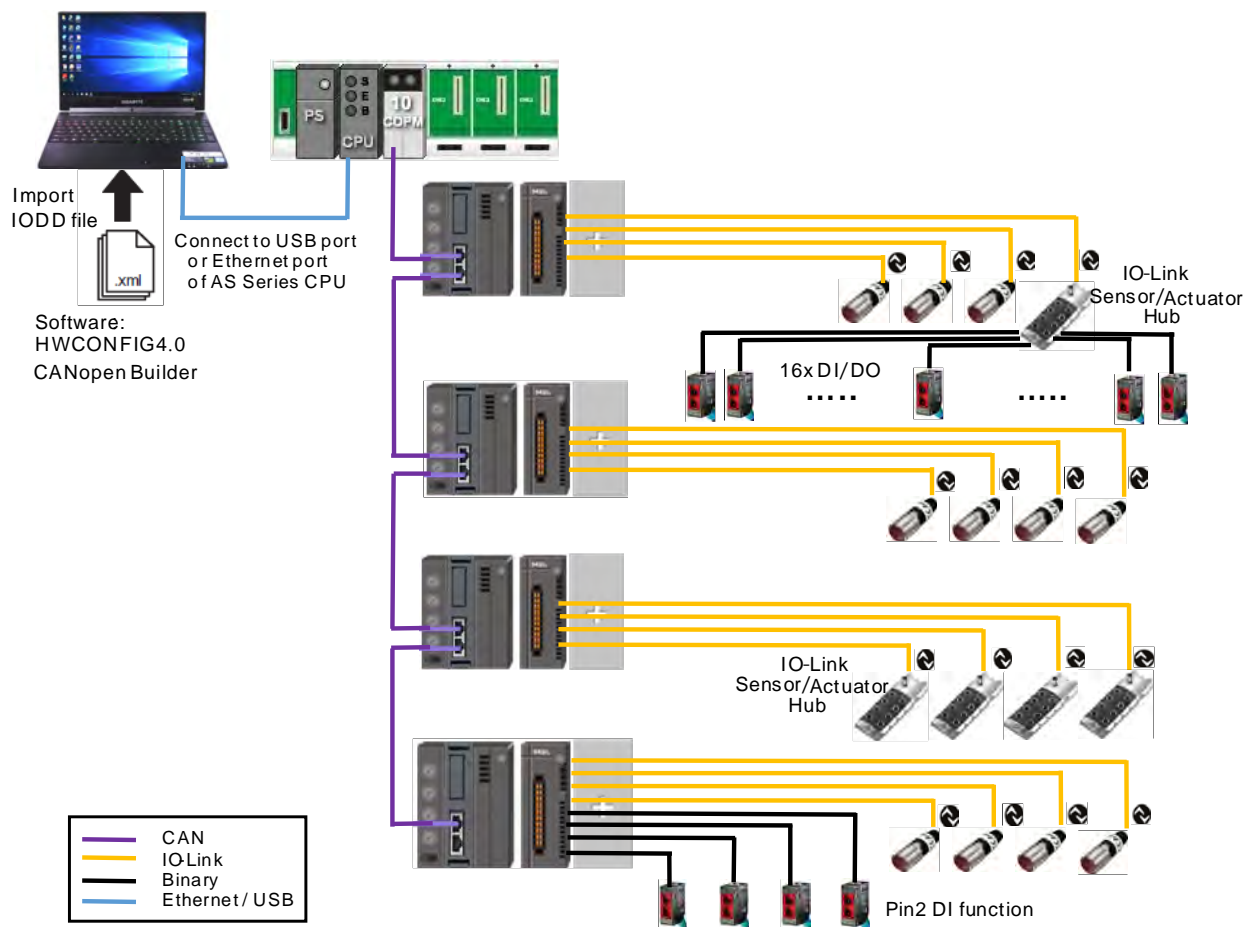

According to the description on CANopen DS301 Mode in section 13.4.1, connect the AS00SCM-A module to AS CPU in AS special remote mode, configure all extension modules and IO-Link devices in HWCONFIG 4.0 and then switch the mode back to the CANopen DS301 mode.

If the upper device is an AH series CPU, the CANopen Builder software can be opened. Configure the PDO mapping list according to the EDS file of the AS00SCM-A module. See the details in section 13.4.5.

If the upper device is a master PLC from other brand, use the software from the brand to configure the CANopen slaves and PDO mapping.

13.4.3 Application of AS Special Remote Mode

See the following table of devices used in the application example:

Model name	Device type
AS332T-A	PLC
AS00SCM-A	RTU
AS04SIL-A	IO-Link Master
AI-B100	3 rd IO-Link Device
E3S-DCP21-IL3	3 rd IO-Link Device
MAXREFDES27#	3 rd IO-Link Device
MAXREFDES36#	3 rd IO-Link Device

First of all, open the HWCONFIG 4.0 software and import the IODD files of IO-Link devices which can be downloaded from vendors' official websites. Follow the steps here to import the IODD files through the **Device Description File Manager** tool.

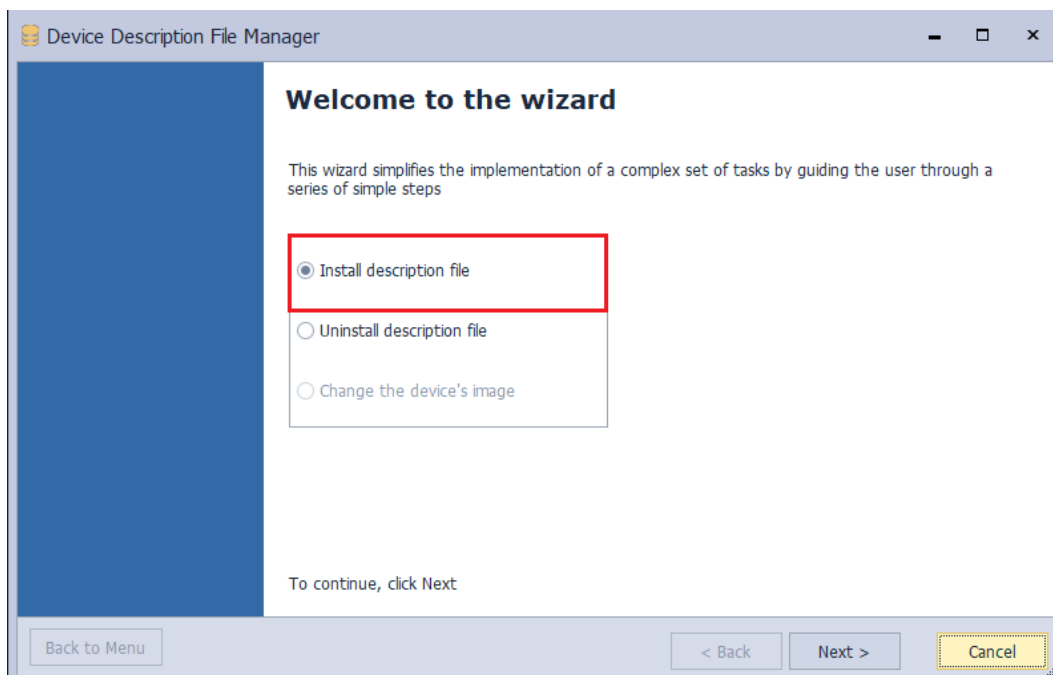
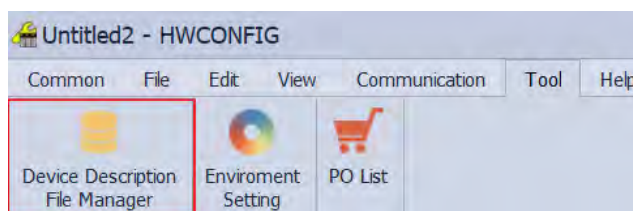

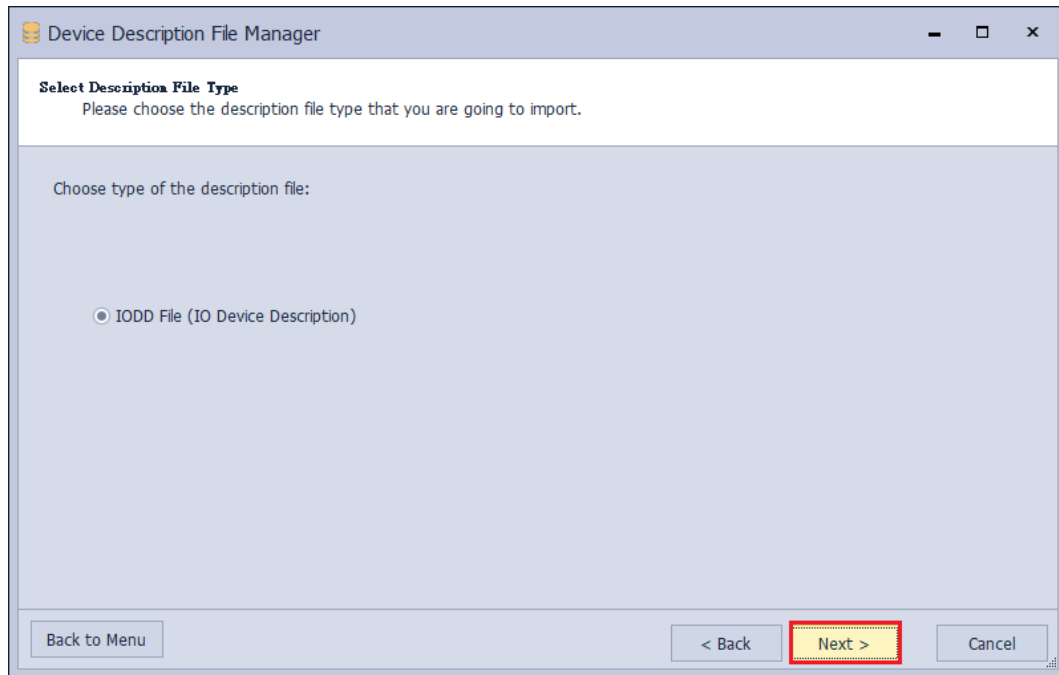

Put all IODD files in the same folder so as to import multiple IODD files at a time.

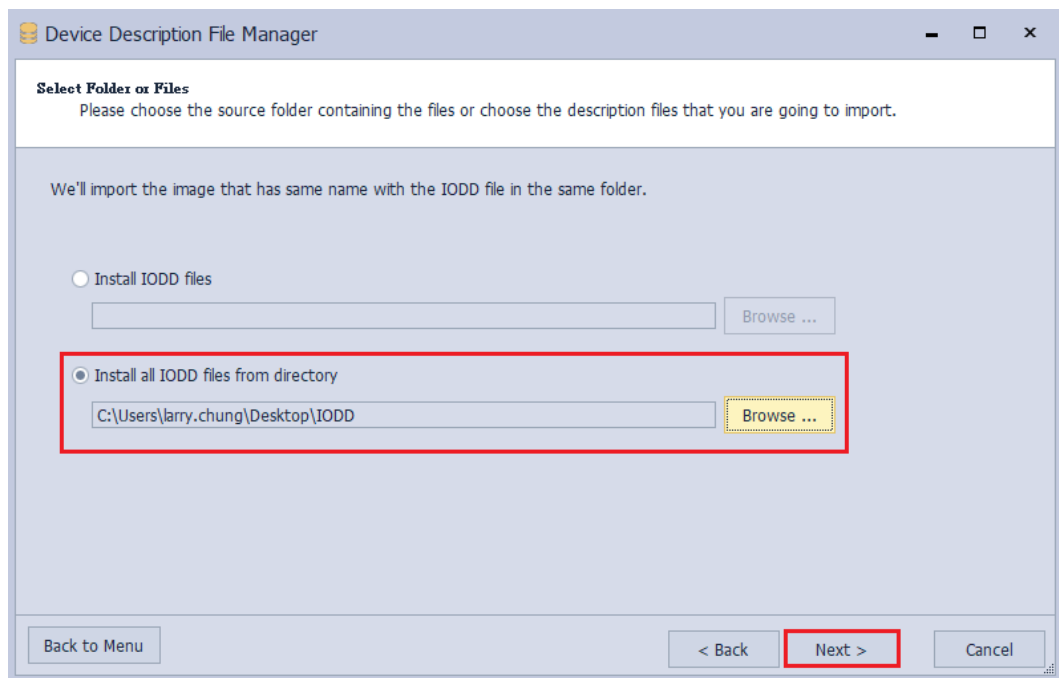
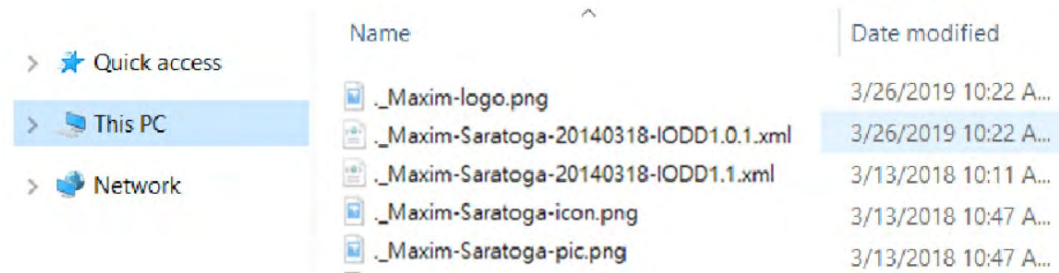

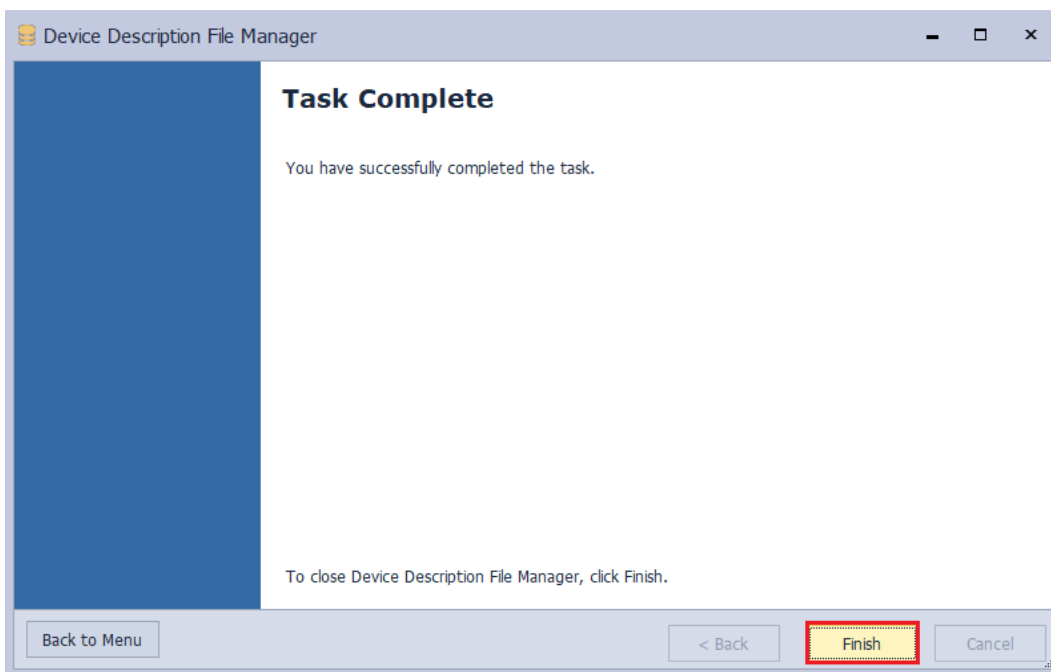
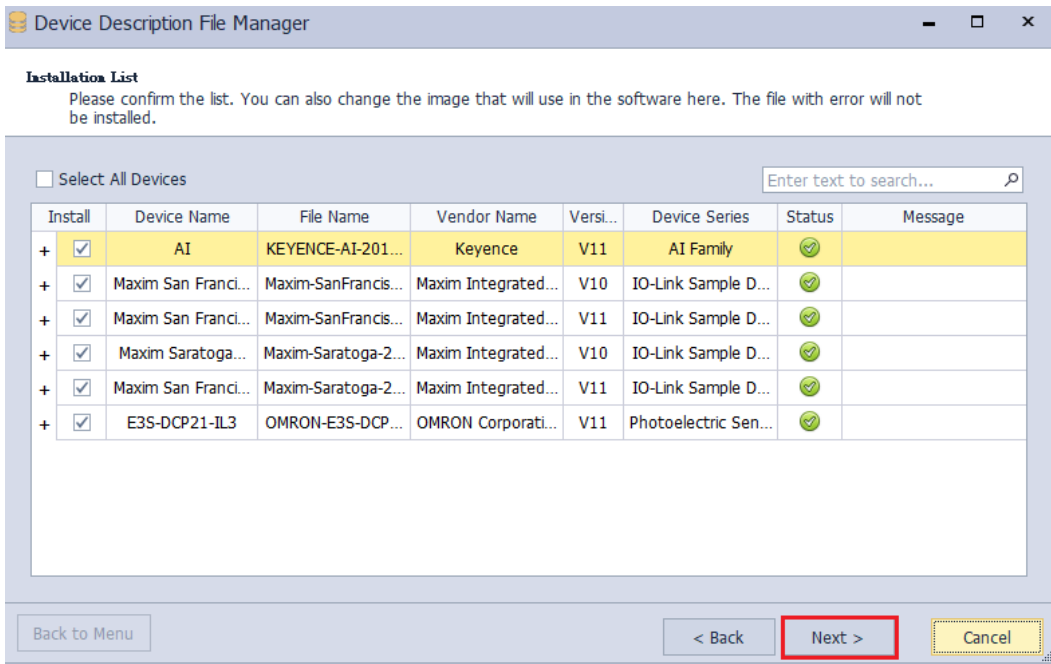

Check the following setups before the AS00SCM-A module is powered on.

1. The AS-FCOPM card is inserted to AS00SCM-A via Card 2. (The 120Ω terminal resistor is enabled.)
2. Use Delta standard cables to connect to AS CPU and the mode switch is turned to RTU mode.
3. Four switches are set to ID1: 0/ FORMAT1: 0/ ID2: 1/ FORMAT2: 7 and the status is set to AS Remote Communication, node ID 1 and baud rate 1Mbps.
4. AS04SIL-A is connected on the right side of AS00SCM (RTU). Ensure that IO-Link devices are connected to the four ports according to the wiring in section 13.2.3.

Switch the power on after the AS-FCOPM card is inserted to AS332T-A via Card 2. (The 120Ω terminal resistor is enabled.)
 Open the HWCONFIG 4.0 software, set up function card 2 for AS CPU and then download the settings as follows.

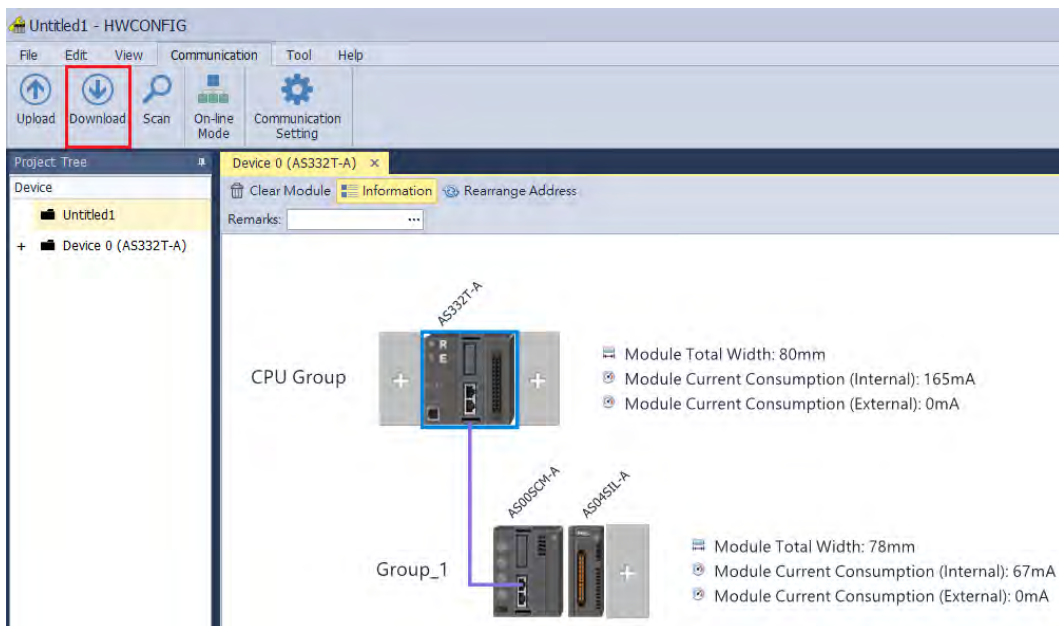
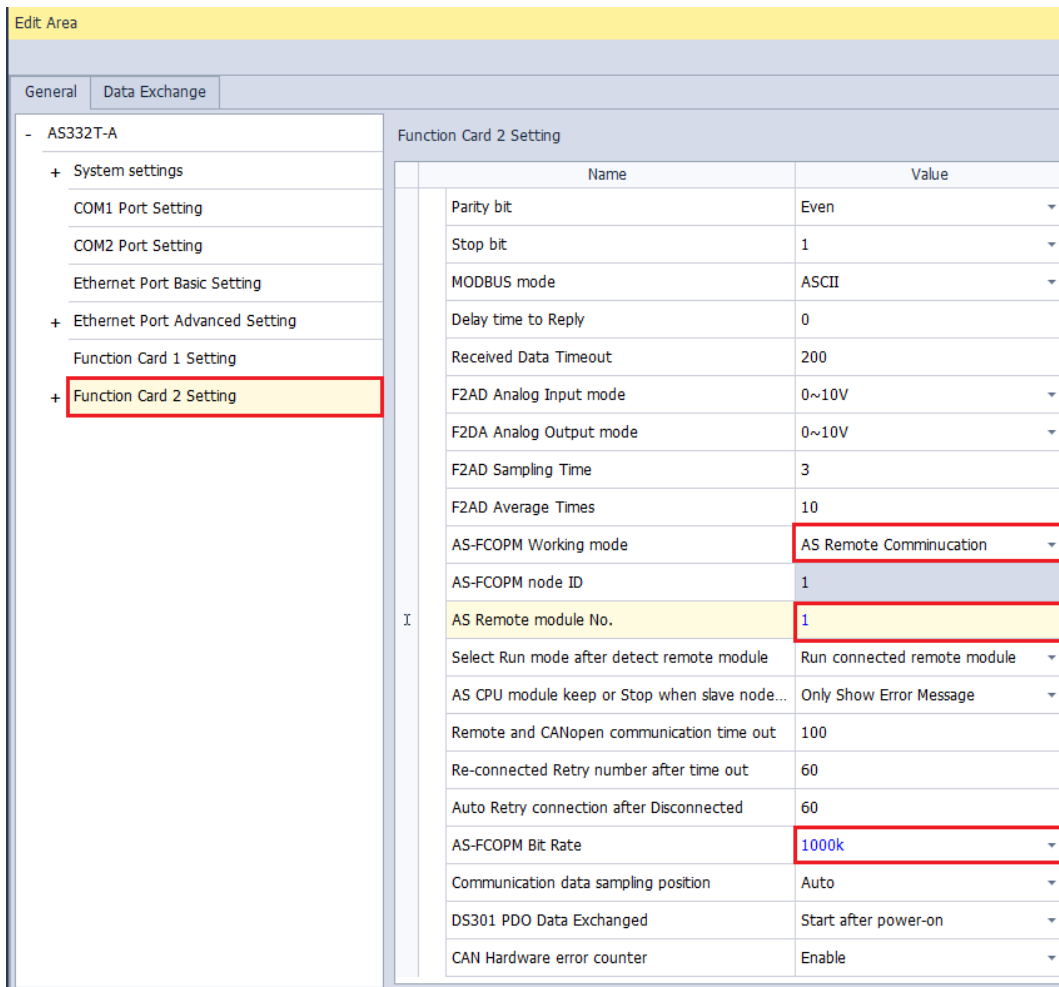

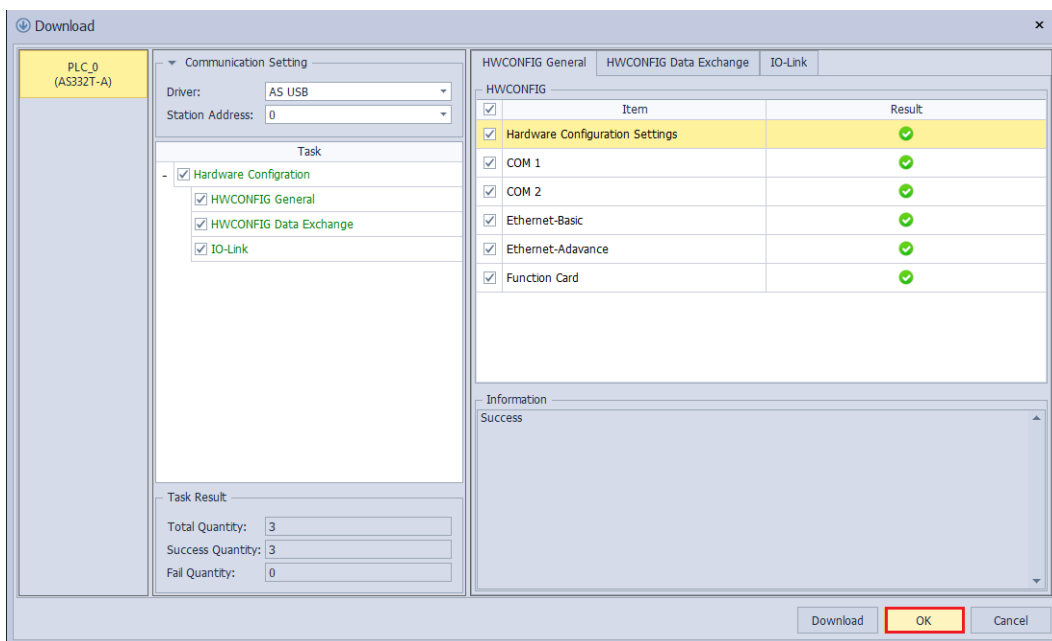
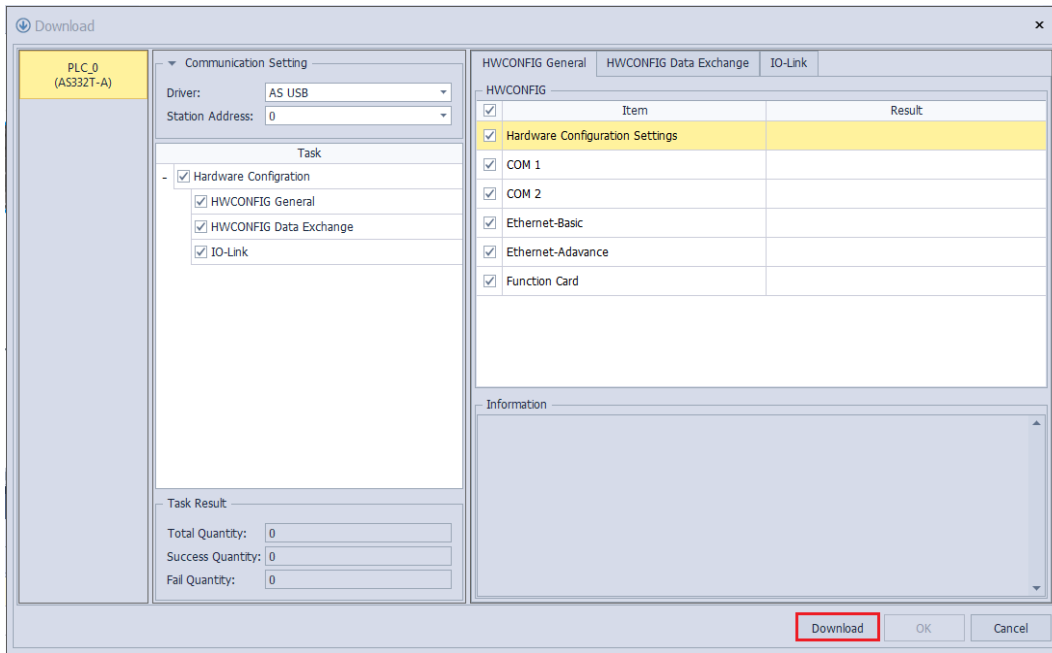

Ensure that the CANopen cables are connected properly and the AS00SCM-A module is already powered on. Check if the Card2 LED indicator of AS00SCM-A keeps blinking after the configuration of AS332T-A is downloaded so as to make sure the communication works normally.

Click **Scan** button.

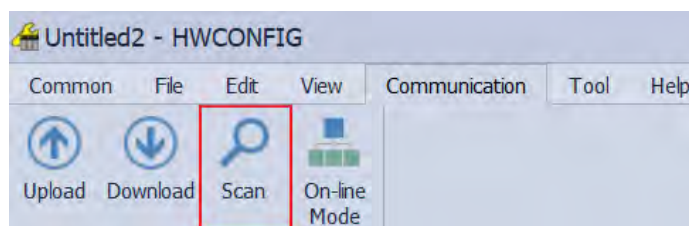

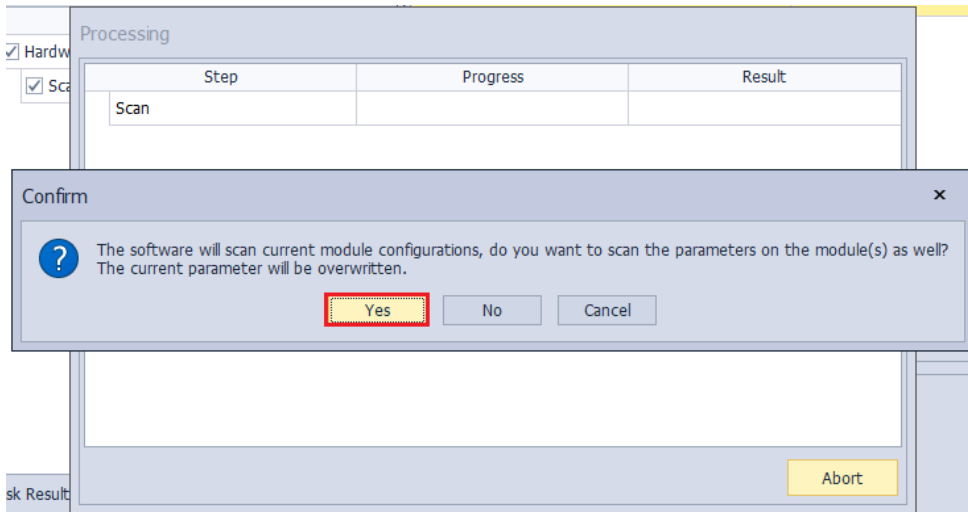
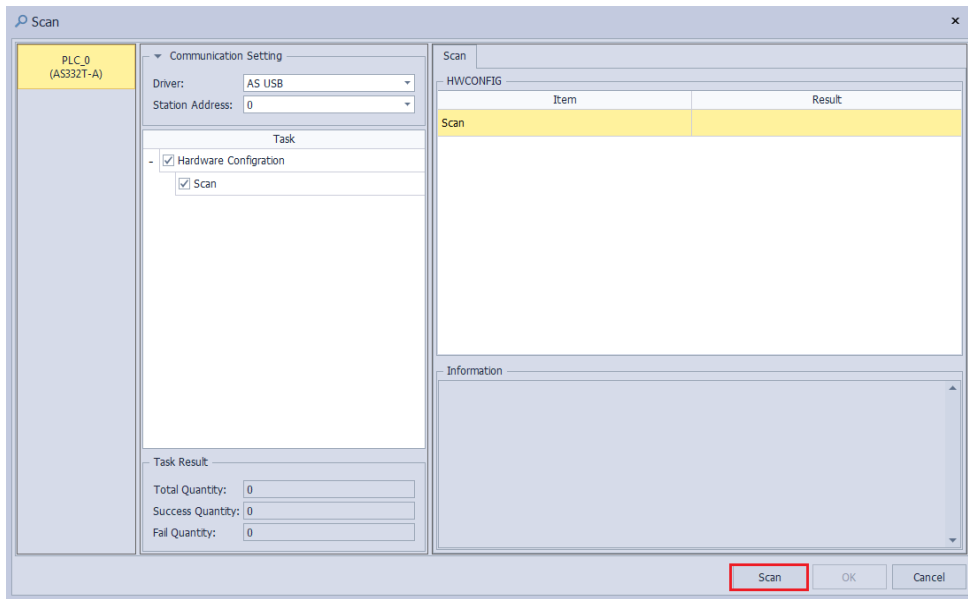

Once any AS04SIL-A module is detected through the software scan, the software will ask whether to scan the connected IO-Link device.

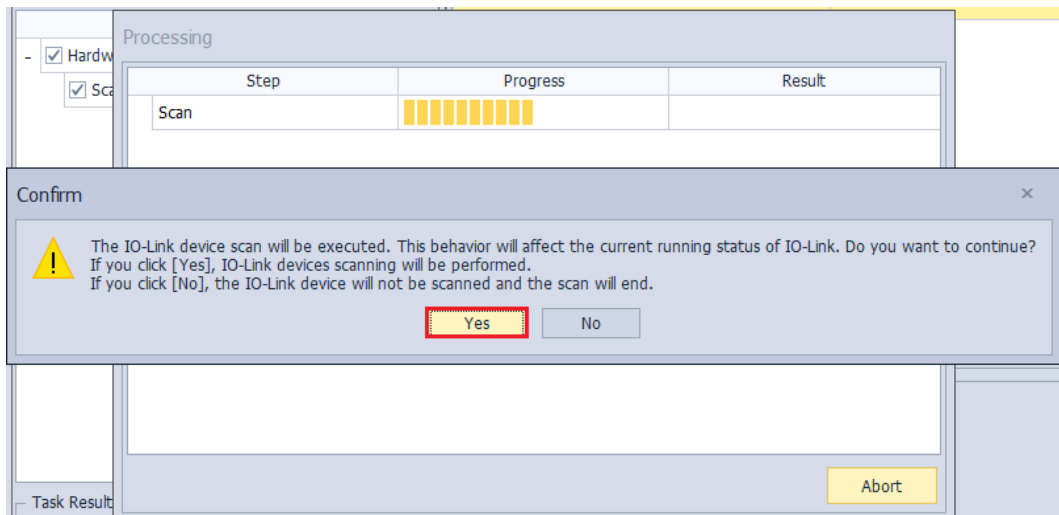

Perform the scan of IO-Link devices. If some configured devices are in communication during the scan, they will fail to be used temporarily. Restart the devices after the scan is over and restore the original work mode.

13

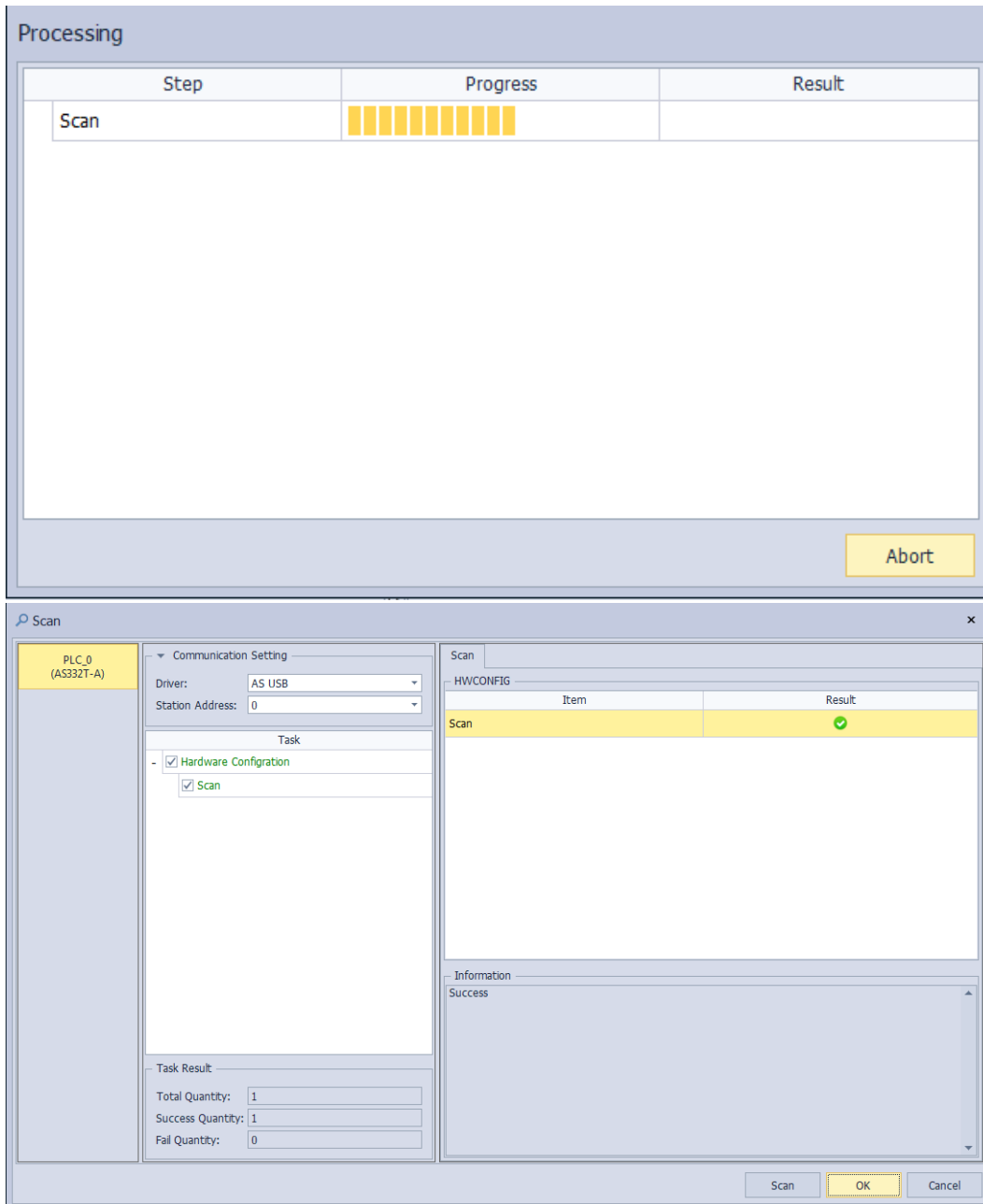

Click the IO-Link module and then select the **IO-Link** page where each device model and related information are can be seen and the parameters to be set up are all default values.

If no matched IODD file can be found out for the scanned device, **Unknown Device** will be shown in the device name field. Users need download the IODD file of the device from the coporate website of the device product according to the scanned device details such as Vendor Name, Vendor ID, Device ID and Device Name and then import the file into the HWCONFIG software.

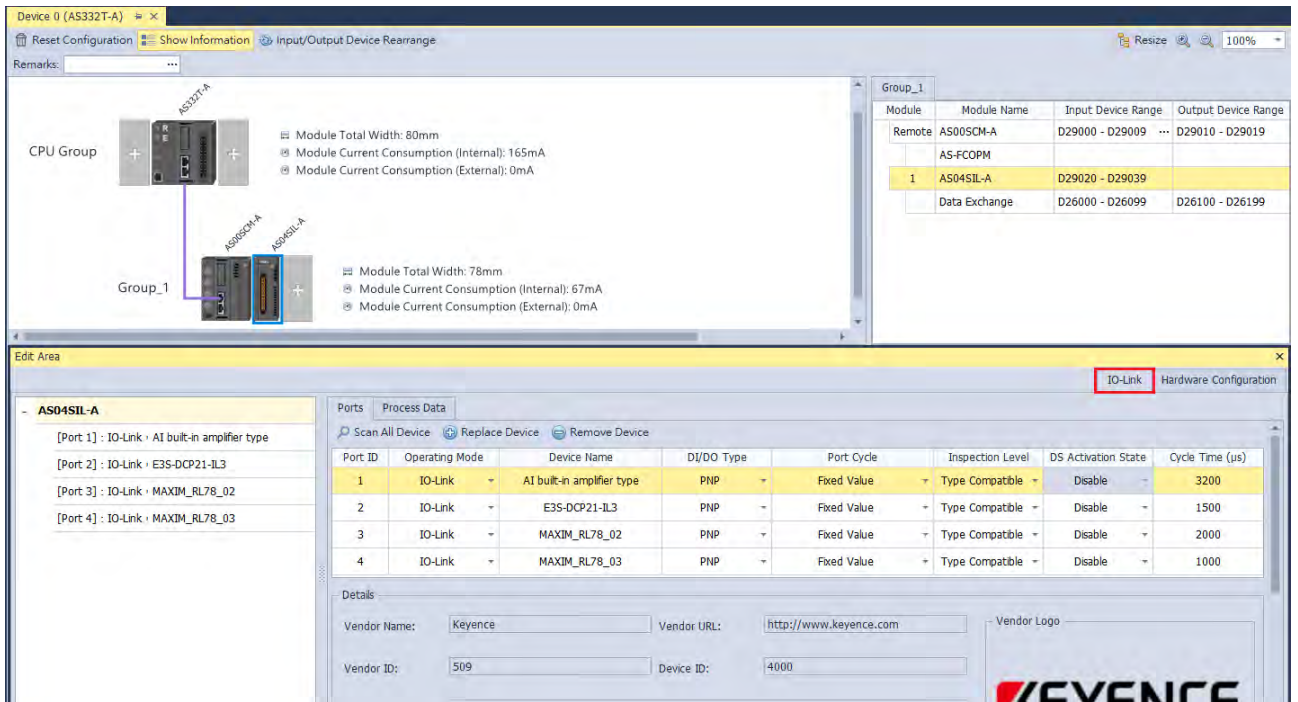

Under the Process Data tab, you can find the supported register addresses of each port. Since ISPSOft V3.11 supports using tags in PLC programming, it is very useful to set up the tags and its corresponding register addresses. Follow the steps 1~3 below to set up the tabs.

Step 1: Click **Set All Tag**

Step 2: A confirmation shows up asking you if you want to overwrite the set tags and comments. Click Yes to proceed.

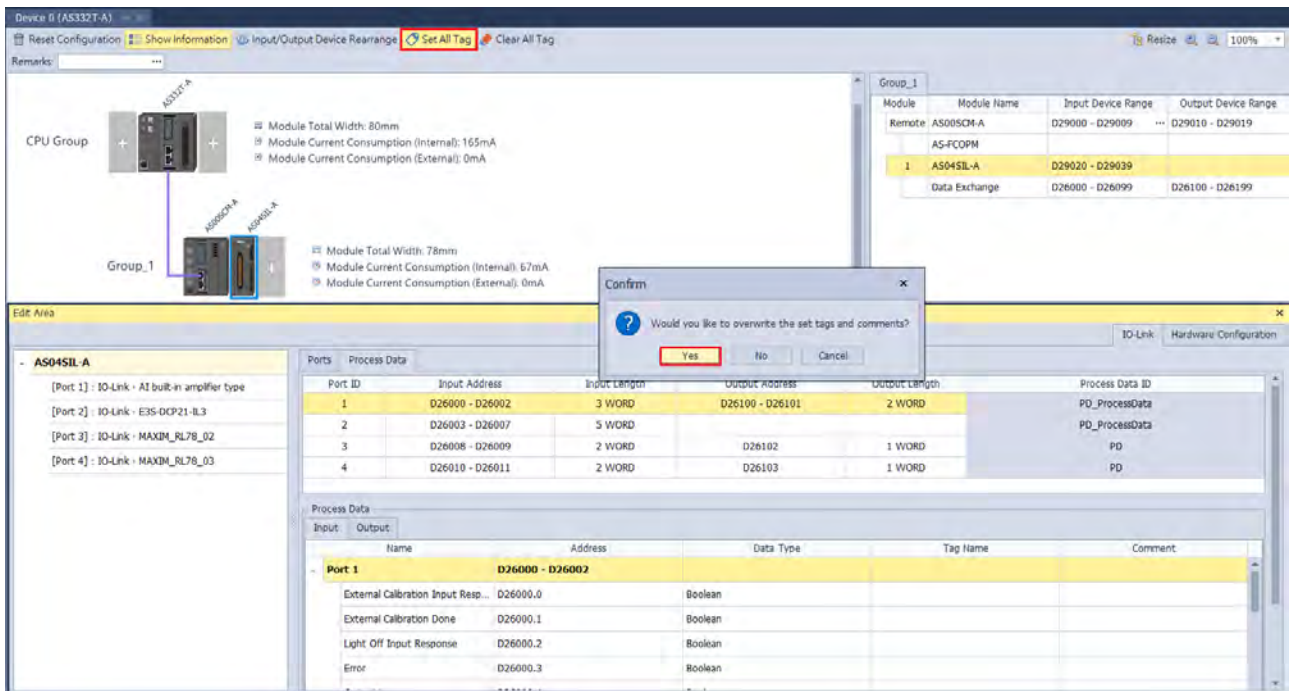

Step 3: All the editable tags show up. Double-click the tags in blue to edit if you need to use a different name other than the default ones.

Note: One register address corresponds to one tag, and it shows on the first group of address.

13

Port ID	Input Address	Input Length	Output Address	Output Length	Process Data ID
1	D26000 - D26002	3 WORD	D26100 - D26101	2 WORD	PD_ProcessData
2	D26003 - D26007	5 WORD			PD_ProcessData
3	D26008 - D26009	2 WORD	D26102	1 WORD	PD
4	D26010 - D26011	2 WORD	D26103	1 WORD	PD

Port	Name	Address	Data Type	Tag Name	Comment
Port 1	External Calibration Input Response	D26000.0	Boolean	NDO_AS04SL_A_2_1_1_External_Calibration	
	External Calibration Done	D26000.1	Boolean		
	Light Off Input Response	D26000.2	Boolean		
	Error	D26000.3	Boolean		
	Output1	D26000.4	Boolean		
	Output2	D26000.5	Boolean		
	Current Value Valid	D26000.6	Boolean		
Port 2	Hold Input Response	D26000.7	Boolean		
	Bank Input Response	D26001.0 - D26001.1	Unsigned Integer	NDO_AS04SL_A_2_1_1_Bank_Input_Response	
	Current Value	D26002.0 - D26002.9	Unsigned Integer	NDO_AS04SL_A_2_1_1_Current_Value	
Port 3	Control Output 1	D26003.0	Boolean	NDO_AS04SL_A_2_1_2_Control_Output_1	
	Control Output 2	D26003.1	Boolean		
	Instability Alarm	D26003.2	Boolean		
	Warning	D26003.3	Boolean		
	Error	D26003.4	Boolean		
	Incident Light Level Blue	D26004.0 - D26004.11	Unsigned Integer	NDO_AS04SL_A_2_1_3_Incident_Light_Level	
	Incident Light Level Green	D26005.0 - D26005.11	Unsigned Integer	NDO_AS04SL_A_2_1_3_Incident_Light_Level	
	Incident Light Level Red	D26006.0 - D26006.11	Unsigned Integer	NDO_AS04SL_A_2_1_3_Incident_Light_Level	
	Light Emitting Color	D26007.0 - D26007.2	Unsigned Integer	NDO_AS04SL_A_2_1_3_Light_Emitting_Color	
	Digital Out	D26008.0	Boolean	NDO_AS04SL_A_2_1_3_Digital_Out	
	Sensor Switch	D26008.1	Boolean		

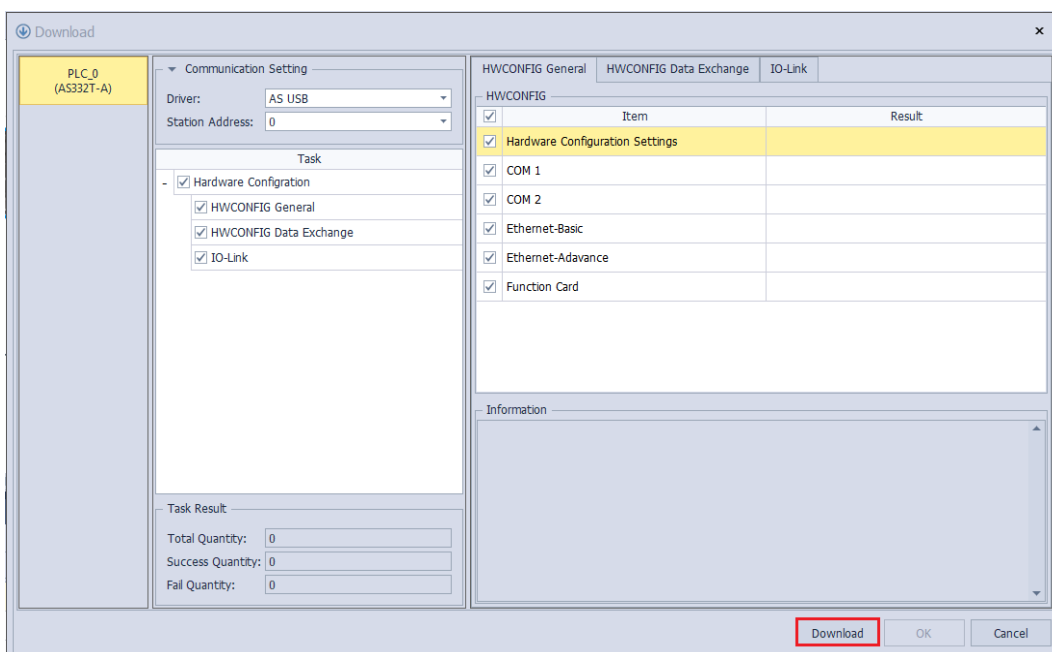
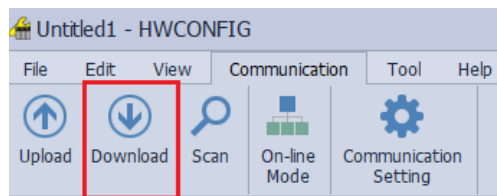

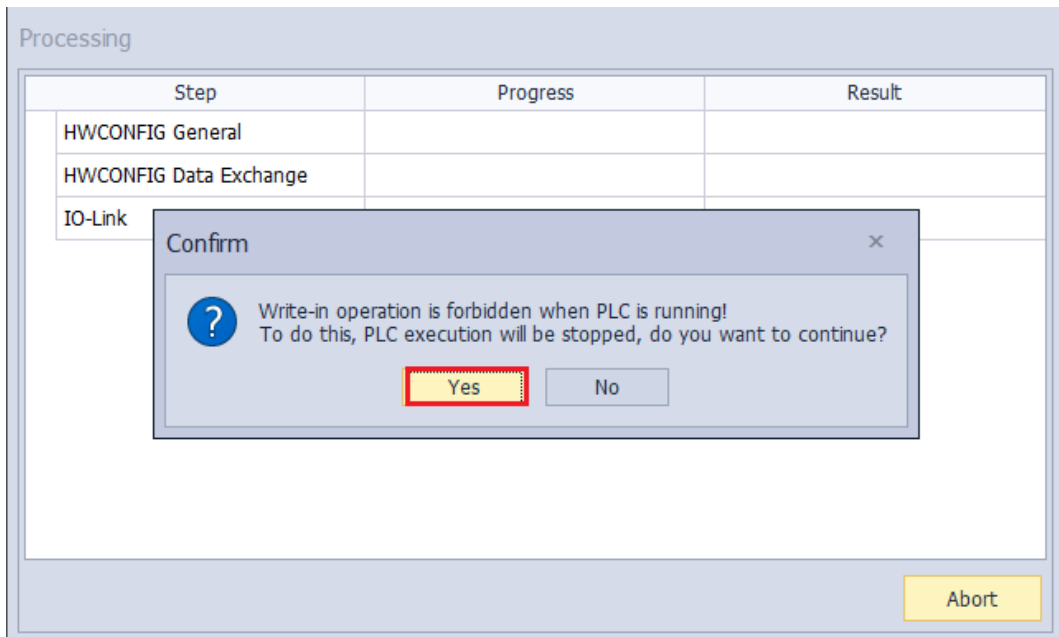
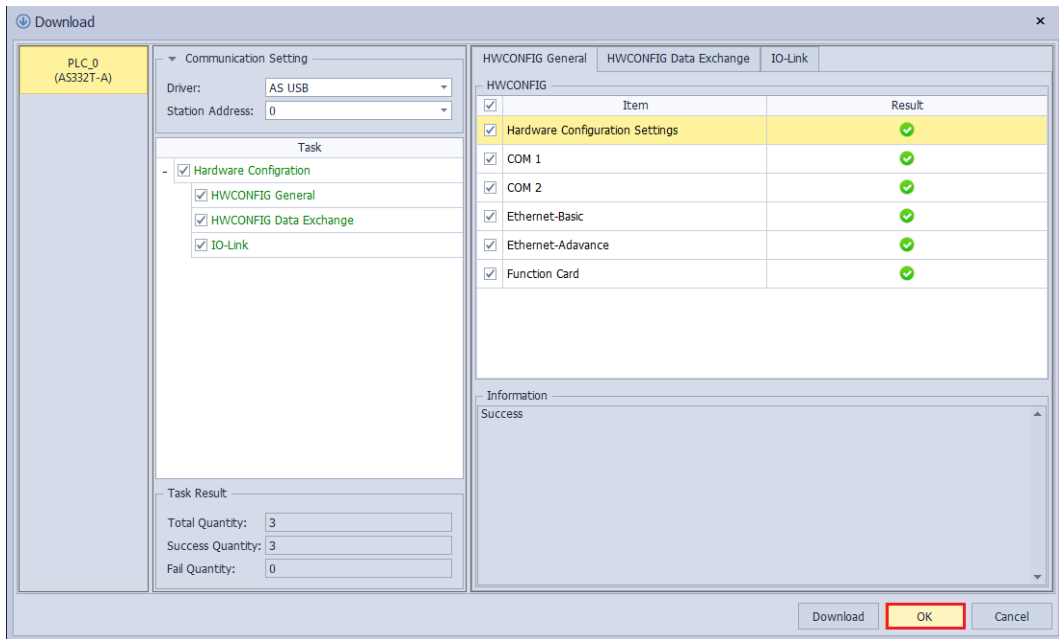

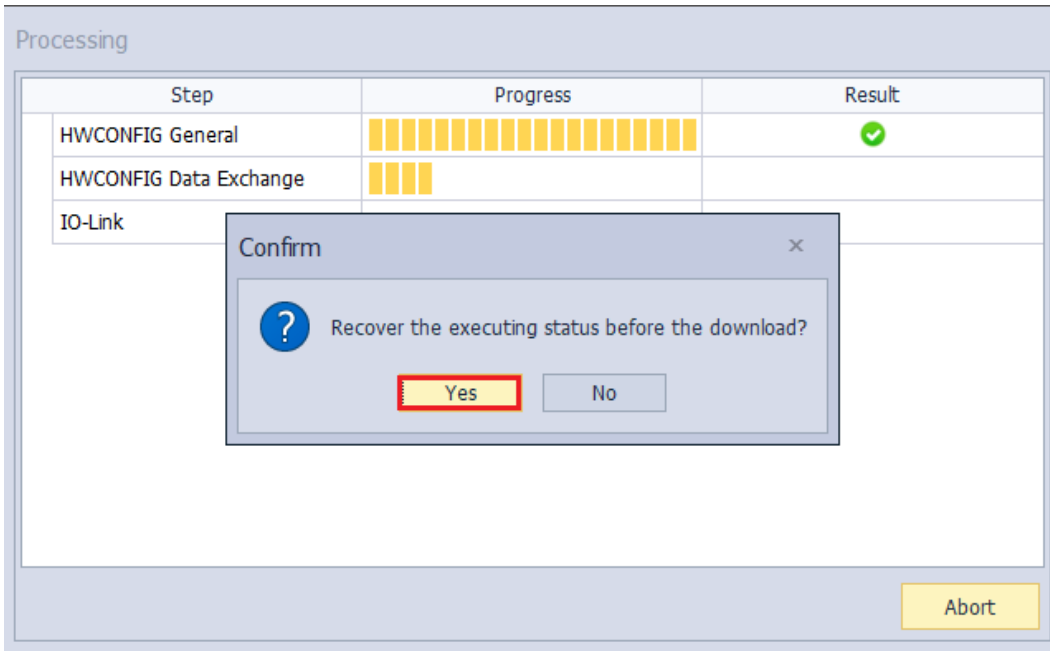

13

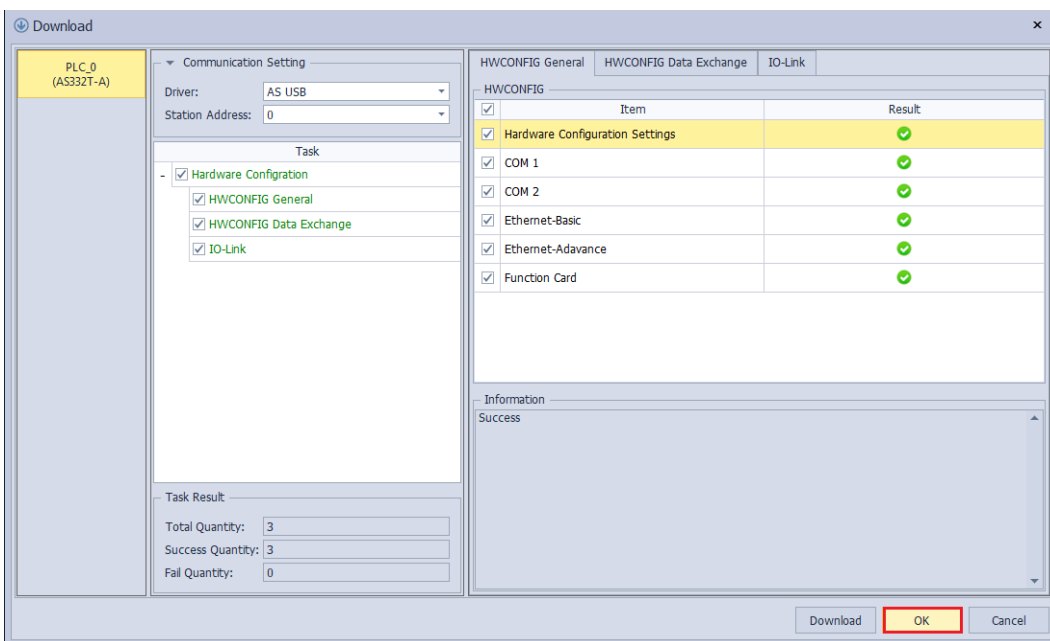

Click the **On-line Mode** button on the IO-Link page and then see the connection status of all devices and the real time monitored values of input and output process data.

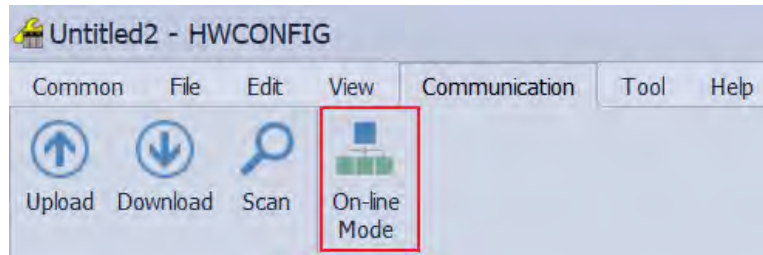

Online

Status	Port ID	Mode	Type	Source	Instance	Definition
✓	1	Event single shot.	Notification	Master	Application	{b0ff21} DL: Device plugged in (NEW_SLAVE).
✓	2	Event single shot.	Notification	Master	Application	{b0ff21} DL: Device plugged in (NEW_SLAVE).
✓	3	Event single shot.	Notification	Master	Application	{b0ff21} DL: Device plugged in (NEW_SLAVE).
✓	4	Event single shot.	Notification	Master	Application	{b0ff21} DL: Device plugged in (NEW_SLAVE).

Process Data

Port	Name	Address	Data Type	Value	Tag Name	Comment
Port 1	D26000 - D26002					
	External Calibration Input Response	D26000.0	Boolean	OFF (false)	NID_AS04SIL_A_2_1_1_External_Calibration	
	External Calibration Done	D26000.1	Boolean	OFF (false)		
	Lights Off Input Response	D26000.2	Boolean	OFF (false)		
	Error	D26000.3	Boolean	OFF (false)		
	Output1	D26000.4	Boolean	OFF (false)		
	Output2	D26000.5	Boolean	OFF (false)		
	Current Value Valid	D26000.6	Boolean	ON (true)		
	Hold Input Response	D26000.7	Boolean	OFF (false)		
	Bank Input Response	D26001.0 - D26001.1	Unsigned Integer	12	NID_AS04SIL_A_2_1_1_Bank_Input_Resp.	
Current Value	D26002.0 - D26002.9	Unsigned Integer	3	NID_AS04SIL_A_2_1_1_Current_Value		
Port 2	D26003 - D26007					
	Control Output 1	D26003.0	Boolean	ON (true)	NID_AS04SIL_A_2_1_3_Control_Output_1	
	Control Output 2	D26003.1	Boolean	OFF (false)		
	Instability Alarm	D26003.2	Boolean	Stable (false)		
	Warning	D26003.3	Boolean	Normal (false)		
	Error	D26003.4	Boolean	Normal (false)		
	Incident Light Level Blue	D26004.0 - D26004.11	Unsigned Integer	0	NID_AS04SIL_A_2_1_2_Incident_Light_L.	
	Incident Light Level Green	D26005.0 - D26005.11	Unsigned Integer	0	NID_AS04SIL_A_2_1_2_Incident_Light_L.	
	Incident Light Level Red	D26006.0 - D26006.11	Unsigned Integer	12	NID_AS04SIL_A_2_1_2_Incident_Light_L.	
	Light Emitting Color	D26007.0 - D26007.2	Unsigned Integer	R (1)	NID_AS04SIL_A_2_1_2_Light_Emitting_C.	
Port 3	D26008 - D26009					
	Digital Out	D26008.0	Boolean	false	NID_AS04SIL_A_2_1_3_Digital_Out	
Sensor Switch	D26008.1	Boolean	true			

13

The **Status** of Port 1~ Port 4 above can also be known through the parsing in the **Normal Exchange Area** of the AS04SIL-A module below.

Normal Exchange Area

Description	Address	Tag Name	Comment
Error code	D29020		
Reserved	D29021		
Port1 - 2 Device Status	D29022 - D29024		
Port3 - 4 Device Status	D29025 - D29027		
Port1 - 4 (IO-Link Process Data) Input Invalid Flag	D29028		
Port1 - 4 Pin2 value	D29029		

With a click on any device, only the input and output process data of the clicked single device will be displayed.

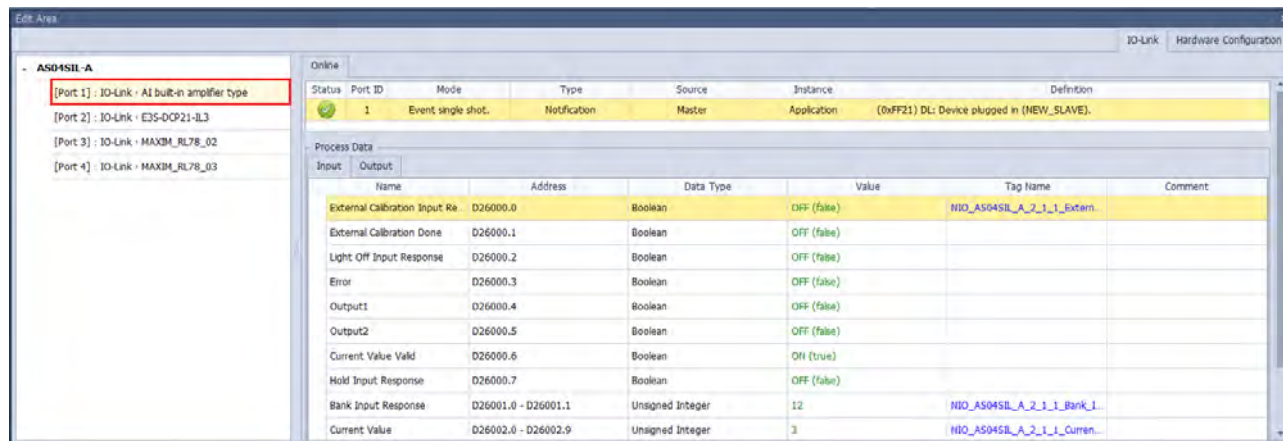

13

13.4.4 Application of Delta Special Driver & AS Remote Mode

The device list in the following example is the same as that in section 12.4.3.

Model name	Device type
AS332T-A	PLC
AS00SCM-A	RTU
AS04SIL-A	IO-Link Master
AI-B100	3 rd IO-Link Device
E3S-DCP21-IL3	3 rd IO-Link Device
MAXREFDES27#	3 rd IO-Link Device
MAXREFDES36#	3 rd IO-Link Device

Complete the following setups before the AS00SCM-A module is powered on.

1. The AS-FCOPM card is inserted to AS00SCM-A via Card 2. (The 120Ω terminal resistor is enabled.)
2. Use Delta standard cable to connect to AS CPU and the mode switch is turned to RTU mode.
3. Four switches are set to ID1: 0 / FORMAT1: 8 / ID2: 9 / FORMAT2: 7 and the status is set to **Delta Special Driver & AS Remote Communication**, node ID 9 and baud rate 1Mbps.
4. AS04SIL-A is connected on the right side of AS00SCM (RTU). Ensure that IO-Link devices are connected to the four ports according to the wiring in section 13.2.3.

Switch the power on after the AS-FCOPM card is inserted to AS332T-A via Card 2. (The 120Ω terminal resistor is enabled.) Open the HWCONFIG 4.0 software, set up function card 2 for AS CPU and then download the settings as follows.

Edit Area

General Data Exchange

- AS332T-A

- + System settings
 - COM1 Port Setting
 - COM2 Port Setting
 - Ethernet Port Basic Setting
- + Ethernet Port Advanced Setting
 - Function Card 1 Setting
 - Function Card 2 Setting**

Function Card 2 Setting

Name	Value
Parity bit	Even
Stop bit	1
MODBUS mode	ASCII
Delay time to Reply	0
Received Data Timeout	200
F2AD Analog Input mode	0~10V
F2DA Analog Output mode	0~10V
F2AD Sampling Time	3
F2AD Average Times	10
AS-FCOPM Working mode	Delta Special Driver & AS Remot...
AS-FCOPM node ID	1
Number of remote modules in Delta Special Driv...	1
Select Run mode after detect remote module	Run connected remote module
AS CPU module keep or Stop when slave node...	Only Show Error Message
Remote and CANopen communication time out	100
Re-connected Retry number after time out	60
Auto Retry connection after Disconnected	60
AS-FCOPM Bit Rate	1000k
Communication data sampling position	Auto
DS301 PDO Data Exchanged	Start after power-on
CAN Hardware error counter	Enable

The following steps are the same as the operation in section 13.4.3.

13.4.5 Application of CANopen DS301 Mode

In this example, the AS00SCM-A RTU module works with EDS V2.06. Please download the EDS from Delta official website and import the CANopen Builder software.

The device list in the following example is the same as that in section 12.4.3.

Model name	Device type
AS332T-A	PLC
AS00SCM-A	RTU
AS04SIL-A	IO-Link Master
AI-B100	3 rd IO-Link Device
E3S-DCP21-IL3	3 rd IO-Link Device
MAXREFDES27#	3 rd IO-Link Device
MAXREFDES36#	3 rd IO-Link Device

The CANopen Builder does not support the configuration of extension modules on the right of the AS00SCM-A module and connected IO-Link devices.

First make the connection in **AS Special Remote** mode, configure all extension modules and IO-Link devices in the HWCONFIG 4.0 software (see the example in section 13.4.3) and then switch back to the **CANopen DS301** mode.

Please complete the following setups before the AS00SCM-A module is powered on.

1. The AS-FCOPM card is inserted to AS00SCM-A via Card 2. (The 120Ω terminal resistor is enabled.)
2. Use Delta standard cables to connect to AS CPU and the mode switch is turned to RTU mode.
3. Four switches are set to ID1: 0 / FORMAT1: 4 / ID2: 2 / FORMAT2: 7 and the status is set to **CANopen DS301**, node ID 2 and baud rate 1Mbps.
4. AS04SIL-A is connected on the right side of AS00SCM (RTU). Ensure that IO-Link devices are connected to the four ports according to the wiring in section 13.2.3.

Switch the power on after the AS-FCOPM card is inserted to AS332T-A via Card 2. (The 120Ω terminal resistor is enabled.) Open the HWCONFIG 4.0 software, set up function card 2 for AS CPU and then download the settings as follows.

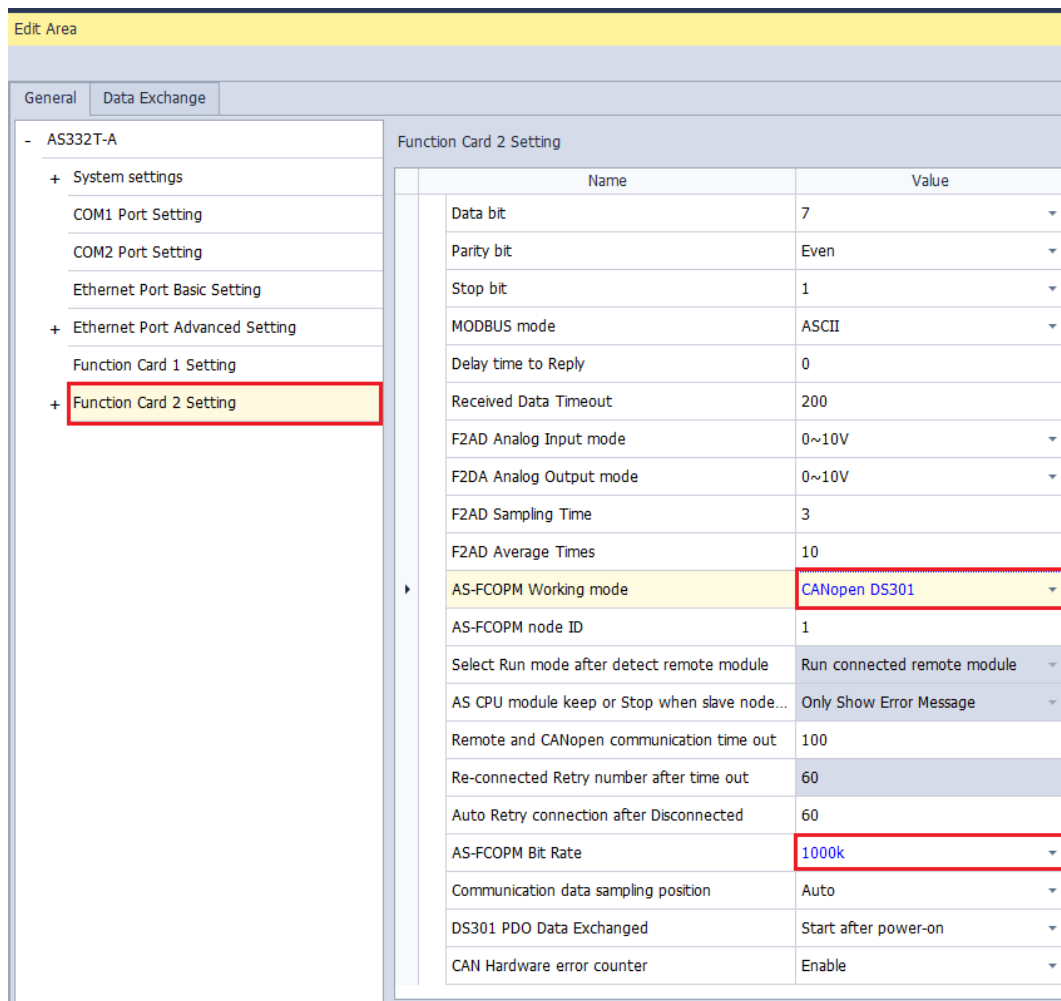

Right-click the AS332T-A symbol and open the CANopen Builder software as below.

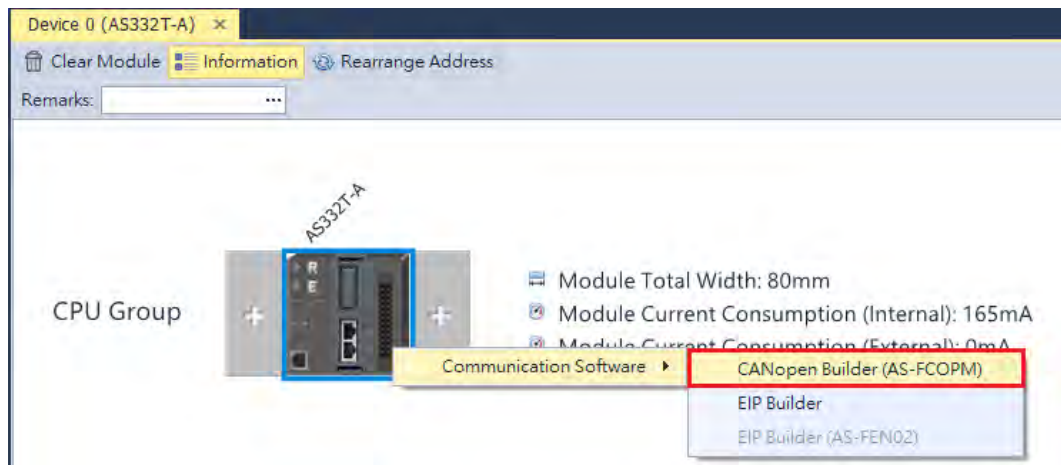

Click the **Online** button.

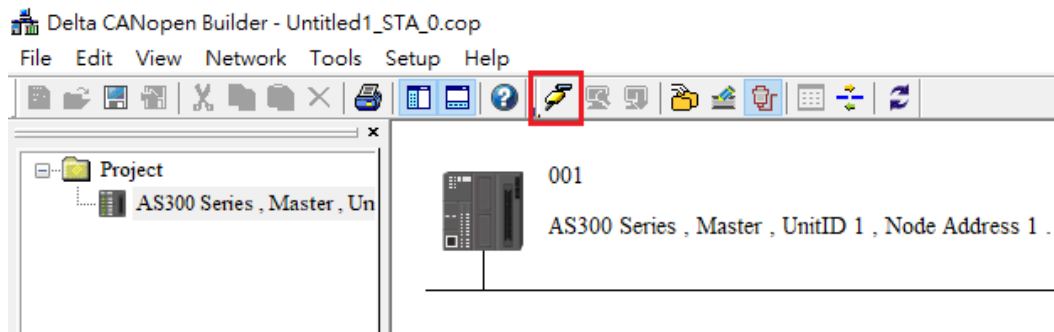

Click the **Scan** button. Then the AS00SCM-A RTU module can be detected.

13

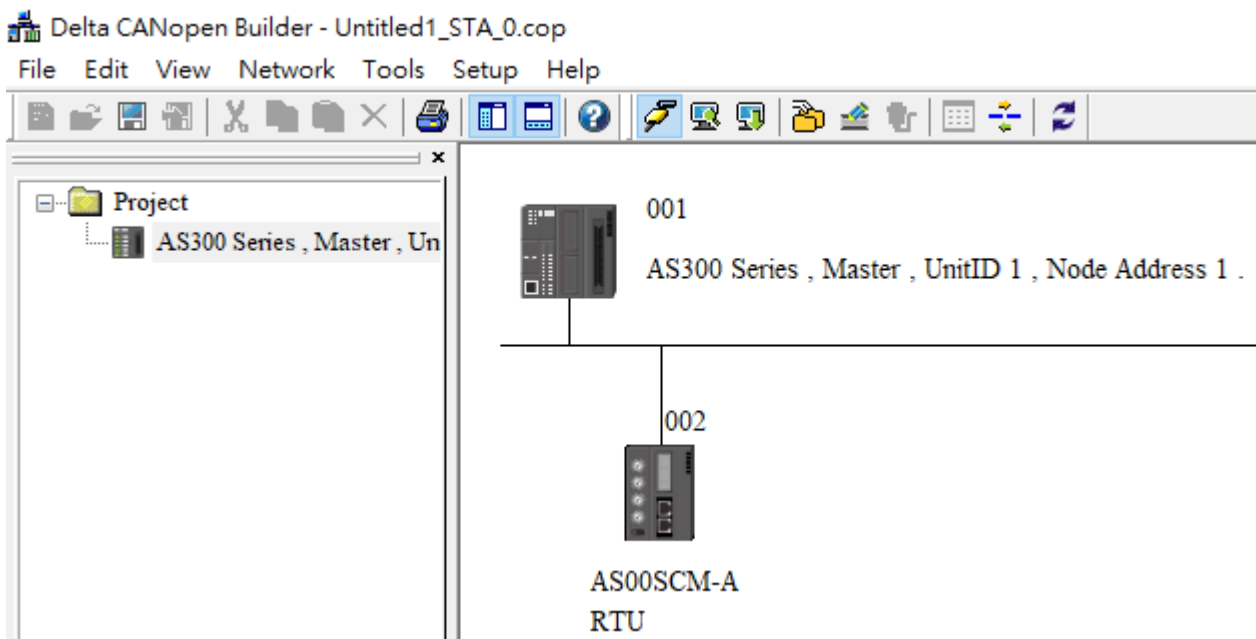
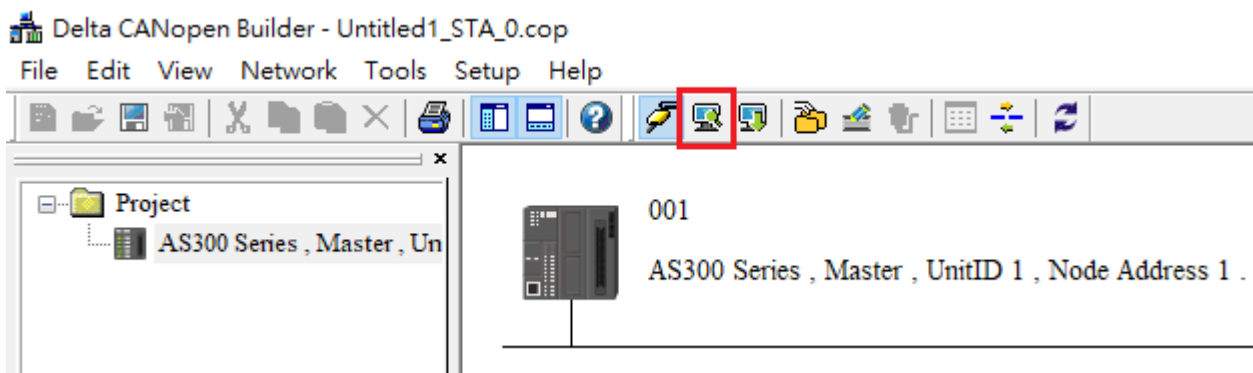

Double-click the detected AS00SCM-A RTU module and ensure that it is with EDS file V2.06 or later. If the EDS file is not matched, check if the V2.06 EDS file has been imported to the left-side device list and the firmware of AS00SCM-A is V2.06 or later.

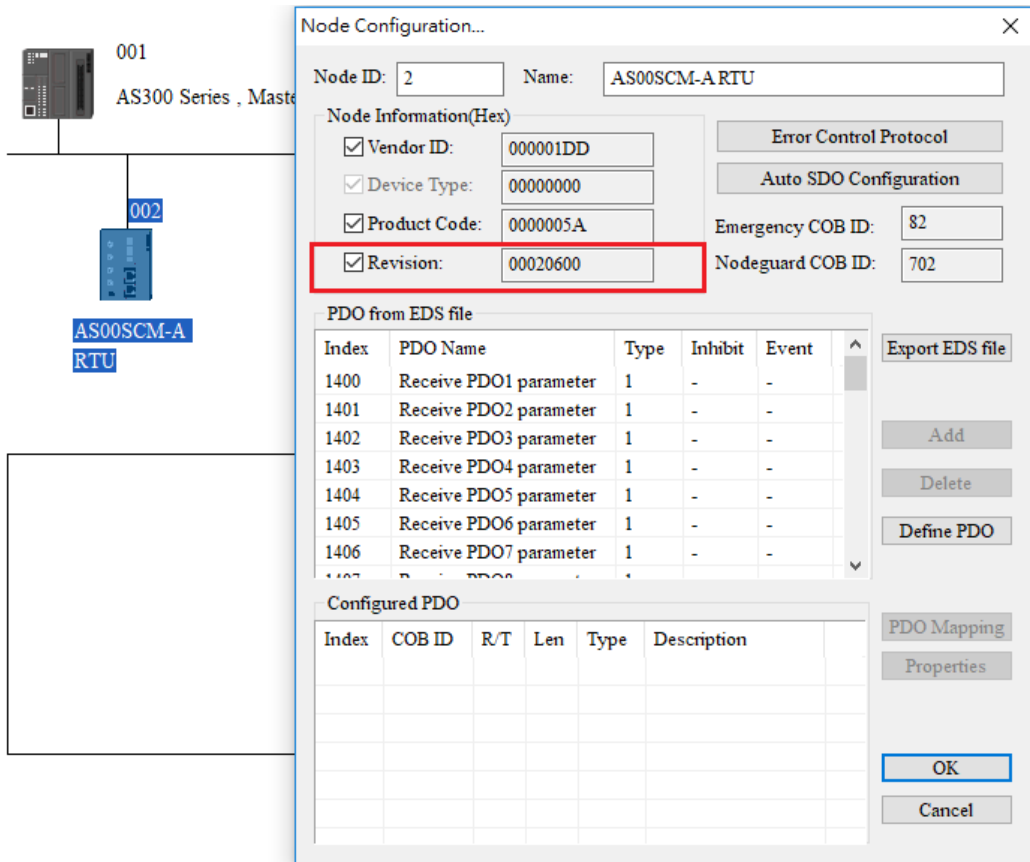
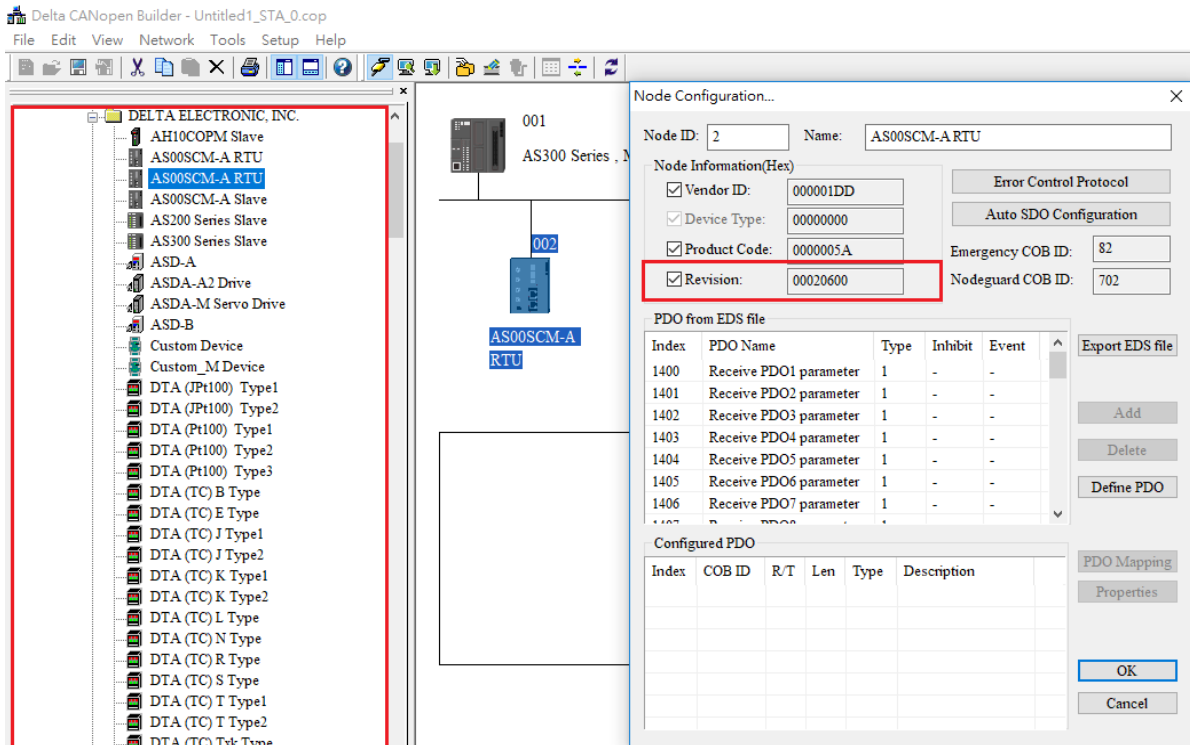

Each object in the EDS file is 1 word (2 bytes) in size and thus one PDO corresponds to one mapped register. Assign all input parameters to available TxPDOs according to the parameters in the **Normal Exchange Area** of AS04SIL-A in section 13.4.3. The mapped PDO object of the input process data is Tx_ModuleX_EDII (Exchanging Data Input which is referred to as EDI).

In this example, the AS04SIL-A module is the first one on the right of the RTU module. Therefore the value of X is 1 and the PDO mapped object for error codes is Tx_Module1_error_code. The corresponding objects starts from Tx_Module1_EDII0 as below.

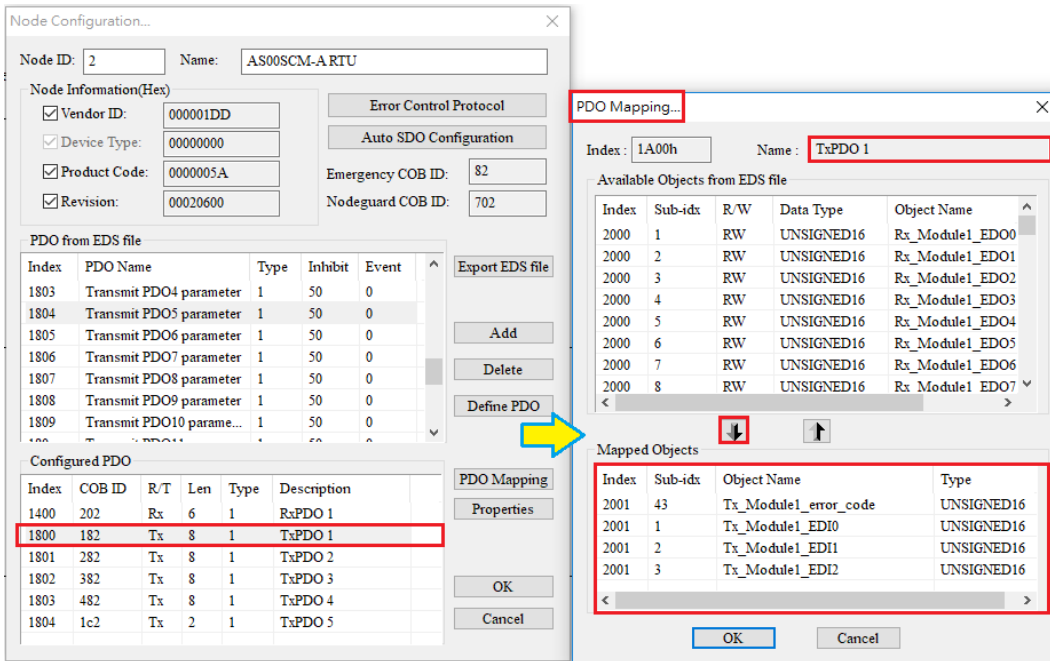

13

Based on all communication port address information in the HWCONFIG 4.0 software in section 13.4.3, assign all input process data to available TxPDOs, which corresponds to the mapped object Tx_NIOX_PD_InputZ and assign all output process data to available RxPDOs, which corresponds to the mapped object Rx_NIOX_PD_OutputY.

In this example, the AS04SIL-A module is the first one on the right of the RTU module. Therefore the value of X is 1, the input objects starting from Tx_NIO1_PD_Input0 correspond to IO-Link Port1~ Port4 in **Process Data- Input** respectively and the output objects starting from Rx_NIO1_PD_Output0 correspond to IO-Link Port1~ Port4 in **Process Data- Output** respectively.

Configure all parameters which need to be updated continuously (which are called objects in CANopen Builder) to one TxPDO or RxPDO according to the steps described above. Add AS00SCM-A RTU to the slave list (Node List) and then the real addresses of mapped registers in AS CPU show up immediately as below.

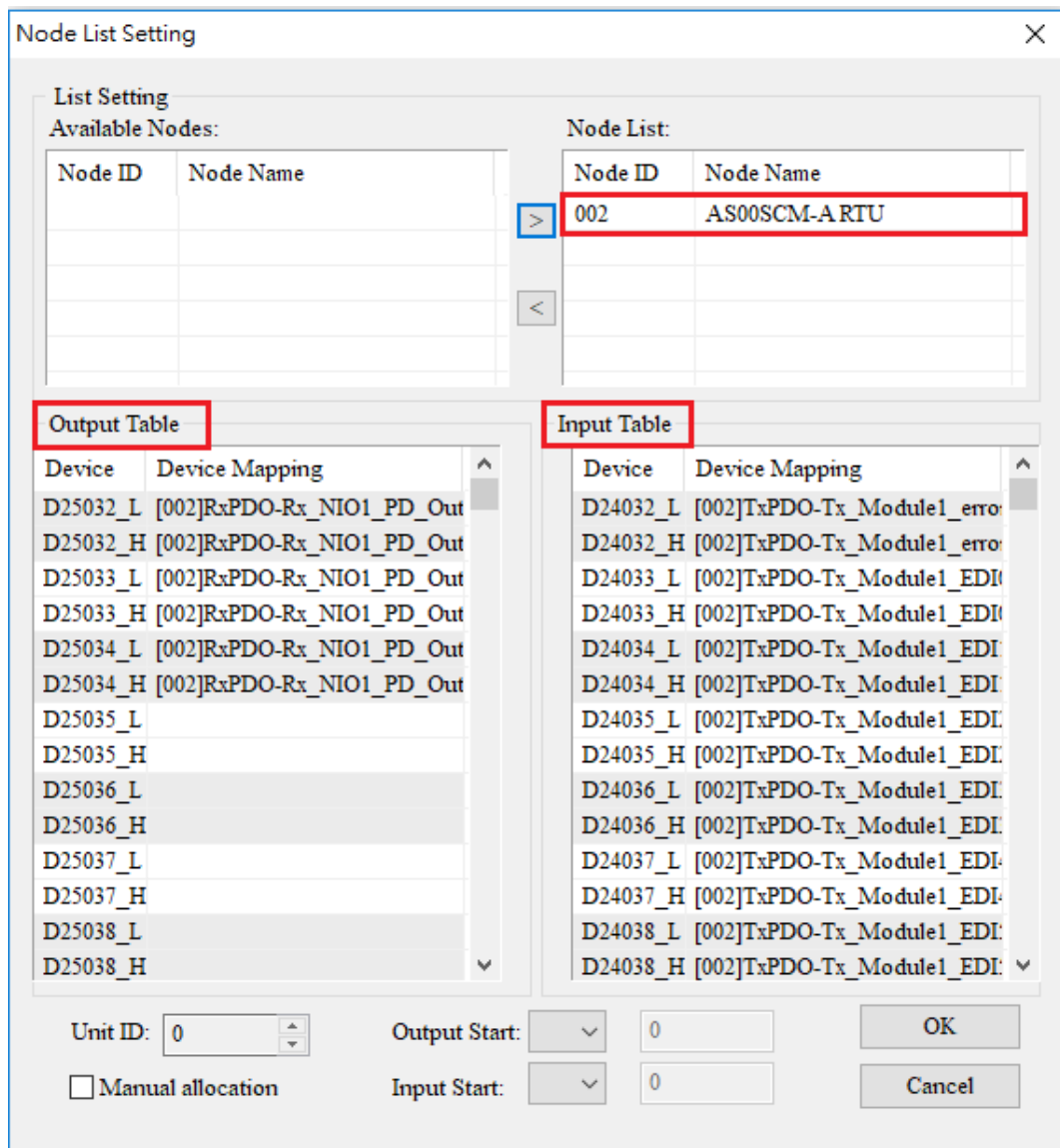

According to the **Normal Exchange Area** page in HWCONFIG in section 13.4.3, the PDO mapped objects correspond to the mapped registers assigned by CANopen Builder as follows.

Device Information		Normal Exchange Area		
	Description	Assign mapped registers by CANopen Builder		PDO mapped objects
▶	Error code	D28000	D24032	Tx_Module1_error_code
	Reserved	D28001		
	Port1 - 2 Device Status	D28002 - D28004	D24033 - D24035	Tx_Module1_EDIO - Tx_Module1_EDI2
	Port3 - 4 Device Status	D28005 - D28007	D24036 - D24038	Tx_Module1_EDI3 - TX_Module1_EDI5
	Port1 - 4 (IO-Link Process Data) Input Invalid...	D28008	D24039	Tx_Module1_EDI6
	Port1 - 4 Pin2 value	Example didn't select this object into PDO, so no mapped register.		Tx_Module1_EDI7

Parameter	Configured PDO	PDO mapped object	Mapped register in AS CPU
Error code	TxPDO1	Tx_Module_error_code	D24032
Port 1-2 Device Status		Tx_Module1_EDi0	D24033
		Tx_Module1_EDi1	D24034
Port 3-4 Device Status	TxPDO2	Tx_Module1_EDi2	D24035
		Tx_Module1_EDi3	D24036
Tx_Module1_EDi4		D24037	
Port1-4 (IO-Link Process Data) Input Invalid Flag	Tx_Module1_EDi5	D24038	
Port 1 Process Data- Input	TxPDO3	Tx_Module1_EDi6	D24039
		Tx_NIO1_PD_Input0	D24040
		Tx_NIO1_PD_Input1	D24041
Port 2 Process Data- Input	TxPDO4	Tx_NIO1_PD_Input2	D24042
		Tx_NIO1_PD_Input3	D24043
		Tx_NIO1_PD_Input4	D24044
		Tx_NIO1_PD_Input5	D24045
Port 3 Process Data- Input	TxPDO5	Tx_NIO1_PD_Input6	D24046
		Tx_NIO1_PD_Input7	D24047
Tx_NIO1_PD_Input8		D24048	
Port 4 Process Data- Input		Tx_NIO1_PD_Input9	D24049
Tx_NIO1_PD_Input10		D24050	
Port 1 Process Data- Output	RxPDO1	Tx_NIO1_PD_Input11	D24051
		Rx_NIO1_PD_Output0	D25032
Rx_NIO1_PD_Output1		D25033	
Port 2 Process Data- Output		No parameter need be output	No parameter need be output
Port 3 Process Data- Output		Rx_NIO1_PD_Output2	D25034
Port 4 Process Data- Output		Rx_NIO1_PD_Output3	D25035

13.5 IO-Link Event Code Table

Here is the table of IO-Link event codes which are recorded in **Port1-4 Device Status** of the **Normal Exchange Area** page. If the sources of events are IO-Link devices, please also refer to the IO-Link device operation manual.

IO-Link Event Codes	Type			Event	Solution	Source	
	Warning	Error	Notification			IO-Link Master	IO-Link Device
16#4000		V		Device temperature over-load	Lower load		V
16#4210	V			Device temperature over-run	Clear source of heat		V
16#5101		V		Device fuse blown	Change fuse		V
16#5110	V			Power supply voltage over-run	Check tolerance		V
16#5111	V			Power supply voltage under-run	Check tolerance		V
16#6320		V		Parameter error	Check device specifications		V
16#6321		V		Parameter missing	Check device specifications		V
16#7710		V		Device short circuit	Check installation		V
16#8C10	V			Process variable range over-run	Check process data		V
16#8C20		V		Measurement range over-run	Check application		V
16#8C30	V			Process variable range under-run	Check process data		V
16#8CA0	V			No connected IO-Link device	Check installation	V	
16#8CA1	V			The version of the IO-Link protocol is different from the one configured.	Use matching IODD file and configured again.	V	
16#8CA2	V			Connected device is different from the one configured in the software	Check configurations and installation	V	
16#8CA3				Reserved		V	
16#8CA4 16#8CAD 16#8CAE		V		IO-Link device process cable short circuit	Check installation	V	
16#8CA5	V			Master temperature exceeds 135°C	Clear source of heat	V	
16#8CA6		V		Master temperature exceeds 160°C	Clear source of heat and lower load	V	
16#8CA7	V			Device power supply voltage under-run L+ (<18V)	Check the external power supply	V	

IO-Link Event Codes	Type			Event	Solution	Source	
	Warning	Error	Notification			IO-Link Master	IO-Link Device
16#8CA8		V		Device power supply voltage under-run L+ (<9V)	Check the external power supply	V	
16#8CA9	V			Illegal device ID	Check device specifications	V	
16#8CAA	V			HWCONFIG configured process data exceeding the IO-Link process data range	Check device specifications	V	
16#8CAB	V			IO-Link process data exceeding HWCONFIG configured process data range	Scan the device and download the configuration again	V	
16#8CAC		V		Data storage error	Contact the factory	V	
16#FF21			V	New connected device		V	
16#FF22			V	Device disconnected	Check installation	V	
16#FF23			V	Data storage identification mismatch	Set the Data Storage access locked and set it to backup / restore and then backing up data according to actual placement.	V	
16#FF24			V	Data storage not sufficient	Check device specifications	V	
16#FF25			V	Data storage parameter access denied	Check device specifications	V	

13.6 Module Status Codes

The following error codes identify possible errors when the AS04SIL module as a communication module is installed on the right side of the CPU module or RTU module.

Error Code	Description	Solution
16#1605	Hardware failure	Install a new AS04SIL or contact the factory.
16#1606	24VDC power supply is not sufficient and then recovered from low-voltage for less than 10 ms.	Check whether the 24 V power supply to the module is normal.

Error Code	Description	Solution
16#1800	Error occurs in IO-Link Master	See section 13.5 for more information.
16#1801	Error occurs in IO-Link device	See section 13.5 for more information.
16#1802	No external power supply	Check the external power supply
16#1803	Error in the download of IO-Link device mapping tables	Redownload the configuration by the software
16#1804	Failure to switch the process data parameter set	Check if the connected device is the same as that configured in the software.
16#1805	Error occurs in the communication port 1 of IO-Link connection	<ol style="list-style-type: none"> 1. Cut the external power off for 3 seconds and power-on again 2. Download the configurations again
16#1806	Error occurs in the communication port 2 of IO-Link connection	
16#1807	Error occurs in the communication port 3 of IO-Link connection	
16#1808	Error occurs in the communication port 4 of IO-Link connection	
16#1809	Error occurs in scan device and force to stop scanning	<ol style="list-style-type: none"> 1. Cut the external power off for 3 seconds and power-on again 2. Scan all devices again

MEMO

Chapter 14 High Speed Counter Module AS02HC

Table of Contents

14.1	Overview	4-2
14.1.1	Characteristics.....	4-2
14.2	Specifications and Functions.....	4-3
14.2.1	Specifications	4-3
14.2.2	Profile	4-6
14.2.3	Terminals.....	4-7
14.2.4	Wiring.....	4-8
14.2.5	LED Indicators.....	4-11
14.3	Operation.....	4-12
14.3.1	Parameter Settings	4-12
14.3.2	Pulse Input Counting.....	4-13
14.3.3	SSI Input Counting	4-16
14.3.4	Z-Phase Function Setting	4-22
14.3.5	List of Dedicated API Instructions.....	4-23
14.3.6	The impact of AS CPU Status on AS02HC-A	4-24
14.4	Hardware Configuration via HWCONFIG in ISPSOft.....	4-25
14.4.1	Initial Setting	4-25
14.4.2	Checking the Module Version	4-28
14.4.3	Online Mode.....	4-29
14.4.4	Import and Export a Parameter File	4-30
14.4.5	Parameters	4-31
14.4.6	Normal Exchange Area	4-32
14.5	Troubleshooting.....	4-33
14.5.1	Error Codes.....	4-33
14.5.2	Troubleshooting Procedure	4-34

14.1 Overview

The AS02HC-A module is a high-speed counter module with two built-in channels. It performs counting through receiving the pulse signal input or SSI encoder signal input. It is only connected to the right side of AS series CPU modules. Configuring it to the right side of the remote modules is not allowed. This chapter mainly introduces the specifications, functions and operation of the module. For software operation, ISPSOft, DIADesigner or DIADesigner-AX is what you need. If you are using AS Series PLC CPU, refer to ISPSOft User Manual or DIADesigner Manual for more information. The new software DIADesigner-AX only supports AX Series PLC CPU and AS Series modules now, refer to AX-3 User Manual for more information on software operation.

14.1.1 Characteristics

1. Pulse signal / SSI signal input interface selection

Pulse input: Supports single-phase pulse input, two-phase pulse input (multiplication x2/4) and CW / CCW pulse input, 5V differential signal and 5-24VDC single-ended signal. The counting speed can reach up to 200kHz (for single-phase input).

SSI input: The data transmission frequency can reach up to 1.25 MHz; the received data length can be up to 32 bits; supports multi-turn and single-turn SSI encoders as well as the conversion of gray and binary codes.

2. 32-bit counter

The two channels of AS02HC-A are both 32-bit counters with the counting range of -2147483648 to 2147483647.

3. Counter type setting

Ring counter: cyclical counting between -2147483648 and 2147483647.

Linear counter: The upper and lower limit values need be set. When the counter value is out of the allowed range, the module can detect that the upper or lower limit is exceeded.

4. High-speed comparison

Preset a comparison value and compare it with the present value of the counter. When they are equal, the external output point actions can be controlled, the interrupt program can be executed or the counter value can be cleared at the same time.

5. Phase-Z function selection

Each of the two channels is configured with a phase Z which can be used as the external input point for Reset, Capture or Gate control.

6. External output points

Four external output points. They can be controlled individually or be used for the output together with high-speed comparison function.

7. Counter value capture

The counting value is captured through a phase Z input trigger or channel comparison-matched trigger.

8. Pulse rate and rotation rate (RPM) measurement

The function measures the input pulse rate and position change rate of the SSI encoder. And the rotation speed (RPM) can be calculated automatically.

9. Use the tool software for easy settings

The HWCONFIG utility software is built into ISPSOft. You can set modes and parameters directly in HWCONFIG of ISPSOft or Hardware Configuraiton of DIADesigner without spending time writing programs to set registers to manage functions.

10. Miscellaneous API instructions

The functions such as counter control, counter value capture, high-speed comparison output and measurement can be achieved via dedicated API instructions.

14.2 Specifications and Functions

14.2.1 Specifications

Functional specification

Item		Description
Number of channels		2
Pulse Input	Input type	Phase A/B differential pulse input (multiplication x2/4), CW/CCW pulse inputs and pulse + direction inputs
	Max. counting frequency	200 kHz
	Max. transmission distance	200 kHz → 30 m
	Counter type	Ring counter, linear counter
SSI Input	Max. data length	32-bit (The single-turn, multi-turn and status data length can be set.)
	Coding method	binary code, gray code
	Transmission frequency	250 kHz, 500 kHz, 625 kHz, 1 MHz, 1.25 MHz
	Max. transmission distance	250 kHz → 150 m 500 kHz → 50 m 625 kHz → 40 m 1 MHz → 20 m 1.25 MHz → 10 m
	Parity check	None, odd parity, even parity
	Counter type	Absolute counter and ring counter
Counter	Counting range	-2147483648 ~ 2147483647 (32-bit counter)
	Counter control	Reset, preset, gate, capture offset correction for absolute position
	State check	Count direction, counting overflow/underflow, linear counting beyond the lower and upper limit values, SSI feedback, SSI position exceeding the protection limit, SSI parity checking, SSI communication status, a zero point is set beyond SSI encoder resolution
External input point (phase Z)	Input point number	2 (one point per channel)
	Function	Counter reset, gate control, counting value capture
	Digital filtering	Disabled, 100 us, 200 us ...20 ms
	Min. software interrupt response time	20 us (hardware response time included)
External output point	Output point number	4
	Output type	NPN transistor (sinking)
Comparison function	Instruction	General comparison output instruction, table comparison output instruction
	Interrupt	Using comparison to achieve the interrupt function
Measurement function	Measured item	Pulse rate and rotation rate (RPM)
	Average times	1 ~ 10 times

Electrical specifications for the inputs

Model		Pulse input	External input
Item			
Number of inputs		4 (A+/B+/A-/B-)	2 (Z+/Z-)
Connector type		D-sub15	
Input voltage / current		5~24 VDC, 6~15 mA	
Action level	OFF→ON	3 V	
	ON→OFF	1 V	
Maximum input frequency		200 kHz	20 kHz
Input impedance		4.7 kΩ	
Input signal		Single-ended signal: 5 ~ 24 VDC (sinking or sourcing); differential signal: 5 V	
Isolation voltage		500 VAC	
Input display		When the optocoupler is driven, the input LED indicator is ON.	
Weight		138 g	

Electrical specifications for the SSI input and output

Model		SSI input	SSI output
Item			
Number of inputs / outputs		2 (DATA+/DATA-)	2 (CLK+/CLK-)
Connector type		D-sub15	
Voltage / Current		5 VDC, 1 mA	5 VDC, ±60 mA (Max)
Action level	OFF→ON	$V_{ID}^{*1} \geq 0.2 \text{ V}$	-
	ON→OFF	$V_{ID} \leq -0.2 \text{ V}$	-
Maximum frequency		1.25 MHz	
Impedance		12 kΩ (terminal resistor 120 Ω)	-
Signal		RS-422	
Isolation voltage		500 VAC	
Input / output display		When the optocoupler is driven, the LED indicator is ON.	

*1 : V_{ID} is the voltage difference between DATA+ and DATA-.

Electrical specifications for the external outputs

Model		AS02HC-A
Item		
Number of outputs		4
Connector type		D-sub15
Output type		NPN transistor (sinking)
Voltage / Current		5~30 VDC, 0.1 A
Maximum load	Resistance	0.1 A
	Inductance	-
	Bulb	-
Maximum output frequency	Resistance	10 kHz
	Inductance	-
	Bulb	-
Maximum Response time	OFF→ON	25 us
Isolation voltage		500 VAC

Electrical specifications for the +5 V encoder power supply

Model		AS02HC-A
Item		
Number of outputs		2 (+5VO/GND)
Connector type		D-sub15
Voltage / Current		5 VDC ($\pm 5\%$), 100 mA (Max)

14.2.2 Profile

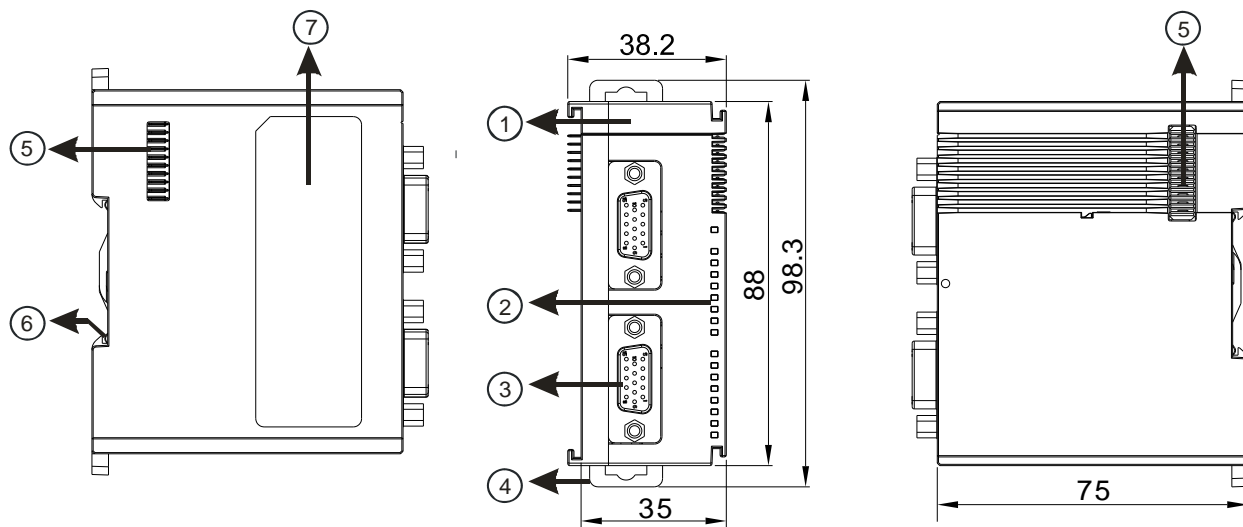

14

Number	Name	Description
1	Model name	Model name of the module
2	POWER LED indicator	Indicates the status of the power supply ON: The power is on. OFF: No power
	Error LED indicator	Error status of the module ON: A major error occurs in the module. OFF: The module is normal. Blinking: A minor error occurs in the module.
	Counter LED indicator for Ch1 Act. & Ch2 Act.	Counting status of the module (Green) OFF: The counter is disabled. When the pulse input takes place: ON: The counter is enabled but the result of counting is not changed. Blinking: The result of counting is updating. When the SSI input takes place: Blinking: The counter is enabled and the position value is updating.
	Input / output LED indicator	ON: Receives an input / output signal OFF: Receives no input / output signal Refer to section 14.2.8 for details.
3	D-sub15	Input: Connected for pulse input and encoder Output: Connected to loads to be driven Power: Providing external encoder +5 VDC
4	DIN rail clip	Secures the module onto the DIN rail
5	Extension module port	Connects extension modules
6	Ground clip	For Grounding
7	Label	Nameplate

14.2.3 Terminals

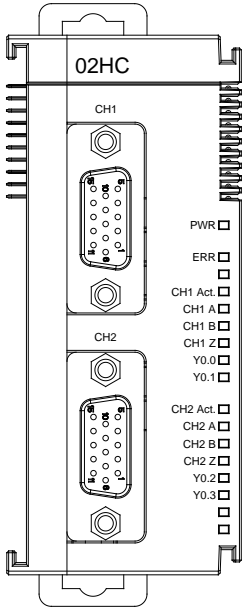
	Pin No.	CH1	CH2
	8	A1+	A2+
	3	A1-	A2-
	7	B1+	B2+
	2	B1-	B2-
	6	Z1+	Z2+
	1	Z1-	Z2-
	10	CLK1+	CLK2+
	5	CLK1-	CLK2-
	9	DATA1+	DATA2+
	4	DATA1-	DATA2-
	14	+5VO1	+5VO2
	15	GND1	GND2
	12	Y0.0	Y0.2
	11	Y0.1	Y0.3
	13	COM0	COM1

14.2.4 Wiring

14.2.4.1 Pulse Input

- The NPN output encoder wiring

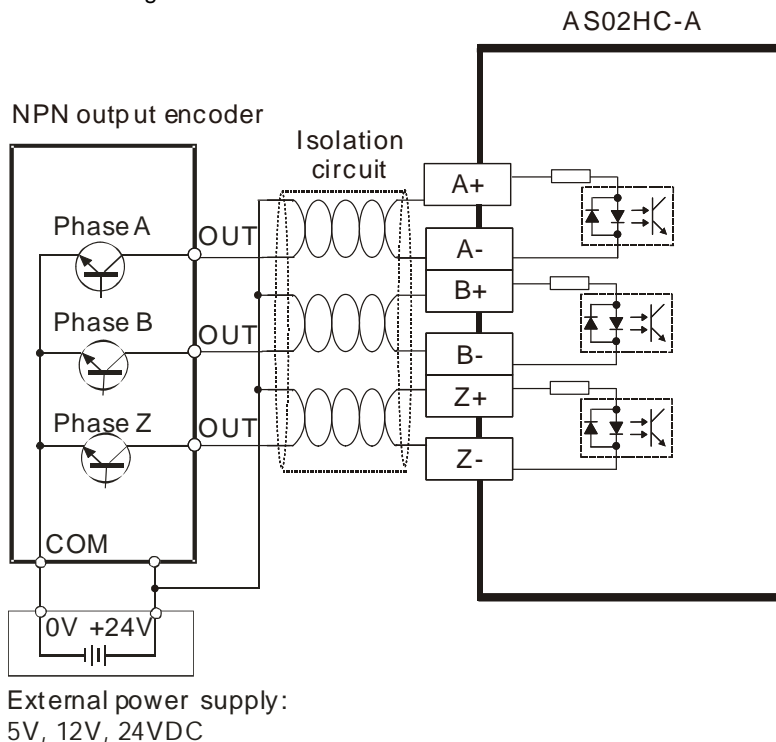

- The PNP output encoder wiring

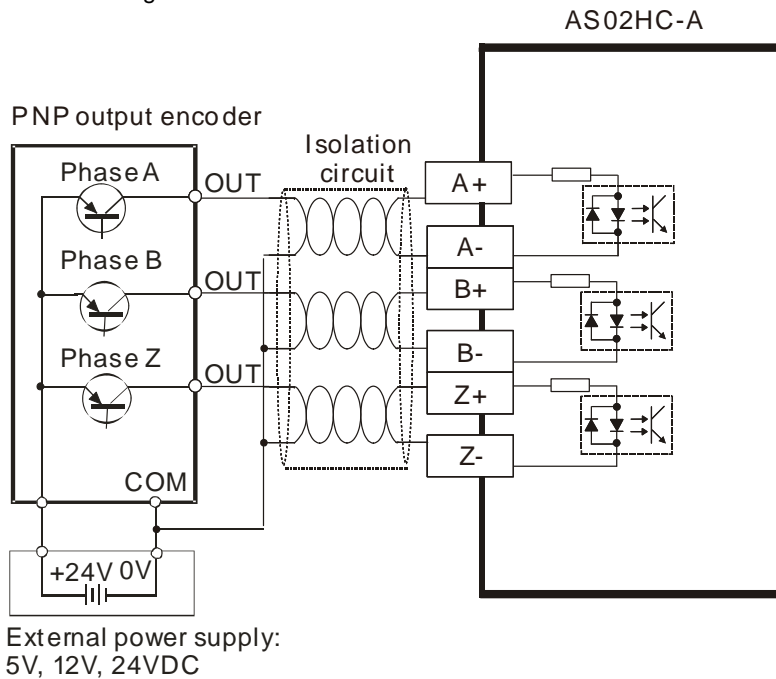

14

- The 5V differential output encoder wiring

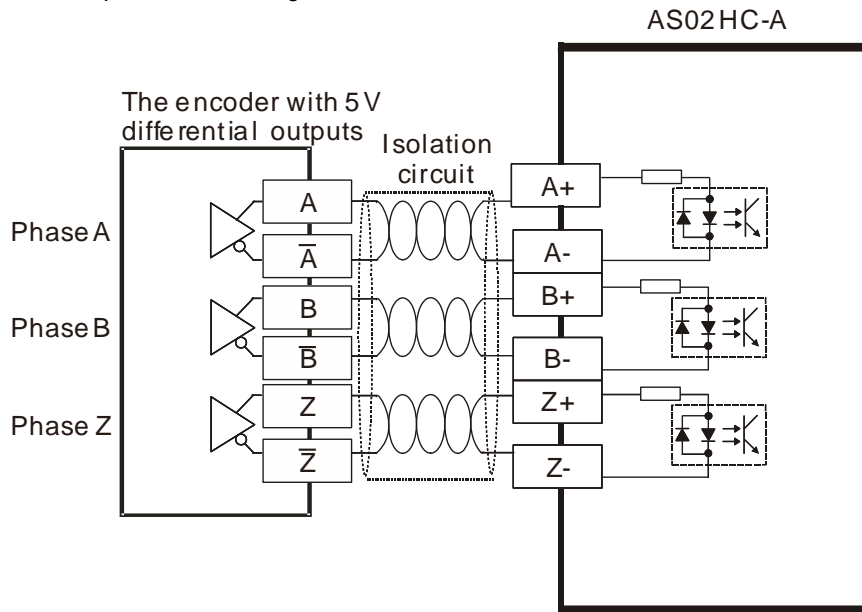

14.2.4.2 SSI Input and Output

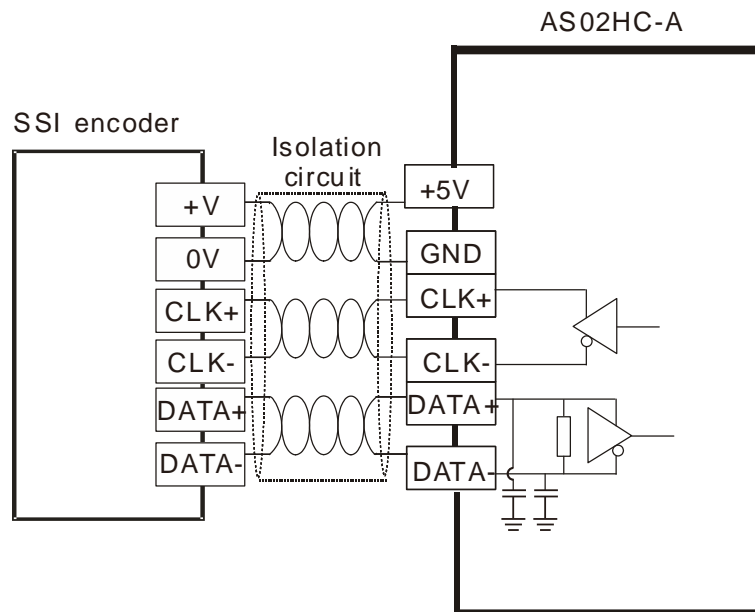

Note:

If the power supply to the SSI encoder is non-5 VDC power supply, please supply corresponding external power based on SSI encoder specifications of different vendors.

14.2.4.3 External Output

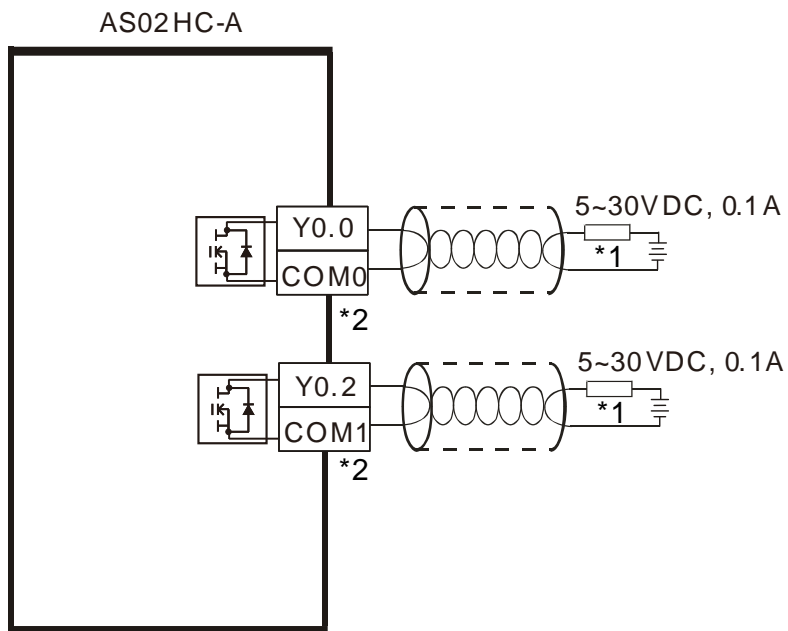

14

*1 : Loads or input points

*2 : Use one single power supply for each COM port.

14.2.5 LED Indicators

Indicator	Color	Name	Description
PWR	Blue	Power indicator	ON: The power supply is normal. OFF: No power supply
ERR	Red	Error indicator	ON: A major error occurs in the module. OFF: The module is operating normally. Blinking: A minor error occurs in the module (Blinks every 0.5 seconds.)
CH1 Act.	Green	Ch1 counter state indicator	OFF: The counter is disabled. Pulse Input - ON: The counter is enabled but there is no change in the counter value. Blinking: The counter value is changing. (Blinks every 0.5 seconds.) SSI Input - Blinking: The counter is enabled and the position value is being updated. (Blinks every 0.5 seconds.)
CH1 A	Red	Ch1 phase-A input indicator	ON: The phase-A input for channel 1 is active. OFF: The phase-A input for channel 1 is not active.
CH1 B	Red	Ch1 phase-B input indicator	ON: The phase-B input for channel 1 is active. OFF: The phase-B input for channel 1 is not active.
CH1 Z	Red	Ch1 phase-Z or DI input indicator	ON: The phase-Z input for channel 1 is active. OFF: The phase-Z input for channel 1 is not active.
Y0.0	Red	Y0.0 output status indicator	ON: The Y0.0 output is active. OFF: The Y0.0 output is not active.
Y0.1	Red	Y0.1 output status indicator	ON: The Y0.1 output is active OFF: The Y0.1 output is not active.
CH2 Act.	Green	Ch2 counter state indicator	OFF: The counter is disabled. Pulse Input - ON: The counter is enabled but there is no change in the counter value. Blinking: The counter value is changing. (Blinks every 0.5 seconds.) SSI Input - Blinking: The counter is enabled and the position value is being updated. (Blinks every 0.5 seconds.)
CH2 A	Red	Ch2 phase-A input indicator	ON: The phase-A input for channel 2 is active. OFF: The phase-A input for channel 2 is not active.
CH2 B	Red	Ch2 phase-B input indicator	ON: The phase-B input for channel 2 is active. OFF: The phase-B input for channel 2 is not active.
CH2 Z	Red	Ch2 phase-Z or DI input indicator	ON: The phase-Z input for channel 2 is active. OFF: The phase-Z input for channel 2 is not active.
Y0.2	Red	Y0.2 output status indicator	ON: The Y0.2 output is active OFF: The Y0.2 output is not active.
Y0.3	Red	Y0.3 output status indicator	ON: The Y0.3 output is active OFF: The Y0.3 output is not active.

14.3 Operation

14.3.1 Parameter Settings

Before using AS02HC-A to count, you need to set the following shown settings in ISPSOft-HWCONFIG. Set the parameters and download the settings to AS02HC-A. Refer to section 14.4. for detailed ISPSOft-HWCONFIG operations.

Tab	Input Interface	Setting Value	Setting Option
CH 1 Setting	Pulse Input	Pulse Type	<ul style="list-style-type: none"> A / B Phase (2x) (default) A / B Phase (4x) CW / CWW Pulse + Direction
		Counter Type	<ul style="list-style-type: none"> Absolute Position (default) Ring Counter
		Maximum	0 ~ 2147483647 (H0 ~ H7FFFFFFF) (default: H7FFFFFFF)
		Minimum	-2147483648 ~ 0 (H80000000 ~ H0) (default: H80000000)
	SSI Input	Ecoder Coding Method	<ul style="list-style-type: none"> Binary Code (default) Gray Code
		Clock Rate	<ul style="list-style-type: none"> 250 KHz 500 KHz 625 KHz 1 MHz (default) 1.25 MHz
		Data Length	7 ~ 32 (default: 5)
		Multi-Turn Length	0 ~ 32 (default: 12)
		Multi-Turn MSB Location	b0 ~ b31 (default: b24)
		Single-Turn Length	1 ~ 32 (default: 13)
		Single-Turn MSB Location	b0 ~ b31 (default: b12)
		Status Length	0 ~ 15 (default: 0)
		Status MSB Location	b0 ~ b31 (default: b0)
		Parity Check	<ul style="list-style-type: none"> None (default) Even Parity Check Odd Parity Check
		Parity Bit Locaiton	b0 ~ b31 (default: b0)
		Parity Check Start	b0 ~ b31 (default: b0)
		Parity Check Length	0 ~ 31 (default: 0)
		Counter Type	<ul style="list-style-type: none"> Absolute Position (default) Ring Counter
		Monoflop Time	4 ~ 2500; unit: 16us (default: 4)
		Maximum Variation Limit	0 ~ 2147483647 (default: 0, disabled)
CH 2 Setting	Same as settings in CH1 Setting		

Tab	Input Interface	Setting Value	Setting Option
Z-Phase Function Setting		CH1 Z-Phase Function	<ul style="list-style-type: none"> Reset Counter (default) Reset Counter + clear Yno (Reset the current counter value and the assigned Y output points from DHCCMP and DHCCMPT instructions.) Capture Gate Control
		CH2 Z-Phase Function	Same as CH1 Z-Phase Function
		Filter Time	0 ~ 200; unit: 100us; default: 0
Alarm Setting		CH1 Ring Counter Overflow / Underflow Detect	Default: disabled
		CH1 SSI Zero Crossing Detect	Default: disabled
		CH2 Ring Counter Overflow / Underflow Detect	Default: disabled
		CH2 SSI Zero Crossing Detect	Default: disabled

14.3.2 Pulse Input Counting

To perform the pulse-input counting, first set the configuration of channels, which includes pulse type and counter type selection in HWCONFIG. If the counter type is set to the linear counter, the maximum counting value and minimum counting value need be set. After the configuration setting is completed, use the API instruction DHCCNT which is special for AS02HC-A in a program to obtain the counting value, achieve the counter control as well as get the real time counter state.

1. Pulse Type

Specify the pulse input type which can be A/B phase (2x), A/B phase (4x), CW/CCW or pulse + direction.

Parameter	Setting	Unit	Default
Pulse Type	A/B phase (2x), A/B phase (4x), CW/CCW, Pulse + direction	-	A/B phase (2x)

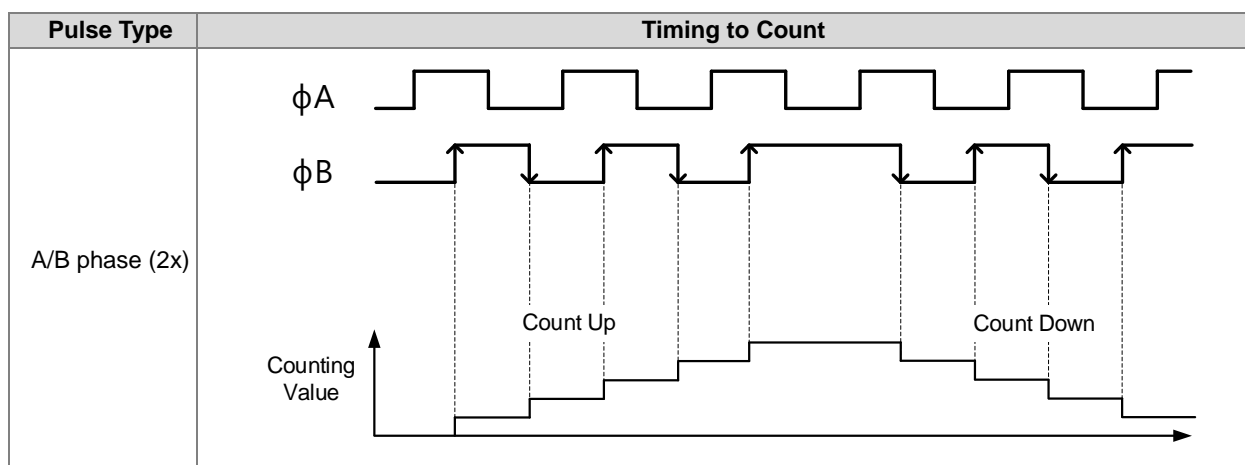

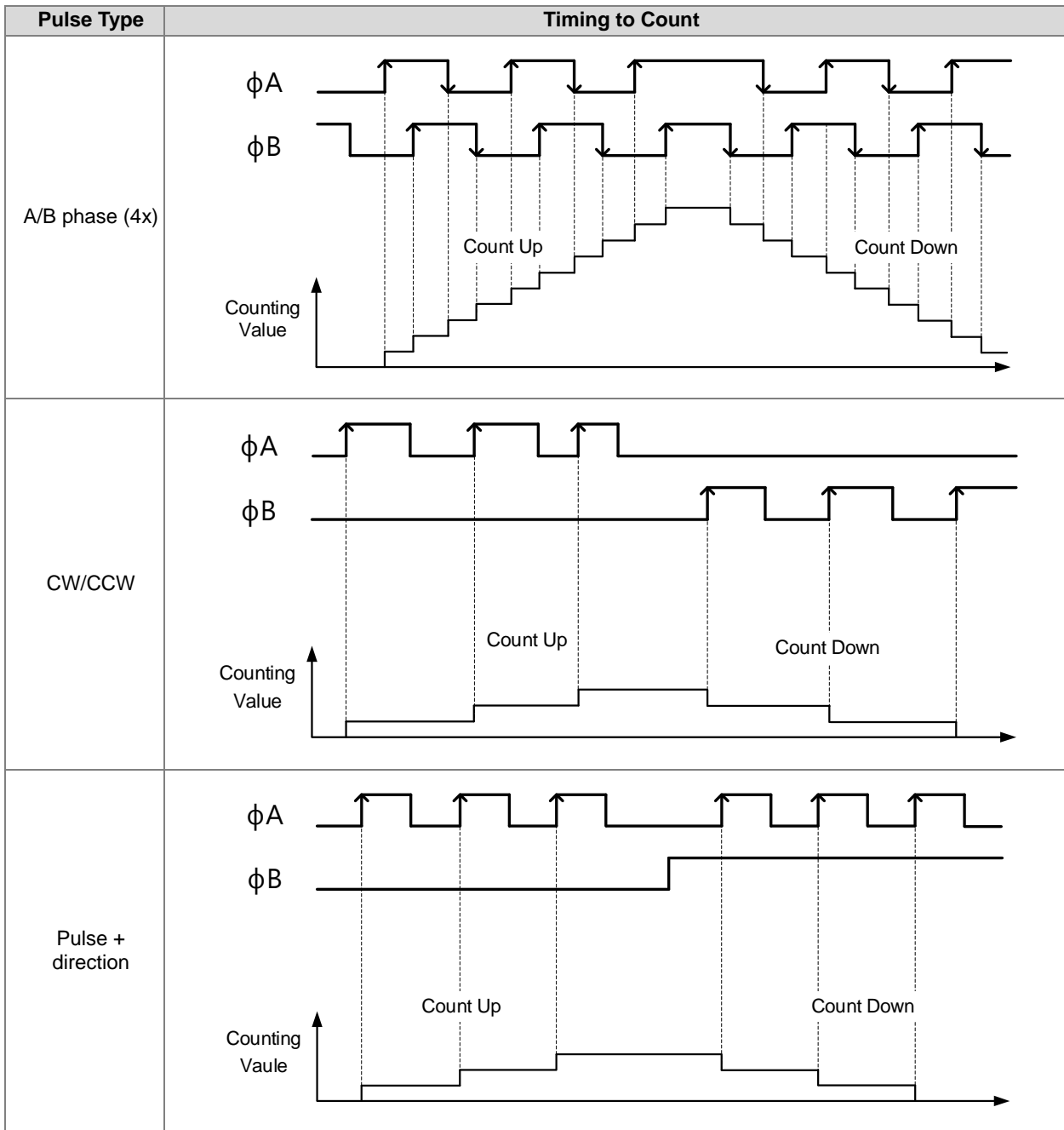

2. Using the ring counter

The ring counter value is cyclical in the range of -2,147,483,648 to 2,147,483,647. When it is greater than 2,147,483,647, the count value changes to -2,147,483,648 and then the counting continues. When it is less than -2,147,483,648, the count value changes to 2,147,483,647 and then the counting continues.

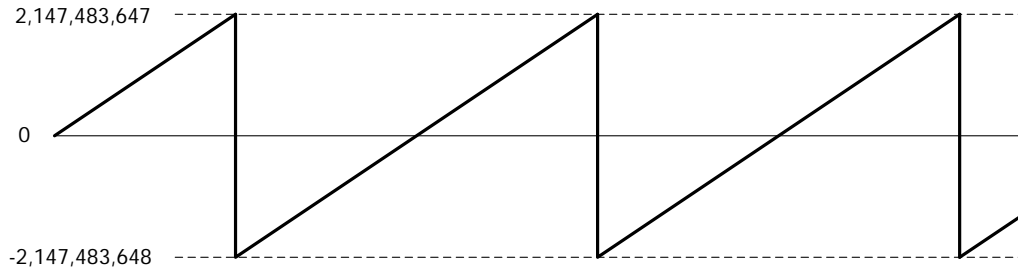

3. Using the linear counter

The maximum and minimum counter values must be set up. The counter counts up and down between the two limit counter value. When the count value exceeds the maximum value, the counter state will show the warning of “The value exceeds the range!” and the count value will be fixed at the maximum counter value. When the count value is below the minimum value, the counter state will show the warning of “The value exceeds the range!” and the count value will be fixed at the minimum counter value.

When the count value is beyond the allowed range, the counting persists internally in the hardware. The counter returns to normal and the count value is refreshed when the internal count value comes back within the valid range.

But when the internal count value in the hardware is beyond the valid range of -2,147,483,648 to 2,147,483,647, the counter state shows linear counter overflow or linear counter underflow, the counting stops and the internal count value stops at 2,147,483,647 or -2,147,483,648. The counting can not continue until the count value overflow state of the counter is cleared.

The methods to clear the states include resetting the counter through phase-Z inputs, executing Reset/Preset via DHCCNT instruction, disabling DHCCNT instruction or changing the CPU from RUN to STOP.

Parameter	Setting	Unit	Default
Max. counter value (upper limit)	0 ~ 2147483647	-	2147483647
Min. counter value (lower limit)	-2147483648 ~ 0	-	-2147483648

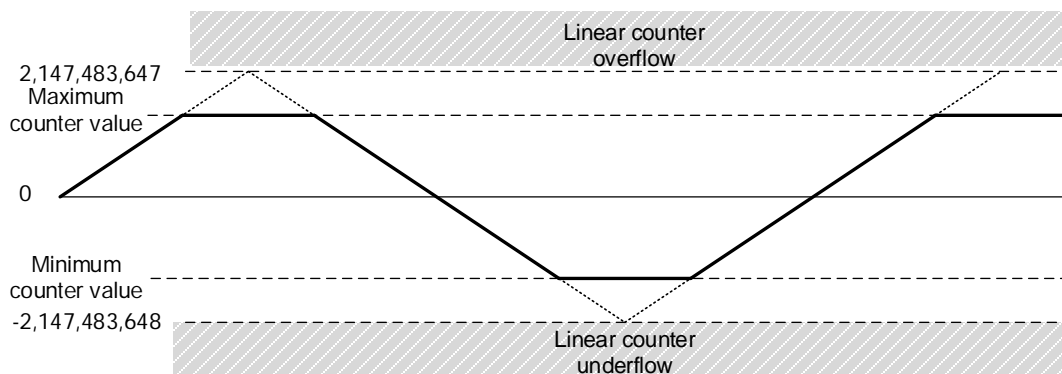

4. Ring counter overflow/underflow detection

Enable the **Ring Counter Overflow/Underflow Detect** function in the Alarm Setting of HWCONFIG. When the overflow or underflow occurs, the alarm will appear.

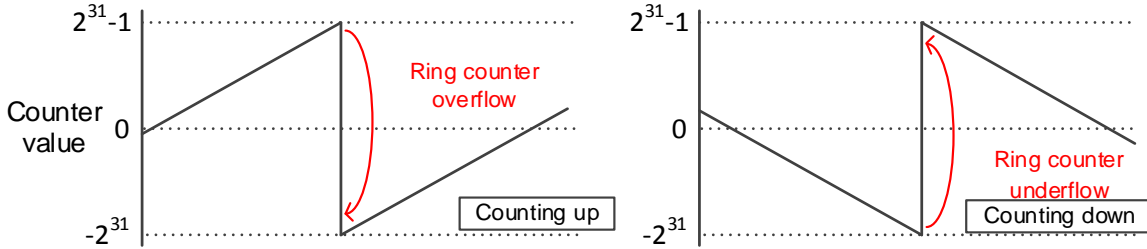

14.3.3 SSI Input Counting

To perform the SSI input counting, first set the configuration of channels in HWCONFIG which includes encoder coding method, clock rate, SSI data format, monoflop time and maximum variation limit. After the configuration setting is completed, use the API instruction DHCCNT which is special for AS02HC-A in a program to obtain the counting value, achieve the counter control as well as get the real time counter state.

14

1. Encoder Coding Method

There are two coding methods, Binary Code and Gray Code for SSI absolute encoder. The Binary Code is the default coding method. If the Gray Code is selected, the gray-code position data (multi-turn and single-turn data) transmitted back from the SSI encoder will be converted into the binary-code position data.

2. Clock Rate

The HWCONFIG software provides 5 clock rates for option including 250 kHz, 500 kHz, 625 kHz, 1 MHz and 1.25 MHz. Default: 1 MHz.

3. SSI Data Format

Set Multi-turn, Single-turn and Status Data start bit & length as well as Parity Check based on the specifications of the used SSI absolute encoder. For SSI data format, 12ST, 13ST, 12 MT+13ST and User-Defined are provided for option. See the descriptions as below for details.

Data Format - 12ST:

<div style="display: flex; justify-content: space-between; width: 100%;"> MSB LSB </div> <div style="display: flex; justify-content: center; align-items: center; gap: 5px;"> <div style="border: 1px solid black; padding: 2px 5px;">b11</div> <div style="border: 1px solid black; padding: 2px 5px;">b10</div> <div style="border: 1px solid black; padding: 2px 5px;">b9</div> <div style="border: 1px solid black; padding: 2px 5px;">b8</div> <div style="border: 1px solid black; padding: 2px 5px;">b7</div> <div style="border: 1px solid black; padding: 2px 5px;">b6</div> <div style="border: 1px solid black; padding: 2px 5px;">b5</div> <div style="border: 1px solid black; padding: 2px 5px;">b4</div> <div style="border: 1px solid black; padding: 2px 5px;">b3</div> <div style="border: 1px solid black; padding: 2px 5px;">b2</div> <div style="border: 1px solid black; padding: 2px 5px;">b1</div> <div style="border: 1px solid black; padding: 2px 5px;">b0</div> </div>											
<div style="text-align: center; margin-bottom: 10px;"> <div style="border: 1px solid black; padding: 5px 20px; display: inline-block;">Single-turn data</div> </div> <p>Data Length (bits): 12 Multi-Turn Data Length (bits): 0 Single-Turn Data Length (bits): 12 Single-Turn Data Start Bit: b11 Status Data Length (bits): 0 Parity Check: No check</p>											

Data Format - 13ST:

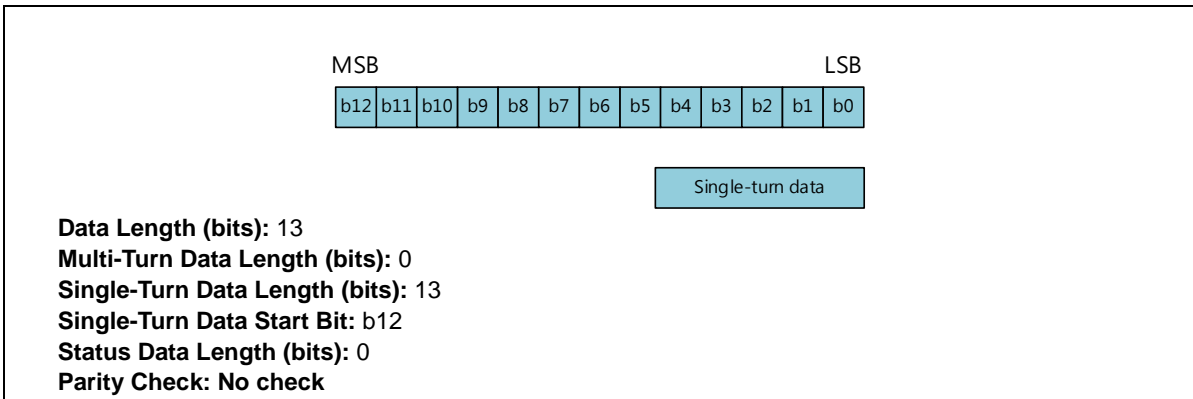

Data Format - 12MT+13ST (Default):

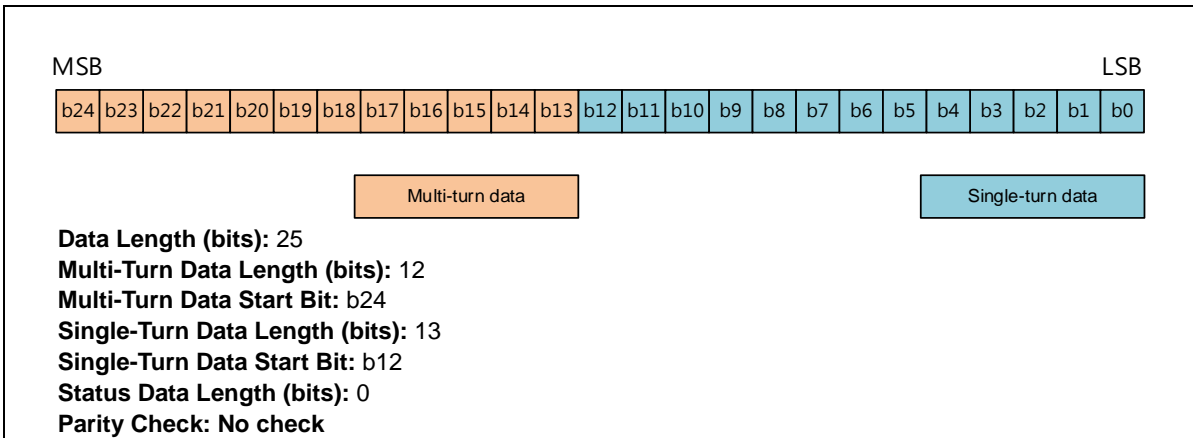

Data Format – User-Defined:

Users can define all parameters based on the illustration in the following diagram.

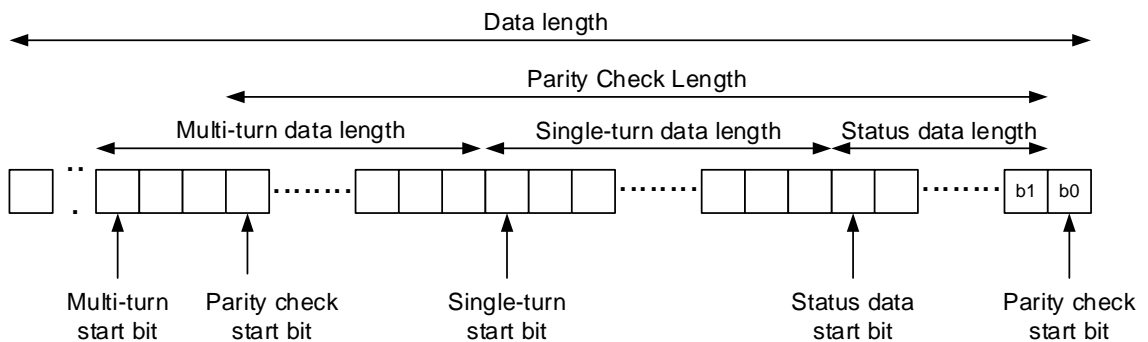

Note: For a multi-turn encoder, the multi-turn data and single-turn data should be next to each other without additional data placed between them.

Item	Setting	Default
Data Length (bits)	7 ~ 31	25
Multi-Turn Data Length (bits)	0 ~ 31	12
Multi-Turn Data Start Bit	B0 ~ b30	B24
Single-Turn Data Length (bits)	1 ~ 31	13
Single-Turn Data Start Bit	B0 ~ b30	B12
Status Data Length (bits)	0 ~ 15	0
Status Data Start Bit	B0 ~ b30	B0
Parity Check	No check, odd parity check, even parity check	No check
Parity Check Bit	B0 ~ b30	B0
Parity Check Start Bit	B0 ~ b30	B0
Parity Check Length (bits)	0 ~ 30	0

Example 1: 25-bit Single-Turn Encoder

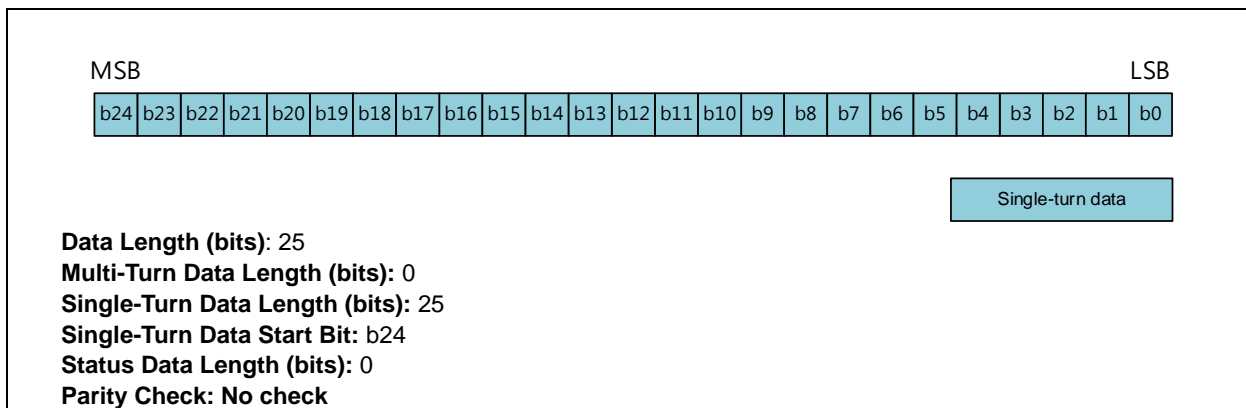

Example 2: Encoder with Status Data

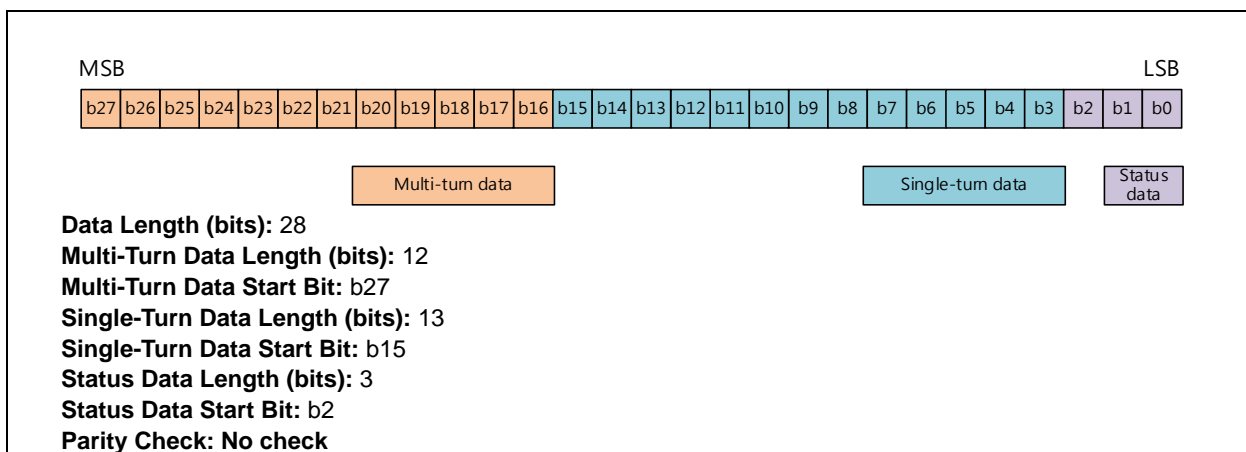

Example 3: Encoder with Parity Check

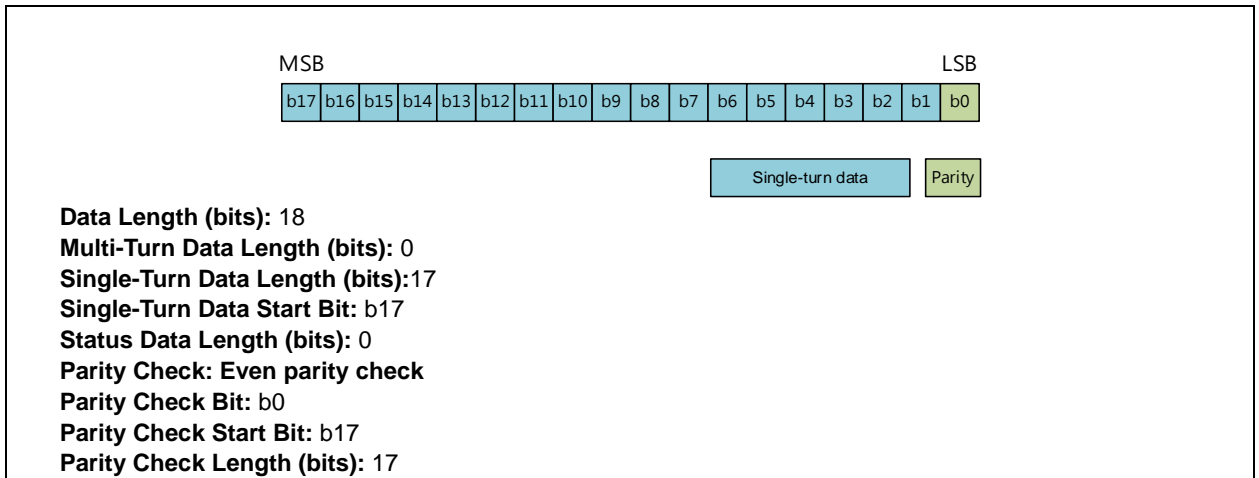

4. Monoflop Time

The Monoflop Time parameter determines the interval time between two SSI data frames. The correct position data can be received as long as the setting value is greater than that specified for the connected encoder. The range is set as follows.

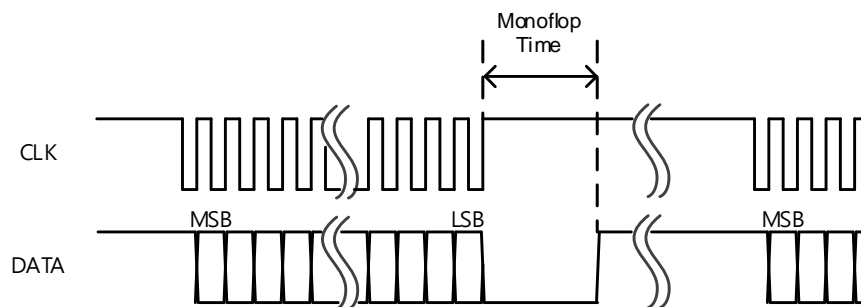

Parameter	Setting	Unit	Default
Monoflop time	4 ~ 2500	16us	4

5. Maximum Variation Limit

The parameter is used to prevent sudden errors occurring in reading absolute position values due to noise interference. You can set the limit value for the variation between two consecutive SSI positions.

When the position change exceeds the set limit, the read position value is discarded, the present count value is not refreshed and the error code is displayed in the counter status. When the position change is back within the set range, the counting returns to normal and the error code is cleared.

When the maximum position variation limit is set to 0, the function is disabled and no check on the position change will be done.

Parameter	Setting	Unit	Default
Maximum Variation Limit	0 ~ 2147483647	-	0 (Disabled)

6. Absolute Position

When the **Absolute Position** option is selected as the counter type, the counter value will show the absolute position of the SSI absolute encoder within the range of 0 to $2^{\text{resolution}}$. The data information including single-turn data, multi-turn data status, data and counting direction can be displayed independently based on the set data format. The offset setting of the SSI absolute encoder can be modified as well. Refer to DHCCNT instruction for more.

7. Ring Counter

When **Ring Counter** is chosen as the counter type, AS02HC-A is used as a 32-bit ring counter by making two read absolute position variations added up and the count value is changing cyclically in the range of -2147483648 to 2147483647. The counting value changes cyclically within the range of -2147483648 to 2147483647. The ring counter value can be cleared to zero through phase Z. The DHCCNT instruction can also be used to clear and preset the counter value. Refer to DHCCNT instruction for details.

8. Zero Crossing Detection

The **SSI Zero Crossing Detect** function is enabled on the Alarm Setting tab page of the HWCONFIG software. The alarm will appear if the absolute position of the SSI encoder crosses the zero position. The detection function can be used for both the absolute position and ring counters. The timing for the zero crossing is illustrated in the following table.

14

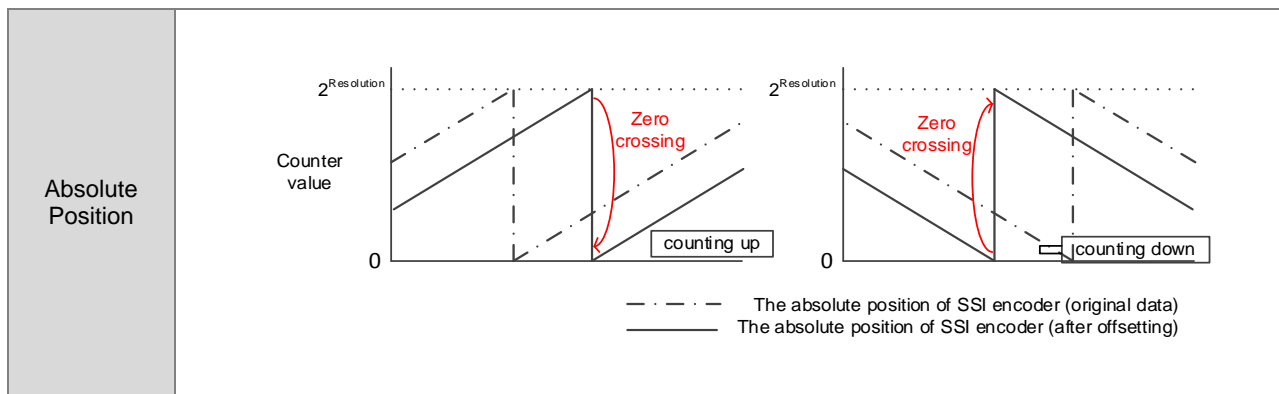

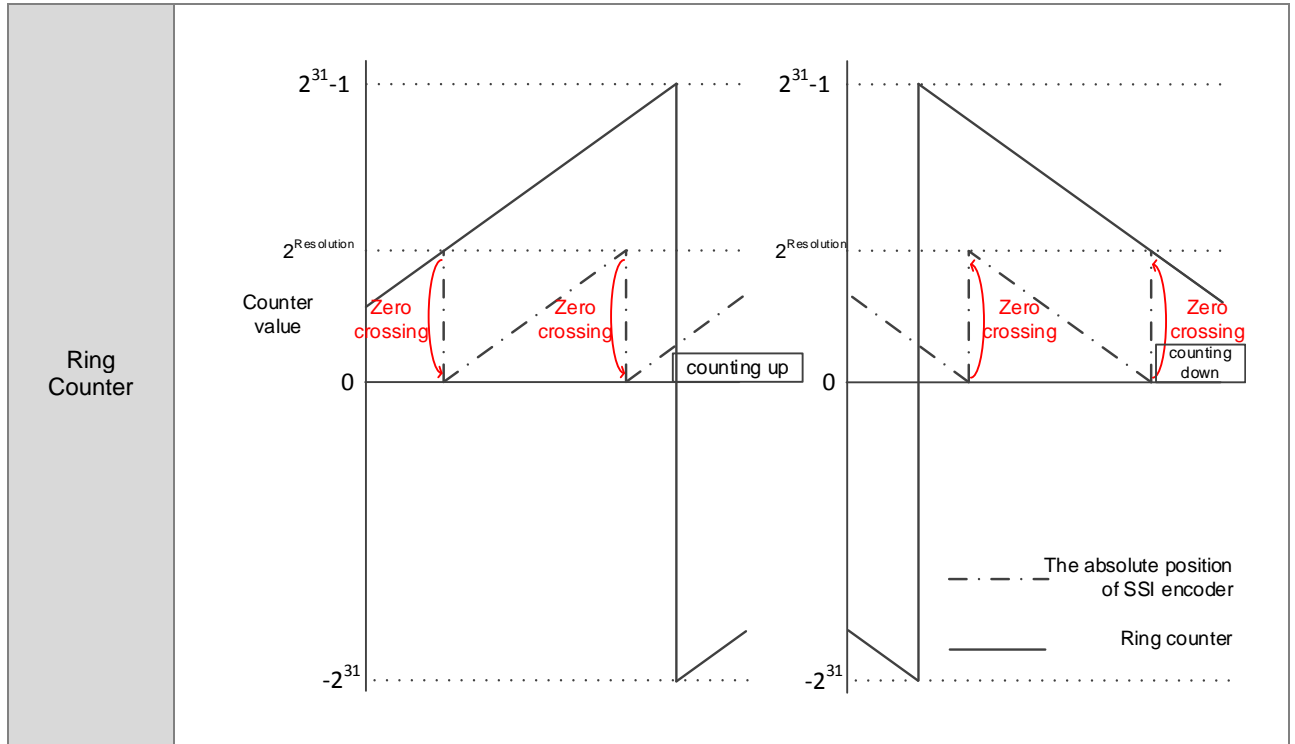

9. Ring Counter Overflow / Underflow Detection

The **Ring Counter Overflow/Underflow Detection** function is enabled on the Alarm Setting tab page of the HWCONFIG software. The alarm will appear as the counter value overflow/underflow occurs.

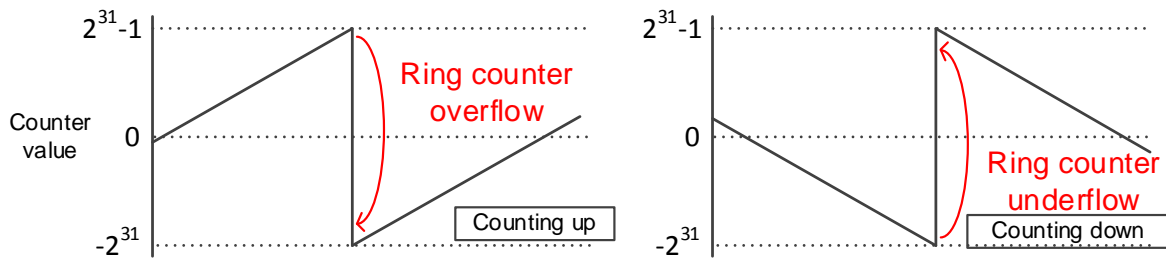

10. SSI Encoder Rotation Rate Restriction

For the SSI input counting, the rotation rate restriction is influenced by the SSI encoder resolution and monoflop time. Use the corresponding formula in the following table to calculate the rotation speed of the SSI encoder.

Encoder type	Rotation rate (RPM)
Single-turn encoder	$\pm \frac{60}{2 \times t_p \times 10^{-6}}$ (tp: monoflop time, unit: us)
Multi-turn encoder	$\pm \frac{60 \times 2^{MT \text{ data length}}}{2 \times t_p \times 10^{-6}}$ (tp: monoflop time, unit: us)

See the reference values for the formula above in the following table.

Monoflop time (us)	Max. rotation rate of single-turn encoders (RPM)	Max. rotation rate of multi-turn encoders (RPM)
64	468750	$468750 \times 2^{\text{MT data length}}$
4000	7500	$7500 \times 2^{\text{MT data length}}$
8000	3750	$3750 \times 2^{\text{MT data length}}$
12000	2500	$2500 \times 2^{\text{MT data length}}$
16000	1875	$1875 \times 2^{\text{MT data length}}$
20000	1500	$1500 \times 2^{\text{MT data length}}$
24000	1250	$1250 \times 2^{\text{MT data length}}$
28000	1071	$1071 \times 2^{\text{MT data length}}$
32000	938	$938 \times 2^{\text{MT data length}}$
36000	833	$833 \times 2^{\text{MT data length}}$
40000	750	$750 \times 2^{\text{MT data length}}$

14.3.4 Z-Phase Function Setting

AS02HC-A's two channels which are with one input point CH1 Z and CH2 Z respectively should be configured in function by HWCONFIG before they are used to achieve the functions of counter reset, gate control, counter value capture and digital filtering.

Item name	Setting	Unit	Default
Phase-Z Function Setting	Counter Reset, Counter Reset +Yno, Gate Control and Capture	-	Counter Reset
Phase-Z Function	Description	Remark	
Counter Reset (Default)	The counter is cleared (the counter value is reset to 0 and the counter status is cleared.)	The counter value can not be cleared if the SSI input and the absolute-position counter type are selected.	
Counter Reset +Yno	Same to Counter Reset above. Also clears the output points that are set by the DHCCMP comparison instruction or table comparison instruction DHCCMPT.	The DHCCMP or DHCCMPT instruction is used.	
Capture	The counter value capture is triggered through the rising edge and falling edge of phase Z.	The DHCCAP instruction is used.	
Gate control	When phase Z is at low level, the counter's counting pauses. When phase Z is at high level, the counter's counting continues.	Applicable to the pulse input only.	

Item name	Setting	Unit	Default
Filter time	0 ~ 200	100 us	0 (Disabled)

14.3.5 List of Dedicated API Instructions

The operation of AS02HC-A is realized via dedicated API instructions in HWCONFIG after the counter configuration setting is done. The dedicated API instructions for AS02HC-A include DHCCNT, DHCCAP, HCDO, DHCCMP, DHCCMPT and DHCMEAS. For details on these instructions and application examples, refer to **AS Series Programming Manual**.

Instruction	Symbol	Function
DHCCNT (Counter control)	<div style="border: 1px solid black; padding: 5px;"> DHCCNT En Module CurCnt ChNo ST Update MT Action AStat Value RefCnt Dir CntStat Error ErrCode </div>	Enable/ disable the counter Change the count value Clear the counter Preset the counter Show current counter value Show the counting direction Show the counter state Correct SSI offset Show SSI data
DHCCAP (Count vlaue capture)	<div style="border: 1px solid black; padding: 5px;"> DHCCAP En Module Capt1 ChNo Cmpl1 TrgSel Capt2 Cmpl2 Error ErrCode </div>	Set a capture method Show captured count values
HCDO (Output point control)	<div style="border: 1px solid black; padding: 5px;"> HCDO En Module Dostate Update Error Dodata ErrCode </div>	Control output points Show output-point state
DHCCMP (Comparison output)	<div style="border: 1px solid black; padding: 5px;"> DHCCMP En Module Match1 ChNo Match2 Update Error Comp1 ErrCode Action1 Yno1 Comp2 Action2 Yno2 </div>	Enable/disable comparison output function Set two point comparison values Set comparison-matched actions Show comparison-matched status

Instruction	Symbol	Function
DHCCMPT (Table comparison output)	<div style="border: 1px solid black; padding: 5px;"> DHCCMPT — En — Module CurNo — ChNo Error — Update ErrCode — CmpLen — CompS — ActionS — YnoS — Inos </div>	Enable/disable table comparison output function Set comparison values for up to ten points Set comparison-matched action Show comparison-matched status
DHCMEAS (Rotation rate measurement)	<div style="border: 1px solid black; padding: 5px;"> DHCMEAS — En — Module Freq — ChNo RPM — Update Error — Cnt/Rev ErrCode — Smpl — Avg </div>	Enable/disable measurement function Set average times Show measured frequency Show measured rotations per minute

14

14.3.6 The impact of AS CPU Status on AS02HC-A

The following table lists the module execution states corresponding to AS CPU operation states of poweroff, and Run -> Stop. After the AS CPU state switches from Stop to Run, the operation state of AS02HC-A module is controlled by the PLC program.

Item	Poweroff, CPU Run -> Stop
Y0.0~Y0.3	Reset to OFF
Phase Z	Disabled
Counter	The counting stops and counter state is cleared.
DHCCNT	The instruction is disabled.
HCDO	The instruction is disabled.
DHCCAP	The instruction is disabled.
DHCCMP	The instruction is disabled; MATCH1 and MATCH2 are cleared.
DHCCMPT	The instruction is disabled and CurNo is cleared.
DHCMEAS	The instruction is disabled.

14.4 Hardware Configuration via HWCONFIG in ISPSOft

14.4.1 Initial Setting

1. Start ISPSOft and then double-click **HWCONFIG**.

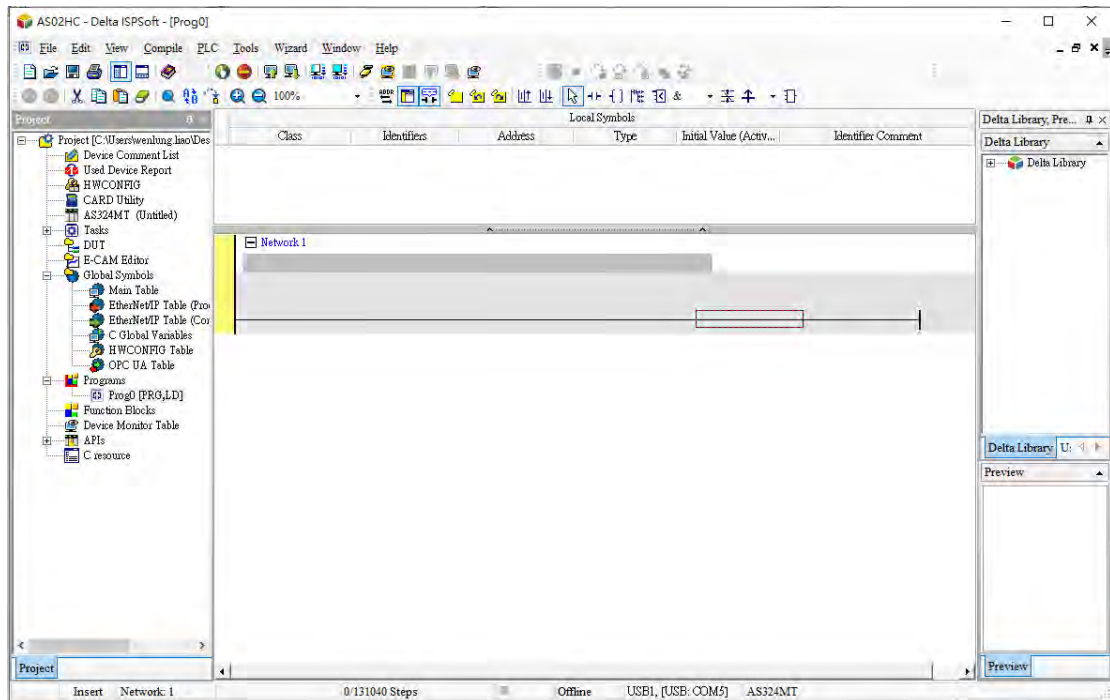

2. Click the **Scan** button.

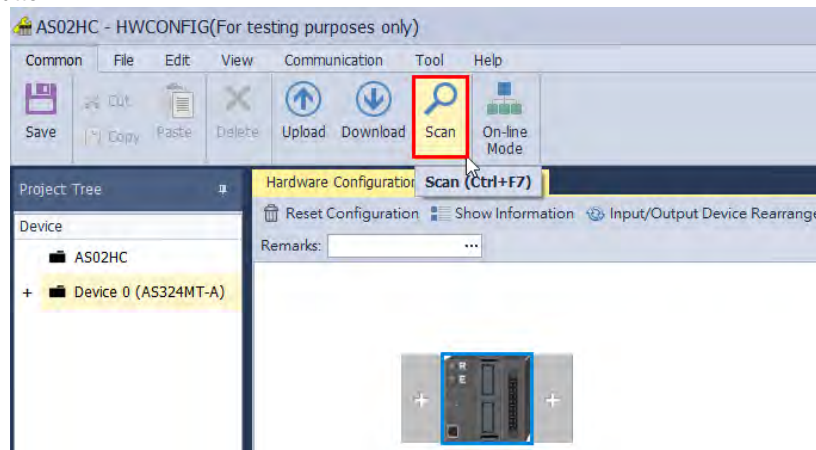

3. After the scanning is completed, AS02HC-A will appear in the following window.

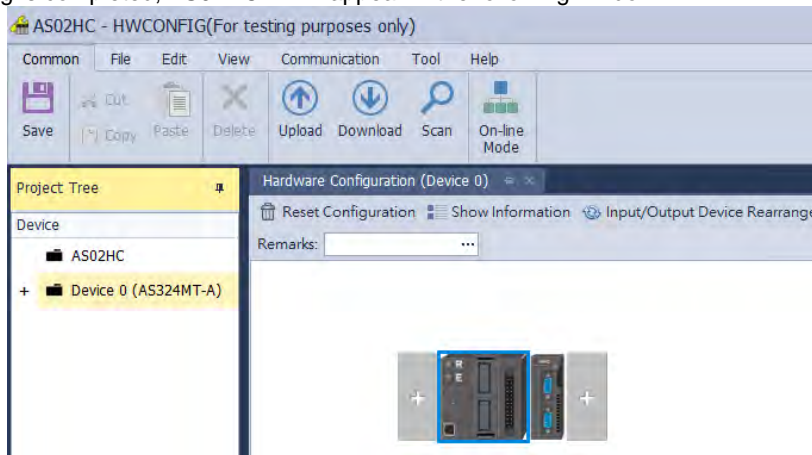

4. Select AS02HC-A and set module parameters.

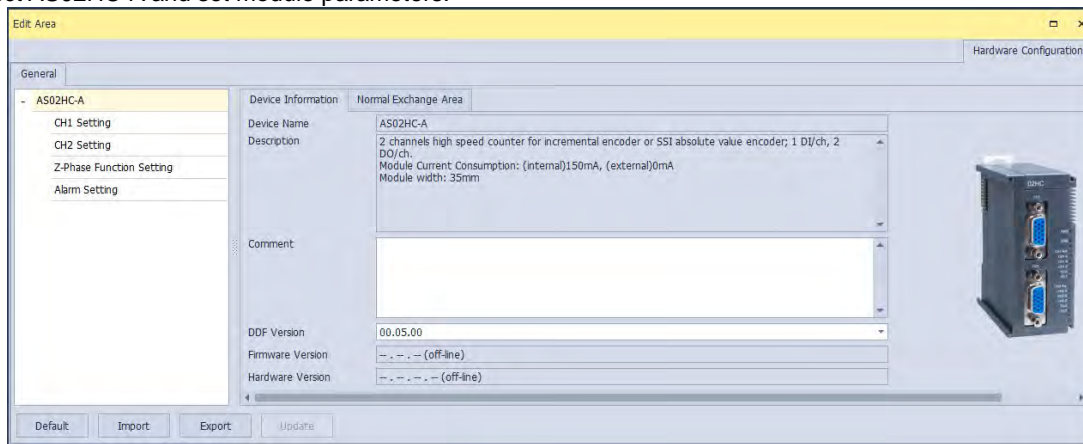

14

5. Close the setting page to finish the setting.

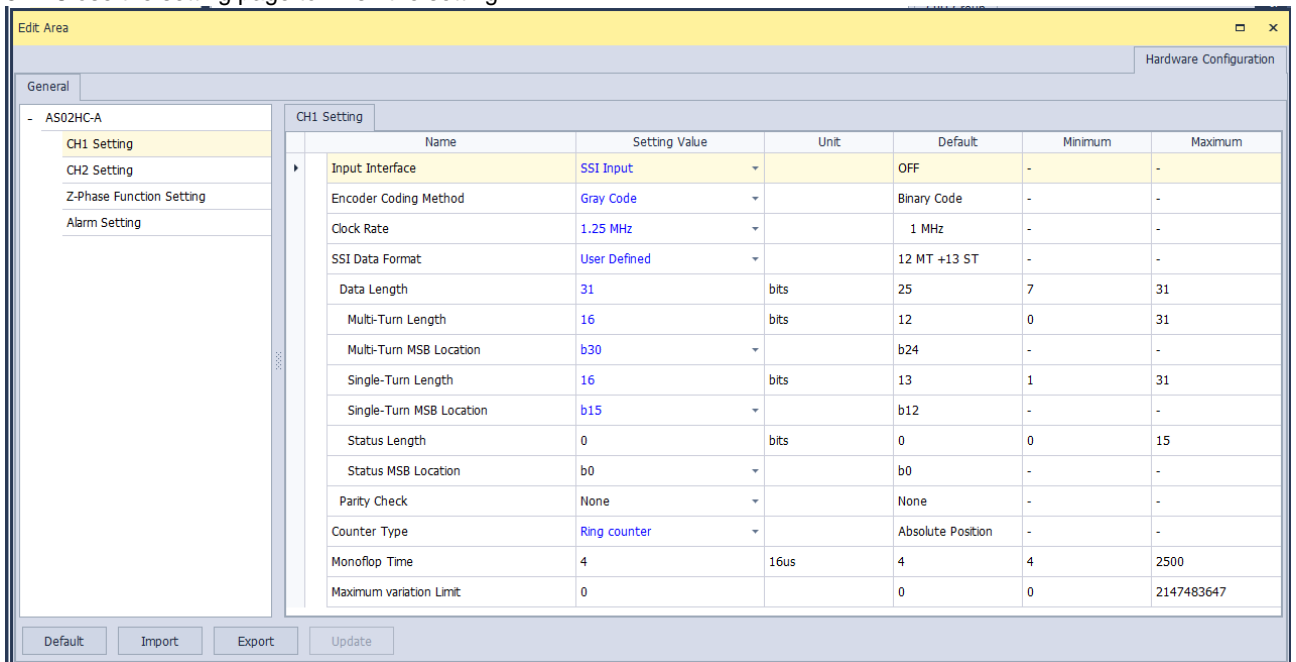
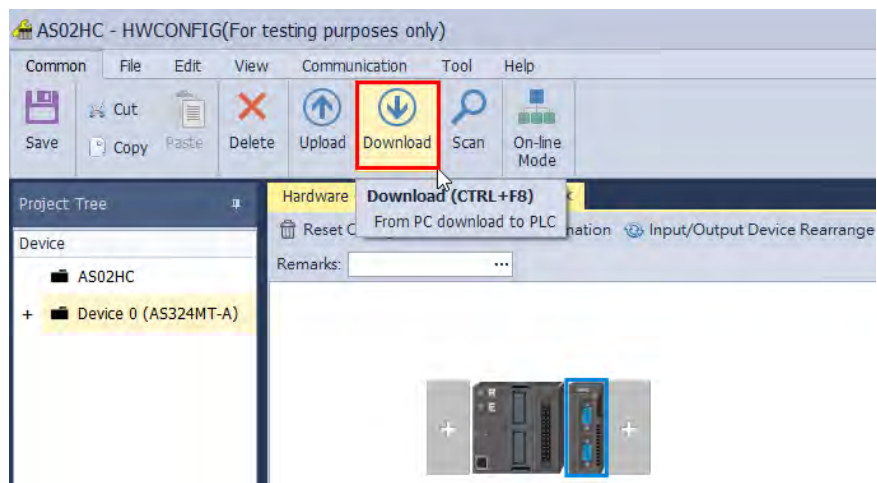
6. Click **Download** to download the configuration data. (The download can not be performed if the CPU is in RUN state)

14.4.2 Checking the Module Version

1. Click **Common** menu > **On-line Mode**.

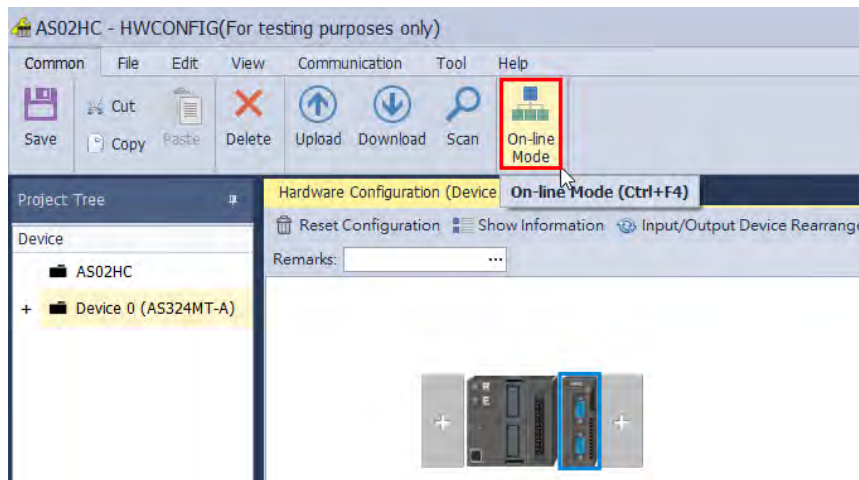

2. Double-click **AS02HC** module to check the firmware version and hardware version.

14

Online

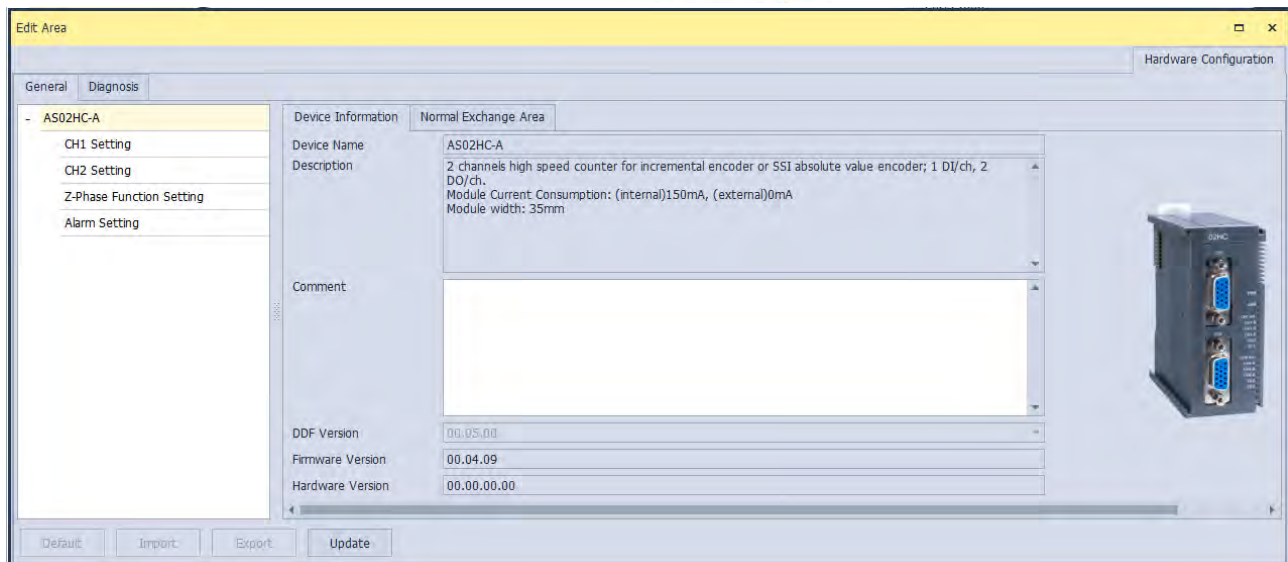

14.4.3 Online Mode

1. Click **On-line Mode** to enter the online mode.

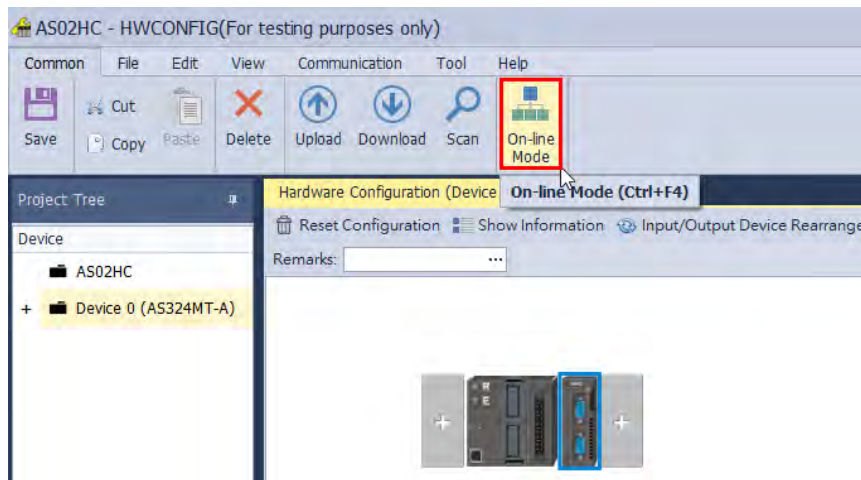

2. Right-click **AS02HC** module and select **Hardware Configuration** or **Module State** from the context menu. Then the error code information can be seen in the module state window and module error log can be seen in the diagnosis area.

Online

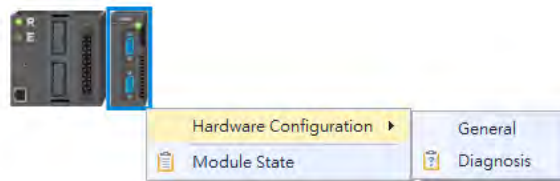

14.4.4 Import and Export a Parameter File

1. Click **Export** in the dialog box to save the current parameters as a dep file (.dep).

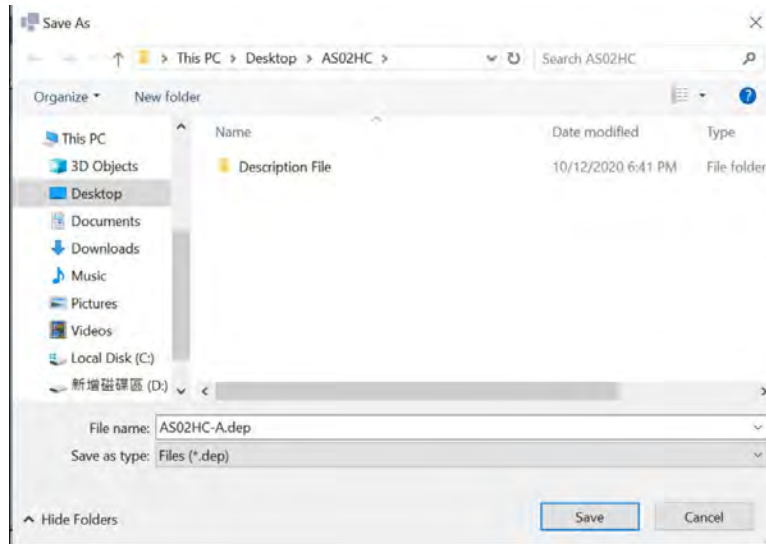
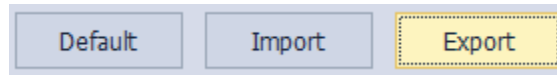

14

2. Click **Import** in the dialog box and select a dep file to save parameters.

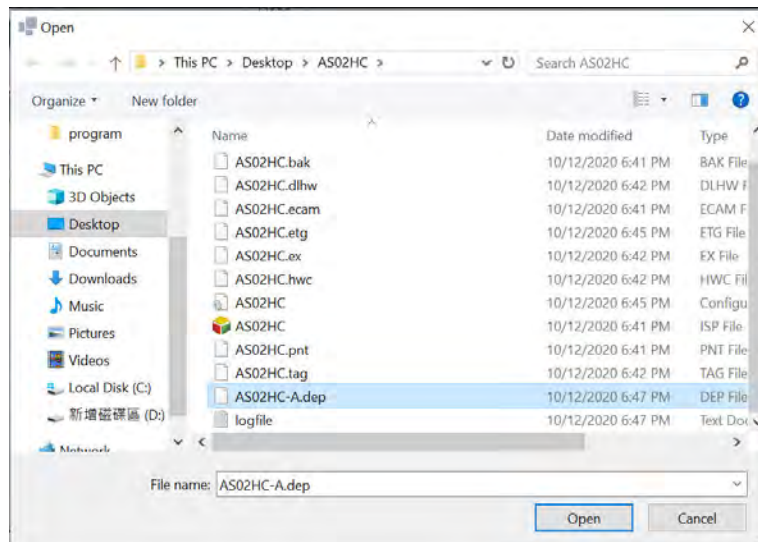
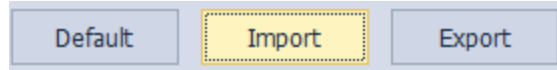

14.4.5 Parameters

1. Select one input interface in CH1 Setting / CH2 Setting.

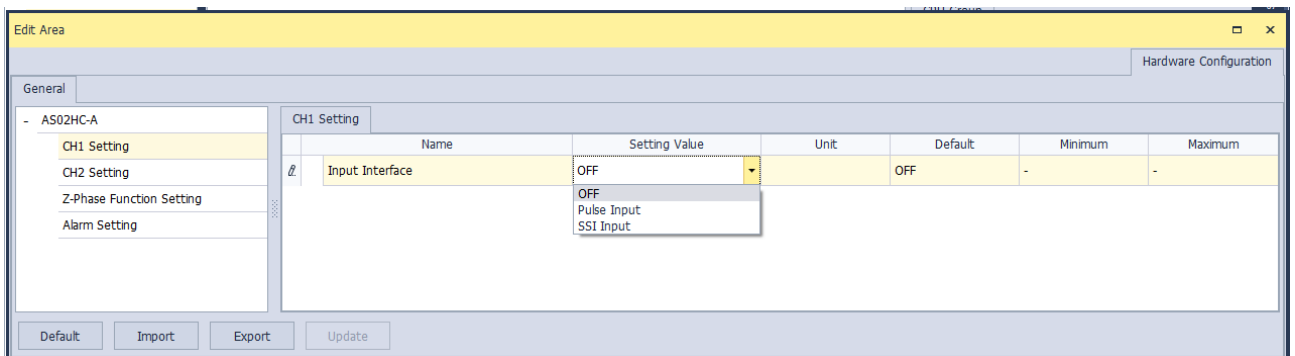

2. Pulse Input in CH1 Setting / CH2 Setting.

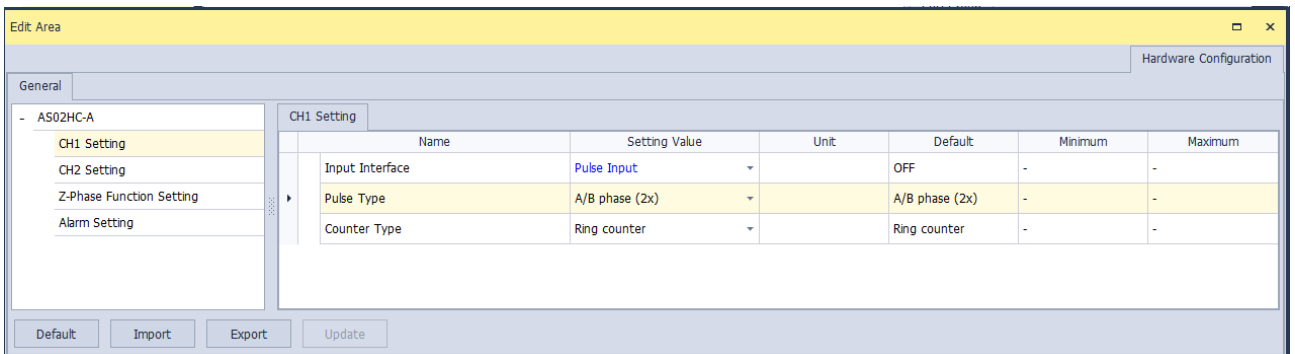

3. SSI Input in CH1 Setting / CH2 Setting

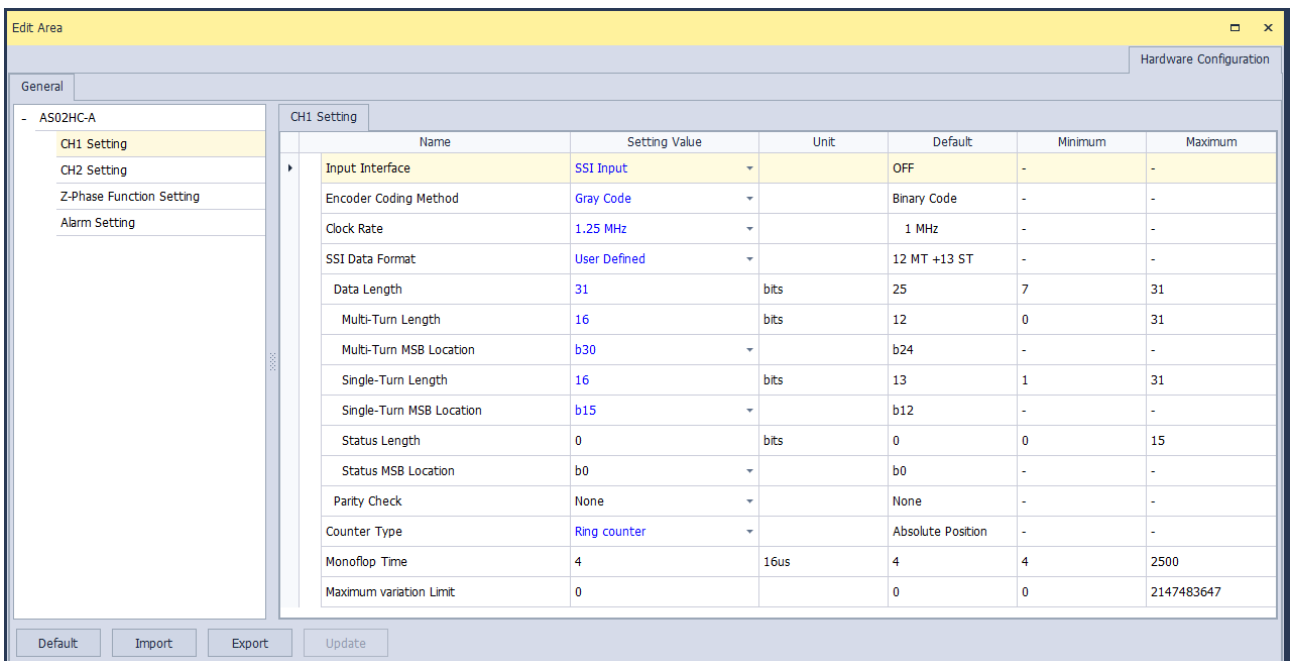

4. Z-Phase Function Setting

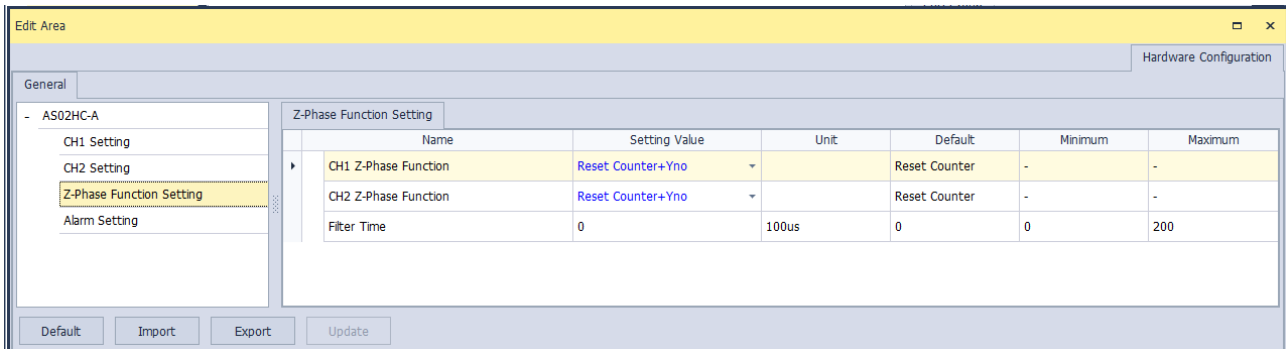

5. Alarm Setting

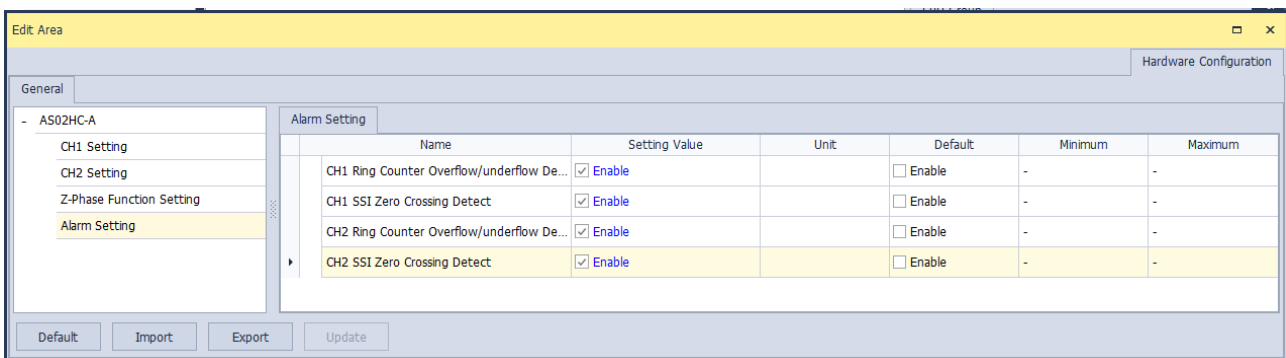

14

14.4.6 Normal Exchange Area

The data exchange area between the CPU and a module is in the Device Setting dialog box. The normal exchange areas for modules are different from one another. Special D registers are corresponded to automatically based on the configuration data for the convenience of directly reading the values. The error codes of AS02HC-A are configured in the Normal Exchange Area. The error codes of the module can be known by monitoring D registers.

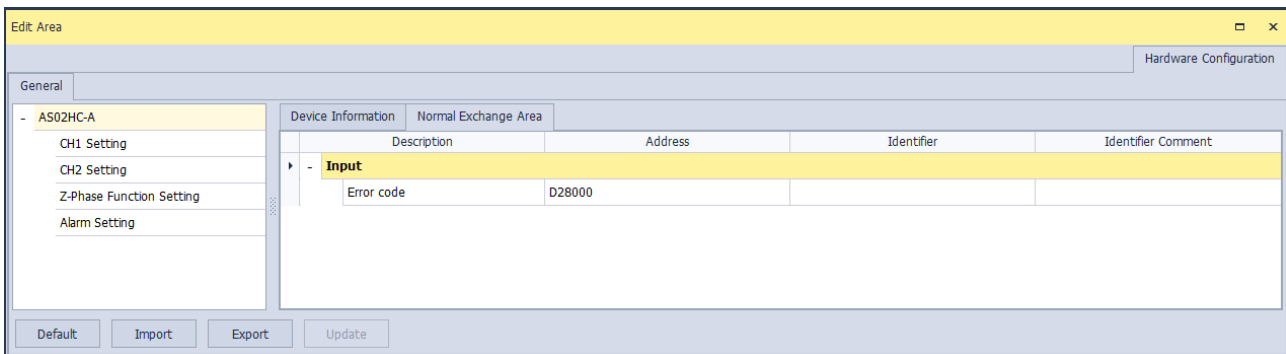

14.5 Troubleshooting

14.5.1 Error Codes

Error code	Description	ERR LED	Counter action	Remark
16#1605	Counted result in the latched area is not retainable (major error)	ON	The counter module stops operating and counting	The error alarm makes the CPU stop the system. (The module need be set to keep counting or stop for when an error occurs in the module:)
16#1606	Module settings in the latched area is not retainable. (major error)			
16#1607	Module setting error (major error)			
16#1800	Counter overflow / underflow on CH1	Blinking	Linear counter: Counting stops.	Linear counter: Counter value overflow inside the hardware Ring counter: After the Ring Counter Overflow/Underflow Detect function is enabled in the Alarm Setting of HWCONFIG, the alarm will appear when the overflow or underflow occurs.
16#1801	Counter overflow / underflow on CH2		Ring counter: Counting continues.	
16#1802	Linear count exceeding the set upper/lower limit on CH1	Blinking	The counting value is fixed at the set max. counter value or the set min. counter value.	The counting inside the hardware persists. When the internal counter value is back within the valid range, the counter returns to normal and the counting value is refreshed.
16#1803	Linear count exceeding the set upper/lower limit on CH2			
16#1804	The variation in relation to an SSI encoder position exceeding the limit on CH1	Blinking	The counting value is fixed at the most recent correct count value.	The variation between two consecutive SSI positions exceeds the setting value.
16#1805	The variation in relation to an SSI encoder position exceeding the limit on CH2			
16#1806	Abnormal SSI communication on CH1	Blinking	The counting value is fixed at the most recent correct count value.	Encoder disconnection/ wiring error/no power supply to the encoder/ data format error/parity check setting error (Error log will not appear unless five consecutive abnormal situations occur.)
16#1807	Abnormal SSI communication on CH2			
16#1808	SSI absolute position cross zero point on CH1	Blinking	Counting continues.	After the SSI Zero Crossing Detect function is enabled on the Alarm Setting tab page of the HWCONFIG software, the alarm will appear as the absolute position of the SSI encoder crosses the zero position.
16#1809	SSI absolute position cross zero point on CH2			

14.5.2 Troubleshooting Procedure

Description	Solution
Counted result in the latched area is not retainable (major error)	Counted data is lost. Switch the module power OFF and ON again. The error code is cleared by the system. Contact the factory if the problem persists.
Module settings in the latched area is not retainable. (major error)	Module setting data is lost. Switch the module power OFF and ON again. Download the HWCONFIG settings again to clear the error code. Contact the factory if the problem persists.
Module setting error (major error)	Check if the setting in HWCONFIG is consistent with the actual placement. Contact the factory if the problem persists.
Counter overflow / underflow on CH1	Check the counter result. If the alarm is not required, disable the alarm output function in HWCONFIG. Use any of the followings to clear the error code: clear, reset, preset the counter, restart the module, or execute DHCCNT instruction again.
Counter overflow / underflow on CH2	
Linear count exceeding the set upper/lower limit on CH1	Check the signal received by channel 1 and 2. Hardware counter is still counting; when the number is back within the range of the maximum to the minimum, the error code will be cleared.
Linear count exceeding the set upper/lower limit on CH2	
The variation in relation to a SSI encoder position exceeding the limit on CH1	Check if there is any interruption and check the device specification to see if the offset setting is matching with the actual placement.
The variation in relation to a SSI encoder position exceeding the limit on CH2	
Abnormal SSI communication on CH1	Check the execution of DHCCNT instruction. If it is parity check, check if there is any interruption and check if the data format is correct. Check if the device wiring is secure, and if the encoder power supply is normal.
Abnormal SSI communication on CH2	
SSI absolute position cross zero point on CH1	Check the SSI absolute encoder specification and modify the setting accordingly. If the alarm is not required, disable the alarm output function in HWCONFIG. Use any of the followings to clear the error code: clear, reset, preset the counter, restart the module, or execute DHCCNT instruction again.
SSI absolute position cross zero point on CH2	

Chapter 15 High-Speed Analog Input

Module AS02ADH

Table of Contents

15.1	Overview	15-2
15.1.1	Characteristics	15-2
15.2	Specifications and Functions	15-3
15.2.1	Specifications	15-3
15.2.2	Profile	15-6
15.2.3	Arrangement of Terminals	15-7
15.2.4	AS02ADH Control Register.....	15-8
15.2.5	Functions.....	15-11
15.2.6	Wiring	15-23
15.2.6.1	Digital Input Wiring	15-23
15.2.6.2	Analog Input Wiring.....	15-24
15.2.7	LED Indicators	15-27
15.3	HWCONFIG in ISPSOft	15-28
15.3.1	Initial Setting	15-28
15.3.2	Checking the Version of a Module	15-31
15.3.3	Online Mode	15-32
15.3.4	Importing/Exporting a Parameter File.....	15-34
15.3.5	Parameters	15-35
15.4	Troubleshooting	15-39
15.4.1	Error Codes	15-39
15.4.2	Troubleshooting Procedure.....	15-40

15.1 Overview

The AS02ADH module is a high-speed analog-to-digital module with two built-in channels. The conversion rate of analog to digital signals can be as fast as 20 μ s per channel. Its two built-in channels are capable of sampling simultaneously. The channels are designed as isolated to reduce interferences and ensure the accuracy of the measured results. This chapter mainly introduces the specifications, functions and operation of the module. For software operation, ISPSOft, DIADesigner or DIADesigner-AX is what you need. If you are using AS Series PLC CPU, refer to ISPSOft User Manual or DIADesigner Manual for more information. The new software DIADesigner-AX only supports AX Series PLC CPU and AS Series modules now, refer to AX-3 User Manual for more information on software operation.

15.1.1 Characteristics

(1) **High-speed conversion**

The conversion rate of analog to digital signals can be as fast as 20 μ s per sampling cycle for two channels simultaneously.

(2) **High accuracy**

Conversion accuracy: The error range for both voltage input and current input is $\pm 0.1\%$ at ambient temperature of 25° C.

(3) **Fully insulation (insulation between channels included)**

Apart from the design of separating the digital and analog signals, the insulation between channels is included to reduce interferences between channels and ensure stability.

(4) **External input points triggering**

By triggering the external input points to achieve recording the log in real time.

(5) **Record function**

At the speed of 20 μ s, high-speed recording works with external input points triggering to activate recording the log continuously or just the execution points in real time.

(6) **Use the tool software for easy settings**

The HWCONFIG utility software is built into ISPSOft. You can set modes and parameters directly in HWCONFIG of ISPSOft or Hardware Configuration of DIADesigner without spending time writing programs to set registers to manage functions.

(7) **Miscellaneous API instructions**

The functions including recording log and peak value can be achieved through dedicated API instructions.

15.2 Specifications and Functions

15.2.1 Specifications

- Functional specifications

Module Name	AS02ADH-A
Number of input channels	2
Analog input	Voltage: -10 V to 10 V, 0 V to 10 V, 5 V to -5 V, 0 V to 5 V, 1 V to 5 V Current: -20 mA to 20 mA, 0 mA to 20 mA, 4 mA to 20 mA
Digital output	16-bit integer 32-bit floating point
Error rate	Room temperature: $\pm 0.1\%$; full temperature range: $\pm 0.2\%$
Hardware resolution	16 bits
Input resistance value	Voltage: $\geq 2 \text{ M}\Omega$ Current: 250Ω
Absolute input range ^{*1}	Voltage: $\pm 15 \text{ V}$ Current: $\pm 32 \text{ mA}$
Channel sampling Cycle ^{*2}	20 μs , 40 μs and 80 μs
Bandwidth of analog input signal	20 kHz
Average function	Time average, moving average: 1 to 1000 times
Digital filtering	Low-pass filter, band-pass filter
Logging function ^{*3}	Digital output value (2000 per channel), peak value
Digital calibration	Maximum / minimum digital output value clipping, gain, offset
Abnormal input signal detection	Limit-exceeding detection, disconnection detection ^{#4}
External input triggering	2 points (1 point / channel), rising-edge or falling-edge triggered
Maximum frequency of external input point triggering	10 kHz

*1: If an input signal exceeds the absolute range, it might damage the channel.

*2: Two channels are in A/D conversion simultaneously.

*3: Logging function should be used with API instructions.

*4: Disconnection detection can only be used in the modes of 4 mA to 20 mA and 1V to 5 V.

● Conversion characteristics - Voltage

Analog-to-Digital Conversion	Voltage Input				
Rated Input Range	-10 V to 10 V	0 V to 10 V	±5 V	0 V to 5 V	1 V to 5 V
Rated Conversion Range	K-32000 to K32000	K0 to K32000	K-32000 to K32000	K0 to K32000	K0 to K32000
Hardware Input Limit*1	-10.12V to 10.12V	-0.12V to 10.12V	-5.06V to 5.06V	-0.06V to 5.06V	0.95V to 5.05V
Conversion Limit*2	K-32384 to K32384	K-384 to K32384	K-32384 to K32384	K-384 to K32384	K-384 to K32384

*1: If the input signal exceeds the hardware input limit, the module only shows the maximum value. If the input signal is below the lower limit, it only shows the minimum value.

*2: If the input signal exceeds the hardware input limit, it also exceeds the digital conversion limit and a conversion limit error appears. For example in the voltage input mode (-10 V to +10 V), when the input signal is 10.15 V, exceeding the hardware upper limit, it also exceeds the conversion upper limit. The module uses the upper limit value (32384) as the input signal and a conversion limit error appears.

● Conversion characteristics - Current

Analog-to-Digital Conversion	Current Input		
Rated Input Range	±20 mA	0 mA to 20 mA	4 mA to 20 mA
Rated Conversion Range	K-32000 to K+2000	K0 to K32000	K0 to K32000
Hardware Input Limit*1	-20.24 mA to 20.24 mA	-0.24 mA to 20.24 mA	3.81 mA to 20.19 mA
Conversion Limit*2	K-32384 to K32384	K-384 to K32384	K-384 to K32384

*1: If the input signal exceeds the hardware input limit, the module only shows the maximum value. If the input signal is below the lower limit, it only shows the minimum value.

*2: If the input signal exceeds the hardware input limit, it also exceeds the digital conversion limit and a conversion limit error appears. For example in the voltage input mode (4 mA to 20 mA), when the input signal is 0 mA, exceeding the hardware upper limit, it also exceeds the conversion upper limit. The module uses the upper limit value (-384) as the input signal and a conversion limit error appears.

- **Electrical specifications**

Module Name	AS02ADH-A
Supply Voltage	24 VDC (20.4 VDC to 28.8 VDC) (-15% to +20%)
Connector Type	Removable terminal block
Isolation	<p>An analog circuit is isolated from a digital circuit. The analog channels are isolated from one another.</p> <p>Isolation between a digital circuit and a ground: 500 VAC</p> <p>Isolation between an analog circuit and a ground: 500 VAC</p> <p>Isolation between an analog circuit and a digital circuit: 500 VAC</p> <p>Isolation between the 24 VDC and a ground: 500 VAC</p>
Rated voltage of external input point	24 VDC
Rated current of external input point	5 mA
Resistance value of external input point	3.9 k Ω
Hardware response time of external input point OFF -> ON	5 μ s
Hardware response time of external input point ON -> OFF	5 μ s
Weight	154g

15.2.2 Profile

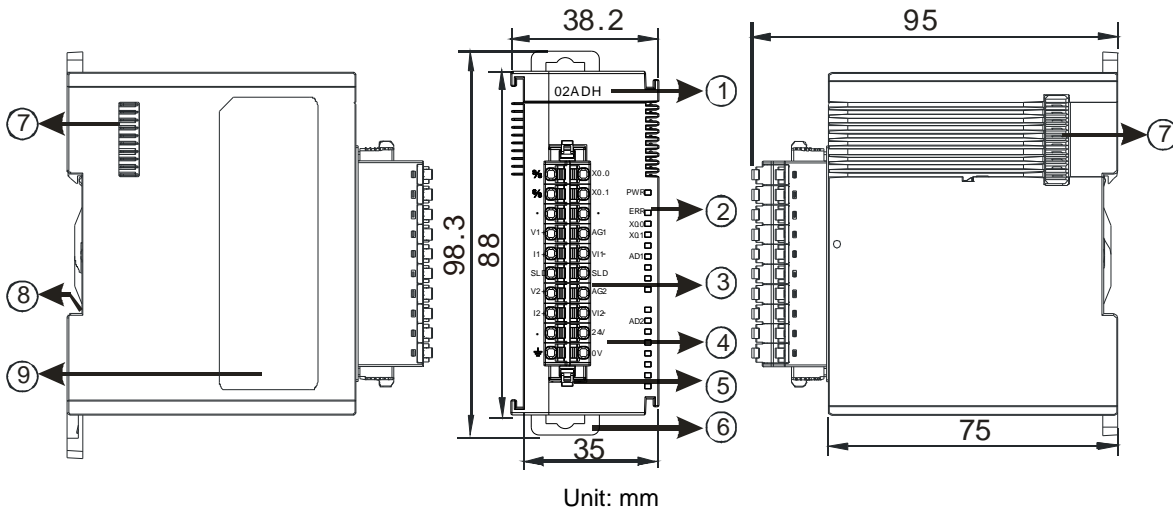

Number	Name	Description
1	Model Name	Model name of the module
2	POWER LED Indicator	Status of the power supply ON: the power is on. OFF: the power is off.
	ERROR LED Indicator	Error status of the module ON: a serious error exists in the module. OFF: the module is operating normally. Blinking: A minor error exists in the module.
	Input Point Status Indicator	Input point status of the module ON: the input point is functioning OFF: the input point is not functioning
	Analog to Digital Conversion Indicator	Analog-to-digital conversion status Blinking: conversion is in process. OFF: conversion has stopped.
3	Removable Terminal Block	Inputs are connected to sensors.
4	Arrangement of the Input/Output Terminals	Arrangement of the terminals
5	Terminal Block Clip	For removing the terminal block
6	DIN Rail Clip	Secures the module onto the DIN rail
7	Module Connecting Set	Connects the modules
8	Ground Clip	
9	Label	Nameplate

15.2.3 Arrangement of Terminals

<p>The diagram shows a terminal block for the AS02ADH module. The terminals are arranged in two columns. The left column contains terminals labeled: X0.0, X0.1, AG1, V1+, I1+, SLD, V2+, I2+, 24V, and 0V. The right column contains terminals labeled: PWR, ERR, X0.0, X0.1, AD1, SLD, AG2, V12-, AD2, and 0V. There are also two terminals marked with a dot (•) in the left column and one marked with a dot (•) in the right column. The module is labeled '02ADH' at the top.</p>	S/S	X0.0
	S/S	X0.1
	•	•
	V1+	AG1
	I1+	V11-
	SLD	SLD
	V2+	AG2
	I2+	V12-
	•	24V
	⊥	0V

15.2.4 AS02ADH Control Register

*If you use HWCONFIG to set values in CRs, once the set value is downloaded, the values can be retained in the module; however if you use TO instruction to write data into CRs, the values CANNOT be retained, after power failure or after transition of the CPU from STOP to RUN.

Note: The attribute of the CR must be W (write) to use TO instruction.

CR#	Name	Description	Atr.	Defaults
0	Format Setup	0: integer format 1: floating point format	R	0
1	Channel 1 mode setup	0: closed 1: -10 V to +10 V 2: 0 V to 10 V 3: -5 V to +5 V	R/W	1
2	Channel 2 mode setup	4: 0 V to 5 V 5: 1 V to 5 V 6: 0 mA to 20 mA 7: 4 mA to 20 mA 8: -20 mA to +20 mA Note: when the format is set as floating point format, you can NOT change the mode through TO instruction.		
3	Channel 1 offset	Range: -32768 to +32767	R/W	0
4	Channel 2 offset			
5	Channel 1 gain	Range: -32768 to +32767	R/W	1000
6	Channel 2 gain			
7	Channel 1 filtering method	0: moving average 1: time average	R/W	0
8	Channel filtering method	2 : 50 Hz low-pass filter 3 : 60 Hz low-pass filter 4 : 1 kHz low-pass filter (for sampling cycle 40 μ s and 80 μ s only) 5 : 3 kHz low-pass filter (for sampling cycle 40 μ s and 80 μ s only) 6 : 5 kHz low-pass filter (for sampling cycle 40 μ s and 80 μ s only) 7 : 7 kHz low-pass filter (for sampling cycle 40 μ s only) 8 : 9 kHz low-pass filter (for sampling cycle 40 μ s only)		

CR#	Name	Description	Atr.	Defaults
		9 : 11 kHz low-pass filter (for sampling cycle 40 μ s only) 10 : 1.5 to 3 kHz band-pass filter (for sampling cycle 40 μ s and 80 μ s only) 11 : 3 to 5.5 kHz band-pass filter (for sampling cycle 40 μ s and 80 μ s only) 12 : 5.5 to 8 kHz band-pass filter (for sampling cycle 40 μ s only) 13 : 8 to 10.5 kHz band-pass filter (for sampling cycle 40 μ s only)		
9	Channel 1 average times	Time average, moving average: 1 to 1000 times	R/W	10
10	Channel 2 average times			
11	Channel sampling cycle	0: 20 μ s 1: 40 μ s 2: 80 μ s	R/W	0
12	Channel 1 maximum digital output value	When the digital output value is out of the range (-32384 to 32384), the digital clipping is used to fix the exceeding value to the maximum digital output value.	R/W	32384
13	Channel 2 maximum digital output value			
14	Channel 1 minimum digital output value	When the digital output value is out of the range (-32384 to 32384), the digital clipping is used to fix the exceeding value to the minimum digital output value.	R/W	-32384
15	Channel 2 minimum digital output value			
16	Trigger method of the external input point X0.0	0: rising-edge trigger 1: falling-edge trigger	R/W	0
17	Trigger method of the external input point X0.1			
18	Digital filtering time of the external input point X0.0	0: OFF 1: 100 μ s 2: 200 μ s 3: 500 μ s	R/W	0
19	Digital filtering time of the external input point X0.1			
20	Channel Alarm Setup	0: enable channel alarm 1: disable channel alarm bit0: channel 1 analog input value exceeding the range detection bit1: channel 2 analog input value exceeding	R/W	3

CR#	Name	Description	Atr.	Defaults
		the range detection 0: warning (minor error) 1: alarm (major error) bit8: error in the external power supply bit9: error in the module hardware bit10: error in calibration		
21	The minimum scale range for channel 1	When the format is set to integer in HWCONFIG, the scale range is invalid. When the format is set to floating-point, the values are shown in HWCONFIG. Here you can set the minimum and maximum scale ranges of corresponding floating-point values for channels. For example, if the scale range for an analog to digital input channel is ± 10.0 V, it indicates the maximum value is +10.0 V and the minimum value is -10.0 V.	R	-10.0
22				
23	The minimum scale range for channel 2	For example, if the scale range for an analog to digital input channel is ± 10.0 V, it indicates the maximum value is +10.0 V and the minimum value is -10.0 V.		-10.0
24				
25	The maximum scale range for channel 1	If the scale range for an analog to digital input channel is 4 mA to 20 mA. It indicates the maximum value is 20 mA and the minimum value is 4 mA.		10.0
26				
27	The maximum scale range for channel 2	Note: You can use PLC instruction DSCLP (API0217) and set SM685 to ON to use floating-point operations when the conversion range needs to edit.		10.0
28				

15.2.5 Functions

Item	Function	Description
1	Digital output format	Integer and floating point formats
2	Calibration	Calibrate a linear curve.
3	Average function	Conversion values are averaged and filtered for each channel.
4	Digital filtering	Low-pass filtering and band-pass filtering: to screen out unwanted frequency
5	Sampling cycle	The conversion rate of analog to digital signals can be set to 20 μ s, 40 μ s or 80 μ s per sampling cycle for two channels simultaneously.
6	External input point trigger for digital filtering	Input point filtering is available to reduce the chance of being triggered by mistake.
7	Digital output value range	When the digital output value is out of the range (-32384 to 32384), the digital clipping is used to fix the exceeding value to the maximum / minimum digital output value.
8	Channel detection and alarm	If an input signal exceeds the input hardware range, the module produces an alarm or a warning. You can disable this function.
9	Logging function	Used with instruction ADLOG and DADLOG (API 1424) to save the analog curves for channels.
10	Peak records for channels	Used with instruction ADPEAK and DADPEAK (API 1425) to save the maximum and minimum value for channels.
11	Disconnection Detection	Disconnection detection only operates when the analog range is 4 mA–20 mA or 1 V–5 V.

1. Digital output format

You can choose integer (16-bits, binary format) or floating-point format for the digital output format. If you set the format to floating-point, you can set the scale range. The analog output mode of a channel has a corresponding digital range. Digital values correspond to analog outputs sent by the module. For example, if the analog range is -10 V to +10 V, the digital range is -10.0 to +10.0, the HSP scale is 10.0, and the LSP scale is -10.0. The digital values -10.0 to +10.0 correspond to the analog values -10 V to +10 V, as the example below shows.

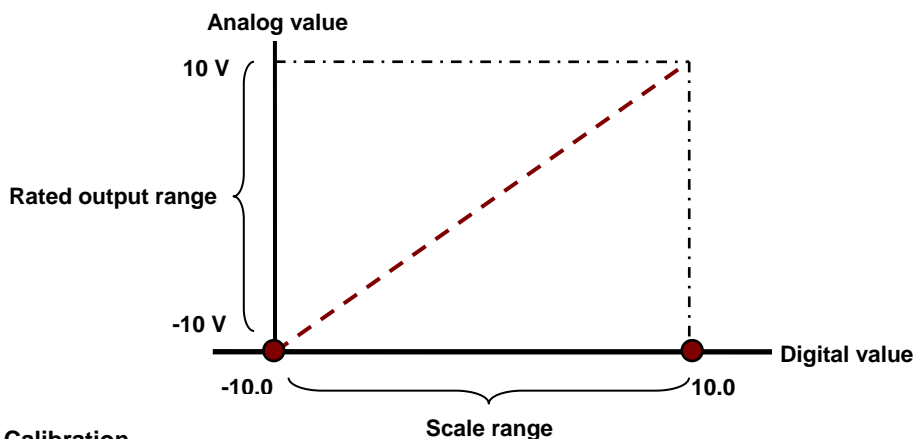

2. Calibration

To make a curve meet specific needs, calibrate the curve by changing the offset and the gain. The calibration range depends on the range of inputs that the hardware can receive. The formula is:

$$Output = \frac{(Input \times Gain)}{1000} + Offset$$

Example:

A channel receives voltage inputs between -10.0 V to +10.0 V. The gain is 1000, and the offset is 0. The corresponding value for the original signal -10.0 V to +10.0 V is -32000 to +32000. If you change the offset to -100, the calibrated value for the original signal -10.0 V to +10.0 V becomes -31900 to +32100.

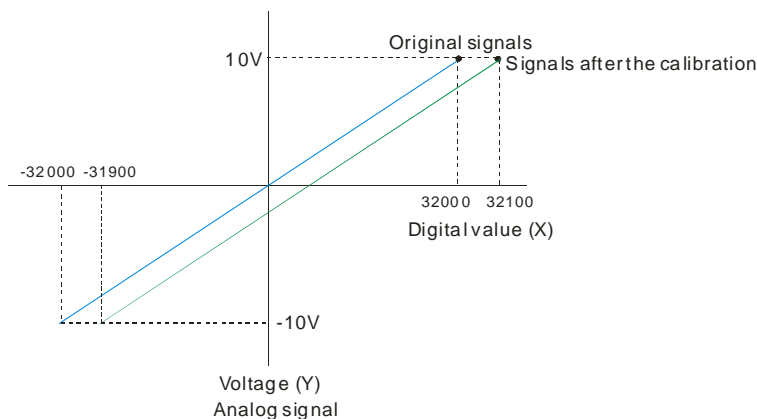

3. Average function

There are two kinds of averages, including moving average and time average; the setting range is 1 to 1000. When the setting value (sampling value) is 1, averaging is not executed. Moving average is to use the latest N number of read values to perform averaging and thus the latest digital output values can be obtained. Thus in moving average, digital value updating cycle = sampling cycle. For time average, it is to accumulate sampling cycle for a time set and then perform averaging on the total value. Thus in time average, digital value updating cycle = sampling cycle x times. For example, when the sampling cycle is 20 μ s and set the time to 1000, the digital value updating cycle is 200 ms (20 μ s x 1000).

Average	Setting range	Digital value updating cycle
Moving average	1~1000	Sampling cycle
Time average		Sampling cycle x times

4. Digital filtering

AS02ADH-A comes with various digital filters. You can use low-pass filter to screen out some specific frequency or use band-pass filter to perform filtering on some specific range of frequency. According to the sampling cycle, you choose an appropriate digital filter; refer the table below.

Filter	Sampling cycle		
	20 μ s	40 μ s	80 μ s
50 Hz low-pass filter	•	•	•
60 Hz low-pass filter	•	•	•
1 kHz low-pass filter	–	•	•
3 kHz low-pass filter	–	•	•
5 kHz low-pass filter	–	•	•
7 kHz low-pass filter	–	•	–
9 kHz low-pass filter	–	•	–
11 kHz low-pass filter	–	•	–
1.5~3 kHz band-pass filter	–	•	•
3~5.5 kHz band-pass filter	–	•	•
5.5~8 kHz band-pass filter	–	•	–
8~10.5 kHz band-pass filter	–	•	–

50 Hz low-pass filter

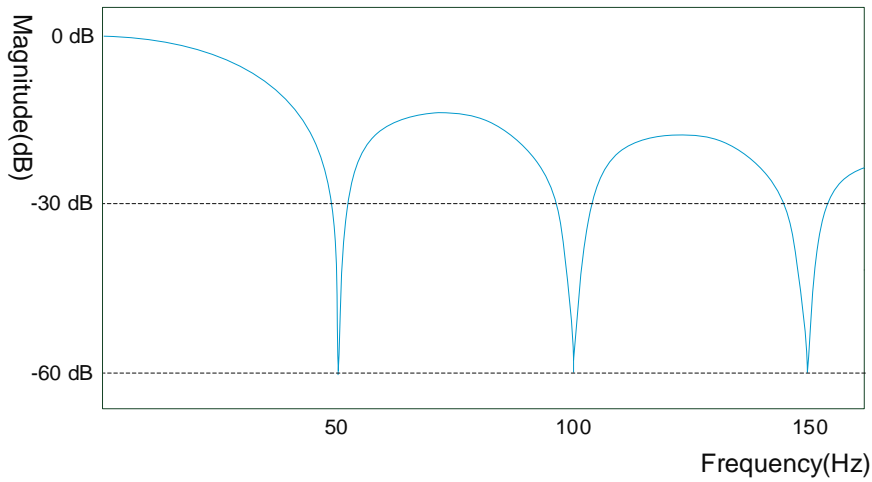

	Attenuation	Cutoff frequency	Realization time
50 Hz low-pass filter	Multiples of 50 Hz: > 50dB	22 Hz	20 ms

60 Hz low-pass filter

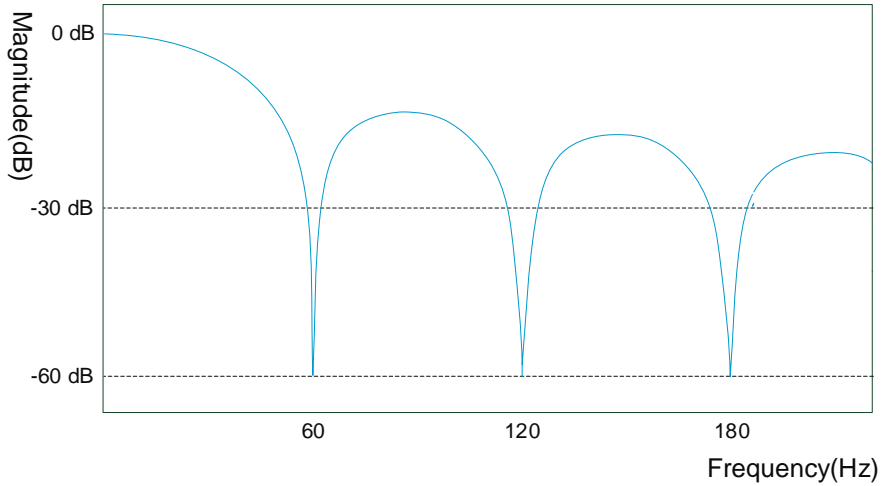

	Attenuation	Cutoff frequency	Realization time
60 Hz low-pass filter	Multiples of 60 Hz: > 50dB	26 Hz	16.7 ms

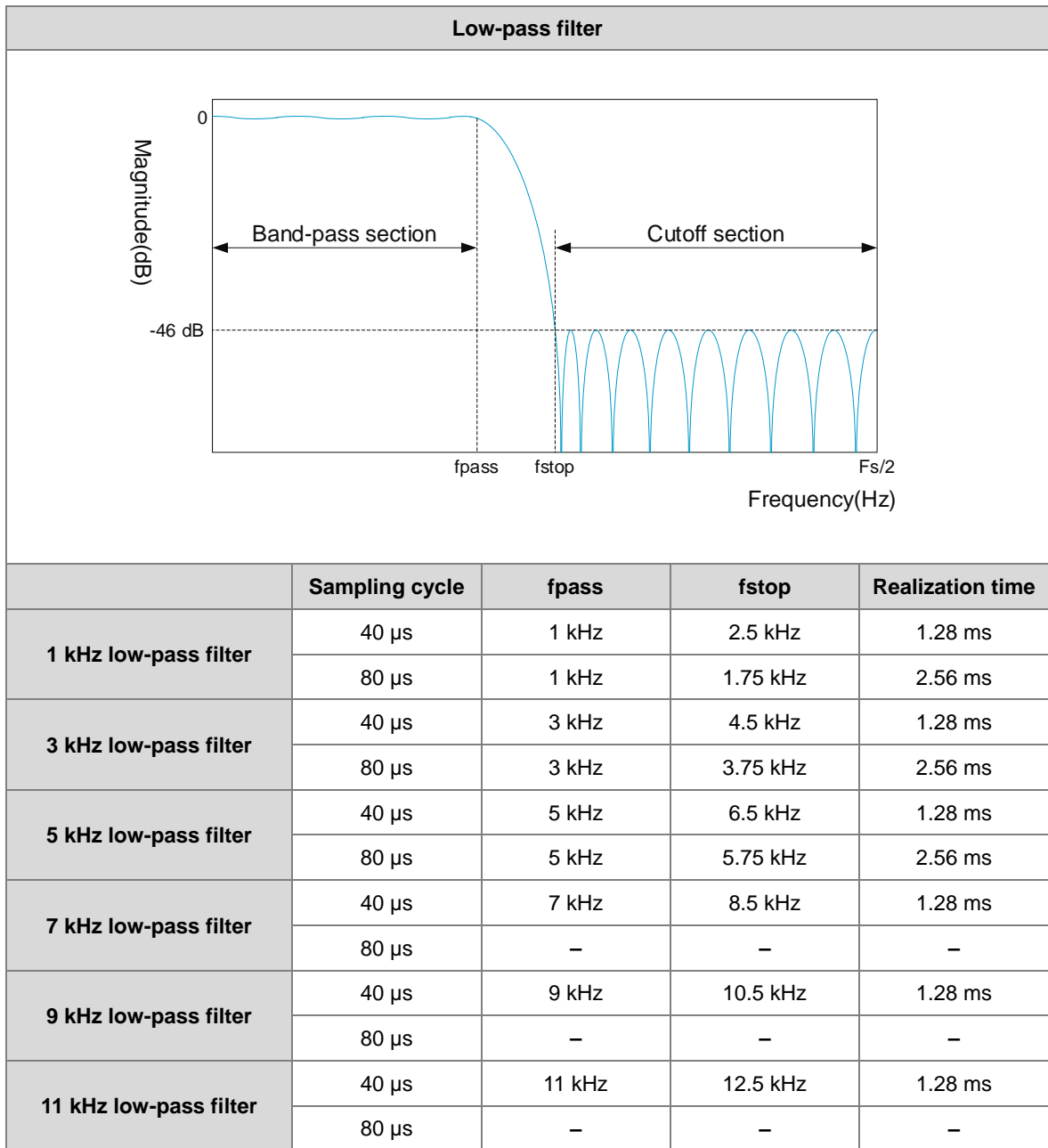

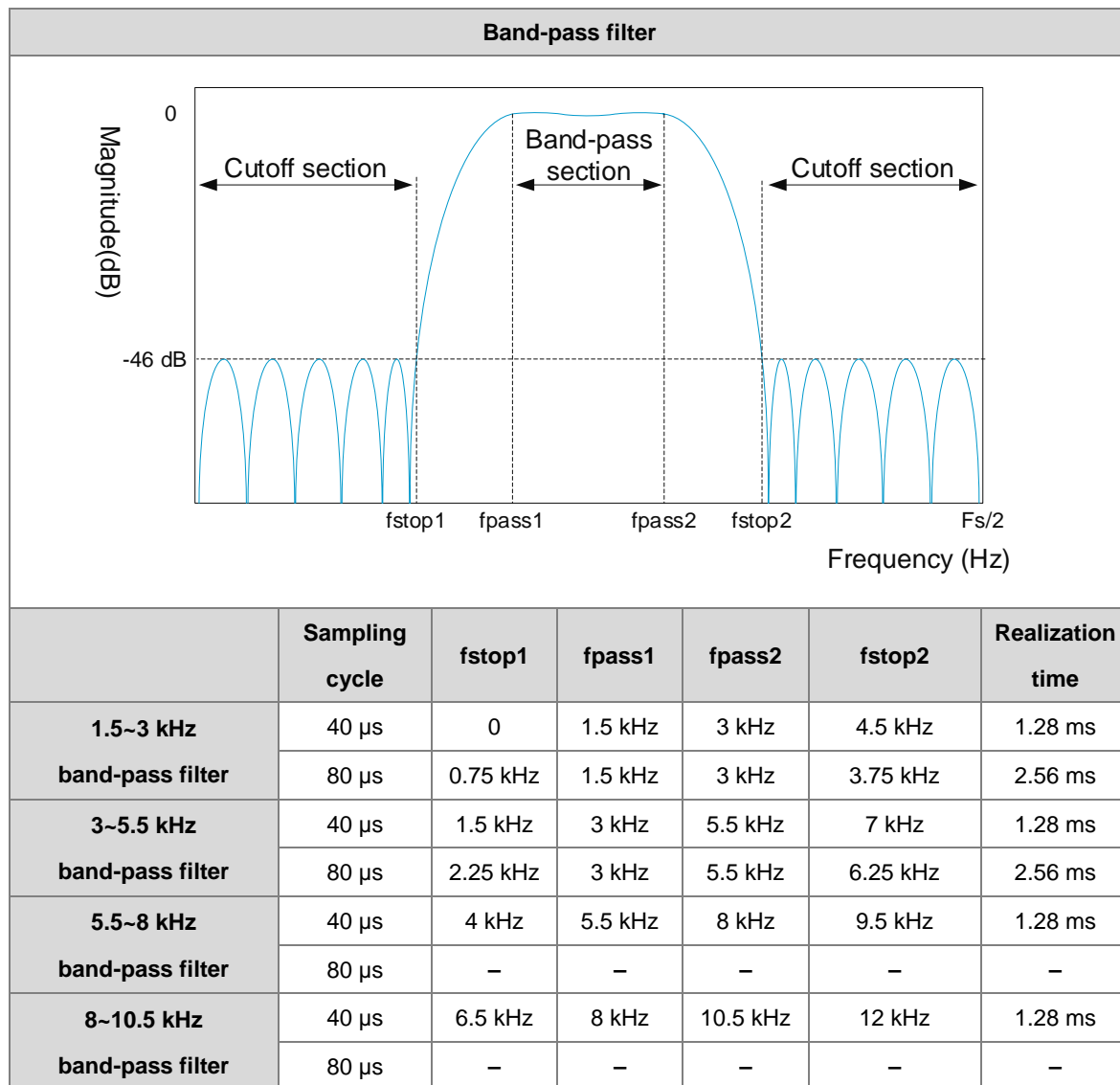

5. Sampling cycle

The conversion rate of analog to digital signals can be set to 20 μ s, 40 μ s or 80 μ s per sampling cycle for two channels simultaneously. See the framework below.

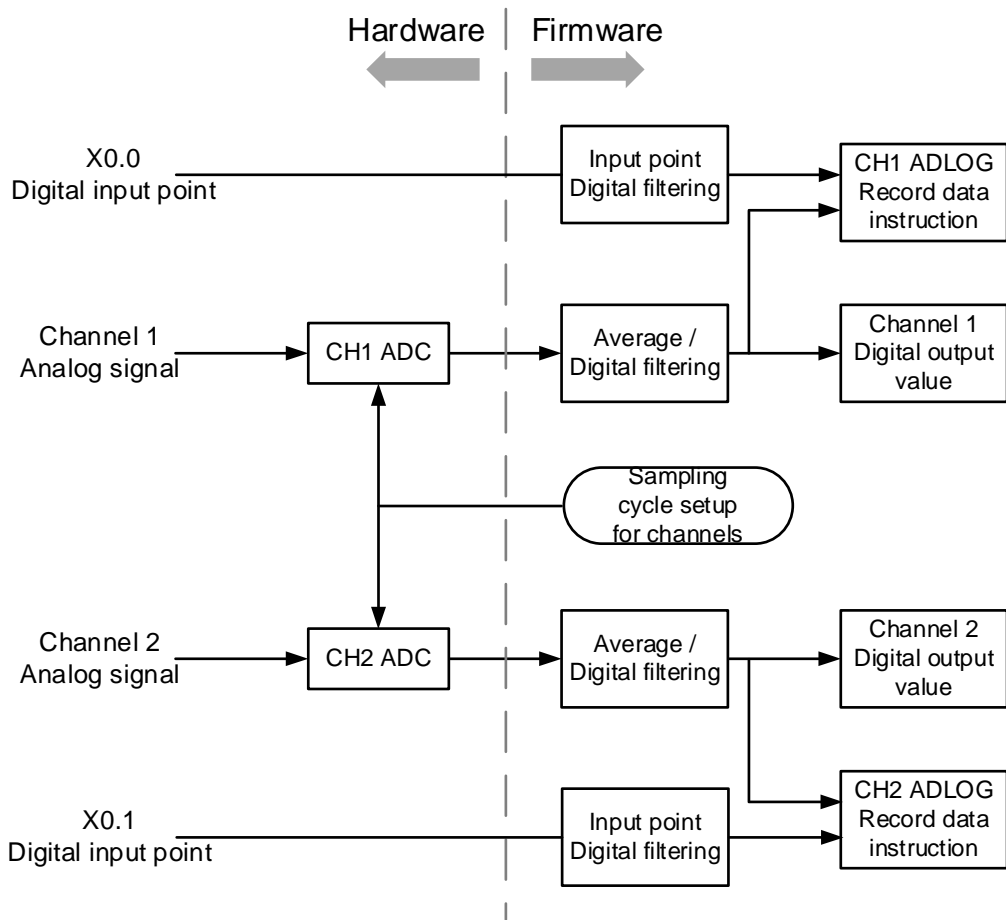

15

Example:

The conversion rate of analog to digital signals used in this example is 20 μ s per sampling cycle for two channels simultaneously.

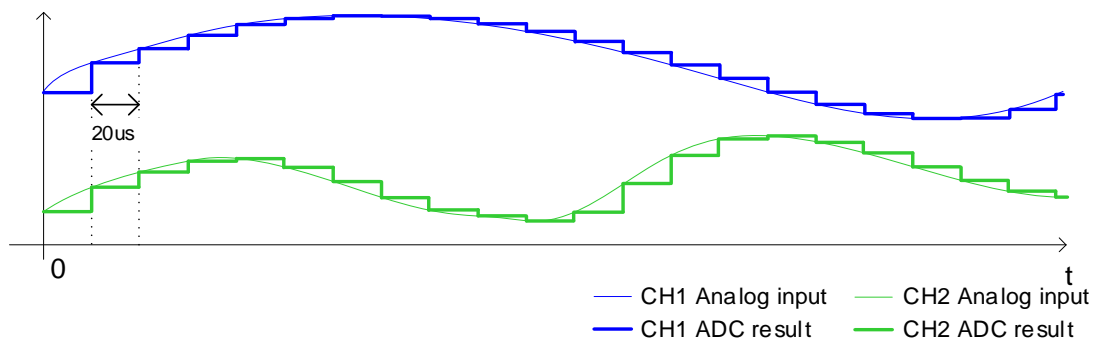

6. External input point trigger for digital filtering

Input point filtering is available to reduce the chance of being triggered by mistake or interferences: you can set the digital filtering cycle to 0 (disabled), 100 μ s, 200 μ s, 500 μ s according to your requirement.

The filtering cycle used in this example is 100 μ s.

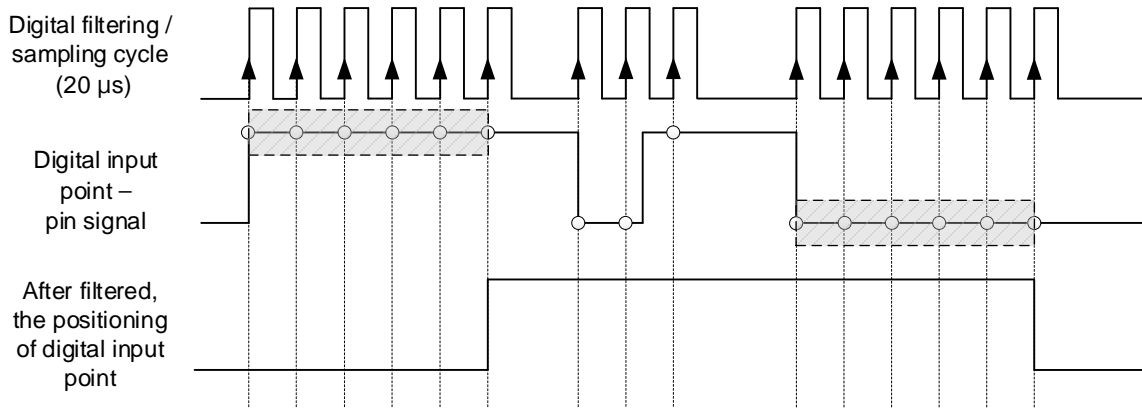

7. Digital output range

When the digital output value is out of the range (-32384 to 32384), the digital clipping is used to fix the exceeding value to the maximum / minimum digital output value.

15

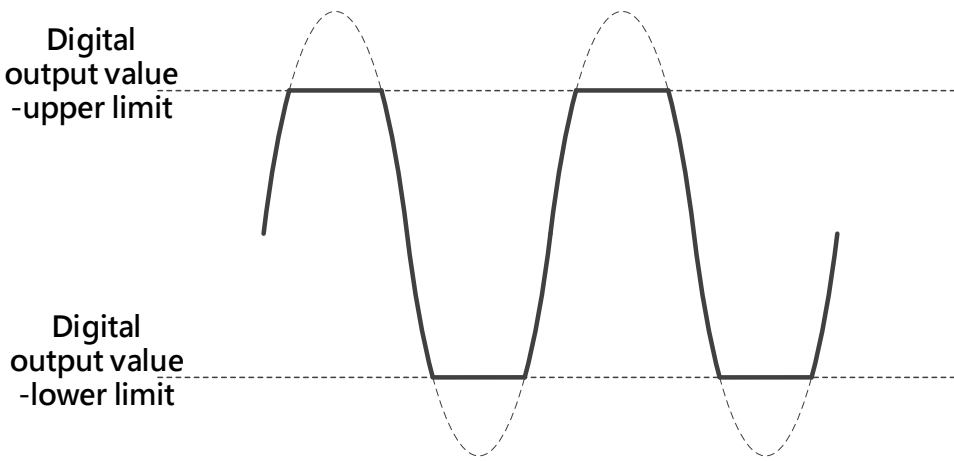

8. Channel detection and alarm

If an input signal exceeds the allowable hardware input range, an error message appears and error LED starts to blink. You can disable this function in the setting of Channel Detect and Alarm so that the module does not produce an alarm or a warning when the input signal exceeds the input range.

9. Logging function

AS02ADH can record 10000 piece of data, if used with instructions ADLOG and DADLOG (API 1424), you can set up the parameters, enable or disable recording for channels. Refer to section 6.15 (API14 Module Instructions) from AS Series Programming Manual for more information.

Instruction	Symbol	Functions
ADLOG (16-bit)	<div style="border: 1px solid black; padding: 5px;"> <p style="text-align: center;">ADLOG</p> <p>— En</p> <p>— Group Datalog</p> <p>— Module CurNo</p> <p>— ChNo Cmplt</p> <p>— Mode Error</p> <p>— Period ErrCode</p> <p>— Points</p> <p>— Postrig</p> </div>	<p>Enable / disable recording</p> <p>Record mode: Fixed period, Fixed period + Trigger start, Point logging, Fixed period + Trigger position assign</p> <p>Recording cycle: multiples of 1~32000</p> <p>Total number of all records: 1~2000</p> <p>The number of records before/after being triggered: 0~2000</p>
DADLOG (32-bit)	<div style="border: 1px solid black; padding: 5px;"> <p style="text-align: center;">DADLOG</p> <p>— En</p> <p>— Group Datalog</p> <p>— Module CurNo</p> <p>— ChNo Cmplt</p> <p>— Mode Error</p> <p>— Period ErrCode</p> <p>— Points</p> <p>— Postrig</p> </div>	<p>When the output value is in floating-point format, you need to use this 32-bit instruction.</p> <p>The fuctions for 32-bit instrucion are the same as they are stated for 16-bit instruction above.</p>

AS02ADH-A can record the shortest time (20 μs) of data and the longest time (2.56 s) of data. It can also record by external input point triggering or as every single log recording. Up to 2000 pieces of data can be recorded. And there are four recording modes are available.

- (1) Fixed period mode: Set **Mode**=0, the data recording would be performed according to the pre-defined record period when **EN** switches to ON. After the recording of a specified number of log points is complete, the **Cmplt** flag would be set to High automatically.

Example:

Set **Points** = 2000

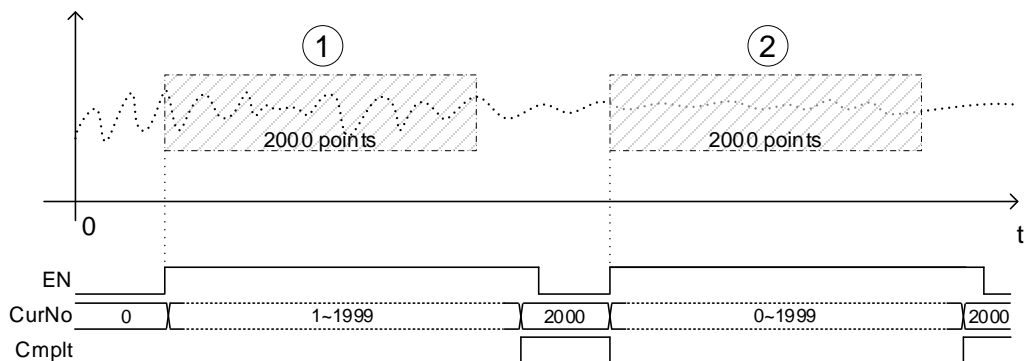

- (2) Fixed period + Trigger start mode: Set **Mode**=1 and switch instruction **EN** to ON before the recording starts. When a trigger signal is detected at the external input point, start recording based on the pre-defined record period. And the **Cmplt** flag is set to **High** automatically when completed. Before the recording is complete, any operation at the external input points does NOT affect the proceeding of record. When the recording of log points is complete and the **Cmplt** flag is **High**, trigger the external input points again to start a new cycle of recording; the instruction EN does NOT required to be turned OFF and then ON again to start another new recording.

Record Channel	The signal source corresponding to the external input points (Set the timing for external input trigger in HWCONFIG)
Channel 1	X0.0 rising-edge or falling-edge triggered
Channel 2	X0.1 rising-edge or falling-edge triggered

Example:

Set **Points** = 2000, the trigger timing for the external input point is set to rising-edge triggered.

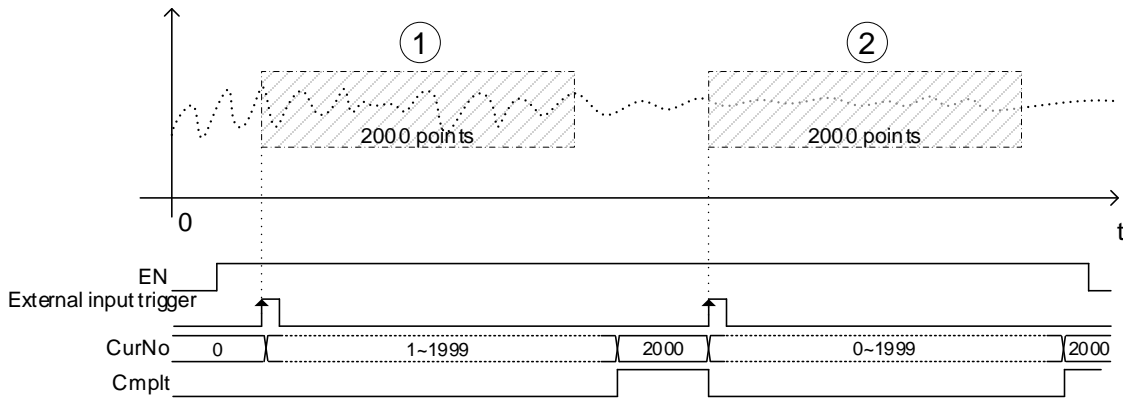

The feature of Fixed period + Trigger Start is similar to Fixed period. But the start timing of recording in Fixed period mode would be delayed as a result of PLC scan time and module communication time, which is shown in the following illustration. It is assumed that M0 is the device to control EN of ADLOG instruction. We can see when M0 switches from OFF to ON, the module does not start recording immediately but with a slight delay.

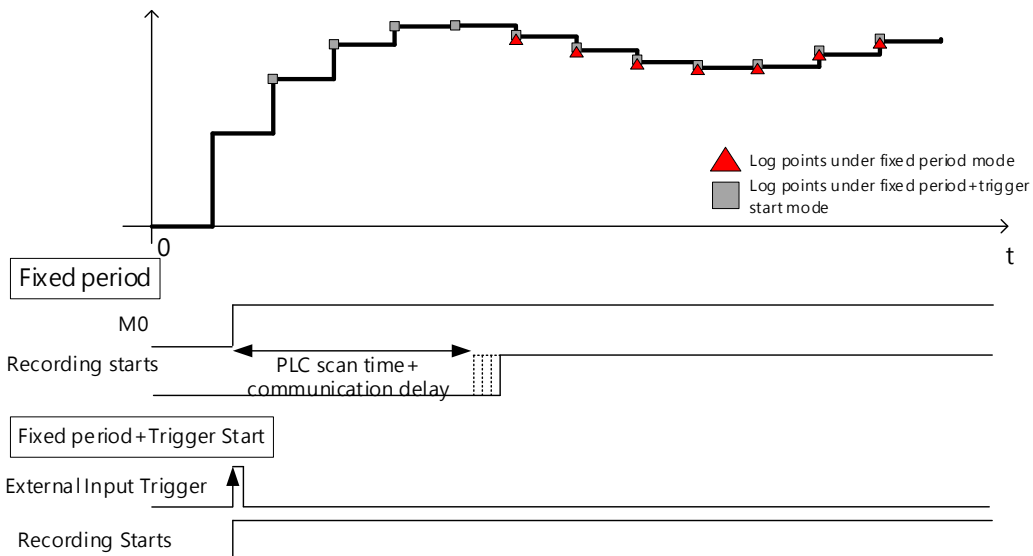

- (3) Point Logging mode: Set **Mode**=2, turn the instruction EN to ON before the recording starts. One log point would be recorded for each triggering at external input point until it reaches the pre-defined point number, **Cmplt** flag would set to High automatically. If you need to the recording to be continued after the **Cmplt** flag is set to High, execute the instruction again.

Record Channel	The signal source corresponding to the external input points (Set the timing for external input trigger in HWCONFIG)
Channel 1	X0.0 rising-edge or falling-edge triggered
Channel 2	X0.1 rising-edge or falling-edge triggered

Example:

Set **Points** = 2000, the trigger timing for external input point is set to rising-edge triggered.

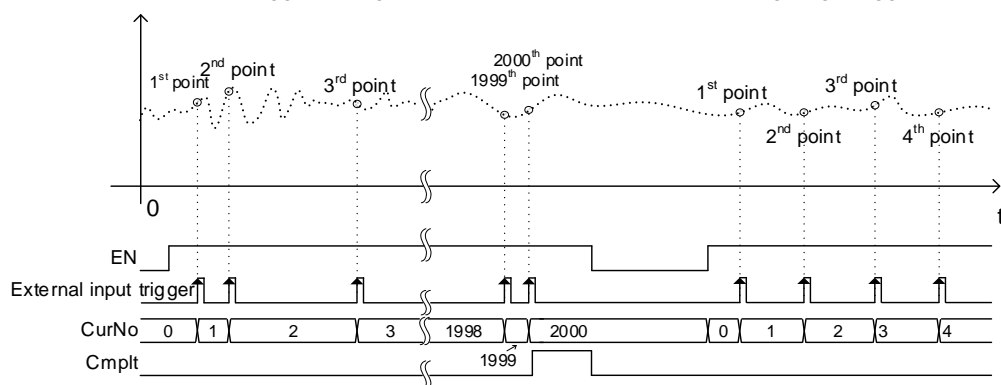

- (4) Fixed period + Trigger position Assign mode: Set **Mode**=3 and set parameters **Points** and **PostTrg** according to your requirements. This mode is to trigger at the external input point and record the pre-defined number of log points before and after the triggering occurs. When using EN to turn on this mode, AS02ADH-A would start waiting for signals to be triggered at external input. And the sampling would start right after, until it reaches the pre-defined point number, and then **Cmplt** flag would set to High automatically. The value in **CurNo** is 0 before triggered, and after triggered, the modules start to send the before-triggered data log to the PLC CPU . Therefore the value of **CurNo** would catch up to the number of accumulated log points.

Record Channel	The signal source corresponding to the external input points (Set the timing for external input trigger in HWCONFIG)
Channel 1	X0.0 rising-edge or falling-edge triggered
Channel 2	X0.1 rising-edge or falling-edge triggered

Example

Set **Mode=3**, **Points = 2000**, and **PostTrg = 1500** so the position of point 501 (**Points – PostTrg**) would be the first record after an external trigger signal is detected.

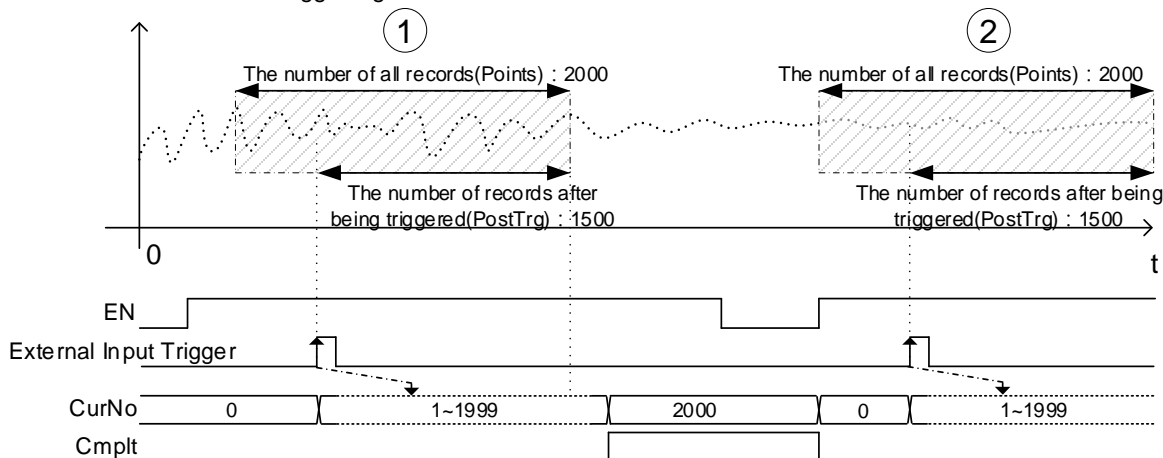

10. Peak records for channels

AS02ADH can record 10000 piece of data, if used with instructions ADPEAK and DADPEAK (API 1425) to save the maximum and minimum value for channels. Refer to section 6.15 (API14 Module Instructions) from AS Series Programming Manual for more information.

Instruction	Symbol	Functions
ADPEAK (16-bit)	<div style="border: 1px solid black; padding: 5px;"> ADPEAK — En — Group MAX — Module MIN — ChNo Error ErrCode </div>	Enable / disable peak data recording
DADPEAK (32-bit)	<div style="border: 1px solid black; padding: 5px;"> DADPEAK — En — Group MAX — Module MIN — ChNo Error ErrCode </div>	When the output value is in floating-point format, you need to use this 32-bit instruction. The fuctions for 32-bit instrucion are the same as they are stated for 16-bit instruction above.

11. Disconnection detection

Disconnection detection only operates when the analog range is 4–20 mA or 1–5 V. If a module that can receive inputs between 4–20 mA or from 1–5 V is disconnected, the input signal exceeds the range of allowable inputs, so the module produces an alarm or a warning.

15.2.6 Wiring

● Precautions

To ensure the analog-to-digital module functions well and reliably, the external wiring must prevent noise. Before you install the cables, follow the precautions below.

- (1) To prevent a surge and induction, the AC cable and the input signal cables that are connected to the module must be separate cables.
- (2) Do not install the cable near a main circuit, a high-voltage cable, or a cable connected to a load that is not a PLC. In addition, the cable must not be bound to a main circuit, a high-voltage cable, or a cable connected to a load which is not a PLC.
- (3) Ground shielded cables and hermetically sealed cables separately.
- (4) Terminals with insulation sleeves cannot be arranged as a terminal block, so you should cover the terminals with insulation tubes.
- (5) Use single-core cables or twin-core cables in a diameter of 24 AWG–22 AWG with pin-type connectors smaller than 1 mm. Use only copper conducting wires that can resist temperatures above 60° C-75° C.

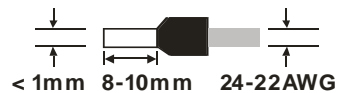

- (6) Notes on two-wire, three-wire, and four-wire connections:
 - Two-wire connection/three-wire connection (passive transducer): connect the transducer and the analog input module to the same power circuit.
 - Four-wire connection (active transducer): the transducer uses an independent power supply so do not connect it to the same power circuit as the analog input module.
- (7) Note: use cables with the same length (less than 200 m) and use wire resistance of less than 20 ohm.

15.2.6.1 Digital Input Wiring

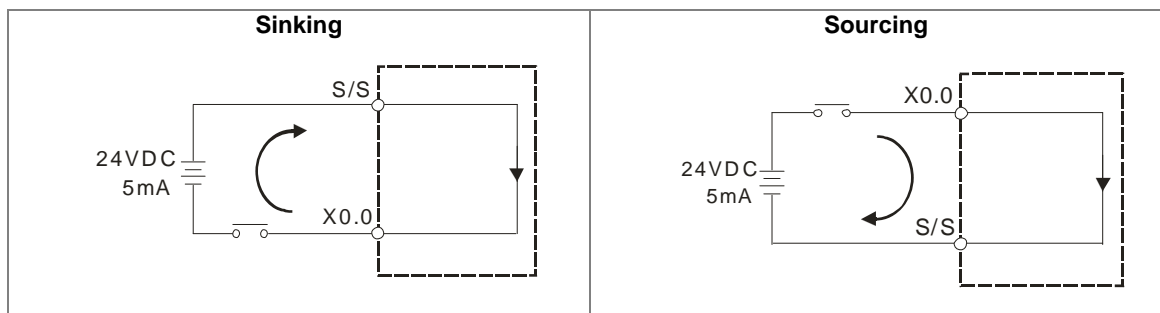

15.2.6.2 Analog Input Wiring

● 4-wired

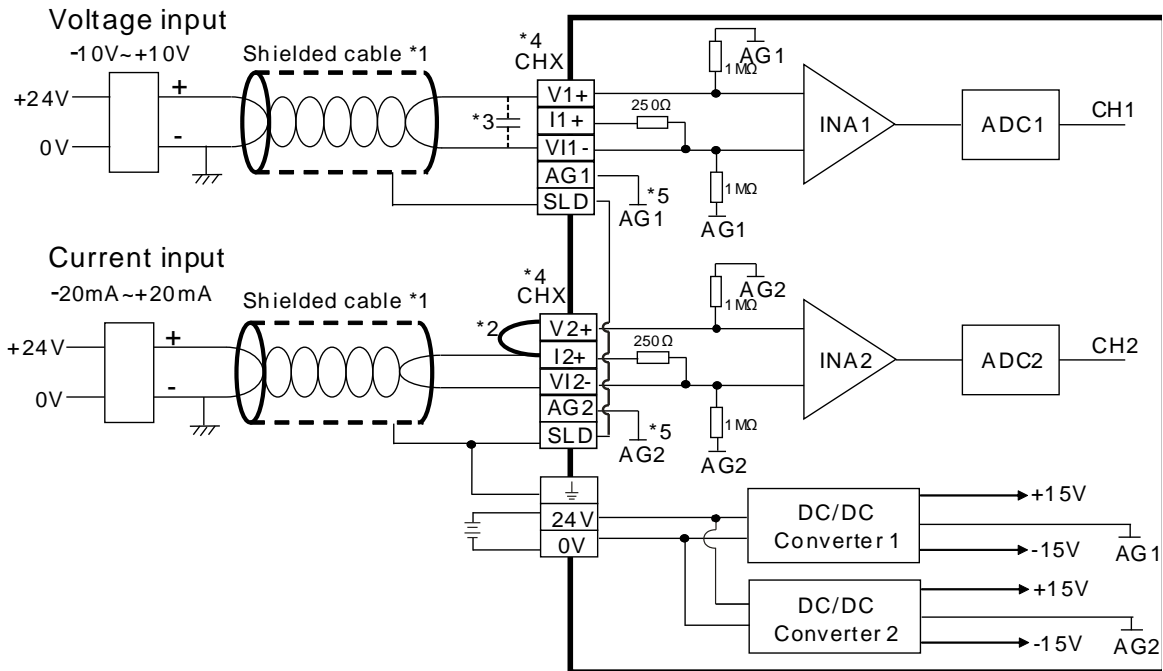

- *1. Use shielded cables to isolate the analog input signal cable from other power cables.
- *2. If the module is connected to a current signal, the terminals V_n and I_{n+} (n=1–2) must be short-circuited.
- *3. If variability in the input voltage results in interference within the wiring, connect the module to a capacitor with a capacitance between 0.1–0.47 μF and a working voltage of 25 V.
- *4. The wording “CHX” indicates that very channel can operate with the wiring presented above.
- *5. If the environment is severe or there is interferences in 24 V pwer supply, short-circuit AG_n (n=1-2) and the input signal.

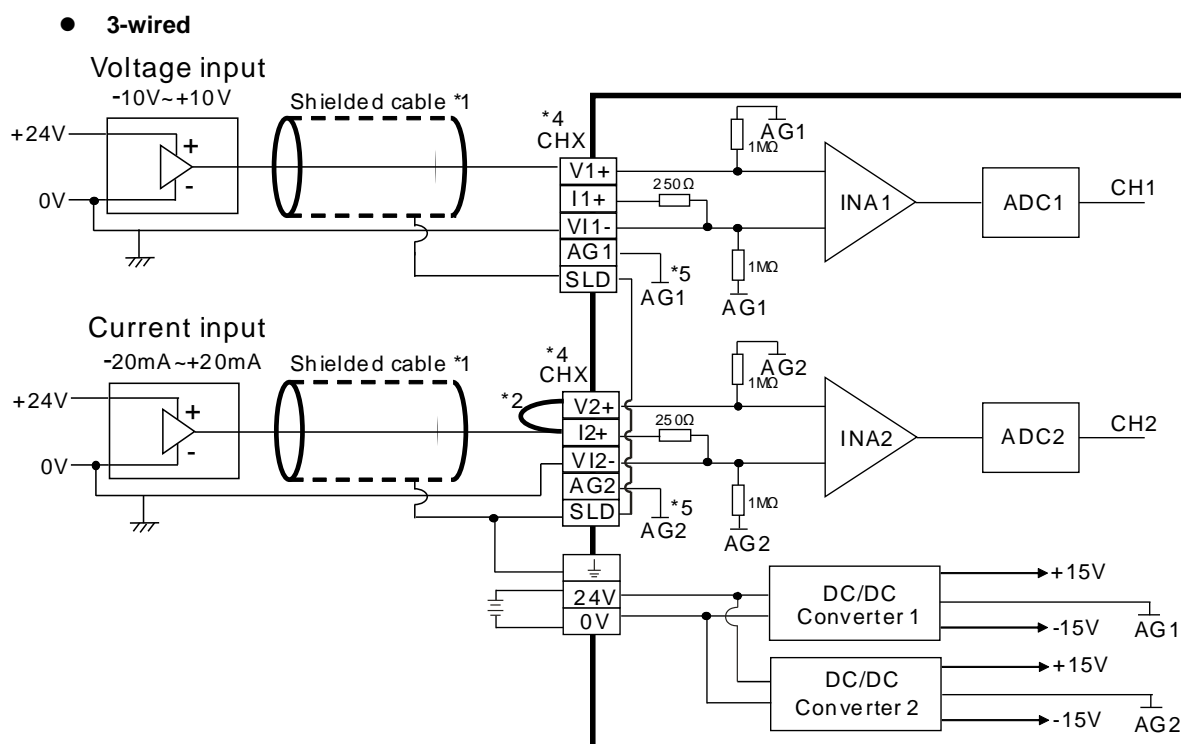

*1. Use shielded cables to isolate the analog input signal cable from other power cables.

*2. If the module is connected to a current signal, the terminals V_n and I_n+ ($n=1-2$) must be short-circuited.

*3. If variability in the input voltage results in interference within the wiring, connect the module to a capacitor with a capacitance between 0.1–0.47 μF and a working voltage of 25 V.

*4. The wording “CHX” indicates that very channel can operate with the wiring presented above.

*5. If the environment is severe or there is interferences in 24 V pwer supply, short-circuit AG_n ($n=1-2$) and the input signal.

● 2-wired

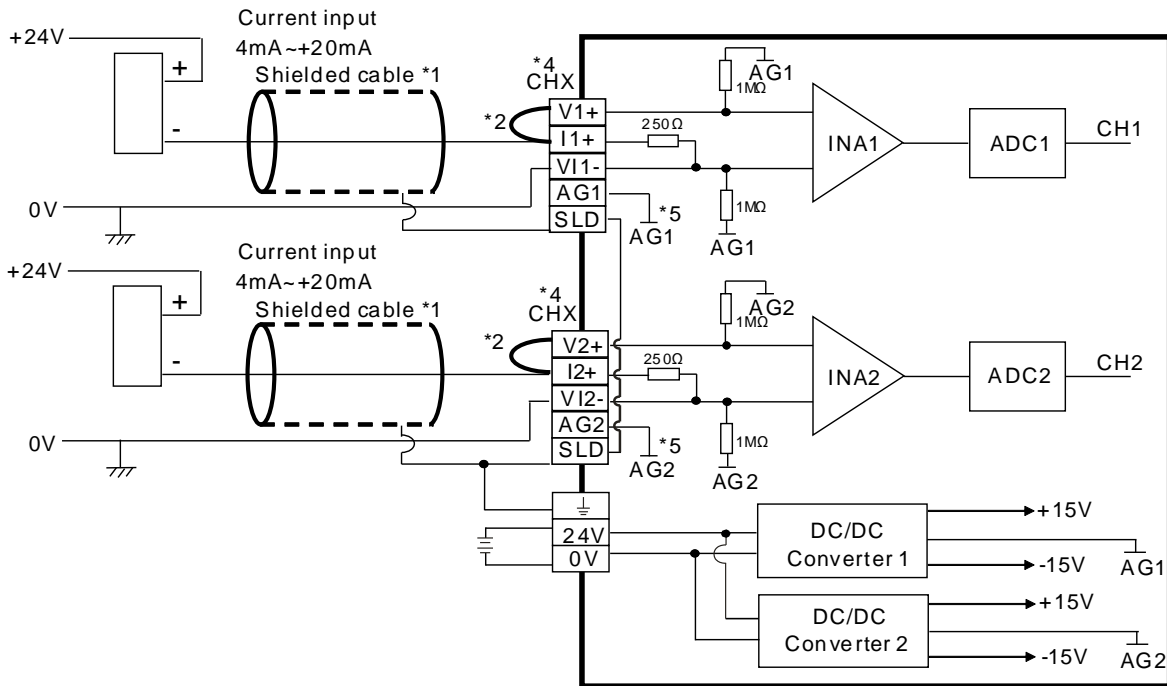

- *1. Use shielded cables to isolate the analog input signal cable from other power cables.
- *2. If the module is connected to a current signal, the terminals V_n and I_n+ ($n=1-2$) must be short-circuited.
- *3. If variability in the input voltage results in interference within the wiring, connect the module to a capacitor with a capacitance between $0.1-0.47 \mu\text{F}$ and a working voltage of 25 V.
- *4. The wording "CHX" indicates that very channel can operate with the wiring presented above.
- *5. If the environment is severe or there is interferences in 24 V pwer supply, short-circuit AG_n ($n=1-2$) and the input signal.

15.2.7 LED Indicators

Printed as	Function	Description
PWR	Power indicator	Power status of the module ON: The power supply is normal. OFF: No power supply
ERR	ERROR indicator	Error status of the module ON: a major error occurs in the module. OFF: the module is operating normally. Blink: a minor error occurs in the module.
X0.0	X0.0 input status indicator	ON: The X0.0 input is active. OFF: The X0.0 input is not active.
X0.1	X0.1 input status indicator	ON: The X0.1 input is active. OFF: The X0.1 input is not active.
AD1	CH1 analog to digital conversion indicator	Analog-to-digital conversion status Blinking: conversion is in process. OFF: conversion has stopped.
AD2	CH2 analog to digital conversion indicator	

15.3 HWCONFIG in ISPSoft

15.3.1 Initial Setting

(1) Start ISPSoft and double-click **HWCONFIG**.

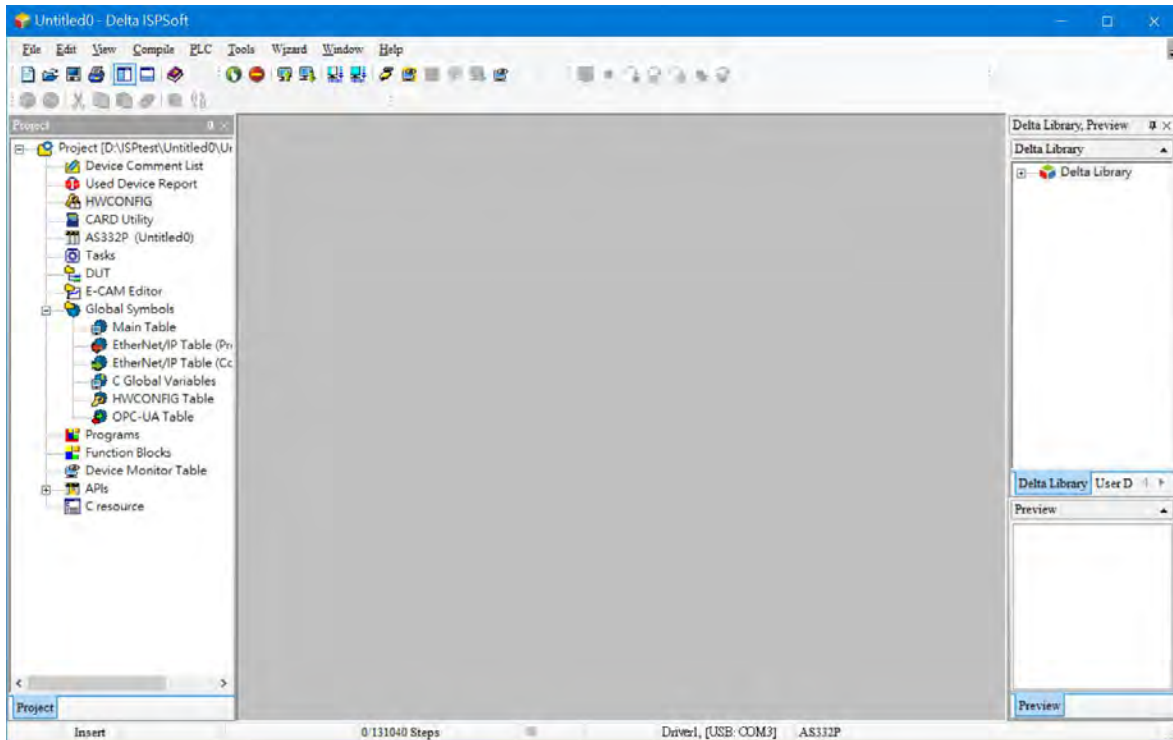

15

(2) Click Scan to see the available devices.

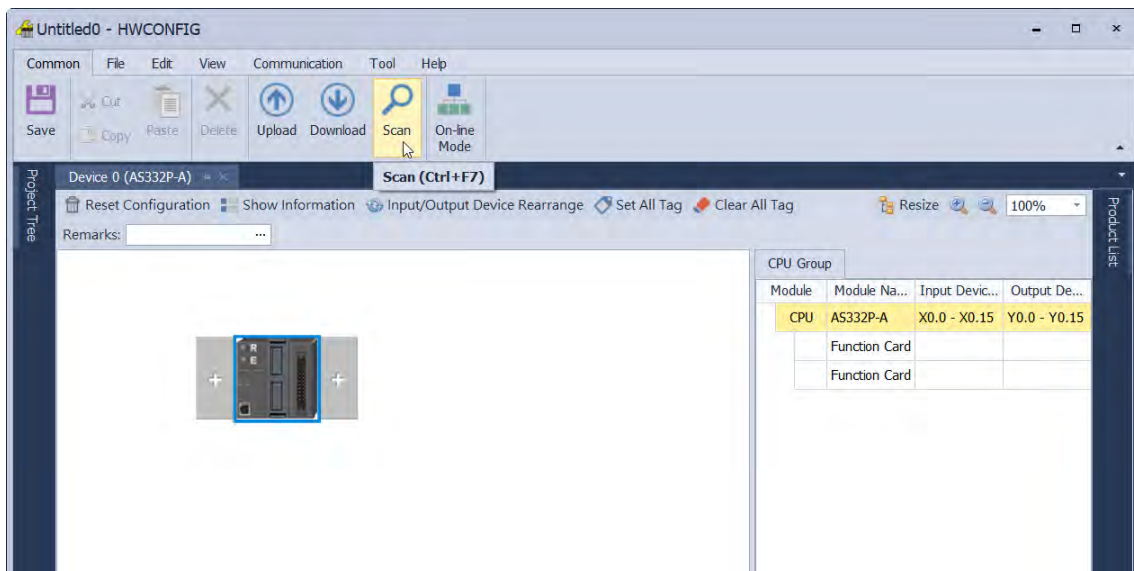

- (3) After the scanning is completed, AS02ADH will appear in the following window.

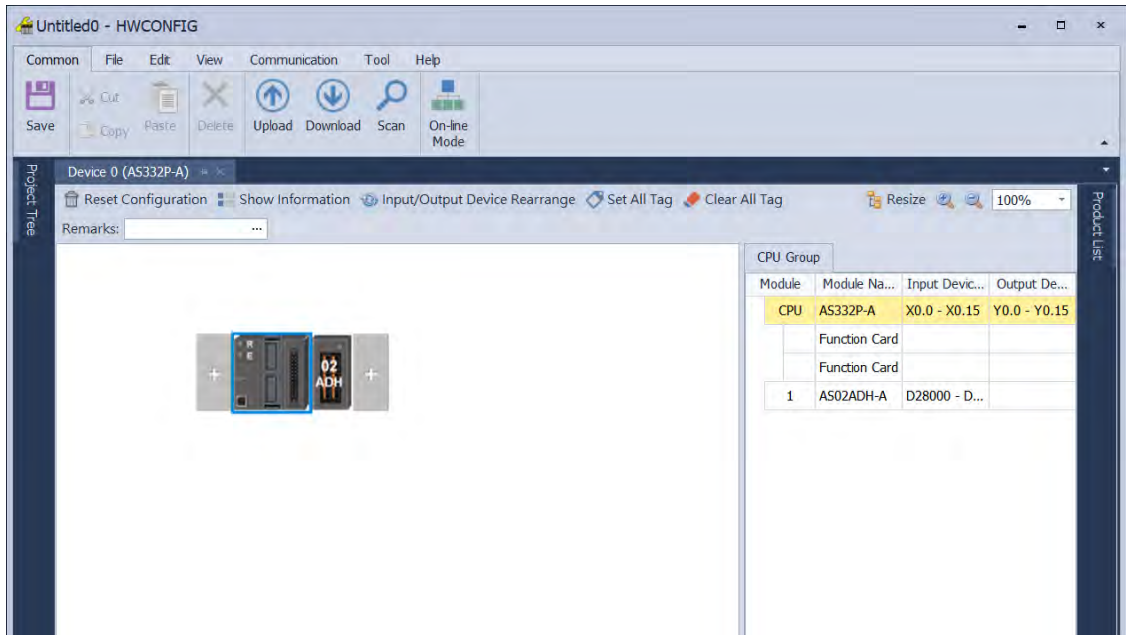

- (4) Select AS02ADH and set module parameters.

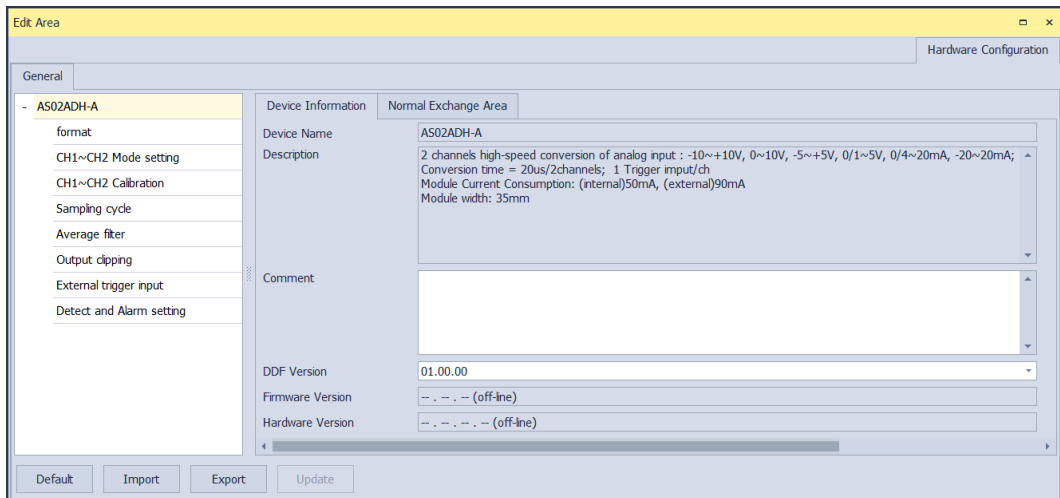

(5) Close the setting page to finish the setting.

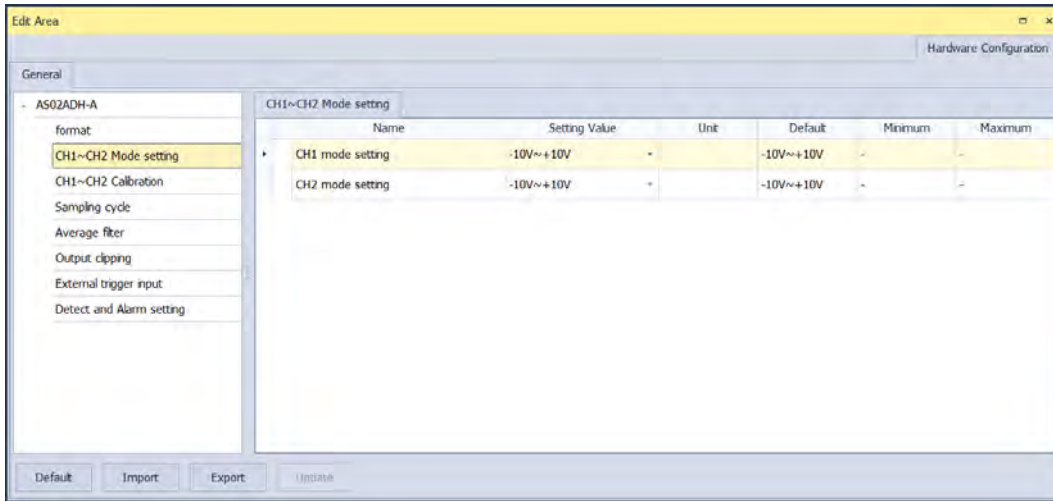

(6) Click **Download** to download the configuration data. (The download can not be performed if the CPU is in RUN state)

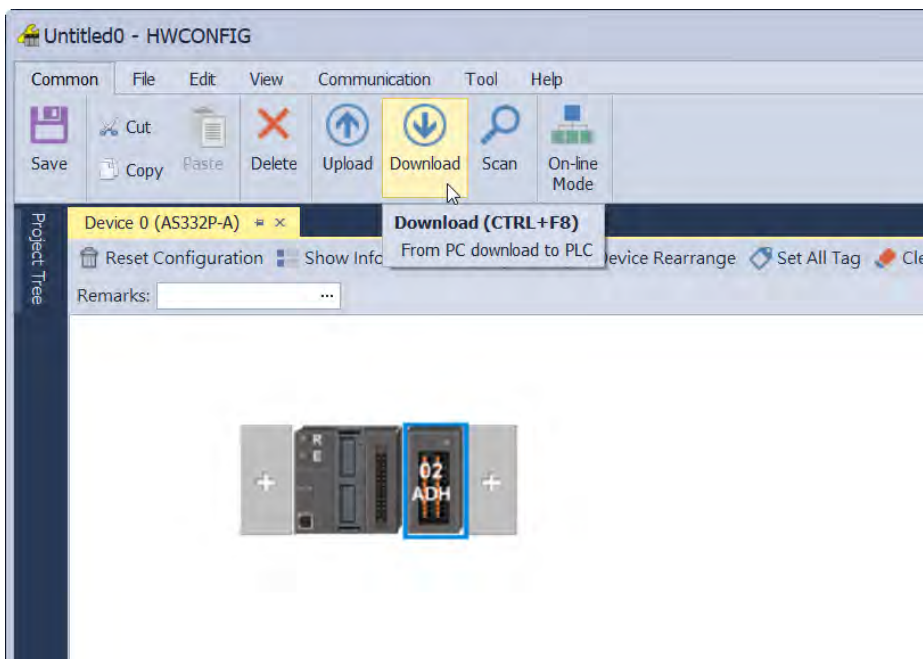

15.3.2 Checking the Version of a Module

- (1) Click **Common** menu > **On-line Mode**.

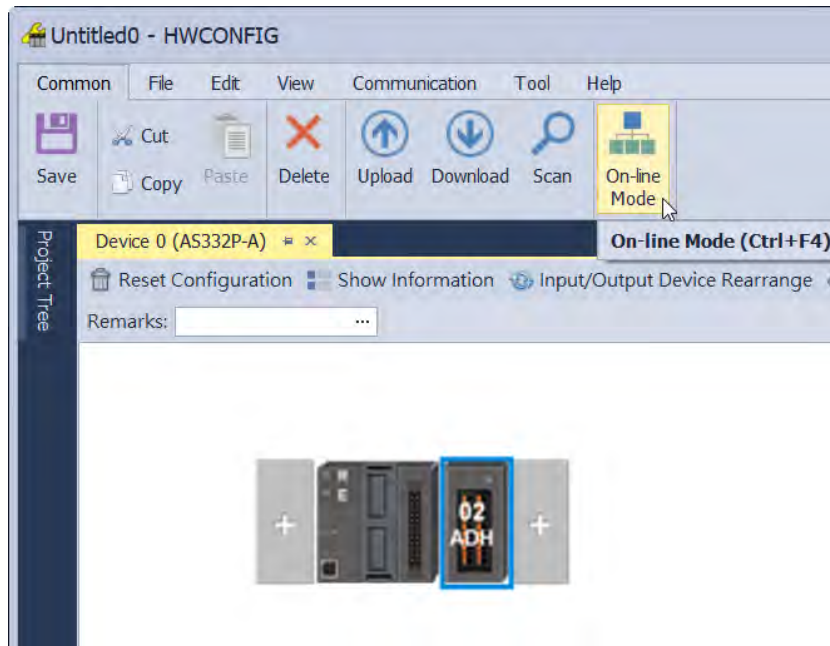

- (2) Double-click **AS02ADH** module to check the firmware version and hardware version.

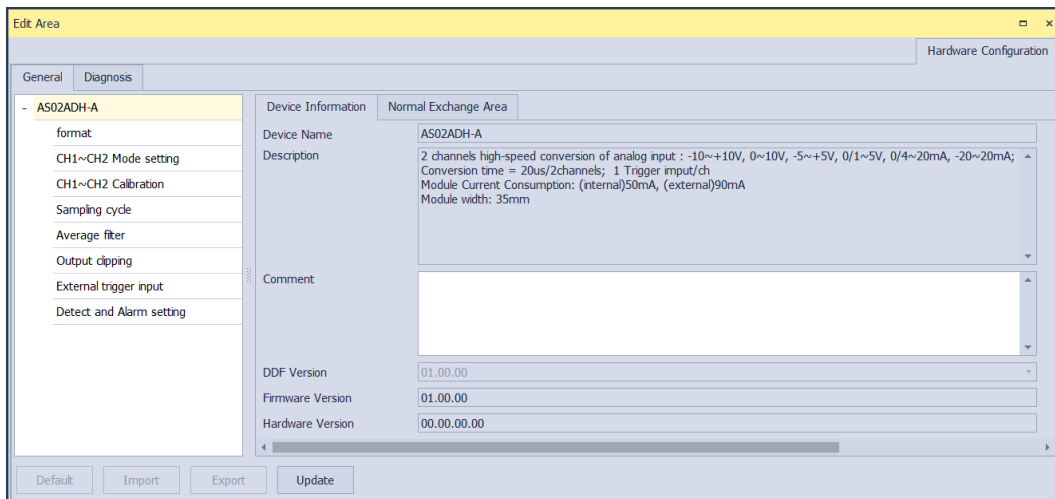

15.3.3 Online Mode

(1) Click **On-line Mode** to enter the online mode.

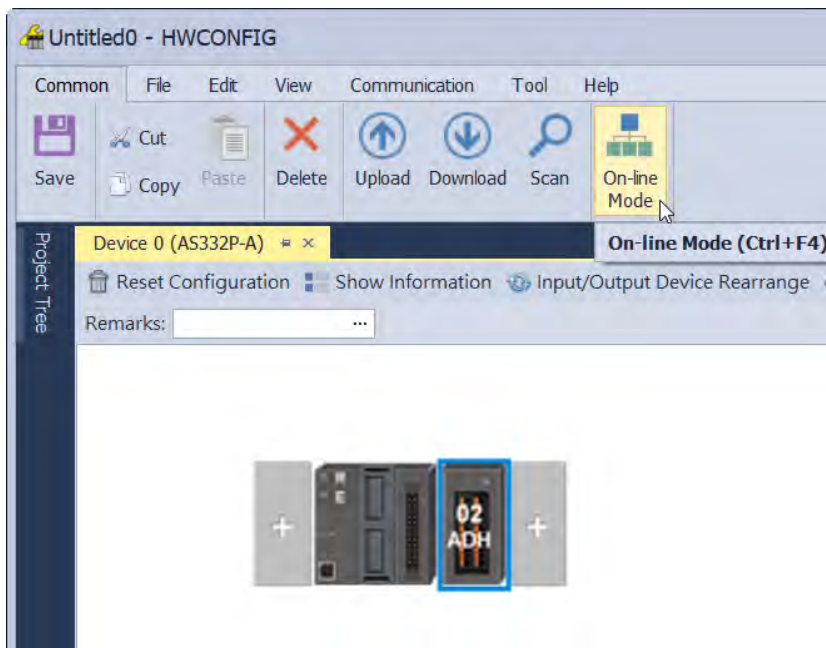

(2) Right-click the module and click **Module State** or **Diagnosis**. You can find digital output value and error codes in **Module State** and the error log can be found in **Diagnosis**.

15

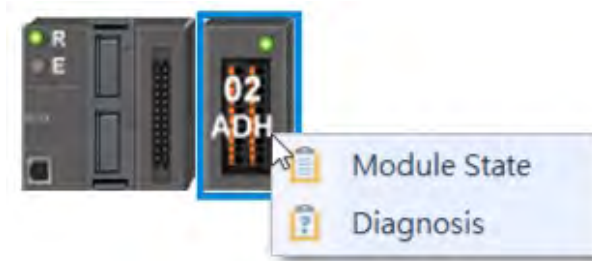

(1) View the module state.

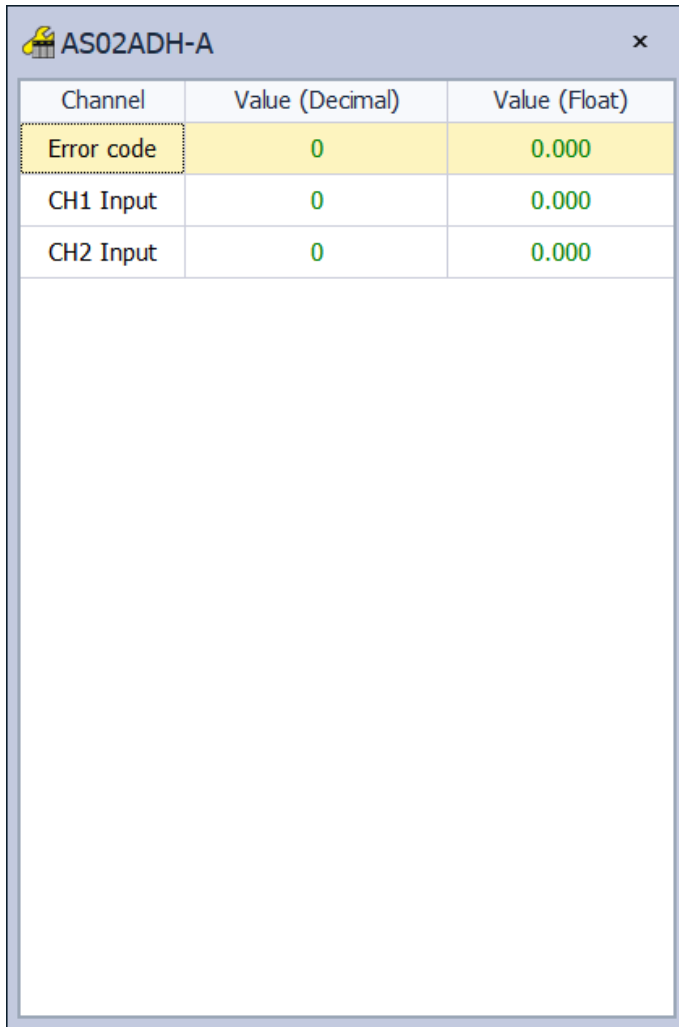

Channel	Value (Decimal)	Value (Float)
Error code	0	0.000
CH1 Input	0	0.000
CH2 Input	0	0.000

15.3.4 Importing/Exporting a Parameter File

(1) Click **Export** in the dialog box to save the current parameters as a dep file (.dep).

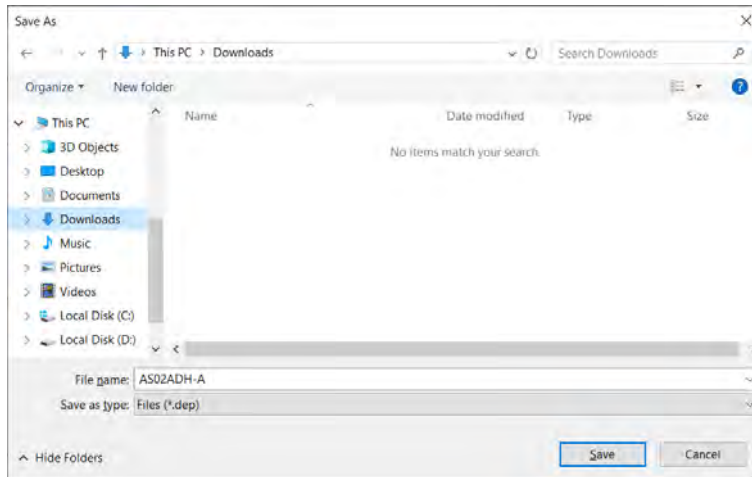
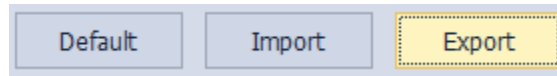

15

(2) Click **Import** in the dialog box and select a dep file to save parameters.

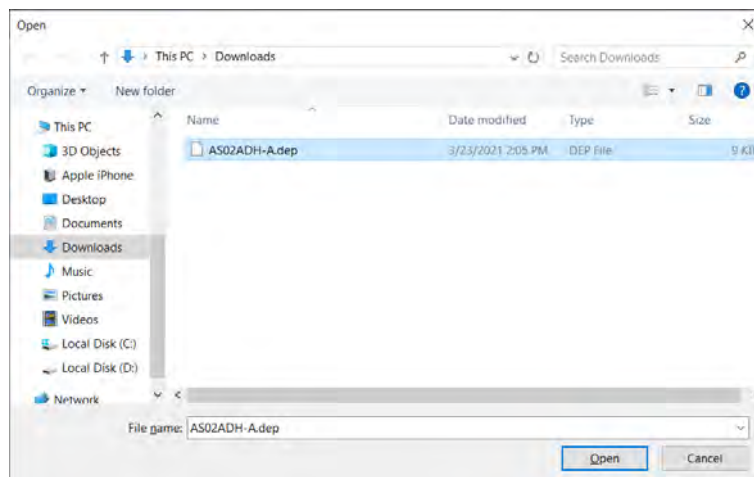
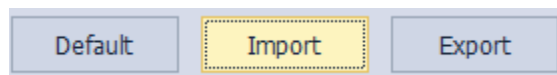

15.3.5 Parameters

- (1) Set up the parameters.

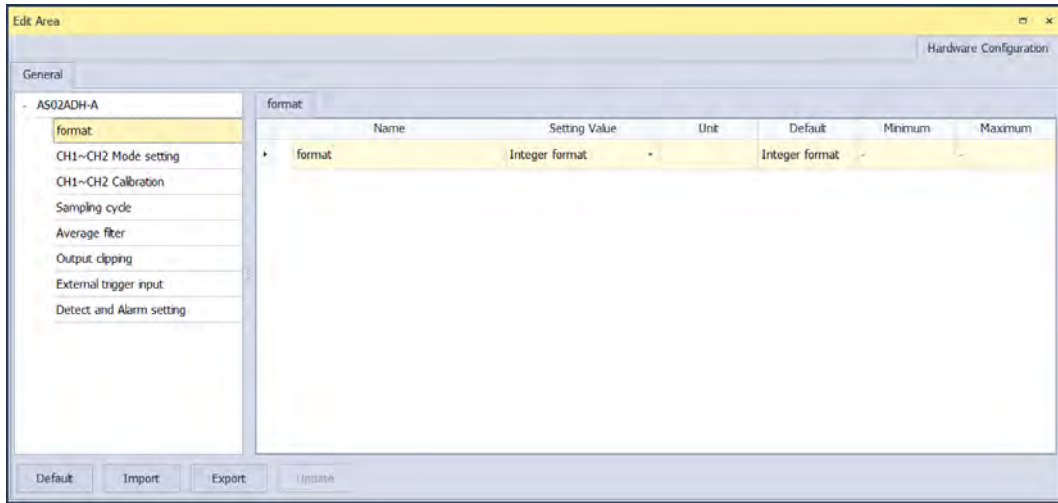

- (2) The CH1-CH2 (channel 1-channel 2) mode settings

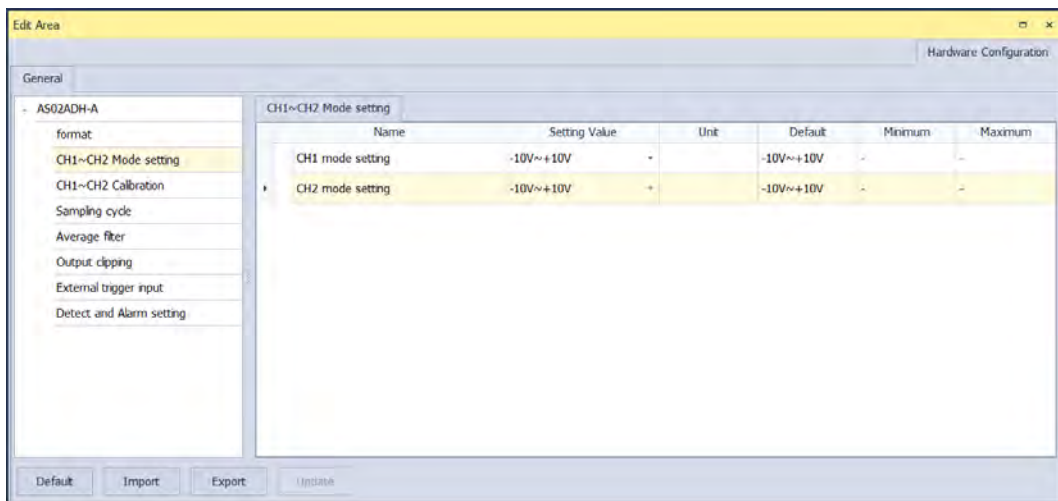

(3) The CH1-CH2 calibration settings

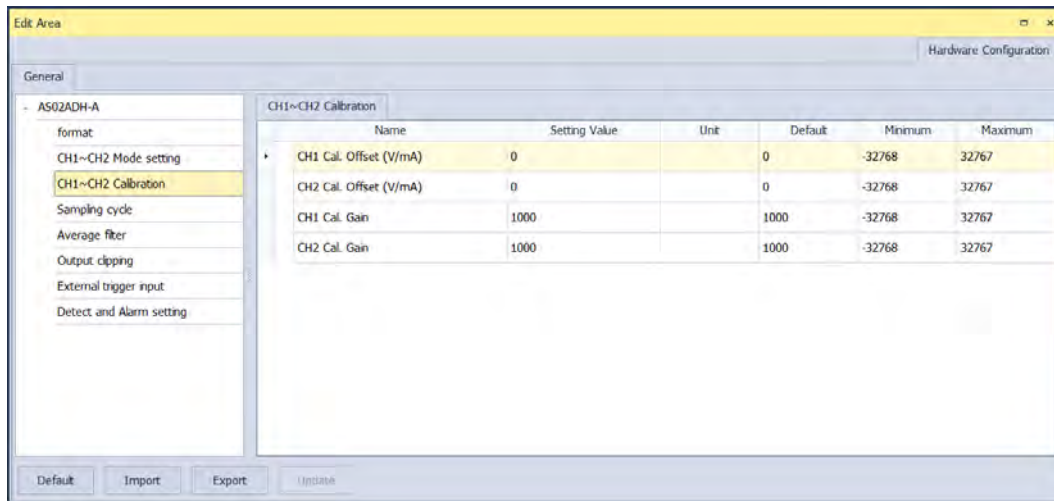

(4) The sampling cycle settings

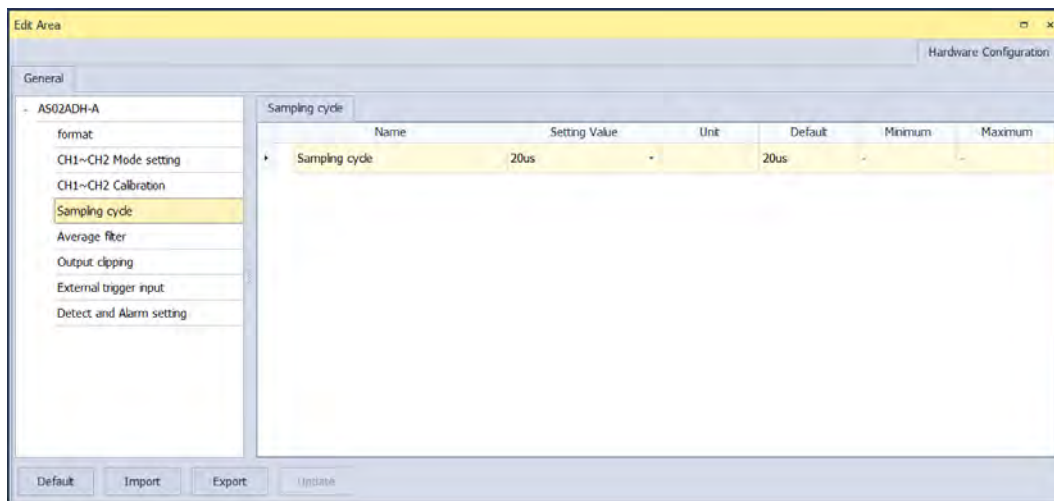

(5) The average filter settings

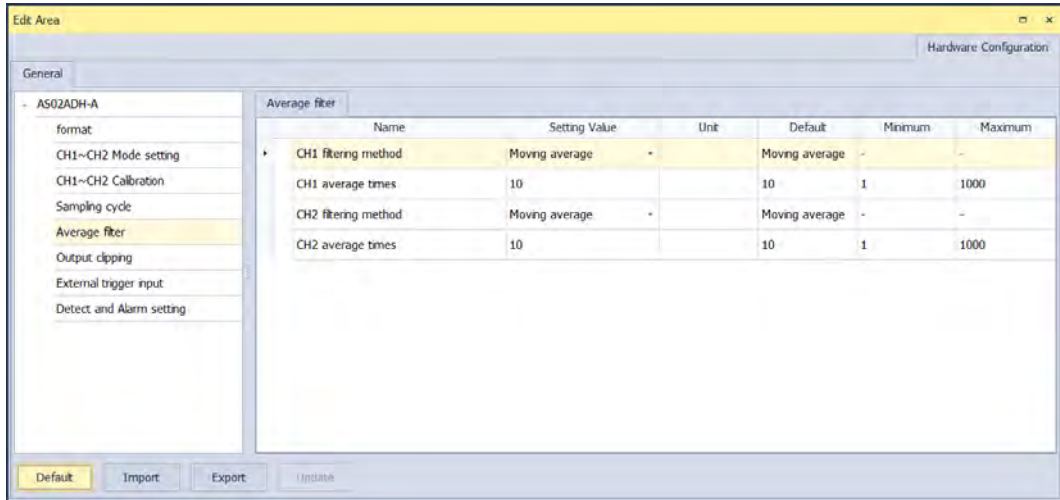

(6) The output clipping settings

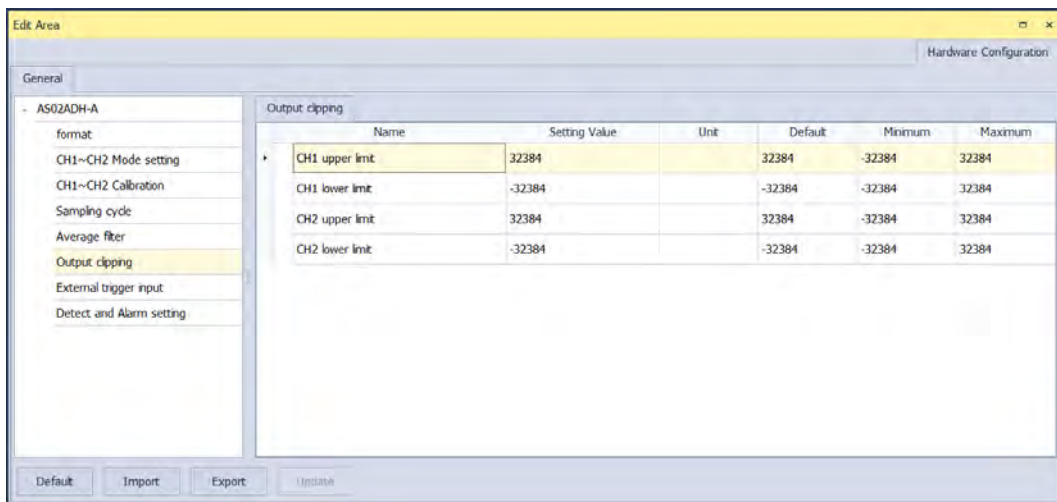

(7) The external trigger input settings

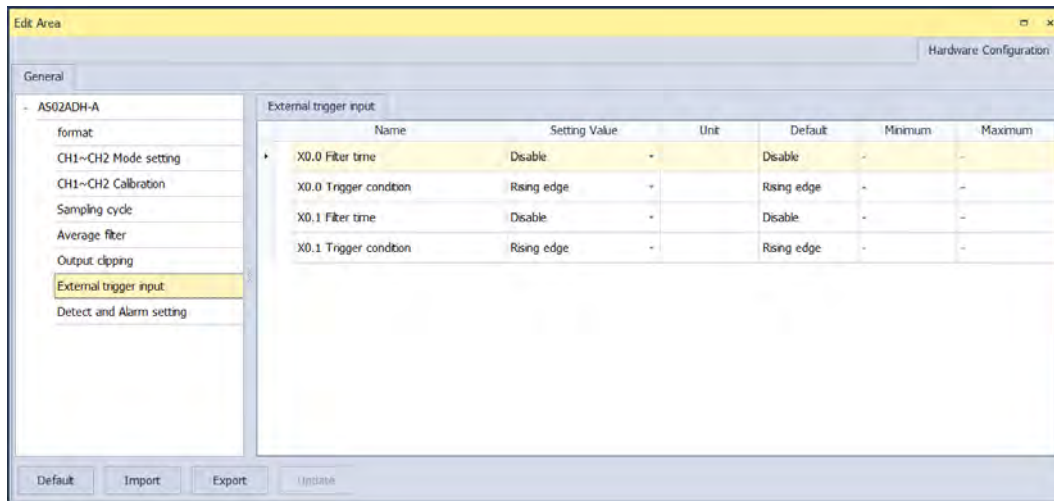

(8) The detect and alarm settings

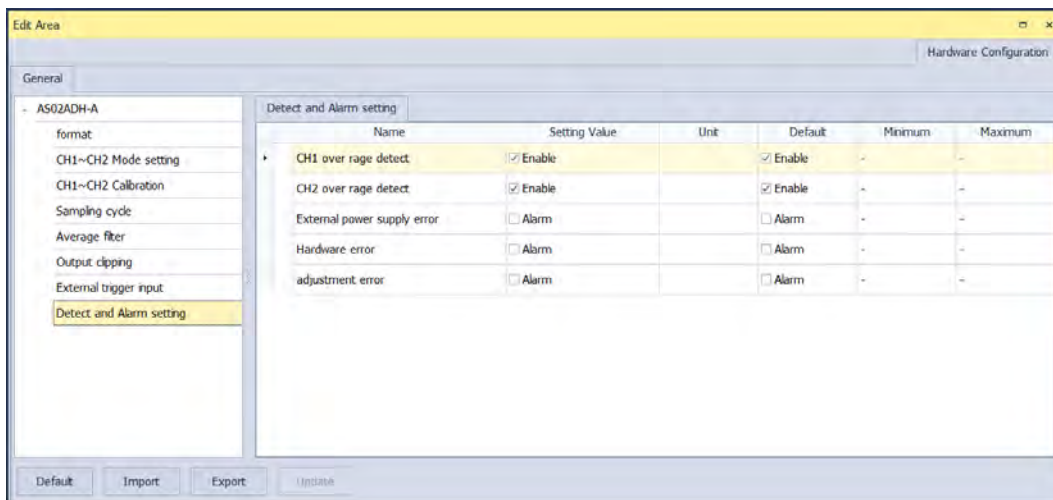

15.4 Troubleshooting

15.4.1 Error Codes

Error Code	Description	A → D LED Indicator	ERROR LED Indicator
16#1605	Hardware failure	Run: Blinking Stop: OFF	ON
16#1606	The parameter setting is not consistent. (alarm)	Run: Blinking Stop: OFF	ON
16#1607	The external voltage is abnormal. (alarm)	OFF	ON
16#1608	The factory calibration is abnormal. (alarm)	Run: Blinking Stop: OFF	ON
16#1801	The external voltage is abnormal.	OFF	Blinking
16#1802	Hardware failure	Run: Blinking Stop: OFF	Blinking
16#1804	The factory calibration is abnormal.	Run: Blinking Stop: OFF	Blinking
16#1808	The signal received by channel 1 exceeds the range of inputs that the hardware can receive.	Run: Blinking Stop: OFF	Blinking
16#1809	The signal received by channel 2 exceeds the range of inputs that the hardware can receive.		
-	When power-on, the module is not detected by CPU module.	OFF	Blinking once or twice and after 2 seconds, it blinks repeatedly

15.4.2 Troubleshooting Procedure

Description	Procedure
The external voltage is abnormal.	Make sure the external 24 V power supply to the module is functioning normally.
Hardware failure	Return the module to the factory for repair.
Internal error The factory calibration is abnormal.	Contact the factory.
The signal received by channel 1 exceeds the range of inputs that the hardware can receive.	Check the signal received by channel 1
The signal received by channel 2 exceeds the range of inputs that the hardware can receive.	Check the signal received by channel 2.
When power-on, the module is not detected by CPU module.	Check if the connection between module and CPU module is working. If not, connect again.