

Industrial Automation Headquarters

Taiwan: Delta Electronics, Inc.
Taoyuan Technology Center
No.18, Xinglong Rd., Taoyuan District,
Taoyuan City 33068, Taiwan
TEL: +886-3-362-6301 / FAX: +886-3-371-6301

Asia

China: Delta Electronics (Shanghai) Co., Ltd.
No.182 Minyu Rd., Pudong Shanghai, P.R.C.
Post code : 201209
TEL: +86-21-6872-3988 / FAX: +86-21-6872-3996
Customer Service: 400-820-9595

Japan: Delta Electronics (Japan), Inc.
Industrial Automation Sales Department
2-1-14 Shibadaimon, Minato-ku
Tokyo, Japan 105-0012
TEL: +81-3-5733-1155 / FAX: +81-3-5733-1255

Korea: Delta Electronics (Korea), Inc.
1511, 219, Gasan Digital 1-Ro., Geumcheon-gu,
Seoul, 08501 South Korea
TEL: +82-2-515-5305 / FAX: +82-2-515-5302

Singapore: Delta Energy Systems (Singapore) Pte Ltd.
4 Kaki Bukit Avenue 1, #05-04, Singapore 417939
TEL: +65-6747-5155 / FAX: +65-6744-9228

India: Delta Electronics (India) Pvt. Ltd.
Plot No.43, Sector 35, HSIIIDC Gurgaon,
PIN 122001, Haryana, India
TEL: +91-124-4874900 / FAX: +91-124-4874945

Thailand: Delta Electronics (Thailand) PCL.
909 Soi 9, Moo 4, Bangpoo Industrial Estate (E.P.Z),
Pattana 1 Rd., T.Phraksa, A.Muang,
Samutprakarn 10280, Thailand
TEL: +66-2709-2800 / FAX: +66-2709-2827

Australia: Delta Electronics (Australia) Pty Ltd.
Unit 2, Building A, 18-24 Ricketts Road,
Mount Waverley, Victoria 3149 Australia
Mail: IA.au@deltaww.com
TEL: +61-1300-335-823 / +61-3-9543-3720

Americas

USA: Delta Electronics (Americas) Ltd.
5101 Davis Drive, Research Triangle Park, NC 27709, U.S.A.
TEL: +1-919-767-3813 / FAX: +1-919-767-3969

Brazil: Delta Electronics Brazil Ltd.
Estrada Velha Rio-São Paulo, 5300 Eugênio de
Melo - São José dos Campos CEP: 12247-004 - SP - Brazil
TEL: +55-12-3932-2300 / FAX: +55-12-3932-237

Mexico: Delta Electronics International Mexico S.A. de C.V.
Gustavo Baz No. 309 Edificio E PB 103
Colonia La Loma, CP 54060
Tlalnepantla, Estado de México
TEL: +52-55-3603-9200

EMEA

EMEA Headquarters: Delta Electronics (Netherlands) B.V.
Sales: Sales.IA.EMEA@deltaww.com
Marketing: Marketing.IA.EMEA@deltaww.com
Technical Support: iatechnicalsupport@deltaww.com
Customer Support: Customer-Support@deltaww.com
Service: Service.IA.emea@deltaww.com
TEL: +31(0)40 800 3900

BENELUX: Delta Electronics (Netherlands) B.V.
Automotive Campus 260, 5708 JZ Helmond, The Netherlands
Mail: Sales.IA.Benelux@deltaww.com
TEL: +31(0)40 800 3900

DACH: Delta Electronics (Netherlands) B.V.
Coesterweg 45, D-59494 Soest, Germany
Mail: Sales.IA.DACH@deltaww.com
TEL: +49(0)2921 987 0

France: Delta Electronics (France) S.A.
ZI du bois Challand 2, 15 rue des Pyrénées,
Lisses, 91090 Evry Cedex, France
Mail: Sales.IA.FR@deltaww.com
TEL: +33(0)1 69 77 82 60

Iberia: Delta Electronics Solutions (Spain) S.L.U
Ctra. De Villaverde a Vallecás, 265 1º Dcha Ed.
Hormigueras – P.I. de Vallecás 28031 Madrid
TEL: +34(0)91 223 74 20

Carrer Llacuna 166, 08018 Barcelona, Spain
Mail: Sales.IA.Iberia@deltaww.com

Italy: Delta Electronics (Italy) S.r.l.
Via Meda 2-22060 Novedrate(CO)
Piazza Grazioli 18 00186 Roma Italy
Mail: Sales.IA.Italy@deltaww.com
TEL: +39 039 8900365

Russia: Delta Energy System LLC
Verenskaya Plaza II, office 112 Verenskaya str.
17 121357 Moscow Russia
Mail: Sales.IA.RU@deltaww.com
TEL: +7 495 644 3240

Turkey: Delta Greentech Elektronik San. Ltd. Sti. (Turkey)
Şerifali Mah. Hendem Cad. Kule Sok. No:16-A
34775 Ümraniye – İstanbul
Mail: Sales.IA.Turkey@deltaww.com
TEL: + 90 216 499 9910

MEA: Eltek Dubai (Eltek MEA DMCC)
OFFICE 2504, 25th Floor, Saba Tower 1,
Jumeirah Lakes Towers, Dubai, UAE
Mail: Sales.IA.MEA@deltaww.com
TEL: +971(0)4 2690148

AS Series Hardware and Operation Manual



Digitized Automation for a Changing World

AS Series Hardware and Operation Manual

AS Series Hardware and Operation Manual

Revision History

Version	Revision	Date
1 st	The first version was published.	2016/11/30
2 nd	<ol style="list-style-type: none"> 1.Added new models AS08AD-B, AS08AD-C and UB-10-IO32D product information. 2.Updated module weights. 3.Updated Emergency Request Message information 	2018/02/09
3 rd	1.Chapter 2: Specification Corrections	2018/03/22
4 th	<ol style="list-style-type: none"> 1.Updated new models AS08AD-B/C, AS02/04PU-A, AS320T/P-B, AS300N-A, AS228R/T/P-A, AS218RX/TX/PX-A, AS06RTD-A, AS08TC-A, AS-FEN02 and AS01DNET-A product information 2.Chapter 9: Updated operation and monitor on the webpage in section 9.10 3.Chapter 10: Updated AS200 series information 	2018/09/25
5 th	<ol style="list-style-type: none"> 1.Updated digital output specifications in section 1.1.2. 2.Added specification of ambient air temperature-barometric pressure-altitude in section 2.1. 3.Added specifications of program capacity (step) and Ethernet in section 2.2.1. 4.Added specifications of input impedance and leakage current in section 2.2.2. 5.Added specifications of digital conversion range and update input impedance for 04DA/06XA. 6.Added a note for the function specification in section 2.5.1. 7.Updated specifications of input impedance in section 2.9.1. 8.Updated the cable specification image in section 4.2.1. 9.Updated the contents of initializing a memory card in section 7.4.1 and added root directory of the memory card in sections 7.6, 7.8 and 7.9. 10.Added an example of Daylight Saving Timing in section 8.2.2.1. 11.Added specification for AS-FEN02 in section 9.3.1 and 9.3.2. 12.Updated EIP Scanner/Adapter and data mapping information, EIP Builder operations in section 9.4. 13.Updated assembly object, TCP/IP interface object and Ethernet link object in section 9.8. 14.Added new EIP products in the EIP product list in section 9.9. 15.Updated operation and monitor on the web information in section 9.10. 16.Added AS200 series descriptions as well as application examples and updated CANopen introduction as well 	2019/1/11

Version	Revision	Date
	<p>as troubleshooting.</p> <p>17.Added descriptions on the Error LED Indicators in section 12.3.1 and 12.3.2.</p> <p>18.Added a new chapter, chapter 13 for Data Tracer and Data Logger.</p> <p>19.Updated the list of Function Codes and Number of Devices Supported for Modbus Protocols in section B.2.</p>	
6 th	<p>1. Manual corrections in the response time of electrical specification for the inputs on AS300 series in section 2.2.2.</p>	2019/06/04
7 th	<p>1. Added information of new products AS02PU-A, AS04PU-A, AS02HC-A, AS04SIL-A, and AS-FPFN02.</p> <p>2. Added AS200 analog input/output information in section 2.2.5.</p> <p>3. Updated electrical specification (24 VDC) for IO module in section 2.3.</p> <p>4. Updated A/D functional specification for AS04AD-A, AS08AD-B, AS08AD-C and AS06XA-A in section 2.4.1.</p> <p>5. Added electrical specification and parameter settings for AS02PU-A and AS04PU-A in section 2.6.</p> <p>6. Added specification for AS02HC-A in section 2.7.</p> <p>7. Added specification for AS04SIL-A in section 2.8.</p> <p>8. Updated specification for AS-F2AD, AS-F2DA and AS-FPFN02 in section 2.10.</p> <p>9. Added descriptions for SM204 and SM204 in section 5.1.3.</p> <p>10.Updated device register range in section 5.1.4.</p> <p>11.Added device function description for AS02HC-A in section 5.2.11.</p> <p>12.Updated data register description in section 5.2.12.</p> <p>13.Updated software setting description “Options - System Information Page” in section 8.2.2.1.</p> <p>14.Updated Send and Receive Length in section 8.2.2.4.</p> <p>15.Updated description of “Options - Function Card 2 Setting” in section 8.2.2.6.</p> <p>16.Updated HWCONFIG image for AS Series CPU module in section 8.2.3.</p> <p>17.Updated description of “Options - Function Card 2 Setting” in section 8.3.1.</p> <p>18.Added AS-FPFN02 product information and updated socket information in section 9.3.</p> <p>19.Updated operational description for EIP Builder in section 9.4.</p> <p>20.Added AS-FPFN02 product information in section 9.6.</p> <p>21.Added instance attribute and object examples in section 9.8.5.</p> <p>22.Added object examples in section 9.8.8.</p> <p>23.Added data type for instance 1 in section 9.8.12.</p> <p>24.Added new product information AHCPU501-EN and</p>	2019/12/20

Version	Revision	Date
	<p>AHCPU560-EN2 in section 9.9.</p> <p>25.Updated SR829 information in section 10.5.1.</p> <p>26.Added descriptions of SM5=ON and SM0=ON in section 12.1.4.</p> <p>27.Updated error codes 16#0102, 16#0202, 16#0302, 16#0D03, 16#0E05, and 16#200A in section 12.2.2.</p> <p>28.Added error codes 16#19B0-16#19FC and updated 16#2001, 16#2003, 16#300B-200E, 16#2012-2014, 16#2017, 16#2027-2031 in section 12.2.9.</p> <p>29.Added troubleshooting information for AS02PU-A, AS04PU-A, AS02HC-A, and AS04SIL-A in section 12.3.2, 12.3.3 and 12.3.5.</p> <p>30.Added error codes 16#1500 and16#1505 in section 12.3.7.2.</p> <p>31.Updated error code #162003 and added 16#2030 and16#2031 and added information for AS02PU-A, AS04PU-A, AS02HC-A, and AS04SIL-A in section 12.4.</p>	
8 th	<ol style="list-style-type: none"> 1. Updated power supply information on all CPU Series, added new product information, AS100 Series and AS-FOPC02, updated model description on Positioning Modules, Counter Modules, AS-FEN02, and AS-FPFN02 in section 1.1.2. 2. Added the durability information in general specification in section 2.1. 3. Updated electrical input insulation information in section 2.2.2, 2.3.1, and 2.7.1. 4. Updated the Software filter time setting range in section 2.31. 5. Updated the general specification on Positioning Module in section 2.6.1. 6. Updated the general specification on Counter Module in section 2.7.1. 7. Updated the general specification of the Ethernet Communication Interface on Network Module in section 2.8.1. 8. Updated the descriptions of the Error LED Indicator, function card slots 1&2 and mode switch for AS00SCM-A in section 2.8.2. 9. Added information of Ethernet Communication Interface for AS-FEN02 and AS-FPFN02 in section 2.10.1. 10.Added a description for the example of 16-bit counters in section 5.2.10. 11.Added a description for the example of 32-bit counters in section 5.2.11. 12.Added a description for data register range in section 5.2.12. 13.Added a notice in section 8.1. 14.Added a device range table for modules in section 8.1.2.2. 15.Updated the image and description in point 5 in section 8.2.2.2. 	2020/07/07

Version	Revision	Date
	<p>16.Updated the EtherNet/IP specification table in section 9.3.2.</p> <p>17.Updated PROFINET specification in section 9.3.3.</p> <p>18.Update a number in AS300 Series PLC master register in section 10.6.</p> <p>19.Added a new description in section 12.2.8.</p> <p>20.Updated the table of ERROR LED Indicators Are ON in section 12.3.3.1.</p> <p>21.Added two new error codes in section 12.3.5.2.</p>	
g th	<p>1.AS Series Hardware Manual and AS Series Operation Manual are combined into AS Series Hardware and Operation Manual to enhance more concise reading experiences.</p> <p>2.Added new product information, AS-PS03C, AS-ATXB, AS-FOPC02, AS100 and added power input specifications for AS300 and AS200 series. Updated specifications on AS02PU-A, AS04PU-A, AS02HC-A, AS-FEN02, and AS-FPFN02.</p> <p>3.Added contents from Chapter 3 of AS Series Hardware Manual in Chapter 2.</p> <p>4.Added contents from Chapter 2 and 5 of AS Series Hardware Manual in Chapter 4.</p> <p>5.Added contents from Chapter 4 of AS Series Hardware Manual in Chapter 5.</p> <p>6.Updated HWCONFIG 4.0 operation images in Chapter 8.</p> <p>7.Added section 9.2.3 Network Communication Parameter Setting. Updated maximum connection quantity for Client and Server in Modbus TCP specification in 9.3.1. Updated PROFINET specification in section 9.3.3. Updated TAG description in section 9.5.2. Updated Delta EIP Products in section 9.9.</p> <p>8.Added section 10.1.3 Refreshing Mechanism in the Input/Output Mapping Area and updated HWCONFIG 4.0 operation images in Chapter 10.</p> <p>9.Added Execution Timing of Interrupts in section 11.1.3.</p> <p>10.Updated 12.2.8 Status and Operation under Different Operating Modes, and troubleshooting sections in 12.3.3 High-Speed Counter Module AS02HC, 12.3.4 Load Cell Module AS02LC, 12.3.5 the Module AS04SIL as a Communication Module and 12.3.6 Module AS00SCM as a Communication Module.</p> <p>11.Added Delta Drive Parameters Backup and Restore in section 13.3.</p> <p>12.Added Appendix C to introduce EMC Standards and Appendix D to illustrate Maintenance and Inspection.</p>	2021/2/5

Version	Revision	Date
10 th	1. Manual correction in Chapter 1.3 presentation.	20210225
11 th	<ol style="list-style-type: none"> 1. Chapter 1: Deleted product information AS-PS03C. Added product information including AS02ADH-A and AS-FFTP01. Updated conversion times for I/O modules and sensor types for temperature measurement modules. 2. Chapter 2: Added new product information including AS100 series PLC CPU, AS02ADH-A, and AS-FFTP01. Added the information of maximum inrush current in the specification. Updated conversion times for I/O modules and sensor types for temperature measurement modules. 3. Chapter 4: Added new product information including AS100 series PLC CPU, AS02ADH-A, and AS-FFTP01. Updated wiring information for positioning modules, counter modules and temperature measurement modules. 4. Chapter 5: Changed the stepping relays to relays. 5. Chapter 7: Added new product information AS100 series PLC CPU. 6. Chapter 8: Updated contents of Select Action When 24Vdc Input Unstable, AS Remote Module Updated Method and I601 to I604 Timer Interrupt Setting Time Base in section 8.2.2. 7. Chapter 9: Changed EIP Builder operation procedures to HWCONFIG's. Added a note that Array-typed tags are NOT supported in explicit messages in section 9.3.2. Updated operation procedures and added demonstrations of EIP Tag deployment in section 9.4, removed the 3rd party product software images in section 9.7, added Network Security section in section 9.10 and added a web operation restriction in section 9.11.1. 8. Chapter 10: Added new product information AS100 series PLC CPU. Updated non-synchronous mode information in section 10.1.3. Added product information including AS100 Series PLC CPU and DVP-ES3 Series PLC CPU. 9. Chapter 11: Updated the contents of Execution Timing of Interrupts in section 11.1.3. 10. Chapter: Updated the content and the solution for error code 16#1807 in section 12.3.4.2. Added error codes 16#1980 to 16#19FC and 16#C000 to 16#CFFF in sections 12.4. Added a new error LED indicator for "When power-on, the module is not detected by CPU" 	20220112

Version	Revision	Date
	<p>module.” in section 12.4.5.</p> <p>11. Chapter 13: Added new product information AS100 series PLC CPU.</p> <p>12. Appendix B: Added new product information AS100 series PLC CPU.</p>	
12 th	<p>1. Added information about DIADesigner software and new function card AS-FECAT in every chapter.</p> <p>2. Chapter 2: Added information for specifications of UL 94 Flame Classifications in section 2.1. Updated information for specification of resolution in section 2.5. Updated information for connector types specification of AS00SCM-A and filtering time for AS04SIL-A in section 2.8.1. Updated information for extreme pulse value range and averaging weights of AS02LC-A in section 2.9.1. Updated the extension card profiles in section 2.10.2.</p> <p>3. Chapter 9: Deleted software images from 3rd party manufacturers.</p> <p>4. Chapter 12: Added the following error codes, 16#000D, 16#0020, 16#0021, 16#0028, 16#0040-16#0047, 16#1000-10FF, and 16#140C.</p>	2022/05/30

AS Series Hardware and Operation Manual

Table of Contents

Chapter 1 Product Introduction

1.1 Overview	1-2
1.1.1 Related Manuals	1-2
1.1.2 Models Descriptions.....	1-2
1.2 Overview	1-13
1.3 Characteristics.....	1-14

Chapter 2 Specifications and System Configuration

2.1 General Specifications	2-3
2.2 CPU Module Specifications.....	2-4
2.2.1 Functional specifications.....	2-4
2.2.2 Electrical specifications	2-5
2.2.3 CPU Module Profiles.....	2-12
2.2.4 CPU Module Input/Output Terminals	2-18
2.2.5 AS200 Input/Output Terminals	2-23
2.3 Digital Input/Output Module Specifications	2-24
2.3.1 General Specifications	2-24
2.3.2 Digital Input/Output Module Profiles	2-27
2.3.3 Digital Input/Output Module Terminals.....	2-36
2.4 Analog Input/Output Module Specifications	2-43
2.4.1 General Specifications	2-43
2.4.2 Analog Input/Output Module Profiles.....	2-51
2.4.3 Analog Input/Output Terminals	2-52
2.5 Temperature Measurement Modules Specifications	2-53
2.5.1 General Specifications	2-53
2.5.2 Temperature Measurement Module Profiles	2-56
2.5.3 Temperature Measurement Module Dimensions	2-58
2.6 Positioning Module Specifications.....	2-59
2.6.1 General Specifications	2-59

2.6.2	Positioning Module Profiles	2-61
2.6.3	Positioning Module Terminals	2-62
2.7	Counter Module Specifications	2-63
2.7.1	General Specifications	2-63
2.7.2	Counting Module Profiles.....	2-66
2.7.3	Counting Module Terminals	2-67
2.8	Network Module Specifications	2-68
2.8.1	General Specifications	2-68
2.8.2	Network Module Profiles	2-72
2.9	Load Cell Module Specifications.....	2-76
2.9.1	General Specifications	2-76
2.9.2	Load Cell Module Profiles	2-77
2.9.3	Load Cell Module Dimensions	2-78
2.10	Extension Card Specifications.....	2-79
2.10.1	General Specifications	2-79
2.10.2	Extension Card Profiles	2-84
2.10.3	Function Card Weights	2-89
2.11	Power Supply Module Specifications	2-90
2.11.1	General Specifications	2-90
2.11.2	Power Supply Module Profiles	2-91
2.12	Power Supply Module Adapter Specification.....	2-92

Chapter 3 Installing Software

3.1	Installing and Uninstalling ISPSOft	3-2
3.1.1	Installing ISPSOft.....	3-2
3.1.2	Uninstalling ISPSOft	3-9
3.2	Installing and Uninstalling COMMGR	3-9
3.2.1	Installing COMMGR	3-10
3.2.2	Uninstalling COMMGR.....	3-13

Chapter 4 Installing Hardware and Wiring

4.1	AS Series Hardware Framework	4-4
4.1.1	AS Series Hardware Component	4-4
4.2	Installation Notes	4-7
4.3	Installation	4-8
4.3.1	Installing Modules in a Control Box	4-8
4.3.2	Installing a Module	4-9
4.3.3	Installing a Removable Terminal Block	4-11
4.3.4	Changing a Module	4-13
4.3.5	Installing and Removing an Extension Card for AS300 PLC CPU	4-13
4.3.6	Installing and Removing a Wiring Module for AS300 PLC CPU	4-15
4.4	Wiring	4-16
4.5	Connecting Power Cables	4-18
4.5.1	Power Cable Wiring Notes	4-18
4.5.2	Ground	4-19
4.5.3	Wiring Power Supply	4-19
4.5.4	Power Consumption	4-21
4.6	Wiring CPU Modules	4-23
4.6.1	Wiring AS324MT-A	4-24
4.6.2	Wiring AS332P-A	4-27
4.6.3	Wiring AS332T-A	4-29
4.6.4	Wiring AS320P-B	4-31
4.6.5	Wiring AS320T-B	4-32
4.6.6	Wiring AS228P-A	4-33
4.6.7	Wiring AS228R-A	4-34
4.6.8	Wiring AS228T-A	4-35
4.6.9	Wiring AS218PX-A / AS218RX-A / AS218TX-A	4-36
4.6.10	Wiring AS132T-A/AS148T-A/AS164T-A	4-40
4.6.11	Wiring AS132P-A/AS148P-A/AS164P-A	4-41
4.6.12	Wiring AS132R-A/AS148R-A/AS164R-A	4-42
4.6.13	Wiring AS Series PLC CPU Communication Ports	4-43
4.7	Wiring Digital Input/Output Modules	4-47
4.7.1	Wiring AS08AM10N-A	4-47
4.7.2	Wiring AS08AN01P-A	4-48
4.7.3	Wiring AS08AN01R-A	4-49
4.7.4	Wiring AS08AN01T-A	4-50
4.7.5	Wiring AS16AM10N-A	4-51
4.7.6	Wiring AS16AN01R-A	4-52
4.7.7	Wiring AS16AN01T-A	4-53

4.7.8	Wiring AS16AN01P-A	4-54
4.7.9	Wiring AS16AP11R-A.....	4-55
4.7.10	Wiring AS16AP11T-A.....	4-56
4.7.11	Wiring AS16AP11P-A.....	4-57
4.7.12	Wiring AS32AM10N-A.....	4-58
4.7.13	Wiring AS32AN02T-A.....	4-60
4.7.14	Wiring AS64AM10N-A.....	4-63
4.7.15	Wiring AS64AN02T-A.....	4-65
4.8	Wiring Digital Input/Output Terminals	4-68
4.8.1	Wiring Digital Input Terminals.....	4-68
4.8.2	Wiring Digital Output Terminals	4-72
4.9	Wiring Analog Input/Output Modules	4-76
4.9.1	Wiring AS04AD-A.....	4-76
4.9.2	Wiring AS08AD-B	4-77
4.9.3	Wiring AS08AD-C	4-78
4.9.4	Wiring AS04DA-A.....	4-79
4.9.5	Wiring AS06XA-A.....	4-80
4.9.6	Wiring AS02ADH-A	4-82
4.10	Wiring Temperature Measurement Modules	4-86
4.10.1	Wiring AS04RTD-A.....	4-86
4.10.2	Wiring AS06RTD-A.....	4-87
4.10.3	Wiring AS04TC-A / AS08TC-A	4-88
4.11	Wiring Positioning Modules and Counter Modules	4-89
4.11.1	Wiring AS02PU-A.....	4-89
4.11.2	Wiring AS04PU-A.....	4-90
4.11.3	Wiring AS02HC-A.....	4-91
4.12	Load Cell Modules.....	4-94
4.12.1	Wiring AS02LC-A	4-94
4.13	Wiring Network Modules	4-95
4.13.1	AS00SCM-A	4-95
4.13.2	Wiring AS00SCM-A	4-95
4.13.3	AS01DNET-A.....	4-96
4.13.4	Wiring AS01DNET-A	4-97
4.13.5	AS04SIL-A	4-98
4.13.6	Wiring AS04SIL-A	4-98
4.14	Wiring Function Cards	4-101
4.14.1	Communicational Function Card Profiles and the Pin Definitions.....	4-101
4.14.2	Wiring the Communicational Function Cards	4-102
4.14.3	Analog Function Card Profiles and the Pin Definitions	4-105

4.14.4	Wiring AS-F2AD	4-106
4.14.5	Wiring AS-F2DA	4-107

Chapter 5 Devices

5.1	Introduction of Devices	5-2
5.1.1	Device Table	5-2
5.1.2	Basic Structure of I/O Storages.....	5-3
5.1.3	Relation Between the PLC Action and the Device Type.....	5-4
5.1.4	Latched Areas in the Device Range.....	5-5
5.2	Device Functions	5-6
5.2.1	Values and Constants	5-6
5.2.2	Floating-point Numbers.....	5-9
5.2.3	Strings	5-11
5.2.4	Input Relays (X)	5-12
5.2.5	Output Relays (Y)	5-13
5.2.6	Auxiliary Relays (M)	5-13
5.2.7	Special Auxiliary Relays (SM).....	5-13
5.2.8	Stepping Relays (S)	5-14
5.2.9	Timers (T)	5-14
5.2.10	16-bit Counters	5-16
5.2.11	32-bit Counters (HC)	5-18
5.2.12	Data Registers (D)	5-20
5.2.13	Special Data Registers (SR).....	5-21
5.2.14	Index Register (E).....	5-21
5.2.15	File Registers (FR).....	5-21
5.3	Assigning I/O Addresses for Modules.....	5-22
5.4	Module Addresses Defined by Software	5-23
5.4.1	Starting Addresses for Digital Input/Output Modules	5-23
5.4.2	Starting Addresses for Analog Input/Output Modules.....	5-24
5.4.3	Starting Addresses for Temperature Measurement Modules.....	5-25
5.4.4	Starting Addresses for Positioning/Counter Modules.....	5-25
5.4.5	Starting Addresses for Network Modules.....	5-26
5.4.6	Starting Addresses for Load Cell Modules	5-27
5.5	Remote Module Addresses Defined by Software	5-28
5.5.1	Starting Addresses for Digital Input/Output Modules	5-31
5.5.2	Starting Addresses for Analog Input/Output Modules.....	5-32

- 5.5.3 Starting Addresses for Temperature Measurement Modules5-33
- 5.5.4 Starting Addresses for Load Cell Modules5-33
- 5.5.5 Starting Addresses for AS04SIL-A Modules5-34

Chapter 6 Writing a Program

- 6.1 Quick Start 6-2**
 - 6.1.1 Example 6-2
 - 6.1.2 Hardware 6-2
 - 6.1.3 Program 6-3
- 6.2 Procedure for Creating a Project in ISPSoft..... 6-4**
- 6.3 Creating a Project..... 6-5**
- 6.4 Hardware Configuration 6-6**
- 6.5 Creating a Program 6-7**
 - 6.5.1 Adding a Ladder Diagram 6-7
 - 6.5.2 Basic Editing – Creating a Contact and a Coil 6-9
 - 6.5.3 Basic Editing – Inserting a Network and Typing an Instruction.....6-12
 - 6.5.4 Basic Editing – Selecting a Network and Operation6-14
 - 6.5.5 Basic Editing – Connecting a Contact in Parallel.....6-17
 - 6.5.6 Basic Editing – Editing a Comment6-18
 - 6.5.7 Basic Editing – Inserting an Applied Instruction.....6-19
 - 6.5.8 Basic Editing – Creating a Comparison Contact and Typing a Constant6-21
 - 6.5.9 Writing a Program6-22
 - 6.5.10 Checking and Compiling a Program6-23
- 6.6 Testing and Debugging a Program 6-24**
 - 6.6.1 Creating a Connection6-24
 - 6.6.2 Downloading a Program and Parameters6-27
 - 6.6.3 Connection Test6-29
- 6.7 Setting a Real-time Clock 6-37**

Chapter 7 Memory Card

7.1	Overview of Memory Cards	7-2
7.1.1	Appearances of Memory Cards	7-2
7.1.2	Memory Card Specifications.....	7-2
7.2	Before using a Memory Card	7-3
7.2.1	Formatting a Memory Card	7-3
7.3	Installing and Removing a Memory Card	7-4
7.3.1	Memory Card Slot in a CPU Module.....	7-4
7.3.2	Installing a Memory Card	7-4
7.3.3	Removing a Memory Card	7-4
7.4	Memory Card Contents	7-5
7.4.1	Initializing a Memory Card.....	7-5
7.4.2	Folder Structure in a Memory Card	7-5
7.5	Introduction to the CARD Utility	7-7
7.6	Backing Up a Project	7-10
7.7	Restoring a Project	7-15
7.8	Restoration Starts Once CPU is supplied with Power	7-19
7.9	CPU Error Log	7-20

Chapter 8 Hardware Configuration and Data Exchange Setups

8.1	Hardware Configuration Tool for AS Series Modules - HWCONFIG	8-2
8.1.1	Introduction of the HWCONFIG Environment	8-2
8.1.2	Configuring a Module.....	8-4
8.2	Setting the Parameters in an AS Series CPU Module	8-23
8.2.1	System Settings – System Information	8-23
8.2.2	System Settings – System Parameter	8-24
8.2.3	System Settings – Device Range Setting	8-30
8.2.4	System Settings – Input Point Filter Time	8-31
8.2.5	System Settings – Position Control Parameter	8-32
8.2.6	System Settings – Daylight Saving Timing.....	8-33
8.2.7	Options - COM1 Port Setting & COM2 Port Setting.....	8-34
8.2.8	Options - Ethernet Port Basic Setting	8-35
8.2.9	Ethernet Port Advance Setting – IP Filter	8-36
8.2.10	Ethernet Port Advance Setting – NTP.....	8-36
8.2.11	Ethernet Port Advance Setting – Email	8-37

8.2.12 Ethernet Port Advance Setting – Socket	8-41
8.2.13 Ethernet Port Advance Setting – RTU Mapping.....	8-43
8.2.14 Function Card 1 Setting	8-44
8.2.15 Function Card 2 Setting	8-45
8.2.16 Data Exchange	8-48

Chapter 9 EtherNet/IP Specification and Operation

9.1 Introduction	9-3
9.1.1 Section Overview.....	9-3
9.1.2 EtherNet/IP	9-3
9.1.3 Definitions of Common Network Terms.....	9-3
9.1.4 Ethernet Features	9-4
9.2 Installation.....	9-6
9.2.1 EtherNet/IP Device	9-6
9.2.2 Network Cable Installation	9-6
9.2.3 Network Communication Parameter Setting.....	9-9
9.3 Specifications	9-10
9.3.1 Ethernet Specification	9-10
9.3.2 EtherNet/IP Specification	9-12
9.3.3 PROFINET Specification	9-14
9.3.4 EtherNet Communication Port.....	9-15
9.4 EtherNet/IP Software.....	9-16
9.4.1 Run HWCONFIG via an Ethernet/IP Scanner	9-16
9.4.2 Set up the IP Address	9-19
9.4.3 Network	9-24
9.4.4 Add New Devices.....	9-27
9.4.5 Data Exchange – Implicit Message	9-32
9.4.6 EtherNet/IP Tags	9-43
9.4.7 Diagnosis	9-47
9.5 Explicit Message.....	9-49
9.6 Troubleshooting	9-49
9.6.1 Error Code Classification.....	9-49
9.6.2 Error Codes & How to fix them	9-50
9.6.3 AS-FPFN02 Error Codes & How to fix them	9-53
9.7 Software Operation	9-54
9.7.1 Operation Demonstration I	9-54
9.7.2 Operation Demonstration II.....	9-57

9.8	CIP Object	9-69
9.8.1	Object List	9-69
9.8.2	Data Type	9-71
9.8.3	Identity Object (Class ID: 01 Hex)	9-74
9.8.4	Message Router Object (Class ID: 02 Hex)	9-77
9.8.5	Assembly Object (Class ID: 04 Hex)	9-78
9.8.6	Connection Manager Object (Class ID: 06 Hex)	9-82
9.8.7	Port Object (Class ID: F4 Hex)	9-84
9.8.8	TCP/IP Interface Object (Class ID: F5 Hex)	9-86
9.8.9	Ethernet Link Object (Class ID: F6 Hex)	9-90
9.8.10	X Register (Class ID: 350 Hex).....	9-93
9.8.11	Y Register (Class ID: 351 Hex).....	9-94
9.8.12	D Register (Class ID: 352 Hex)	9-95
9.8.13	M Register (Class ID: 353 Hex)	9-96
9.8.14	S Register (Class ID: 354 Hex).....	9-97
9.8.15	T Register (Class ID: 355 Hex).....	9-98
9.8.16	C Register (Class ID: 356 Hex).....	9-99
9.8.17	HC Register (Class ID: 357 Hex)	9-100
9.8.18	SM Register (Class ID: 358 Hex)	9-101
9.8.19	SR Register (Class ID: 359 Hex).....	9-102
9.9	Delta EIP Product List	9-103
9.9.1	Delta EIP Products	9-103
9.9.2	Delta EIP Products, DLR (Device Level Ring) supported	9-103
9.9.3	Delta EIP Products, Scanner supported	9-104
9.10	Network Security	9-104
9.11	Operation and Monitor on the Web	9-105
9.11.1	Getting Started.....	9-105
9.11.2	Device Information.....	9-109
9.11.3	Network configuration.....	9-110
9.11.4	Data Monitoring.....	9-113
9.11.5	Diagnostic.....	9-118
9.11.6	Configurations	9-120

Chapter 10 CANopen Function and Operation

10.1 Introduction to CANopen	10-2
10.1.1 CANopen Function Descriptions.....	10-2
10.1.2 The Input/Output Mapping Areas	10-4
10.1.3 Refreshing Mechanism in the Input/Output Mapping Areas.....	10-5
10.2 Installation and Network Topology	10-9
10.2.1 The Dimensions of AS-FCOPM.....	10-9
10.2.2 AS-FCOPM on AS300 PLC	10-9
10.2.3 Configure the AS-FCOPM with HWCONFIG	10-10
10.2.4 The CAN Interface and Network Topology.....	10-11
10.3 The CANopen Protocol	10-16
10.3.1 Introduction to the CANopen Protocol	10-16
10.3.2 The CANopen Communication Object.....	10-17
10.3.3 The Predefined Connection Set	10-22
10.4 Sending SDO, NMT and Reading Emergency Message through the Ladder Diagram	10-24
10.4.1 Data Structure of SDO Request Message.....	10-24
10.4.2 Data Structure of NMT Message.....	10-27
10.4.3 Data Structure of EMERGENCY Request Message.....	10-28
10.4.4 Example of Sending SDO through the Ladder Diagram	10-30
10.5 Troubleshooting	10-32
10.5.1 CANopen Network Node State Display	10-32
10.6 Application Example	10-35
10.7 Object Dictionary	10-43

Chapter 11 CPU Module Operating Principles

11.1 CPU Module Operations	11-2
11.1.1 Procedure.....	11-2
11.1.2 I/O Refreshing and Communication Service	11-3
11.1.3 Interrupts.....	11-3
11.2 CPU Module Operating Modes	11-4
11.2.1 Operating Modes	11-4
11.2.2 Status and Operation under Different Operating Modes	11-4

Chapter 12 Troubleshooting

12.1 Troubleshooting	12-3
12.1.1 Basic troubleshooting steps	12-3
12.1.2 Clear the Error States	12-3
12.1.3 Troubleshooting SOP	12-4
12.1.4 Viewing System Log and Error Step	12-5
12.2 Troubleshooting for CPU Modules	12-7
12.2.1 ERROR LED Indicators Are ON	12-7
12.2.2 ERROR LED Indicators Blinking Every 0.5 Seconds	12-7
12.2.3 ERROR LED Indicators Blinking Rapidly Every 0.2 Seconds	12-9
12.2.4 ERROR LED Indicators Slow Blinking Every 3 Seconds and Lighting up for 1 Second	12-9
12.2.5 BAT. LOW LED Indicators Are ON	12-10
12.2.6 BAT. LOW LED Indicators Blinking Every 0.5 Seconds	12-10
12.2.7 The LED RUN and ERROR Indicators are Blinking Simultaneously Every 0.5 Seconds	12-11
12.2.8 The RUN and LED Indicators are Blinking One After Another Every 0.5 Seconds.	12-11
12.2.9 Other Errors (Without LED Indicators)	12-11
12.3 Troubleshooting for I/O Modules	12-19
12.3.1 Troubleshooting for Analog Modules (AD/DA/XA) and Temperature Modules (RTD/TC)	12-19
12.3.2 Troubleshooting for the Positioning Module AS02/04PU	12-20
12.3.3 Troubleshooting for the High-Speed Counter Module AS02HC	12-20
12.3.4 Troubleshooting for the Load Cell Module AS02LC	12-21
12.3.5 Troubleshooting for the Module AS04SIL IO-Link as a Communication Module	12-22
12.3.6 Troubleshooting for the Module AS00SCM as a Communication Module	12-25
12.3.7 Troubleshooting for the Module AS00SCM as a Remote Module	12-26
12.3.8 Troubleshooting for AS01DNET Modules	12-27
12.4 Error Codes and LED Indicators for CPU Modules	12-28
12.4.1 Error Codes and LED Indicators for CPU Modules	12-28
12.4.2 Error Codes and LED Indicators for Analog/Temperature Modules	12-36
12.4.3 Error Codes and LED Indicators for Positioning Module AS02 / 04PU	12-36
12.4.4 Error Codes and LED Indicators for High Speed Counter Module AS02HC	12-37
12.4.5 Error Codes and LED Indicators for Load Cell Module AS02LC	12-37
12.4.6 Error Codes and LED Indicators for Module AS04SIL IO-Link as	

a Communication Module	12-38
12.4.7 Error Codes and LED Indicators for Module AS00SCM as a Communication Module	12-39
12.4.8 Error Codes and LED Indicators for Module AS00SCM as a Remote Module.....	12-39
12.4.9 Error Codes and LED Indicators for Module AS01DNET (Master/Slave Mode).....	12-39
12.4.10 Error Codes and LED Indicators for Module AS01DNET (RTU Mode)	12-41

Chapter 13 Data Tracer and Data Logger

13.1 Data Tracer.....	13-2
13.1.1 About Data Tracer	13-2
13.1.2 Example.....	13-4
13.2 Data Logger.....	13-5
13.2.1 About Data Logger.....	13-5
13.2.2 Related SM Flags and SR Registers.....	13-7
13.3 Delta Drive Parameters Backup and Restore	13-8
13.3.1 System Requirement.....	13-8
13.3.2 The Architecture Overview for Backup and Restore	13-8
13.3.3 Steps to Backup Delta Device Parameters	13-9
13.3.4 Steps to Restore Delta Device Parameters.....	13-12
13.3.5 FAQ.....	13-17

Appendix A Installing a USB Driver

A.1 Installing the USB Driver for an AS Series CPU module in Windows XP with SP3	A-2
A.2 Installing the USB Driver for an AS Series CPU module in Windows 7 ...	A-6
A.3 Installing the USB Driver for an AS Series CPU module in Windows 8 .	A-11
A.4 Installing the USB Driver for an AS Series CPU module in Windows 10	A-13
A.5 Notes on Utilizing USB Communication	A-16

Appendix B Device Addresses

B.1 Standard Modbus Device AddressesB-2
B.2 Function Codes and Number of Devices Supported for Modbus ProtocolsB-3

Appendix C EMC Standards

C.1 EMC Standards for an AS Series SystemC-2
C.1.1 AS Series System EMC Standards.....C-2
C.1.2 Installation Instructions to meet EMC Standards.....C-4
C.1.3 Cables.....C-5

Appendix D Maintenance and Inspection

D.1 Cautions D-2
D.2 Daily Maintenance D-3
D.2.1 Required Inspection Tools.....D-3
D.2.2 Daily InspectionD-3
D.3 Periodic Maintenance D-4
D3.1 Required Inspection Tools.....D-4
D.3.2 Periodic InspectionD-5

*** All the Windows screenshots are used with permission from Microsoft.**

Chapter 1 Product Introduction

Table of Contents

1.1	Overview	1-2
1.1.1	Related Manuals	1-2
1.1.2	Models Descriptions.....	1-2
1.2	Overview	1-13
1.3	Characteristics.....	1-14

1.1 Overview

This manual introduces the AS Series PLC CPU functions, devices, module tables, basic instructions, applied instructions, electrical specifications troubleshooting, as well as appearances, dimensions, and so forth.

1.1.1 Related Manuals

The related manuals for AS Series programmable logic controllers are listed below.

- AS Series Quick Start
This guides you in how to use the system before reading the related manuals.
- AS Series Programming Manual
This introduces programming for the AS Series programmable logic controllers, basic instructions, and applied instructions.
- ISPSOft / DIADesigner User Manual
This introduces the use of the ISPSOft and DIADesigner software, programming language (Ladder, IL, SFC, FBD, and ST), POU's, and tasks.
- AS Series Hardware and Operation Manual
This introduces electrical specifications, appearances, dimensions, CPU functions, devices, module tables, troubleshooting, and so forth.
- AS Series Module Manual
This introduces special I/O modules such as network modules, analog I/O modules, temperature measurement modules, motion control modules, and so forth.

1.1.2 Models Descriptions

Classification	Model Name	Description
Power supply module	AS-PS02	Input: 100-240 VAC, 50/60 Hz Output: 24VDC/2A, 48W (for PLC internal use)
	AS-PS02A	Input: 100-240 VAC, 50/60 Hz Output: 24VDC/1.5A, 36W (for PLC internal use) Output: 24VDC/0.5A, 12W (for external use)
AS CPU power module adaptor	AS-ATXB	For easier wiring, this adaptor allows wiring on the bottom of the module instead of on the left-side of the module.
AS300 Series CPU module	AS332P-A	CPU module, 24VDC power input, PNP output, 1x Ethernet port, 2x RS-485 ports, 1x USB port, 1x Micro SD interface, 2x function cards (optional), supporting 32 I/Os (16DI+16DO) and up to 1024 I/Os. Program capacity:128K steps, high-density terminal blocks
	AS332T-A	CPU module, 24VDC power input, NPN output, 1x Ethernet port, 2x RS-485 ports, 1x USB port, 1x Micro SD interface, 2x function cards (optional), supporting 32 I/Os

Classification	Model Name	Description
		(16DI+16DO) and up to 1024 I/Os. Program capacity:128K steps, high-density terminal blocks
	AS324MT-A	CPU module, 24VDC power input, NPN differential output, 1x Ethernet port, 2x RS-485 ports, 1x USB port, 1x Micro SD interface, 2x function cards (optional), supporting 24 I/Os (12DI+12DO) and up to 1016 I/Os. Program capacity:128K steps, high-density terminal blocks
	AS320P-B	CPU module, 24VDC power input, PNP output, 1x Ethernet port , 2x RS-485 ports, 1x USB port, 1x Micro SD interface, 2x function cards (optional), supporting 20 I/Os (8DI+12DO) and up to 1024 I/Os. Program capacity:128K steps, removable terminal blocks
	AS320T-B	CPU module, 24VDC power input, NPN output, 1x Ethernet port, 2x RS-485 ports, 1x USB port, 1x Micro SD interface, 2x function cards (optional), supporting 20 I/Os (8DI+12DO) and up to 1024 I/Os. Program capacity:128K steps, removable terminal blocks
	AS300N-A	CPU module, 24VDC power input, no I/Os, 1x Ethernet port, 2x RS-485 ports, 1x USB port, 1x Micro SD interface, 2x function cards (optional), and supporting up to 1024 I/Os. Program capacity:128K steps
AS200 Series CPU module	AS228P-A	CPU module, 24VDC power input, PNP output, 1x Ethernet port , 2x RS-485 ports, 1x USB port, 1x Micro SD interface, CAN communication port, supporting 28 I/Os (16DI+12DO) and up to 1024 I/Os. Program capacity: 64K steps, removable terminal blocks
	AS228T-A	CPU module, 24VDC power input, NPN output, 1x Ethernet port , 2x RS-485 ports, 1x USB port, 1x Micro SD interface, CAN communication port, supporting 28 I/Os (16DI+12DO) and up to 1024 I/Os. Program capacity: 64K steps, removable terminal blocks
	AS228R-A	CPU module, 24VDC power input, Relay output, 1x Ethernet port , 2x RS-485 ports, 1x USB port, 1x Micro SD interface, CAN communication port, supporting 28 I/Os (16DI+12DO) and up to 1024 I/Os. Program capacity: 64K

1

Classification	Model Name	Description
		steps, removable terminal blocks
	AS218PX-A	CPU module, 24VDC power input, PNP output, 1x Ethernet port , 2x RS-485 ports, 1x USB port, 1x Micro SD interface, CAN communication port, supporting 18 I/Os (8DI+6DO+2AI+2AO) and up to 1024 I/Os. Program capacity: 64K steps, removable terminal blocks
	AS218TX-A	CPU module, 24VDC power input, NPN output, 1x Ethernet port , 2x RS-485 ports, 1x USB port, 1x Micro SD interface, CAN communication port, supporting 18 I/Os (8DI+6DO+2AI+2AO) and up to 1024 I/Os. Program capacity: 64K steps, removable terminal blocks
	AS218RX-A	CPU module, 24VDC power input, Relay output, 1x Ethernet port , 2x RS-485 ports, 1x USB port, 1x Micro SD interface, CAN communication port, supporting 18 I/Os (8DI+6DO+2AI+2AO) and up to 1024 I/Os. Program capacity: 64K steps, removable terminal blocks
AS100 Series CPU module	AS132P-A	CPU module, 100-240VDC power input, PNP output, 1x Ethernet port , 2x RS-485 ports, 1x USB port, 1x Micro SD interface, CAN communication port, supporting 32 I/Os (16DI+16DO) and up to 1024 I/Os. Program capacity: 64K steps, removable terminal blocks
	AS132T-A	CPU module, 100-240VDC power input, NPN output, 1x Ethernet port , 2x RS-485 ports, 1x USB port, 1x Micro SD interface, CAN communication port, supporting 32 I/Os (16DI+16DO) and up to 1024 I/Os. Program capacity: 64K steps, removable terminal blocks
	AS132R-A	CPU module, 100-240VDC power input, Relay output, 1x Ethernet port , 2x RS-485 ports, 1x USB port, 1x Micro SD interface, CAN communication port, supporting 32 I/Os (16DI+16DO) and up to 1024 I/Os. Program capacity: 64K steps, removable terminal blocks
	AS148P-A	CPU module, 100-240VDC power input, PNP output, 1x Ethernet port , 2x RS-485 ports, 1x USB port, 1x Micro SD interface, CAN communication port, supporting 48 I/Os (24DI+24DO) and up to 1024 I/Os. Program capacity: 64K

Classification	Model Name	Description
		steps, removable terminal blocks
	AS148T-A	CPU module, 100-240VDC power input, NPN output, 1x Ethernet port , 2x RS-485 ports, 1x USB port, 1x Micro SD interface, CAN communication port, supporting 48 I/Os (24DI+24DO) and up to 1024 I/Os. Program capacity: 64K steps, removable terminal blocks
	AS148R-A	CPU module, 100-240VDC power input, Relay output, 1x Ethernet port , 2x RS-485 ports, 1x USB port, 1x Micro SD interface, CAN communication port, supporting 48 I/Os (24DI+24DO) and up to 1024 I/Os. Program capacity: 64K steps, removable terminal blocks
	AS164P-A	CPU module, 100-240VDC power input, PNP output, 1x Ethernet port , 2x RS-485 ports, 1x USB port, 1x Micro SD interface, CAN communication port, supporting 64 I/Os (32DI+32DO) and up to 1024 I/Os. Program capacity: 64K steps, removable terminal blocks
	AS164T-A	CPU module, 100-240VDC power input, NPN output, 1x Ethernet port , 2x RS-485 ports, 1x USB port, 1x Micro SD interface, CAN communication port, supporting 64 I/Os (32DI+32DO) and up to 1024 I/Os. Program capacity: 64K steps, removable terminal blocks
	AS164R-A	CPU module, 100-240VDC power input, Relay output, 1x Ethernet port , 2x RS-485 ports, 1x USB port, 1x Micro SD interface, CAN communication port, supporting 64 I/Os (32DI+32DO) and up to 1024 I/Os. Program capacity: 64K steps, removable terminal blocks
Digital input/output module	AS08AM10N-A	24VDC 5mA 8 inputs Spring-clamp terminal block
	AS08AN01P-A	5 - 30VDC 0.5A/output, 4A/COM 8 outputs Sourcing output Spring-clamp terminal block

Classification	Model Name	Description
1	AS08AN01R-A	240VAC/24VDC 2A/output, 8A/COM 8 outputs Relay Spring-clamp terminal block
	AS08AN01T-A	5 - 30VDC 0.5A/output, 4A/COM 8 outputs Sinking output Spring-clamp terminal block
	AS16AM10N-A	24VDC 5mA 16 inputs Spring-clamp terminal block
	AS16AN01P-A	5 - 30VDC 0.5A/output, 4A/COM 16 outputs Sourcing output Spring-clamp terminal block
	AS16AN01R-A	240VAC/24VDC 2A/output, 8A/COM 16 outputs Relay Spring-clamp terminal block
	AS16AN01T-A	5 - 30VDC 0.5A/output, 4A/COM 16 outputs Sinking output Spring-clamp terminal block
	AS16AP11P-A	24VDC 5mA 8 inputs

Classification	Model Name	Description
		5 - 30VDC 0.5A/output, 4A/COM 8 outputs Sourcing output Spring-clamp terminal block
	AS16AP11R-A	24VDC 5mA 8 inputs 240VAC/24VDC 2A/output, 8A/COM 8 outputs Relay Spring-clamp terminal block
	AS16AP11T-A	24VDC 5mA 8 inputs 5 - 30VDC 0.5A/output, 4A/COM 8 outputs Sinking output Spring-clamp terminal block
	AS32AM10N-A	24VDC 3.2mA 32 inputs MIL connector
	AS32AN02T-A	5 - 30VDC 0.1A/output, 3.2A/COM 32 outputs Sinking output MIL connector
	AS64AM10N-A	24VDC 3.2mA

Classification	Model Name	Description
		64 inputs MIL connector
	AS64AN02T-A	5 - 30VDC 0.1A/output, 3.2A/COM 64 outputs Sinking output MIL connector
Analog input/output module	AS04AD-A	4-channel analog input module Hardware resolution: 16 bits 0–10V, 0/1–5V, -5 to +5V, -10 to +10V, 0/4–20mA, -20– +20mA Conversion time: 2 ms/channel; for FW V1.02.00 or later, upgraded to 1 ms/channel
	AS08AD-B	8-channel analog input module Hardware resolution: 16 bits 0 to +10V, 0/1–5V, -5V to +5V, -10V to +10V Conversion time: 2 ms/channel; for FW V1.02.00 or later, upgraded to 1 ms/channel
	AS08AD-C	8-channel analog input module Hardware resolution: 16 bits 0/4–20mA, -20mA→+20mA Conversion time: 2 ms/channel; for FW V1.02.00 or later, upgraded to 1 ms/channel
	AS04DA-A	4-channel analog output module Hardware resolution: 12 bits -10 to +10V, 0–20mA, 4–20mA Conversion time: 2 ms/channel
	AS06XA-A	4-channel analog input Hardware resolution: 16 bits 0–10V, 0/1–5V, -5 to +5V, -10 to +10V, 0/4–20mA, -20 to +20mA Conversion time: 2 ms/channel; for FW V1.02.00 or later, upgraded to 1 ms/channel

Classification	Model Name	Description
		2-channel analog output Hardware resolution: 12 bits -10 to +10V, 0–20mA, 4–20mA Conversion time: 2 ms/channel
	AS02ADH-A	2-channel analog input Hardware resolution: 16 bits 0–10V, 0/1–5V, -5 to +5V, -10 to +10V, 0/4–20mA, -20 to +20mA High-speed conversion time: 20 μ s The analog channels are isolated from one another. Digital output value (2000 per channel), peak value Low-pass and band-pass filters are available.
Temperature measurement module	AS04RTD-A	4-channel, 2-wire/3-wire RTD Sensor type: Pt100 / Ni100 / Pt1000 / Ni1000 / JPt100 / LG-Ni1000 / Cu50 / Cu100 / 0-300 Ω / 0-3000 Ω / Ni120 (FW V1.06 or later) input impedance Resolution: 0.1°C/0.1°F (16 bits) Conversion time: 200ms/channel
	AS06RTD-A	6-channel, 2-wire/3-wire RTD Sensor type: Pt100 / Ni100 / Pt1000 / Ni1000 / JPt100 / LG-Ni1000 / Cu50 / Cu100 / 0-300 Ω / 0-3000 Ω / Ni120 (FW V1.06 or later) input impedance, Resolution: 0.1°C/0.1°F (16 bits) Conversion time: 200ms/channel
	AS04TC-A	4-channel thermocouple Sensor type: J, K, R, S, T, E, N, B and -100 to +100 mV Resolution: 0.1°C/0.1°F (24 bits) Conversion time: 200ms/channel
	AS08TC-A	8-channel thermocouple Sensor type: J, K, R, S, T, E, N, B and -100 to +100 mV Resolution: 0.1°C/0.1°F (24 bits) Conversion time: 200ms/channel
Load cell	AS02LC-A	2-channel, 4-wire/6-wire load cell sensor

Classification	Model Name	Description
module		Eigenvalues for a load cell: 1, 2, 4, 6, 20, 40, 80 mV/V Highest precision 1/10000 @ 50ms of conversion time ADC Resolution : 4 bits Conversion time: 2.5–400ms (nine options to choose from)
Positioning module	AS02PU-A	2-axis motion control 5-24 VDC, 1 differential input (A/B/Z phase), maximum hardware input frequency at 200 kHz 24 VDC, 5 mA, 5 inputs, maximum hardware input frequency at 1 kHz, 5 VDC, 2-axis (4 points) differential outputs, maximum output frequency at 200 kHz
	AS04PU-A	4-axis motion control 24 VDC, 5mA, 6 inputs, maximum hardware input frequency at 1 kHz 5-30 VDC, 0.1A, 4-axis (8 points) open collector output, maximum output frequency at 100 kHz
Counter module	AS02HC-A	2-channel high-speed counters Input methods are pulse-input (max. at 200 kHz) and SSI communication interface input (max. at 1.25 MHz) 4-axis high-speed open collector output, 5-30 VDC, 0.1A, can work with high-speed instructions to output
Network module	AS00SCM-A	Serial communication module, 2x communication ports for communication cards, supporting Modbus protocols
	AS01DNET-A	DeviceNet communication port, functioning as master or slave
	AS04SIL-A	IO-Link module, built-in with 4 IO-Link communication ports
Remote I/O module	AS00SCM-A + AS-FCOPM	For AS-FCOPM function cards
	AS00SCM-A + AS-FEN02	For AS-FEN02 function cards
	AS01DNET-A (RTU)	DeviceNet remote IO slave, its right side connectswith AS Series extension modules, including digital modules, analog

Classification	Model Name	Description
		modules, temperature modules, etc.
Function cards	AS-F232	Serial communication port, RS232, functioning as master or slave
	AS-F422	Serial communication port, RS422, functioning as master or slave
	AS-F485	Serial communication port, RS485, functioning as master or slave
	AS-FCOPM	CANopen communication port, supporting DS301, AS series remote modules and Delta servo systems
	AS-F2AD	2-channel analog input 0-10V (12 bits), 4-20mA (11 bits) Conversion time: 3ms/channel
	AS-F2DA	2-channel analog output 0-10V, 4-20mA (12 bits) Conversion time: 2ms/channel
	AS-FEN02	Only available for AS300 Series PLC CPU, 2x Ethernet ports, supporting switch function, Modbus TCP, EtherNet/IP Adapter and AS Series remote control
	AS-FPFN02	Only available for AS300 Series PLC CPU, 2x Ethernet ports, supporting switch function and PROFINET Device (Slave)
	AS-FOPC02	Only available for AS300 Series PLC CPU, 2x Ethernet ports, supporting switch function, OPC-UA Server and Modbus TCP
	AS-FFTP01	Only available for AS300 Series PLC CPU, 1x Ethernet ports, supporting FTP Server, OPC-UA Server, MQTT Client, Web Server, and Data Log
	AS-FECAT	Only available for AS300 Series PLC CPU, 2x Ethernet ports, supporting data exchange (before EtherCAT Master enabled), MODBUS TCP Server (1 connection), EtherCAT Master 16-axes point-to-point positioning control (only available for Delta drive)
Programming cable	UC-PRG015-01A (1.5M)	Used for the connection between a PLC and a PC via a mini USB port, use for AS332T-A, AS332P-A, and AS324MT-A

Classification	Model Name	Description
	UC-PRG030-01A (3M)	Use for the connection between a PLC and a PC with a mini USB port, use for AS332T-A, AS332P-A, and AS324MT-A
	UC-PRG030-20A (3M)	Use for the connection between a PLC and a PC with a RJ45 port, use for AS332T-A, AS332P-A, AS324MT-A, AS-FEN02, AS-FPFN02 and AS-FECAT.
I/O extension cable	UC-ET010-24B (1M)	MIL connector, 40Pin ↔ 40Pin, shielded, use for AS32AM10N-A, AS32AN02T-A, AS64AM10N-A and AS64AN02T-A
	UC-ET020-24B (2M)	
	UC-ET030-24B (3M)	
	UC-ET010-24D (1M)	MIL connector, 40Pin ↔ 2x 20Pin, shielded, use for AS332T-A, AS332P-A, AS324MT-A, AS32AM10N-A, AS32AN02T-A, AS64AM10N-A, and AS64AN02T-A
	UC-ET020-24D (2M)	
	UC-ET030-24D (3M)	
External terminal module	UB-10-ID16A	16 inputs/outputs, 20-Pin MIL connector, use for AS332T-A, AS332P-A, AS324MT-A, AS32AM10N-A, AS32AN02T-A, AS64AM10N-A and AS64AN02T-A
	UB-10-ID32A	32 inputs, 40-Pin MIL connector, use for AS32AM10N-A and AS64AM10N-A
	UB-10-IO32D	Terminal block (spring clamp/MIL connector), MIL connector to 40-Pin spring clamp terminal block, use for AS332T-A, AS332P-A, AS324MT-A, AS32AM10N-A, AS32AN02T-A
	UB-10-OR16A	16 relay outputs, 20-Pin MIL connector, NPN, use for AS332T-A, AS32AN02T-A and AS64AN02T-A
	UB-10-OR16B	16 relay outputs, 20-Pin MIL connector, PNP, use for AS332P-A
	UB-10-OT32A	32 transistor outputs, 40-Pin MIL connector, NPN, use for AS32AN02T-A and AS64AN02T-A
Network cables	UC-CMC003-01A (0.3M)	CANopen communication cable, use for AS-FCOPM series
	UC-CMC005-01A (0.5M)	CANopen communication cable, use for AS-FCOPM series
	UC-CMC010-01A (1M)	CANopen communication cable, use for AS-FCOPM series
	UC-CMC015-01A (1.5M)	CANopen communication cable, use for AS-FCOPM series
	UC-CMC020-01A (2M)	CANopen communication cable, use for AS-FCOPM series
	UC-CMC030-01A (3M)	CANopen communication cable, use for AS-FCOPM series
	UC-CMC050-01A (5M)	CANopen communication cable, use for AS-FCOPM series

Classification	Model Name	Description
	UC-CMC100-01A (10M)	CANopen communication cable, use for AS-FCOPM series
	UC-CMC200-01A (20M)	CANopen communication cable, use for AS-FCOPM series
	UC-EMC003-02A (0.3M)	Ethernet communication cable, use for AS Series CPU modules, AS-FEN02, AS-FPFN02 and AS-FECAT.
	UC-EMC005-02A (0.5M)	Ethernet communication cable, use for AS Series CPU modules, AS-FEN02, AS-FPFN02 and AS-FECAT.
	UC-EMC010-02A (1M)	Ethernet communication cable, use for AS Series CPU modules, AS-FEN02, AS-FPFN02 and AS-FECAT.
	UC-EMC020-02A (2M)	Ethernet communication cable, use for AS Series CPU modules, AS-FEN02, AS-FPFN02 and AS-FECAT.
	UC-EMC050-02A (5M)	Ethernet communication cable, use for AS Series CPU modules, AS-FEN02, AS-FPFN02 and AS-FECAT.
	UC-EMC100-02A (10M)	Ethernet communication cable, use for AS Series CPU modules, AS-FEN02, AS-FPFN02 and AS-FECAT.
	UC-EMC200-02A (20M)	Ethernet communication cable, use for AS Series CPU modules, AS-FEN02, AS-FPFN02 and AS-FECAT.

1.2 Overview

An AS series CPU module is an advanced controller with built-in 6 high speed counters for inputs, up to 6-axis (pulse), and can optionally work with a total of 8-axis (CANopen) position outputs. It provides a strong network function for users, and users can create connection among devices on the network through software. An AS series CPU module also provides structured programming. Users can assign programs to different tasks, and write a program which is frequently executed in a function block. Besides, users can choose different programming languages ladder diagrams (LD), structured texts (ST), sequential function charts (SFC), continuous function chart (CFC) and C language dealt with by IEC 61131-3 according to their needs when writing programs in ISPSOft or DIADesigner. They can create the AS series hardware configuration by means of hardware configuration software. They can also restore or back up a system rapidly through the built-in SD interface in an AS series CPU module. This manual introduces the basic operation of an AS series system, and help users familiarize themselves with the AS series system.

1.3 Characteristics

Characteristics of the AS series CPU module:

(1) High efficiency

- The AS Series CPU module uses a 32-bit high-speed processor. The module executes basic instructions at 25 ns each and moving instructions at 150ns each. The module executes instructions at a speed of 40k steps/ms (40% of the instructions are basic instructions, and 60% of the instructions are applied instructions).
- The CPU of the AS Series uses the Soc architecture, built with six (or three) high speed counters. The maximum frequency is 200 kHz for each counter (differential output models can reach 4 MHz); six-axis high speed position output at 200 kHz (differential output models can reach 4 MHz).

(2) Supporting more inputs and outputs

- The AS series CPU module supports up to 1024 digital I/Os or 32 I/O modules (any type) or 16 analog I/O modules.
- The AS series works with SCM/DNET communication modules (AS-FCOPM, and AS-FEN02 included) to create a remote connection, and you can connect up to 15 remote modules.

Note: For the connections between the CPU modules and the remote modules, the I/O points cannot exceed 1024 I/Os, 32 I/O modules (any type), or 16 analog I/O modules.

(3) Multiple I/O modules

- The AS series CPU module supports the following I/O modules: digital input/output modules, analog input/output modules, temperature measurement modules, positioning/counter modules, network modules, and function cards. Refer to section 1.1.2 section for more details.

(4) Larger program capacity and memory

- The AS300 Series advanced CPU modules have 128k steps of program capacity. 60000 general registers (30000 for specific use and 30000 for programming editing), and 64k words of memory (that can be used for storing parameters).
- The AS100 and AS200 Series advanced CPU modules have 64k steps of program capacity. 60000 general registers (30000 for specific use and 30000 for programming editing), and 64k words of memory (that can be used for storing parameters).

(5) Supporting IEC 61131-3

- The AS series CPU module supports IEC 61131-3.
- Supported programming languages are ladder diagrams (LD), sequential function chart (SFC), structured text (ST), continuous function chart (CFC) (ISPSOft V3.01 or later) and C language (ISPSOft V3.08 or later).

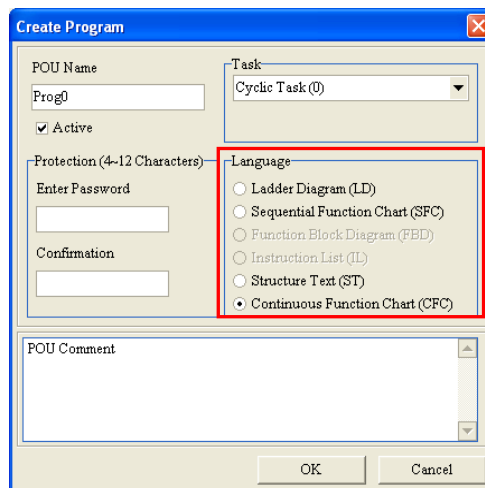

- You can select a programming language according to your preference. Programming languages support one another so that programs written by different users are compatible.

(6) Strong function block

- Both standard IEC61131-3 function blocks and convenient functions blocks provided by Delta Electronics, Inc. are supported. You can use function List blocks for frequently used programs for greater structure and convenience.
- The symbol for a function block in a ladder diagram is similar to an integrated circuit (IC) in a circuit diagram. Because the ladder diagram is based on the traditional circuit diagram, the operation of a function block is similar to the function of an integrated circuit. You only need to send the signal to the corresponding input of the function block. You do not need to consider the processing procedure inside the function block.

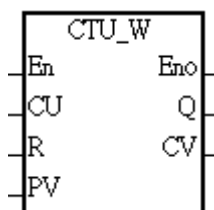

- A function block is a program element equipped with the operation function. It is similar to a subroutine, and is a type of POU (Program Organization Unit). It cannot operate by itself, and must be called through the main program POU. The function defined by the function block is executed after being called with the related parameters. The final result can be sent to the device or variable in the superior POU after the function block completes.
- You can set passwords in ISPSOft or DIADesigner to provide function block security. The program inside a function block cannot be read, and business patents cannot be compromised.

(7) Task

1

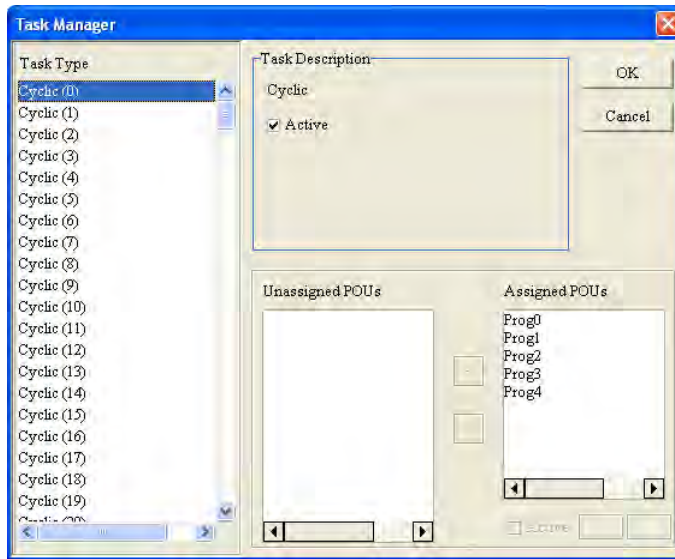

(ISPSOFT image)

- You can assign 283 tasks at most to a program. Among these tasks, 32 are cyclic, 32 are I/O interrupts, 4 are timer interrupts, two are communication interrupts, one is an external 24 V low-voltage interrupt, and 212 are user-defined tasks.
- You can enable and disable a task when running a program by using the TKON and TKOFF instructions.

(8) Increasing hardware configuration efficiency through a USB cable and ISPSOFT / DIADesigner

- The AS Series CPU module provides a standard USB 2.0 interface. USB 2.0 increases the data transfer rate and decreases the time it takes to download the program, monitor the program, and configure the hardware. You do not need to buy a special communication cable for the CPU module. You can use a general USB cable to connect to the AS Series CPU module.

(9) Serial control interface with multiple functions

- AS Series CPU modules provide two RS-485 serial control interfaces, COM1 and COM2, which can be set as either master or slave.
- You use the communication cards to work with two extension serial communication ports and to set the port as a master or slave.

(10) High-speed Ethernet communication interface

- AS Series CPU modules are equipped with a 10/100 M Ethernet communication interface and support email, web, and socket services.
- System error messages can be sent to your email immediately. You do not need to be on location to

understand the problem.

(11) Memory card

- The memory card has the following functions.

System backup: user program, CPU parameters, module table, and the device setting values

System recovery: user program, CPU parameters, module table, and device setting values

Parameter storage: device value

Log storage: system error log and system status log

(12) I/O module installation

- The AS Series PLC supports slide-and-lock installation on I/O modules when the power is off. After the PLC is powered off, you can remove the defective module and replace it with a new one without removing other modules.



(13) Supporting on-line debugging mode

- You can use the on-line debugging mode in the AS series CPU module after a single instruction step completes, or after a breakpoint is specified, to find bugs in the program.
- The CPU module must be running to enter the debugging mode. After enabling the on-line monitoring

function, click . The debugging screen varies from programming language to programming language, but the same operation applies to these programming languages. For the AS series PLC, structured text does not support debugging mode, and sequential function charts supports debugging mode during the action and the transition.

Using ISPSOft to demonstrate:

Step 1: Set the PLC to RUN

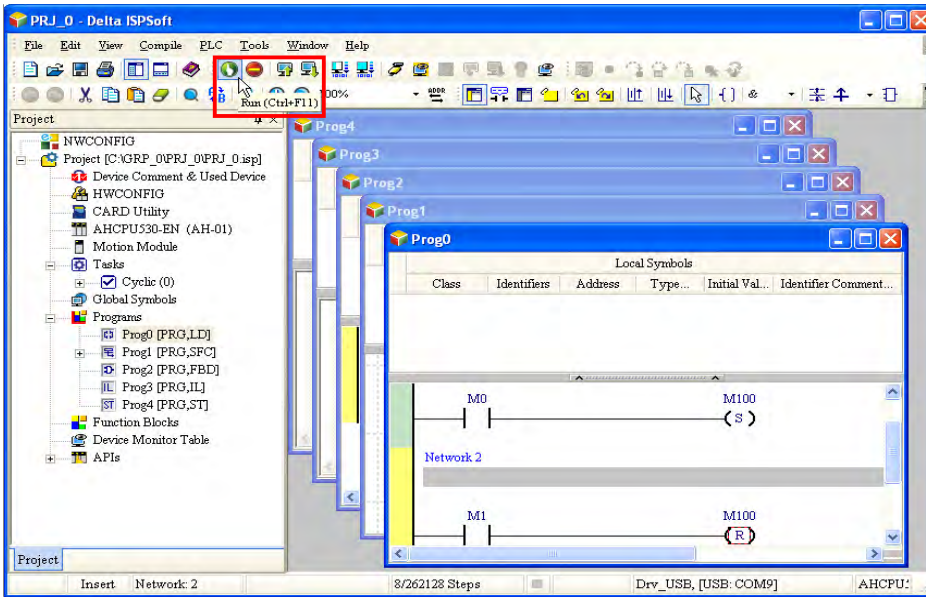

Step 2: Entering the on-line mode

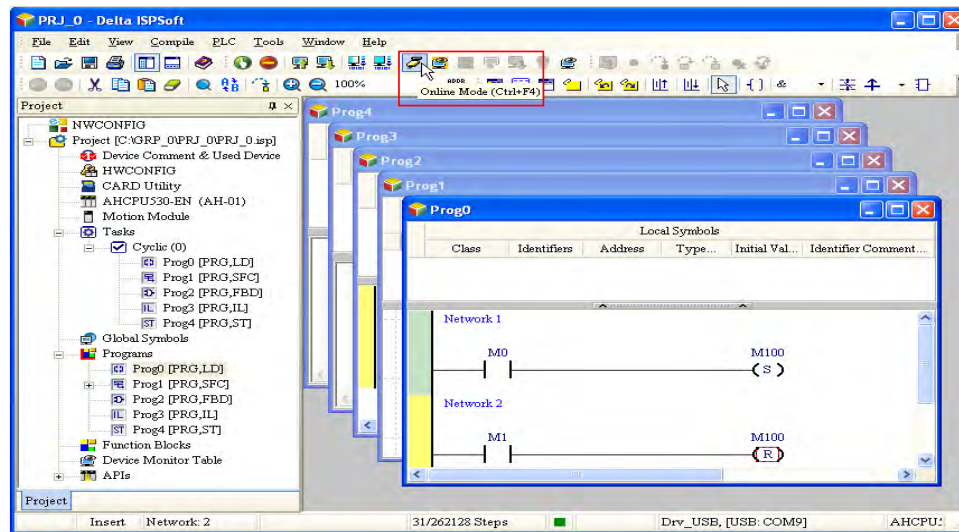

Step 3: Enter debugging mode

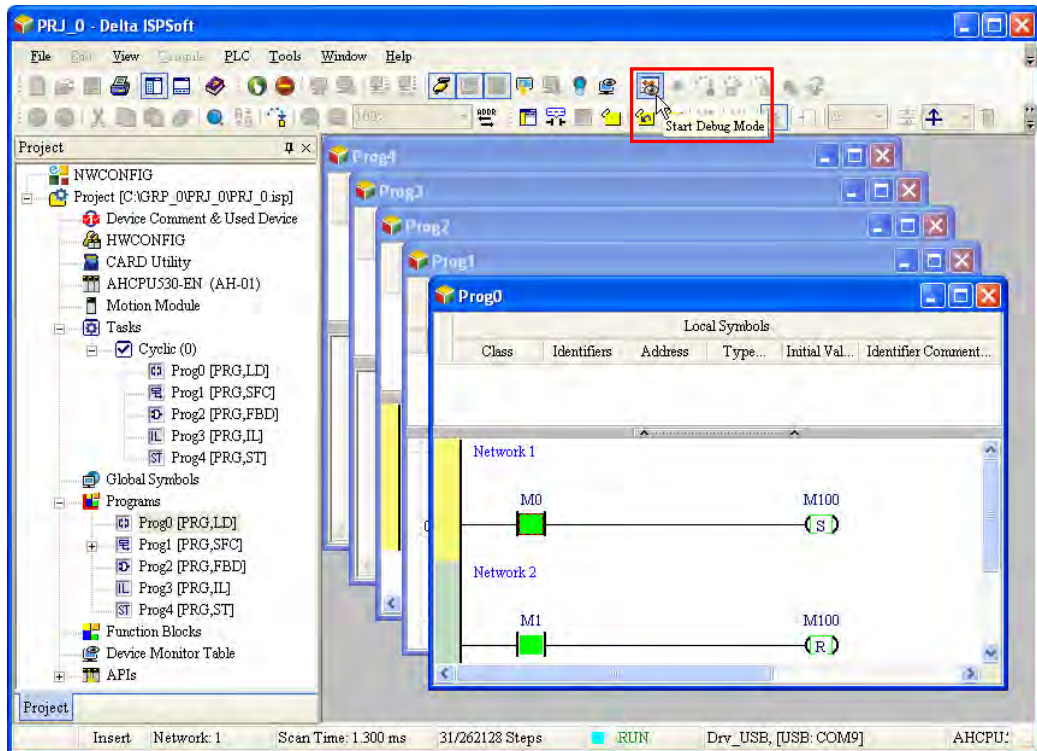

(14) On-line editing mode

- You can use the on-line editing mode when the system is running to update the program without affecting the system operation.
- Using ISPSOft to demonstrate, when the system is in the on-line monitoring mode, enter the on-line editing mode by clicking

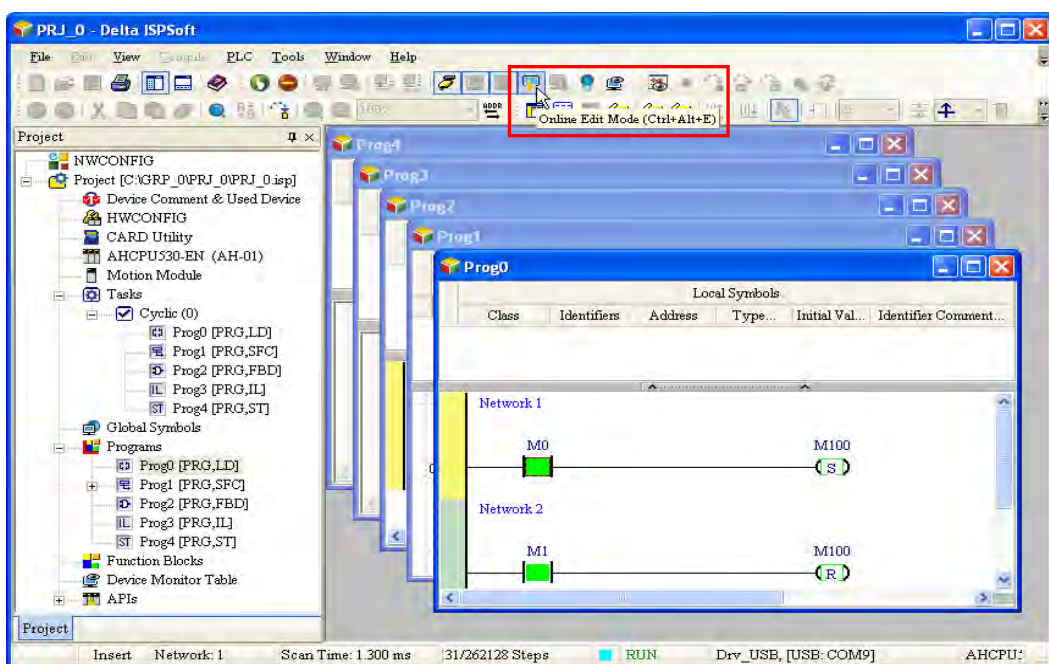

- After the program is modified and compiled, you can update the program in the CPU module by

clicking  to download it to the CPU.

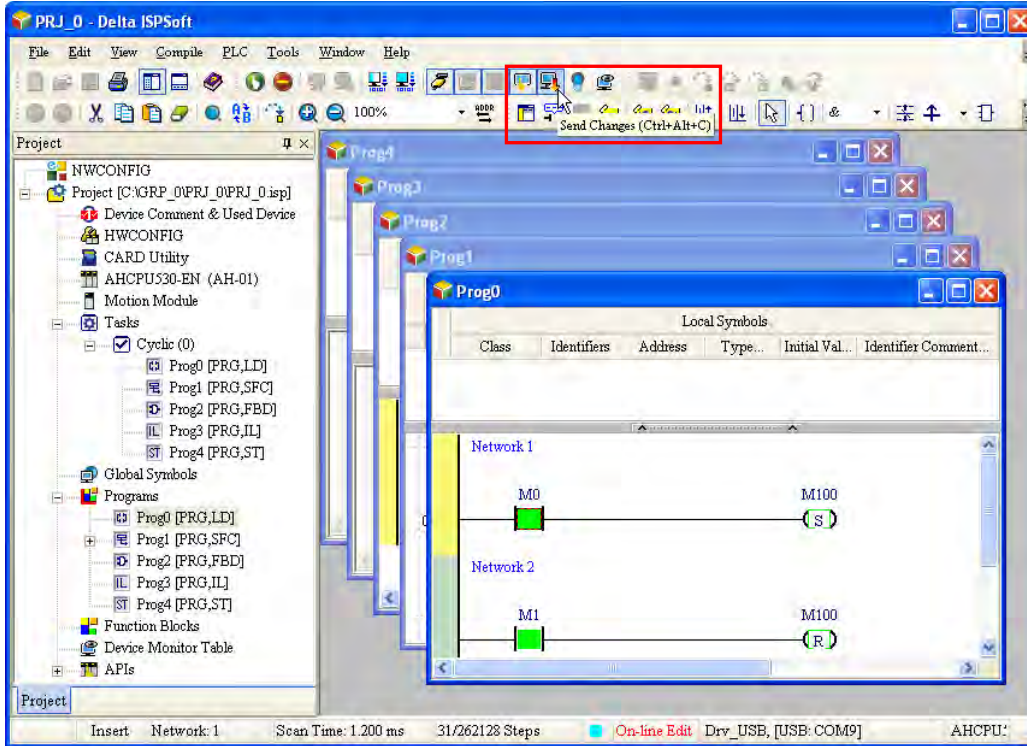

Chapter 2 Specifications and System Configuration

Table of Contents

2.1	General Specifications	2-3
2.2	CPU Module Specifications	2-4
2.2.1	Functional specifications	2-4
2.2.2	Electrical specifications	2-5
2.2.3	CPU Module Profiles	2-12
2.2.4	CPU Module Input/Output Terminals	2-18
2.2.5	AS200 Input/Output Terminals	2-23
2.3	Digital Input/Output Module Specifications	2-24
2.3.1	General Specifications	2-24
2.3.2	Digital Input/Output Module Profiles	2-27
2.3.3	Digital Input/Output Module Terminals	2-36
2.4	Analog Input/Output Module Specifications	2-43
2.4.1	General Specifications	2-43
2.4.2	Analog Input/Output Module Profiles	2-51
2.4.3	Analog Input/Output Terminals	2-52
2.5	Temperature Measurement Modules Specifications	2-53
2.5.1	General Specifications	2-53
2.5.2	Temperature Measurement Module Profiles	2-56
2.5.3	Temperature Measurement Module Dimensions	2-58
2.6	Positioning Module Specifications	2-59
2.6.1	General Specifications	2-59
2.6.2	Positioning Module Profiles	2-61
2.6.3	Positioning Module Terminals	2-62
2.7	Counter Module Specifications	2-63
2.7.1	General Specifications	2-63
2.7.2	Counting Module Profiles	2-66
2.7.3	Counting Module Terminals	2-67
2.8	Network Module Specifications	2-68
2.8.1	General Specifications	2-68
2.8.2	Network Module Profiles	2-72
2.9	Load Cell Module Specifications	2-76
2.9.1	General Specifications	2-76
2.9.2	Load Cell Module Profiles	2-77
2.9.3	Load Cell Module Dimensions	2-78
2.10	Extension Card Specifications	2-79
2.10.1	General Specifications	2-79
2.10.2	Extension Card Profiles	2-84

2.10.3	Function Card Weights.....	2-89
2.11	Power Supply Module Specifications	2-90
2.11.1	General Specifications	2-90
2.11.2	Power Supply Module Profiles	2-91
2.12	Power Supply Module Adapter Specification.....	2-92

2.1 General Specifications

Item	Specifications
Operating temperature	-20 to 60°C
Storage temperature	-40 to 80°C
Operating humidity	5–95% No condensation
Storage humidity	5–95% No condensation
Work environment	No corrosive gas exists.
Installation location	In a control box
Pollution degree	2
Ingress protection (IP ratings)	IP20
EMC (electromagnetic compatibility)	Refer to Appendix C for more information.
Vibration resistance	Tested with: 5 Hz \leq f \leq 8.4 Hz, constant amplitude 3.5 mm; 8.4 Hz \leq f \leq 150 Hz, constant acceleration 1g Duration of oscillation: 10 sweep cycles per axis on each direction of the three mutually perpendicular axes International Standard IEC 61131-2 & IEC 60068-2-6 (TEST Fc)
Shock resistance	Tested with: Half-sine wave: Strength of shock 15 g peak value, 11 ms duration; Shock direction: The shocks in each in direction per axis, on three mutually perpendicular axes (total of 18 shocks) International Standard IEC 61131-2 & IEC 60068-2-27 (TEST Ea)
Safety	Conforms to IEC 61131-2, UL508
Ambient air temperature-barometric pressure-altitude	Operating: 1080 ~ 795hPa (-1000 ~ 2000 m) Storage:1080 ~ 660hPa (-1000 ~ 3500 m)
Endurance	Applicable to the removable terminal block, function card slot, SD card slot, Ethernet port, USB port on the modules and the connecting ports between modules. Plugging: more than 100 times (Each plugging in is counted as 1 time and pins inside the slots or ports should not be bent or crooked.) Force used for plugging in: to plug in a removalbe terminal block, the force used is around 70 g and for other slots and ports, the force is around 220 g. Force used for plugging out: to plug out a removalbe terminal block, the force used is around 1000 g and for other slots and ports, the force is around 20 g.
UL 94 Flame Classifications	UL 94 V-0

2.2 CPU Module Specifications

2.2.1 Functional specifications

Item	AS324MT-A / AS332T-A / AS332P-A	AS164T-A / AS164R-A AS164P-A / AS148T-A AS148R-A / AS148P-A AS132T-A / AS132R-A AS132P-A AS228T-A / AS228P-A AS228R-A / AS218TX-A AS218PX-A / AS218RX-A	Remark
Execution	The program is executed cyclically.		
Input/Output control	Regenerated inputs/outputs Direct inputs/outputs		The inputs and outputs can be controlled through the direct inputs and direct outputs.
Programming language	IEC 61131-3		
	Ladder diagrams, continuous function charts, structured text, and sequential function charts		
Instruction execution speed	40K steps/ms		
Number of instructions	Approximately 666 instructions		
Constant scan cycle (ms)	1-32000 (The scan cycle can be increased by one millisecond.)		Setting the parameter
Program capacity (step)	128K steps (256K bytes)	64K steps (128K bytes)	
Installation	DIN rails or screws		
Installation of a module	No backplane installation; only module after module		
Maximum number of modules which can be installed	32 modules		
Number of tasks	283 tasks (32 cyclic tasks; 16 I/O interrupts; four timed interrupts, etc.)		Refer to the AS Series Operation manual for more information.
Number of inputs/outputs	1024		Number of inputs/outputs accessible to an actual input/output module
Input relays [X]	1024		
Output relays [Y]	1024		
Internal relays [M]	8192 (M0–M8191)		
Timers [T]	512 (T0–T511)		
Counters [C]	512 (C0–C511)		
32-bit counter [HC]	256 (HC0–HC255)		
Data register [D]	30000 (D0–D29999)		
Data register [W]	30000 (W0–W29999)		
Stepping relay [S]	2048 (S0–S2047)		

Item	AS324MT-A / AS332T-A / AS332P-A	AS164T-A / AS164R-A AS164P-A / AS148T-A AS148R-A / AS148P-A AS132T-A / AS132R-A AS132P-A AS228T-A / AS228P-A AS228R-A / AS218TX-A AS218PX-A / AS218RX-A	Remark
Index register [E]	10 (E0–E9)		
Special auxiliary relay [SM]	2048 (SM0–SM2047)		
Special data register [SR]	2048 (SR0–SR2047)		
Serial communication port	2x RS-485		
Ethernet port	10/100 M		Refer to the section 9.3 for more details on Ethernet specifications
USB port	Mini USB		
Storage interface	SD Card (Micro SD); maximum storage: 32G		
Real-time clock	Years, months, days, hours, minutes, seconds and weeks		*Batteries (CR1620) are not included.
Function card interface	2x function cards, supporting communication card, AD/DA analog function cards	None	Function card is only available for AS300 Series.
CANopen DS301 (Master)	Maximum node: 64; maximum bytes: 2000		*A function card AS-FCOPM is required for AS300 Series.
CANopen DS301 (Slave)	Maximum PDO: 8; maximum bytes: 8		

2.2.2 Electrical specifications

● AS200 Series and AS300 Series

Item	Model					
	AS332T-A/ AS332P-A/ AS324MT-A	AS320T-B/ AS320P-B	AS300N-A	AS228T-A/ AS228P-A	AS218TX-A/ AS218PX-A	AS228R-A/ AS218RX-A
Supply voltage	24 VDC (20.4 VDC–28.8 VDC) (-15% to +20%)					
Max. inrush current	95 A (@28.8VDC · I ² t = 4.5 A ² S)					
Power consumption (W)	3.6	3.6	3	3.6	4.32	4.56 / 4.8
Weight (g)	260	285	235	285	290	325 / 310
Communication port isolation	USB, COM1, COM2, and CAN ^{*1} ports: 500 VAC Ethernet: 1500 VAC: *1: CAN port is not built-in for AS300 Series. You need to purchase a communication card AS-FCOPM to have a CAN port.					

● AS100 Series

Item \ Model	AS132T-A AS132P-A	AS132R-A	AS148T-A AS148P-A	AS148R-A	AS164T-A AS164P-A	AS164R-A
Supply voltage	100 ~ 240VAC (-15% ~ 10%); 50 / 60Hz ± 5%					
Max. inrush current	140 A (@264VAC · I ² t = 29.4 A ² S)					
Power fuse rating	2.5 A / 250 VAC					
Power consumption (W)	130 V _{MAX}					
Internal power consumption (W)	2.64	3.84	3	4.8	3.36	5.76
Current output (DC 24V)	500 mA					
Output short-circuit protection (DC 24V)	Yes					
Electronical isolation	3,000 VAC (Primary-secondary); 3,000 VAC (Primary-FE); 500 VAC (Secondary-FE)					
Insulation voltage	Above 5 MΩ The voltage between all inputs/outputs and the ground is 500 VAC.					
Ground	The diameter of the ground should not be less than the diameters of the cables connected to the terminals L and N.					
Weight (g)	550	600	650	700	750	800
Communication port isolation	USB, COM1, COM2, and CAN ports: 500 VAC Ethernet: 1500 VAC					

● AS300 Series: Electrical specifications for the inputs on digital input/output module. The signals passing through the inputs are 24 VDC signals.

Item \ Model	AS332T-A AS332P-A	AS320T-B AS320P-B	AS324MT-A
Number of inputs	16 (X0.0-X0.15)	8 (X0.0-X0.7)	12 (X0.0-X0.11)
Terminal connector type	MIL connector	Removable spring-type terminal blocks	MIL connector
Input type	Digital input		
Input form	Direct current (sinking or sourcing)		X0.0+~X0.3+/X0.0- to X0.3-: differential input X0.4~X0.11: Direct current (sinking or sourcing)
Input voltage/ current	24 VDC 5 mA		X0.0+~X0.3+/X0.0- to X0.3-: 5 VDC, 5 mA X0.4~X0.11: 24 VDC, 5 mA
Action level	OFF→ON	>15 VDC	
	ON→OFF	<5 VDC	
Response time	OFF→ON	X0.0~X0.11: < 2.5μs X0.12~X0.15: < 50μs	X0.0+~X0.3+/X0.0- to X0.3- : < 0.125 μs X0.4~X0.11: < 2.5μs

Model		AS332T-A AS332P-A	AS320T-B AS320P-B	AS324MT-A
	ON→OFF	X0.0~X0.11: < 2.5μs X0.12~X0.15: < 50μs		X0.0+~X0.3+/X0.0- to X0.3- : < 0.125 μs X0.4~X0.11: < 2.5μs
Maximum input frequency		X0.0~X0.11: 200 kHz X0.12~X0.15: 10 kHz		X0.0+~X0.3+/X0.0- to X0.3-: < 4 MHz X0.4~X0.11: < 200 kHz
Input impedance		5.6 k Ω		
Input signal		Voltage input Sinking: The inputs are NPN transistors whose collectors are open collectors. Sourcing: The inputs are PNP transistors whose collectors are open collectors.		
Input isolation		500 VAC		
Input display		When the optocoupler is driven, the input LED indicator is ON.		

Note: AS300N-A does not come with inputs/outputs.

● AS300 Series: Electrical specifications for the outputs

Model		AS332T-A AS332P-A	AS320T-B AS320P-B	AS324MT-A
Number of outputs		16 (Y0.0-Y0.15)	12 (Y0.0-Y0.11)	12 (Y0.0-Y0.11)
Terminal connector type		MIL connector	Removable spring-type terminal blocks	MIL connector
Output form		Transistor-T (sinking) Transistor-P (sourcing)		Y0.0+~Y0.3+/Y0.0- to Y0.3-: differential input Y0.4~Y0.11: Transistor-T (sinking)
Voltage		5-30 VDC		Y0.0+~Y0.3+/Y0.0- to Y0.3- : 5 VDC Y0.4~Y0.11: 5-30VDC
Leakage current		<10uA		
Max. inrush current		Transistor-T (sinking): 0.8 A Transistor-P (sourcing): 1.2 A (Tested condition: Ta = 25 °C, V _{DS} = 30VDC and pulse duration = 1ms)		
Maximum load	Resistance	0.1A/output, 1.6A/COM	0.1A/output, 1.2A/COM	Y0.0+~Y0.3+/Y0.0-Y0.3- : 20mA/output (+ and - as a group, e.g. Y0.0+ and Y0.0- is a group) Y0.4~Y0.11:0.1A/output, 0.8A/COM
	Inductance	N/A		
	Bulb	N/A		
Minimum load		1mA / 5V		
Maximum output frequency*1	Resistance	Y0.0~Y0.11: 200 kHz Y0.12~Y0.15: 100 Hz		Y0.0+~Y0.3+/Y0.0- to Y0.3- : 4 MHz Y0.4~Y0.11: 200 kHz
	Inductance	N/A		
	Bulb	N/A		
Maximum Response time	OFF→ON	Y0.0~Y0.11: 2.5μs Y0.12~Y0.15: 0.5ms		Y0.0+~Y0.3+/Y0.0- to Y0.3-: 0.125 μs Y0.4~Y0.11: 2.5 μs
Output isolation		500 VAC		

- **AS200 Series: Electrical specifications for the inputs. The signals passing through the inputs are 24 VDC signals.**

Model		AS228P-A / AS228R-A / AS228T-A	AS218PX-A / AS218RX-A / AS218TX-A
Item			
Number of inputs		16 (X0.0-X0.15)	8 (X0.0-X0.7)
Terminal connector type		Removable spring-type terminal blocks	
Input type		Digital input	
Input form		Direct current (sinking or sourcing)	
Input voltage/ current		24 VDC, 5 mA	
Action level	OFF→ON	>15 VDC	
	ON→OFF	<5 VDC	
Response time	OFF→ON	X0.0–X0.7: < 2.5 μs X0.8–X0.15: < 50 μs	
	ON→OFF	X0.0–X0.7: < 2.5 μs X0.8–X0.15: < 50 μs	
Maximum input frequency		X0.0–X0.7: 200 kHz X0.8–X0.15: 10 kHz	
Input impedance		X0.0–X0.7: 3.9 k Ω X0.8–X0.15: 5.6 k Ω	3.9 k Ω
Input signal		Voltage direct input Sinking: The inputs are NPN transistors whose collectors are open collectors. Sourcing: The inputs are PNP transistors whose collectors are open collectors.	
Digital input isolation		500 VAC	
Input display		When the optocoupler is driven, the input LED indicator is ON.	
Analog inputs		N/A	2
Analog input conversion time*1		N/A	3 ms / channel
Analog input resolution		N/A	12bits
Analog input mode		N/A	-10V~10V (voltage mode) or 20mA~20mA (currentmode)
Analog linearity error		N/A	±1% (full scale)
Analog input impedance		N/A	≥1 MΩ (Voltage mode) 250 Ω (Current mode)
Analog input isolation		When there is isolation between analog and digital electricals and there is no isolation among analog channels. Isolation between analog electrical and grounding: 500 VAC Isolation between analog and digital electrical: 500 VAC	

*1: Analog input data updates automatically in every PLC program scan.

● AS200 Series: Electrical specifications for the outputs

Item		Model	AS228R-A AS218RX-A	AS228T-A AS218TX-A	AS228P-A AS218PX-A
Number of outputs		AS228 Series: 12 outputs (Y0.0-Y0.11) AS218 Series 6 outputs (Y0.0-Y0.5)			
Terminal connector type		Removable spring-type terminal blocks			
Output form		Relay		Transistor-T (sinking)	Transistor-P (sourcing)
Voltage / current		240 VAC / 24 VDC		5-30 VDC	5-30 VDC
Leakage current		0uA		<10uA	
Max. inrush current		N/A		Transistor-T (sinking): 0.8 A Transistor-P (sourcing): 7.5 A (Tested condition: Ta = 25 °C, V _{DS} = 30VDC and pulse duration = 1ms)	
Maximum load	Resistance	AS228	2A/output, 8A/COM	0.5A/output, 2A/COM	0.5A/output, 2A/COM
		AS218	2A/output, 6A/COM	0.5A/output, 1.5A/COM	0.5A/output, 1.5A/COM
	Inductance		Life cycle curve*2	N/A	N/A
	Bulb		20W (24 VDC) 100W (230 VAC)	N/A	N/A
Minimum load		1mA / 5V			
Maximum output frequency	Resistance	1Hz		200kHz	200kHz
	Inductance	0.5Hz		N/A	N/A
	Bulb	1Hz		N/A	N/A
Maximum Response time	OFF→ON	10 μs		2.5 μs	2.5 μs
	ON→OFF				
Analog outputs		AS218 Series: 2 outputs			
Analog output conversion time*1		3 ms / channel (for AS218 PLC CPU)			
Analog output resolution		AS218 Series: 12bits			
Analog output mode		AS218 Series: -10V~10V (voltage mode) or 0mA~20mA (currentmode)			
Electrical output isolation		1500 VAC		500 VAC	
Analog output isolation		When there is isolation between analog and digital electricals and there is no isolation among analog channels. Isolation between analog electrical and grounding: 500 VAC Isolation between analog and digital electrical: 500 VAC			

*1: Analog output data updates automatically in every PLC program scan.

*2: Life cycle curve: The lifetime of a relay terminal varies with the working voltage, the load type (the power factor $\cos\psi$, the time constant $t(L/R)$), and the current passing through the terminal. The relation is shown in the life cycle curve below.

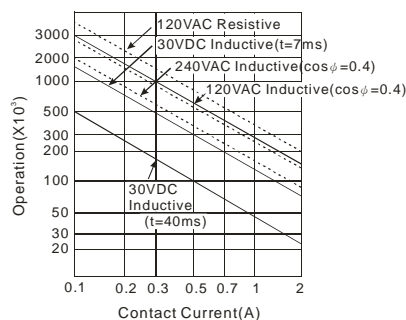

- **AS100 Series: Electrical specifications for the inputs. The signals passing through the inputs are 24 VDC signals.**

Item \ Model		AS164T-A AS164P-A AS164R-A	AS148T-A AS148P-A AS148R-A	AS132T-A AS132P-A AS132R-A
Number of inputs		32 (X0.0~X0.15) (X1.0~X1.15)	24 (X0.0~X0.15) (X1.0~X1.7)	16 (X0.0 ~ X0.15)
Terminal connector type		Removable screw-type terminal blocks		
Input type		Digital input		
Input form		Direct current (sinking or sourcing)		
Input voltage/ current		24 VDC, 5 mA		
Action level	OFF→ON	>15 VDC		
	ON→OFF	<5 VDC		
Response time	OFF→ON	X0.0~X0.7: < 2.5 μs X0.8~X0.15: <25 μs X1.0~X1.15: < 500 μs		
	ON→OFF	X0.0~X0.7: < 2.5 μs X0.8~X0.15: <25 μs X1.0~X1.15: < 500 μs		
Maximum input frequency		X0.0~X0.7: 200 kHz X0.8~X0.15: 20 kHz X1.0~X1.15: 1 kHz		
Input impedance		X0.0~X0.7: 3.9 k Ω X0.8~X0.15; X1.0~X1.15: 5.6 k Ω		
Input signal		Voltage direct input Sinking: The inputs are NPN transistors whose collectors are open collectors. Sourcing: The inputs are PNP transistors whose collectors are open collectors.		
Digital input isolation		500 VAC		
Input display		When the optocoupler is driven, the input LED indicator is ON.		

- **AS100 Series: Electrical specifications for the outputs**

Item \ Model		AS164R-A AS148R-A AS132R-A	AS164T-A AS148T-A AS132T-A	AS164P-A AS148P-A AS132P-A
Number of outputs		AS132R/T/P-A: 16 outputs (Y0.0~Y0.15) AS148R/T/P-A: 24 outputs (Y0.0~Y0.15) (Y1.0~Y1.7) AS164R/T/P-A: 32 outputs (Y0.0~Y0.15) (Y1.0~Y1.15)		
Terminal connector type		Removable screw-type terminal blocks		
Output form		Relay	Relay	Relay
Voltage / current		240 VAC/24 VDC	5~30 VDC	
Leakage current		0uA	<10uA	
Max. inrush current		NA	Transistor-T (sinking): 0.8 A Transistor-P (sourcing): 7.2 A (Tested condition: Ta = 25 °C, V _{DS} = 30VDC and pulse duration = 1ms)	
Maximum load	Resistance	2A/output, 5A/COM	0.5A/output, 2A/COM	
	Inductance	Life cycle curve*2	15W (30 VDC)	

2

Item \ Model		AS164R-A AS148R-A AS132R-A	AS164T-A AS148T-A AS132T-A	AS164P-A AS148P-A AS132P-A
	Bulb	20W (24 VDC) 100W (230 VAC)	2.5W (30 VDC)	
Maximum output frequency		1 Hz	Y0.0~Y0.11: 200 kHz Y0.12~*1: 1 kHz	
Maximum Response time	OFF→ON	10 ms	Y0.0~Y0.11: 2.5 μs Y0.12~*1: 500 μs	
	ON→OFF		Y0.0~Y0.11: 2.5 μs Y0.12~*1: 500 μs	
Electrical output isolation		1500 VAC	500 VAC	

*1: Refere to section 2.2.4 for more information on the maximum output points of each model.

*2: Life cycle curve: The lifetime of a relay terminal varies with the working voltage, the load type (the power factor $\cos\psi$, the time constant $t(L/R)$), and the current passing through the terminal. The relation is shown in the life cycle curve below.

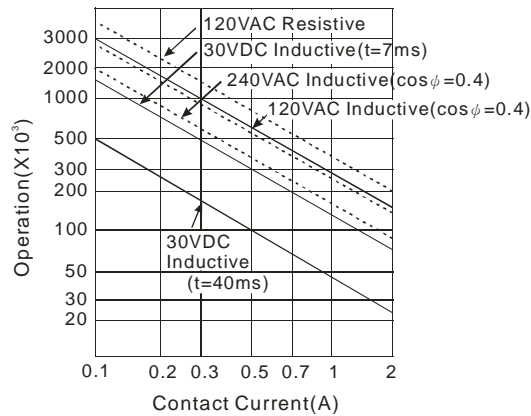

2.2.3 CPU Module Profiles

- AS324MT-A/AS332T-A/AS332P-A/AS300N-A

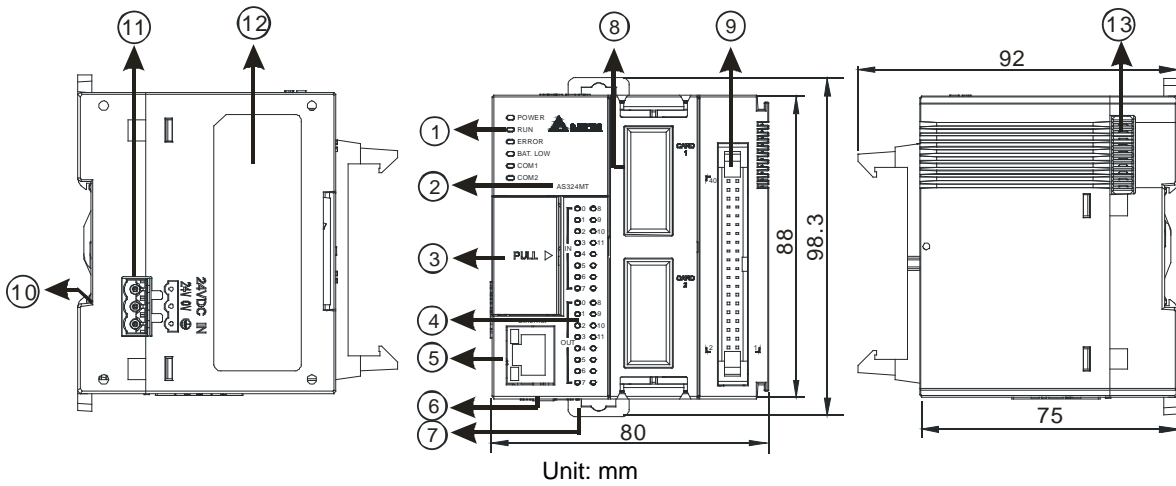

- AS320T-B/AS320P-B

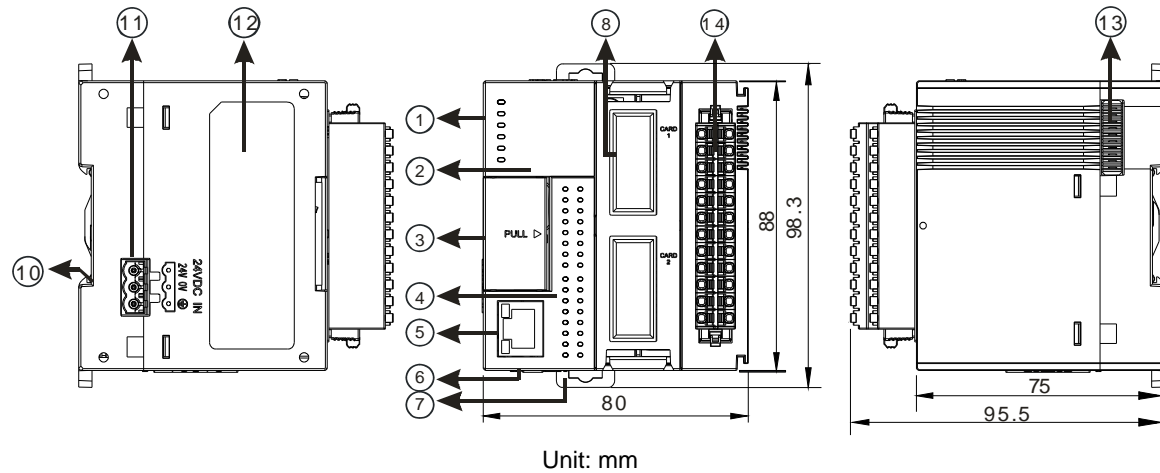

Number	Name	Description
1	Power LED indicator	Indicates the power status of the CPU module
	Run LED indicator	Operating status of the module ON: the module is running. OFF: the module is stopped.
	Error LED indicator	Error status of the module ON: a serious error occurs in the module. OFF: the module is normal. Blinking: a minor error occurs in the module.
	BAT.LOW LED indicator	Indicates the battery status of the CPU module. (Enable/Disable this display in HWCONFIG in ISPSofT)
	COM1 LED COM2 LED	Indicates the communication status of the COM port. OFF: no communication over the COM port Blinking: communication over the COM port
2	Model name	Shows the model name of the CPU module.
3	Run/Stop	RUN: execute the programs STOP: stop the programs
	USB port	Mini USB communication port

2

Number	Name	Description
	SD card slot	Provides an interface for an SD card
	VR0/VR1	VR0: use the flag SM166 to activate the values in SR166 VR1: use the flag SM167 to activate the values in SR167
4	Input/Output LED indicator	If there is an input signal, the input LED indicator is ON. If there is an output signal, the output LED indicator is ON.
5	Ethernet port	Provides an interface for a n Ethernet communication
6	COM1/COM2	Provides an interface for RS-485 communication
7	DIN rail clip	Secures the DIN rail
8	Extension card slot	Provides an interface for an extension card
9	MIL connector	Connects the module and the wiring module AS300N-A does not come with inputs/outputs; no MIL connector for it.
10	Grounding clip	For grounding
11	Power supply	For power supply
12	Label	Nameplate
13	External module port	Connects the modules
14	Removable terminal blocks	For wiring the input and output; Note: Since AS300N-A does not come with inputs/outputs, no terminal block for this series.

● AS200 Series (AS218PX-A/AS218RX-A/AS218TX-A/AS228R-A/AS228T-A/AS228P-A)

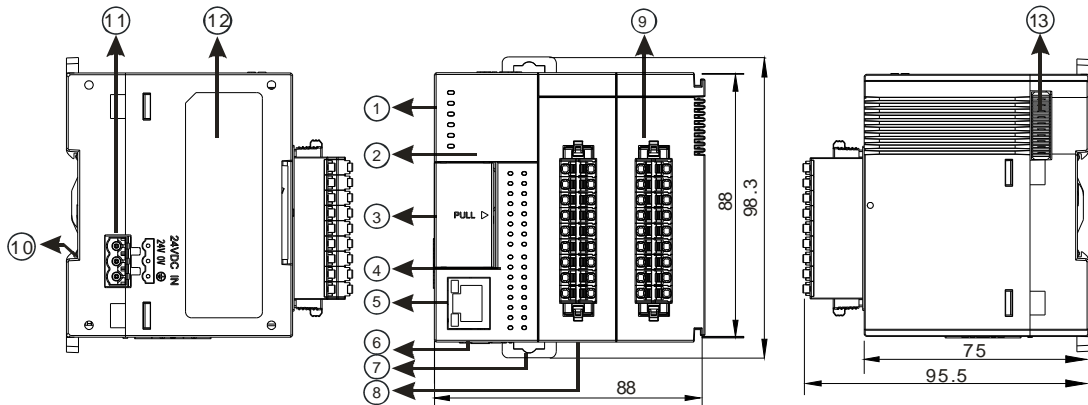

Unit: mm

Number	Name	Description
1	Power LED indicator	Indicates the power status of the CPU module
	Run LED indicator	Operating status of the module ON: the module is running. OFF: the module is stopped. Blinking: the module is detecting an error.
	Error LED indicator	Error status of the module ON: a serious error occurs in the module. OFF: the module is normal. Blinking: a minor error occurs in the module.
	BAT.LOW LED indicator	Indicates the battery status of the CPU module. (Enable/Disable this display in HWCONFIG in ISPSOft)
	COM1 LED COM2 LED CAN LED	Indicates the communication status of the COM/CAN port. OFF: no communication over the COM/CAN port Blinking: communication over the COM/CAN port

Number	Name	Description
2	Model name	Shows the model name of the CPU module.
3	Run/Stop	RUN: execute the programs STOP: stop the programs
	USB port	Mini USB communication port
	SD card slot	Provides an interface for an SD card
	VR0/VR1	VR0: use the flag SM166 to activate the values in SR166 VR1: use the flag SM167 to activate the values in SR167
4	Input/Output LED indicator	If there is an input signal, the input LED indicator is ON. If there is an output signal, the output LED indicator is ON.
5	Ethernet port	Provides an interface for a n Ethernet communication
6	COM1/COM2	Provides an interface for RS-485 communication
7	DIN rail clip	Secures the DIN rail
8	CAN port	Provides an interface for CAN communication
9	Removable terminal blocks	For wiring the input and output
10	Grounding clip	For grounding
11	Power supply	For power supply
12	Label	Nameplate
13	External module port	Connects the modules

● AS100 Series (AS132T-A/AS132P-A/AS132R-A/AS148T-A/AS148P-A/AS148R-A/AS164T-A/AS164P-A/AS164R-A)

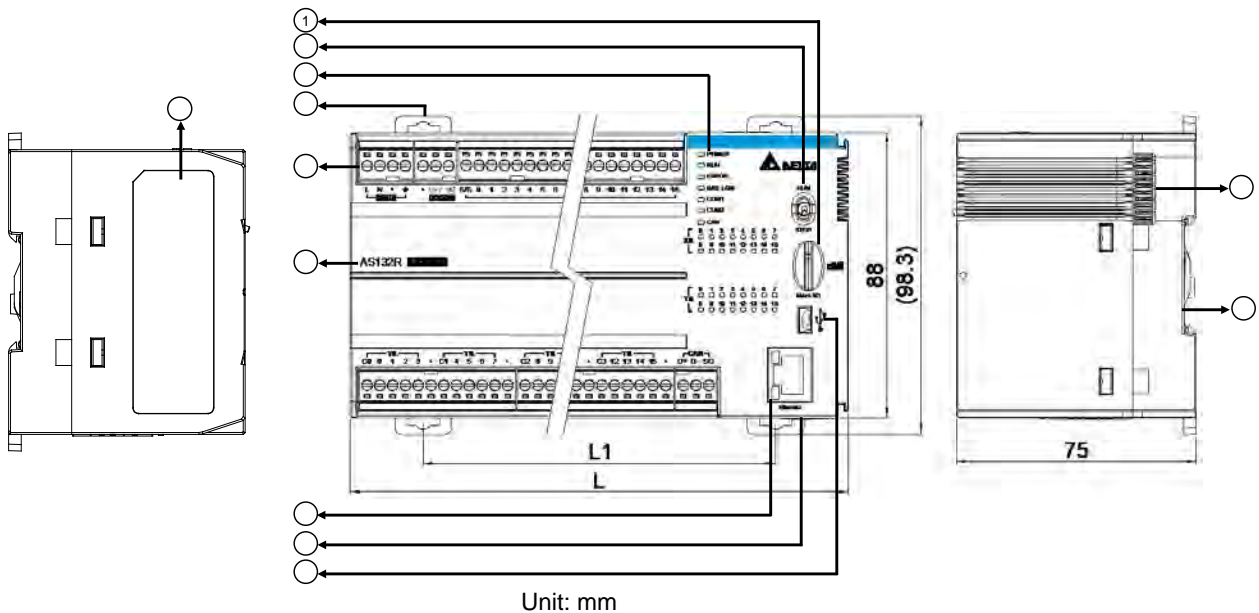

Model name	AS132R/T/P-A	AS148R/T/P-A	AS164R/T/P-A
L	156	207	249.5
Model name	AS132R/T/P-A	AS148R/T/P-A	AS164R/T/P-A
L1	110.3	161.3	203.8

2

Number	Name	Description
1	SD card slot	Provides an interface for an SD card
2	Run/Stop	RUN: execute the programs STOP: stop the programs
3	Power LED indicator	Indicates the power status of the CPU module
	Run LED indicator	Operating status of the module ON: the module is running. OFF: the module is stopped. Blinking: the module is detecting an error.
	Error LED indicator	Error status of the module ON: a serious error occurs in the module. OFF: the module is normal. Blinking: a minor error occurs in the module.
	BAT.LOW LED indicator	Indicates the battery status of the CPU module. (Enable/Disable this display in HWCONFIG in ISPSofT)
	COM1 LED COM2 LED CAN LED	Indicates the communication status of the COM/CAN port. OFF: no communication over the COM/CAN port Blinking: communication over the COM/CAN port
4	DIN rail clip	Secures the DIN rail
5	Removable terminal blocks	Connects the wirings of power, input/output and CAN communication.
6	Model name	Shows the model name of the CPU module.
7	Ethernet port	Provides an interface for a n Ethernet communication
8	COM1/COM2	Provides an interface for RS-485 communication
9	USB port	Mini USB communication port
10	External module port	Connects the modules
11	Grounding clip	For grounding
12	Label	Nameplate

● MIL connector, extension cable, and wiring modules (for AS332T-A/AS332P-A/AS324MT-A)

1. Extension Cable UC-ET010-24D (1M) / UC-ET020-24D (2M) / UC-ET030-24D (3M)

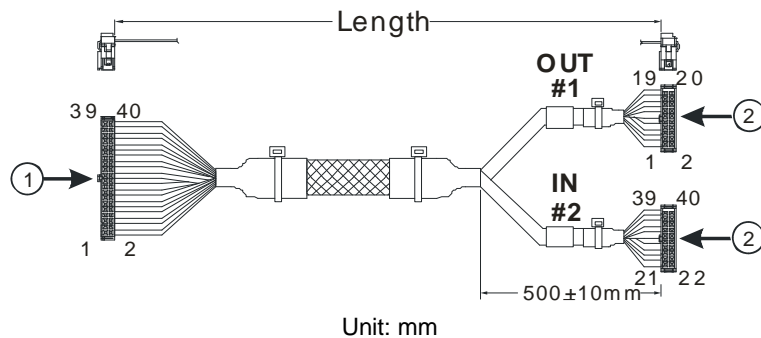

Number	Name	Description
1	IDC 40-pin terminal	Connects a digital input/output module and an external terminal module.
2	IDC 20-pin terminal	Connects the external terminal modules UB-10-ID16A/UB-10-OR16A/UB-10-OR16B

2. AS332T-A/AS332P-A/AS324MT-A and the external terminal module UB-10-ID16A

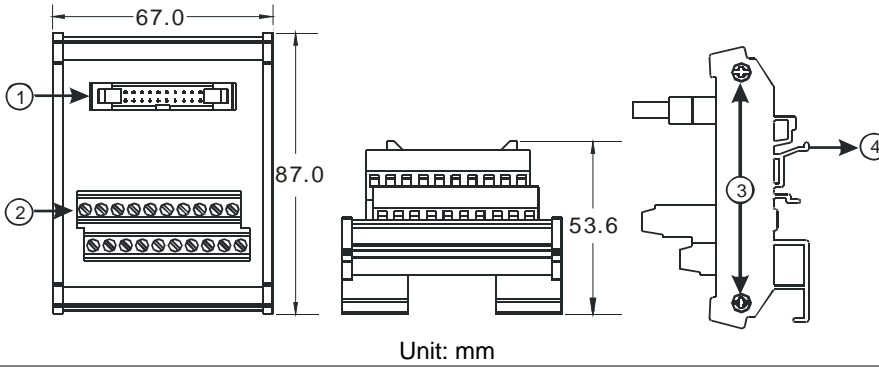

Number	Name	Description
1	20-pin MIL connector	Connects the external terminal module and a wiring module
2	Terminals	Input/Output terminals for wiring
3	Clip	Hangs the external terminal module on a DIN rail
4	Set screw	Fixes the base

3. AS332T-A and the external terminal module UB-10-OR16A/AS332P-A, and UB-10-OR16B

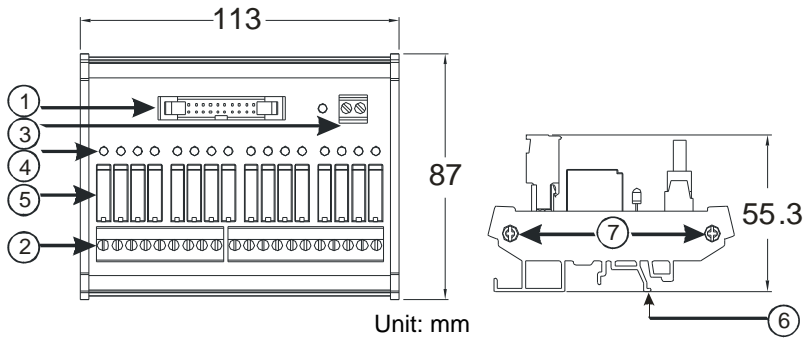

Number	Name	Description
1	20-pin MIL connector	Connects the external terminal module and a wiring module
2	Terminals	Input/Output terminals for wiring
3	2-pin power input terminal	Power input terminal for wiring
4	Output LED indicator	If there is an output signal, the output LED indicator is ON.
5	Relay output	Relay output
6	Clip	Hangs the external terminal module on a DIN rail
7	Set screw	Fixes the base

● Spring clamp/MIL connector terminal block UB-10-IO32D for AS332T-A/AS332P-A/AS324MT-A

2

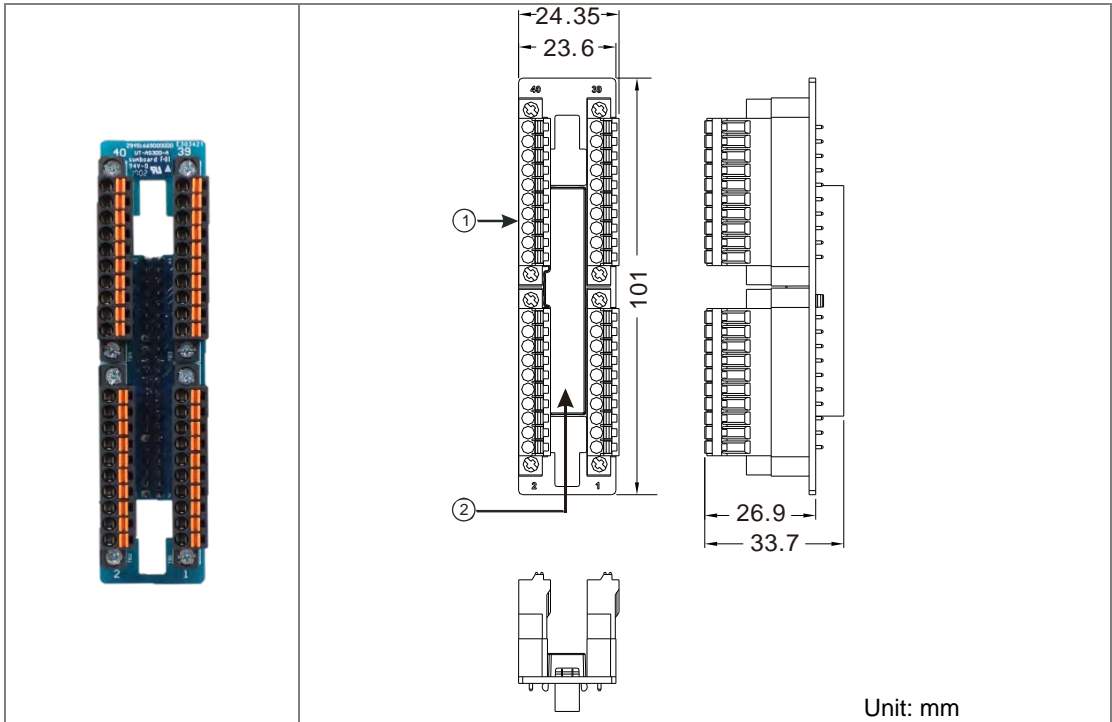

Number	Name	Description
1	Terminal block for output	Terminal block
2	40-pin MIL connector	Connects the module and the wiring module

Note: It is suggested to use simple test for input and output points. Its right-side cannot be connected to the same terminal block typed module, e.g. 64 points DIO module to prevent two terminal blocks from interfering with each other.

2.2.4 CPU Module Input/Output Terminals

● AS300 Series PLC CPU

AS332P-A			AS332T-A		
	-	-	-	-	-
	S/S	S/S	S/S	S/S	S/S
	X0.15	X0.14	X0.15	X0.14	X0.14
	X0.13	X0.12	X0.13	X0.12	X0.12
	X0.11	X0.10	X0.11	X0.10	X0.10
	X0.9	X0.8	X0.9	X0.8	X0.8
	X0.7	X0.6	X0.7	X0.6	X0.6
	X0.5	X0.4	X0.5	X0.4	X0.4
	X0.3	X0.2	X0.3	X0.2	X0.2
	X0.1	X0.0	X0.1	X0.0	X0.0
	C0	C0	-	-	-
	-	-	C0	C0	C0
	Y0.15	Y0.14	Y0.15	Y0.14	Y0.14
	Y0.13	Y0.12	Y0.13	Y0.12	Y0.12
	Y0.11	Y0.10	Y0.11	Y0.10	Y0.10
	Y0.9	Y0.8	Y0.9	Y0.8	Y0.8
Y0.7	Y0.6	Y0.7	Y0.6	Y0.6	
Y0.5	Y0.4	Y0.5	Y0.4	Y0.4	
Y0.3	Y0.2	Y0.3	Y0.2	Y0.2	
Y0.1	Y0.0	Y0.1	Y0.0	Y0.0	
AS324MT-A			AS320T-B/AS320P-B		
	S/S	S/S	S/S	S/S	S/S
	X0.11	X0.10	X0	X1	X1
	X0.9	X0.8	X2	X3	X3
	X0.7	X0.6	X4	X5	X5
	X0.5	X0.4	X6	X7	X7
	SG0	SG0	C0	C0	C0
	X0.3-	X0.3+	Y0	Y1	Y1
	X0.2-	X0.2+	Y2	Y3	Y3
	X0.1-	X0.1+	Y4	Y5	Y5
	X0.0-	X0.0+	Y6	Y7	Y7
	C0	C0	Y8	Y9	Y9
	Y0.11	Y0.10	Y10	Y11	Y11
	Y0.9	Y0.8			
	Y0.7	Y0.6			
	Y0.5	Y0.4			
	SG1	SG1			
Y0.3-	Y0.3+				
Y0.2-	Y0.2+				
Y0.1-	Y0.1+				
Y0.0-	Y0.0+				

● AS200 Series PLC CPU

AS218RX-A/AS218TX-A/AS218PX-A				
<p>Legend: ○ POWER ○ RUN ○ ERROR ○ BAT. LOW ○ COM1 ○ COM2</p> <p>IN: 0-15 OUT: 0-11 Ethernet: 0-7 CAN: 0-7</p>	AIO		DIO	
	V1+	V2+	S/S	C0
	I1+	I2+	X0.0	Y0.0
	V1-	V2-	X0.1	Y0.1
	-	-	X0.2	Y0.2
	VO1	VO2	X0.3	-
	IO1	IO2	X0.4	C1
	AG	AG	X0.5	Y0.3
	-	-	X0.6	Y0.4
	-	⏏	X0.7	Y0.5
AS228R-A/AS228T-A/AS228P-A				
<p>Legend: ○ POWER ○ RUN ○ ERROR ○ BAT. LOW ○ COM1 ○ COM2</p> <p>IN: 0-15 OUT: 0-11 Ethernet: 0-7 CAN: 0-7</p>	IN		OUT	
	S/S	S/S	C0	C1
	X0.0	X0.1	Y0.0	Y0.4
	X0.2	X0.3	Y0.1	Y0.5
	X0.4	X0.5	Y0.2	Y0.6
	X0.6	X0.7	Y0.3	Y0.7
	X0.8	X0.9	-	-
	X0.10	X0.11	-	C2
	X0.12	X0.13	Y0.8	Y0.9
	X0.14	X0.15	Y0.10	Y0.11

2

● AS100 Series PLC CPU

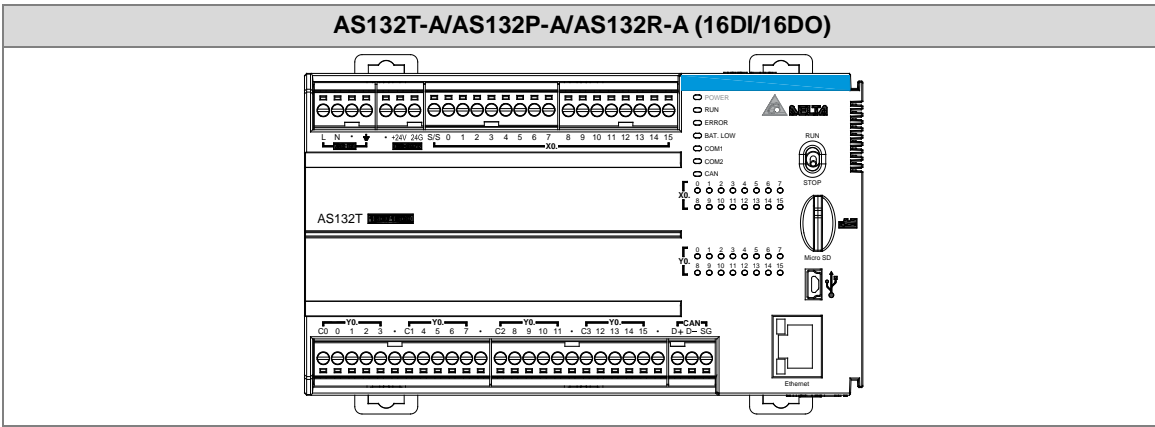

Upper row		1	2	3	4	5	6	7	8	9	10	11	12	13	14	15	16	17	18	19	20	
AS132		L	N	•	⏏	•	+24V	24G	S/S0	X0.0	X0.1	X0.2	X0.3	X0.4	X0.5	X0.6	X0.7	X0.8	X0.9	X0.10	X0.11	
		21	22	23	24																	
		X0.12	X0.13	X0.14	X0.15																	
Lower row		1	2	3	4	5	6	7	8	9	10	11	12	13	14	15	16	17	18	19	20	
AS132		C0	Y0.0	Y0.1	Y0.2	Y0.3	•	C1	Y0.4	Y0.5	Y0.6	Y0.7	•	C2	Y0.8	Y0.9	Y0.10	Y0.11	•	C3	Y0.12	
		21	22	23	24	25	26	27														
		Y0.13	Y0.14	Y0.15	•	D+	D-	SG														

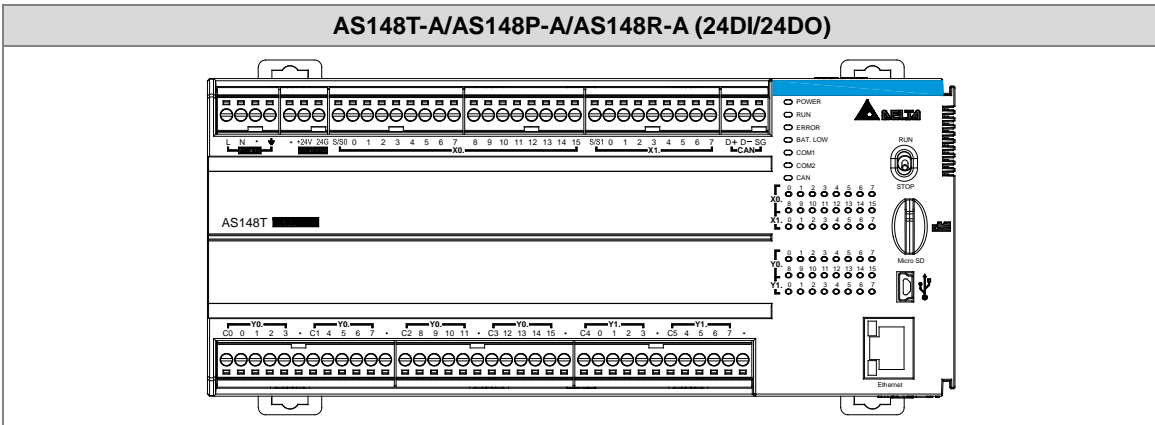

Upper row		1	2	3	4	5	6	7	8	9	10	11	12	13	14	15	16	17	18	19	20	
AS148		L	N	•	⏏	•	+24V	24G	S/S0	X0.0	X0.1	X0.2	X0.3	X0.4	X0.5	X0.6	X0.7	X0.8	X0.9	X0.10	X0.11	
		21	22	23	24	25	26	27	28	29	30	31	32	33	34	35	36					
		X0.12	X0.13	X0.14	X0.15	S/S1	X1.0	X1.1	X1.2	X1.3	X1.4	X1.5	X1.6	X1.7	D+	D-	SG					
Lower row		1	2	3	4	5	6	7	8	9	10	11	12	13	14	15	16	17	18	19	20	
AS148		C0	Y0.0	Y0.1	Y0.2	Y0.3	•	C1	Y0.4	Y0.5	Y0.6	Y0.7	•	C2	Y0.8	Y0.9	Y0.10	Y0.11	•	C3	Y0.12	
		21	22	23	24	25	26	27	28	29	30	31	32	33	34	35	36					
		Y0.13	Y0.14	Y0.15	•	C4	Y1.0	Y1.1	Y1.2	Y1.3	•	C5	Y1.4	Y1.5	Y1.6	Y1.7	•					

2

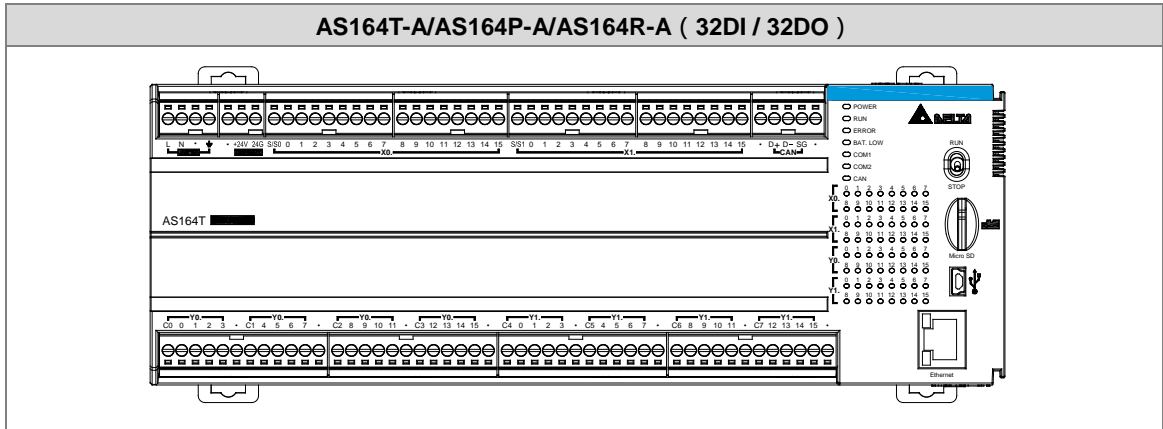

Upper row		1	2	3	4	5	6	7	8	9	10	11	12	13	14	15	16	17	18	19	20
AS164	L	N	•	⊥	•	+24V	24G	S/S0	X0.0	X0.1	X0.2	X0.3	X0.4	X0.5	X0.6	X0.7	X0.8	X0.9	X0.10	X0.11	
	X0.12	X0.13	X0.14	X0.15	S/S1	X1.0	X1.1	X1.2	X1.3	X1.4	X1.5	X1.6	X1.7	X1.8	X1.9	X1.10	X1.11	X1.12	X1.13	X1.14	
	X1.15	•	D+	D-	SG	•															
Lower row		1	2	3	4	5	6	7	8	9	10	11	12	13	14	15	16	17	18	19	20
AS164	C0	Y0.0	Y0.1	Y0.2	Y0.3	•	C1	Y0.4	Y0.5	Y0.6	Y0.7	•	C2	Y0.8	Y0.9	Y0.10	Y0.11	•	C3	Y0.12	
	Y0.13	Y0.14	Y0.15	•	C4	Y1.0	Y1.1	Y1.2	Y1.3	•	C5	Y1.4	Y1.5	Y1.6	Y1.7	•	C6	Y1.8	Y1.9	Y1.10	
	Y1.11	•	C7	Y1.12	Y1.13	Y1.14	Y1.15	•													

- MIL connector and the external terminal module UB-10-ID16A for AS332T-A / AS332P-A / AS324MT-A

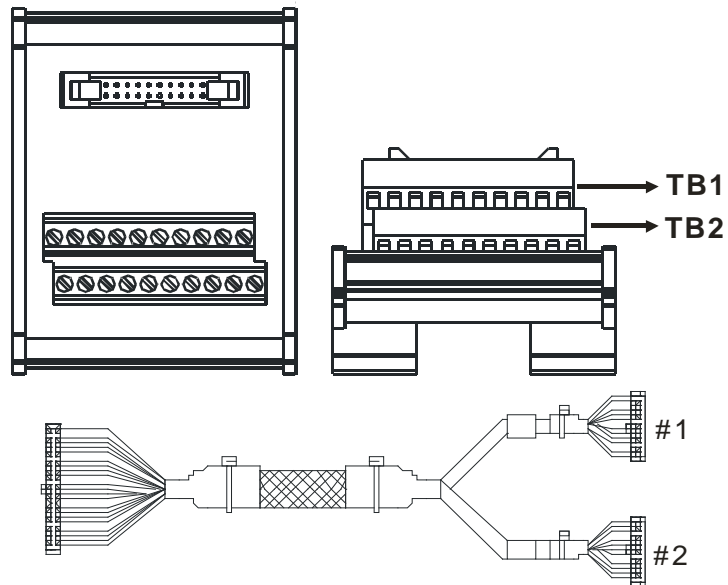

AS332T-A											
#1	TB1	Y0.0	Y0.2	Y0.4	Y0.6	Y0.8	Y0.10	Y0.12	Y0.14	C0	-
	TB2	Y0.1	Y0.3	Y0.5	Y0.7	Y0.9	Y0.11	Y0.13	Y0.15	C0	-
#2	TB1	X0.0	X0.2	X0.4	X0.6	X0.8	X0.10	X0.12	X0.14	S/S	-
	TB2	X0.1	X0.3	X0.5	X0.7	X0.9	X0.11	X0.13	X0.15	S/S	-

AS332P-A											
#1	TB1	Y0.0	Y0.2	Y0.4	Y0.6	Y0.8	Y0.10	Y0.12	Y0.14	-	C0
	TB2	Y0.1	Y0.3	Y0.5	Y0.7	Y0.9	Y0.11	Y0.13	Y0.15	-	C0
#2	TB1	X0.0	X0.2	X0.4	X0.6	X0.8	X0.10	X0.12	X0.14	S/S	-
	TB2	X0.1	X0.3	X0.5	X0.7	X0.9	X0.11	X0.13	X0.15	S/S	-

AS324MT-A											
#1	TB1	Y0.0+	Y0.1+	Y0.2+	Y0.3+	SG1	Y0.4	Y0.6	Y0.8	Y0.10	C0
	TB2	Y0.0-	Y0.1-	Y0.2-	Y0.3-	SG1	Y0.5	Y0.7	Y0.9	Y0.11	C0
#2	TB1	X0.0+	X0.1+	X0.2+	X0.3+	SG0	X0.4	X0.6	X0.8	X0.10	S/S
	TB2	X0.0-	X0.1-	X0.2-	X0.3-	SG0	X0.5	X0.7	X0.9	X0.11	S/S

- Spring clamp/MIL connector terminal block UB-10-IO32D for AS332T-A/AS332P-A/AS324MT-A

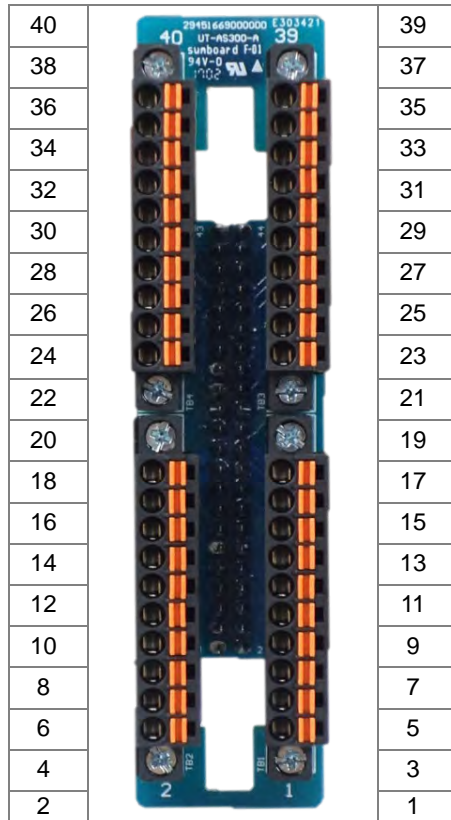

2.2.5 AS200 Input/Output Terminals

- **Analog Input**

Two analog signal input channels:

Item	Voltage Input	Current input
Analog Signal	-10 to +10 V	-20 to 20 mA 4 to 20mA (for FW V1.08 or later)
Resolution	12-bit	11-bit
Input impedance	$\geq 1 \text{ M}\Omega$	250 Ω
Conversion time	3 ms / CH	
Analog to digital conversion range	-2000 to 2000	-1000 to 1000 (-20 to 20 mA) 0 to 1000 (4 to 20mA)
Digital value output	SR168 (CH1)	SR169 (CH2)

You can use the program to read the values in SR to obtain the corresponding A/D conversion value for the channel.

- **Analog Output**

Two analog signal output channels:

Item	Voltage output	Current output
Analog Signal	-10 to +10 V	0 to 20 mA
Resolution	12-bit	12-bit
Impedance allowance	$\geq 1 \text{ k}\Omega$	$\leq 500 \Omega$
Conversion time	2ms / CH	
Analog to digital conversion range	-2000 to 2000	0 to 4000
Digital value output	SR172 (CH1)	SR173 (CH2)

You can use the instruction MOV to move the value to the SR to obtain the corresponding voltage output value.

2.3 Digital Input/Output Module Specifications

2.3.1 General Specifications

- Electrical specifications for the inputs on digital input/output modules

(The signals passing through the inputs are 24 VDC signals.)

Module name	08AM10N -A	16AM10N -A	32AM10N -A	64AM10N -A	16AP11R A	16AP11T -A	16AP11P -A
Number of inputs	8	16	32	64	8	8	8
Connector type	Removable terminal block		MIL connector		Removable terminal block		
Input type	Digital input						
Input form	Direct current (sinking or sourcing)						
Input voltage/ current	24 VDC · 5 mA			24 VDC 3.2 mA	24 VDC · 5 mA		
Input impedance	4.7 k Ω			7.5k Ω	4.7 k Ω		
Action level	OFF→ON	>15 VDC					
	ON→OFF	<5 VDC					
Response time	OFF→ON	< 20 us					
	ON→OFF	< 200 us					
Software filter time	Setting range: 0 ~ 25 ms; default: 10 ms						
Maximum input frequency	Varies according to the filter time; for example when the filter is 1 ms, the maximum input frequency is 500 Hz, when 2 ms, 250 Hz. Note: CPU scan time also affects the maximum input frequency.						
Input signal	Voltage input Sinking: The inputs are NPN transistors whose collectors are open collectors. Sourcing: The inputs are PNP transistors whose collectors are open collectors.						
Input isolation	500 VAC						
Input display	When the optocoupler is driven, the input LED indicator is ON.						
Weight	100 g	117 g	100 g	140 g	138 g	120 g	120 g

● **Electrical specifications for the outputs on a digital input/output module**

Item		Model	08AN01	16AN01	16AP11	08AN01	16AN01	16AP11	08AN01	16AN01	16AP11
		R-A	R-A	R-A	T-A	T-A	T-A	P-A	P-A	P-A	
Number of outputs			8	16	8	8	16	8	8	16	8
Connector type		Removable terminal block									
Output type		Digital output									
Output form		Relay-R			Transistor-T (sinking)			Transistor-P (sourcing)			
Voltage/ current		240 VAC/24 VDC			5–30 VDC			5–30 VDC *2			
Leakage current		0uA			<10uA			<250uA (@V1.00A0) <10uA (@V1.00A1)			
Max. inrush current		NA			Overcurrent protection			7.5A (Tested condition: Ta = 25 °C, V _{DS} = 30VDC and pulse duration = 1ms)			
Maximum load	Resistance	2A/output, 8A/COM			0.5A/output, 4A/COM			0.5A/output, 4A/COM			
	Inductance	Life cycle curve*2			12 W (24 VDC)			12 W (24 VDC)			
	Bulb	20 W (24 VDC) 100 W (230 VAC)			2 W (24 VDC)			2 W (24 VDC)			
Minimum load		1 mA / 5V									
Maximum output frequency*1	Resistance	1 Hz			100 Hz			100 Hz			
	Inductance	0.5 Hz			0.5 Hz			0.5 Hz			
	Bulb	1 Hz			10 Hz			10 Hz			
Maximum Response time	OFF→ON	< 10 ms			< 0.5 ms			< 0.5 ms			
	ON→OFF	< 10 ms			< 0.5 ms			< 0.5 ms			
Output isolation		1500 VAC			500 VAC						
Weight		120 g	158 g	138 g	100 g	122 g	120 g	100 g	123 g	120 g	

Item		Model	32AN02T-A			64AN02T-A		
Number of outputs			32			64		
Connector type		MIL connector						
Output type		Digital output						
Output form		Transistor-T (sinking)						
Output voltage		5–30 VDC						
Leadage current		<10uA						
Max. inrush current		Overcurrent protection						
Maximum load	Resistance	0.1A/output, 3.2A/COM						
	Inductance	N/A						
	Bulb	N/A						
Minimum load		1 mA / 5V						
Maximum output frequency*1		100 Hz (resistance)						
Maximum Response time	OFF→ON	< 0.5 ms						
	ON→OFF							
Output isolation		500 VAC						

Item \ Model	32AN02T-A	64AN02T-A
Weight	100 g	142 g

*1: The scan cycle affects the frequency. Here shows the maximum output frequency. The load type should be taken into account while designing for the application.

*2: Life cycle curve: The lifetime of a relay terminal varies with the working voltage, the load type (the power factor $\cos\psi$, the time constant $t(L/R)$), and the current passing through the terminal. The relation is shown in the life cycle curve below.

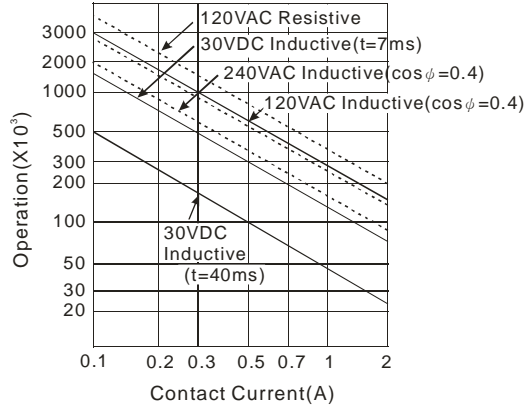

2.3.2 Digital Input/Output Module Profiles

- AS08AM10N-A/AS08AN01P-A/AS08AN01R-A/AS08AN01T-A

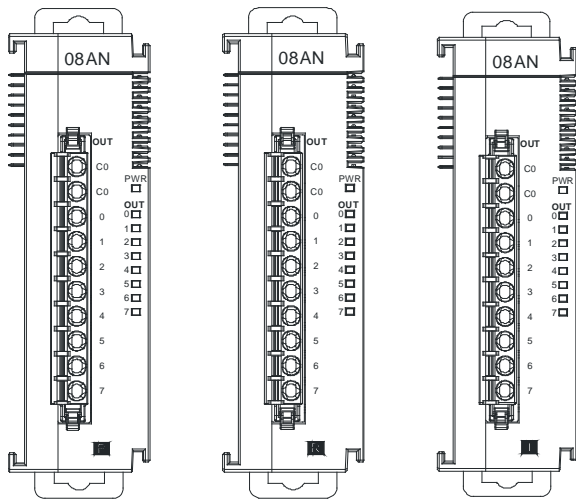
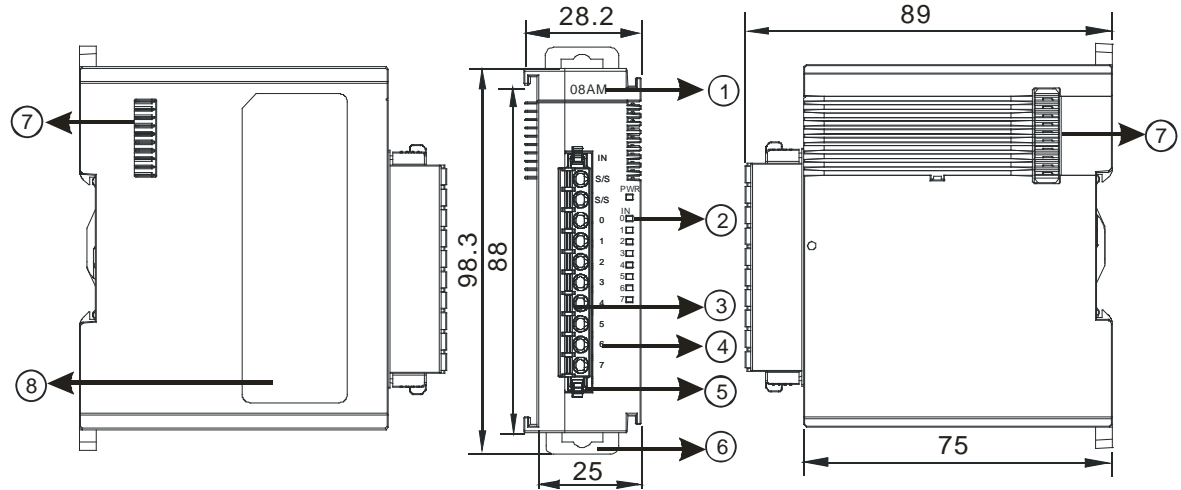

Unit: mm

Number	Name	Description
1	Model name	Model name of the module
2	Input/output LED indicator	If there is an input signal, the input LED indicator is ON. If there is an output signal, the output LED indicator is ON.
3	Removable terminal block	The inputs are connected to sensors. The outputs are connected to loads to be driven.
4	Arrangement of the input/output terminals	Arrangement of the terminals
5	Terminal block clip	Secures the terminal block
6	DIN rail clip	Secures the DIN rail
7	External module port	Connects the modules
8	Label	Nameplate

- AS16AM10N-A/AS16AN01P-A/AS16AN01R-A/AS16AN01T-A/AS16AP11P-A/AS16AP11R-A/AS16AP11T-A

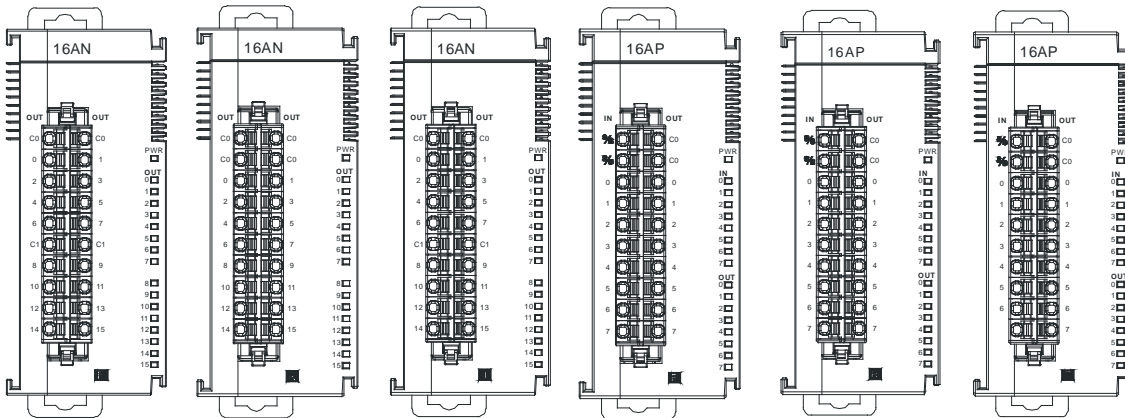
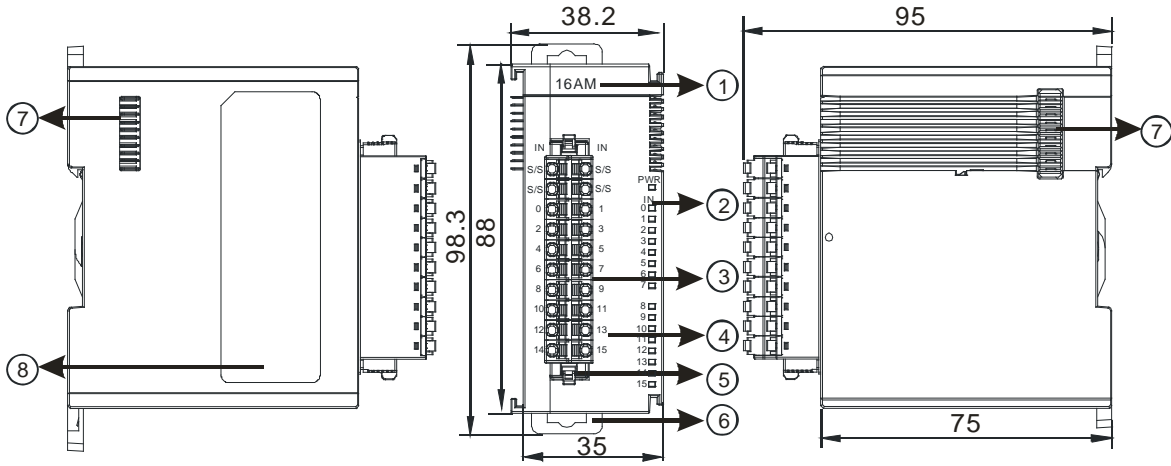

Unit: mm

Number	Name	Description
1	Model name	Model name of the module
2	Input/Output LED indicator	If there is an input signal, the input LED indicator is ON. If there is an output signal, the output LED indicator is ON.
3	Removable terminal block	The inputs are connected to sensors. The outputs are connected to loads to be driven.
4	Arrangement of the input/output terminals	Arrangement of the terminals
5	Terminal block clip	Secures the terminal block
6	DIN rail clip	Secures the DIN rail
7	External module port	Connects the modules
8	Label	Nameplate

● AS32AM10N-A

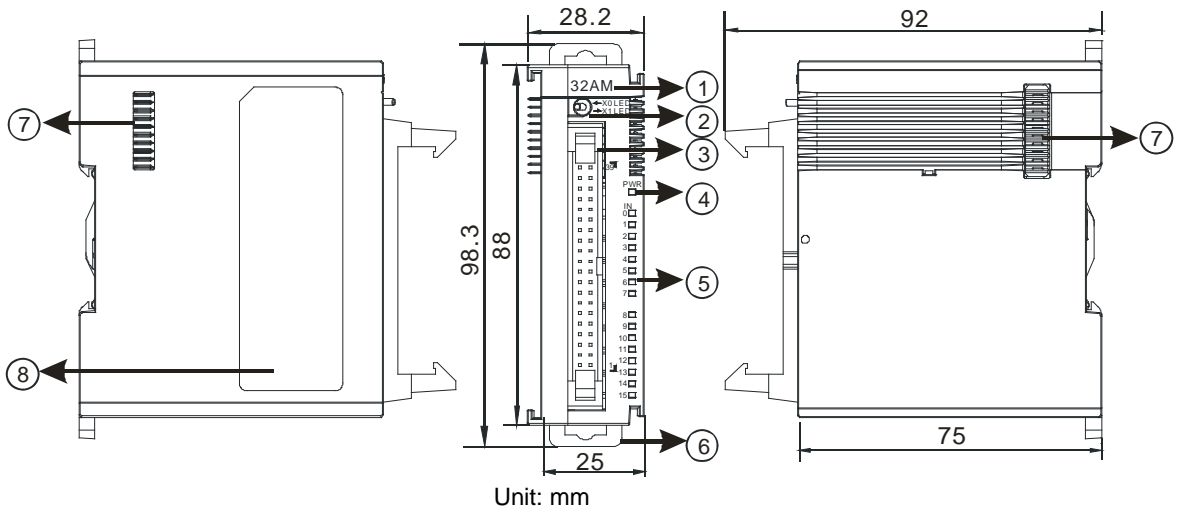

Number	Name	Description
1	Model name	Model name of the module
2	X0/X1 LED Indicator switch	Switches the LED indicators to their represented inputs.
3	ML connector	For the external I/O connecting cables UC-ET010-24B, UC-ET020-24B, UC-ET030-24B
4	Power LED indicator	Indicates the power status of the module
5	Input LED indicator	LED indicator is ON during input.
6	DIN rail clip	Secures the DIN rail
7	External module port	Connects the modules
8	Label	Nameplate

● AS32AN02T-A

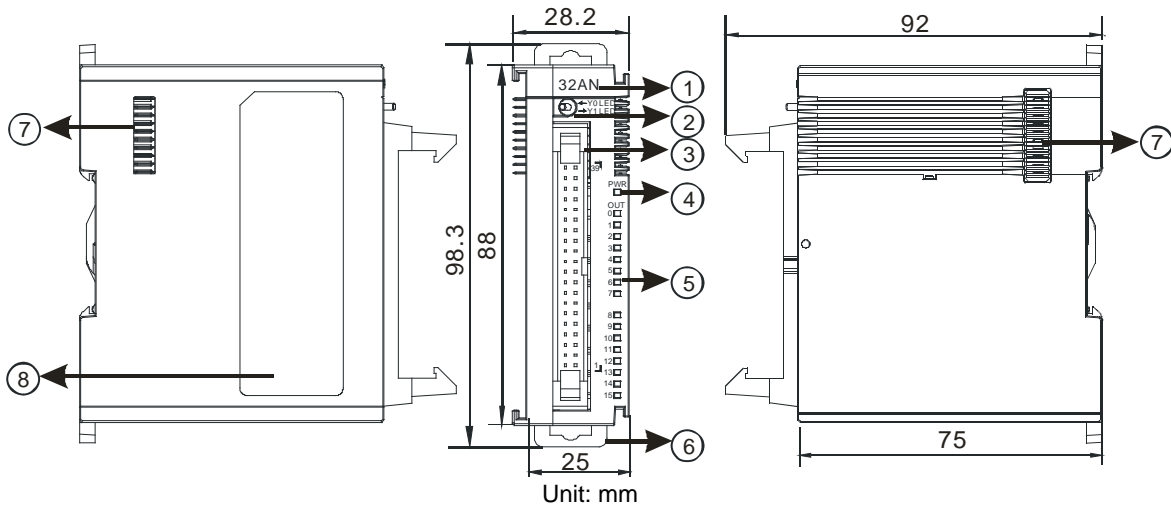

Number	Name	Description
1	Model name	Model name of the module
2	Y0/Y1 LED indicator switch	Switches the LED indicators to their represented outputs.
3	ML connector	For the external I/O connecting cables UC-ET010-24D, UC-ET020-24D, UC-ET030-24D
4	Power LED indicator	Indicates the power status of the module
5	Output LED indicator	LED indicator is ON during output.
6	DIN rail clip	Secures the DIN rail
7	External module port	Connects the modules
8	Label	Nameplate

● AS64AM10N-A

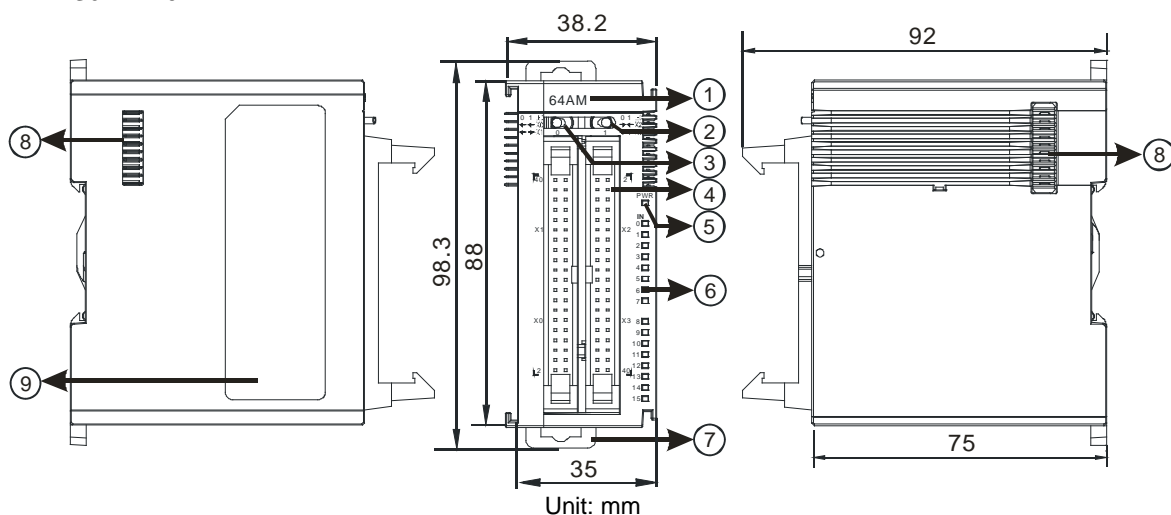

Number	Name	Description
1	Model name	Model name of the module
2	LED indicator switch 1	Switches the LED indicators to their represented inputs.
3	LED indicator switch 2	Switches the LED indicators to their represented inputs.
4	ML connector	For the external I/O connecting cables UC-ET010-24B, UC-ET020-24B, UC-ET030-24B
5	Power LED indicator	Indicates the power status of the module
6	Input LED indicator	If there is an input signal, the input LED indicator is ON.
7	DIN rail clip	Secures the DIN rail
8	External module port	Connects the modules
9	Label	Nameplate

● AS64AN02T-A

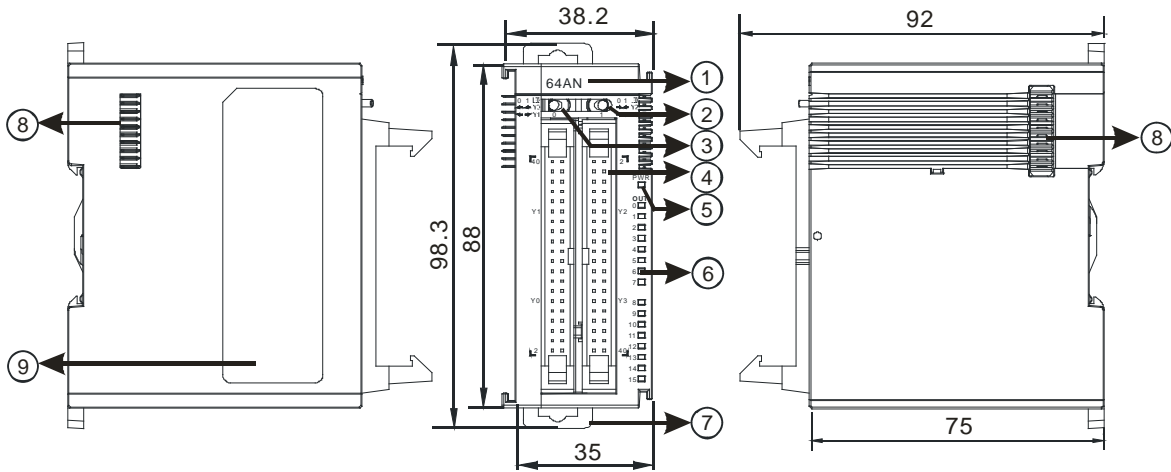

Unit: mm

Number	Name	Description
1	Model name	Model name of the module
2	LED indicator switch 1	Switches the LED indicators to their represented outputs.
3	LED indicator switch 2	Switches the LED indicators to their represented outputs.
4	ML connector	For the external I/O connecting cables UC-ET010-24D, UC-ET020-24D, UC-ET030-24D
5	Power LED indicator	Indicates the power status of the module
6	Output LED indicator	If there is an output signal, the output LED indicator is ON.
7	DIN rail clip	Secures the DIN rail
8	External module port	Connects the modules
9	Label	Nameplate

● **ML connector, extension cable, and wiring modules**

1. Extension Cable UC-ET010-24D (1M) / UC-ET020-24D (2M) / UC-ET030-24D (3M)

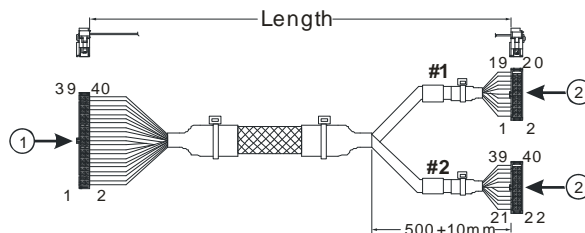

Unit: mm

Number	Name	Description
1	IDC 40-pin terminal	Connects a digital input/output module and an external terminal module.
2	IDC 20-pin terminal	Connects the external terminal modules UB-10-ID16A/UB-10-OR16A/UB-10-OR16B

2. I/O connecting cables UC-ET010-24B (1M) / UC-ET020-24B (2M) / UC-ET030-24B (3M)

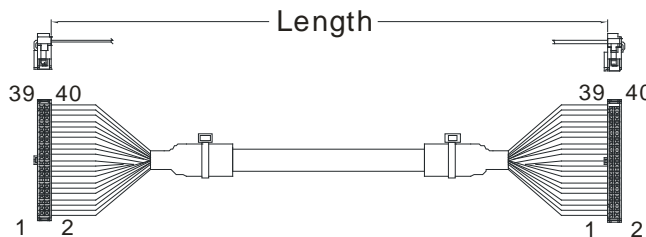

Number	Name	Description
1	IDC 40-pin terminal	Connects an external terminal module and a wiring module UB-10-ID32A, and UB-10-OT32A

3. AS32AM10N-A/AS64AM10N-A and the external terminal modules UB-10-ID16A, UB-10-ID32A

◆ UB-10-ID16A

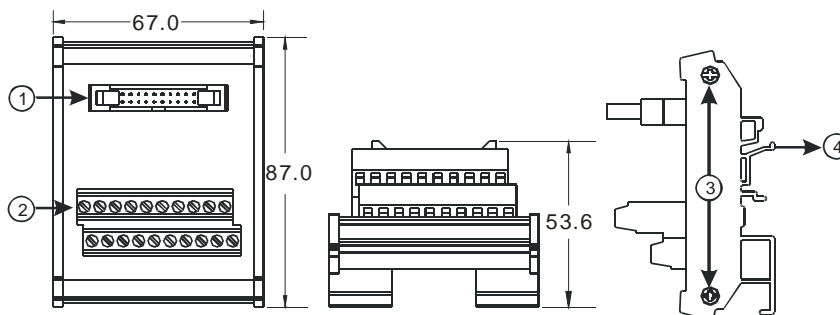

Unit: mm

◆ UB-10-ID32A

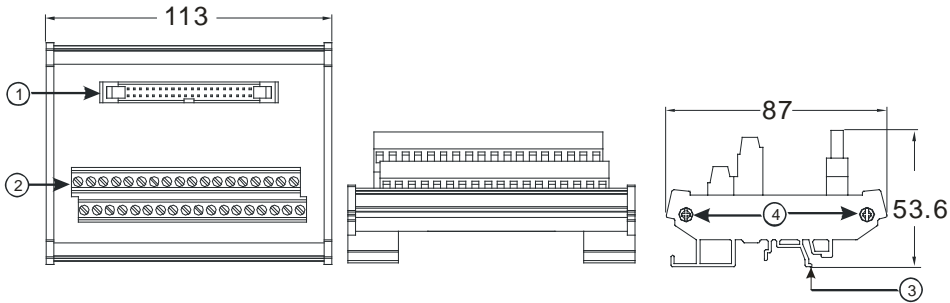

Unit: mm

Number	Name	Description
1	UB-10-ID16A: 20-pin ML connector UB-10-ID32A: 40-pin ML connector	Connects the external terminal module and a wiring module
2	Terminals	Input/Output terminals for wiring
3	Clip	Hangs the external terminal module on a DIN rail
4	Set screw	Fixes the base

4. AS332T-A/AS64AN02T-A and the external terminal modules UB-10-ID16A, UB-10-OR16A, and UB-10-OT32A.

◆ UB-10-ID16A

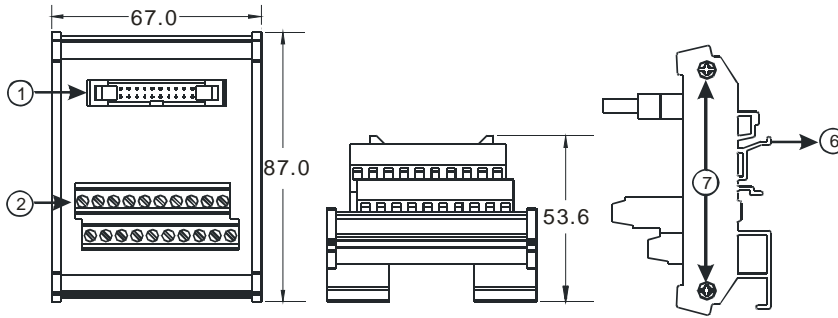

Unit: mm

◆ UB-10-OR16A

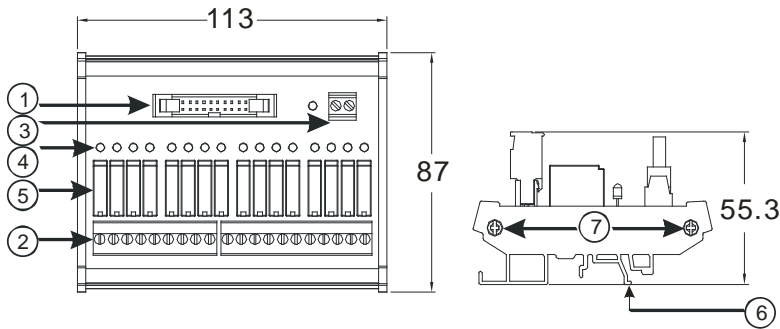

Unit: mm

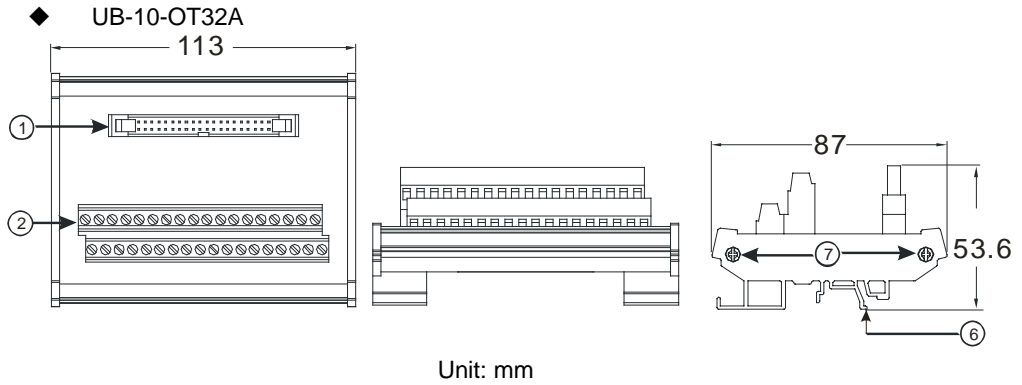

Number	Name	Description
1	UB-10- ID16A /OR16A: 20-pin ML connector UB-10-OT32A: 40-pin ML connector	Connects the external terminal module and a wiring module
2	Terminals	Input/Output terminals for wiring
3	2-pin power input terminal	Power input terminal for wiring
4	Output LED indicator	LED indicator is ON during output.
5	Relay output	Relay output
6	Clip	Hangs the external terminal module on a DIN rail
7	Set screw	Fixes the base

● Spring clamp/MIL connector terminal block UB-10-IO32D for AS32AM10N-A/AS32AN02T-A

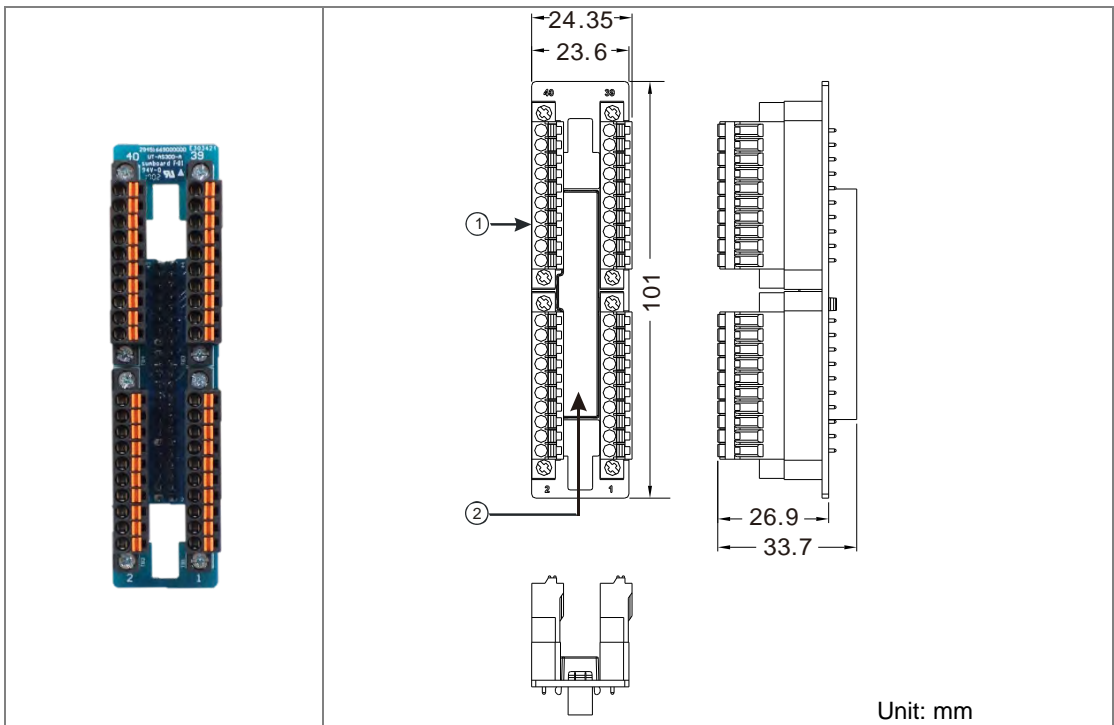

Number	Name	Description
1	Terminal block for output	Terminal block
2	40-pin MIL connector	Connects the module and the wiring module

2.3.3 Digital Input/Output Module Terminals

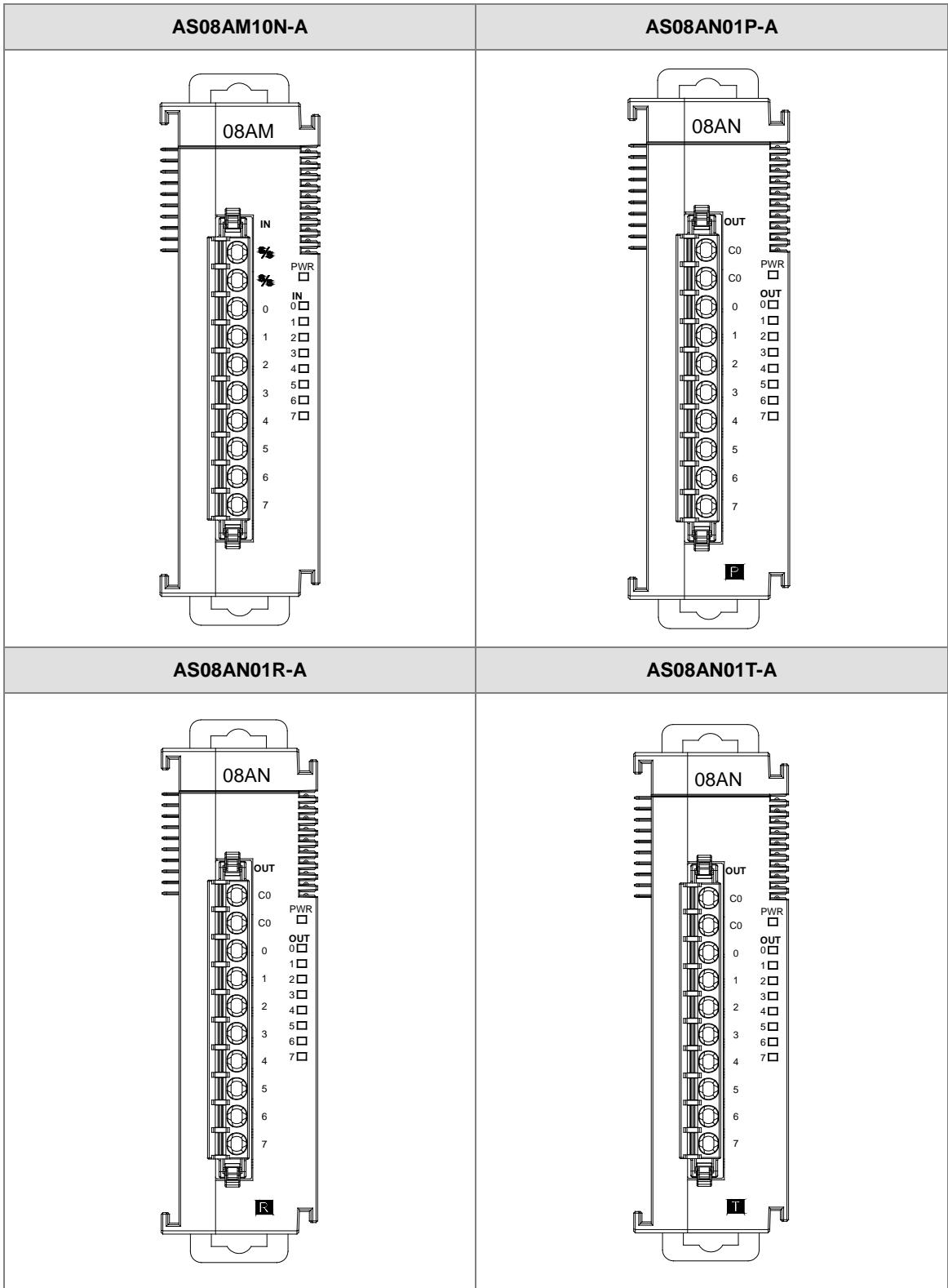

2

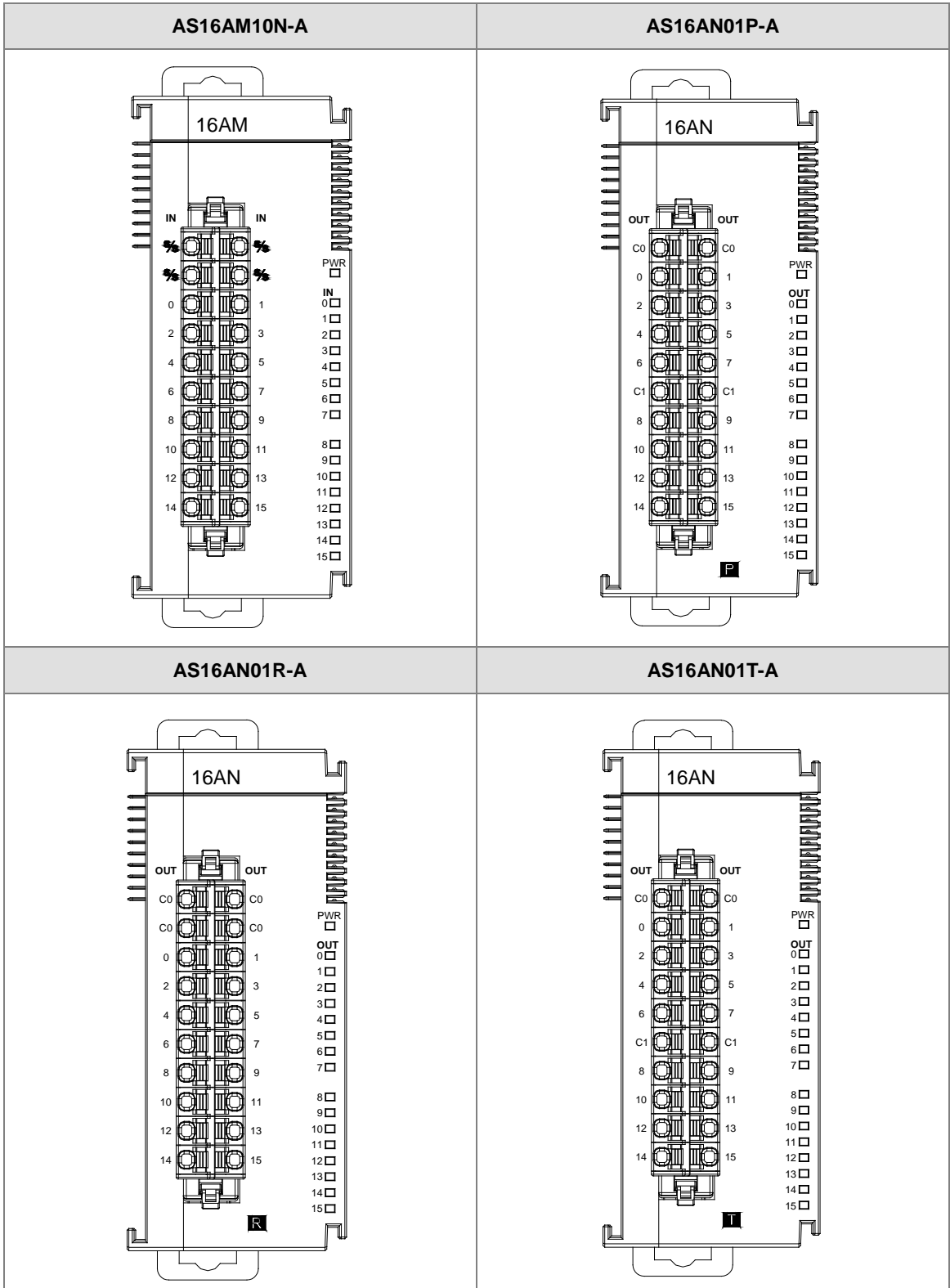

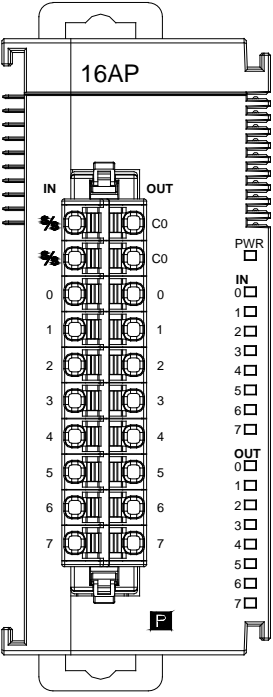
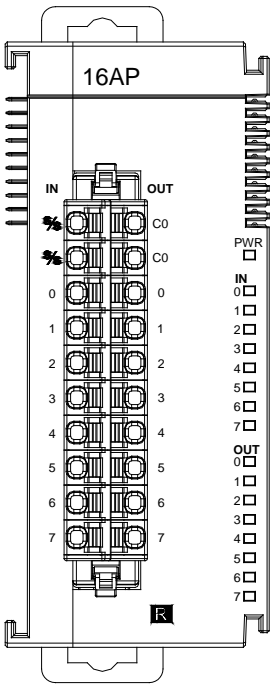
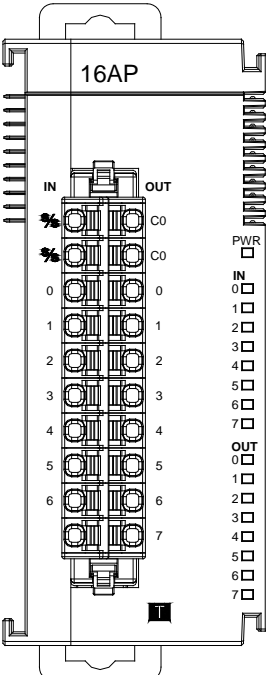
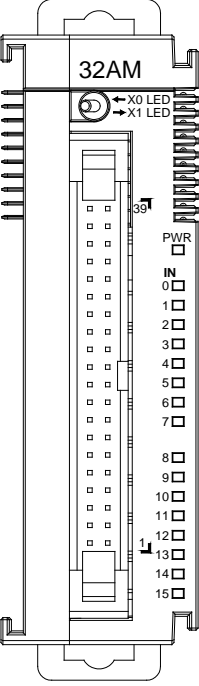
AS16AP11P-A	AS16AP11R-A																																									
																																										
AS16AP11T-A	AS32AM10N-A																																									
		<table border="1"> <tbody> <tr><td>-</td><td>-</td></tr> <tr><td>S/S</td><td>S/S</td></tr> <tr><td>1.15</td><td>1.14</td></tr> <tr><td>1.13</td><td>1.12</td></tr> <tr><td>1.11</td><td>1.10</td></tr> <tr><td>1.9</td><td>1.8</td></tr> <tr><td>1.7</td><td>1.6</td></tr> <tr><td>1.5</td><td>1.4</td></tr> <tr><td>1.3</td><td>1.2</td></tr> <tr><td>1.1</td><td>1.0</td></tr> <tr><td>-</td><td>-</td></tr> <tr><td>S/S</td><td>S/S</td></tr> <tr><td>0.15</td><td>0.14</td></tr> <tr><td>0.13</td><td>0.12</td></tr> <tr><td>0.11</td><td>0.10</td></tr> <tr><td>0.9</td><td>0.8</td></tr> <tr><td>0.7</td><td>0.6</td></tr> <tr><td>0.5</td><td>0.4</td></tr> <tr><td>0.3</td><td>0.2</td></tr> <tr><td>0.1</td><td>0.0</td></tr> </tbody> </table>	-	-	S/S	S/S	1.15	1.14	1.13	1.12	1.11	1.10	1.9	1.8	1.7	1.6	1.5	1.4	1.3	1.2	1.1	1.0	-	-	S/S	S/S	0.15	0.14	0.13	0.12	0.11	0.10	0.9	0.8	0.7	0.6	0.5	0.4	0.3	0.2	0.1	0.0
-	-																																									
S/S	S/S																																									
1.15	1.14																																									
1.13	1.12																																									
1.11	1.10																																									
1.9	1.8																																									
1.7	1.6																																									
1.5	1.4																																									
1.3	1.2																																									
1.1	1.0																																									
-	-																																									
S/S	S/S																																									
0.15	0.14																																									
0.13	0.12																																									
0.11	0.10																																									
0.9	0.8																																									
0.7	0.6																																									
0.5	0.4																																									
0.3	0.2																																									
0.1	0.0																																									

2

AS32AN02T-A		AS64AM10N-A				
	-	-	-	-	-	
	C0	C0	-	-	2.0	2.1
	1.15	1.14	S/S0	S/S0	2.2	2.3
	1.13	1.12	1.15	1.14	2.4	2.5
	1.11	1.10	1.13	1.12	2.6	2.7
	1.9	1.8	1.11	1.10	2.8	2.9
	1.7	1.6	1.9	1.8	2.10	2.11
	1.5	1.4	1.7	1.6	2.12	2.13
	1.3	1.2	1.5	1.4	2.14	2.15
	1.1	1.0	1.3	1.2	S/S	S/S
	-	-	1.1	1.0	-	-
	C0	C0	-	-	3.0	3.1
	0.15	0.14	S/S0	S/S0	3.2	3.3
	0.13	0.12	0.15	0.14	3.4	3.5
	0.11	0.10	0.13	0.12	3.6	3.7
0.9	0.8	0.11	0.10	3.8	3.9	
0.7	0.6	0.9	0.8	3.10	3.11	
0.5	0.4	0.7	0.6	3.12	3.13	
0.3	0.2	0.5	0.4	3.14	3.15	
0.1	0.0	0.3	0.2	S/S1	S/S1	
		0.1	0.0	-	-	

AS64AN02T-A					
	-	-	2.0	2.1	-
	C0	C0	2.2	2.3	-
	1.15	1.14	2.4	2.5	-
	1.13	1.12	2.6	2.7	-
	1.11	1.10	2.8	2.9	-
	1.9	1.8	2.10	2.11	-
	1.7	1.6	2.12	2.13	-
	1.5	1.4	2.14	2.15	-
	1.3	1.2	C1	C1	-
	1.1	1.0	-	-	-
	-	-	3.0	3.1	-
	C0	C0	3.2	3.3	-
	0.15	0.14	3.4	3.5	-
	0.13	0.12	3.6	3.7	-
	0.11	0.10	3.8	3.9	-
0.9	0.8	3.10	3.11	-	
0.7	0.6	3.12	3.13	-	
0.5	0.4	3.14	3.15	-	
0.3	0.2	C1	C1	-	
0.1	0.0	-	-	-	

● **ML connector and the wiring module**

1. AS32AM10N-A/AS64AM10N-A

◆ The wiring module: UB-10-ID16A

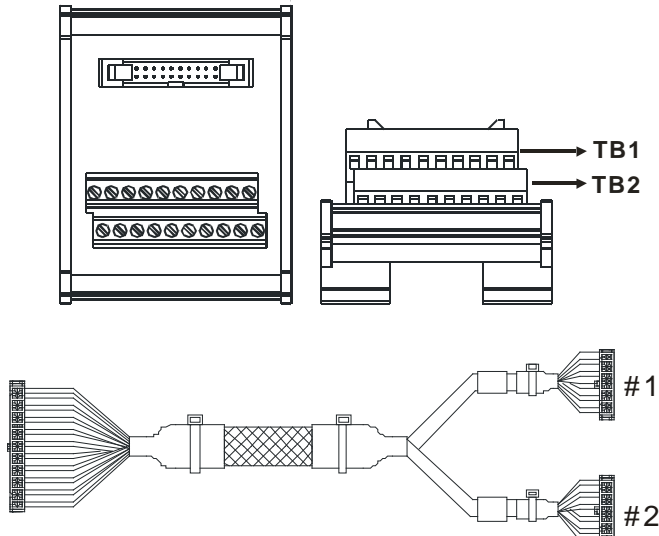

AS32AM10N-A/ AS64AM10N-A											
#2	TB1	X0.0	X0.2	X0.4	X0.6	X0.8	X0.10	X0.12	X0.14	S/S	-
	TB2	X0.1	X0.3	X0.5	X0.7	X0.9	X0.11	X0.13	X0.15	S/S	-

◆ The wiring module: UB-10-ID32A

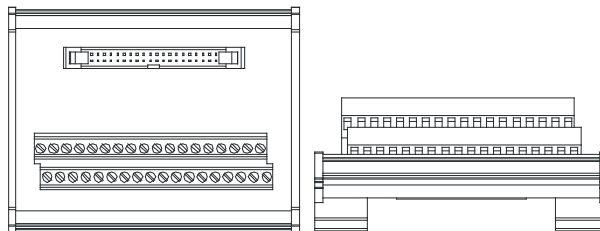

AS series terminals:

Upper row	X0.0	X0.2	X0.4	X0.6	X0.8	X0.10	X0.12	X0.14	X1.0	X1.2	X1.4	X1.6	X1.8	X1.10	X1.12	X1.14	S/S	S/S
Lower row	X0.1	X0.3	X0.5	X0.7	X0.9	X0.11	X0.13	X0.15	X1.1	X1.3	X1.5	X1.7	X1.9	X1.11	X1.13	X1.15	S/S	S/S

2

2. AS32AN02T-A/AS64AN02T-A and the wiring modules:

◆ UB-10-ID16A

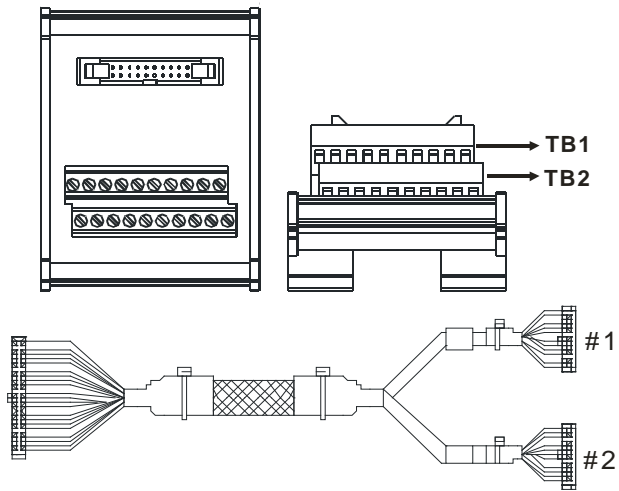

AS332T-A											
#1	TB1	Y0.0	Y0.2	Y0.4	Y0.6	Y0.8	Y0.10	Y0.12	Y0.14	C0	-
	TB2	Y0.1	Y0.3	Y0.5	Y0.7	Y0.9	Y0.11	Y0.13	Y0.15	C0	-

◆ UB-10-OT32A

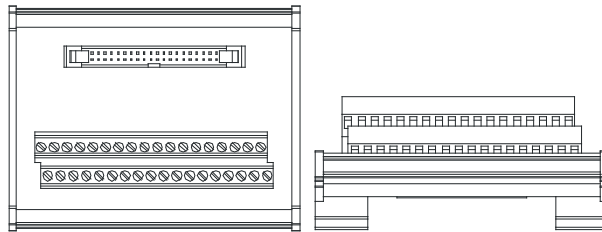

AS series terminals:

Upper row	Y0.0	Y0.2	Y0.4	Y0.6	Y0.8	Y0.10	Y0.12	Y0.14	Y1.0	Y1.2	Y1.4	Y1.6	Y1.8	Y1.10	Y1.12	Y1.14	•	•
Lower row	Y0.1	Y0.3	Y0.5	Y0.7	Y0.9	Y0.11	Y0.13	Y0.15	Y1.1	Y1.3	Y1.5	Y1.7	Y1.9	Y1.11	Y1.13	Y1.15	C0	C0

◆ UB-10-OR16A

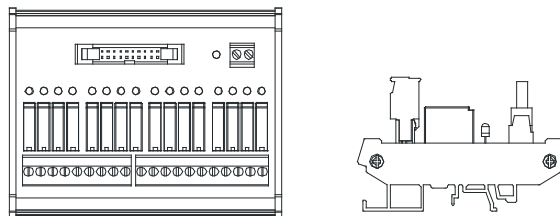

Terminals:

																			GND	+24V
C0	Y0	Y1	Y2	Y3	C1	Y4	Y5	Y6	Y7	C2	Y10	Y11	Y12	Y13	C3	Y14	Y15	Y16	Y17	V

AS series terminals:

																				GND	+24V
C0	Y0.0	Y0.1	Y0.2	Y0.3	C1	Y0.4	Y0.5	Y0.6	Y0.7	C2	Y0.8	Y0.9	Y0.10	Y0.11	C3	Y0.12	Y0.13	Y0.14	Y0.15		

3. AS32AM10N-A/AS32AN02T-A and the wiring modules:

◆ UB-10-IO32D

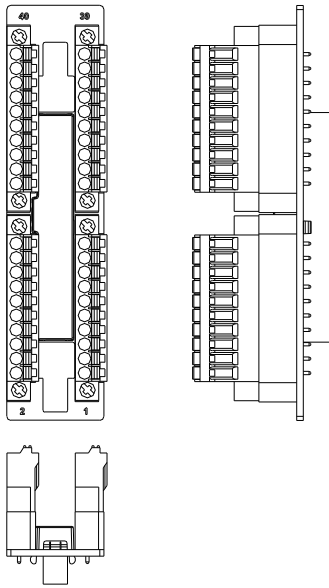

2.4 Analog Input/Output Module Specifications

2.4.1 General Specifications

- AS04AD-A / AS08AD-B / AS08AD-C

Electrical specifications

Module Name	AS04AD-A	AS08AD-B	AS08AD-C
Number of Inputs	4	8	8
Analog-to-Digital Conversion	Voltage input/Current input	Voltage input	Current input
Supply Voltage	24 VDC (20.4 VDC–28.8 VDC) (-15% to +20%)		
Connector Type	Removable terminal block		
Conversion Time	2 ms / channel; for FW V1.02.00 or later, upgraded to 1 ms/channel		
Isolation	An analog circuit is isolated from a digital circuit by a digital integrated circuit/optocoupler, but the analog channels are not isolated from one another. Isolation between a digital circuit and a ground: 500 VAC Isolation between an analog circuit and a ground: 500 VAC Isolation between an analog circuit and a digital circuit: 500 VAC Isolation between the 24 VDC and a ground: 500 VAC		
Weight	145g		

Functional specifications

Analog-to-Digital Conversion	Voltage Input				
Rated Input Range	-10 V ~ +10 V	0 V ~ 10 V	±5 V	0 V ~ 5 V	1 V ~ 5 V
Rated Conversion Range	K-32000 ~ K32000	K0 ~ K32000	K-32000 ~ K32000	K0 ~ K32000	K0 ~ K32000
Hardware Input Limit*1	-10.12V ~ 10.12V	-0.12V ~ 10.12V	-5.06V ~ 5.06V	-0.06V ~ 5.06V	0.95V ~ 5.05V
Conversion Limit*2	K-32384 ~ K32384	K-384 ~ K32384	K-32384 ~ K32384	K-384 ~ K32384	K-384 ~ K32384
Error Rate	Room Temperature: ±0.2% ; Full Temperature Range: ±0.5%				
Hardware Resolution	16 bits				
Input Impedance	2MΩ				
Absolute Input Range*3	±15 V				

*1: If the input signal exceeds the hardware input limit, the module only shows the maximum value. If the input signal is below the lower limit, it only shows the minimum value. And an error flag will be set.

*2: If the input signal exceeds the hardware input limit, it also exceeds the conversion limit and a conversion limit error appears. For example in the voltage input mode (-10 V to +10 V), when the input signal is 10.15 V, exceeding the hardware upper limit, it also exceeds the conversion upper limit. The module uses the upper limit value (32387) as the input signal and a conversion limit error appears.

*3: If an input signal exceeds the absolute range, it might damage the channel.

Analog-to-Digital Conversion	Current Input		
	Rated Input Range	±20 mA	0 mA–20 mA
Rated Conversion Range	K-32000 ~ K+2000	K0 ~ K32000	K0 ~ K32000
Hardware Input Limit*1	-20.24 mA ~ 20.24 mA	-0.24 mA ~ 20.24 mA	3.81 mA ~ 20.19 mA
Conversion Limit*2	K-32384 ~ K32384	K-384 ~ K32384	K-384 ~ K32384
Error Rate	Room Temperature: ±0.2% ; Full Temperature Range: ±0.5%		
Hardware Resolution	16 bits		
Input Impedance	250Ω		
Absolute Input Range*3	±32 mA		

*1: If the input signal exceeds the hardware input limit, the module only shows the maximum value. If the input signal is below the lower limit, it only shows the minimum value. And an error flag will be set.

*2: If the input signal exceeds the hardware input limit, it also exceeds the conversion limit and a conversion limit error appears. For example in the voltage input mode (4 mA to 20 mA), when the input signal is 0 mA, exceeding the hardware upper limit, it also exceeds the conversion upper limit. The module uses the upper limit value (-384) as the input signal and a conversion limit error appears.

*3: If an input signal exceeds the absolute range, it might damage the channel.

- **AS04DA-A**

Electrical specifications

Module name	AS04DA-A
Number of outputs	Four
Digital-to-analog conversion	Voltage output/Current output
Supply voltage	24 VDC (20.4 VDC–28.8 VDC) (-15%–+20%)
Connector type	Removable terminal block
Conversion time	2 ms/channel
Isolation	An analog circuit is isolated from a digital circuit by a digital integrated circuit/an optocoupler, but the analog channels are not isolated from one another. Isolation between a digital circuit and a ground: 500 VAC Isolation between an analog circuit and a ground: 500 VAC Isolation between an analog circuit and a digital circuit: 500 VAC Isolation between the 24 VDC and a ground: 500 VAC
Weight	145 g

Functional specifications

Digital-to-analog conversion	Voltage output				
Rated output range	$\pm 10\text{ V}$	0 V–10 V	$\pm 5\text{ V}$	0 V–5 V	1 V–5 V
Conversion Range	K-32000 ~ K+32000	K0 ~ K32000	K-32000 ~ K+32000	K0 ~ K32000	K0 ~ K32000
Hardware output range	-10.1V to +10.1V	-0.1V to +10.1V	-5.05V to +5.05V	-0.05V to +5.05V	0.95V–5.05V
Error rate (Room temperature)	$\pm 0.2\%$				
Error rate (Full temperature range)	$\pm 0.5\%$				
Linearity error (Room temperature)	$\pm 0.05\%$				
Linearity error (Full temperature range)	$\pm 0.05\%$				
Hardware resolution	12 bits				
Input impedance	$\geq 1\text{ k}\Omega$		$\geq 500\Omega$		

Digital-to-analog conversion	Current output	
Rated output range	0 mA–20 mA	4 mA–20 mA
Conversion Range	K0 ~ K32000	K0 ~ K32000
Hardware output range	-0.2 mA to +20.2 mA	3.8 mA–20.2 mA
Error rate (Room temperature)	$\pm 0.2\%$	
Error rate (Full temperature range)	$\pm 0.5\%$	
Linearity error (Room temperature) (Full temperature range)	$\pm 0.03\%$	
Linearity error	$\pm 0.03\%$	
Hardware resolution	12 bits	
Input impedance	$\leq 550\Omega$	

- AS06XA-A

Electrical specifications

Module name	AS06XA-A
Number of inputs/outputs	Inputs: four; Outputs: two
Analog-to-digital conversion	Voltage input/Current input; Voltage output/Current output;
Supply voltage	24 VDC (20.4 VDC–28.8 VDC) (-15% to +20%)
Connector type	Removable terminal block
Conversion time	2ms/channel; for FW V1.02.00 or later, upgraded to 1 ms/channel
Isolation	An analog circuit is isolated from a digital circuit by a digital integrated circuit/an optocoupler, but the analog channels are not isolated from one another. Isolation between a digital circuit and a ground: 500 VAC Isolation between an analog circuit and a ground: 500 VAC Isolation between an analog circuit and a digital circuit: 500 VAC Isolation between the 24 VDC and a ground: 500 VAC
Weight	145 g

Functional specifications for the analog-to-digital conversion

Analog-to-Digital Conversion	Voltage Input				
	-10 V ~ +10 V	0 V ~ 10 V	±5 V	0 V ~ 5 V	1 V ~ 5 V
Rated Input Range	-10 V ~ +10 V	0 V ~ 10 V	±5 V	0 V ~ 5 V	1 V ~ 5 V
Rated Conversion Range	K-32000	K0	K-32000	K0	K0
	~ K32000	~ K32000	~ K32000	~ K32000	~ K32000
Hardware Input Limit*1	-10.12V	-0.12V	-5.06V	-0.06V	0.95V
	~ 10.12V	~ 10.12V	~ 5.06V	~ 5.06V	~ 5.05V
Conversion Limit*2	K-32384	K-384	K-32384	K-384	K-384
	~ K32384	~ K32384	~ K32384	~ K32384	~ K32384
Error Rate	Room Temperature: ±0.2% ; Full Temperature Range: ±0.5%				
Hardware Resolution	16 bits				
Input Impedance	2MΩ				
Absolute Input Range*3	±15 V				

*1: If the input signal exceeds the hardware input limit, the module only shows the maximum value. If the input signal is below the lower limit, it only shows the minimum value. And an error flag will be set.

*2: If the input signal exceeds the hardware input limit, it also exceeds the conversion limit and a conversion limit error appears. For example in the voltage input mode (-10 V to +10 V), when the input signal is 10.15 V, exceeding the hardware upper limit, it also exceeds the conversion upper limit. The module uses the upper limit value (32384) as the input signal and a conversion limit error appears.

*3: If an input signal exceeds the absolute range, it might damage the channel.

Analog-to-Digital Conversion	Current Input		
Rated Input Range	±20 mA	0 mA–20 mA	4 mA–20 mA
Rated Conversion Range	K-32000 ~ K+2000	K0 ~ K32000	K0 ~ K32000
Hardware Input Limit*1	-20.24 mA ~ 20.24 mA	-0.24 mA ~ 20.24 mA	3.81 mA ~ 20.19 mA
Conversion Limit*2	K-32384 ~ K32384	K-384 ~ K32384	K-384 ~ K32384
Error Rate	Room Temperature: ±0.2% ; Full Temperature Range: ±0.5%		
Hardware Resolution	16 bits		
Input Impedance	250Ω		
Absolute Input Range*3	±32 mA		

*1: If the input signal exceeds the hardware input limit, the module only shows the maximum value. If the input signal is below the lower limit, it only shows the minimum value. And an error flag will be set.

*2: If the input signal exceeds the hardware input limit, it also exceeds the conversion limit and a conversion limit error appears. For example in the voltage input mode (4 mA to 20 mA), when the input signal is 0 mA, exceeding the hardware upper limit, it also exceeds the conversion upper limit. The module uses the upper limit value (-384) as the input signal and a conversion limit error appears.

*3: If an input signal exceeds the absolute range, it might damage the channel.

Functional specifications for the digital-to-analog conversion

Digital-to-Analog Conversion	Voltage Output				
Rated Output Range	±10 V	0 ~ 10 V	±5 V	0 ~ 5 V	1 ~ 5 V
Conversion Range	K-32000 ~ K32000	K0 ~ K32000	K-32000 ~ K32000	K0 ~ K32000	K0 ~ K32000
Hardware Output Range	-10.1 V ~ +10.1 V	-0.1 V ~ 10.1 V	-5.05 V ~ +5.05 V	-0.05 V ~ +5.05 V	0.95 ~ 5.05 V
Error Rate (Room Temperature)	±0.2%				
Error Range (Full temperature range)	±0.5%				
Linearity Error (Room Temperature)	±0.05%				
Linearity Error (Full Temperature Range)	±0.05%				
Hardware Resolution	12 bits				
Permissible load impedance	≥1k Ω	≥500Ω			

Digital-to-Analog Conversion	Current Output	
Rated Output Range	0–20 mA	4–20 mA
Conversion Range	K0 ~ K32000	K0 ~ K32000
Hardware Output Range	-0.2 mA to 20.2 mA	3.8–20.2 mA
Error Range (Room Temperature)	±0.2%	
Error Range (Full Temperature Range)	±0.5%	
Linearity Error (Room Temperature)	±0.03%	
Linearity Error (Full Temperature Range)	±0.10%	
Hardware Resolution	12 bits	
Permissible Load Impedance	≤ 550 Ω	

- AS02ADH-A

Electrical specifications

Supply Voltage	24 VDC (20.4 VDC–28.8 VDC) (-15% to +20%)
Connector Type	Removable terminal block
Isolation	An analog circuit is isolated from a digital circuit by a digital integrated circuit/optocoupler, but the analog channels are not isolated from one another. Isolation between a digital circuit and a ground: 500 VAC Isolation between an analog circuit and a ground: 500 VAC Isolation between an analog circuit and a digital circuit: 500 VAC Isolation between the 24 VDC and a ground: 500 VAC
Rated voltage of external input point	24 VDC
Rated current of external input point	5 mA
Resistance value of external input point	3.9 k Ω
Hardware response time of external input point OFF -> ON	< 5 μ s
Hardware response time of external input point ON -> OFF	< 5 μ s
Weight	154 g

Functional specifications

Number of input channels	2
Analog input	Voltage: -10 V to 10 V, 0 V to 10 V, 5 V to -5 V, 0 V to 5 V, 1 V to 5 V Current: -20 mA to 20 mA, 0 mA to 20 mA, 4 mA to 20 mA
Digital output	16-bit integer 32-bit floating point
Error rate	Room temperature: $\pm 0.1\%$; full temperature range: $\pm 0.2\%$
Hardware resolution	16 bits
Input resistance value	Voltage: ≥ 2 M Ω Current: 250 Ω
Absolute input range*1	Voltage: ± 15 V Current: ± 32 mA
Channel sampling Cycle*2	20 μ s, 40 μ s and 80 μ s
Bandwidth of analog input signal	20 kHz
Average function	Time average, moving average: 1 to 1000 times
Digital filtering	Low-pass filter, band-pass filter
Logging function*3	Digital output value (2000 per channel), peak value
Digital calibration	Maximum / minimum digital output value clipping, gain, offset
Abnormal input signal detection	Limit-exceeding detection, disconnection detection#4
External input triggering	2 points (1 point / channel), rising-edge or falling-edge triggered
Maximum frequency of external input point triggering	10 kHz

*1: If an input signal exceeds the absolute range, it might damage the channel.

*2: Two channels are in A/D conversion simultaneously.

*3: Logging function should be used with API instructions.

*4: Disconnect detecton can only be used in the modes of 4 mA to 20 mA and 1V to 5 V.

Functional specifications for the analog-to-digital conversion – Voltage Input

Analog-to-Digital Conversion	Voltage Input				
Rated Input Range	-10V~10V	0V~10V	±5V	0V~5V	1V~5V
Rated Conversion Range	K-32000 ~ K32000	K0~K32000	K-32000 ~ K32000	K0~K32000	K0~K32000
Hardware Input Limit*1	- 10.12V~10.12V	-0.12V~10.12V	-5.06V~5.06V	-0.06V~5.06V	0.95V~5.05V
Conversion Limit*2	K-32384 ~ K32384	K-384~K32384	K-32384 ~ K32384	K-384~K32384	K-384~K32384

*1: If the input signal exceeds the hardware input limit, the module only shows the maximum value. If the input signal is below the lower limit, it only shows the minimum value. And an error flag will be set.

*2: If the input signal exceeds the hardware input limit, it also exceeds the conversion limit and a conversion limit error appears. For example in the voltage input mode (-10 V to +10 V), when the input signal is 10.15 V, exceeding the hardware upper limit, it also exceeds the conversion upper limit. The module uses the upper limit value (32384) as the input signal and a conversion limit error appears.

Functional specifications for the analog-to-digital conversion – Current Input

Analog-to-Digital Conversion	Current Input		
Rated Input Range	±20mA	0mA~20mA	4mA~20mA
Rated Conversion Range	K-32000 ~ K32000	K0~K32000	K0~K32000
Hardware Input Limit*1	-20.24mA~20.24mA	-0.24mA~20.24mA	3.81mA~20.19mA
Conversion Limit*2	K-32384~ K32384	K-384~K32384	K-384~K32384

*1: If the input signal exceeds the hardware input limit, the module only shows the maximum value. If the input signal is below the lower limit, it only shows the minimum value. And an error flag will be set.

*2: If the input signal exceeds the hardware input limit, it also exceeds the conversion limit and a conversion limit error appears. For example in the voltage input mode (4 mA to 20 mA), when the input signal is 0 mA, exceeding the hardware upper limit, it also exceeds the conversion upper limit. The module uses the upper limit value (-384) as the input signal and a conversion limit error appears.

2.4.2 Analog Input/Output Module Profiles

- AS04AD-A/AS08AD-B/AS08AD-C/AS04DA-A/AS06XA-A/AS02ADH-A

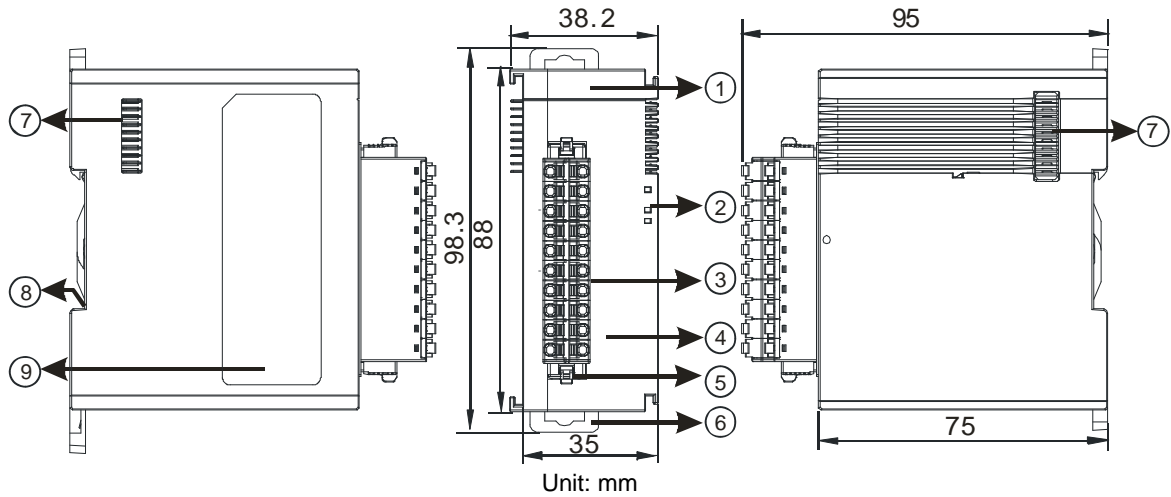

Number	Name	Description
1	Model name	Model name of the module
2	POWER LED indicator	Indicates the status of the power supply ON: the power is on OFF: no power
	ERROR LED indicator	Error status of the module ON: a serious error occurs in the module. OFF: the module is normal. Blinking: a minor error occurs in the module.
	Input LED indicator	Indicates the status of the input point ON: If there is an input signal, the input LED indicator is ON. OFF: No input signal, the input LED indicator is OFF.
	Analog-to-digital / digital-to-analog conversion indicator	Indicates the conversion status Blinking: conversion is taking place OFF: stop conversion
3	Removable terminal block	The inputs are connected to sensors. The outputs are connected to loads to be driven.
4	Arrangement of the input/output terminals	Arrangement of the terminals
5	Terminal block clip	Removal of the terminal block
6	DIN rail clip	Secures the module onto the DIN rail
7	Module connecting set	Connects the modules
8	Ground clip	
9	Label	Nameplate

2.4.3 Analog Input/Output Terminals

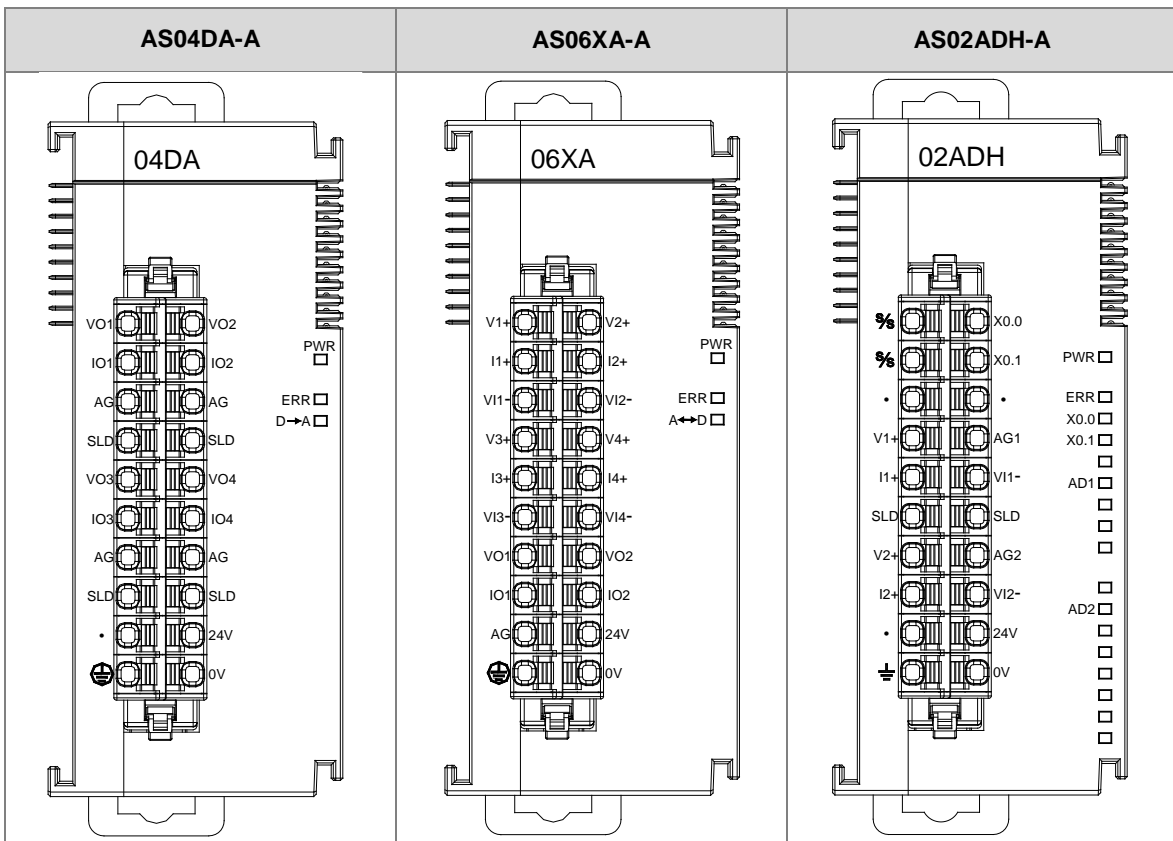
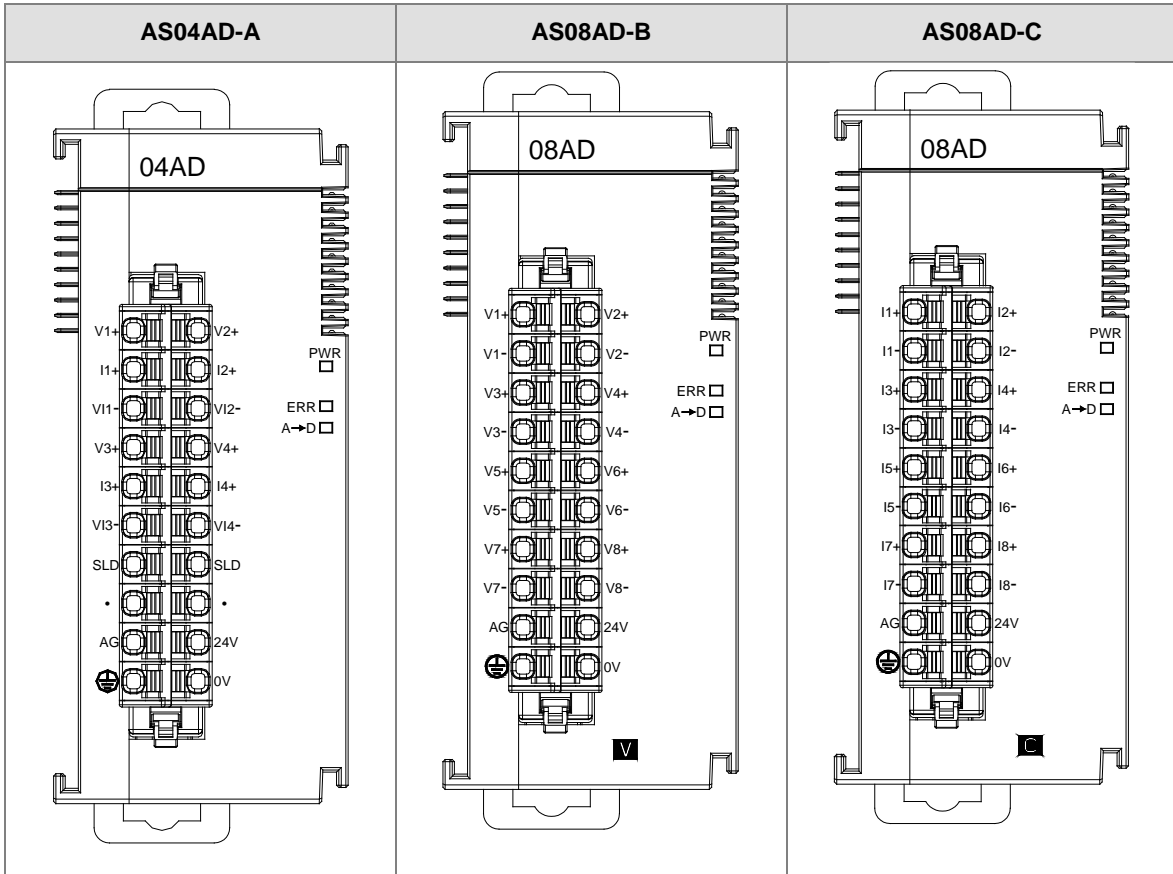

2.5 Temperature Measurement Modules Specifications

2.5.1 General Specifications

- AS04RTD-A / AS06RTD-A

Electrical specifications

Number of analog inputs	AS04RTD-A: four ; AS06RTD-A: six
Applicable sensor	2-WIRE & 3-WIRE Pt100: DIN 43760-1980 JIS C1604-1989; 100 Ω 3850 PPM/°C Pt1000: DIN EN60751; 1 k Ω 3850 PPM/°C Ni100/Ni1000: DIN 43760 JPt100: JIS C1604-1989LG-Ni1000 Cu50/Cu100 Ni120 (available for FW V1.06 or later) 0–300 Ω/0–3000 Ω
Supply voltage	24 VDC (20.4 VDC–28.8 VDC) (-15% to +20%)
Connector type	Removable terminal block
Overall accuracy	Pt100/Ni100/Ni120/Pt1000/Ni1000/JPt100: 25°C/77°F: The error is ±0.1% of the input within the range. -20 to +60°C/-4 to +140°F: The error is ±0.5% of the input within the range. LG-Ni1000: 25°C/77°F: The error is ±0.2% of the input within the range. Cu50: 25°C/77°F: The error is ±4°C of the input within the range. Cu100: 25°C/77°F: The error is ±2°C of the input within the range.
Resolution	0.1°C / 0.1°F
Conversion time	Two-wire/three-wire configuration: 200 ms/channel
Isolation	An analog circuit is isolated from a digital circuit by a digital integrated circuit/an optocoupler, and the analog channels are isolated from one another by optocouplers. Isolation between a digital circuit and a ground: 500 VAC Isolation between an analog circuit and a ground: 500 VAC Isolation between an analog circuit and a digital circuit: 500 VAC Isolation between the 24 VDC and a ground: 500 VAC
Weight	AS04RTD-A: 115g ; AS06RTD-A: 125g

Functional specifications

Analog-to-digital conversion	Centigrade (°C)	Fahrenheit (°F)	Input impedance
Rated input range *1	Pt100: -180°C to +800°C Ni100: -80°C to +170°C Ni120 : -80°C~320°C Pt1000: -180°C to +800°C Ni1000: -80°C to +170°C JPt100: -180°C to +500°C LG-Ni1000: -50°C to +180°C Cu50: -50°C to +150°C Cu100: -50°C to +150°C	Pt100: -292°F to +1,472°F Ni100: -112°F to +338°F Ni120: -112°F~608°F Pt1000: -292°F to +1,472°F Ni1000: -112°F to +338°F JPt100: -292°F to +932°F LG-Ni1000: -58°F to +356°F Cu50: -58°F to +302°F Cu100: -58°F to +302°F	0–300 Ω 0–3000 Ω
Maximum Measurable Range *2	Pt100: -200°C to 850°C Ni100: -100°C to 180°C Pt1000: -200°C to 850°C Ni1000: -100°C to 180°C JPt100: -200°C to 510°C LG-Ni1000: -60°C to 200°C Cu50: -50°C to 150°C Cu100: -50°C to 150°C	Pt100 : -328°F to 1,562°F Ni100: -148°F to 356°F Pt1000 : -328°F to 1,562°F Ni1000 : -148°F to 356°F JPt100 : -328°F to 950°F LG-Ni1000 : -76°F to 392°F Cu50 : -58°F to 302°F Cu100 : -58°F to 302°F	0–320 Ω 0–3200 Ω
Average function	Range: 1–100		
Self-diagnosis	Disconnection detection		

*1: If any of these limits are exceeded, device functionality should not be assumed, damage may occur and reliability may be affected.

*2: If the to be measured temperature exceeds the upper/lower limit, it only shows the maximum / minimum value.

● AS04TC-A / AS08TC-A

Electrical specifications

Number of analog inputs	AS04TC-A: four ; AS08TC-A: eight
Applicable sensor	Type J, K, R, S, T, E, N, B, C, U, L, TXK thermocouple; input impedance: ±100mV
Supply voltage	24 VDC (20.4 VDC–28.8 VDC) (-15% to +20%)
Connector type	Removable terminal block
Overall accuracy	25°C/77°F: The error is ±0.5% of the input within the range. -20 to +60°C/-4 to +140°F: The error is ±1% of the input within the range.
Resolution	0.1°C / 0.1°F
Conversion time	200 ms/channel
Isolation	An analog circuit is isolated from a digital circuit by a digital integrated circuit, and the analog channels are isolated from one another by optocouplers. Isolation between a digital circuit and a ground: 500 VAC Isolation between an analog circuit and a ground: 500 VAC Isolation between an analog circuit and a digital circuit: 500 VAC Isolation between two group circuits: 500 VAC Isolation between the 24 VDC and a ground: 500 VAC Isolation between the analog channels: 120VAC
Weight	AS04TC-A: 115g ; AS08TC-A: 125g

Functional specifications

Analog-to-digital conversion	Centigrade (°C)	Fahrenheit (°F)	Input impedance
Rated input range ^{*1}	Type J: -100°C~1200°C Type K: -100°C~1,350°C Type R: 0°C~1,750°C Type S: 0°C~1,750°C Type T: -150°C~400°C Type E: -150°C~980°C Type N: -150°C~1,300°C Type B: 200°C~1,800°C Type C: 0°C~2,320°C Type U: -200°C~600°C Type L: -200°C~900°C Type TXK: -200°C~800°C	Type J: -148°F~2,192°F Type K: -148°F~2,462°F Type R: 32°F~3,182°F Type S: 32°F~3,182°F Type T: -238°F~752°F Type E: -238°F~1,796°F Type N: -238°F~2,372°F Type B: 392°F~3,272°F Type C: NA Type U: -328°F~1,112°F Type L: -328°F~1,652°F Type TXK: -328°F~1,472°F	±100mV
Maximum Measurable Range ^{*2}	Type J: -210°C~1200°C Type K: -250°C~1,350°C Type R: -50°C~1,760°C Type S: -50°C~1,760°C Type T: -250°C~400°C Type E: -250°C~1000°C Type N: -250°C~1,300°C Type B: 20°C~1,800°C Type C: 0°C~2,320°C Type U: -200°C~600°C Type L: -200°C~900°C Type TXK: -200°C~800°C	Type J: -346°F~2,192°F Type K: -418°F~2,462°F Type R: -58°F~3,200°F Type S: -25°F~3,200°F Type T: -418°F~752°F Type E: -418°F~1,832°F Type N: -418°F~2,372°F Type B: 68°F~3,272°F Type C: NA Type U: -328°F~1,112°F Type L: -328°F~1,652°F Type TXK: -328°F~1,472°F	±100mV
Average function	Range: 1~100		
Self-diagnosis	Disconnection detection		

*1: If any of these limits are exceeded, device functionality should not be assumed, damage may occur and reliability may be affected.

*2: If the to be measured temperature exceeds the upper/lower limit, it only shows the maximum / minimum value.

2.5.2 Temperature Measurement Module Profiles

- AS04RTD-A / AS06RTD-A

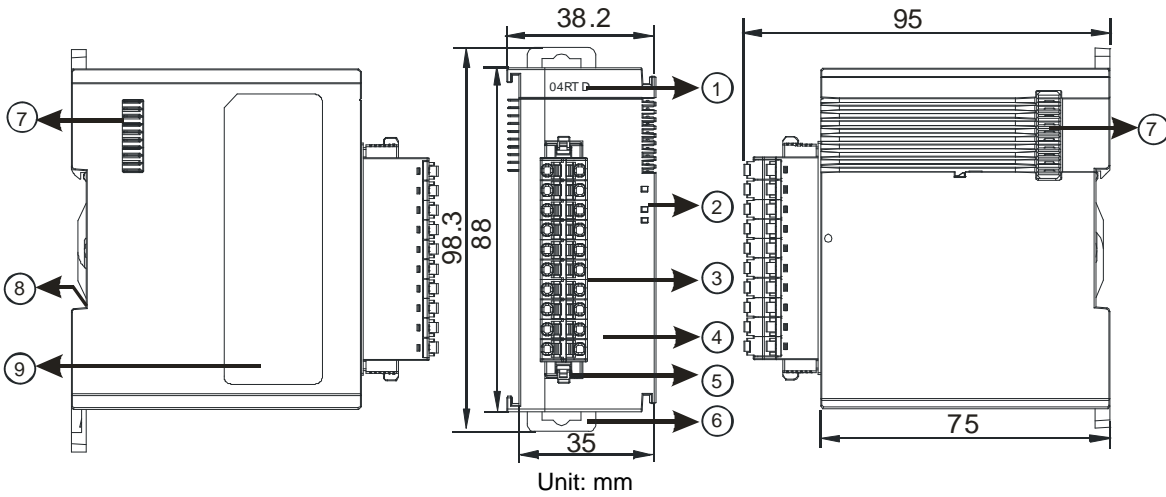

Number	Name	Description
1	Model name	Model name of the module
2	POWER LED indicator	Indicates the status of the power supply ON: the power is on OFF: no power
	ERROR LED indicator	Error status of the module ON: a serious error occurs in the module. OFF: the module is normal. Blinking: a minor error occurs in the module.
	Analog to digital conversion indicator	Indicates the analog to digital conversion status Blinking: conversion is taking place OFF: stop conversion
3	Removable terminal block	The inputs are connected to sensors. The outputs are connected to loads to be driven.
4	Arrangement of the input/output terminals	Arrangement of the terminals
5	Terminal block clip	Removal of the terminal block
6	DIN rail clip	Secures the module onto the DIN rail
7	Module connecting set	Connects the modules
8	Ground clip	
9	Label	Nameplate

● AS04TC-A / AS08TC-A

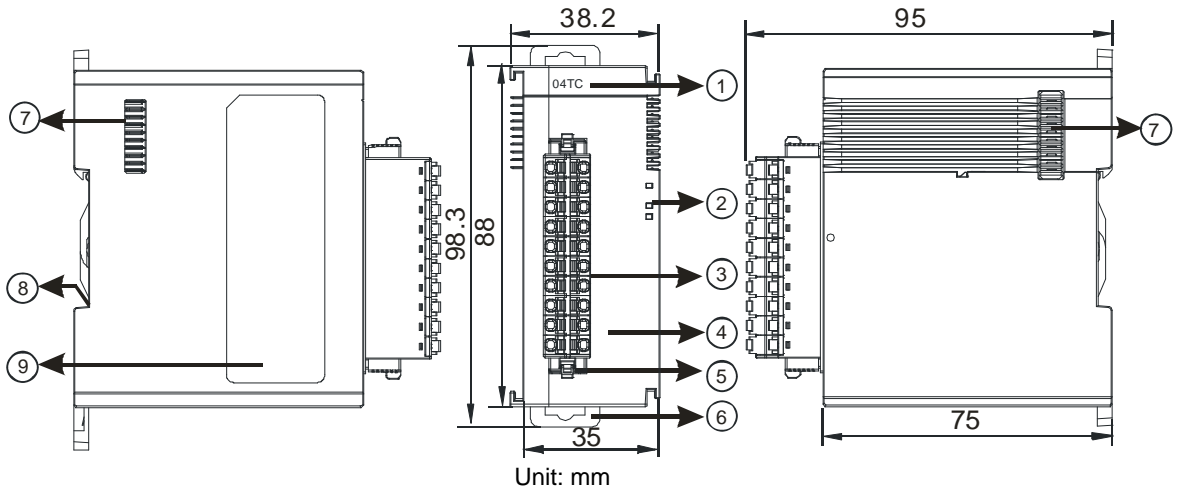

Number	Name	Description
1	Model name	Model name of the module
2	POWER LED indicator	Indicates the status of the power supply ON: the power is on OFF: no power
	ERROR LED indicator	Error status of the module ON: a serious error occurs in the module. OFF: the module is normal. Blinking: a minor error occurs in the module.
	Analog to digital conversion indicator	Indicates the analog to digital conversion status Blinking: conversion is taking place OFF: stop conversion
3	Removable terminal block	The inputs are connected to sensors. The outputs are connected to loads to be driven.
4	Arrangement of the input/output terminals	Arrangement of the terminals
5	Terminal block clip	Removal of the terminal block
6	DIN rail clip	Secures the module onto the DIN rail
7	Module connecting set	Connects the modules
8	Ground clip	
9	Label	Nameplate

2.5.3 Temperature Measurement Module Dimensions

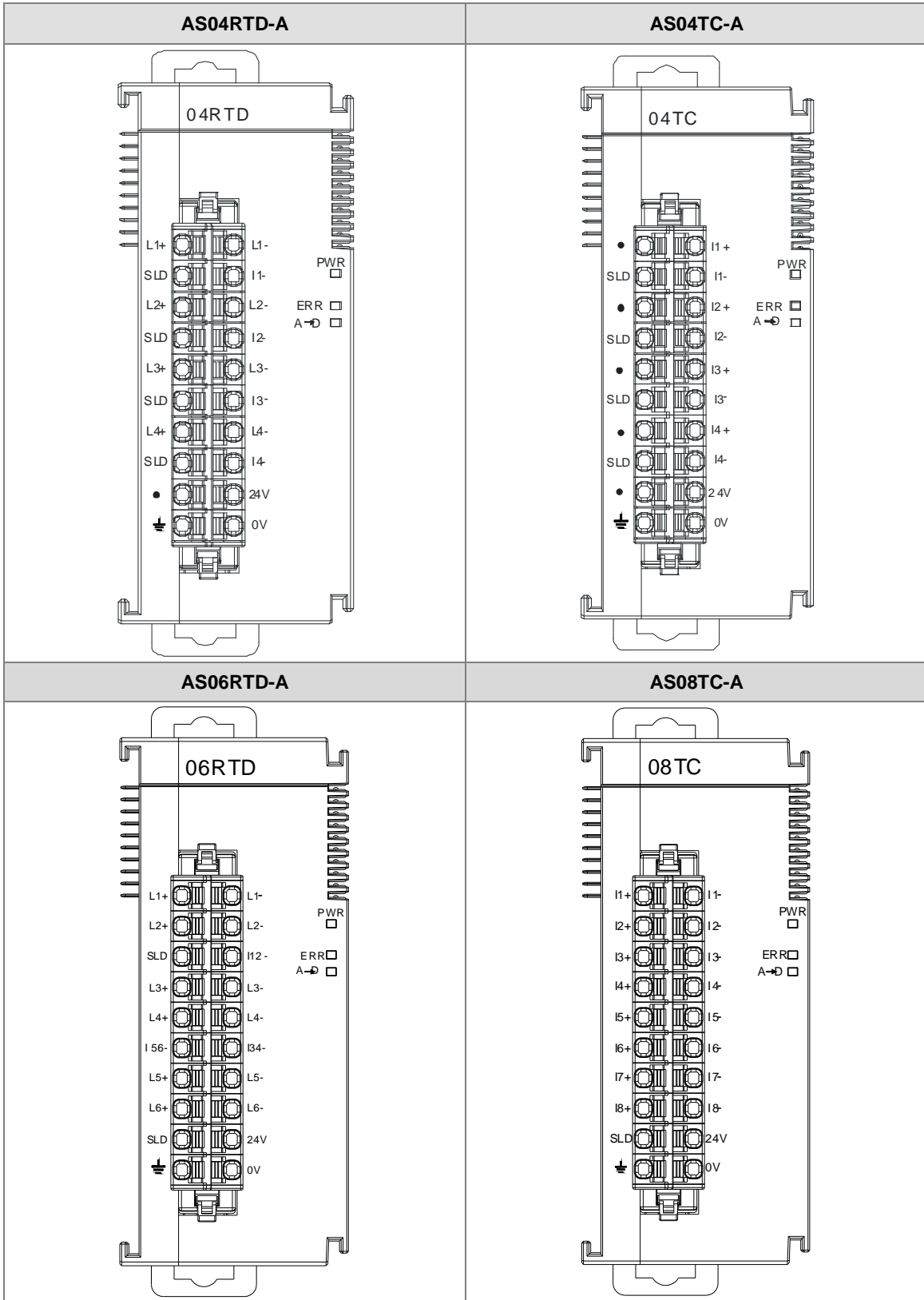

Unit: mm

2.6 Positioning Module Specifications

2.6.1 General Specifications

Electrical specifications for the inputs

- AS02PU-A

Model		High-speed Input	Normal Input
Item			
Number of inputs		3 (A+/A-, B+/B-, Z+/Z-)	5 (X0.0-X0.4)
Connector type		Removable terminal blocks	
Input form		Differential input	Direct current (sinking or sourcing)
Input current		5-24 VDC, 5 mA	24 VDC, 5 mA
Action level	OFF→ON	>3 VDC	>15 VDC
	ON→OFF	<1.5 VDC	<5 VDC
Response time		1.5 μs	< 0.5 ms
Maximum input frequency		200 kHz (A+/A-, B+/B-, Z+/Z-)	1 kHz
Input impedance		4.7 k Ω	
Input isolation		500 VAC	
Input display		When the optocoupler is driven, the input LED indicator is ON.	
Weight		120 g	

- AS04PU-A

Model		Normal
Item		
Number of inputs		Six
Connector type		Removable terminal blocks
Input form		Direct current (sinking or sourcing) Sinking: The inputs are NPN transistors whose collectors are open collectors. Sourcing: The inputs are PNP transistors whose collectors are open collectors.
Input current		24 VDC, 5 mA
Action level	OFF→ON	>15 VDC
	ON→OFF	<5 VDC
Response time		< 0.5 ms
Maximum input frequency		1 kHz
Input impedance		4.7 k Ω
Input isolation		500 VAC
Input display		When the optocoupler is driven, the input LED indicator is ON.
Weight		120 g

Electrical specifications for the outputs

Model		AS02PU-A	AS04PU-A
Item			
Number of outputs		Four (2-axis)	Eight (4-axis)
Connector type		Removable terminal blocks	
Output form		differential output	Transistor-T (sinking) (NPN)
Output voltage		5 VDC*1	5-30 VDC, 0.1A
Leakage current		< 10 uA	
Minimum load		1 mA / 5 VDC	
Maximum load	Resistance	10 mA	0.1A
	Inductance	N/A	
	Bulb	N/A	
Maximum output frequency	Resistance	200 kHz	100 kHz
	Response time		
	OFF→ON	0.1 μs	1.5 μs
	ON→OFF	0.1 μs	1.5 μs
Output isolation		500 VAC	
Weight		120 g	

Note *1: Actual output 4 VDC (high input impedance) to 3.3 VDC (10 mA)/point

2.6.2 Positioning Module Profiles

- AS02PU-A / AS04PU-A

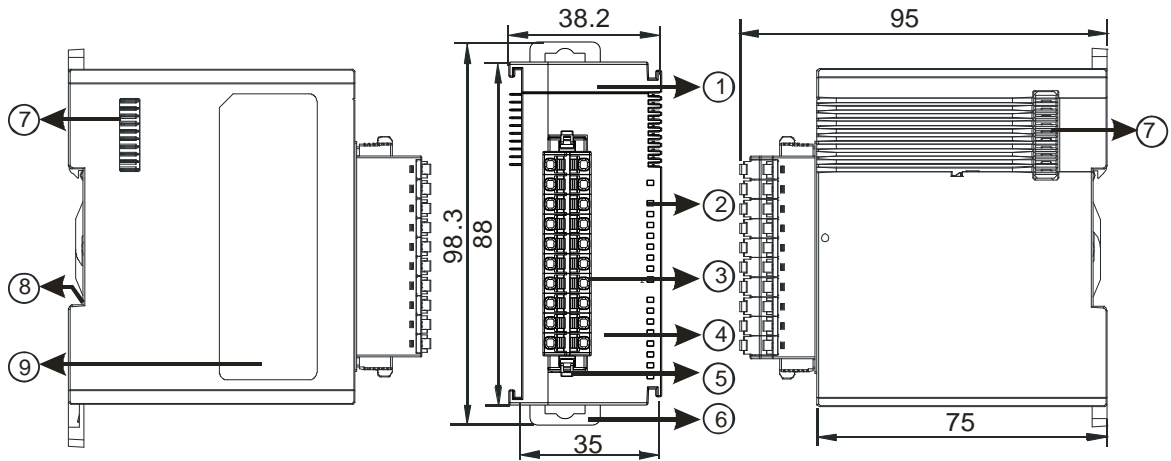

Number	Name	Description
1	Model name	Model name of the module
2	POWER LED indicator (Blue)	Indicates the status of the power supply ON: the power is on OFF: no power
	Run LED indicator (Green)	Operating status of the module ON: the module is running and ready to accept instructions. OFF: the module is stopped and can NOT accept instructions.
	Error LED indicator (Red)	Error status of the module OFF: the module is normal. Blinking (0.2 seconds ON/OFF): hardware error occurs in the module, can NOT operate normally
	Input LED indicator (Red)	ON: Receives an input signal OFF: Receives no input signal
	Output LED indicator (Red)	ON: Receives an output signal OFF: Receives no output signal
3	Removable terminal block	The inputs are connected to sensors. The outputs are connected to loads to be driven.
4	Arrangement of the input/output terminals	Arrangement of the terminals
5	Terminal block clip	Removal of the terminal block
6	DIN rail clip	Secures the module onto the DIN rail
7	Module connecting set	Connects the modules
8	Ground clip	On the DIN rail for grounding
9	Label	Nameplate

2.6.3 Positioning Module Terminals

AS02PU-A	AS04PU-A																																																																																								
AS02PU-A	AS04PU-A																																																																																								
<p>Wordings with the same indications that are used on the terminal block and manual</p> <table border="1" style="margin: auto; border-collapse: collapse; text-align: center;"> <thead> <tr> <th>Manual</th> <th>Terminal Block (left)</th> <th>Manual</th> <th>Terminal Block (right)</th> </tr> </thead> <tbody> <tr><td>A+</td><td>A+</td><td>A-</td><td>A-</td></tr> <tr><td>B+</td><td>B+</td><td>B-</td><td>B-</td></tr> <tr><td>Z+</td><td>Z+</td><td>Z-</td><td>Z-</td></tr> <tr><td>S/S</td><td>S/S</td><td>X0.0</td><td>0</td></tr> <tr><td>X0.1</td><td>1</td><td>X0.2</td><td>2</td></tr> <tr><td>X0.3</td><td>3</td><td>X0.4</td><td>4</td></tr> <tr><td>Y0.0+</td><td>0+</td><td>Y0.0-</td><td>0-</td></tr> <tr><td>Y0.1+</td><td>1+</td><td>Y0.1-</td><td>1-</td></tr> <tr><td>Y0.2+</td><td>2+</td><td>Y0.2-</td><td>2-</td></tr> <tr><td>Y0.3+</td><td>3+</td><td>Y0.3-</td><td>3-</td></tr> </tbody> </table>	Manual	Terminal Block (left)	Manual	Terminal Block (right)	A+	A+	A-	A-	B+	B+	B-	B-	Z+	Z+	Z-	Z-	S/S	S/S	X0.0	0	X0.1	1	X0.2	2	X0.3	3	X0.4	4	Y0.0+	0+	Y0.0-	0-	Y0.1+	1+	Y0.1-	1-	Y0.2+	2+	Y0.2-	2-	Y0.3+	3+	Y0.3-	3-	<p>Wordings with the same indications that are used on the terminal block and manual</p> <table border="1" style="margin: auto; border-collapse: collapse; text-align: center;"> <thead> <tr> <th>Manual</th> <th>Terminal Block (left)</th> <th>Manual</th> <th>Terminal Block (right)</th> </tr> </thead> <tbody> <tr><td>S/S</td><td>S/S</td><td>C0</td><td>C0</td></tr> <tr><td>S/S</td><td>S/S</td><td>Y0.0</td><td>0</td></tr> <tr><td>X0.0</td><td>0</td><td>Y0.1</td><td>1</td></tr> <tr><td>X0.1</td><td>1</td><td>Y0.2</td><td>2</td></tr> <tr><td>X0.2</td><td>2</td><td>Y0.3</td><td>3</td></tr> <tr><td>X0.3</td><td>3</td><td>C1</td><td>C1</td></tr> <tr><td>X0.4</td><td>4</td><td>Y0.4</td><td>4</td></tr> <tr><td>X0.5</td><td>5</td><td>Y0.5</td><td>5</td></tr> <tr><td></td><td>•</td><td>Y0.6</td><td>6</td></tr> <tr><td></td><td>•</td><td>Y0.7</td><td>7</td></tr> </tbody> </table>	Manual	Terminal Block (left)	Manual	Terminal Block (right)	S/S	S/S	C0	C0	S/S	S/S	Y0.0	0	X0.0	0	Y0.1	1	X0.1	1	Y0.2	2	X0.2	2	Y0.3	3	X0.3	3	C1	C1	X0.4	4	Y0.4	4	X0.5	5	Y0.5	5		•	Y0.6	6		•	Y0.7	7
Manual	Terminal Block (left)	Manual	Terminal Block (right)																																																																																						
A+	A+	A-	A-																																																																																						
B+	B+	B-	B-																																																																																						
Z+	Z+	Z-	Z-																																																																																						
S/S	S/S	X0.0	0																																																																																						
X0.1	1	X0.2	2																																																																																						
X0.3	3	X0.4	4																																																																																						
Y0.0+	0+	Y0.0-	0-																																																																																						
Y0.1+	1+	Y0.1-	1-																																																																																						
Y0.2+	2+	Y0.2-	2-																																																																																						
Y0.3+	3+	Y0.3-	3-																																																																																						
Manual	Terminal Block (left)	Manual	Terminal Block (right)																																																																																						
S/S	S/S	C0	C0																																																																																						
S/S	S/S	Y0.0	0																																																																																						
X0.0	0	Y0.1	1																																																																																						
X0.1	1	Y0.2	2																																																																																						
X0.2	2	Y0.3	3																																																																																						
X0.3	3	C1	C1																																																																																						
X0.4	4	Y0.4	4																																																																																						
X0.5	5	Y0.5	5																																																																																						
	•	Y0.6	6																																																																																						
	•	Y0.7	7																																																																																						

2.7 Counter Module Specifications

2.7.1 General Specifications

Item		Description
Number of channels		2
Pulse Input	Input signal type	Phase differential (A/B): x2, x4; CW/CCW; Pulse/Direction
	Max. transmission distance	200 kHz at 30 m
	Counter type	Circular counter, linear encoder
SSI Input	Max. data length	32-bit (The single-turn, multi-turn, and status data length can be set.)
	Coding method	Binary code, gray code
	Max. transmission distance	250 kHz at 150 m, 500 kHz at 50 m, 625 kHz at 40 m, 1 MHz at 20 m, 1.25 MHz at 10 m
	Parity check bit	None, odd parity, even parity
	Counter type	Circular counter, absolute counter
Counter	Counting range	-2147483648 ~ 2147483647 (32-bit)
	Counter control	Reset, preset, gate, capture, offset correction for absolute position
	Output state check	Direction to count, counting overflow/underflow, linear counting beyond the lower and upper limit values, SSI feedback, SSI position exceeding the protection limit, SSI parity checking, SSI communication status, a zero point is set beyond SSI encoder resolution
External input point (phase Z)	Input point	2 (one for each channel)
	Function	Reset, gate, capture
	Digital filtering	OFF, 100 μ s, 200 μ s to 20 ms
	Min. software interrupt response time	20 μ s (hardware response time included)
External output point	Output point	4
	Output type	NPN transistor (sinking)
Comparison function	Instruction	General comparison output instruction, table comparison output instruction
	Interrupt	Using comparison to achieve the interrupt function
Measurement function	Measured item	Input frequency and revolution
	Average times	1 to 10 times

Electrical specifications for the inputs

Model		Pulse input	External input
Item			
Number of inputs		4 (A+/B+, A-/B-)	2 (Z+/Z-)
Connector type		D-sub 15	
Input current		5-24 VDC, 6-15 mA	
Action level	OFF→ON	3 V	
	ON→OFF	1 V	
Maximum input frequency		200 kHz	20 kHz
Input impedance		4.7 kΩ	
Input signal		Signal signal: 5 – 24 VDC (sinking or sourcing) ; differential signal: 5 V	
Input isolation		500 VAC	
Input display		When the optocoupler is driven, the input LED indicator is ON.	
Weight		138 g	

Electrical specifications for the SSI input and output

Model		SSI input	SSI output
Item			
Number of inputs / outputs		2 (DATA+/DATA-)	2 (CLK+/CLK-)
Connector type		D-sub 15	
Voltage / Current		5 VDC, 1 mA	5 VDC, ±60 mA (max.)
Action level	OFF→ON	$V_{ID}^{*1} \geq 0.2V$	-
	ON→OFF	$V_{ID} \leq 0.2V$	-
Maximum input/output frequency		1.25 MHz	
Input impedance		12 kΩ (terminal resistor 120 Ω)	-
Input signal		RS-422	
Input isolation		500 VAC	
Input display		When the optocoupler is driven, the input LED indicator is ON.	

*1: V_{ID} is the voltage difference between DATA+ and DATA-.

Electrical specifications for the external outputs

Item		Model	AS02HC-A
Number of outputs			4
Connector type			D-sub 15
Output type			NPN transistor (sinking)
Voltage			5 – 30 VDC
Minimum load			1 mA / 5 VDC
Maximum load	Resistance		0.1A/output
	Inductance		-
	Bulb		-
Maximum output frequency*1	Resistance		10 kHz
Maximum Response time	OFF→ON		25 μs
	ON→OFF		
Output isolation			500 VAC

Electrical specifications for the +5 V encoder power supply

Item		Model	AS02HC-A
Number of outputs			2 (+5 VO/GND)
Connector type			D-sub 15
Voltage / Current			5 VDC (±5%), ±100 mA (max.)

2.7.2 Counting Module Profiles

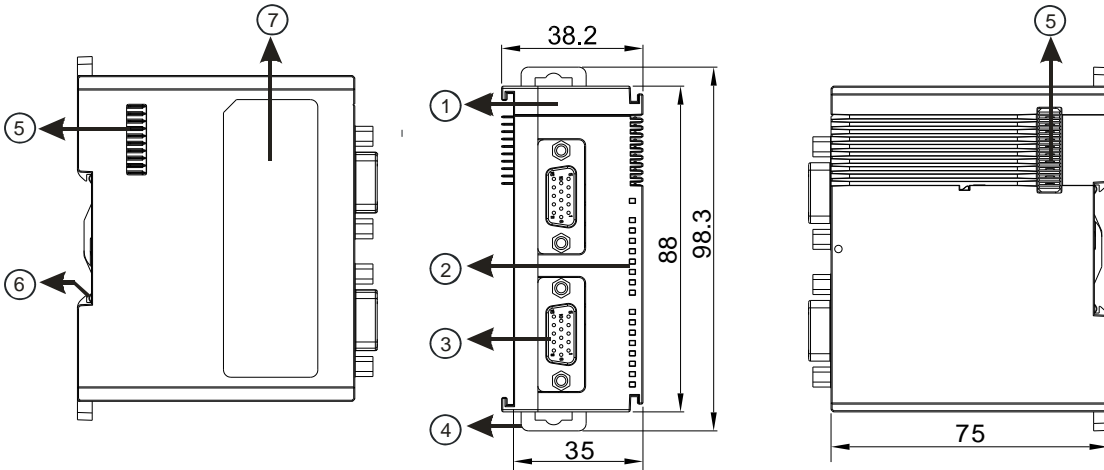

Number	Name	Description
1	Model name	Model name of the module
2	POWER LED indicator (Blue)	Indicates the status of the power supply ON: the power is on OFF: no power
	Error LED indicator (Red)	Error status of the module ON: a serious error occurs in the module. OFF: the module is normal. Blinking: a minor error occurs in the module.
	Counter LED indicator for Ch1 Act. & Ch2 Act. (Green)	Counting status of the module OFF: the counter is disabled. ON: the counter is enabled but the result of counting is not changed. Blinking: the result of counting is updating. When SSI input: Blinking: the counter is enabled and the position value is updating.
	Input / output LED indicator	ON: Receives an input / output signal OFF: Receives no input / output signal
3	D-sub 15	Input: connected for pulse input and encoder Output: connected to loads to be driven Power: providing external encoder +5 VDC
4	DIN rail clip	Secures the module onto the DIN rail
5	Module connecting set	Connects the modules
6	Ground clip	On the DIN rail for grounding
7	Label	Nameplate

2.7.3 Counting Module Terminals

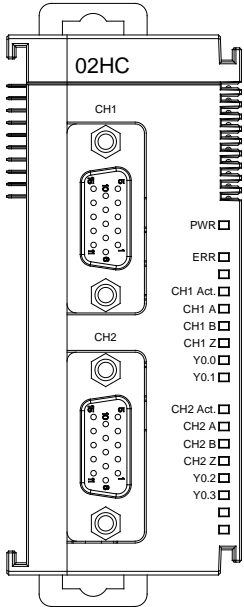
	Pin No.	CH1	CH2
	8	A1+	A2+
	3	A1-	A2-
	7	B1+	B2+
	2	B1-	B2-
	6	Z1+	Z2+
	1	Z1-	Z2-
	10	CLK1+	CLK2+
	5	CLK1-	CLK2-
	9	DATA1+	DATA2+
	4	DATA1-	DATA2-
	14	+5VO1	+5VO2
	15	GND1	GND2
	12	Y0.0	Y0.2
	11	Y0.1	Y0.3
	13	COM0	COM1

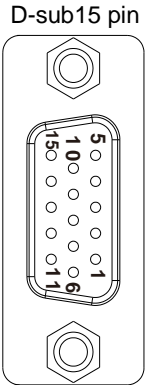
--

2

2.8 Network Module Specifications

2.8.1 General Specifications

- AS00SCM-A

RS-485/RS-422/RS-232 communication interface

Item	Specifications
Connector type	5-pin European-style terminal block, spring-clamp terminal block
Electronical isolation	500 VAC
Communication format	Stop bit: 1 stop bit or 2 stop bits Parity bit: none, an odd parity bit, or an even parity bit Data bit: 7 data bits or 8 data bits
Communication protocol	CAN

CAN communication interface

Item	Specifications
Connector type	RJ-45*2
Transmission speed	10K, 20K, 50K, 125K, 250K, 500K, 1000 Kbps
Communication protocol	AS special remote mode (for RTU mode) CANopen (available for models with firmware V2.0 or later)

Ethernet communication interface

Item	Specifications
Connector type	RJ-45*2
Transmission speed	10M, 100 Mbps
Communication protocol	EtherNet/IP (available for models with firmware V2.02 or later), PROFINET (available for models with firmware V2.06 or later)

Electrical specifications

Item	Specifications
Supply voltage	24 VDC
Electric energy consumption	0.6 W
Weight	169 g

- AS01DNET-A

CAN communication interface

Item	Specifications
Connector type	Removable terminal blocks (enclosed with fastening screws, 5.08 mm)
Electronical isolation	500 VAC
Transmission cables	Communication cable *2, power cable *2, shield cable *1
Communication protocol	DeviceNet

Communication interface

Item	Specifications
Data type	I/O polling, explicit message
Transmission speed	Standard mode: 125K, 250K, 500Kbps Extension mode: 10K, 20K, 50K, 125K, 250K, 500K, 1000K, 800Kbps and 1M bps

Electrical specifications

Item	Specifications
Voltage	11~25 VDC supplied by power cable of the network
Current	Ttypical value: 28 mA; rush current: 125 mA (24 VDC)

- AS04SIL-A

Unit Specifications

Item		Specifications
Model type		IO-Link master
Model name		AS04SIL-A
Number of ports		4
Communication	Baud rate	4.8 kbps ; 38.4 kbps ; 230.4 kbps
	Topology	1 : 1
	Compliant standards	<ul style="list-style-type: none"> ■ IO-Link Interface and System Specification Version 1.1.2 ■ IO-Link Test Specification Version 1.1.2
Modes	IO-Link	Yes
	SIO (DI)	Yes
	SIO (DO)	Yes, up to 100 mA / channel
Cyclic communications		2 ms min. ; dynamic, according to the valid data length
Input: data size in each communication port		32 bytes max.
Output: data size in each communication port		32 bytes max.
Input: data size in each module		128 bytes max.
Output: data size in each module		128 bytes max.
Input PDO data size		100 words max.
Output PDO data size		100 words max.
Back up		Yes
Cable specification	Type	Unshielded (can also apply to shielded ones)
	Length	20 m max.
	Electrostatic capacity between lines	3 nF max.
	Loop resistance	6 Ω max.
External connection terminals		Clamping terminal block

Electrical specifications

Item		Specifications
Power supply to device in IO-Link mode or SIO (DI) mode	Rated voltage	24 VDC (20.4 VDC~ 28.8 VDC) (9-15%~-+20%)
	Maximum load current	0.2A/port
	Short-circuit protection	Yes
Digital inputs in SIO (DI) mode	Internal I/O common	NPN, PNP
	Input voltage / current	24 VDC, 5 mA
	ON voltage	>15 VDC
	OFF voltage	<5 VDC
	Filter time	0 – 65 ms (0: no filter)
Digital outputs in SIO (DO) mode	Internal I/O common	NPN, PNP
	Output voltage / current	24 VDC (20.4 VDC~ 28.8 VDC), 0.1A/port
	Short-circuit protection	Yes
	Leakage current	<0.1 mA
	Residual voltage	<1.5 VDC
Digital inputs for pin 2 in IO-Link mode	Internal I/O common	NPN, PNP
	Input voltage / current	24 VDC, 2 mA
	ON voltage	>15 VDC
	OFF voltage	<5 VDC
	Filter time	0 – 65 ms (0: no filter)
Electrical isolation		500 VAC
Power consumption		0.8 W
Weight		133g

2.8.2 Network Module Profiles

- AS00SCM-A

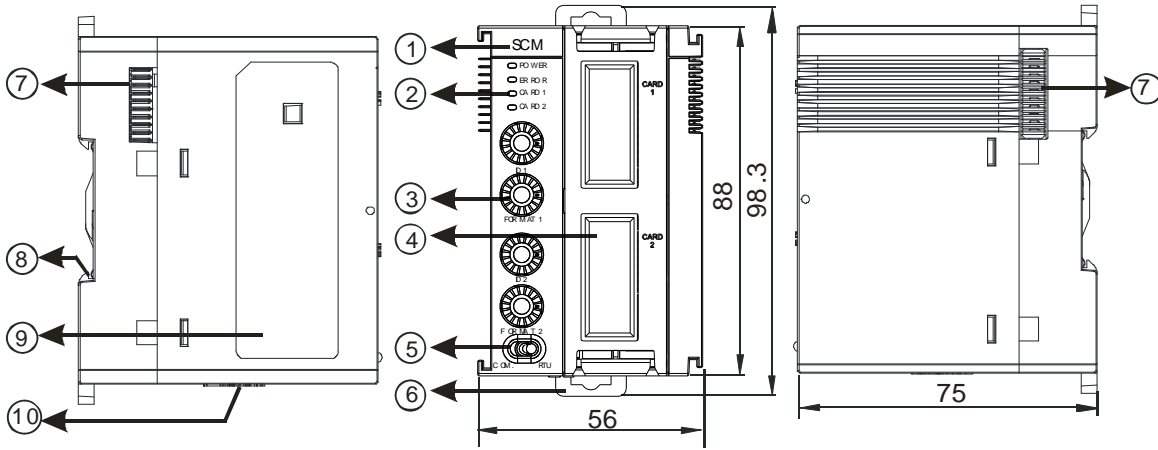

Unit: mm

Number	Name	Description
1	Model name	Model name of the module
2	POWER LED indicator	Indicates the status of the power supply ON: The power is on OFF: No power or the power is low
	ERROR LED indicator	Error status of the module OFF: The module is normal. Blinking: Error occurs now or error had occurred before
	Extension card 1 indicator (orange)	Blinking: Communication is taking place in card 1 OFF: No communication in card 1
	Extension card 2 indicator (orange)	Blinking: Communication is taking place in card 2 OFF: No communication in card 2
3	Address and function setting knobs	2 sets for setting up the address and function in card 1 and 2
4	Slot of function card 1	COM mode: Available for AS-F232, AS-F422, AS-F485
	Slot of function card 2	COM mode: Available for AS-F232, AS-F422, AS-F485, AS-FCOPM RTU mode: AS-FCOPM, AS-FEN02, AS-FPFN02
5	Mode switch	COM: Serial communication mode; RTU: remote module mode
6	DIN rail clip	Secures the module onto the DIN rail
7	Module connecting set	Connects the modules
8	Ground clip	
9	Label	Nameplate
10	Input for supplying power to remote modules	Power supply for the remote module (NOT for COM mode)

● AS01DNET-A

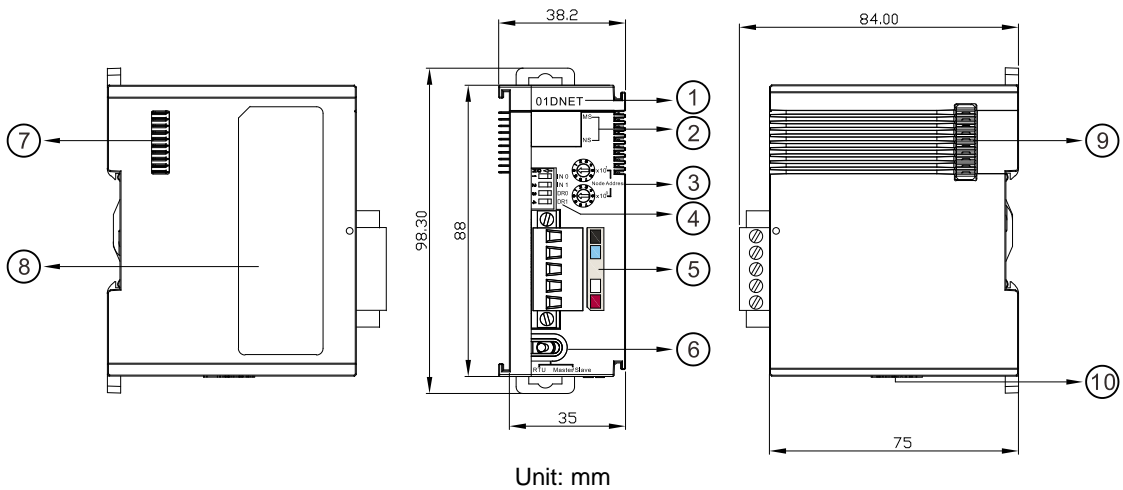

Number	Name	Description
1	Model name	Model name of the module
2	State LED indicator	<p>Master/slave mode:</p> <ul style="list-style-type: none"> ● NS LED <ul style="list-style-type: none"> OFF: no power or duplicate ID check has not been completed. Green light blinking every 0.5 seconds: the connection to the DeviceNet network failed. Green light ON: online; the connection to the DeviceNet network is normal. Red light blinking every 0.5 seconds: communication error Red light ON: Network trouble, duplicate node ID, no network power or Bus-OFF. ● MS LED <ul style="list-style-type: none"> OFF: no power Green light blinking every 0.5 seconds: no module is configured. Green light ON: input and output data are normal. Red light blinking every 0.5 seconds: when AS01DNET works as the master, the slave in Scan List can not work normally. When AS01DNET works as the slave, an error occurs in the configuration. Red light ON: hardware error ● Combination of NS LED and MS LED <ul style="list-style-type: none"> NS LED OFF & MS LED OFF: no power NS LED OFF & MS LED green light ON: duplicate ID check has not been completed. NS LED red light ON & MS LED green light ON: duplicate ID check failed or Bus-OFF. NS LED red light ON & MS LED red light blinking every 0.5 seconds: no network power NS LED red light ON & MS LED red light ON: hardware error

Number	Name	Description
		<p>RTU mode:</p> <ul style="list-style-type: none"> ● NS LED <p>OFF: no power or duplicate ID check has not been completed.</p> <p>Green light blinking every 0.5 seconds: the connection to the DeviceNet network failed.</p> <p>Green light ON: online; the connection to the DeviceNet network is normal.</p> <p>Red light blinking every 0.5 seconds: I/O connection timeout between AS01DNET (RTU) and DeviceNet master</p> <p>Red light ON: Network trouble, duplicate node ID, no network power or Bus-OFF.</p> <ul style="list-style-type: none"> ● MS LED <p>OFF: no power</p> <p>Green light blinking every 0.5 seconds:</p> <ul style="list-style-type: none"> - AS01DNET (RTU) is waiting for the I/O data from DeviceNet master. - No I/O data transmission between AS01DNET(RTU) and DeviceNet master - The PLC connected to DeviceNet master is in STOP state. <p>Green light ON: normal transmission of I/O data between AS01DNET (RTU) and DeviceNet master</p> <p>Red light blinking every 0.5 seconds: no network power supply; configuration error; module alarms.</p> <p>Red light ON: hardware error</p>
3	Address switch	Setting up the address
4	Function switch	Setting up the functions, including the work mode and baud rate of DeviceNet network
5	DeviceNet communication port	Connects the modules via DeviceNet communication. Use AS01DNET-A connector for wiring.
6	Mode switch (RTU/DNET; Master/Slave)	<p>Master/Slave mode: the port does not need an external 24VDC power supply connected</p> <p>RTU mode: the power input port of the network module is required to connect an external 24VDC power supply only. You can connect</p>
7	Left-side extension port	Connects the modules
8	Label	Nameplate
9	Right-side extension port	Connects the modules
10	Input for supplying power to remote modules	Power supply for the remote module

● AS04SIL-A

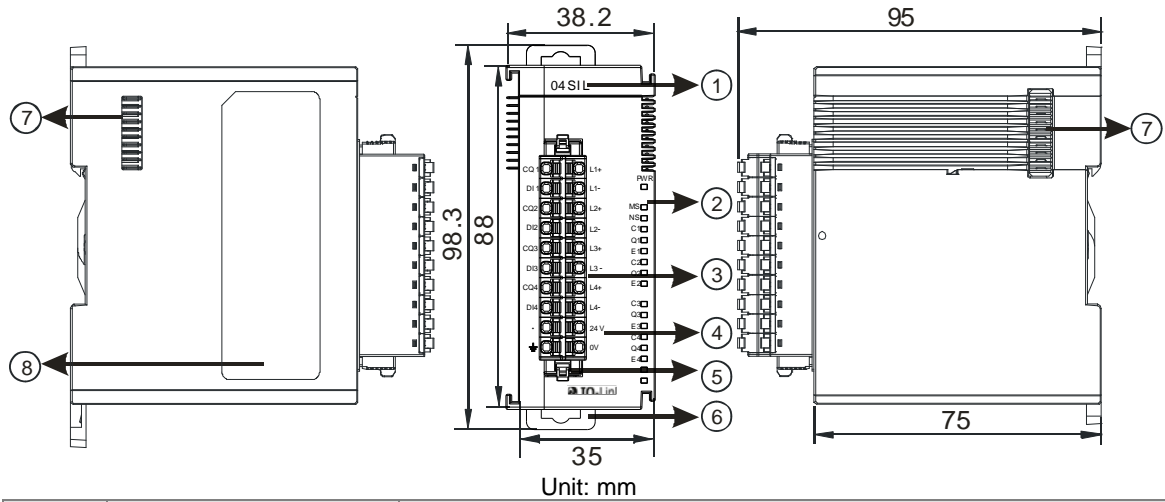

Number	Name	Description
1	Model name	Model name of the module
2	POWER LED indicator	Indicates the status of the power supply ON: the power is on OFF: no power or the power is low
	Module LED indicator	Error status of the module OFF: The module is normal. Blinking: ● Module setting or communication error (blinks every 1 second) ● Hardware or low power error (blinks every 0.2 second)
	Network LED indicator	Error status of the network ON: No external power supply Blinking: Scanning is under going or the module is configured and the diagnosis is done. OFF: The module is configured but the diagnosis has not done yet.
	C1, C2, C3, C4 LED indicator (orange)	IO-Link connection status of each communication port ON: The communication port is in IO-Link mode and a device is connected. Blinking: The communication port is in IO-Link mode but no device is connected or thhe device connected is not configured. OFF: The communication port is disabled or in SIO mode.
	Q1, Q2, Q3, Q4 LED indicator (orange)	Indicates the status of input / output in SIO mode ON: The input/output is working in SIO mode. OFF: The communication port is disabled or in IO-Link mode.
	E1, E2, E3, E4 LED indicator (red)	Indicates if any warning or error occurs in the IO-Link connection Blinking: A warning or error occurs OFF: No warnings or errors
3	Removable terminal block	IO-Link
4	Arrangement of the input/output terminals	Arrangement of the terminals
5	Terminal block clip	Removal of the terminal block
6	DIN rail clip	Secures the module onto the DIN rail
7	Module connecting set	Connects the modules
8	Label	Nameplate

2.9 Load Cell Module Specifications

2.9.1 General Specifications

- AS02LC-A

Item	Description
Rated supply voltage/Power consumption	24 VDC (-15 to +20%) / 5W
Minimum/maximum voltage	18~31.2VDC
Maximum current consumption	150 mA
Input signal range	±40mVDC
Sensibility	+5 VDC +/-10%
ADC resolution	24 bits
Highest precision	0.04%
Applicable sensor type	Four-wire or six-wire load cell
Expanding a temperature coefficient	$\leq \pm 50$ ppm/K v. E
Reducing a temperature coefficient to zero	$\leq \pm 0.4$ μ V/K
Linearity error	$\leq 0.02\%$
Response time	2.5, 10, 16, 20, 50, 60, 100, 200, and 400ms
Eigenvalue applicable to a load cell	0-1, 0-2, 0-4, 0-6, 0-20, 0-40 and 0-80 mV/V
Maximum distance for connecting a load cell	100 meters
Maximum output current	5 VDC * 160 mA
Allowable load	40-4,010 Ω
Common-mode rejection ratio (CMRR @50/60 Hz)	≥ 100 dB
Extreme pulse value range	0-8
Averaging weights	1-100 (FW V1.04: 1 to 400)
Isolation	Between a digital circuit and the ground: 500 VAC Between an analog circuit and the ground: 500 VAC Between an analog circuit and a digital circuit: 500 VAC
Weight	147 g

2.9.2 Load Cell Module Profiles

- AS02LC-A

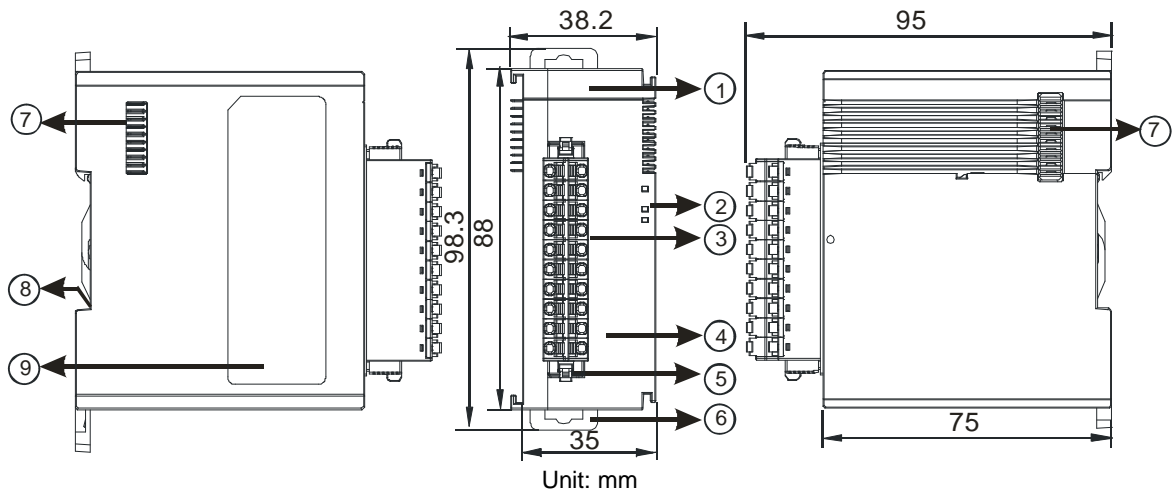

Number	Name	Description
1	Model name	Model name of the module
2	POWER LED indicator	Indicates the status of the power supply ON: the power is on OFF: no power
	ERROR LED indicator	Error status of the module ON: a serious error occurs in the module. OFF: the module is normal. Blinking: a minor error occurs in the module.
	Analog to digital conversion indicator	Indicates the analog to digital conversion status Blinking: conversion is taking place OFF: stop conversion
3	Removable terminal block	The inputs are connected to sensors. The outputs are connected to loads to be driven.
4	Arrangement of the input/output terminals	Arrangement of the terminals
5	Terminal block clip	Removal of the terminal block
6	DIN rail clip	Secures the module onto the DIN rail
7	Module connecting set	Connects the modules
8	Ground clip	
9	Label	Nameplate

2.9.3 Load Cell Module Dimensions

- AS02LC-A

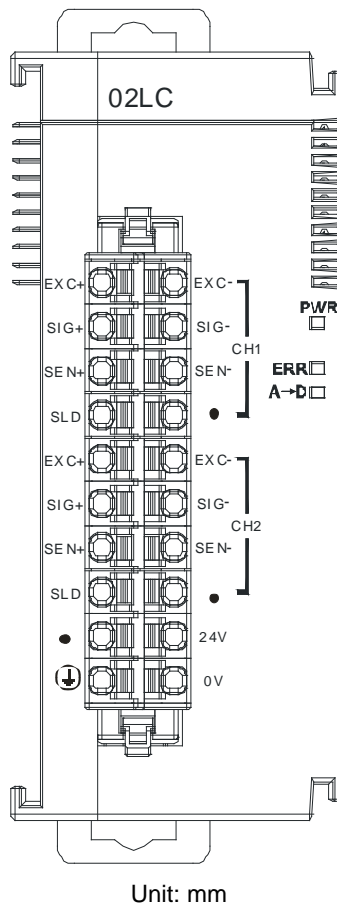

2.10 Extension Card Specifications

2.10.1 General Specifications

- AS-F2AD

Two DC analog signal input channels:

Item	Voltage Input	Current Input
Rated Input Range	0 V - 10 V	4 mA - 20 mA
Resolution	12-bit	11-bit
Digital Conversion Range	0 - 4000	0 - 2000
Hardware Input Limit*1	0V ~ +10.24V	4mA ~ 20.37mA (FW V1.00) 3.63mA ~ 20.37mA (FW V1.20 or later)
Digital Conversion Limit*2	0 ~ 4095	0 ~ 2047 (FW V1.00) - 48 ~ 2047(FW V1.20 or later)
Error Rate	room temperature: $\pm 0.5\%$; full temperature range: $\pm 1.0\%$	
Isolation	The isolation between digital and analog is 500 VAC; no isolation between channels.	
Input Impedance	2 M Ω	250 Ω
Conversion Time*3	3 ms / CH	
Characteristic Curve		
Digital Value Output*4	Card 1	SR168 (CH1), SR169 (CH2)
	Card 2	SR170 (CH1), SR171 (CH2)

*1: The input signal should NOT exceed the limit. If exceeding the limit, damage may occur.

*2: If the input signal exceeds the hardware input limit, the module only shows the maximum value. If the input signal is below the lower limit, it only shows the minimum value. If the input signal exceeds the hardware input limit, it also exceeds the digital conversion limit and a conversion limit error appears. For example in the current input mode (4 mA to 20 mA), when the input signal is 0 mA, exceeding the hardware lower limit, it also exceeds the conversion lower limit. The module uses the lower limit value (-48) as the input signal. If a disconnected analysis is required, you can check if the digital conversion value is -48.

*3: The conversion time is the time for each channel to convert signals to hardware input signals. If you need to calculate a complete conversion time, you need to add the PLC scan time.

*4: Use the program to read the values in SR to obtain the corresponding A/D conversion value for the channel.

*5: Refer to section 2.2.16 SM/SR notes for more information on descriptions of SM27/SR27 analog input error codes.

● **AS-F2DA**

Two DC analog signal output channels:

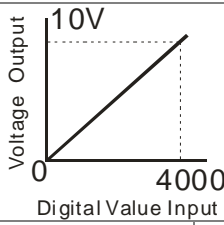
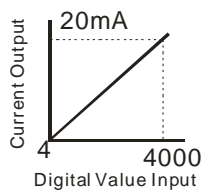
Item	Voltage Output	Current Output	
Analog Signal	0 V - 10 V	4 mA - 20 mA	
Resolution	12-bit	12-bit	
Digital Conversion Limit	0 - 4000	0 - 4000	
Error Rate	room temperature: $\pm 0.5\%$; full temperature range: $\pm 1.0\%$		
Isolation	The isolation between digital and analog is 500 VAC; no isolation between channels.		
Impedance Allowance	$\geq 1 \text{ k}\Omega$	$\leq 500 \Omega$	
Conversion Time*1	2ms / CH		
Characteristic Curve			
Digital Value Output*2	Card 1	SR172 (CH1)	SR173 (CH2)
	Card 2	SR174 (CH1)	SR175 (CH2)

*1: The conversion time is the time for each channel to convert signals to hardware input signals. If you need to calculate a complete conversion time, you need to add the PLC scan time.

*2: Use the MOV instruction to move the value to the SR to obtain the corresponding voltage output value.

● **AS-F232**

The AS series PLC is built with COM1 (RS-485), and COM2 (RS-485). You can use this extension card for communication with different interfaces such as RS-232 and a PC. The communication functions and isolation levels are the same as the PLU CPU built-in ones. It can be used in slave or master mode. After installing the extension card, go to the HWCONFIG in the ISPSOft for communication setup.

■ Wiring example

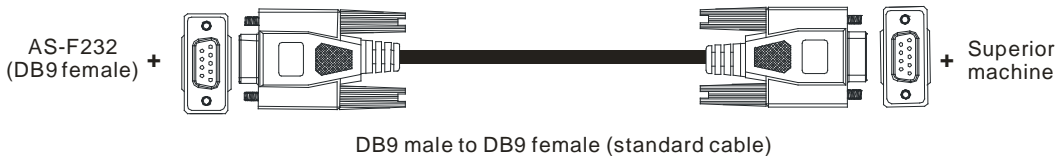

● **AS-FCOPM**

With its own standalone communication port, the extension card can work independently and can act as a master or a slave. After installing the extension card, go to the HWCONFIG in ISPSOft to set up the communication.

■ Wiring example

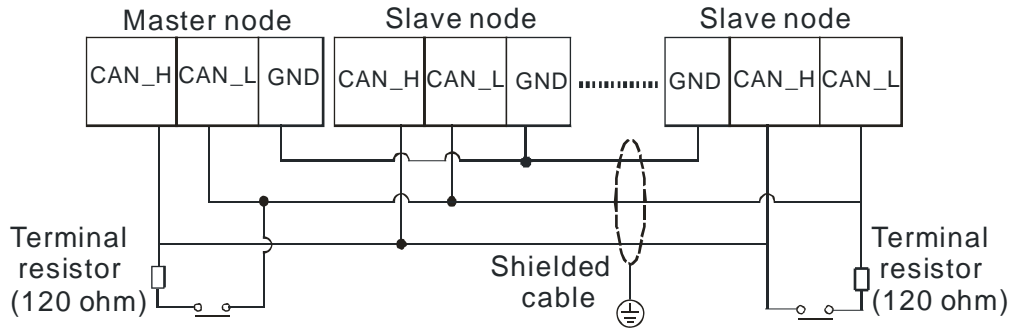

● **AS-F422**

You can use this extension card for communication with Delta HMI series or other devices through the RS-422 communication port. You can use this extension card for communication with different interfaces such as RS-232 and a PC. The communication functions and isolation levels are the same as the PLU CPU built-in ones. It can be used in slave or master mode. After installing the extension card, go to the HWCONFIG in the ISPSOft for communication setup.

■ Wiring example of the communication with Delta HMI DOPA series via COM2

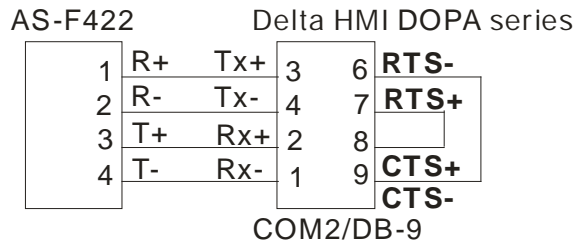

● **AS-F485**

With its own standalone communication port, the extension card can work independently. You can use this extension card for communication with different interfaces such as RS-232 and a PC. The communication functions and isolation levels are the same as the PLU CPU built-in ones. It can be used in slave or master mode. After installing the extension card, go to the HWCONFIG in the ISPSOft for communication setup.

■ Wiring example

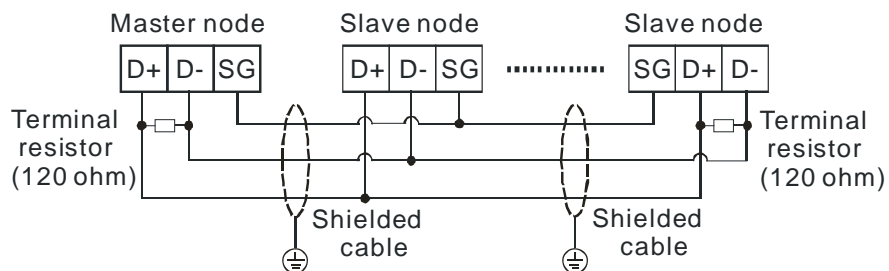

- **AS-FEN02**

With its own standalone communication port, the extension card can work independently and can be set as a MODBUS TCP server, Client or EtherNet/IP Adapter. After installing the extension card, go to the HWCONFIG in ISPSOFT to set up the communication.

Ethernet communication interface

Item	Specifications
Connector type	RJ-45*2
Transmission speed	10/100BASE-T (X) full duplex, switched Ethernet
Cable	CAT5e (up to 100 m)
Communication protocol	Modbus TCP Server, Client and EtherNet/IP Adapter
Isolation	1500 VAC

- **AS-FOPC02**

With its own standalone communication port, the extension card can work independently and can be set as a Modbus TCP Server and OPC UA Server. After AS-FOPC02 is installed on the PLC, you need to go to HWCONFIG to edit the parameters.

Ethernet communication interface

Item	Specifications
Connector type	RJ-45*2
Transmission speed	10/100BASE-T (X) full duplex, switched Ethernet
Cable	CAT5e (up to 100 m)
Communication protocol	Modbus TCP Server and OPC UA Server
Isolation	1500 VAC

- **AS-FPFN02**

With its own standalone communication port, the extension card can work independently and can be set as a PROFINET slave to connect to PROFINET network and exchange data with PROFINET master. After installing the extension card, go to the PROFINET Configurator to set up the communication and download the configurations to the master and then the master sends the configurations to the function card.

Ethernet communication interface

Item	Specifications
Connector type	RJ-45*2
Transmission speed	10/100BASE-T (X) full duplex, switched Ethernet
Cable	CAT5e (up to 100 m)
Communication protocol	PROFINET RT
Isolation	1500 VAC

● AS-FFTP01

With its own standalone communication port, the extension card can work independently and can be set as a MODBUS TCP server, Client or EtherNet/IP Adapter. After installing the extension card, go to the HWCONFIG in ISPSOft to set up the communication.

Ethernet communication interface

Item	Specifications
Connector type	RJ-45*2
Transmission speed	10/100BASE-T (X) full duplex, switched Ethernet
Cable	CAT5e (up to 100 m)
Communication protocol	Modbus TCP Server, Client and EtherNet/IP Adapter
Isolation	1500 VAC

Micro SD

Item	Specifications
Applicable SD card	Micro SD card
Capacity	Max.<= 2TB (SD/SDHC/SDXC)
Speed class rating	Class 10 (C1)
Busbar interface	High Speed (25MB/s)
➤ It is suggested to use the Micro SD with 32GB capacity and Class10 rating	

● AS-FECAT

This communication card can work independently and does NOT occupy the communication port of PLC CPU. It can act as Modbus TCP Server and EtherCAT Master. After AS-FECAT is installed, you can go to HWCONFIG from ISPSOft for editing in the Function Card 2 section.

Ethernet communication interface

Item	Specifications
Connector type	RJ-45*2
Transmission speed	10/100BASE-T (X) full duplex, switched Ethernet (before EtherCAT Master enabled)
Cable	CAT5e (up to 100 m)
Communication protocol	Modbus TCP Server and EtherCAT Master
Isolation	1500 VAC

2.10.2 Extension Card Profiles

- AS-F2AD/AS-F2DA/AS-F422/AS-F485

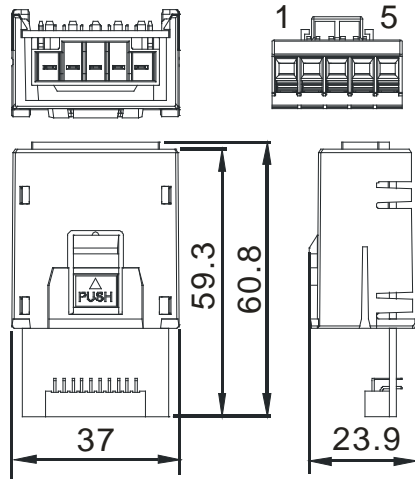

Unit: mm

Pin no.	AS-F2AD	AS-F2DA	AS-F422	AS-F485
1	V1+	VO1	R+	-
2	I1+	IO1	R-	-
3	V2+	VO2	T+	D+
4	I2+	IO2	T-	D-
5	COM	COM	SG	SG

- AS-F232/AS-FCOPM

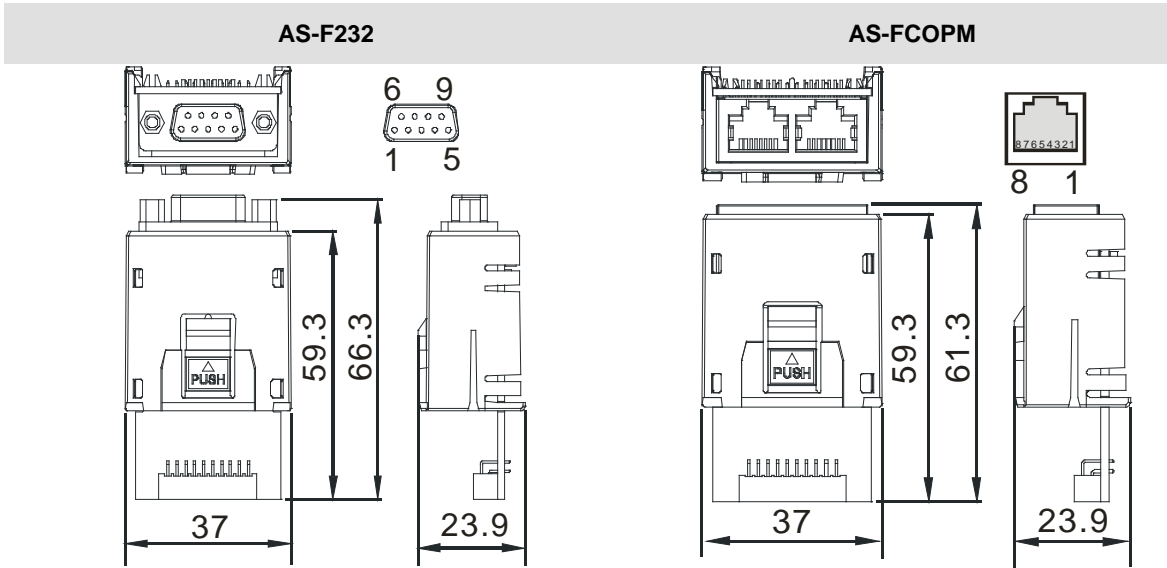

Unit: mm

Pin no.	AS-F232	AS-FCOPM
1	-	CAN_H
2	TX	CAN_L
3	RX	GND
4	-	-
5	GND	-
6-9	-	-

● AS-FEN02

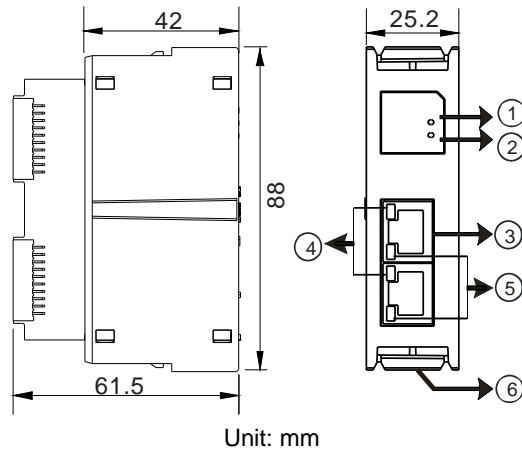

Number	Name	Description
1	MS indicator	Indicates the status of the communication card Green light ON: the operation is working normal Green light BLINKING: the setting is not complete Red light ON: internal communication fail, can NOT be recovered Red light BLINKING: internal communication timeout OFF: no power
2	NS indicator	Indicates the status of Ethernet connection Green light ON: a CIP connection is established Green light BLINKING: a CIP connection is not established after power-on Red light ON: duplicated IP address Red light BLINKING: communication timeout (a CIP connection has been established after power-on) / IP address change OFF: no power / network cable is not connected
3	RJ-45 port X1/X2	For network connections
4	LINK indicator X1/X2	Indicate the status of Ethernet connection Green light ON: a network connection is established OFF: a network connection is not established
5	ACT indicator X1/X2	Indicate the status of Ethernet communication Orange BLINKING: data transmission OFF: no data transmission
6	Clip ring	Secures AS series

RJ-45 Pin Definition

1 TX+	2 TX-	3 RX+	4 N/C
5 N/C	6 RX-	7 N/C	8 N/C

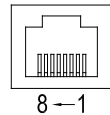

● AS-FPFN02

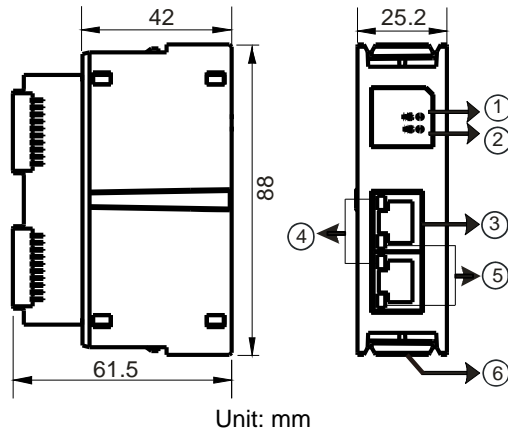

Number	Name	Description
1	SF indicator	System Fault Indicator Red light ON: an error occurs in the topology or RTU module OFF: no system error
2	BF indicator	Bus Fault Indicator Red light ON: no PROFINET connection Red light BLINKING: the connection is working fine but the communication with PROFINET Controller is NOT normal. OFF: the connection with PN-Controller is working fine.
3	RJ-45 port X1/X2	Uses for network connections
4	LINK indicator X1/X2	Indicates the status of Ethernet connection Green light ON: a network connection is established OFF: a network connection is not established
5	ACT indicator X1/X2	Indicates the status of Ethernet communication Orange BLINKING: data transmission OFF: no data transmission
6	Clip ring	Secures AS series

RJ-45 Pin Definition

1 TX+	2 TX-	3 RX+	4 N/C	<p>8-1</p>
5 N/C	6 RX-	7 N/C	8 N/C	

● AS-FOPC02

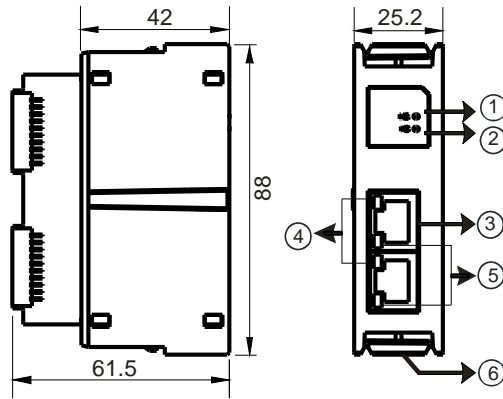

Unit: mm

Number	Name	Description
1	MS indicator	Indicates the status of the communication card Green light ON: the operation is working normal Green light BLINKING: the setting is not complete Red light ON: powering on, or internal communication fail, can NOT be recovered Red light BLINKING: internal communication timeout OFF: no power
2	NS indicator	Indicates the status of Ethernet connection Green light ON: an OPC UA connection is established Green light BLINKING: an OPC UA connection is not established after power-on Red light ON: duplicated IP address Red light BLINKING: communication timeout (OPC UA connection has been established after power-on) / IP address change OFF: no power / network cable is not connected
3	RJ-45 port X1/X2	For network connections
4	LINK indicator X1/X2	Indicate the status of Ethernet connection Green light ON: a network connection is established OFF: a network connection is not established
5	ACT indicator X1/X2	Indicate the status of Ethernet communication Orange BLINKING: data transmission OFF: no data transmission
6	Clip ring	Secures AS series

RJ-45 Pin Definition

1 TX+	2 TX-	3 RX+	4 N/C
5 N/C	6 RX-	7 N/C	8 N/C

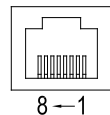

● AS-FFTP01

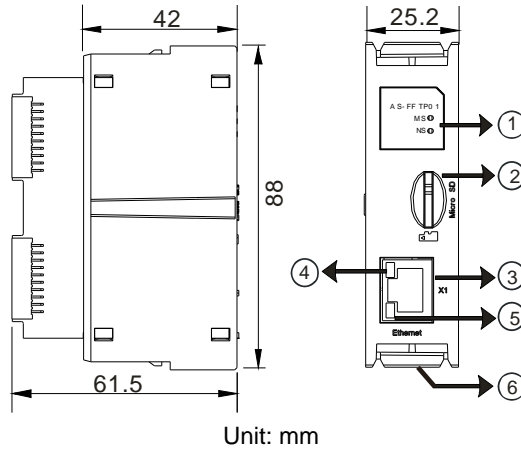

Number	Name	Description
1	MS indicator	Indicates the status of the communication card Green light ON: the communication card operation is working normal Green light BLINKING: communication card is initializing Red light ON: powering on or internal communication fail, can NOT be recovered Red light BLINKING: internal communication timeout; reboot is required. OFF: no power
	NS indicator	Red light ON: IP address conflict; remove the device with the same IP address on the network
2	Micro SD card slot	For Micro SD card
3	RJ-45 port	For network connections
4	LINK indicator	Indicate the status of Ethernet connection Green light ON: a network connection is established OFF: a network connection is not established
5	ACT indicator	Indicate the status of Ethernet communication Orange BLINKING: data transmission OFF: no data transmission
6	Clip ring	Secures AS series

RJ-45 Pin Definition

1 TX+	2 TX-	3 RX+	4 N/C
5 N/C	6 RX-	7 N/C	8 N/C

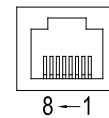

● AS-FECAT

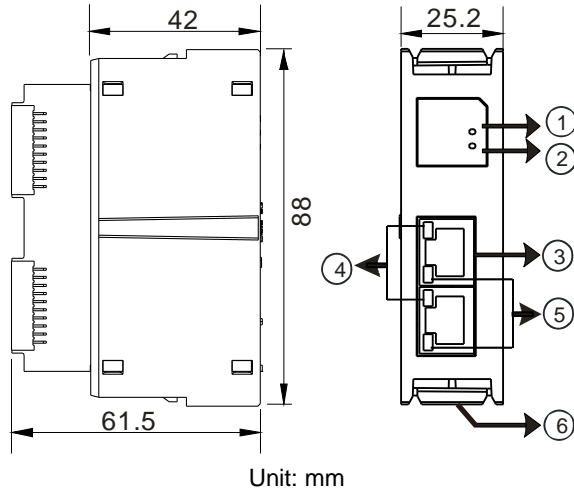

Number	Name	Description
1	SYS indicator	Indicates the power status of the communication card and the status of the firmware update Green light ON: Power On Green light BLINKING: firmware updating OFF: no power or firmware updating is complete.
2	ECAT indicator	Indicates the status of EtherCAT communication Green light ON: the communication card operation is working normal (All slaves are in the operational state.) Red light ON: the network connection between master and slave is not established. Red light BLINKING (2s): the connection of slave is lost. Red light BLINKING (5s): the state of slave is not normal OFF: ECAT master function is not enabled. Going to state of firmware updating
3	RJ-45 ports x1, x2	For network connections
4	LINK indicators x1, x2	Indicate the status of Ethernet connection Green light ON: a network connection is established OFF: a network connection is not established
5	ACT indicators x1, x2	Indicate the status of Ethernet communication Orange BLINKING: data transmission OFF: no data transmission
6	Clip ring	Secures AS series

RJ-45 Pin Definition

1 TX+	2 TX-	3 RX+	4 N/C
5 N/C	6 RX-	7 N/C	8 N/C

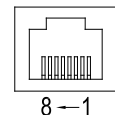

2.10.3 Function Card Weights

	AS-F2AD	AS-F2DA	AS-F422	AS-F485	AS-F232	AS-FCOPM	AS-FEN02	AS-FEN02 / AS-FOPC02 / AS-FFTP01 / AS-FECAT
Weight	30 g	30 g	22 g	29 g	26 g	29 g	51 g	51 g

2.11 Power Supply Module Specifications

2.11.1 General Specifications

- AS-PS02/AS-PS02A

Item		Specifications
Supply voltage		100–240 VAC (-15% to +10%) 50/60 Hz±5%
Action specifications		If the input power supply is larger than 85 VAC, the power supply module can function normally.
Allowable instantaneous power failure time		If the instantaneous power failure time is less than ten milliseconds, the power supply module keeps running.
Fuse		2.5A/250 VAC
Inrush current		< 70A@115 VAC
24 VDC output		AS-PS02: 2 A for internal use: the CPU and the modules. AS-PS02A: 1.5 A for internal use: the CPU and the modules; 0.5 A for external use.
Power protection		The 24 VDC output is equipped with the short circuit protection and the overcurrent protection.
Electronical isolation		1,500 VAC (Primary-secondary), 1,500 VAC (Primary-PE), 500 VAC (Secondary-PE)
Insulation voltage		Above 5 MΩ The voltage between all inputs/outputs and the ground is 500 VAC.
Ground		The diameter of the ground should not be less than the diameters of the cables connected to the terminals L and N.
Weight	AS-PS02	270 g
	AS-PS02A	310 g

2.11.2 Power Supply Module Profiles

- AS-PS02

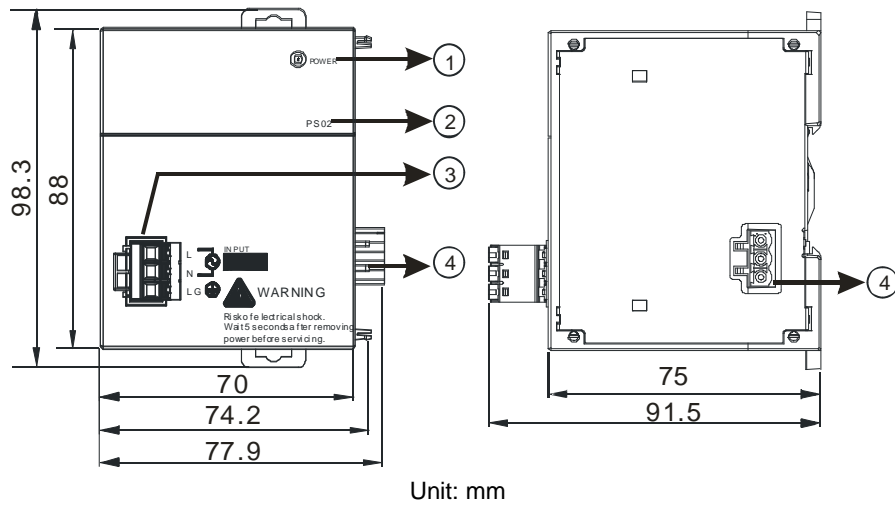

- AS-PS02A

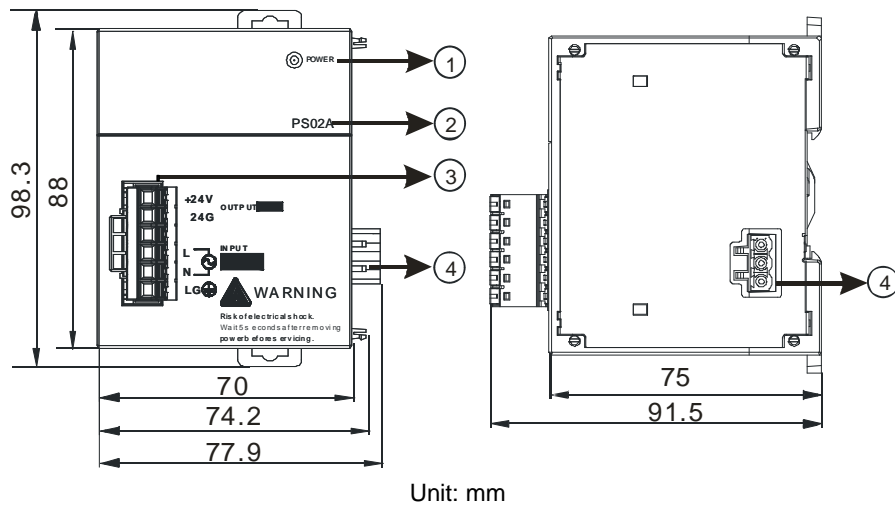

Number	Name	Description
1	POWER LED indicator (green)	Indicates the status of the power supply
2	Model name	Model name of the power supply module
3	Arrangement of the terminals	+24V: connecting external 24VDC + 24G: connecting external 24G LG: Line ground L: AC power input (Line) N: AC power input (Neutral)
4	Power output	Connected with AS series

2.12 Power Supply Module Adapter Specification

For easier wiring, this adaptor allows wiring on the bottom of the module instead of on the left-side of the module. If you already purchased AS-PS02 or AS-PS02A, you do not need this adaptor to have an easier wiring.

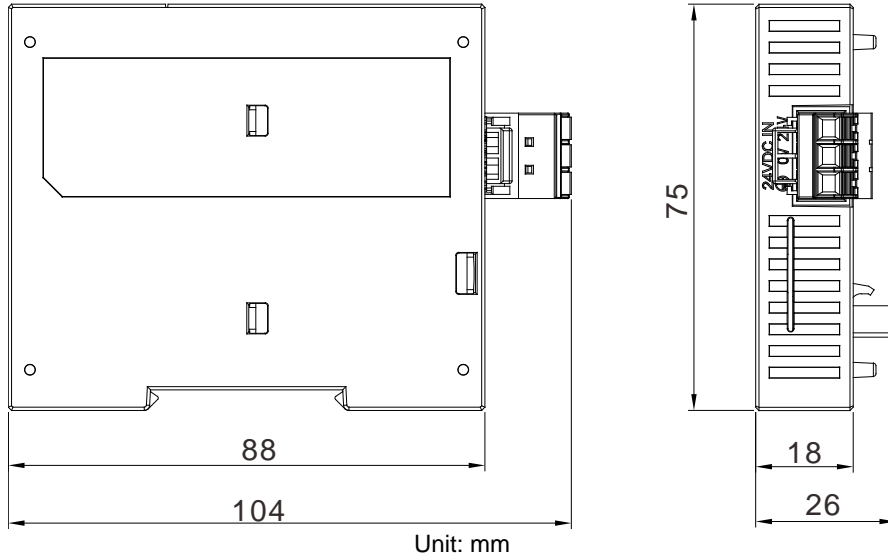

Chapter 3 Installing Software

Table of Contents

3.1	Installing and Uninstalling ISPSOft.....	3-2
3.1.1	Installing ISPSOft	3-2
3.1.2	Uninstalling ISPSOft.....	3-9
3.2	Installing and Uninstalling COMMGR	3-9
3.2.1	Installing COMMGR.....	3-10
3.2.2	Uninstalling COMMGR	3-13

Before creating an AS Series system, you need to install ISPSOft / DIADesigner and COMMGR. ISPSOft or DIADesigner is a software platform for integrating the hardware, network configuration, and program development for a system. COMMGR functions as middleware between a computer and devices. It functions as a communication management interface between ISPSOft / DIADesigner and AS Series hardware. This chapter uses ISPSOft for demonstration. For DIADesigner operation, refer to Chapter 3 from DIADesigner software manual. AS for COMMGR operation, refer to software manual (DIAInstaller -> Software Manual).

3.1 Installing and Uninstalling ISPSOft

- System requirements

Item	System requirement	
Operating system	Windows XP / 7 / 8 / 10	
CPU	Pentium 1.5 G or above	
Memory	256 MB or above (512 MB or above is recommended.)	
Hard disk drive	Capacity : 500 MB or above	
CD-ROM drive	This is optional for installing ISPSOft.	
Monitor	Resolution: 800×600 or above (suggested setting: 1024×768/96 dpi)	
Keyboard/Mouse	A general keyboard/mouse or devices compatible with Windows	
Printer	A printer with a driver for Windows. This is needed to print projects.	
RS-232 port	For connecting to a PLC	One of them is used, but a PLC that is connected must have a corresponding port. (*1)
USB port	For connecting to a PLC	
Ethernet port	For connecting to a PLC	
Communication software	COMMGR, a communication manager, must be installed. (*2)	
Supported Models	AH500 series PLCs/DVP series PLCs (exclusive of DVP-PM series PLCs)/ AS series, AC motor drives: VFD with PLC built-in series, and Text panel HMI with PLC built-in series.	

*1. ISPSOft supports several ways to connect a computer to a PLC. Make sure the port and the mode supported by the PLC are correct before you connect a computer to the PLC.

*2. Please refer to section 3.2 for more information about COMMGR.

*3. The functions and specifications mentioned above are only applicable to ISPSOft version 3.00 or above. The older versions are not equipped with complete functions.

3.1.1 Installing ISPSOft

If an older version of ISPSOft has been installed on a computer, uninstall it before you install ISPSOft. Refer to section 3.1.2 for more information about uninstalling ISPSOft. The following are the steps to install ISPSOft.

- (1) Start the Windows operating system and then install ISPSOft. You may need administrative privileges to install the software.
- (2) Put the ISPSOft CD in the CD-ROM drive, or download the installation program from the official Delta website <http://www.delta.com>. Before you install the installation program downloaded from the website, you must decompress the file.
- (3) Click **Start**, and then click **Run...** to open the **Run** window. Specify the path to the file called setup.exe in the **Open** box, and then click **OK**. You can also double-click the **setup** icon to execute the installation program.

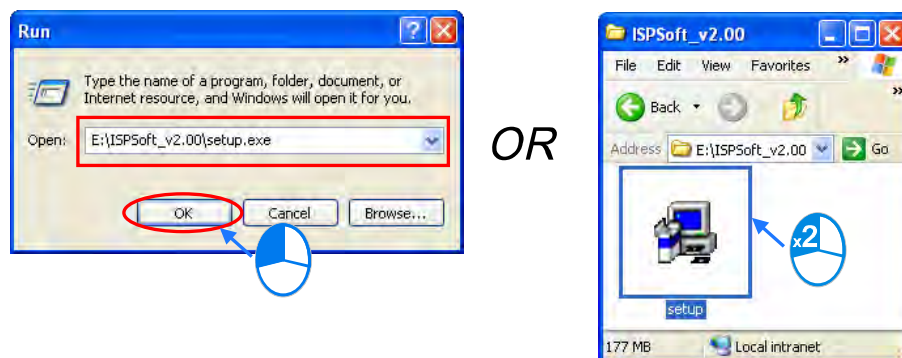

- (4) When a previous version of the ISPSOft is found, click **OK** then **Yes** to uninstall that version shown in the pop-up windows (see below).

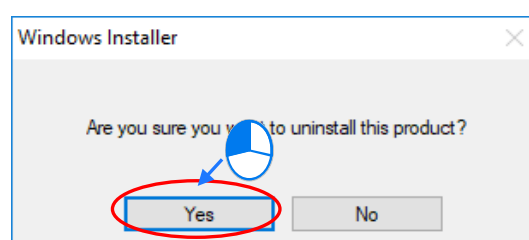
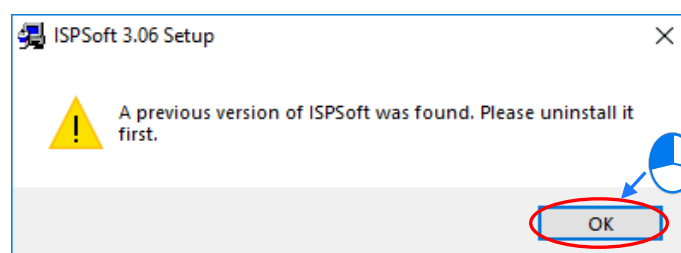

(5) Click **Install** once Shield Wizard window appears.

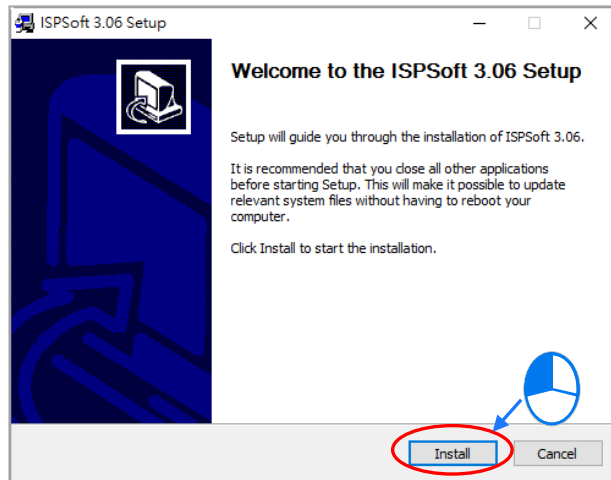

(6) The installation program detects if your computer has installed Microsoft Visual C++ 2013 or not. If not, the following installation steps will show up. Click **Install** to install and after the installation is done, click **Close**.

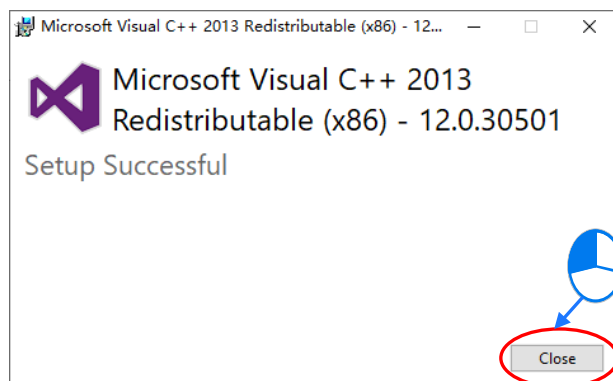
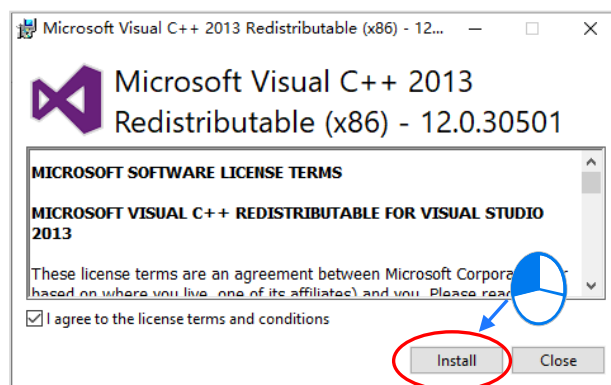

- (7) After the ISPSOft x.xx – Install Shield Wizard window appears, click **Next**.

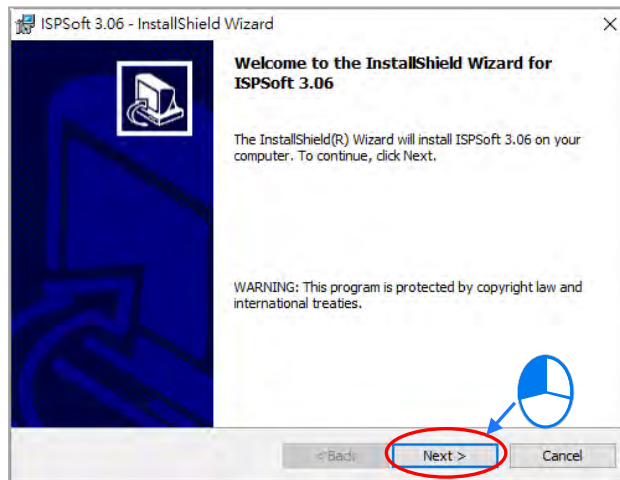

- (8) Select **I accept the terms in the license agreement** and click **Next**.

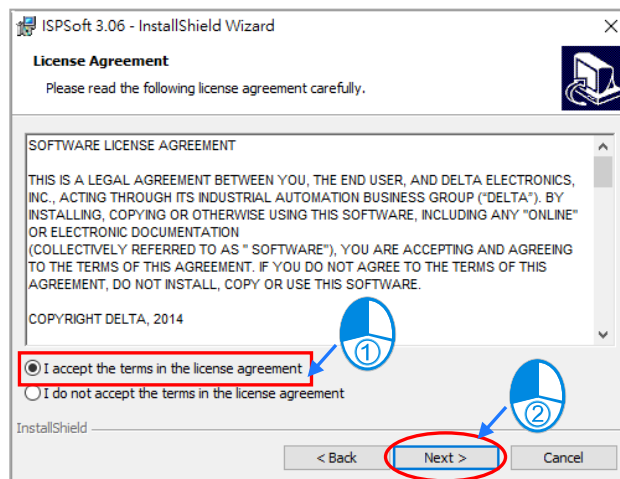

- (9) Type the necessary information in the **User Name** and **Organization** boxes, and then click **Next**.

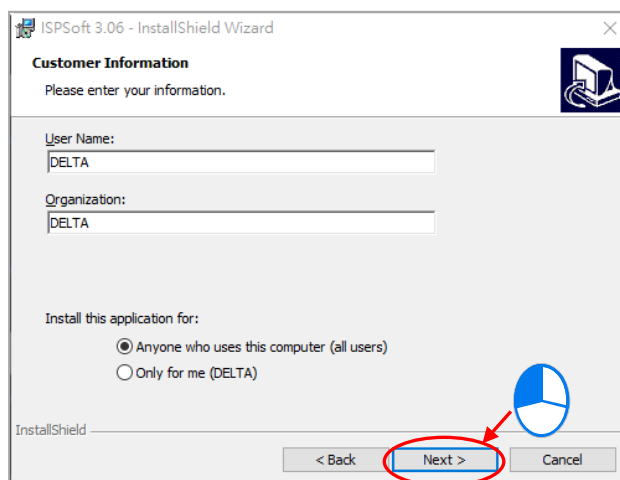

(10) Check if the installation information is correct and then click **Install**.

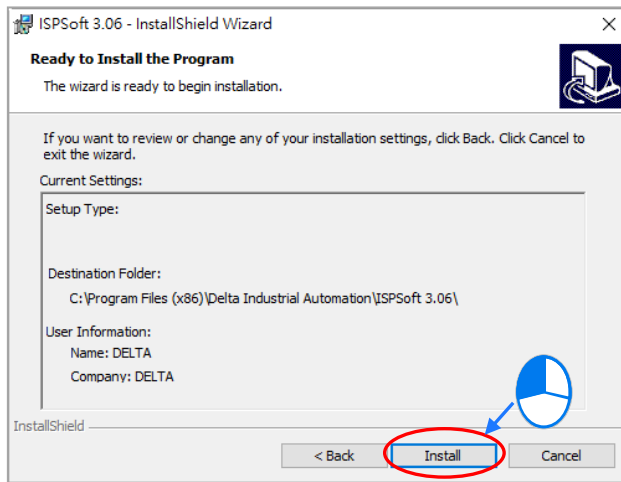

(11) After ISPSOft is installed, click **Finish** to complete the installation.

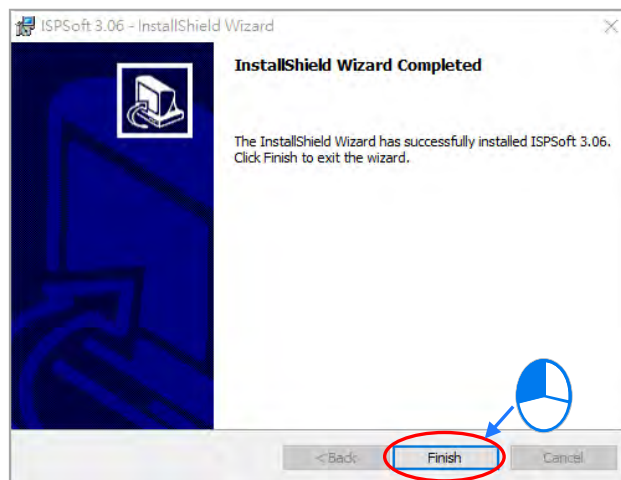
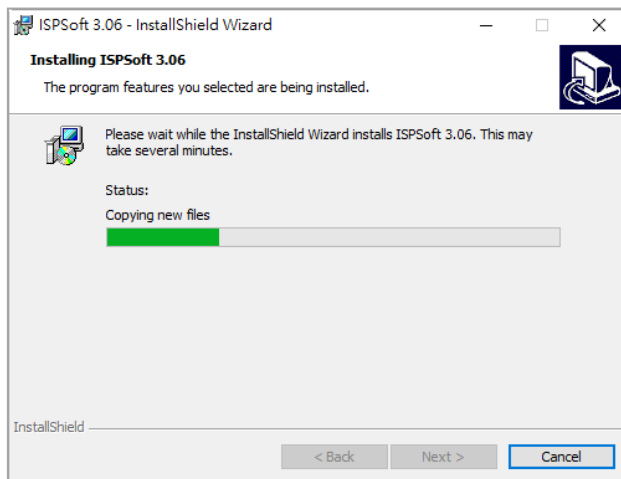

- (12) Next the HWCONFIG is about to be installed. If there is a previous version of HWCONFIG installed in your computer. The following image appears. Click **Yes** to replace the previous version of HWCONFIG with a newer version.

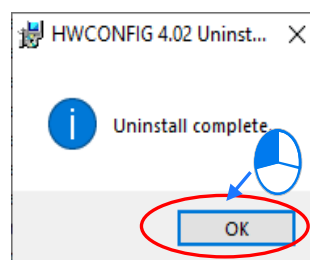
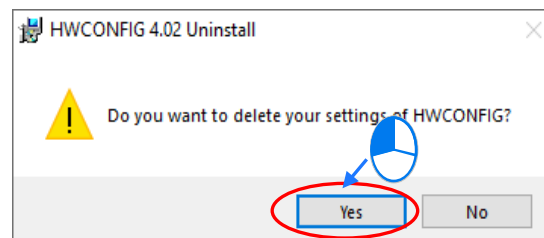
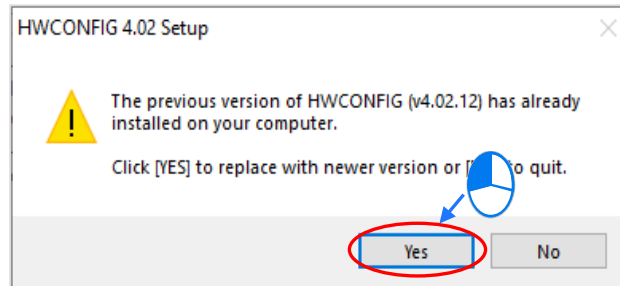

- (13) Click **Install**, once the installation window appears.

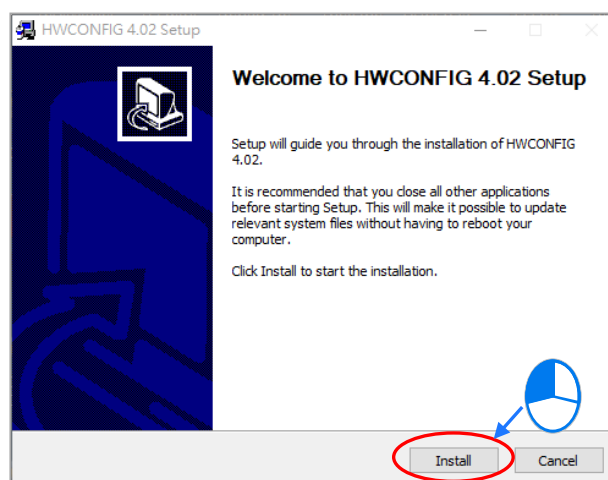

(14) After HWCONFIG is installed, click **Finish** to complete the installation.

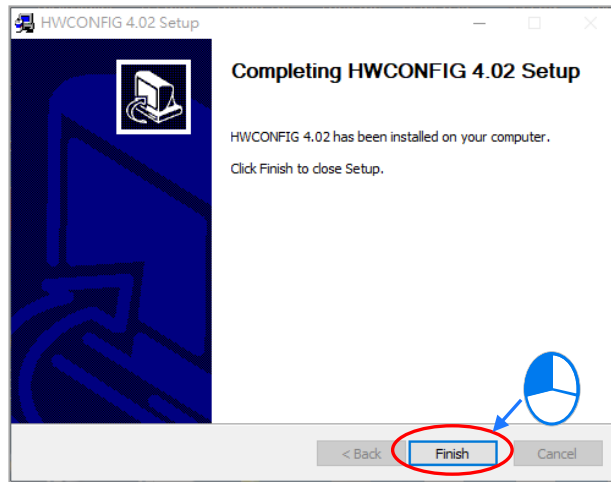

(15) After installation is done, the installation program creates shortcuts on the desktop and the Start menu. Click **Close** to complete the installation.

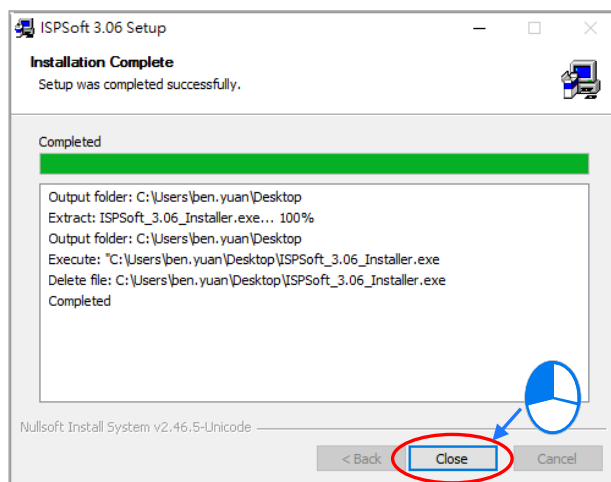

3.1.2 Uninstalling ISPSOft

(1) Generally, you can click **ISPSOft Uninstall** or select **Programs** under **Control Panel** to remove the ISPSOft; when **ISPSOft Uninstall** is not found, there are two methods to uninstall the software:

- Method 1: Select **ISPSOft x.xx** from the Windows list, click **More** then select **Open file location**.
- Method 2: Place **%ProgramData%\Microsoft\Windows\Start Menu\Programs\Delta Industrial Automation\PLC** in the address box and press Enter. Then, double click ISPSOft x.xx file.

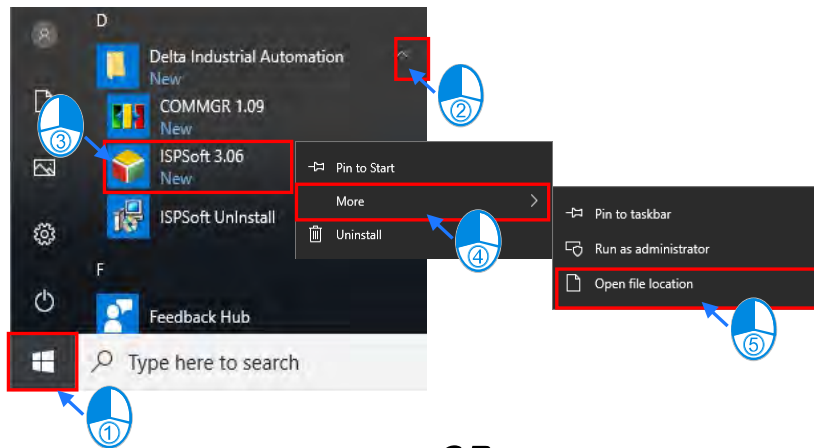

OR

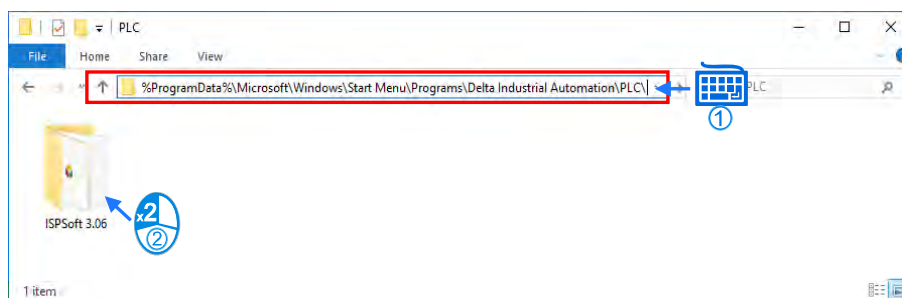

(2) Remove the software by double-click the **ISPSOft Uninstall**.

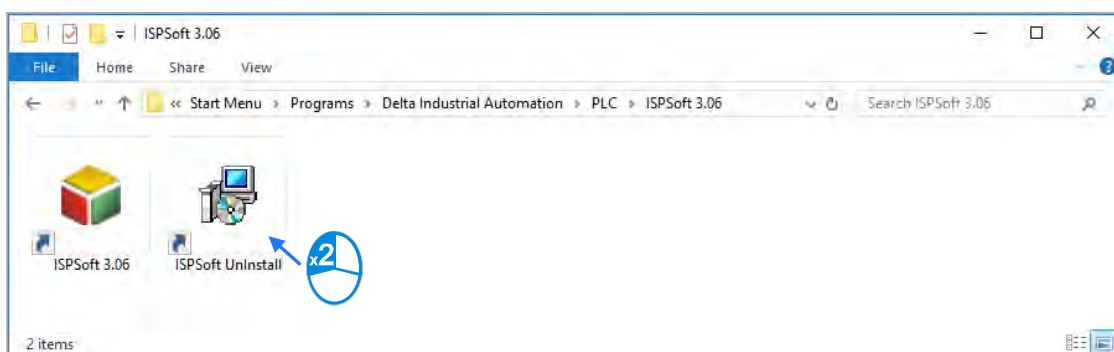

- (3) To uninstall ISPSOft, click **Yes** shown in the pop-up window. The window will automatically close once the software is removed.

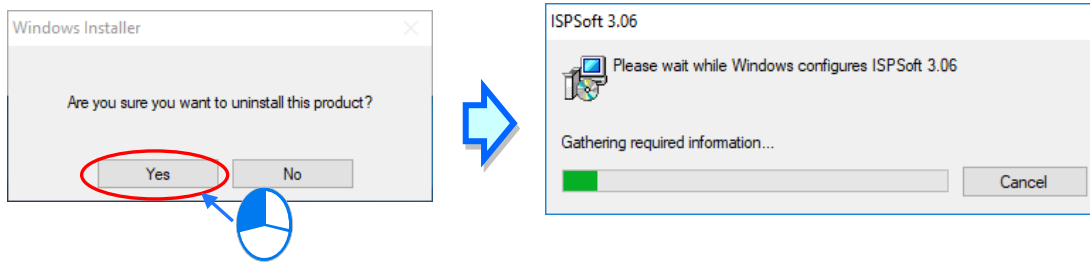

3.2 Installing and Uninstalling COMMGR

3.2.1 Installing COMMGR

COMMGR is a software independent of ISPSOft. It must be installed separately. When the previous version of COMMGR is detected in a computer, that version is advised to be uninstalled first before the latest COMMGR can be installed.

- (1) Start a computer and enter the Windows operating system. You need to log on to the system as a system administrator before installing COMMGR.
- (2) Put a COMMGR CD in the CD-ROM drive, or download the installation program from official Delta website <http://www.deltaww.com/>. Before you install the program downloaded from the website, you must decompress the file.
- (3) Click **Start**, and then click **Run...** to open the **Run** window. Specify the path to the file called setupComm.exe in the **Open** box, and then click **OK**. Alternatively, you can double-click the icon which is used to install COMMGR to execute the installation program.

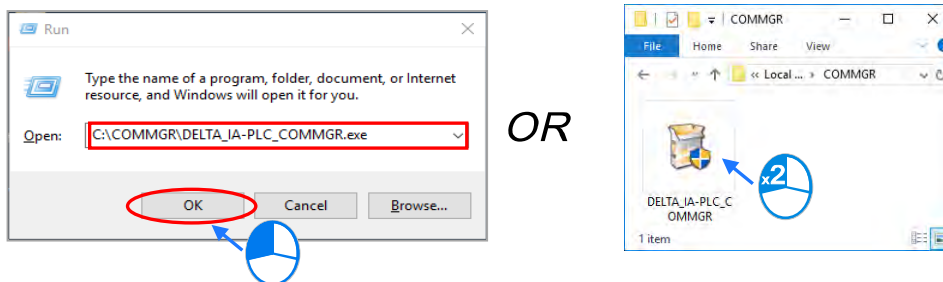

- (4) When the previous version of COMMGR is installed, click **OK** to remove that version shown in the pop-up window (see below) and when uninstall is complete, click **OK** again.

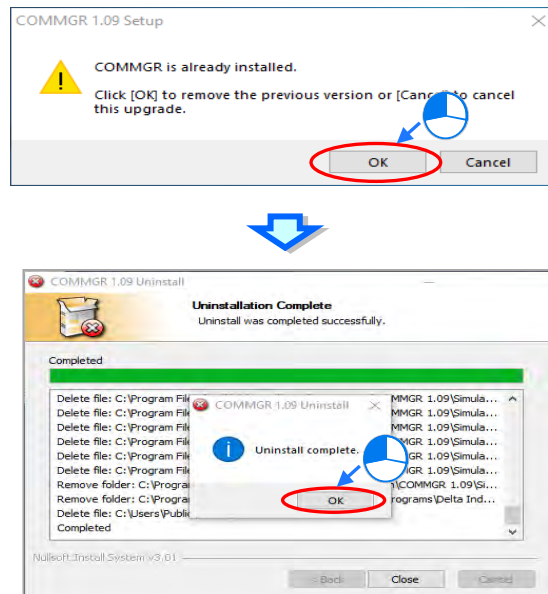

- (5) Click **Next** after the Setup window appears.



- (6) Use default setup in the destination folder. Click **Install** to start the installation.

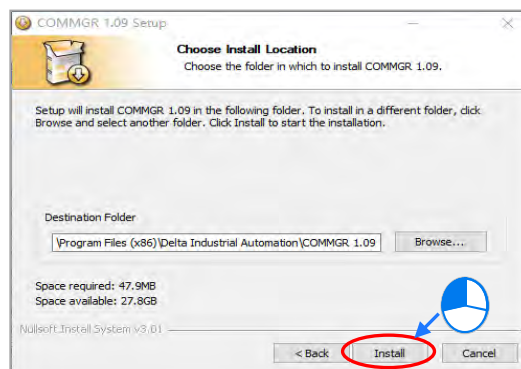

- (7) After you install COMMGR, the installation program creates a shortcut to the program on the **Start** menu. Click **Finish** to complete the installation.

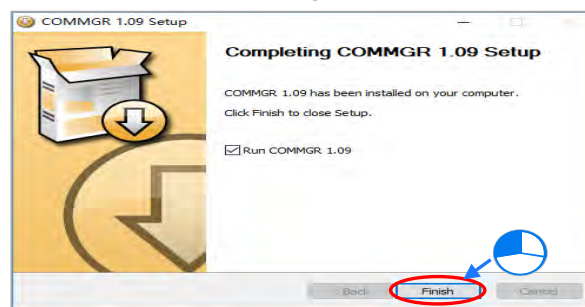
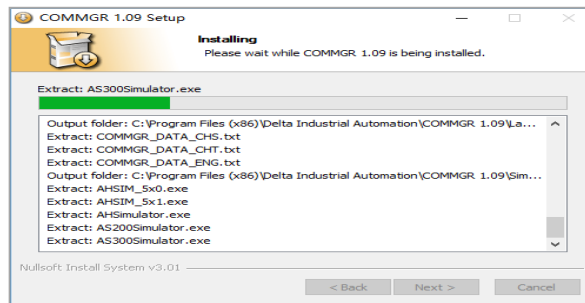

3

3.2.2 Uninstalling COMMGR

- (1) Enter the settings of **Apps & features** in Windows, select **COMMGR x.xx** and click **Uninstall**.

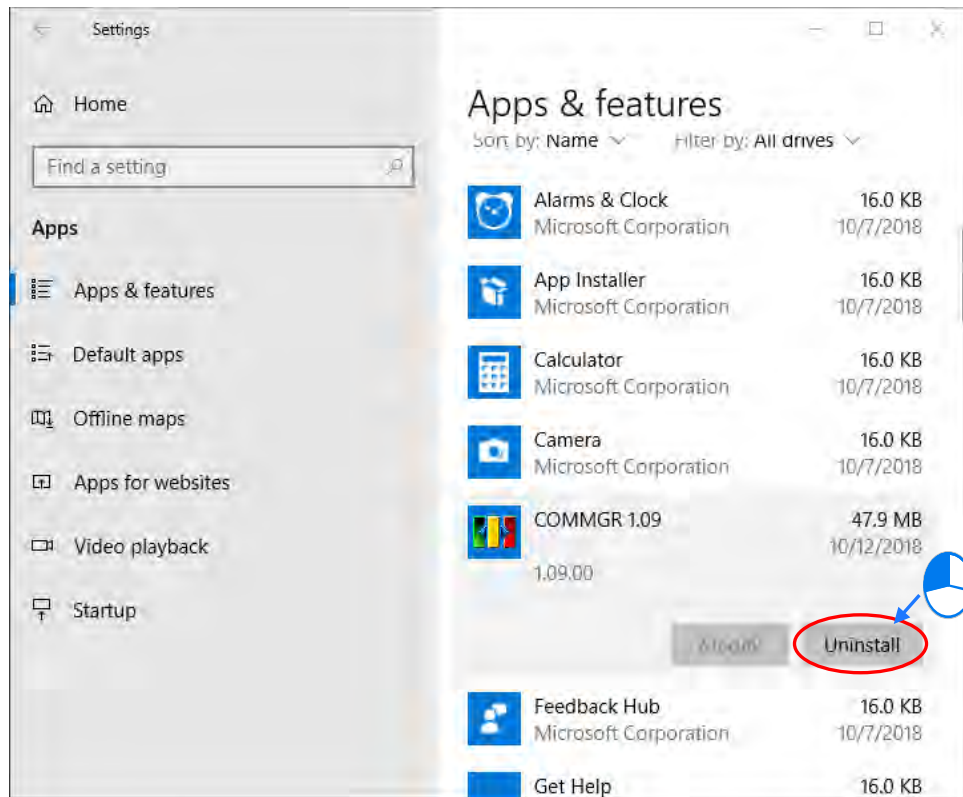

- (2) Click **Yes** and then **OK** to complete COMMGR uninstallation.

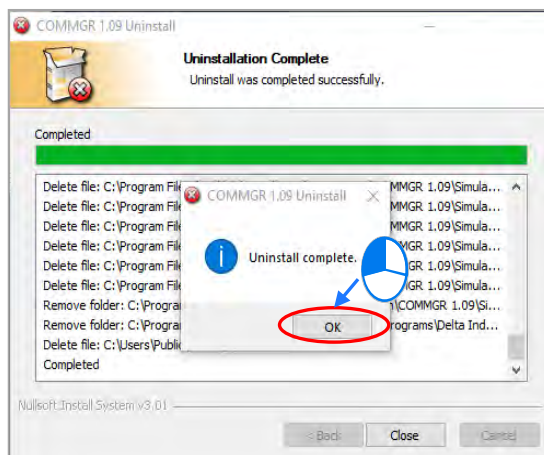
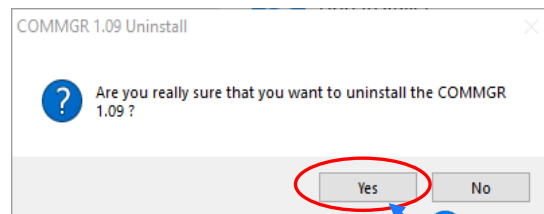

MEMO

Chapter 4 Installing Hardware and Wiring

Table of Contents

4.1	AS Series Hardware Framework	4-3
4.1.1	AS Series Hardware Component	4-3
4.2	Installation Notes	4-6
4.3	Installation	4-7
4.3.1	Installing Modules in a Control Box	4-7
4.3.2	Installing a Module	4-8
4.3.3	Installing a Removable Terminal Block	4-10
4.3.4	Changing a Module	4-12
4.3.5	Installing and Removing an Extension Card for AS300 PLC CPU	4-12
4.3.6	Installing and Removing a Wiring Module for AS300 PLC CPU	4-14
4.4	Wiring.....	4-15
4.5	Connecting Power Cables	4-17
4.5.1	Power Cable Wiring Notes	4-17
4.5.2	Ground	4-18
4.5.3	Wiring Power Supply	4-18
4.5.4	Power Consumption.....	4-20
4.6	Wiring CPU Modules	4-22
4.6.1	Wiring AS324MT-A	4-23
4.6.2	Wiring AS332P-A	4-26
4.6.3	Wiring AS332T-A	4-28
4.6.4	Wiring AS320P-B	4-30
4.6.5	Wiring AS320T-B	4-31
4.6.6	Wiring AS228P-A	4-32
4.6.7	Wiring AS228R-A	4-33
4.6.8	Wiring AS228T-A	4-34
4.6.9	Wiring AS218PX-A / AS218RX-A / AS218TX-A.....	4-35
4.6.10	Wiring AS132T-A/AS148T-A/AS164T-A	4-39
4.6.11	Wiring AS132P-A/AS148P-A/AS164P-A.....	4-40
4.6.12	Wiring AS132R-A/AS148R-A/AS164R-A.....	4-41
4.6.13	Wiring AS Series PLC CPU Communication Ports	4-42
4.7	Wiring Digital Input/Output Modules	4-46
4.7.1	Wiring AS08AM10N-A	4-46
4.7.2	Wiring AS08AN01P-A.....	4-47
4.7.3	Wiring AS08AN01R-A.....	4-48
4.7.4	Wiring AS08AN01T-A.....	4-49
4.7.5	Wiring AS16AM10N-A	4-50
4.7.6	Wiring AS16AN01R-A.....	4-51
4.7.7	Wiring AS16AN01T-A.....	4-52
4.7.8	Wiring AS16AN01P-A.....	4-53
4.7.9	Wiring AS16AP11R-A	4-54

4.7.10	Wiring AS16AP11T-A.....	4-55
4.7.11	Wiring AS16AP11P-A.....	4-56
4.7.12	Wiring AS32AM10N-A.....	4-57
4.7.13	Wiring AS32AN02T-A.....	4-59
4.7.14	Wiring AS64AM10N-A.....	4-62
4.7.15	Wiring AS64AN02T-A.....	4-64
4.8	Wiring Digital Input/Output Terminals	4-67
4.8.1	Wiring Digital Input Terminals	4-67
4.8.2	Wiring Digital Output Terminals	4-71
4.9	Wiring Analog Input/Output Modules	4-75
4.9.1	Wiring AS04AD-A	4-75
4.9.2	Wiring AS08AD-B	4-76
4.9.3	Wiring AS08AD-C	4-77
4.9.4	Wiring AS04DA-A	4-78
4.9.5	Wiring AS06XA-A.....	4-79
4.9.6	Wiring AS02ADH-A	4-81
4.10	Wiring Temperature Measurement Modules	4-85
4.10.1	Wiring AS04RTD-A.....	4-85
4.10.2	Wiring AS06RTD-A.....	4-86
4.10.3	Wiring AS04TC-A / AS08TC-A.....	4-87
4.11	Wiring Positioning Modules and Counter Modules	4-88
4.11.1	Wiring AS02PU-A.....	4-88
4.11.2	Wiring AS04PU-A.....	4-89
4.11.3	Wiring AS02HC-A	4-90
4.12	Load Cell Modules.....	4-93
4.12.1	Wiring AS02LC-A	4-93
4.13	Wiring Network Modules	4-94
4.13.1	AS00SCM-A	4-94
4.13.2	Wiring AS00SCM-A	4-94
4.13.3	AS01DNET-A.....	4-95
4.13.4	Wiring AS01DNET-A.....	4-96
4.13.5	AS04SIL-A.....	4-97
4.13.6	Wiring AS04SIL-A.....	4-97
4.14	Wiring Function Cards	4-100
4.14.1	Communicational Function Card Profiles and the Pin Definitions.....	4-100
4.14.2	Wiring the Communicational Function Cards	4-101
4.14.3	Analog Function Card Profiles and the Pin Definitions	4-104
4.14.4	Wiring AS-F2AD	4-105
4.14.5	Wiring AS-F2DA	4-106

4.1 AS Series Hardware Framework

4.1.1 AS Series Hardware Component

The AS series programmable logic controller is a medium-to-small programmable logic control (PLC). The execution speed and memory capacity are increased. Use of function blocks is also supported. In order to meet your more advanced application requirements, the AS series programmable logic controllers provide more flexible system extension frameworks. Under such system frameworks, you do not need to use several CPU modules to control the system because there are too many I/O points or the equipment is too far away. This retains system completeness, and you can be more efficient in developing projects. Several PLC CPUs are available for various sectors; users can make their choices according to their applications.

- **The minimum requirements for an AS200 / AS300 Series framework**

The minimum framework of the AS200 / AS300 series system consists of one CPU module (AS200 / AS300 PLC CPU) and one power supply module (AS-PS02). AS-PS02 converts AC into DC, providing PLC CPU with direct current power supply. As for AS200 / 300 Series PLC CPU, it is the heart of the system and is responsible for the system control and management.



● **The minimum requirements for an AS100 Series framework**

Since AS100 Series PLC CPU does NOT require a power supply module, AS100 Series PLC CPU is all you need to run a whole system.



● **Communication cable**

Several communication interfaces are included in a CPU module, and many types of network modules are available. You can select a suitable communication cable according to the actual situation.

The following table lists information about communication interfaces and main applications.

Interface	Connector	Application
Communication port	Five-pin removable terminal block	Computer/HMI communication/Industrial control network (2x RS-485)
Ethernet	RJ45	Computer/HMI communication/Remote control/Data exchange/Industrial control network
USB	Mini USB	Computer communication

● **Extension module**

AS Series CPU module is equipped with standard communication ports, select suitable modules according to the actual situation. Various kinds of modules can be purchased according to your needs. Refer to section 1.1.2 for detailed information on the modules that can be used with your AS Series System.

● **The limitations of setting up a standard AS PLC framework**

The following lists the limits for setting up a standard framework of the AS PLC system. Exceeding any one of the limits causes the PLC to send an error message.

Limit 1: You can connect up to 32 extension modules to the PLC, not including the power module, CPU module, and remote module.

Limit 2: The maximum number of digital I/O points is 1024. The built-in digital I/O points of the CPU module are included.

Limit 3: You can connect up to 16 analog modules (AD, DA, XA, RTD, TC and LC) to the PLC.

Limit 4: You can connect up to 4 communication modules (AS00SCM, AS01DNET-A, and AS04SIL-A) to the PLC.

Limit 5: You can connect up to 8 positioning modules (AS02PU-A, AS04PU-A and AS02HC-A) to the PLC.

Limit 6: You can connect up to 15 remote modules (AS00SCM+AS-FCOPM) to the PLC. The remote modules can work with up to eight digital/analog modules.

Limit 7: You can connect up to 15 remote modules (AS00SCM+AS-FEN02) to the PLC. The remote modules can work with up to eight digital/analog modules.

Limit 8: You can connect up to 8 extension modules (digital modules, analog modules, temperature measurement module, etc.) to AS01DNET-A (RTU mode).

Limit 9: You can connect remote modules to digital/analog modules (temperature measurement and load cell modules), but not to communication or positioning modules.

4.2 Installation Notes

- To ensure you have sufficient installation space for AS Series System, before installation begins, be sure to measure the size of your AS Series System and the size of the communication cable connectors and the space between devices should also be taken into account.
- Make sure that the work environment conforms to the specifications for the products. It is necessary to consider the basic temperature/humidity control and dust/corrosion prevention.
- Electromagnetic interference can result in system malfunction. Therefore, you must design the EMC carefully. Refer to Appendix C in this manual for more information on EMC standards.
- If components such as screws and washers are specified in the manual, do use components conforming to the specifications.
- If a cable is connected to a communication port, make sure the cable connector is properly joined to the port on the module.
- For the installation of DIN Rail, use a 35 mm wide rail or use the one that complies with EN 60715.

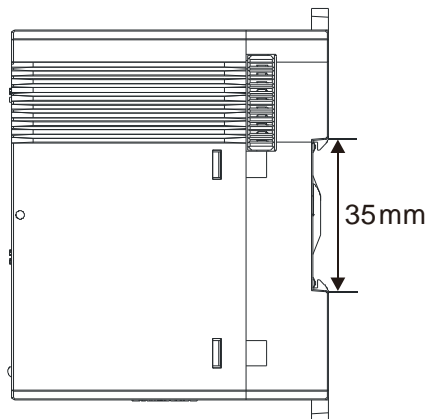

4.3 Installation

4.3.1 Installing Modules in a Control Box

A PLC has to be installed in a closed control box. In order to ensure that the PLC radiates heat normally, the space between the PLC and the control box must be larger than 50 millimeters.

- AS200 / AS300

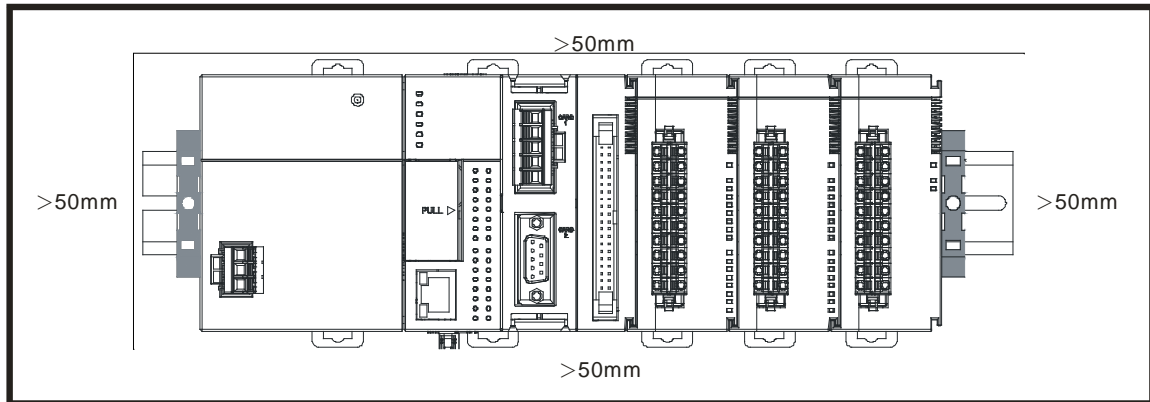

- AS100

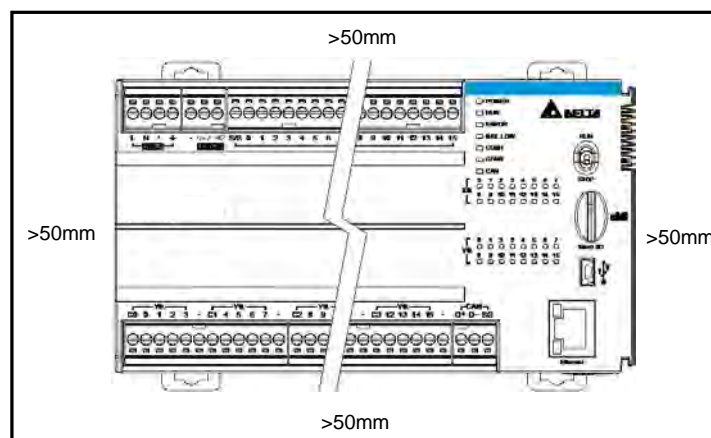

- Keep the PLC away from high-voltage equipment, high-voltage wires, and high-voltage motors.
- In order to prevent the PLC from overheating, please do not install the PLC vertically on the bottom or top of the control box.
- Please install the PLC horizontally in the control box, as shown above.
- If you intend to increase the number of modules, you must leave some space for installing the modules in the control box.

4.3.2 Installing a Module

The methods to install a module are the same for AS100, AS200 and AS300 series PLC CPU. Here we use AS200 / AS300 as an example for demonstration.

1. Press the clip rings if they are out as the image 1 shown. Push the module to the desire position until you hear a click to finish installation.
2. Link the I/O modules on the right side of the PLC and make sure they are hooked together. Push the modules into the DIN rail until you hear a click.
3. After you installed the module, fasten the screws on the modules to secure the module on the DIN rail.

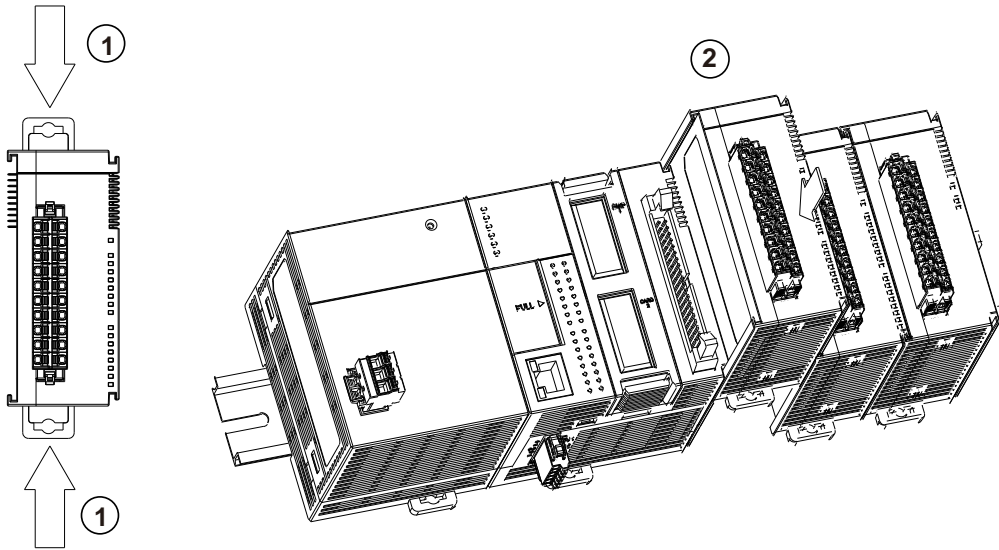

If there is a vibration source near the installation site, install anti-vibration baffles on the sides of the AS Series modules for better stabilization, such as the gray baffles show below.

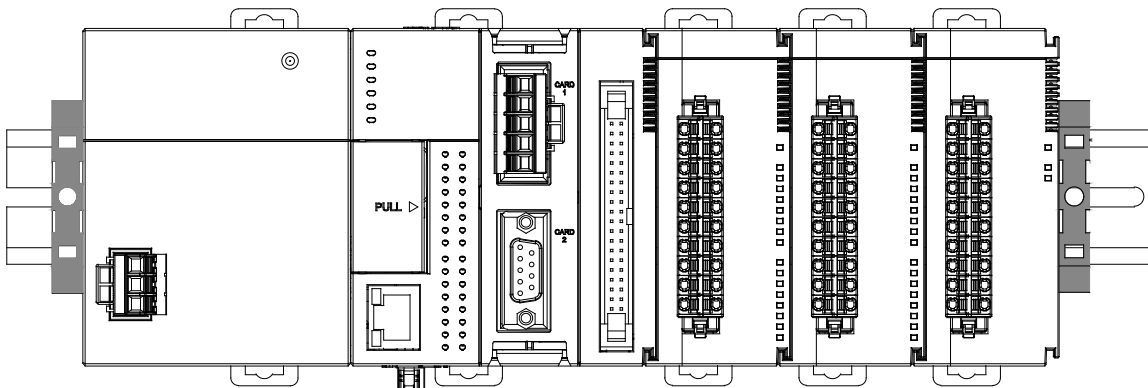

- **Install the baffles:**
 - Hook the baffle onto the DIN rail and press it down as the directional arrow shows below.

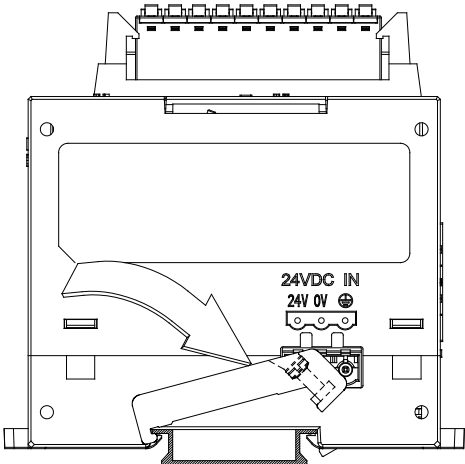

- Use screws to secure the baffle.

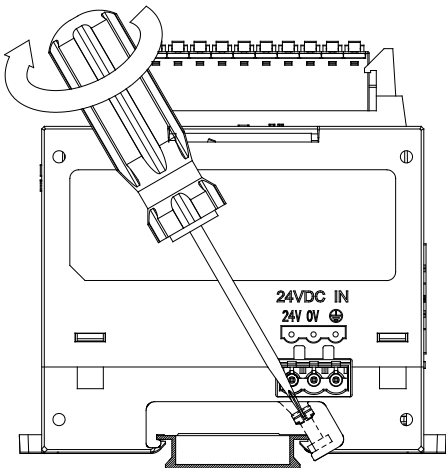

- a. The completed baffle installation is shown below.

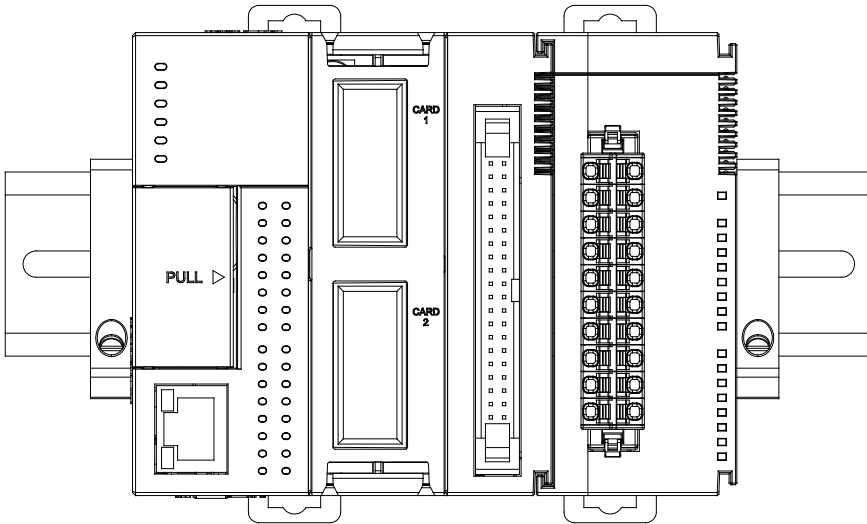

4.3.3 Installing a Removable Terminal Block

For AS200 / AS300 Series PLC CPU: install the removable terminal block on the module as shown below.

- **Installation**

Align the terminal block at the printed circuit board, and press it into the module.

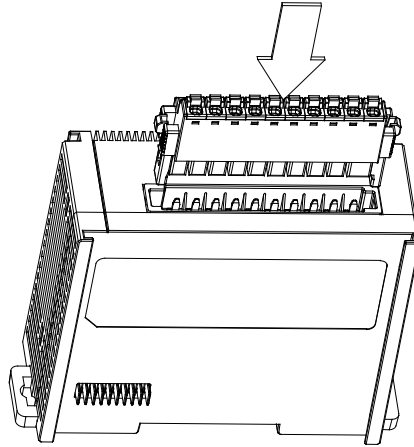

- **Removal**

Pull the clips down in the direction shown by the arrow, and then pull the terminal block up as shown below.

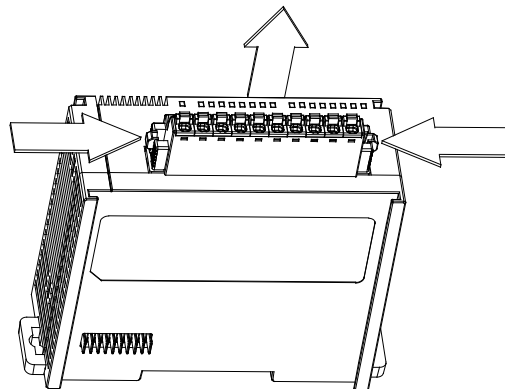

For AS100 Series PLC CPU: install the removable terminal block on the module as shown below.

● **Installation**

Align the terminal block at the printed circuit board, and press it into the module.

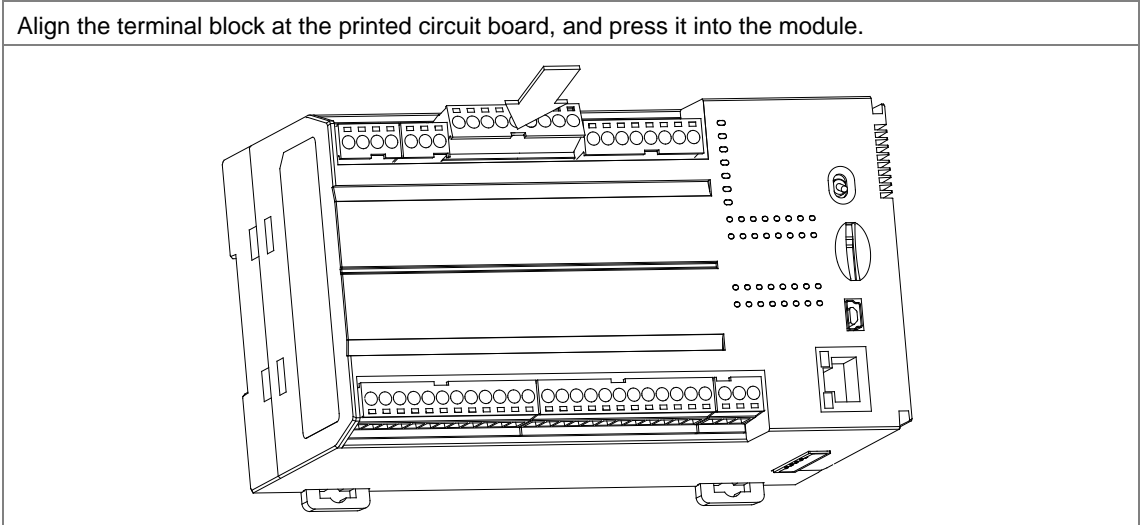

● **Removal**

Use a screwdriver to separate the terminal block from the module and then pull the terminal block out as shown below.

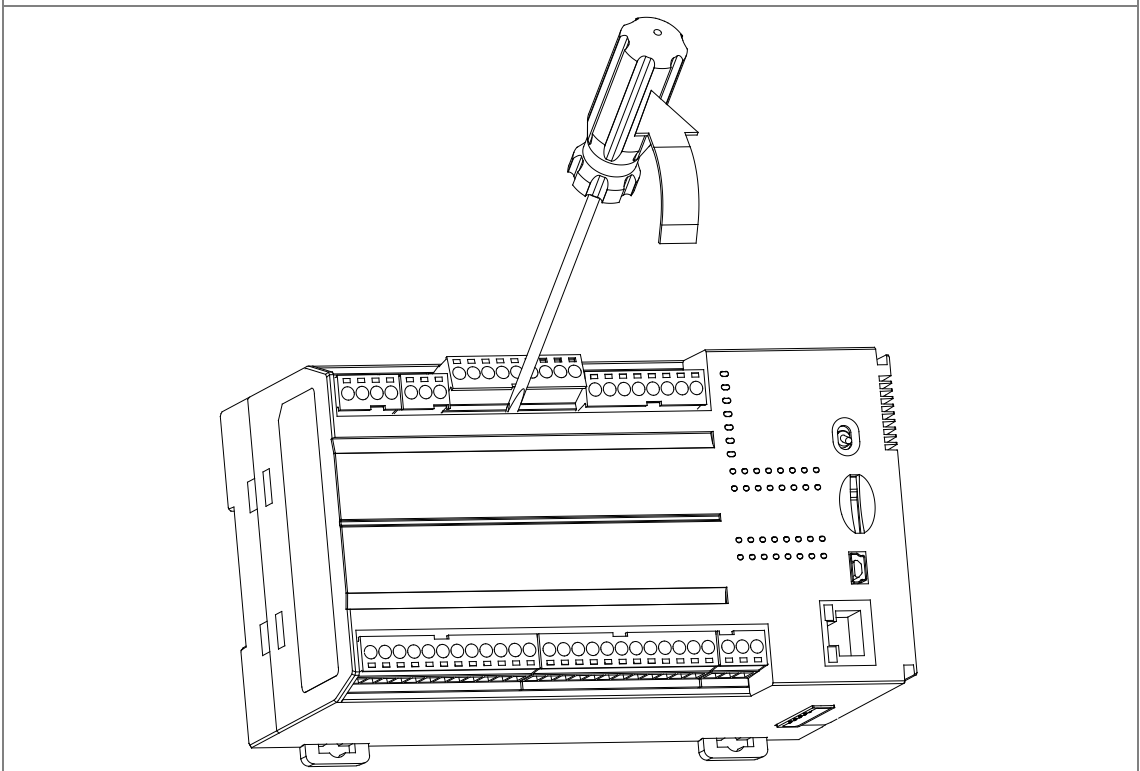

4.3.4 Changing a Module

1. Take the removable terminal block out of the module and pull the clip out from the DIN rail as the image shown below.

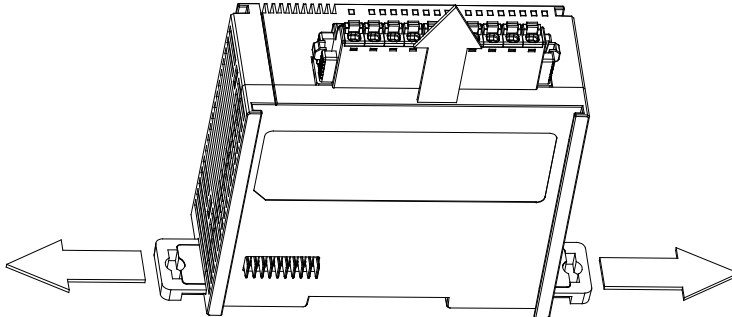

2. Remove the module to be changed out.
3. Slide the new module in as the image shows below.

4

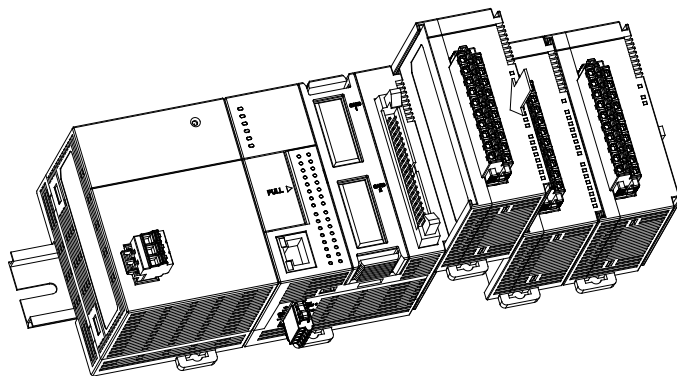

4.3.5 Installing and Removing an Extension Card for AS300 PLC CPU

A. AS-F232/AS-F422/AS-F485/AS-F2AD/AS-F2DA/AS-FCOPM

1. Installation

Push the extension card into the extension card slot until you hear a click.

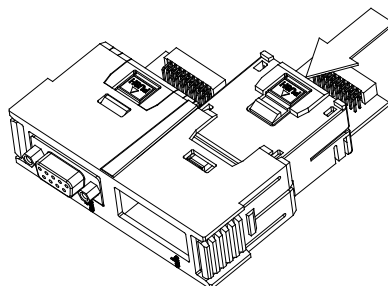

2. Removal

Press the  button to release the extension card and then take the extension card out.

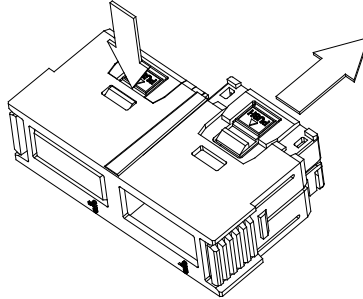

B. AS-FEN02 / AS-FPFN02 / AS-FOPPC02 / AS-FECAT

1. Installation

Push the extension card into the extension card slot until you hear a click.

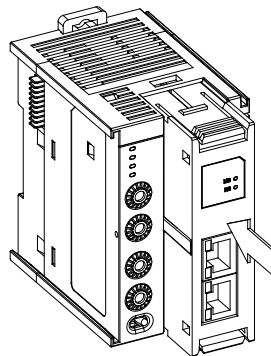

2. Removal

Press the buttons on the upper and lower ends to release the extension card and then take the extension card out.

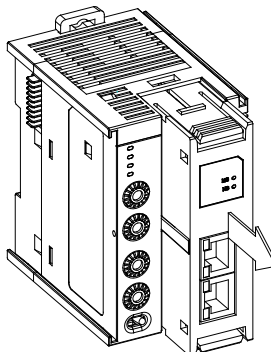

4.3.6 Installing and Removing a Wiring Module for AS300 PLC CPU

Put a communication cable in the port on a CPU module, and make sure the connector of the cable is properly joined to the port.

- **Installation**

1. One side of the wiring module has to be fixed first.
2. Press the driver board in the direction indicated by arrow 1, and make sure the groove is aligned with the DIN rail.

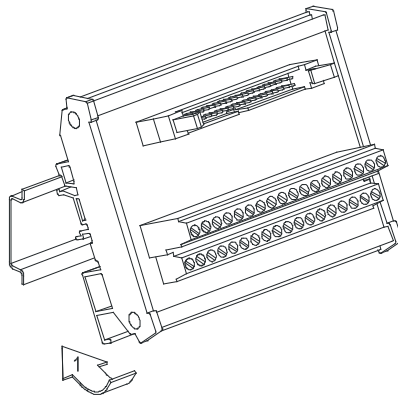

- **Removal**

1. Push the wiring module in the direction indicated by arrow 1.
2. Pull the wiring module in the direction indicated by arrow 2.

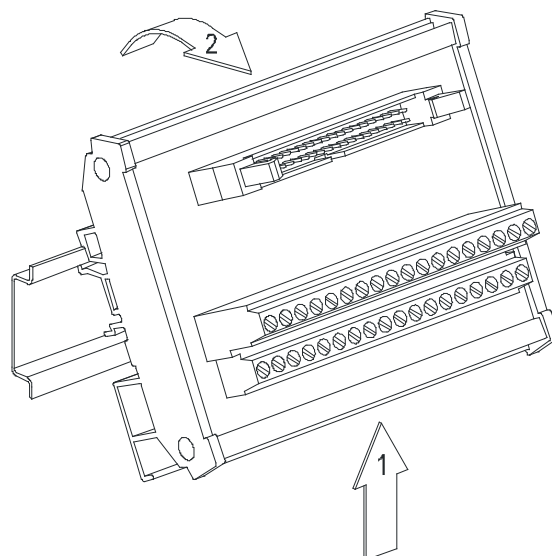

4.4 Wiring

- Please pay attention to the following warnings.

	<ul style="list-style-type: none"> ● Before installing or wiring a module, you must verify that the external power supply is turned off. If the power supply is not turned off, you may get an electric shock, or the product may be damaged. ● After you complete installing or wiring the module, make sure that a terminal block cover is installed on the module before turning on the power supply or operating the module. If the terminal block cover is not installed properly, you may get an electric shock, or the module may not operate normally. ● Be sure to connect the terminals FG and LG with protective grounding conductors. Otherwise, you may get an electric shock, or the module may not operate normally. ● To ensure that a PLC is wired correctly, you must check the rated voltage of the product and the arrangement of the terminals. If the PLC is connected to a power supply that does not conform to the rated voltage, or the product is not wired correctly, a fire may occur, or the product may be damaged. ● The external connections should be crimped, press-welded by specific tools, or soldered correctly. Improper connections may result in a short circuit, fire, or malfunction. ● Tighten the terminal screws to the specified torque. If the terminal screws are loose, a short circuit, fire, or faulty operation may occur. Tightening the terminal screws too far may cause damage to the terminal screws or the module, resulting in a short circuit or malfunction. ● Make sure there are no foreign substances such as iron filings or wiring debris inside the module. Foreign substances may result in a fire, damage, or malfunction.
---	--

- I/O module wiring notes

(1) Terminal definitions

- ◆ Two-/three-wire (passive sensor): the sensor and the system share the same power circuit.
- ◆ Four-wire (active sensor): the sensor uses an independent power supply and should not share the same power circuit with the system.

(2) Terminals with insulation sleeves cannot be used as a terminal block. It is recommended that the terminals be covered with insulation tubes.

(3) Use single-wire cables or two-wire cables with a diameter of 24 AWG to 22 AWG and with less than 1mm pin-type terminals. Only use copper conducting wires with a temperature rating of 60/75°C.

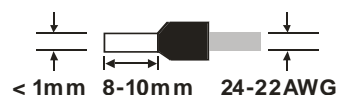

- (4) Keep the input cables, output cables, and power cable separate from one another.
- (5) If the main circuit and the power cable cannot be separated from each other, use a shielded cable, and ground it at the side of the I/O module. In some cases, the shielded cable can be grounded at the opposite side.

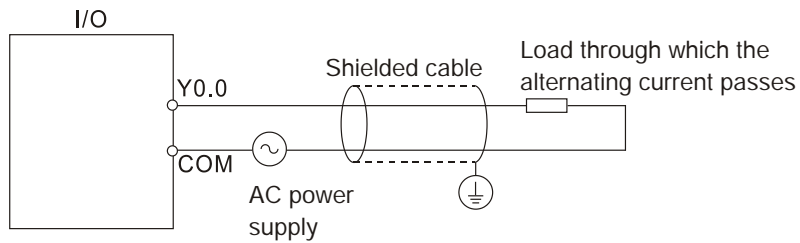

- (6) If you wire a module through conduit, you must ground the conduit correctly.
- (7) Keep 24 VDC input cables separate from 110 VAC input cables and 220 VDC input cables.
- (8) If the wiring length is more than 200 meters (656.19 feet), leakage current can result from parasitic capacitance, and the system will not function properly.

4.5 Connecting Power Cables

4.5.1 Power Cable Wiring Notes

- **Connecting AC power cables**

- (1) If a power grid's input voltage source is alternating current (AC), ranging from 100 VAC to 240 VAC, you need to connect the power supply to the terminals L and N. Do NOT connect 110 VAC or 220 VAC to the input terminals +24V or -24V that will damage the PLC CPU.
- (2) The cables carrying the 110 VAC, 220 VAC, and 24 VDC should be single or two-wire cables.
- (3) Do not bundle 110 VAC cable, 220 VAC cable, 24 VDC cable, the (high-voltage high-current) main circuit, and the I/O signal cable together. The distance between adjacent cables should be more than 100 millimeters (3.94 inches).
- (4) If a power failure lasts less than 10 ms, PLC keeps running without being affected. If the time of power loss lasts longer or the voltage of the power supply is too low, the PLC will stop running and all outputs will be stopped. After the power is back on, the PLC will resume working automatically. (Some auxiliary relays and registers are retainable in the PLC, you can make use of these advantages while designing a PLC program.)
- (5) For the input terminals L and N as well as LG / \perp , use single-wire cables or two-wire cables in a diameter of 12 AWG to 18 AWG and with less than 1mm pin-type terminals. Only use copper conducting wires with a temperature rating of 60/75°C.

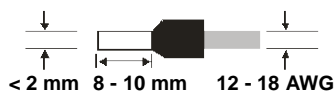

- (6) If cables are connected to the terminals LG or \perp , you must ground the cables. Do not connect LG or \perp to any devices. If LG and \perp are not grounded, the PLC will be susceptible to noise. Since LG / \perp carries electric potential, you will get an electric shock if you touch the metal parts.

- (7) To prevent electrical surge from lightning, install a surge protector as shown below.

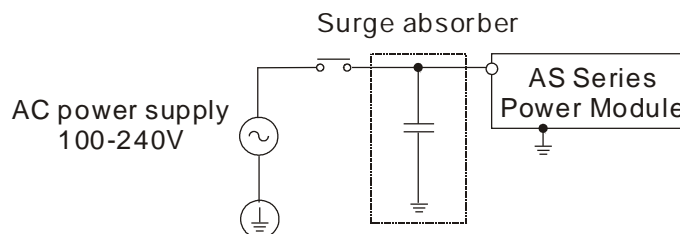

Points for attention:

1. Ground the surge protector and the PLC system.
2. Select the surge protector with a working voltage that is not less than the maximum allowable input voltage.

4.5.2 Ground

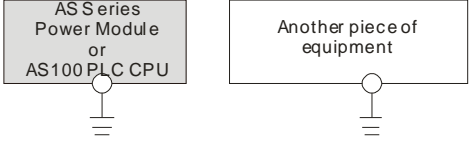
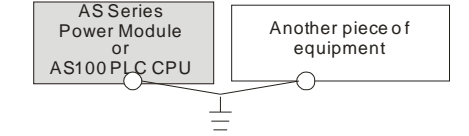
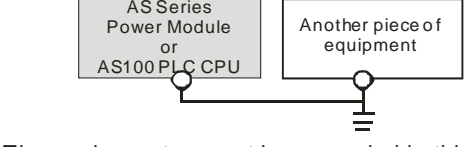
<ul style="list-style-type: none"> • The diameter of the ground should not be less than the diameters of the cables connected to the terminals L and N. • If using multiple pieces of equipment, use a single-point ground. 	 <p>The single-point ground is better.</p>
<ul style="list-style-type: none"> • If you cannot use a single-point ground, use a common-point ground. 	 <p>The common-point ground is permitted.</p>
<ul style="list-style-type: none"> • Do not connect equipment ground wires together as shown on the right. 	 <p>The equipment can not be grounded in this way.</p>

4.5.3 Wiring Power Supply

AS200 / AS300 PLC CPU

- AS-PS02

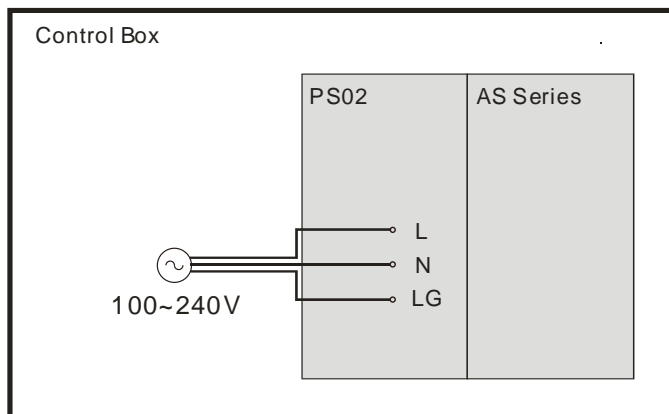

● AS-PS02A

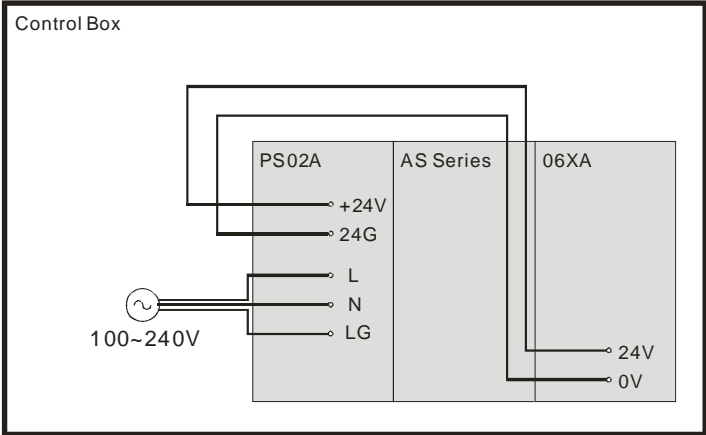

AS100 PLC CPU

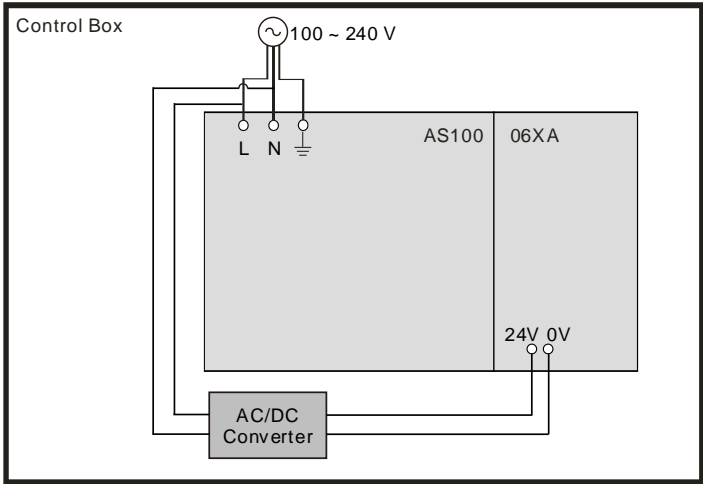

*1. The live wire and the neutral wire in the AC power cable are connected to L and N on the power supply module respectively. To prevent incorrect system operation, the ground in the AC power cable must be connected to LG on the power supply module or \perp of AS100 PLC CPU.

4.5.4 Power Consumption

The following table lists the power consumption for AS Series modules.

Classification	Model name	Internal power consumption (mA)	Internal power consumption (W)	External power consumption (W)
CPU module	AS332P-A	150	3.6	N/A
	AS332T-A	150	3.6	N/A
	AS324MT-A	150	3.6	N/A
	AS320P-B	150	3.6	N/A
	AS320T-B	150	3.6	N/A
	AS300N-A	125	3	N/A
	AS228T-A	150	3.6	N/A
	AS228P-A	150	3.6	N/A
	AS228R-A	190	4.56	N/A
	AS218TX-A	180	4.32	N/A
	AS218PX-A	180	4.32	N/A
	AS218RX-A	200	4.8	N/A
	AS132T-A	110	2.64	N/A
	AS132P-A	110	2.64	N/A
	AS132R-A	160	3.84	N/A
	AS148T-A	125	3	N/A
	AS148P-A	125	3	N/A
	AS148R-A	200	4.8	N/A
AS164T-A	140	3.36	N/A	
AS164P-A	140	3.36	N/A	
AS164R-A	240	5.76	N/A	
Digital I/O module	AS08AM10N-A	20	0.5	N/A
	AS08AN01T-A	30	0.72	N/A
	AS08AN01P-A	60	1.4	N/A
	AS08AN01R-A	70	1.7	N/A
	AS16AM10N-A	20	0.5	N/A
	AS16AP11T-A	30	0.7	N/A
	AS16AP11P-A	30	0.7	N/A
	AS16AP11R-A	80	1.9	N/A
	AS16AN01T-A	60	1.4	N/A
	AS16AN01P-A	60	1.4	N/A
	AS16AN01R-A	140	3.4	N/A
	AS32AM10N-A	20	0.48	N/A
	AS32AN02T-A	30	0.72	N/A
	AS64AM10N-A	30	0.72	N/A
AS64AN02T-A	60	1.44	N/A	
Analog I/O module	AS04AD-A	50	1.2	2.16
	AS08AD-B	50	1.2	2.5
	AS08AD-C	50	1.2	2.5
	AS04DA-A	50	1.2	2.64
	AS06XA-A	50	1.2	2.16
	AS02ADH-A	50	1.2	2
Temperature measurement module	AS04RTD-A	30	0.75	2
	AS06RTD-A	30	0.75	2
	AS04TC-A	30	0.75	2
	AS08TC-A	30	0.75	2
Load cell	AS02LC-A	30	0.75	3

Classification	Model name	Internal power consumption (mA)	Internal power consumption (W)	External power consumption (W)
module				
Positioning module	AS02PU-A	62.5	1.5	N/A
	AS04PU-A	62.5	1.5	N/A
Network module	AS00SCM-A	25	0.6	N/A
	AS01DNET-A	33	0.8	N/A
	AS04SIL-A	33	0.8	0.5
Function cards	AS-F232	20	0.48	N/A
	AS-F422	30	0.72	N/A
	AS-F485	20	0.48	N/A
	AS-FCOPM	20	0.48	N/A
	AS-F2AD	15	0.36	N/A
	AS-F2DA	50	1.2	N/A
	AS-FEN02	50	1.2	N/A
	AS-FPFN02	50	1.2	N/A
	AS-FOPC02	50	1.2	N/A
	AS-FFTP01	55	1.32	N/A
	AS-FECAT	50	1.2	N/A

4.6 Wiring CPU Modules

- When you use open collector NPN/PNP outputs to activate AS300 high speed inputs, you need to have the pull up/pull down resistor connected to X point and S/S. Only use 3 W / 470 ohm or 2 W / 1 Kohm resistors.
- When you use Push-Pull outputs to activate AS PLC CPU high speed inputs, you don't need to use any pull up/pull down resistor connected to X point and S/S.
- While using ports Y as output ports, all the C0 points should be connected. Do NOT only use ONE C0 point.

Note:

- In case open collector NPN/PNP outputs are used to activate AS300 high speed inputs, you need to have the pull up/pull down resistor connected to X point and S/S.
- In case Push-Pull outputs are used to activate AS300 high speed inputs, you don't need to use any pull up/pull down resistor connected to X point and S/S.
- It is recommended to use the resistor of 3W/470ohm or 2W/1Kohm.
- While using ports Y as output ports, all the C0 points should be connected. Do NOT only use ONE C0 point.

Through the following wiring you can increase the resistance of a resistor. See the illustration below for reference.

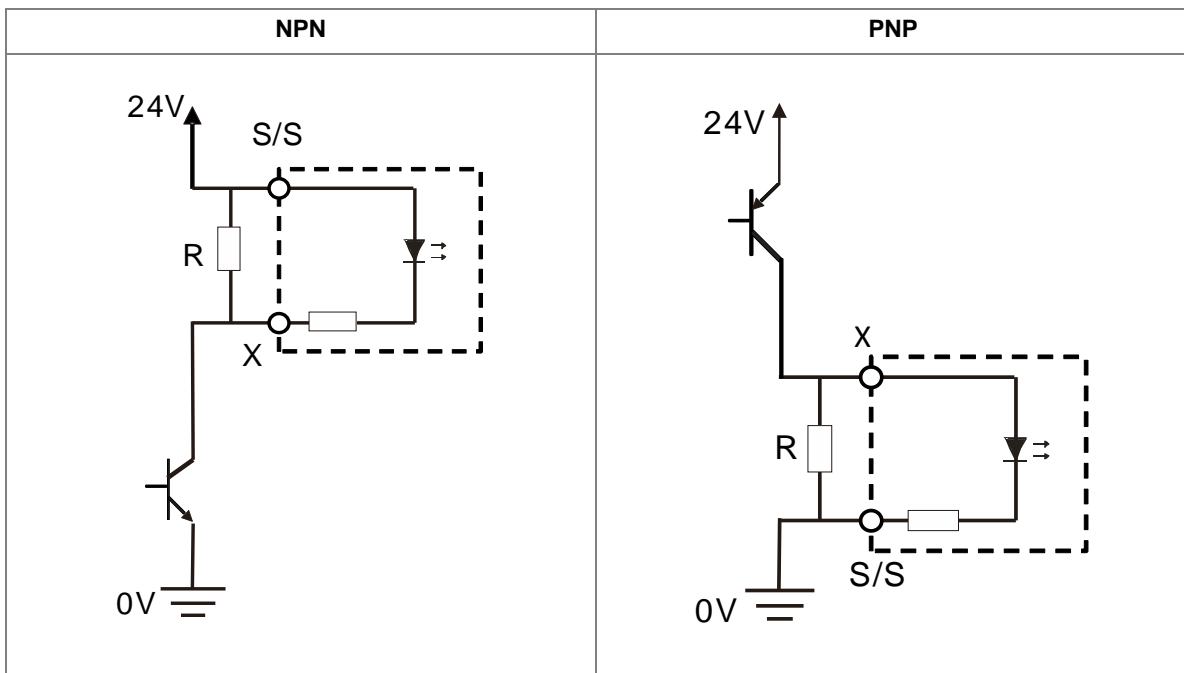

4.6.1 Wiring AS324MT-A

Input form	X0.0+ to X0.3+/X0.0- to X0.3- : Differential input X0.4–X0.11: Direct current (sinking or sourcing)
Input current/voltage	X0.0+ to X0.3+/X0.0- to X0.3- : 5V DC, 5 mA X0.4–X0.11: 24 VDC, 5 mA
Output form	Y0.0+ to Y0.3+/Y0.0- to Y0.3- : Differential input Y0.4–Y0.11: Transistor-T (sinking)
Output current/voltage	Y0.0+ to Y0.3+/Y0.0- to Y0.3-: 5V DC, 20mA/output (+ and – as a group, e.g. Y0.0+ and Y0.0- is a group) Y0.4 to Y0.11: 5 to 30V DC, 0.1A/output, 0.8A/COM

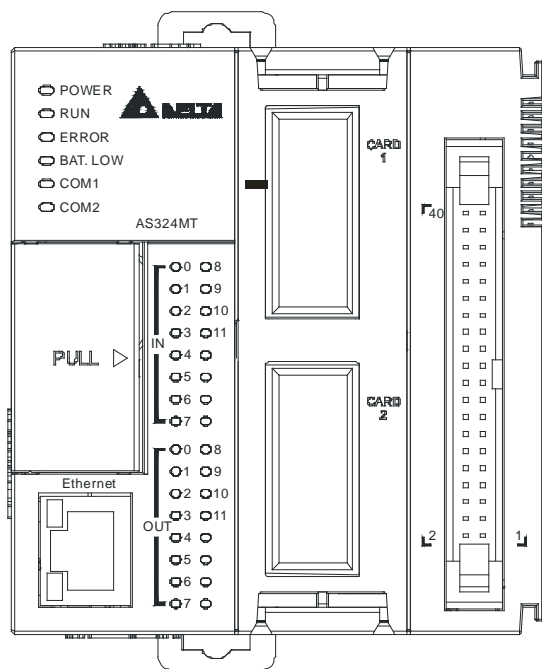

40	39	S/S	S/S
38	37	X0.11	X0.10
36	35	X0.9	X0.8
34	33	X0.7	X0.6
32	31	X0.5	X0.4
30	29	SG0	SG0
28	27	X0.3-	X0.3+
26	25	X0.2-	X0.2+
24	23	X0.1-	X0.1+
22	21	X0.0-	X0.0+
20	19	C0	C0
18	17	Y0.11	Y0.10
16	15	Y0.9	Y0.8
14	13	Y0.7	Y0.6
12	11	Y0.5	Y0.4
10	9	SG1	SG1
8	7	Y0.3-	Y0.3+
6	5	Y0.2-	Y0.2+
4	3	Y0.1-	Y0.1+
2	1	Y0.0-	Y0.0+

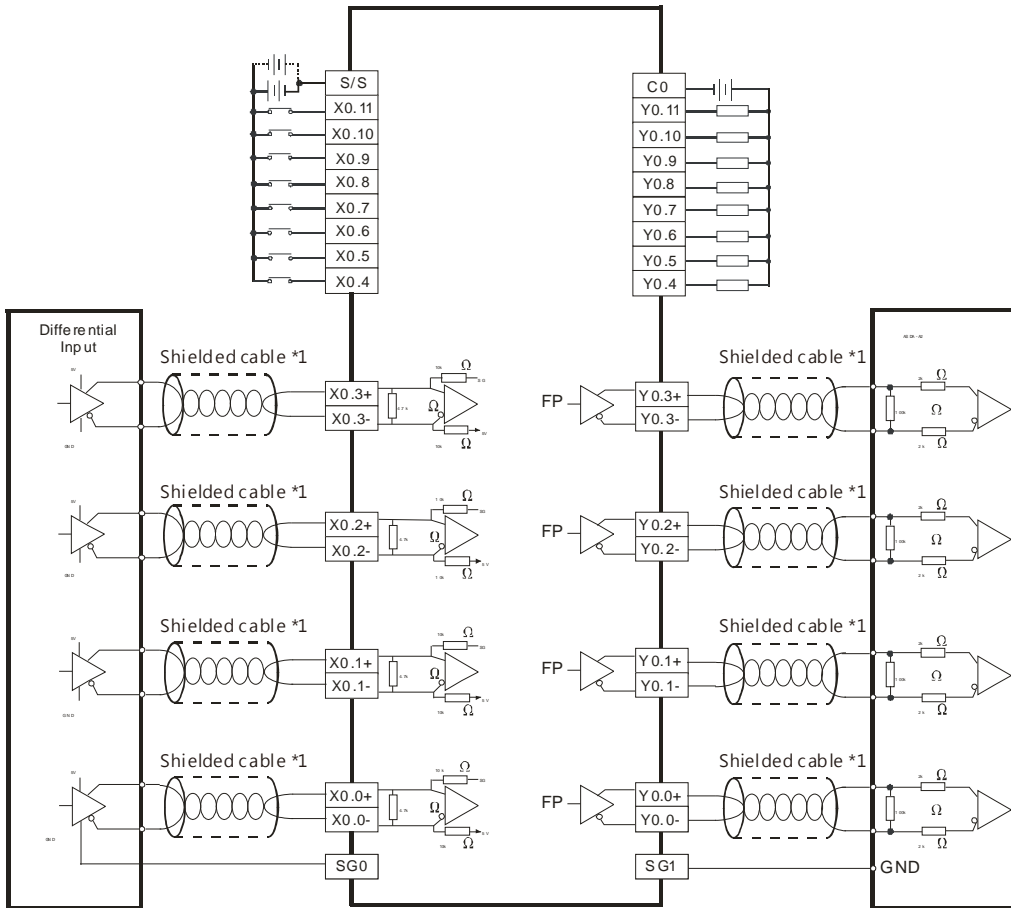

● Wiring the External Terminal Module UB-10-ID16A

Input form	X0.0+ to X0.3+/X0.0- to X0.3-: Differential input X0.4–X0.11: Direct current (sinking or sourcing)
Input current/voltage	X0.0+ to X0.3+/X0.0- to X0.3- : 5 VDC, 5 mA X0.4–X0.11: 24 VDC, 5 mA
Output form	Y0.0+ to Y0.3+/Y0.0- to Y0.3- : Differential input Y0.4–Y0.11: Transistor-T (sinking)
Output current/voltage	Y0.0+ to Y0.3+/Y0.0- Y0.3-: 5 VDC, 20 mA Y0.4–Y0.11: 5 to 30 VDC, 0.1 A

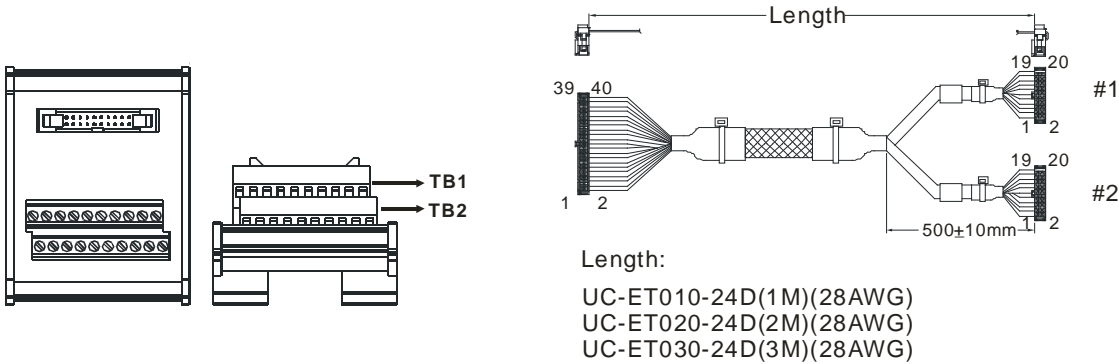

#1	TB1	Y0.0+	Y0.1+	Y0.2+	Y0.3+	SG1	Y0.4	Y0.6	Y0.8	Y0.10	C0
	TB2	Y0.0-	Y0.1-	Y0.2-	Y0.3-	SG1	Y0.5	Y0.7	Y0.9	Y0.11	C0
#2	TB1	X0.0+	X0.1+	X0.2+	X0.3+	SG0	X0.4	X0.6	X0.8	X0.10	S/S
	TB2	X0.0-	X0.1-	X0.2-	X0.3-	SG0	X0.5	X0.7	X0.9	X0.11	S/S

4.6.2 Wiring AS332P-A

Input form	Direct current (sinking or sourcing)
Input current/voltage	24 VDC, 5 mA
Output form	Transistor-P (sourcing)
Output current/voltage	5 to 30 VDC, 0.1A/output, 1.6A/COM

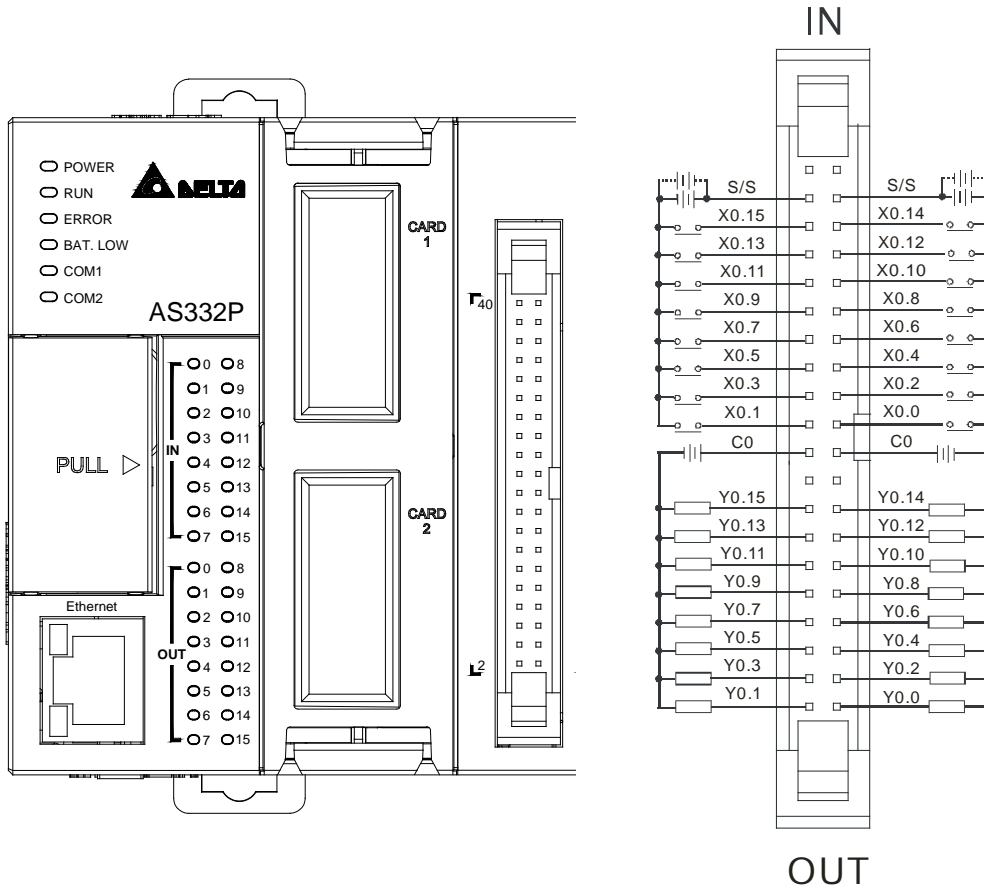

4

● Wiring the External Terminal Module UB-10-ID16A

Input form	Direct current (sinking or sourcing)
Input current/voltage	24 VDC. 5 mA
Output form	Transistor-P (sourcing)
Output current/voltage	5 to 30 VDC. 0.1A

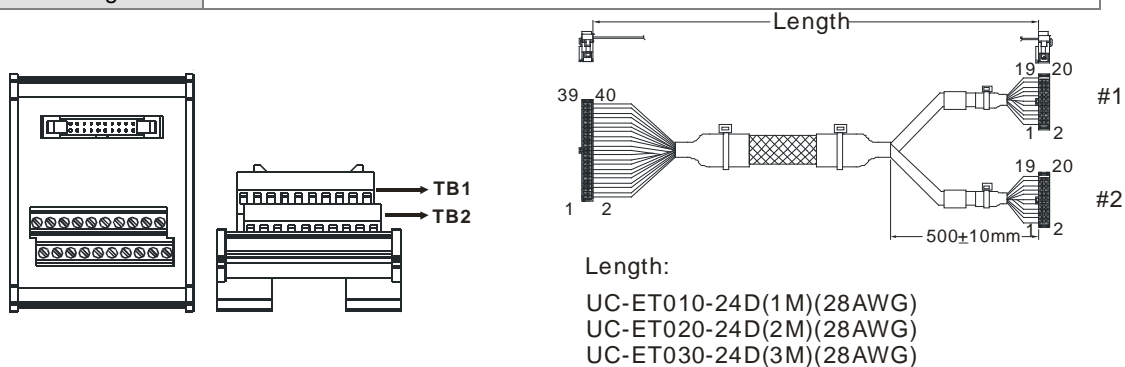

#1	TB1	Y0.0	Y0.2	Y0.4	Y0.6	Y0.8	Y0.10	Y0.12	Y0.14	-	C0
	TB2	Y0.1	Y0.3	Y0.5	Y0.7	Y0.9	Y0.11	Y0.13	Y0.15	-	C0
#2	TB1	X0.0	X0.2	X0.4	X0.6	X0.8	X0.10	X0.12	X0.14	S/S	-
	TB2	X0.1	X0.3	X0.5	X0.7	X0.9	X0.11	X0.13	X0.15	S/S	-

● Wiring the External Terminal Module UB-10-OR16B

For cables that can only be connected to the cables of group #1, see below.

Output form	Relay
Output voltage	Less than 250 VAC, 30 VDC

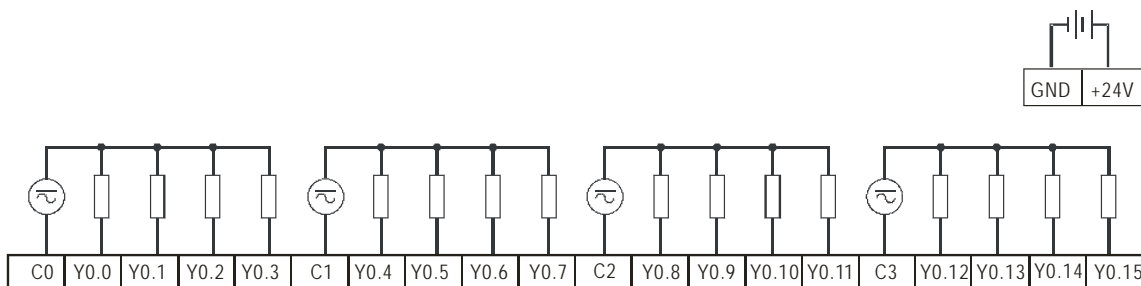
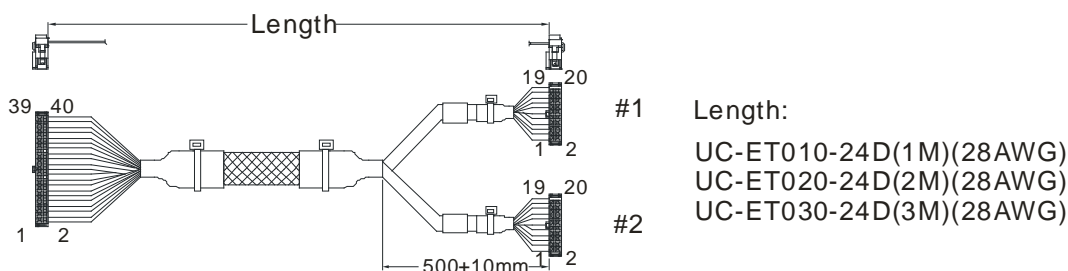

4.6.3 Wiring AS332T-A

Input form	Direct current (sinking or sourcing)
Input current/voltage	24 VDC, 5 mA
Output form	Transistor-T (sinking)
Output current/voltage	5 to 30 VDC, 0.1A/output, 1.6A/COM

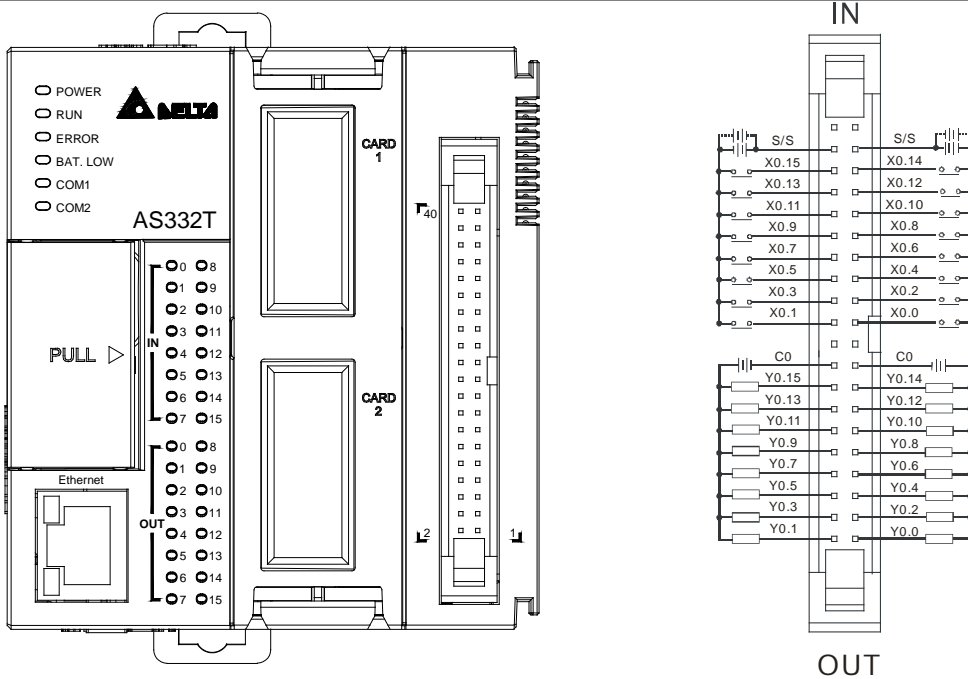

● Wiring the External Terminal Module UB-10-ID16A

Input form	Direct current (sinking or sourcing)
Input current/voltage	24 VDC, 5 mA
Output form	Transistor-T (sinking)
Output current/voltage	5 to 30 VDC, 0.1 A

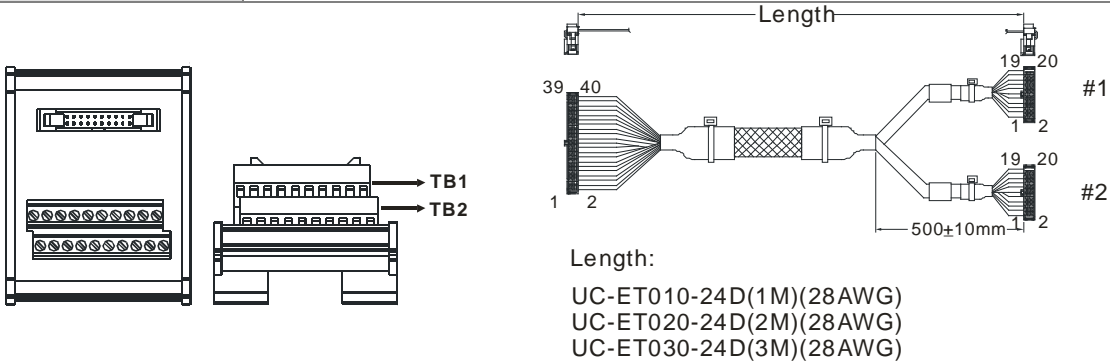

#1	TB1	Y0.0	Y0.2	Y0.4	Y0.6	Y0.8	Y0.10	Y0.12	Y0.14	C0	-
	TB2	Y0.1	Y0.3	Y0.5	Y0.7	Y0.9	Y0.11	Y0.13	Y0.15	C0	-
#2	TB1	X0.0	X0.2	X0.4	X0.6	X0.8	X0.10	X0.12	X0.14	S/S	-
	TB2	X0.1	X0.3	X0.5	X0.7	X0.9	X0.11	X0.13	X0.15	S/S	-

● Wiring the External Terminal Module UB-10-OR16A

For cables that can only be connected to the cables of group #1, see below.

Output form	Relay
Output voltage	Less than 250 VAC, 30 VDC

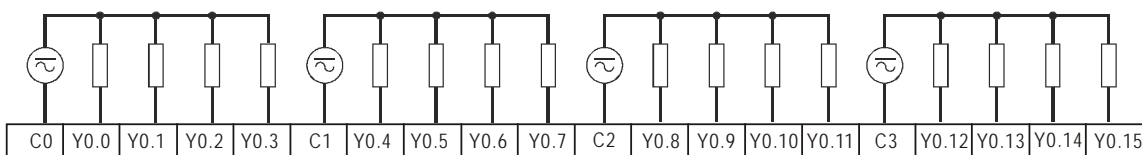
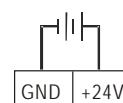
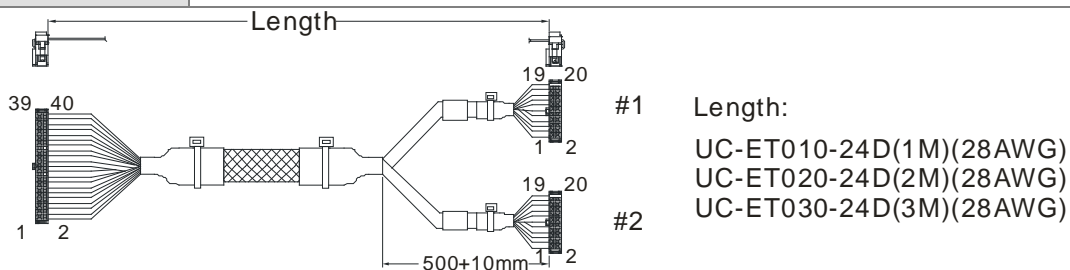

Note: UB-10-OR16A can be used with AS Series and DVP Series. The indications on the UB-10-OR16A board is for DVP Series. For the definitions of terminal connections for AS Series, you can see the reference table below. Or refer to the enclosed sticker for AS Series.

AS	C0	Y0.0	Y0.1	Y0.2	Y0.3	C1	Y0.4	Y0.5	Y0.6	Y0.7	C2	Y0.8	Y0.9	Y0.10	Y0.11	C3	Y0.12	Y0.13	Y0.14	Y0.15
DVP	C0	Y0	Y1	Y2	Y3	C1	Y4	Y5	Y6	Y7	C2	Y10	Y11	Y12	Y13	C3	Y14	Y15	Y16	Y17

4.6.4 Wiring AS320P-B

Input form	Direct current (sinking or sourcing)
Input current/voltage	24 VDC, 5 mA
Output form	Transistor-P (sourcing)
Output current/voltage	5 to 30 VDC, 0.1A/output, 1.2A/COM

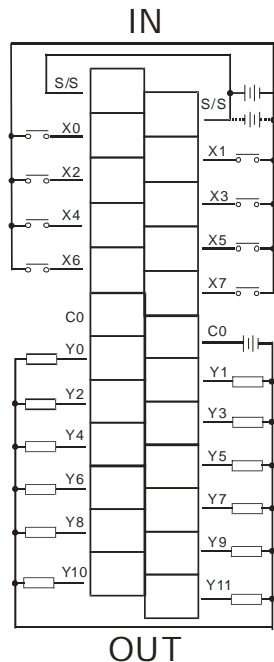
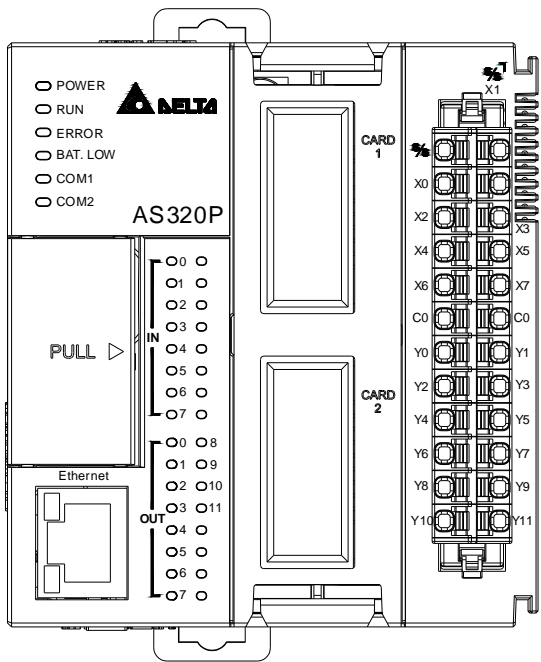

4

4.6.5 Wiring AS320T-B

Input form	Direct current (sinking or sourcing)
Input current/voltage	24 VDC, 5 mA
Output form	Transistor-T (sinking)
Output current/voltage	5 to 30 VDC, 0.1A/output, 1.2A/COM

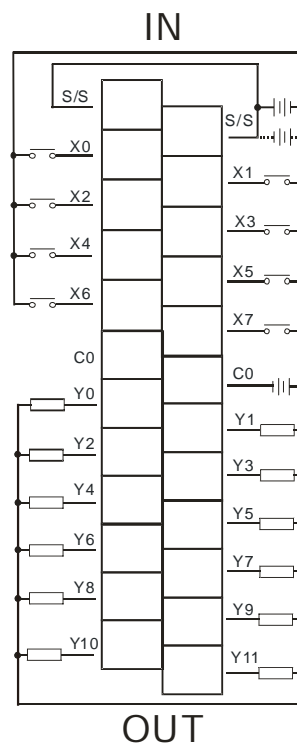
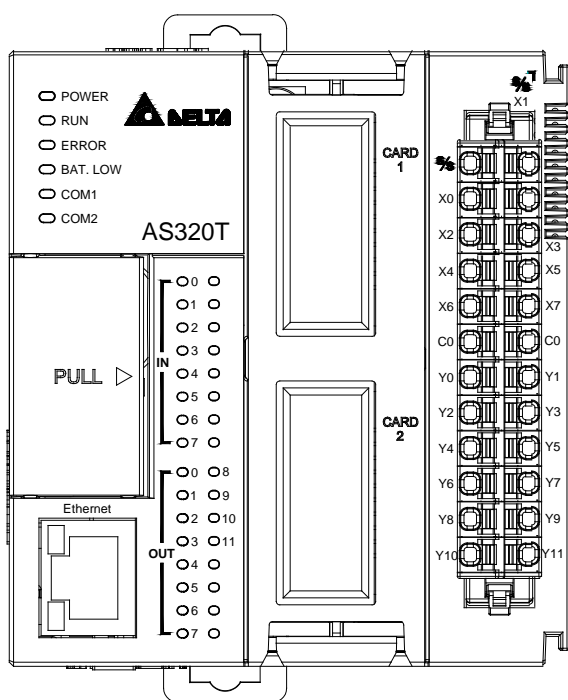

4.6.6 Wiring AS228P-A

Input form	Direct current (sinking or sourcing)
Input current/voltage	24 VDC, 5 mA
Output form	Transistor-P (sourcing) (PNP)
Output current/voltage	5 to 30 VDC, 0.5A/output, 2A/COM

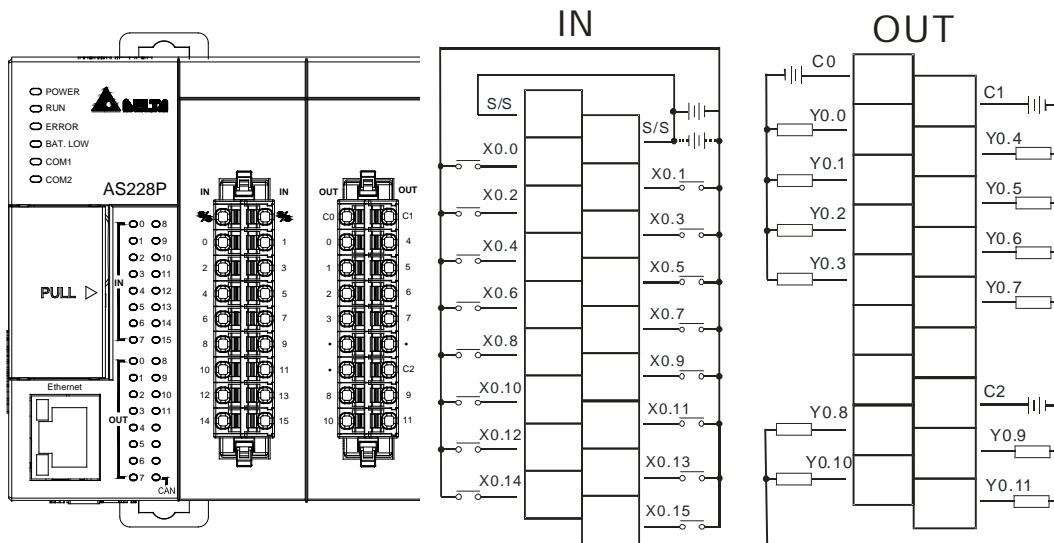

4.6.7 Wiring AS228R-A

Input form	Direct current (sinking or sourcing)
Input current/voltage	24 VDC, 5 mA
Output form	Relay
Output current/voltage	240VAC/24VDC, 2A/output, 8A/COM

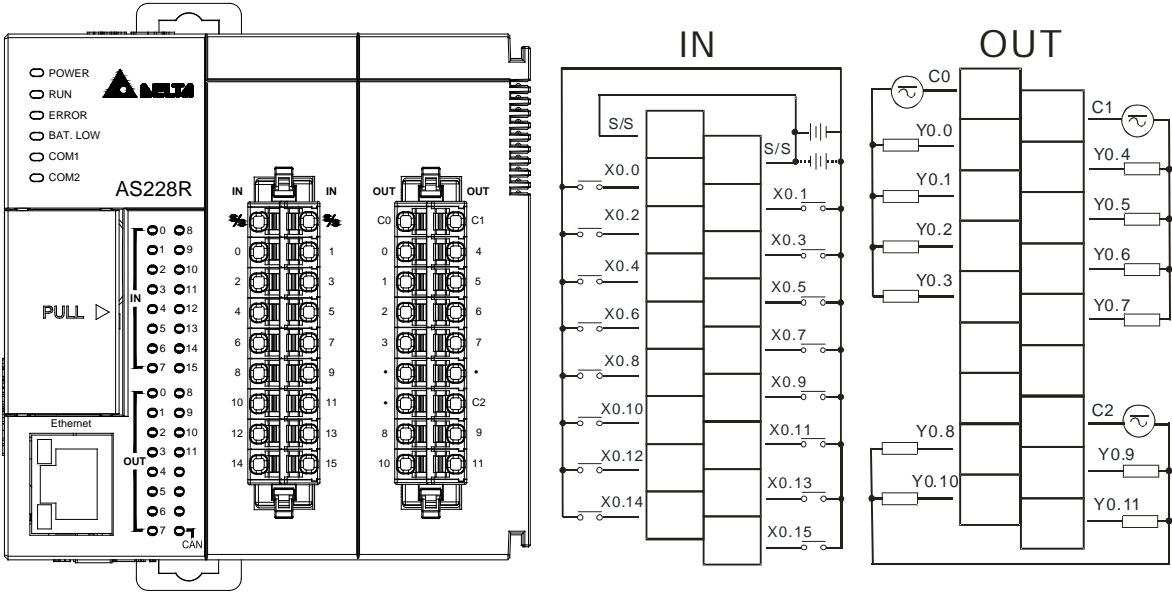

4.6.8 Wiring AS228T-A

Input form	Direct current (sinking or sourcing)
Input current/voltage	24 VDC, 5 mA
Output form	Transistor-T (sinking) (NPN)
Output current/voltage	5 to 30 VDC, 0.5A/output, 2A/COM

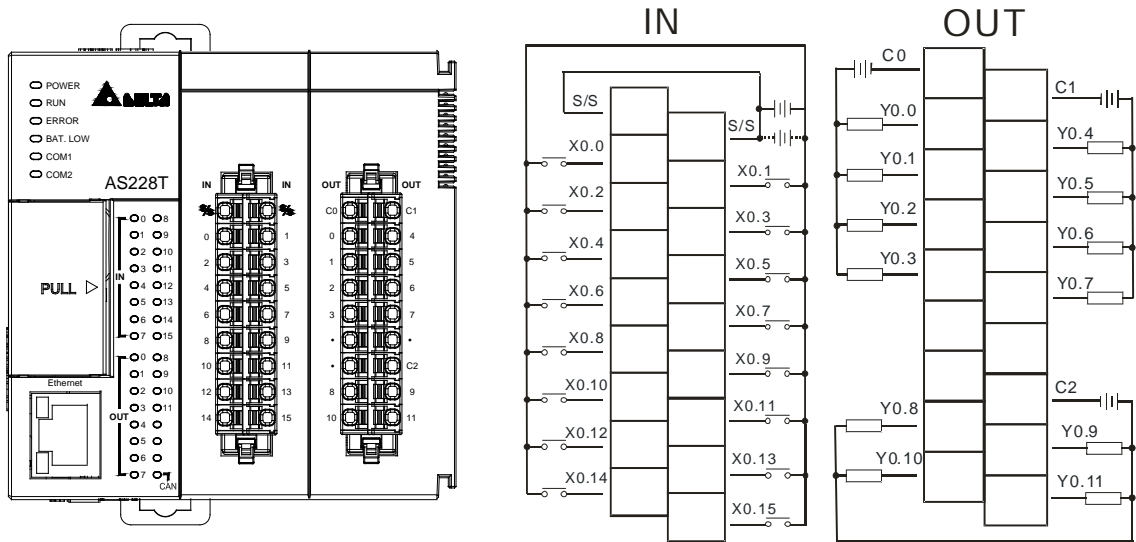

4

4.6.9 Wiring AS218PX-A / AS218RX-A / AS218TX-A

4.6.9.1 Wiring AS218PX-A

Input form	Direct current (sinking or sourcing)
Input current/voltage	24 VDC, 5 mA
Output form	Transistor-P (sourcing) (PNP)
Output current/voltage	5 to 30 VDC, 0.5A/output, 1.5A/COM
Analog input*1	12bits, -10V-10V (voltage), -20mA-20mA (current)
Analog output*1	12bits, -10V-10V(voltage), 0- 20mA (current)

*1. Refer to section 4.6.9.4 for more details on wiring analog input and output.

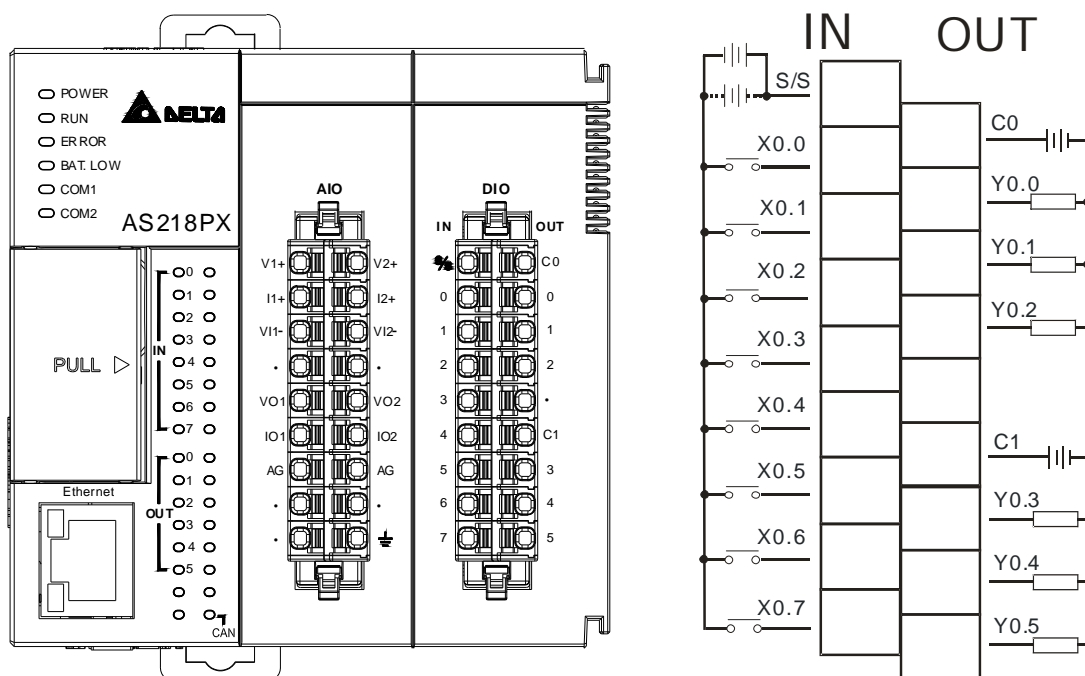

4.6.9.2 Wiring AS218RX-A

Input form	Direct current (sinking or sourcing)
Input current/voltage	24 VDC, 5 mA
Output form	Relay
Output current/voltage	240 VAC / 24 VDC, 2A/output, 6A/COM
Analog input*1	12 bits, -10V-10V (voltage), -20mA-20mA (current)
Analog output*1	12 bits, -10V-10V(voltage), 0- 20mA (current)

*1. Refer to section 4.6.9.4 for more details on wiring analog input and output.

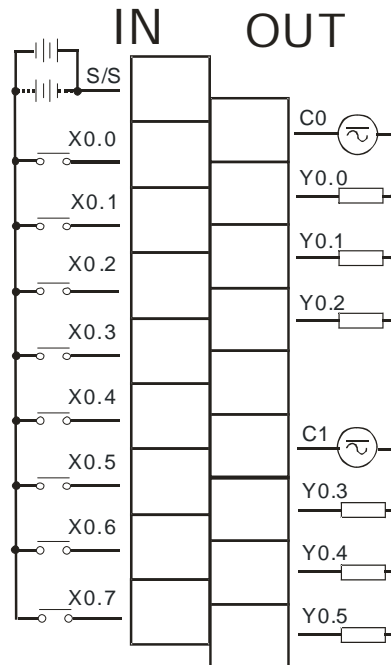
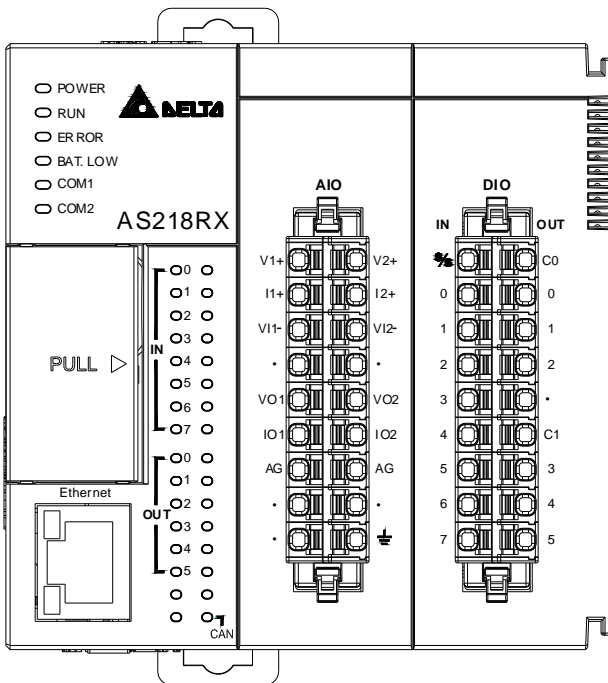

4.6.9.3 Wiring AS218TX-A

Input form	Direct current (sinking or sourcing)
Input current/voltage	24 VDC, 5 mA
Output form	Transistor-T (sinking) (NPN)
Output current/voltage	5 to 30 VDC, 0.5A/output, 1.5A/COM
Analog input*1	12 bits, -10V-10V (voltage), -20mA-20mA (current)
Analog output*1	12 bits, -10V-10V(voltage), 0- 20mA (current)

*1. Refer to section 4.6.9.4 for more details on wiring analog input and output.

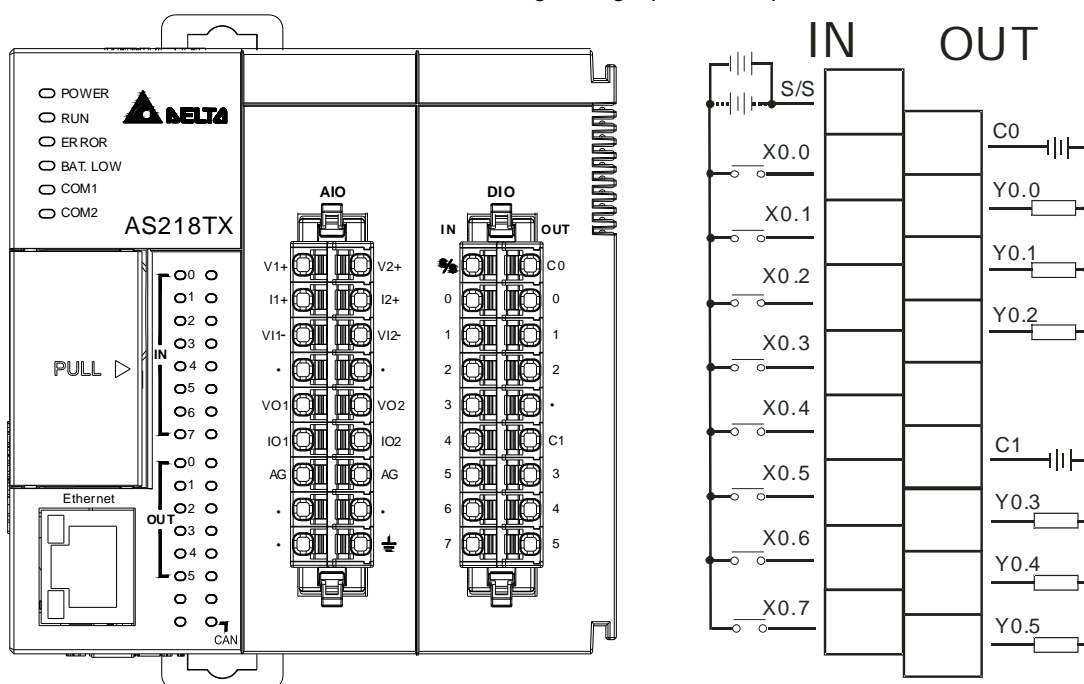

4.6.9.4 Wiring Details on AS218PX-A/AS218RX-A/AS218TX-A

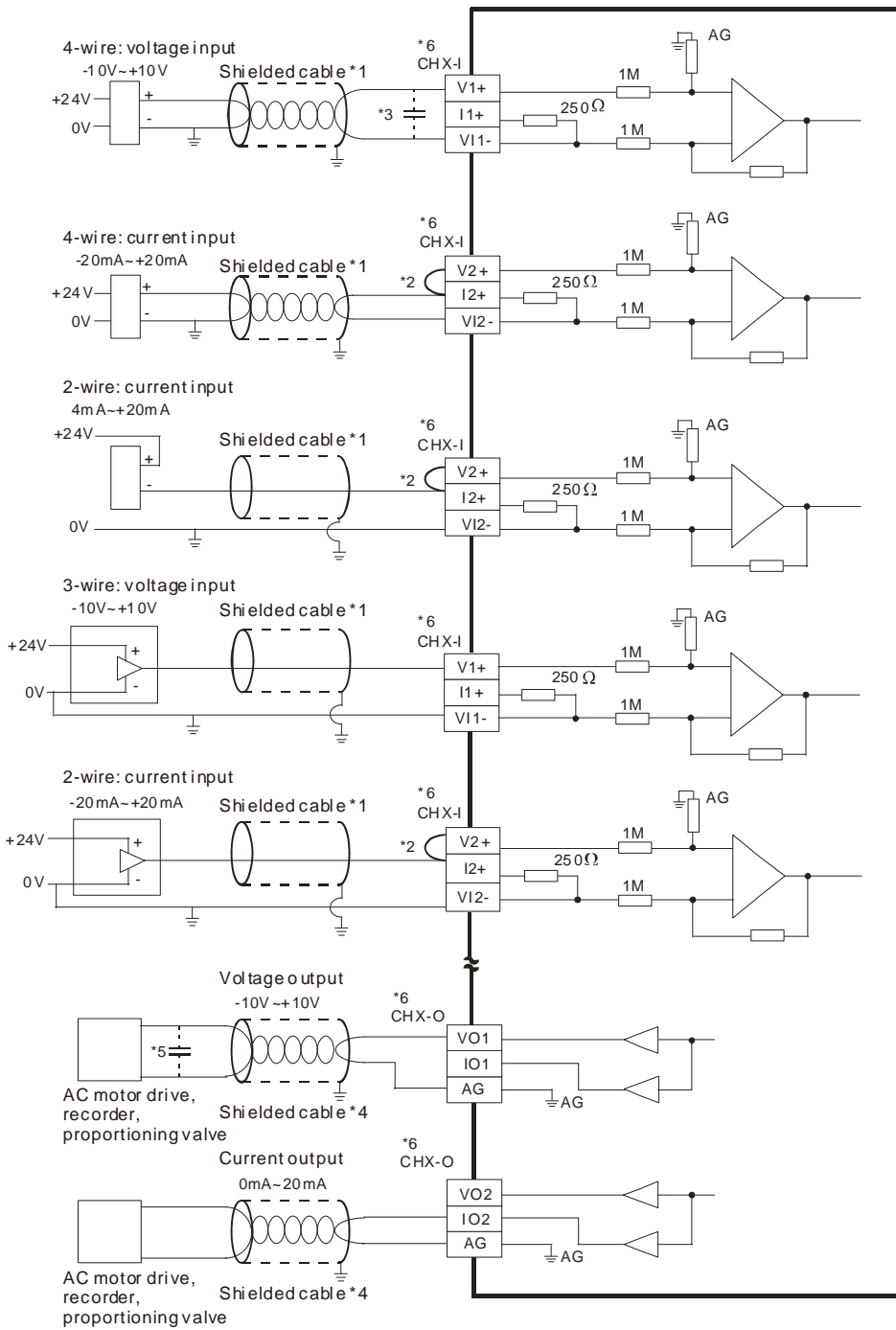

4

4.6.10 Wiring AS132T-A/AS148T-A/AS164T-A

Input form	Direct current (sinking or sourcing)
Input current/voltage	24 VDC, 5 mA
Output form	Transistor-T (sinking) (NPN)
Output current/voltage	5 to 30 VDC, 0.5A/output, 2A/COM

The following illustrations uses AS148T-A as an example. The wiring method is similar to AS132T-A and AS164T-A.

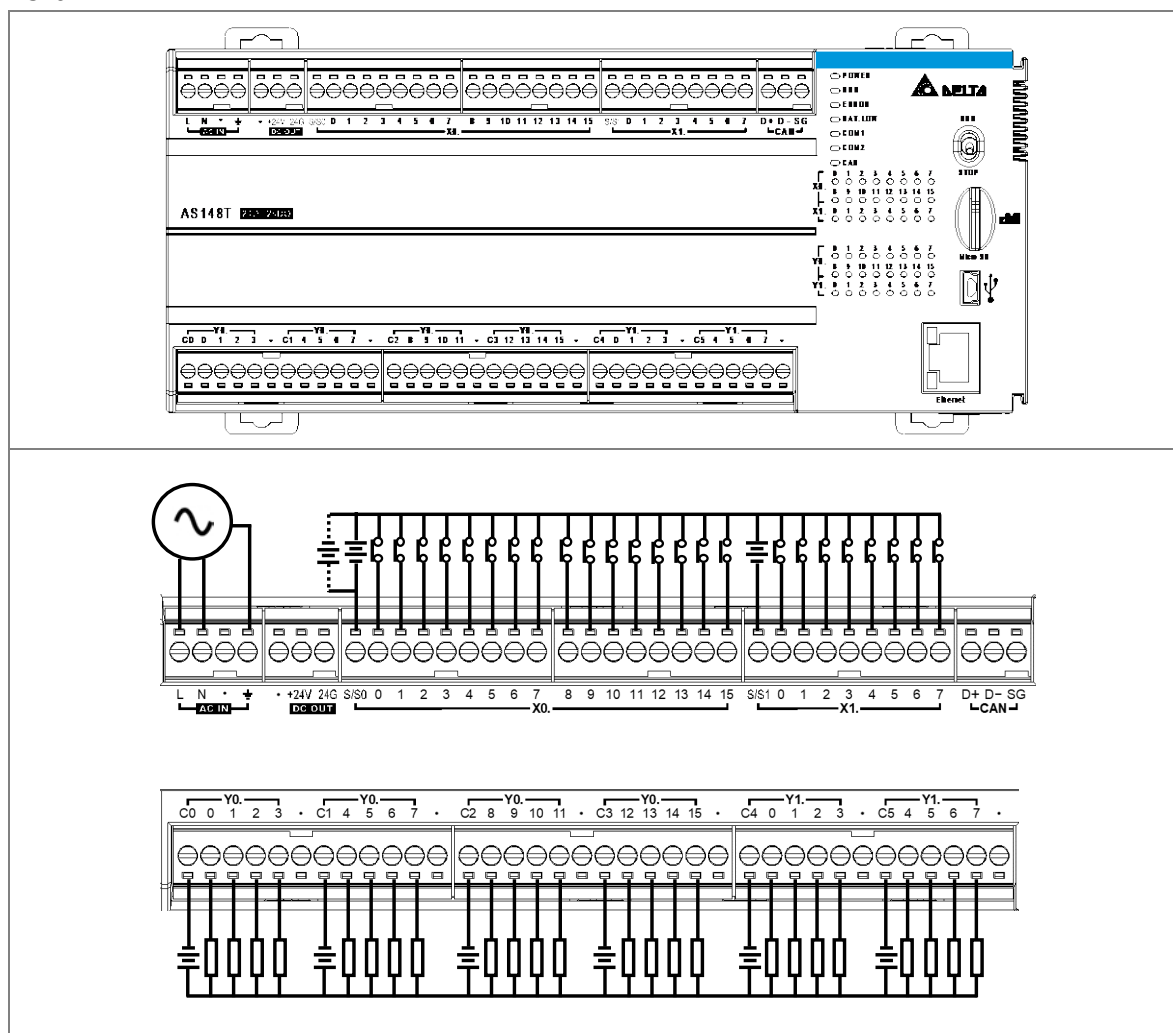

4.6.11 Wiring AS132P-A/AS148P-A/AS164P-A

Input form	Direct current (sinking or sourcing)
Input current/voltage	24 VDC, 5 mA
Output form	Transistor-P (sourcing) (PNP)
Output current/voltage	5 to 30 VDC, 0.5A/output, 2A/COM

The following illustrations uses AS148P-A as an example. The wiring method is similar to AS132P-A and AS164P-A.

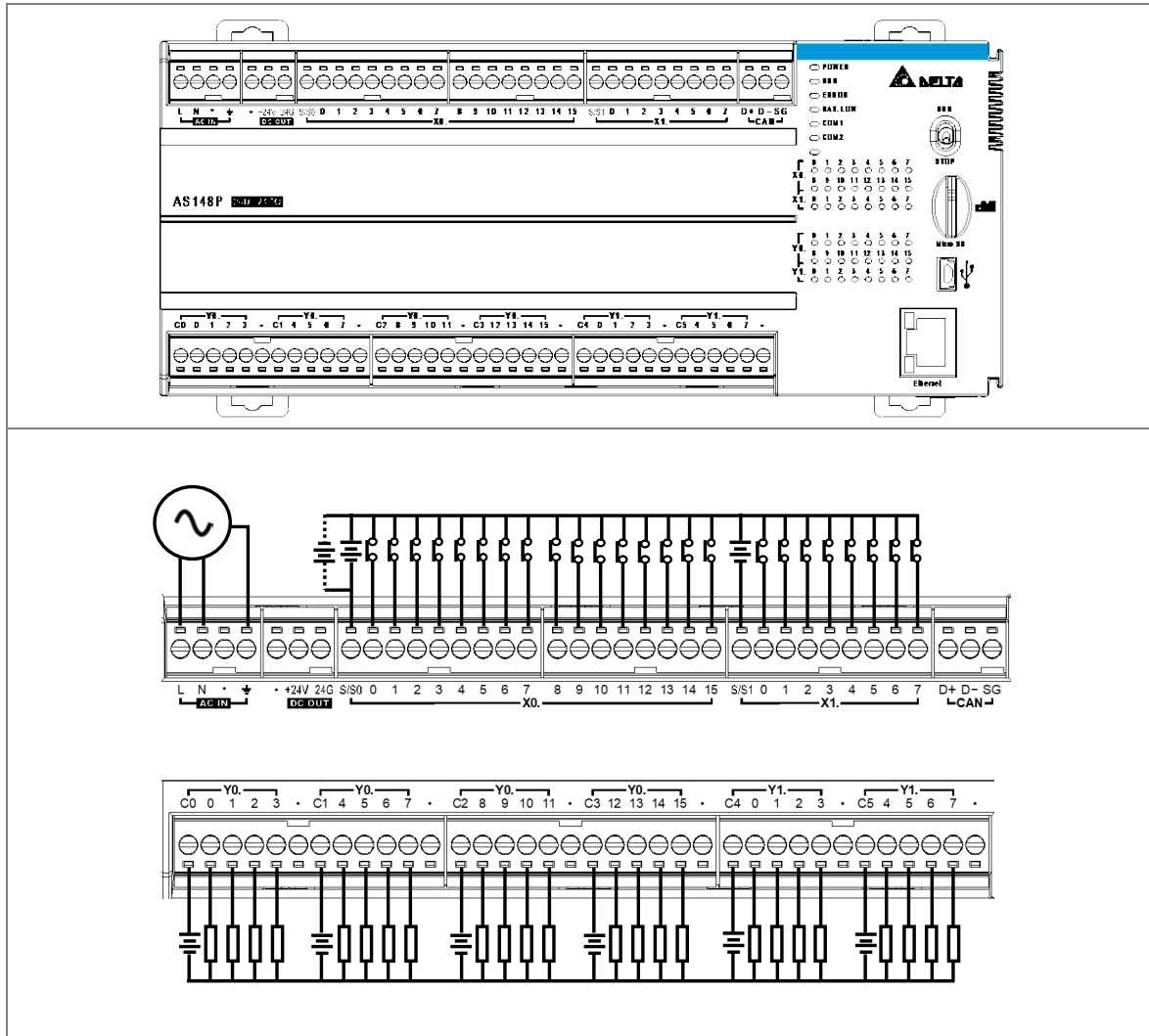

4.6.12 Wiring AS132R-A/AS148R-A/AS164R-A

Input form	Direct current (sinking or sourcing)
Input current/voltage	24 VDC, 5 mA
Output form	Relay
Output current/voltage	240VAC/24VDC, 2A/output, 5A/COM

The following illustrations uses AS148R-A as an example. The wiring method is similar to AS132R-A and AS164R-A.

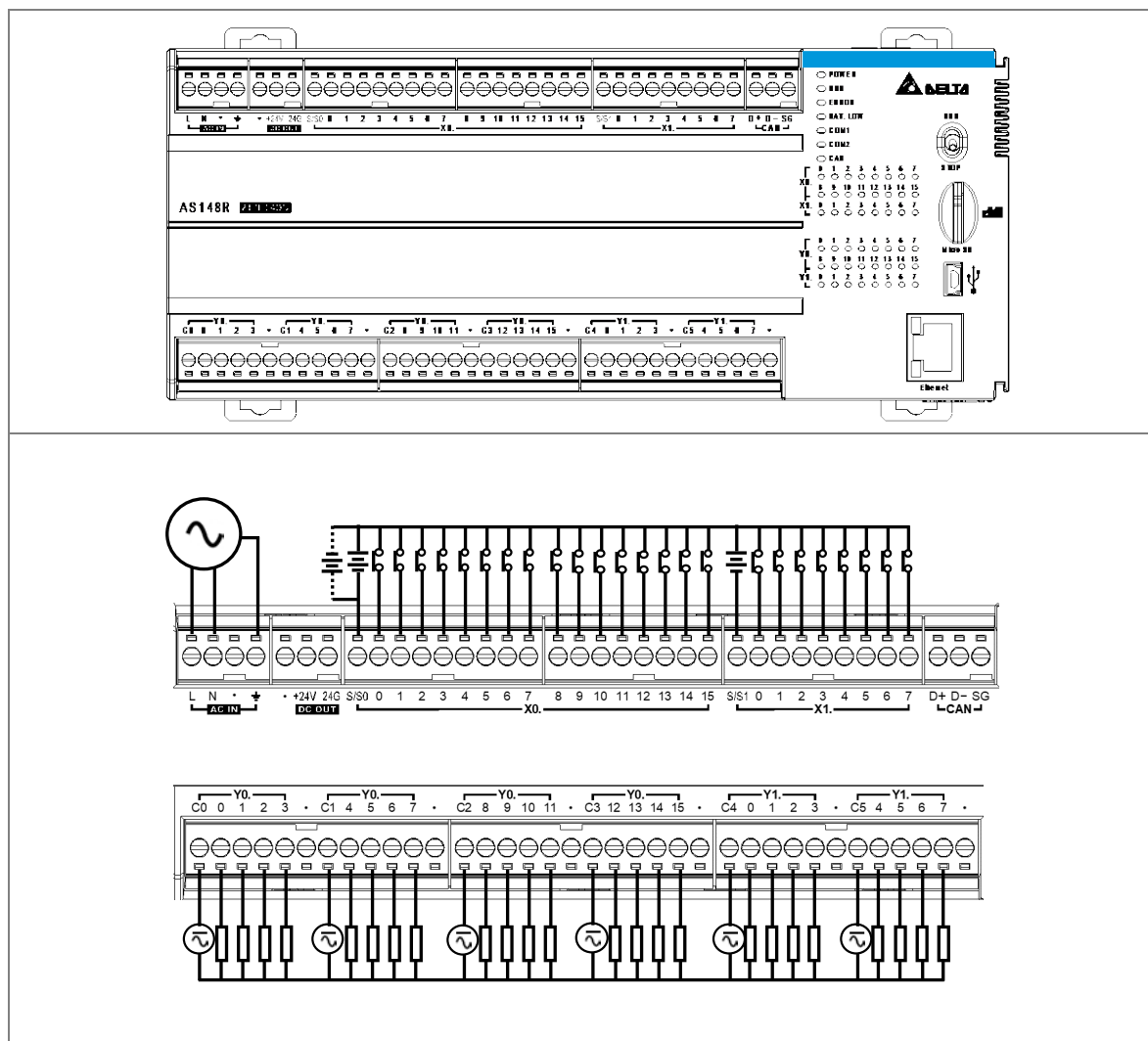

4.6.13 Wiring AS Series PLC CPU Communication Ports

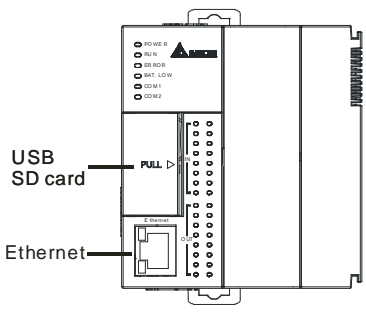
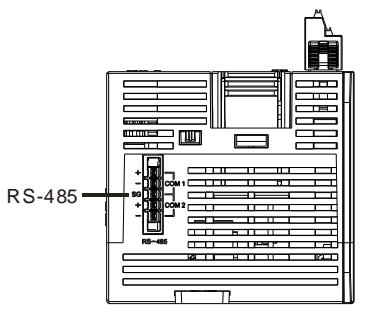
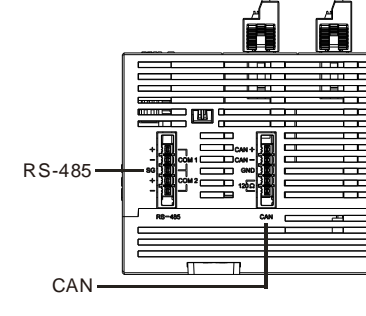
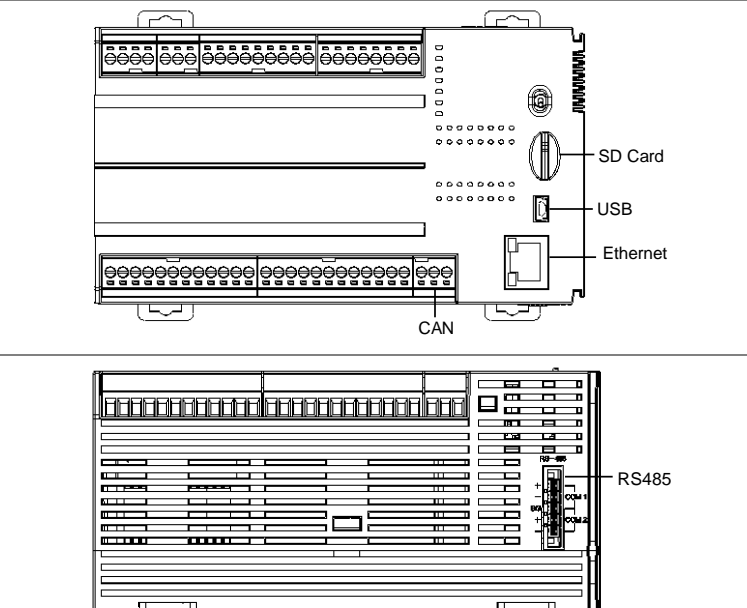
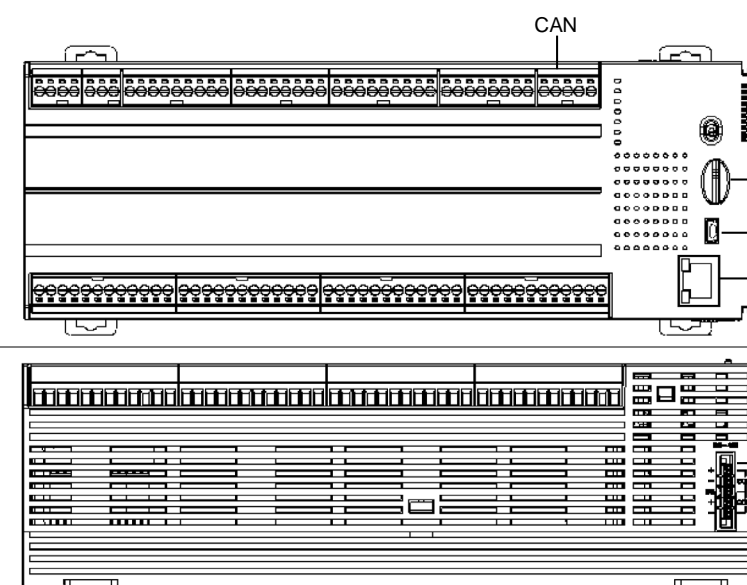
AS300/AS200 Series	AS300 Series	AS200 Series
 <p>USB SD card Ethernet</p>	 <p>RS-485</p>	 <p>RS-485 CAN</p>
AS100 Series		
<p>AS132T/P/R-A</p>	 <p>CAN SD Card USB Ethernet</p>	
<p>AS148T/P/R-A AS164T/P/R-A</p>	 <p>CAN RS485</p>	

4

- **USB port**

Pin	Function
1	VBUS (4.4–5.25 V)
2	D-
3	D+
4	Ground
5	Ground



Mini-B

- Refer to Appendix A : Installing a USB Driver, if it is the first time for AS Series to use USB port to communicate.
- Time to use USB port: uploading/downloading PLC programs, monitoring during calibration and upgrading firmware.
- NOT suggested to use USB port: applications that require a long and un-interruptible communication.
- What to do when a communication failure occurs: unplug any communication connector from the USB port and then plug the connector back. After that reconnect and try communication again.

4

- **Ethernet port**

Pin	Signal	Description
1	TX+	Transmitting data (positive pole)
2	TX-	Transmitting data (negative pole)
3	RX+	Receiving data (positive pole)
4	--	N/C
5	--	N/C
6	RX-	Receiving data (negative pole)
7	--	N/C
8	--	N/C

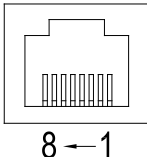

8 ← 1

● **RS485**

Pin	Signal	Description
1	+	COM1 D+
2	-	COM1 D-
3	SG	Signal Ground
4	+	COM2 D+
5	-	COM2 D-

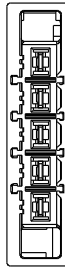

■ **RS485 Wiring**

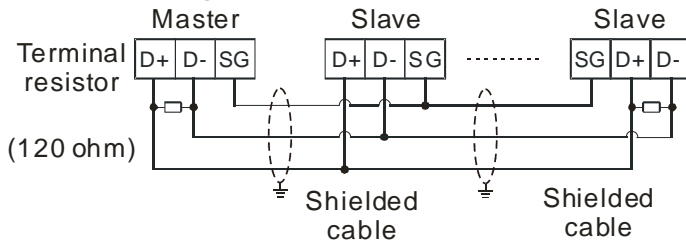

● **CAN Pins and Wiring**

■ **CAN Pins for AS200 / AS300 Series PLC CPU**

Pin	Signal	Description
1	CAN+	CAN_H
2	CAN-	CAN_L
3	GND	GROUND
4	120Ω	Terminal resistor
5		

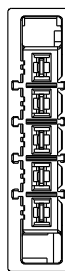

Note: Pin4 and Pin5 must be short-circuited to activate the built-in terminal resistor 120Ω and work as an impedance to reduce noise inference when signal reflections occur and ensure signal can be transmitted normally.

■ **CAN Wiring for AS200 / AS300 Series PLC CPU**

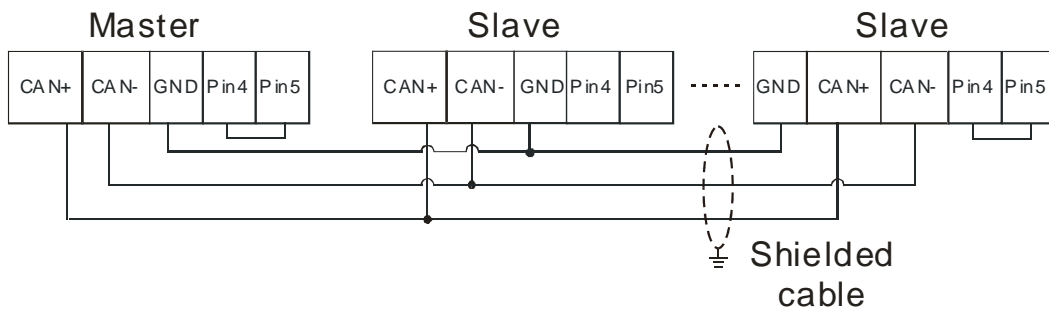

1. It is recommended to use Daisy Chain for connection and be sure to use terminal resistor in the beginning and the end of the terminal arrangement.
2. Pin4 and Pin5 must be short-circuited to activate the built-in terminal resistor 120Ω.

■ CAN Pins for AS100

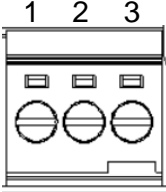
AS132T/P/R-A				
AS148T/P/R-A				
Terminal				
	PIN	1	2	3
Signal	D+	D-	SG	
Description	CAN_H	CAN_L	GROUND	

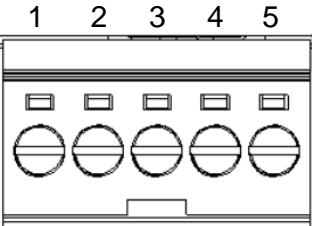
AS164T/P/R-A					
Terminal					
	PIN	1	2	3	4
Signal	-	D+	D-	SG	-
Description	-	CAN_H	CAN_L	GROUND	-

4

■ CAN Wiring for AS100

1. It is recommended to use Daisy Chain for CANopen network connection and be sure to use 120Ω terminal resistor in the beginning and the end of the terminal arrangement.
2. SG is the grounding signal for CANopen network.

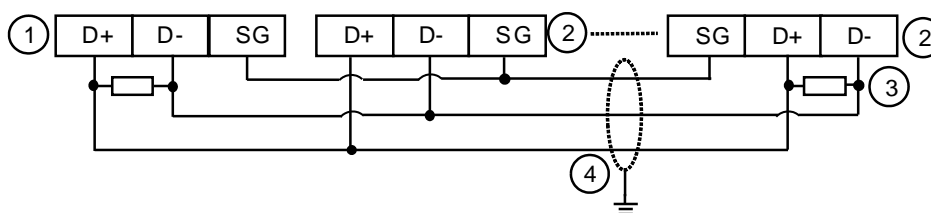

①	Master	②	Slave	③	Terminal resistor	④	Shielded cable
---	--------	---	-------	---	-------------------	---	----------------

4.7 Wiring Digital Input/Output Modules

This section illustrates how to wire digital input/output modules. The wiring diagrams below also illustrate how the power supplies are connected to S/S, and COM. If you need more information about wiring of digital input/output terminals, refer to Section 4.8 in this manual.

4.7.1 Wiring AS08AM10N-A

Input form	Direct current (sinking or sourcing)
Voltage specifications	24 VDC, 5 mA

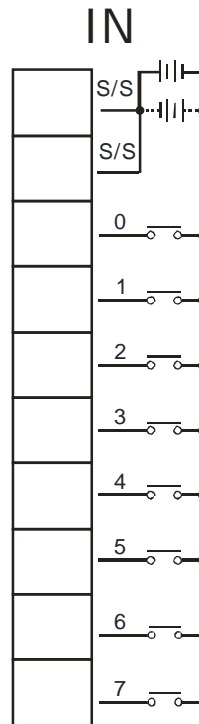
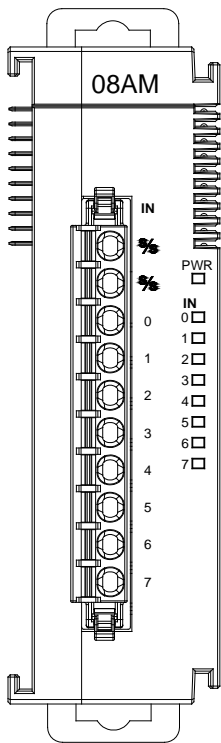

4.7.2 Wiring AS08AN01P-A

Output form	Transistor-P (sourcing)
Voltage specifications	5 to 30 VDC, 0.5A/output, 4A/COM

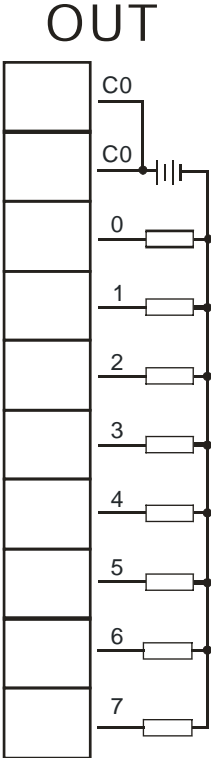
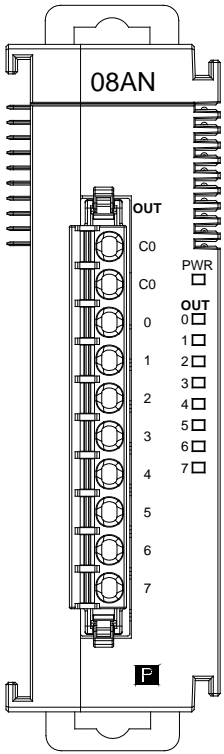

4.7.3 Wiring AS08AN01R-A

Output form	Relay
Voltage specifications	5 to 30 VDC, 2A/output, 8A/COM

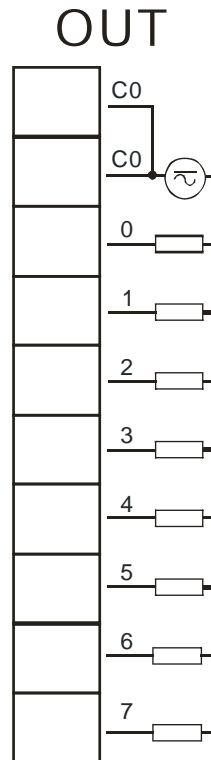
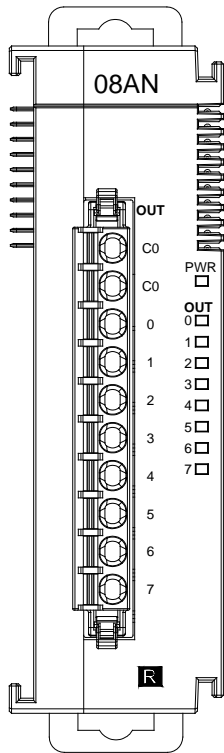

4

4.7.4 Wiring AS08AN01T-A

Output type	Transistor-T (sinking)
Voltage specifications	5 to 30 VDC, 0.5A/output, 4A/COM

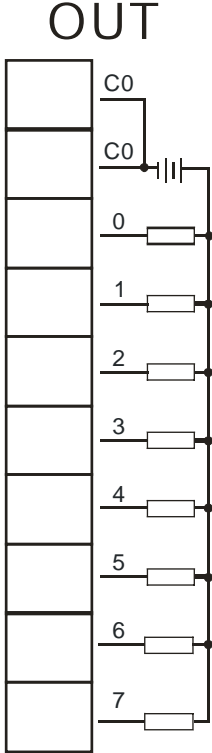
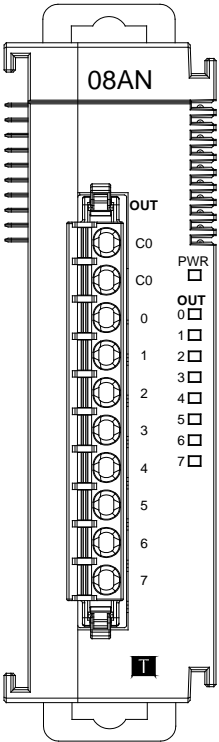

4.7.5 Wiring AS16AM10N-A

Input type	Direct current (sinking or sourcing)
Voltage specifications	24 VDC, 5 mA

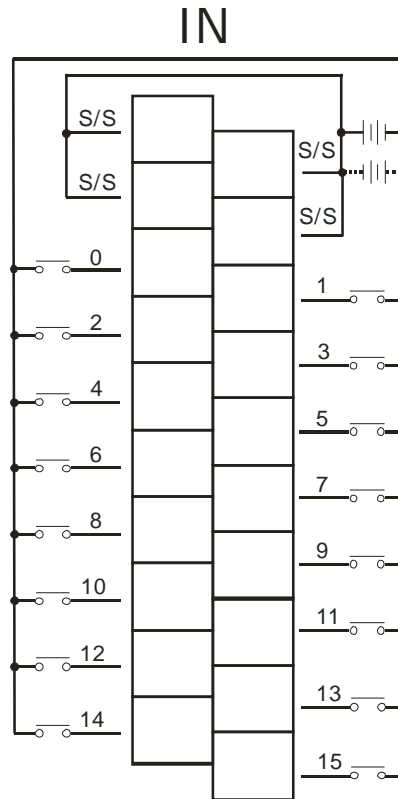
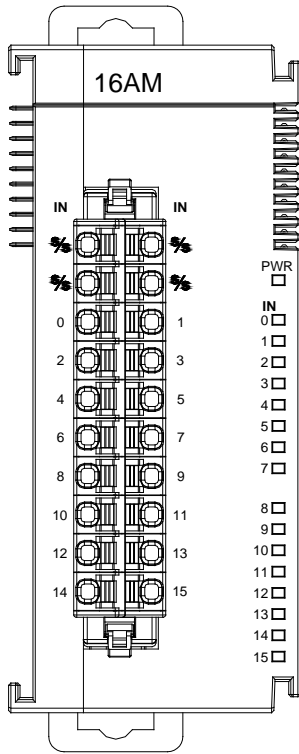

4

4.7.6 Wiring AS16AN01R-A

Output type	Relay
Voltage specifications	240 VAC/24 VDC, 2A/output, 8A/COM

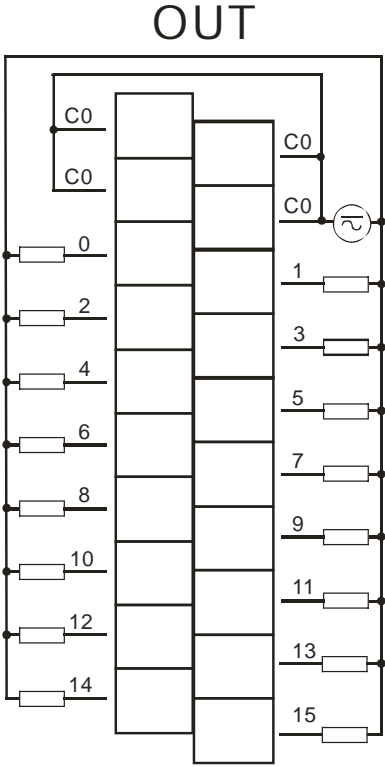
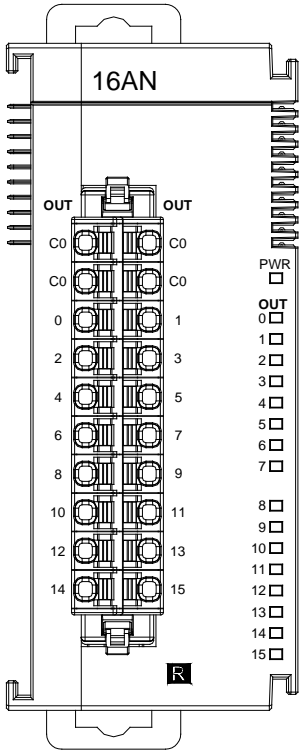

4.7.7 Wiring AS16AN01T-A

Output type	Transistor-T (sinking)
Voltage specifications	5 to 30 VDC, 0.5A/output, 4A/COM

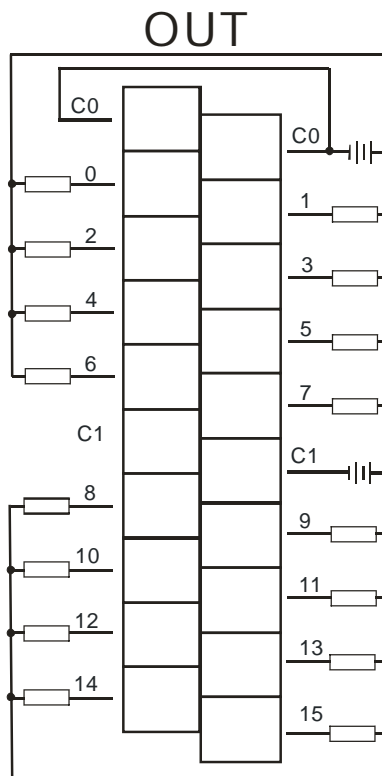
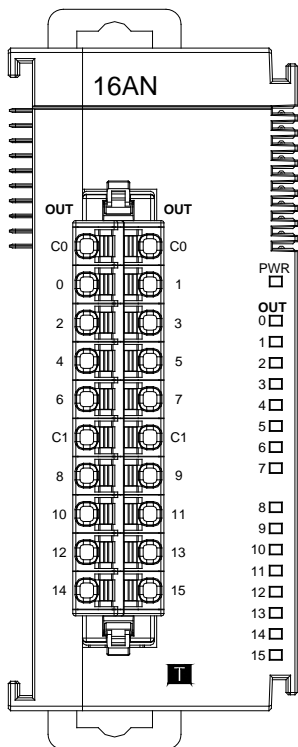

4

4.7.8 Wiring AS16AN01P-A

Output type	Transistor-P (sourcing)
Voltage specifications	5 to 30 VDC, 0.5A/output, 4A/COM

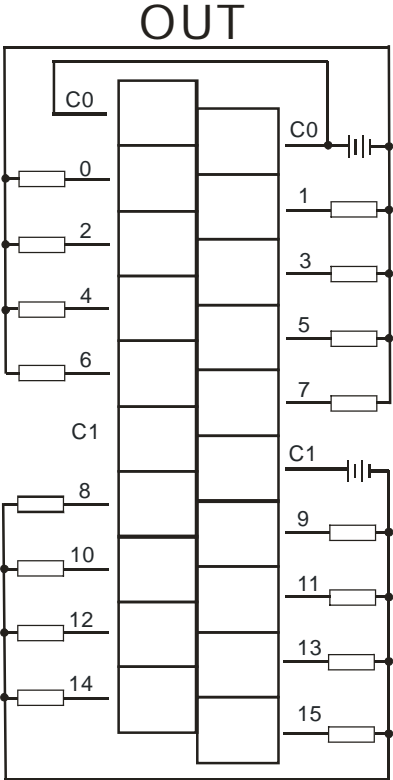
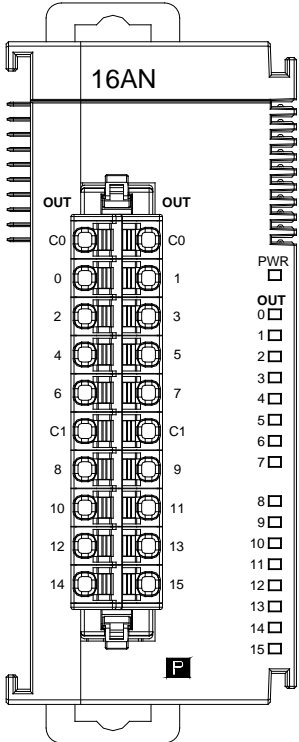

4.7.9 Wiring AS16AP11R-A

Input form	Direct current (sinking or sourcing)
Voltage specifications	24 VDC, 5 mA
Output type	Relay
Voltage specifications	240 VAC/24 VDC, 2 A/inputs, 8 A/COM

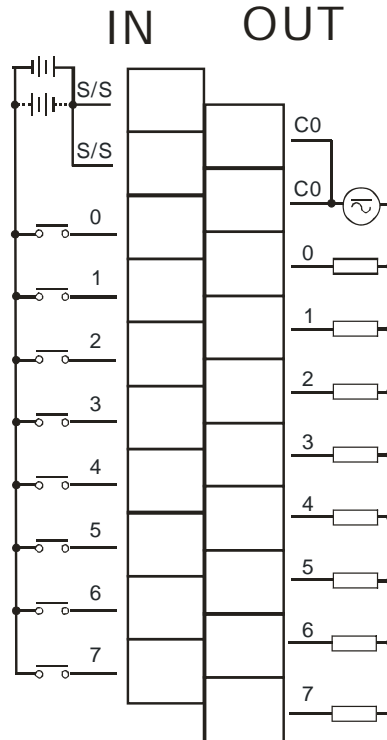
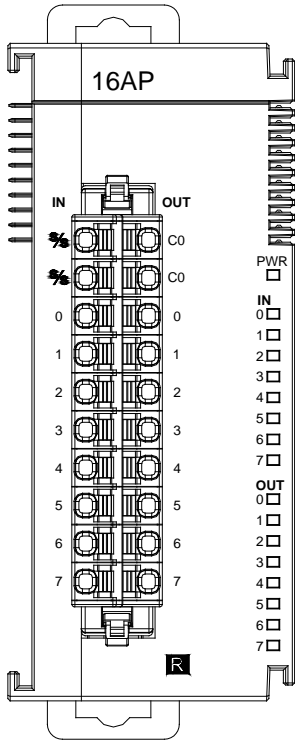

4

4.7.10 Wiring AS16AP11T-A

Input form	Direct current (sinking or sourcing)
Voltage specifications	24 VDC, 5 mA
Output type	Transistor-T (sinking)
Voltage specifications	5 to 30 VDC, 0.5A/output, 4A/COM

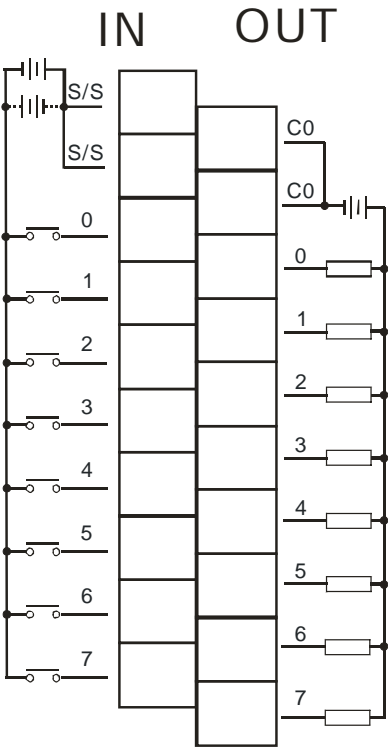
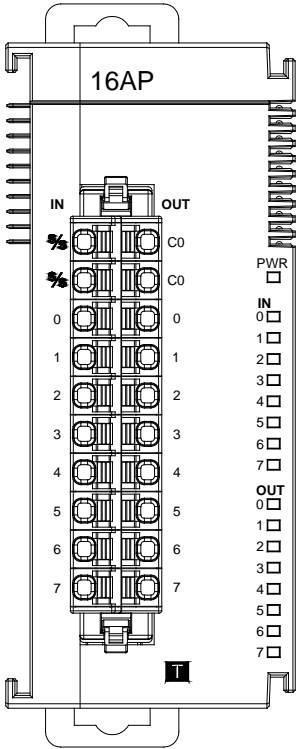

4.7.11 Wiring AS16AP11P-A

Input form	Direct current (sinking or sourcing)
Voltage specifications	24 VDC, 5 mA
Output type	Transistor-P (sourcing)
Voltage specifications	5 to 30 VDC, 0.5A/output, 4A/COM

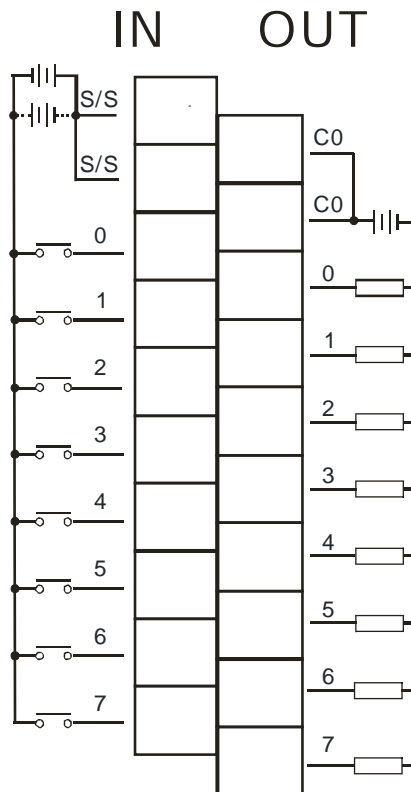
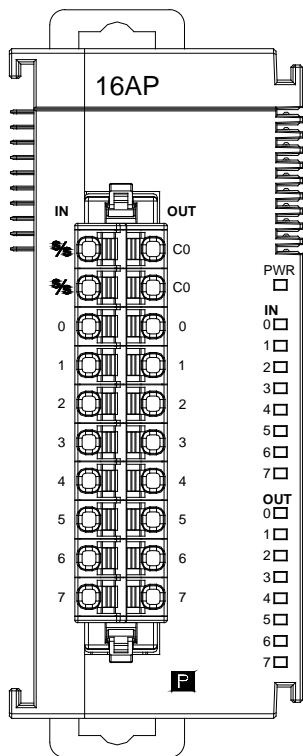

4

4.7.12 Wiring AS32AM10N-A

Input form	Direct current (sinking or sourcing)
Input current	24 VDC, 5 mA

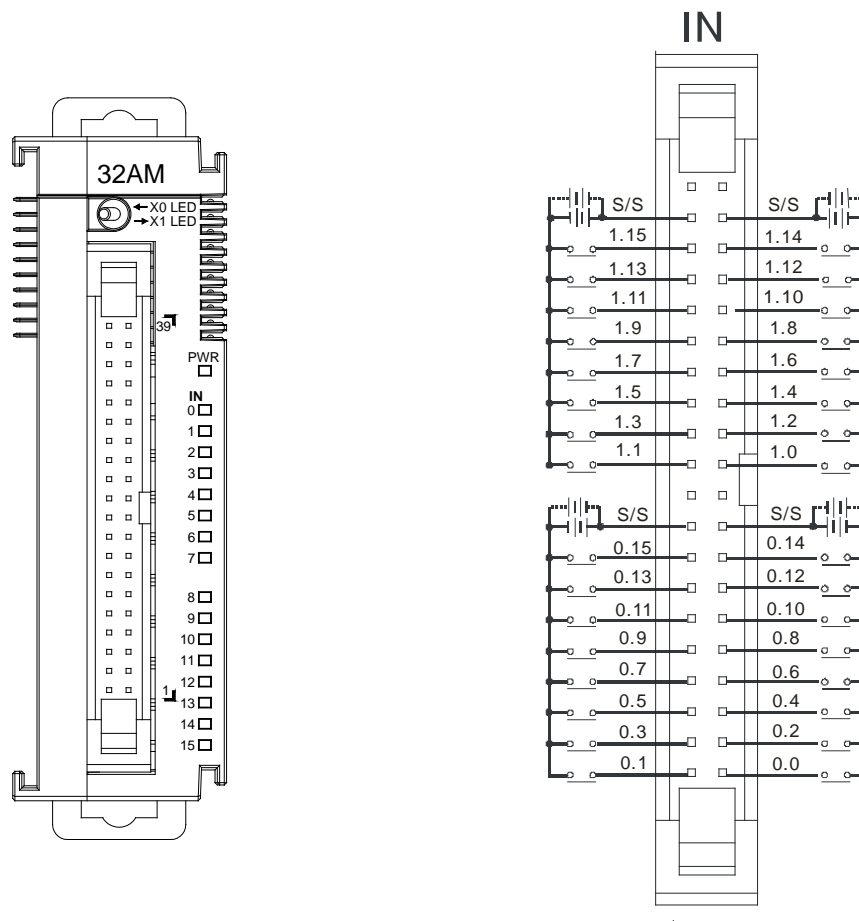

- Wiring the External Terminal Module UB-10-ID16A

For cables that can only be connected to the cables of group #2, see below.

Input form	Direct current (sinking or sourcing)
Voltage specifications	24 VDC, 5 mA

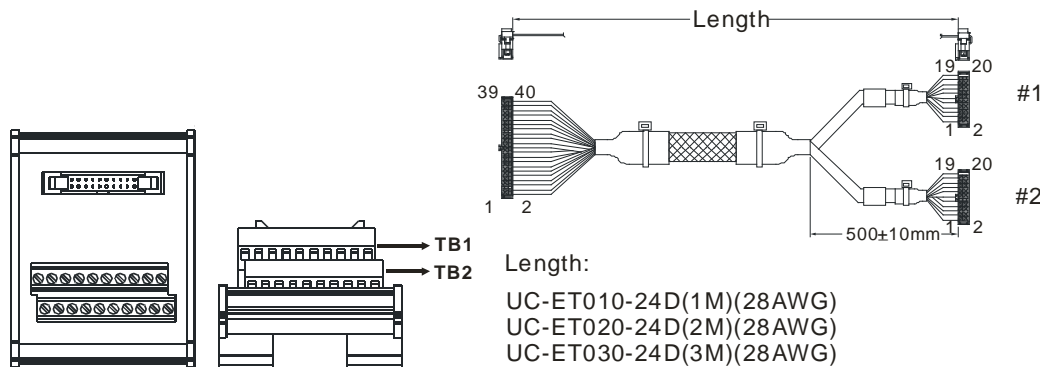

#2	TB1	X0.0	X0.2	X0.4	X0.6	X0.8	X0.10	X0.12	X0.14	S/S	-
	TB2	X0.1	X0.3	X0.5	X0.7	X0.9	X0.11	X0.13	X0.15	S/S	-

● Wiring the External Terminal Module UB-10-ID32A

Input form	Direct current (sinking or sourcing)
Input current/voltage	24 VDC, 5 mA

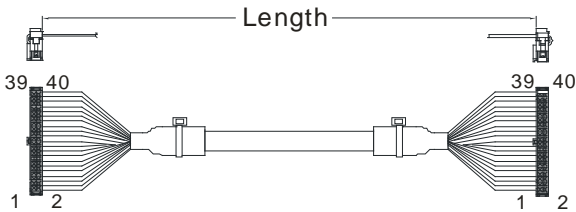

Length:
 UC-ET010-24B(1M)
 UC-ET020-24B(2M)
 UC-ET030-24B(3M)

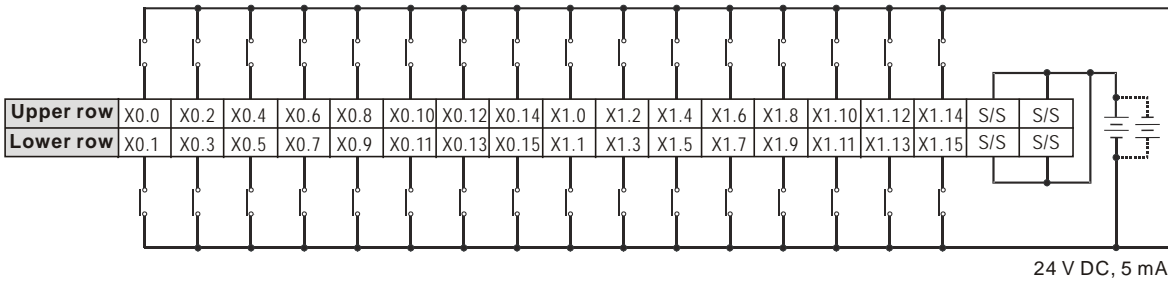

Note: UB-10-ID32A can be used with AS Series and DVP Series. The indications on the UB-10-ID32A board is for DVP Series. For the definitions of terminal connections for AS Series, you can see the reference table below. Or refer to the enclosed sticker for AS Series.

Upper row	AS	X0.0	X0.2	X0.4	X0.6	X0.8	X0.10	X0.12	X0.14	X1.0	X1.2	X1.4	X1.6	X1.8	X1.10	X1.12	X1.14	S/S	S/S
	DVP	X0	X2	X4	X6	X10	X12	X14	X16	X20	X22	X24	X26	X30	X32	X34	X36	S/S	S/S
Lower row	DVP	X1	X3	X5	X7	X11	X13	X15	X17	X21	X23	X25	X27	X31	X33	X35	X37	S/S	S/S
	AS	X0.1	X0.3	X0.5	X0.7	X0.9	X0.11	X0.13	X0.15	X1.1	X1.3	X1.5	X1.7	X1.9	X1.11	X1.13	X1.15	S/S	S/S

4.7.13 Wiring AS32AN02T-A

Output form	Transistor-T (sinking)
Voltage specifications	5 to 30 VDC, 0.1A/output, 3.2A/COM

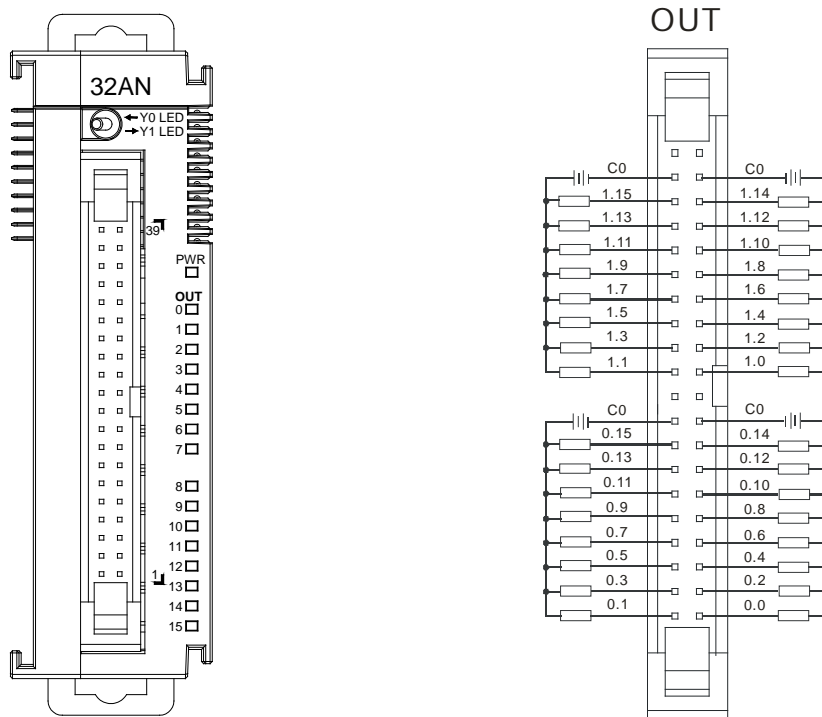

- Wiring the External Terminal Module UB-10-ID16A

For cables that can only be connected to the cables of group #1, see below.

Output form	Transistor-T (sinking)
Voltage specifications	5 to 30 VDC, 0.1 A

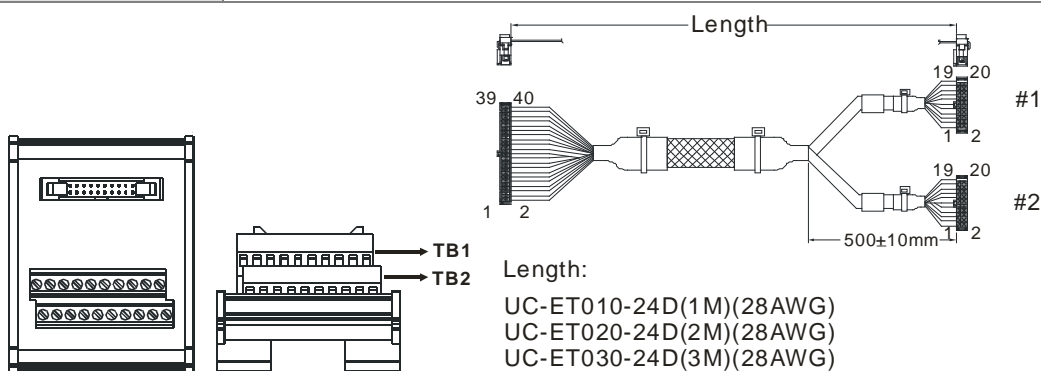

#1	TB1	Y0.0	Y0.2	Y0.4	Y0.6	Y0.8	Y0.10	Y0.12	Y0.14	C0	-
	TB2	Y0.1	Y0.3	Y0.5	Y0.7	Y0.9	Y0.11	Y0.13	Y0.15	C0	-

● Wiring the External Terminal Module UB-10-OR16A

For cables that can only be connected to the cables of group #1, see below.

Output form	Relay
Voltage specifications	Less than 250 VAC, 30 VDC, 2 A

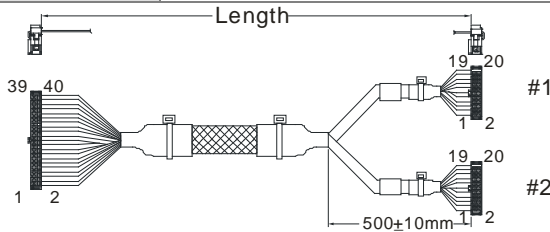

Length:
 UC-ET010-24D(1M)(28AWG)
 UC-ET020-24D(2M)(28AWG)
 UC-ET030-24D(3M)(28AWG)

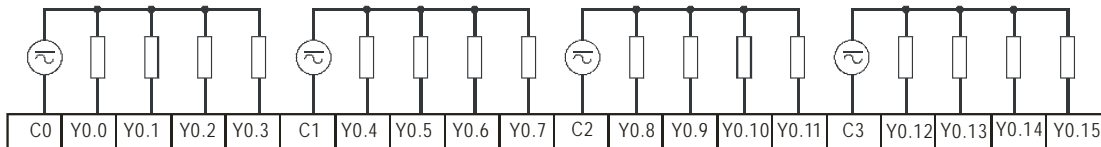
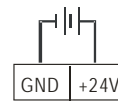

Note: UB-10-OR16A can be used with AS Series and DVP Series. The indications on the UB-10-OR16A board is for DVP Series. For the definitions of terminal connections for AS Series, you can see the reference table below. Or refer to the enclosed sticker for AS Series.

AS	C0	Y0.0	Y0.1	Y0.2	Y0.3	C1	Y0.4	Y0.5	Y0.6	Y0.7	C2	Y0.8	Y0.9	Y0.10	Y0.11	C3	Y0.12	Y0.13	Y0.14	Y0.15
DVP	C0	Y0	Y1	Y2	Y3	C1	Y4	Y5	Y6	Y7	C2	Y10	Y11	Y12	Y13	C3	Y14	Y15	Y16	Y17

● Wiring the External Terminal Module UB-10-OT32A

Output form	Transistor-T (sinking)
Voltage specifications	5 to 30 VDC, 0.1 A

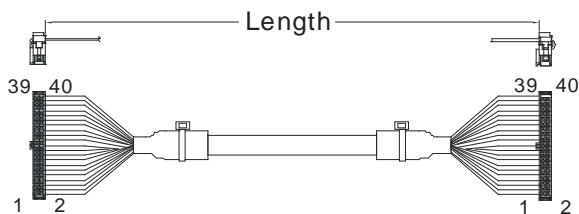

Length:
 UC-ET010-24B(1M)
 UC-ET020-24B(2M)
 UC-ET030-24B(3M)

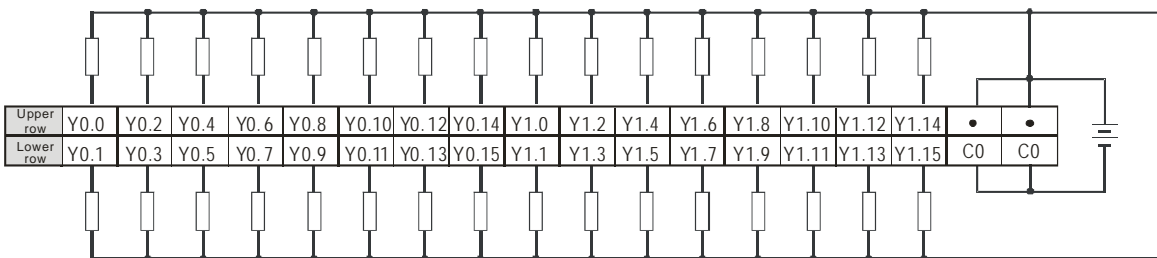

Note: UB-10-OT32A can be used with AS Series and DVP Series. The indications on the UB-10-OT32A board is for DVP Series. For the definitions of terminal connections for AS Series, you can see the reference table below. Or refer to the enclosed sticker for AS Series.

Upper row	AS	Y0.0	Y0.2	Y0.4	Y0.6	Y0.8	Y0.10	Y0.12	Y0.14	Y1.0	Y1.2	Y1.4	Y1.6	Y1.8	Y1.10	Y1.12	Y1.14	●	●
	DVP	Y0	Y2	Y4	Y6	Y10	Y12	Y14	Y16	Y20	Y22	Y24	Y26	Y30	Y32	Y34	Y36	●	●
Lower row	DVP	Y1	Y3	Y5	Y7	Y11	Y13	Y15	Y17	Y21	Y23	Y25	Y27	Y31	Y33	Y35	Y37	C0	C0
	AS	Y0.1	Y0.3	Y0.5	Y0.7	Y0.9	Y0.11	Y0.13	Y0.15	Y1.1	Y1.3	Y1.5	Y1.7	Y1.9	Y1.11	Y1.13	Y1.15	C0	C0

4.7.14 Wiring AS64AM10N-A

Input type	Direct current (sinking or sourcing)
Voltage specifications	24 VDC, 5 mA

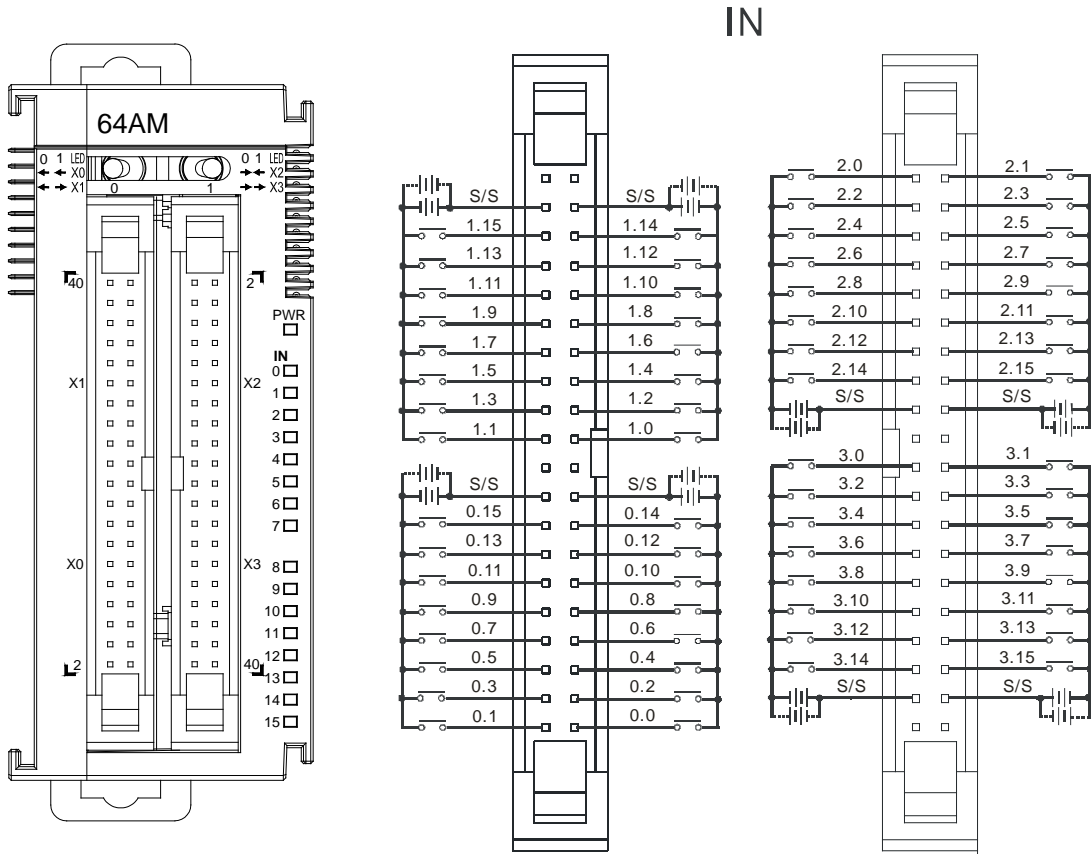

- Wiring the External Terminal Module UB-10-ID16A

For cables that can only be connected to the cables of group #2, see below.

Input form	Direct current (sinking or sourcing)
Voltage specifications	24 VDC, 5 mA

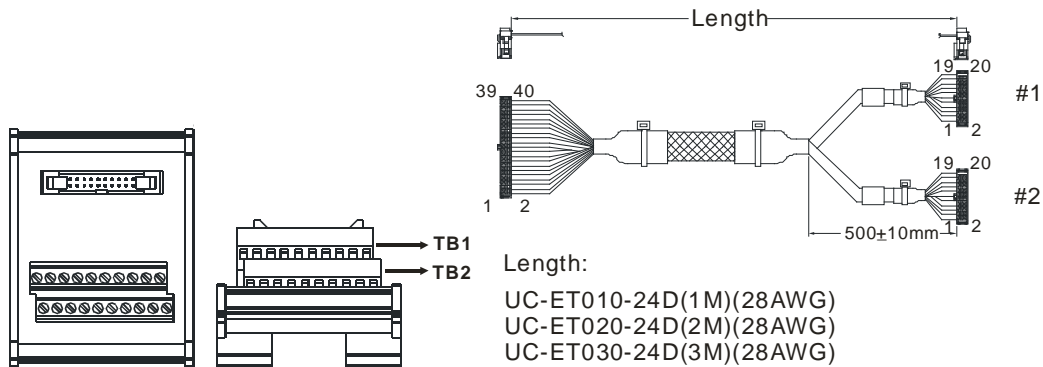

#2	TB1	X0.0	X0.2	X0.4	X0.6	X0.8	X0.10	X0.12	X0.14	S/S	-
	TB2	X0.1	X0.3	X0.5	X0.7	X0.9	X0.11	X0.13	X0.15	S/S	-

● Wiring the External Terminal Module UB-10-ID32A

For cables that can only be connected to the cables of group #2, see below.

Input form	Direct current (sinking or sourcing)
Voltage specifications	24VDC, 5mA

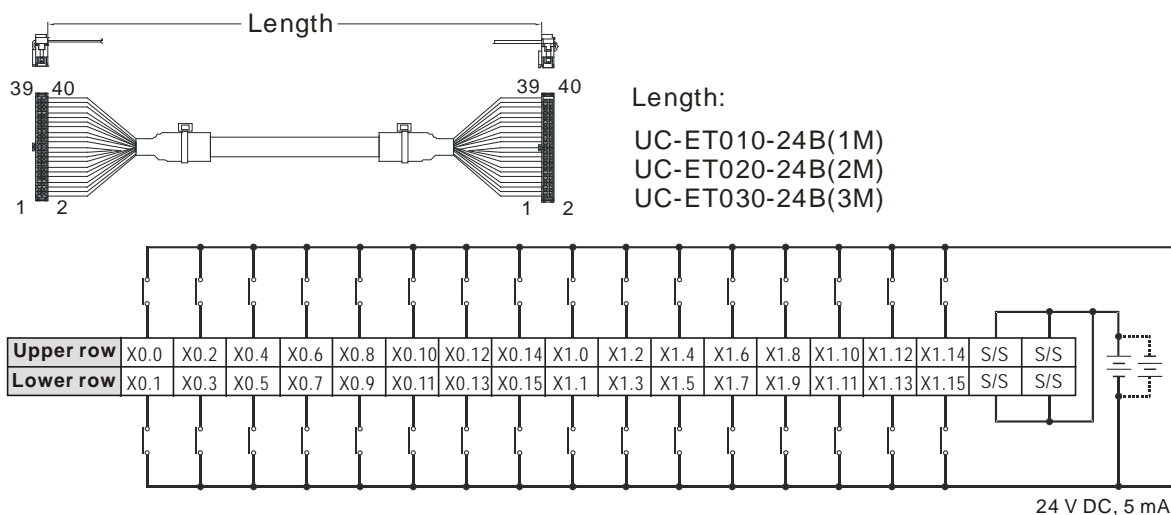

Note: UB-10-ID32A can be used with AS Series and DVP Series. The indications on the UB-10-ID32A board is for DVP Series. For the definitions of terminal connections for AS Series, you can see the reference table below.

Or refer to the enclosed sticker for AS Series.

Upper row	AS	X0.0	X0.2	X0.4	X0.6	X0.8	X0.10	X0.12	X0.14	X1.0	X1.2	X1.4	X1.6	X1.8	X1.10	X1.12	X1.14	S/S	S/S
	DVP	X0	X2	X4	X6	X10	X12	X14	X16	X20	X22	X24	X26	X30	X32	X34	X36	S/S	S/S
Lower row	DVP	X1	X3	X5	X7	X11	X13	X15	X17	X21	X23	X25	X27	X31	X33	X35	X37	S/S	S/S
	AS	X0.1	X0.3	X0.5	X0.7	X0.9	X0.11	X0.13	X0.15	X1.1	X1.3	X1.5	X1.7	X1.9	X1.11	X1.13	X1.15	S/S	S/S

4.7.15 Wiring AS64AN02T-A

Output type	Transistor-T (sinking)
Voltage specifications	5 to 30 VDC, 0.1A/output, 3.2A/COM

OUT

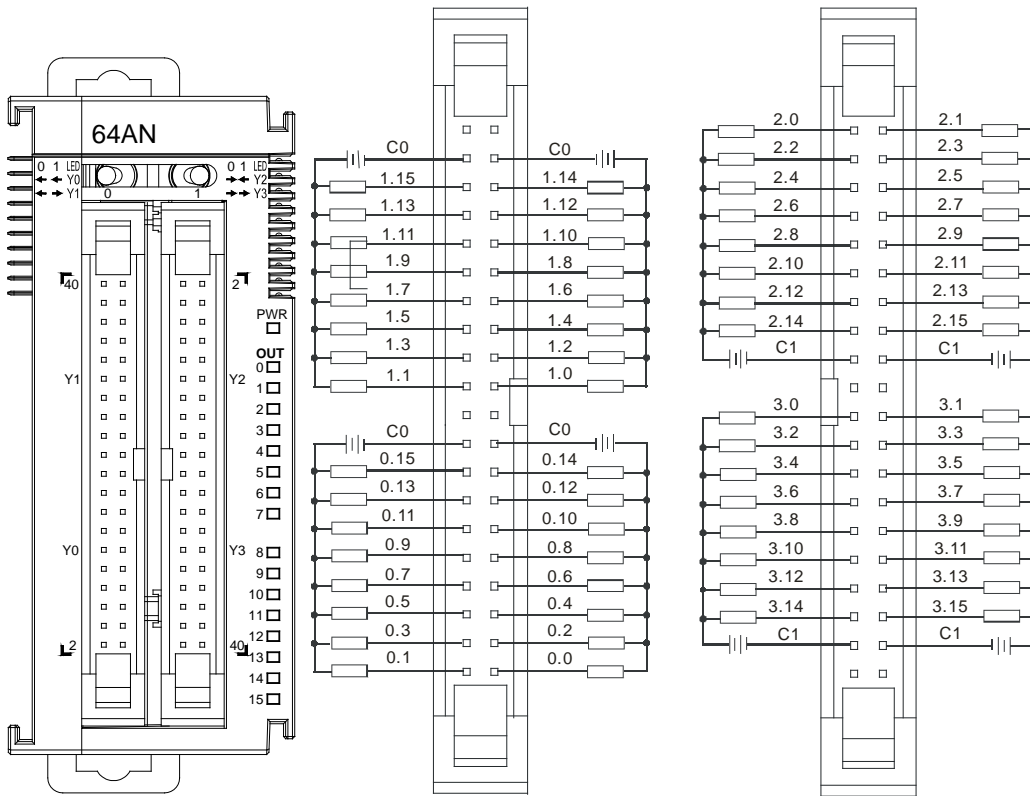

- Wiring the External Terminal Module UB-10-ID16A

For cables that can only be connected to the cables of group #1, see below.

Output type	Transistor-T (sinking)
Voltage specifications	5 to 30 VDC, 0.1 A

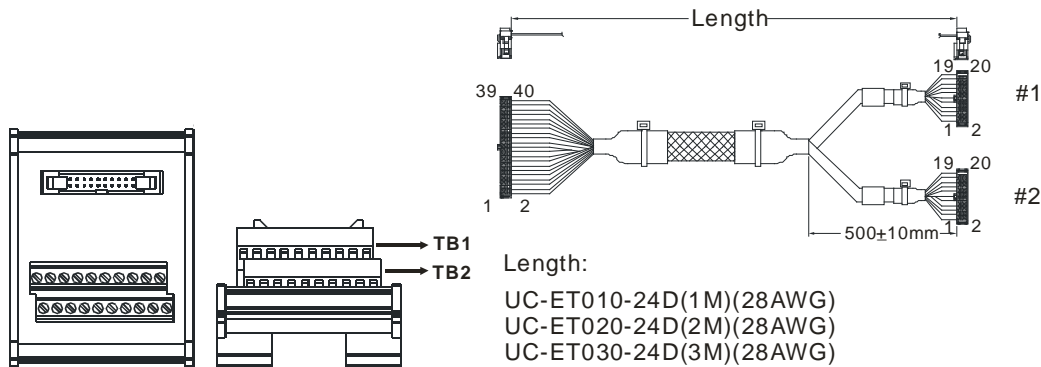

#1	TB1	Y0.0	Y0.2	Y0.4	Y0.6	Y0.8	Y0.10	Y0.12	Y0.14	C0	-
	TB2	Y0.1	Y0.3	Y0.5	Y0.7	Y0.9	Y0.11	Y0.13	Y0.15	C0	-

● Wiring the External Terminal Module UB-10-OR16A

For cables that can only be connected to the cables of group #1, see below.

Output form	Relay
Voltage specifications	Less than 250 VAC, 30 VDC, 2 A

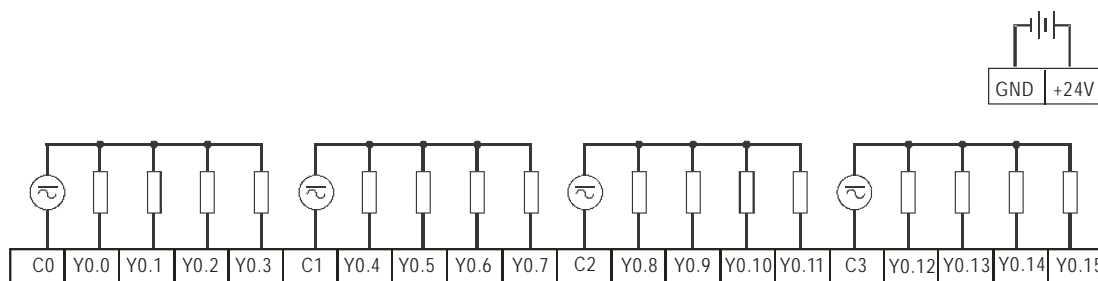
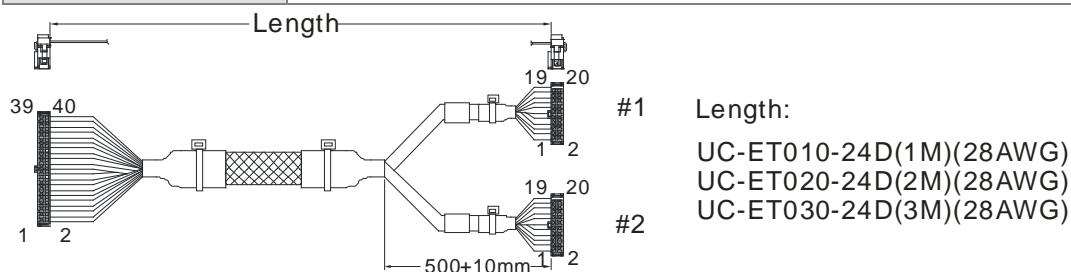

Note: UB-10-OR16A can be used with AS Series and DVP Series. The indications on the UB-10-OR16A board is for DVP Series. For the definitions of terminal connections for AS Series, you can see the reference table below. Or refer to the enclosed sticker for AS Series.

AS	C0	Y0.0	Y0.1	Y0.2	Y0.3	C1	Y0.4	Y0.5	Y0.6	Y0.7	C2	Y0.8	Y0.9	Y0.10	Y0.11	C3	Y0.12	Y0.13	Y0.14	Y0.15
DVP	C0	Y0	Y1	Y2	Y3	C1	Y4	Y5	Y6	Y7	C2	Y10	Y11	Y12	Y13	C3	Y14	Y15	Y16	Y17

● Wiring the External Terminal Module UB-10-OT32A

Output type	Transistor-T (sinking)
Voltage specifications	5 to 30 VDC, 0.1 A

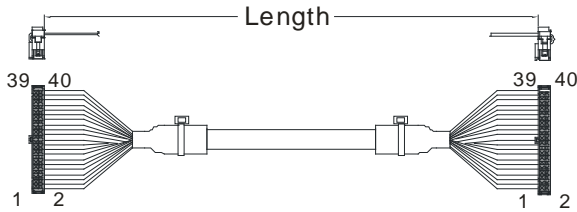

Length:
 UC-ET010-24B(1M)
 UC-ET020-24B(2M)
 UC-ET030-24B(3M)

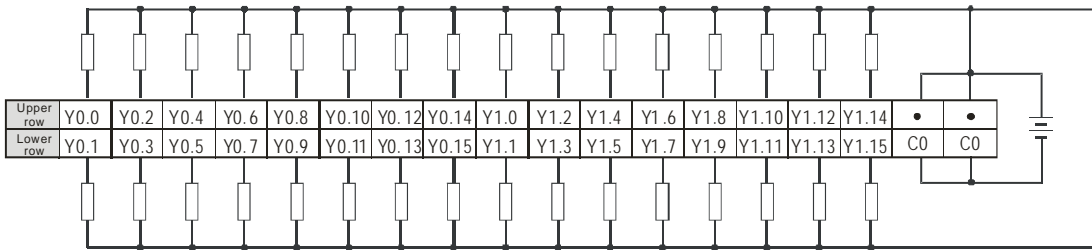

Note: UB-10-OT32A can be used with AS Series and DVP Series. The indications on the UB-10-OT32A board is for DVP Series. For the definitions of terminal connections for AS Series, you can see the reference table below. Or refer to the enclosed sticker for AS Series.

Upper row	AS	Y0.0	Y0.2	Y0.4	Y0.6	Y0.8	Y0.10	Y0.12	Y0.14	Y1.0	Y1.2	Y1.4	Y1.6	Y1.8	Y1.10	Y1.12	Y1.14	●	●
	DVP	Y0	Y2	Y4	Y6	Y10	Y12	Y14	Y16	Y20	Y22	Y24	Y26	Y30	Y32	Y34	Y36	●	●
Lower row	DVP	Y1	Y3	Y5	Y7	Y11	Y13	Y15	Y17	Y21	Y23	Y25	Y27	Y31	Y33	Y35	Y37	C0	C0
	AS	Y0.1	Y0.3	Y0.5	Y0.7	Y0.9	Y0.11	Y0.13	Y0.15	Y1.1	Y1.3	Y1.5	Y1.7	Y1.9	Y1.11	Y1.13	Y1.15	C0	C0

4.8 Wiring Digital Input/Output Terminals

4.8.1 Wiring Digital Input Terminals

4.8.1.1 Sinking and Sourcing

The input signal is the 24 VDC power input. Sinking and sourcing are the current driving capabilities of a circuit. They are defined as follows.

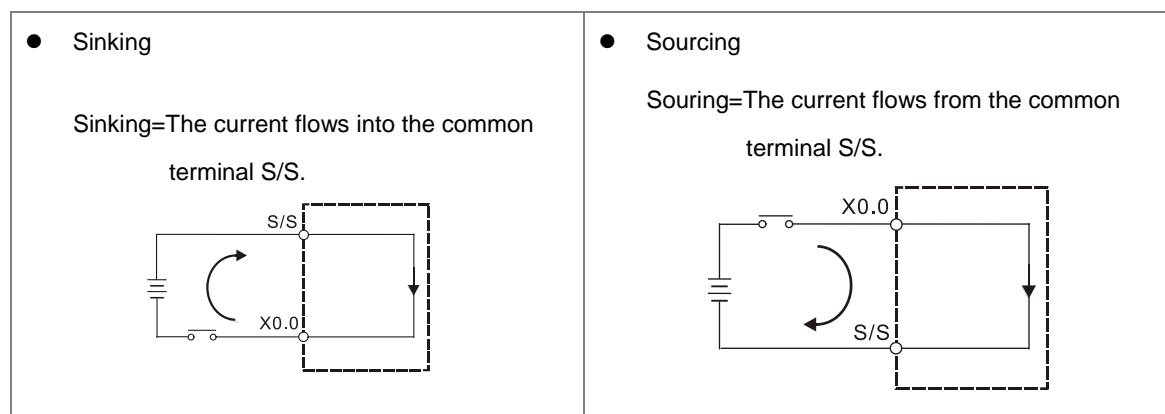

4.8.1.2 Relay Type

- Sinking

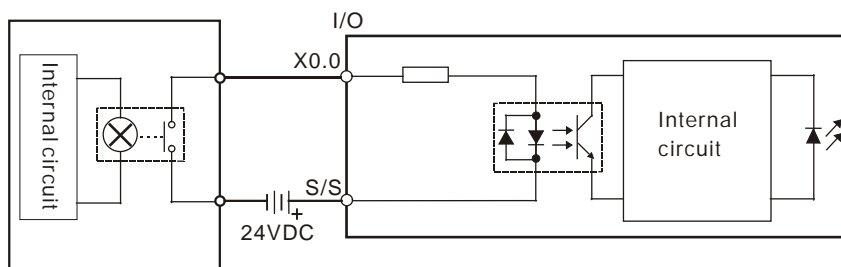

- Sourcing

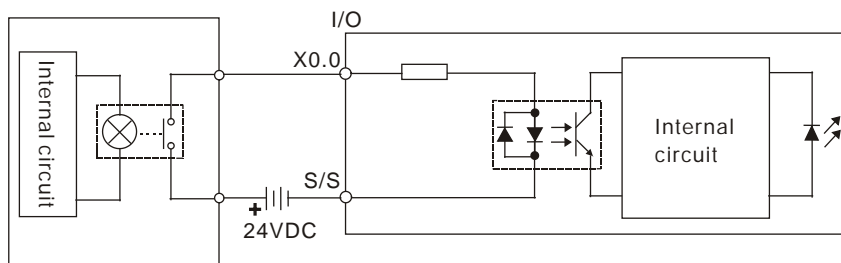

4.8.1.3 Open-collector Input Type

- Sinking

(NPN transistor whose collector is open)

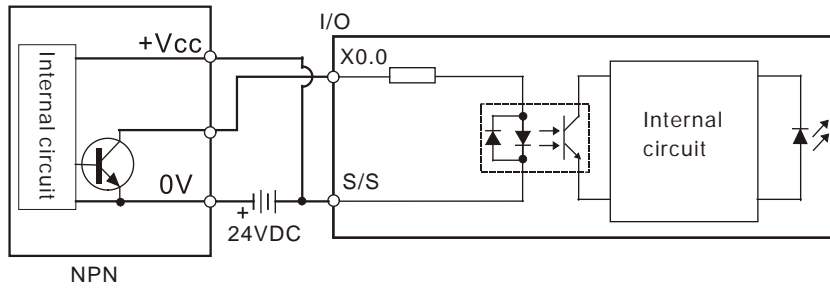

- Sourcing

(PNP transistor whose collector is open)

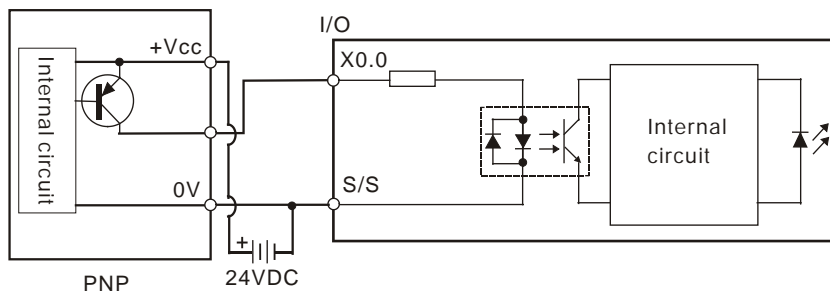

4.8.1.4 Two-wire Proximity Switch

Use the two-wire proximity switch whose leakage current I_L is less than 1.5 mA when the switch is OFF. If the leakage current is larger than 1.5 mA, connect the divider resistance R_b using the formula below.

$$R_b \leq \frac{6}{I_L - 1.5} \text{ (k}\Omega\text{)}$$

- Sinking

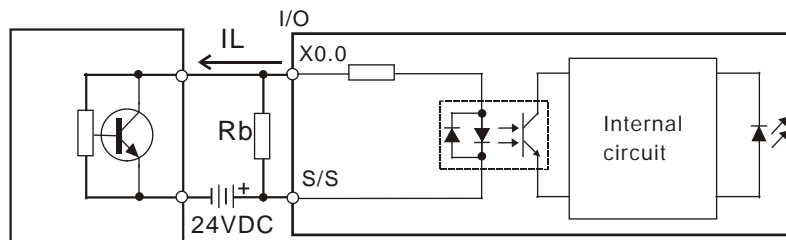

Two-wire proximity switch

- Sourcing

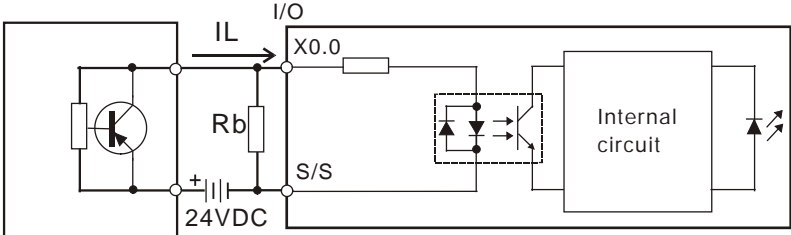

Two-wire proximity switch

4.8.1.5 Three-wire Switch

- Sinking

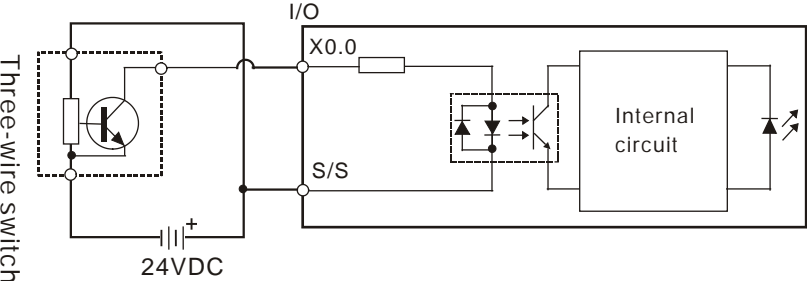

- Sourcing

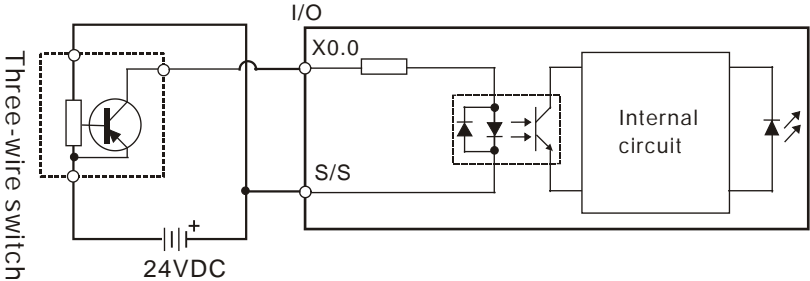

4.8.1.6 Optoelectronic Switch

- Sinking

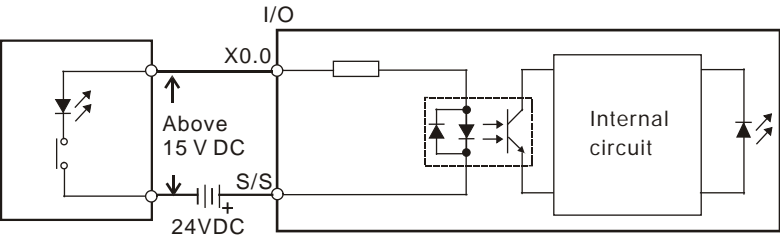

Optoelectronic switch

- Sourcing

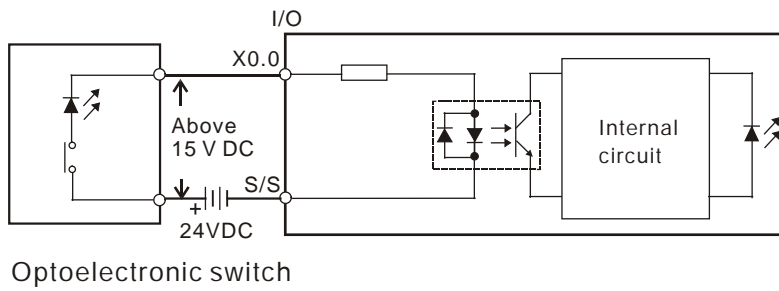

4.8.1.7 Differential Input

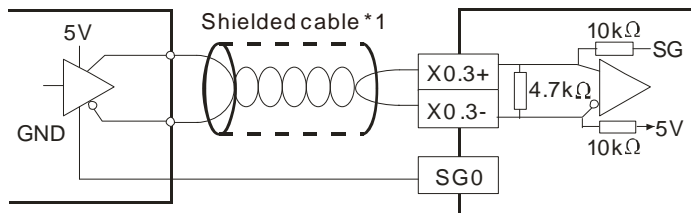

4

4.8.2 Wiring Digital Output Terminals

4.8.2.1 Output Circuits

There are three types of output units. They are relay outputs, transistor outputs, and differential outputs.

1. Relay output

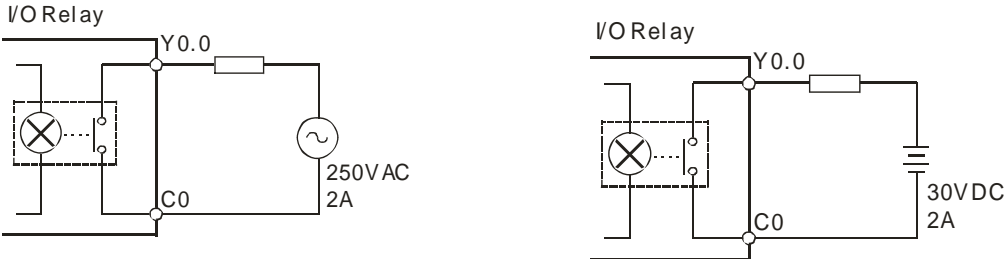

2. Transistor output

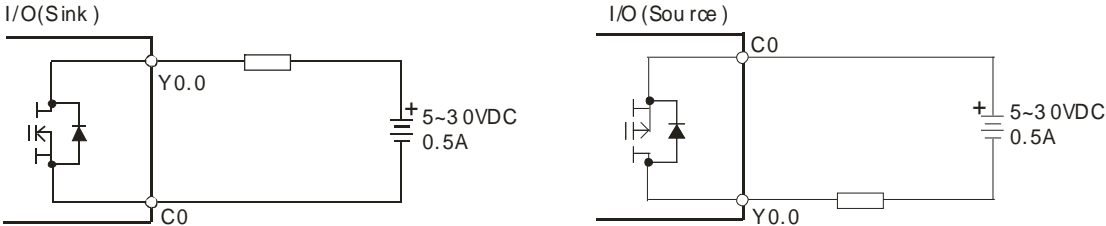

3. Differential output

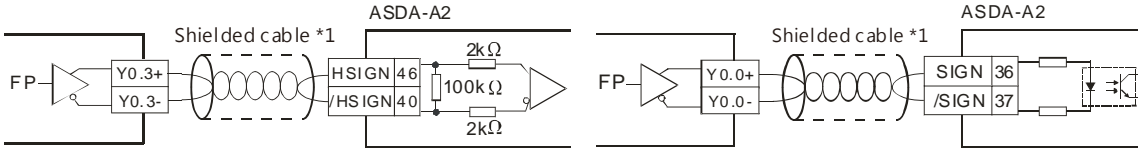

4.8.2.2 Relay Output Circuit

Relay terminals have no polarity. They can be used with alternating current that passes through a load, or with direct current that passes through a load. The maximum current that can pass through every relay terminal is 2 A, and refer to each product specification for the maximum current that can pass through every common terminal. Life cycle curve: The lifetime of a relay terminal varies with the working voltage, the load type (the power factor $\cos\phi$, the time constant $t(L/R)$), and the current passing through the terminal. The relation is shown in the life cycle curve below.

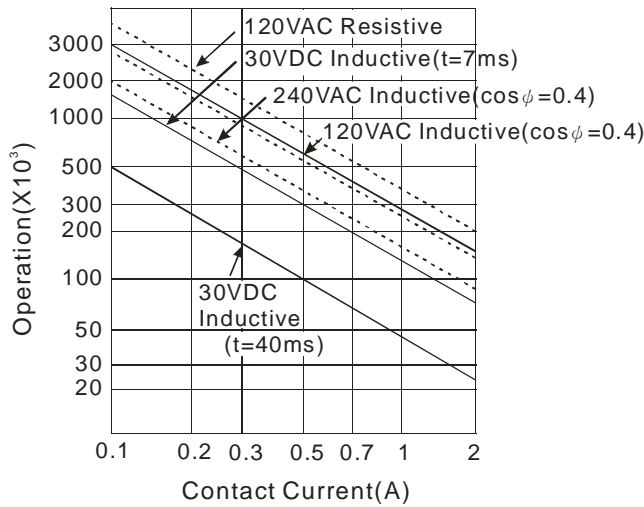

- Relay output circuit

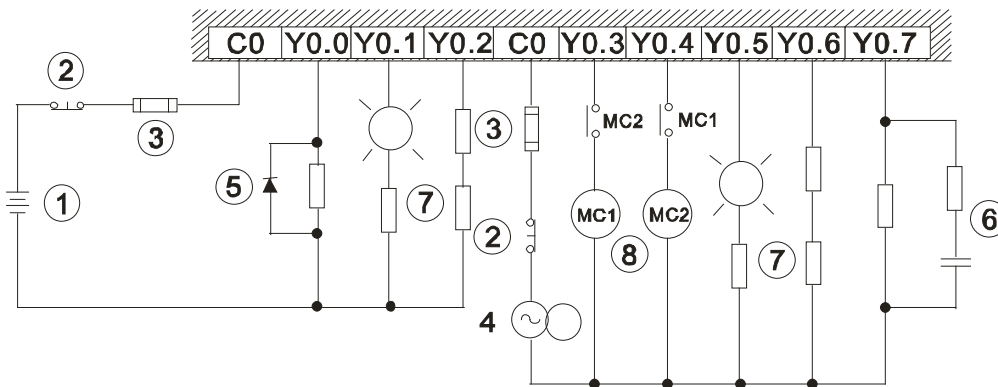

①	Direct-current power supply
②	Emergency stop using an external switch.
③	Fuse: to protect the output circuit, a fuse having a breaking capacity between 5 A to 10 A is connected to the common terminal.
④	Alternating-current power supply

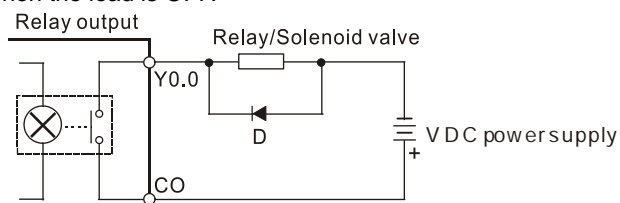
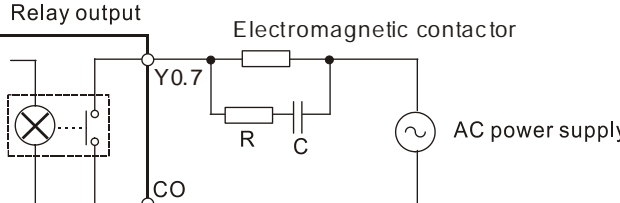
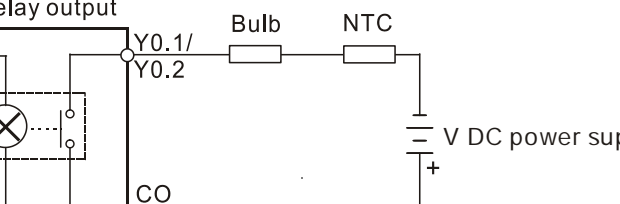
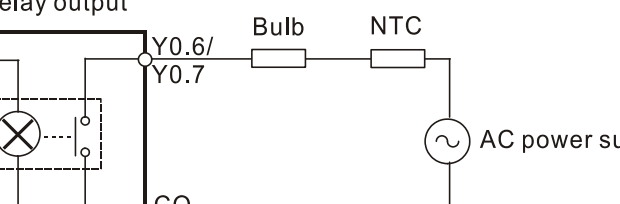
<p>⑤</p>	<p>A relay or a solenoid valve is used as a DC load. A diode is connected in parallel to absorb the surge voltage that occurs when the load is OFF.</p>  <p>D: 1N4001 diode</p>
<p>⑥</p>	<p>An electromagnetic contactor is used as an AC load. A resistor and a capacitor are connected in parallel to absorb the surge voltage that occurs when the load is OFF.</p>  <p>R: 100~120 Ω C: 0.1~0.24 μF</p>
<p>⑦</p>	<p>A bulb (incandescent lamp) is used as a DC load. A thermistor is connected in series to absorb the surge current that occurs when the load is ON.</p>  <p>NTC: 10 Ω</p> <p>A bulb (neon lamp) is used as an AC load. A thermistor is connected in series to absorb the surge current that occurs when the load is ON.</p>  <p>NTC: 10 Ω</p>
<p>⑧</p>	<p>Mutually exclusive output: For example, Y0.3 controls the clockwise rotation of the motor, and Y0.4 controls the counterclockwise rotation of the motor. This interlock circuit and the program in the PLC ensure that there are protective measures if an abnormal condition occurs.</p>

4.8.2.3 Transistor Output Circuit (NPN)

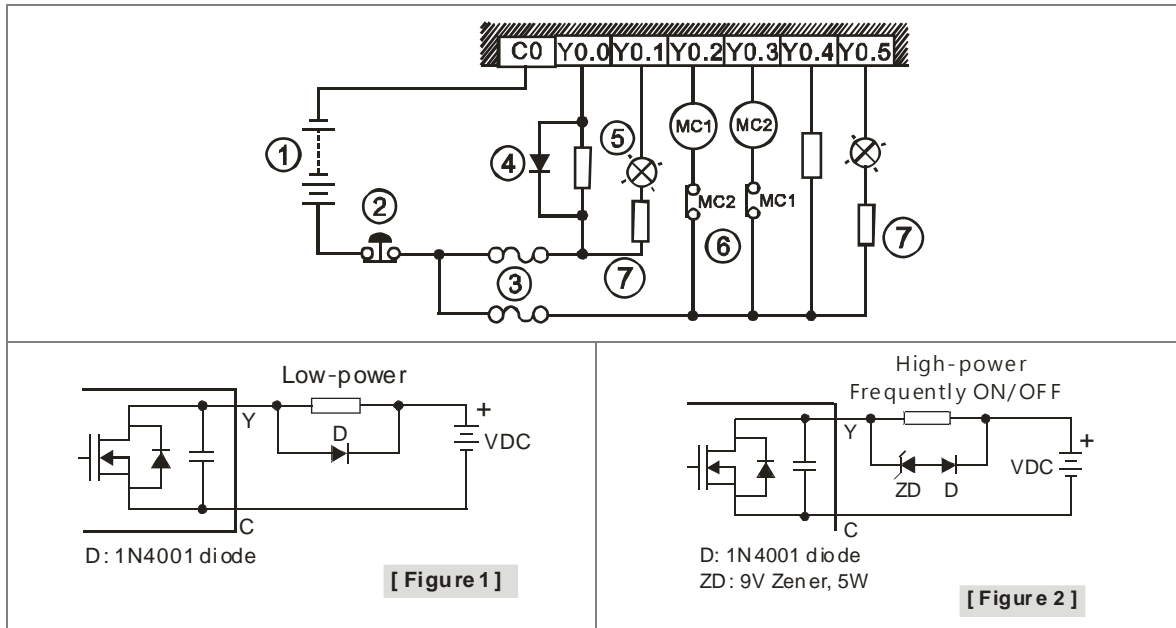

①	Direct-current power supply
②	Emergency stop
③	Fuse
④	<p>The output terminals of a transistor module are open-collector output terminals. If Y0.0/Y0.1 is a pulse train output terminal of a transistor module, the output current passing through its output pull-up resistor must be greater than 0.1 A to ensure that the transistor module operates normally.</p> <ol style="list-style-type: none"> 1. A diode is connected in parallel to absorb the surge voltage: used in low-power situations (refer to Figure 1). 2. A diode and Zener are connected in parallel to absorb the surge voltage: used in high-power and power-on/off frequently situations (refer to Figure 2).
⑤	A bulb (incandescent lamp) is used as a DC load. A thermistor is connected in series to absorb the surge current which occurs when the load is ON.
⑥	Mutually exclusive output: For example, Y0.2 controls the clockwise rotation of the motor, and Y0.3 controls the counterclockwise rotation of the motor. This interlock circuit and the program in the PLC ensure that there are protective measures if an abnormal condition occurs.
⑦	Connected to a NTC thermistor (negative temperature coefficient), when a bulb (incandescent lamp) is used as a DC load and a thermistor is connected in series to absorb the surge current.

4.9 Wiring Analog Input/Output Modules

Definitions of the terminals

- ◆ Two/three-wire (passive sensor): the sensor and the system share the same power circuit.
- ◆ Four-wire (active sensor): the sensor uses an independent power supply and should not share the same power circuit with the system.
- ◆ Note: use cables with the same length (less than 200 m) and use terminal resistors of less than 100 ohm.

4.9.1 Wiring AS04AD-A

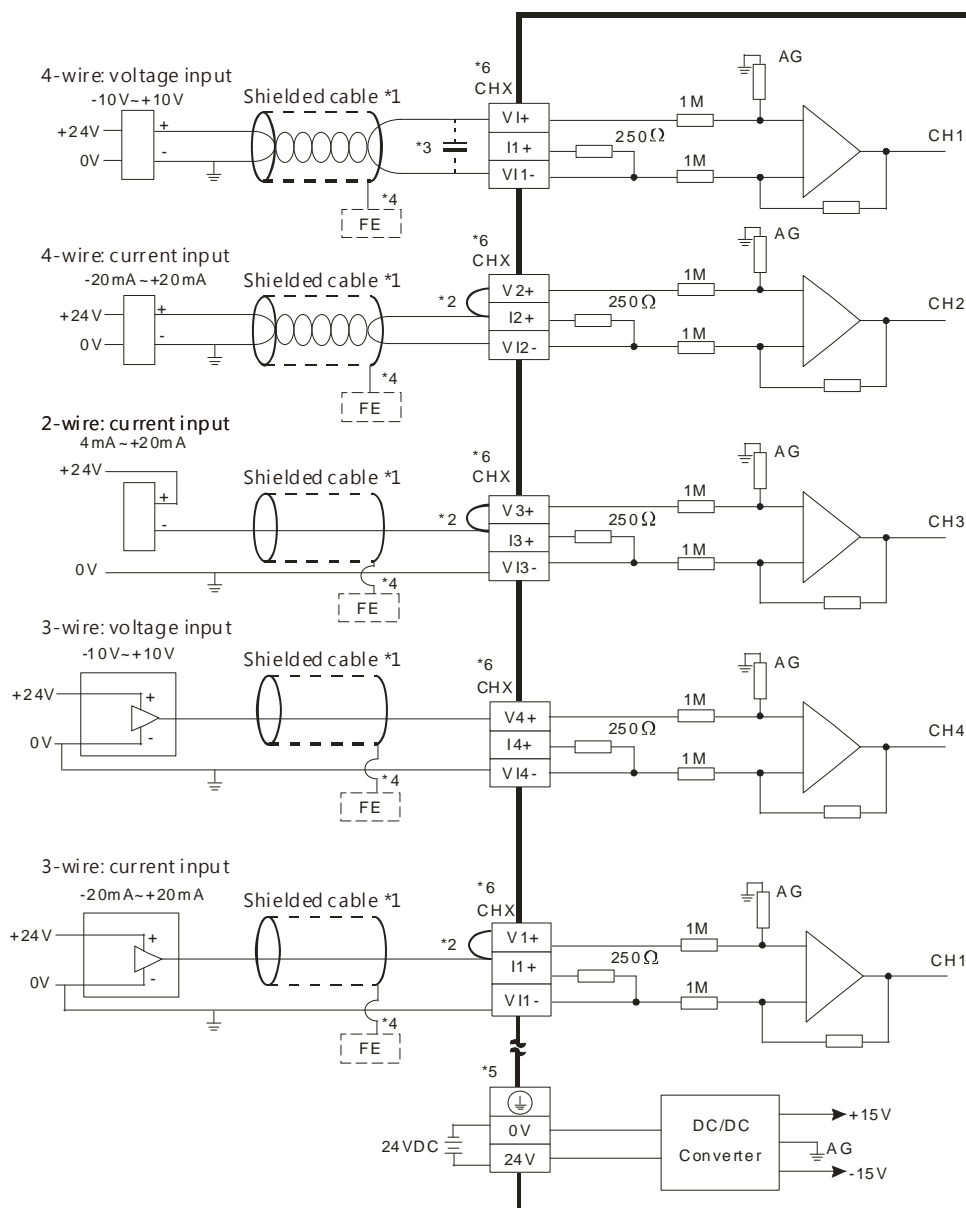

*1. Use shielded cables to isolate the analog input signal cable from other power cables.

*2. If the module is connected to a current signal, the terminals V_n and I_{n+} (n=1–4) must be short-circuited.

- *3. If noise in the input voltage results in noise interference in the wiring, connect the module to a capacitor with a capacitance between 0.1–0.47 μF with a working voltage of 25 V.
- *4. Connect FE of the shielded cable to ground.
- *5. Connect the terminal ⏏ to ground.
- *6. Every channel can work with the wiring shown above.

4.9.2 Wiring AS08AD-B

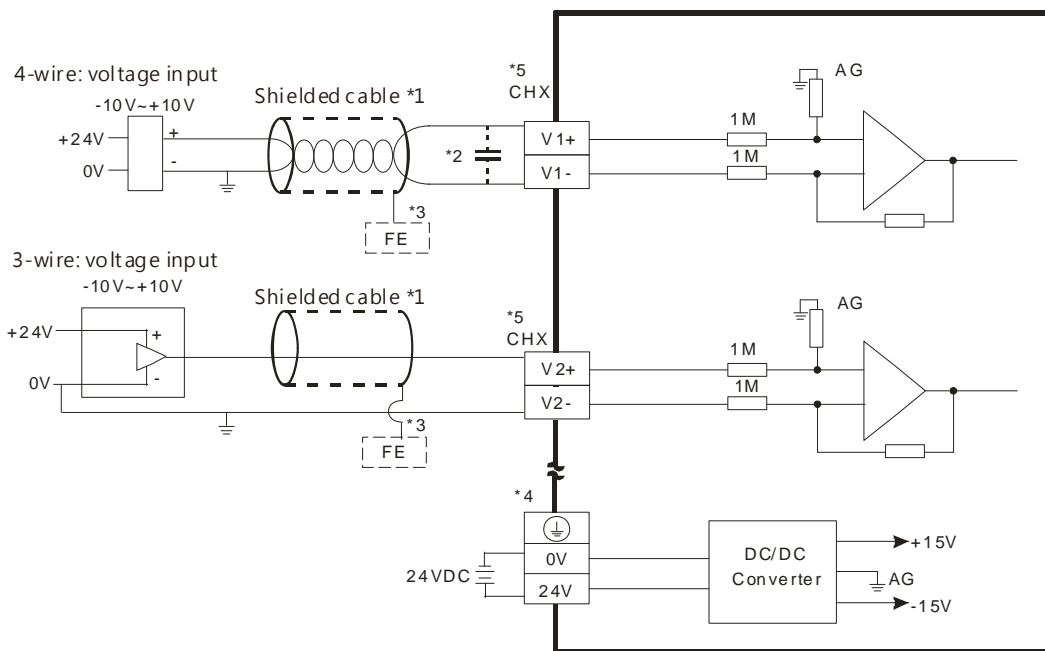

- *1. Use shielded cables to isolate the analog input signal cable from other power cables.
- *2. If noise in the input voltage results in noise interference in the wiring, connect the module to a capacitor with a capacitance between 0.1–0.47 μF with a working voltage of 25 V.
- *3. Connect FE of the shielded cable to ground.
- *4. Connect the terminal ⏏ to ground.
- *5. Every channel can work with the wiring shown above.

4.9.3 Wiring AS08AD-C

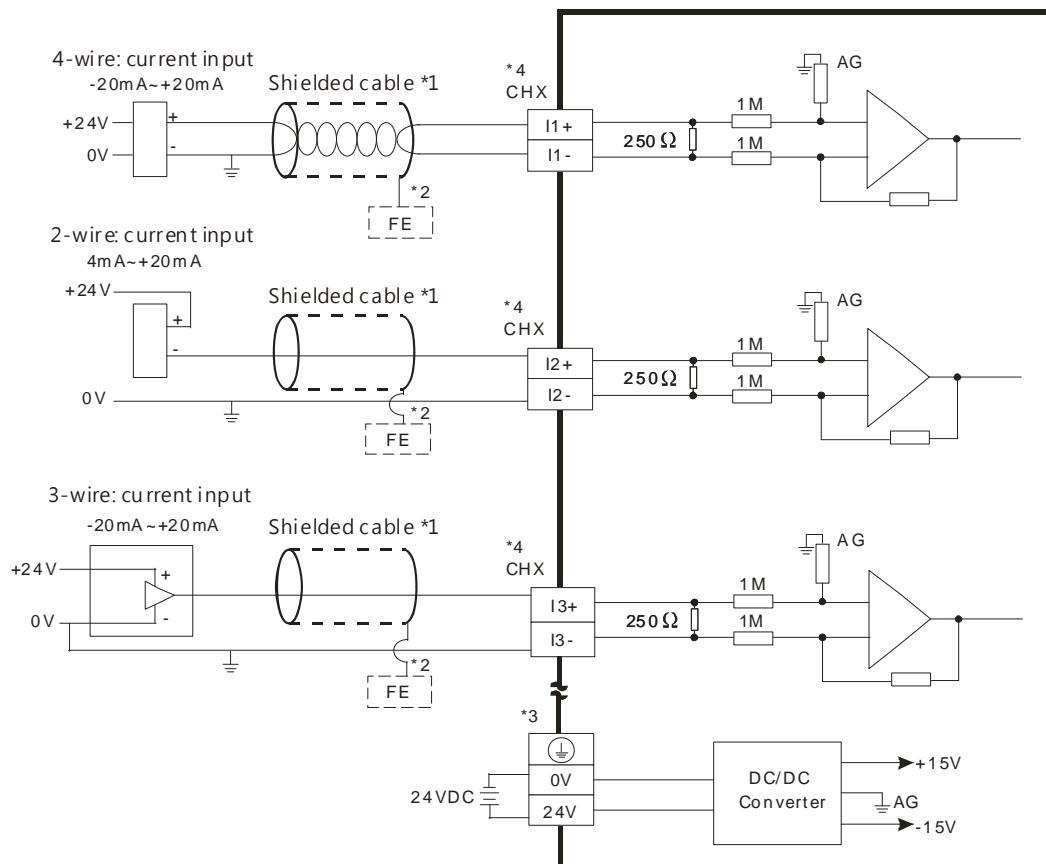

*1. Use shielded cables to isolate the analog input signal cable from other power cables.

*2. Connect FE of the shielded cable to ground.

*3. Connect the terminal \oplus to ground.

*4. Every channel can work with the wiring shown above.

4.9.4 Wiring AS04DA-A

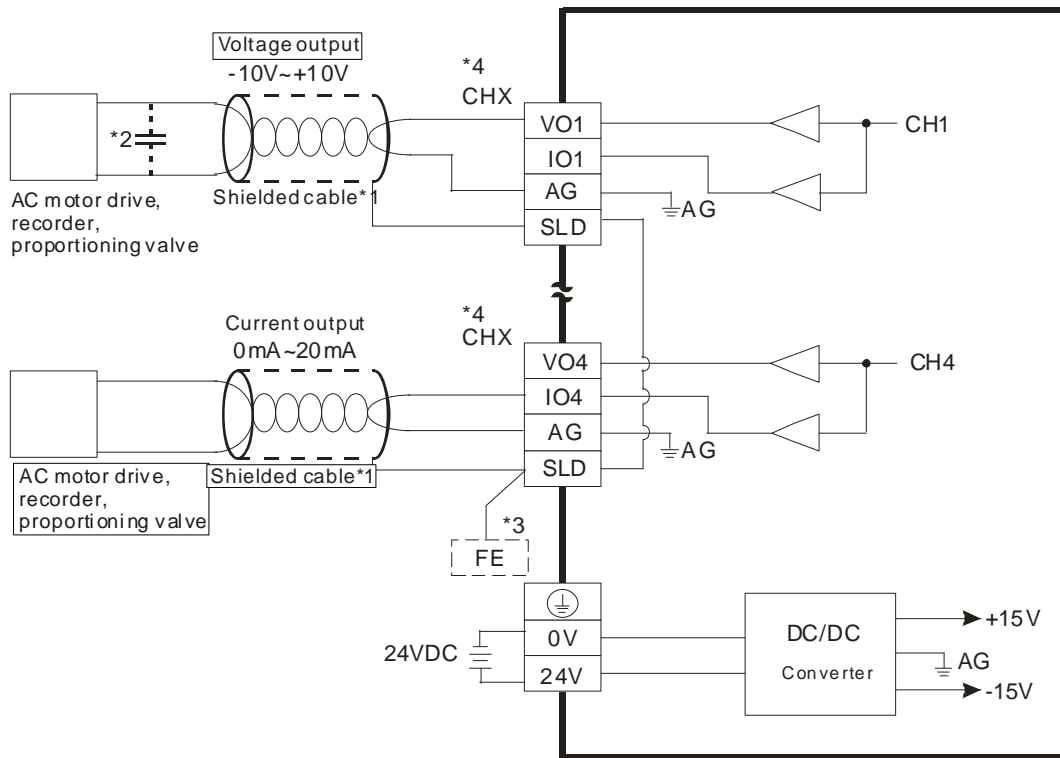

- *1. Use shielded cables to isolate the analog input signal cable from other power cables.
- *2. If noise in the input voltage results in noise interference in the wiring, connect the module to a capacitor with a capacitance between 0.1–0.47 μF with a working voltage of 25 V.
- *3. Connect the SLD to FE. Connect FE and the terminal ⏏ to ground.
- *4. Every channel can work with the wiring shown above.

4.9.5 Wiring AS06XA-A

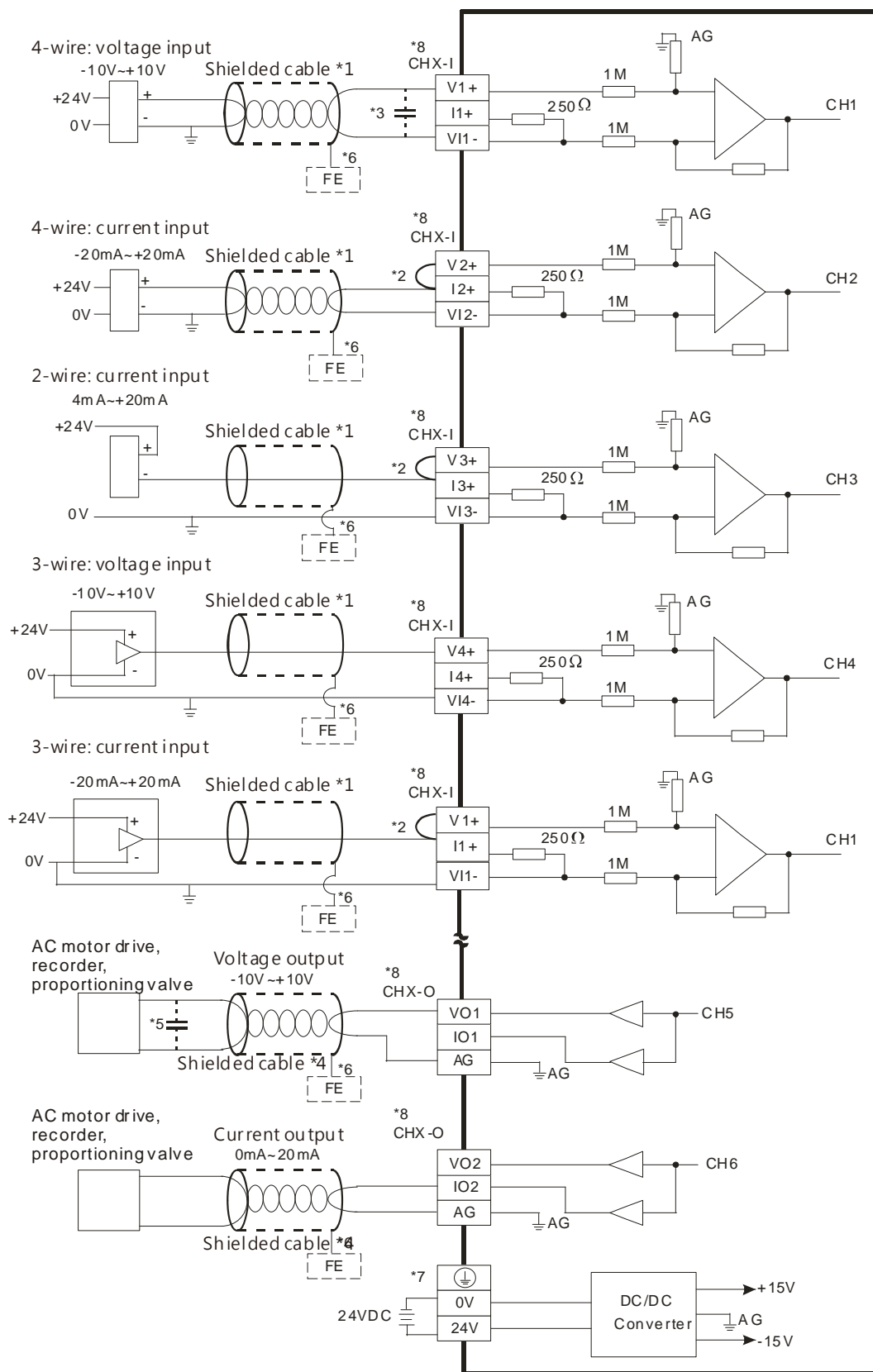

- *1. Use shielded cables to isolate the analog input/output signal cable from other power cables.
- *2. If the module is connected to a current signal, the terminals V_n and I_{n+} ($n=1-4$) must be short-circuited.
- *3. If noise in the input voltage results in noise interference with the wiring, connect the module to a capacitor with a capacitance between $0.1-0.47 \mu\text{F}$ with a working voltage of 25 V.
- *4. Use shielded cables to isolate the analog output signal cable from other power cables.
- *5. If noise in the output voltage results in noise interference in the wiring, connect the module to a capacitor with a capacitance between $0.1 \mu\text{F}-0.47 \mu\text{F}$ with a working voltage of 25 V.
- *6. Connect FE of the shielded cable to ground.
- *7. Connect the terminal  to ground.
- *8. CHX-I: Every channel can work with the input wiring shown above. CHX-O: Every channel can work with the output wiring shown above.

4.9.6 Wiring AS02ADH-A

● Precautions

To ensure the analog-to-digital module functions well and reliably, the external wiring must prevent noise. Before you install the cables, follow the precautions below.

- (1) To prevent a surge and induction, the AC cable and the input signal cables that are connected to the module must be separate cables.
- (2) Do not install the cable near a main circuit, a high-voltage cable, or a cable connected to a load that is not a PLC. In addition, the cable must not be bound to a main circuit, a high-voltage cable, or a cable connected to a load which is not a PLC.
- (3) Ground shielded cables and hermetically sealed cables separately.
- (4) Terminals with insulation sleeves cannot be arranged as a terminal block, so you should cover the terminals with insulation tubes.
- (5) Use single-core cables or twin-core cables in a diameter of 24 AWG–22 AWG with pin-type connectors smaller than 1 mm. Use only copper conducting wires that can resist temperatures above 60° C-75° C.

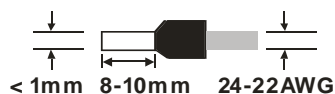

- (6) Notes on two-wire, three-wire, and four-wire connections:
 - Two-wire connection/three-wire connection (passive transducer): connect the transducer and the analog input module to the same power circuit.
 - Four-wire connection (active transducer): the transducer uses an independent power supply so do not connect it to the same power circuit as the analog input module.
- (7) Note: use cables with the same length (less than 200 m) and use wire resistance of less than 20 ohm.

4.9.6.1 Digital Input Wiring

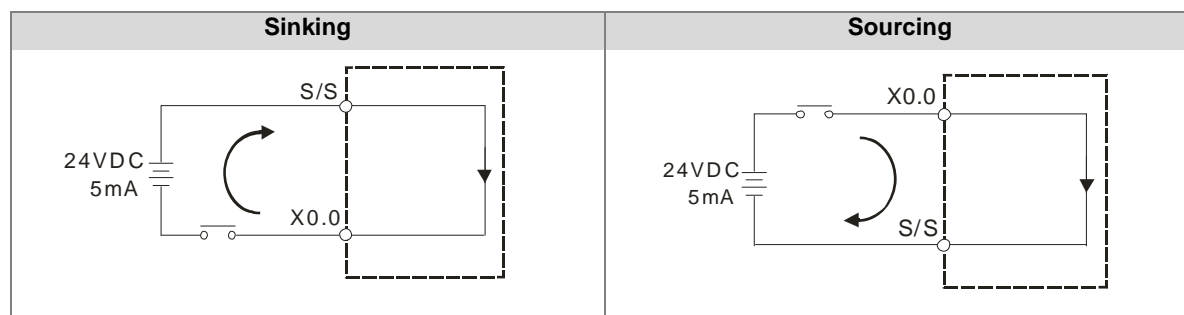

4.9.6.2 Analog Input Wiring

- 4-wired

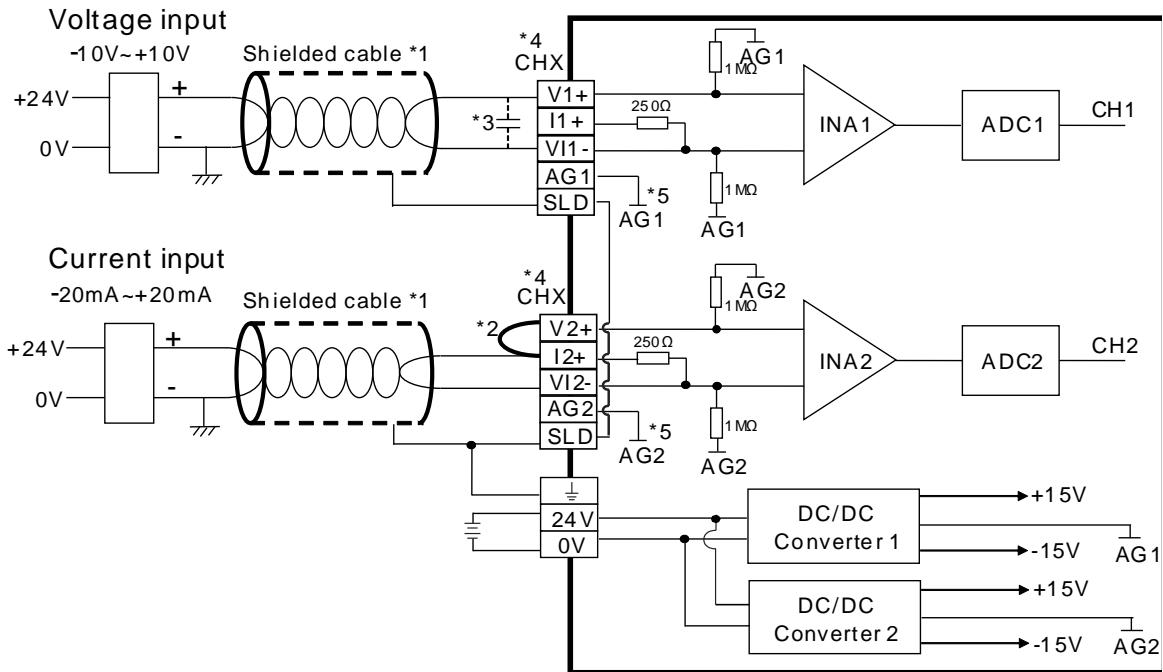

- *1. Use shielded cables to isolate the analog input signal cable from other power cables.
- *2. If the module is connected to a current signal, the terminals V_n and I_{n+} (n=1-2) must be short-circuited.
- *3. If variability in the input voltage results in interference within the wiring, connect the module to a capacitor with a capacitance between 0.1-0.47 μF and a working voltage of 25 V.
- *4. The wording "CHX" indicates that very channel can operate with the wiring presented above.
- *5. If the environment is severe or there is interferences in 24 V pwer supply, short-circuit AG_n (n=1-2) and the input signal.

- 3-wired

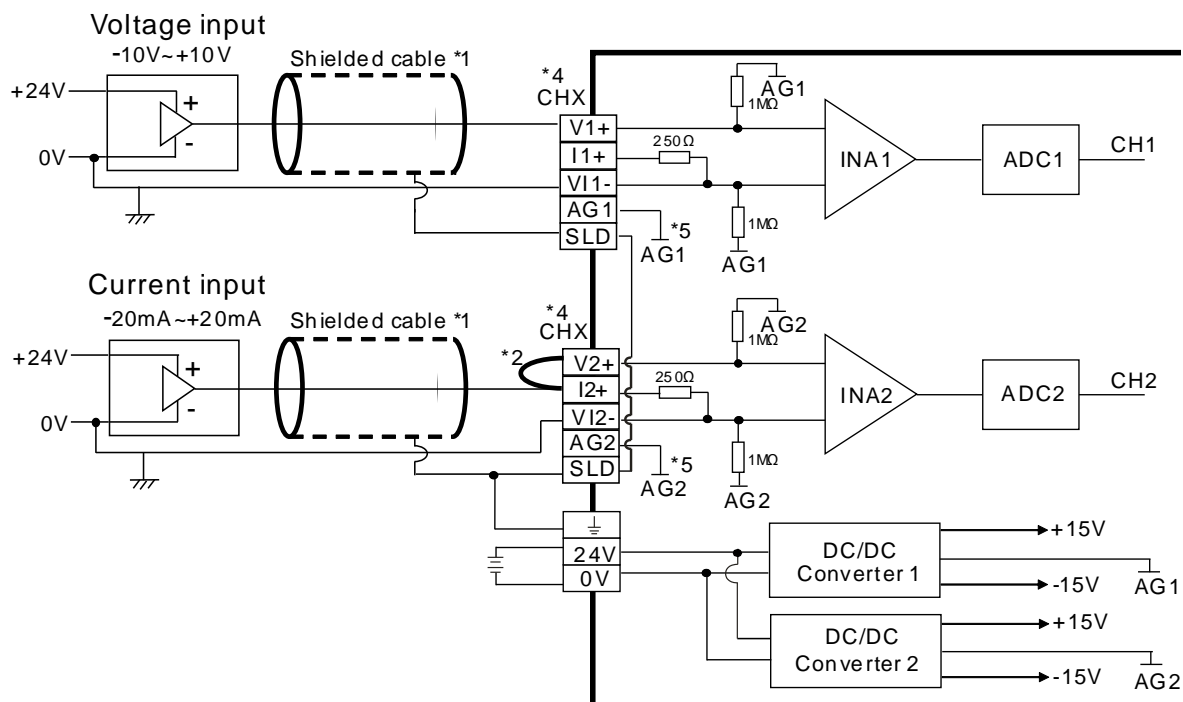

*1. Use shielded cables to isolate the analog input signal cable from other power cables.

*2. If the module is connected to a current signal, the terminals V_n and I_n ($n=1-2$) must be short-circuited.

*3. If variability in the input voltage results in interference within the wiring, connect the module to a capacitor with a capacitance between 0.1–0.47 μF and a working voltage of 25 V.

*4. The wording “CHX” indicates that very channel can operate with the wiring presented above.

*5. If the environment is severe or there is interferences in 24 V pwer supply, short-circuit AG_n ($n=1-2$) and the input signal.

● 2-wired

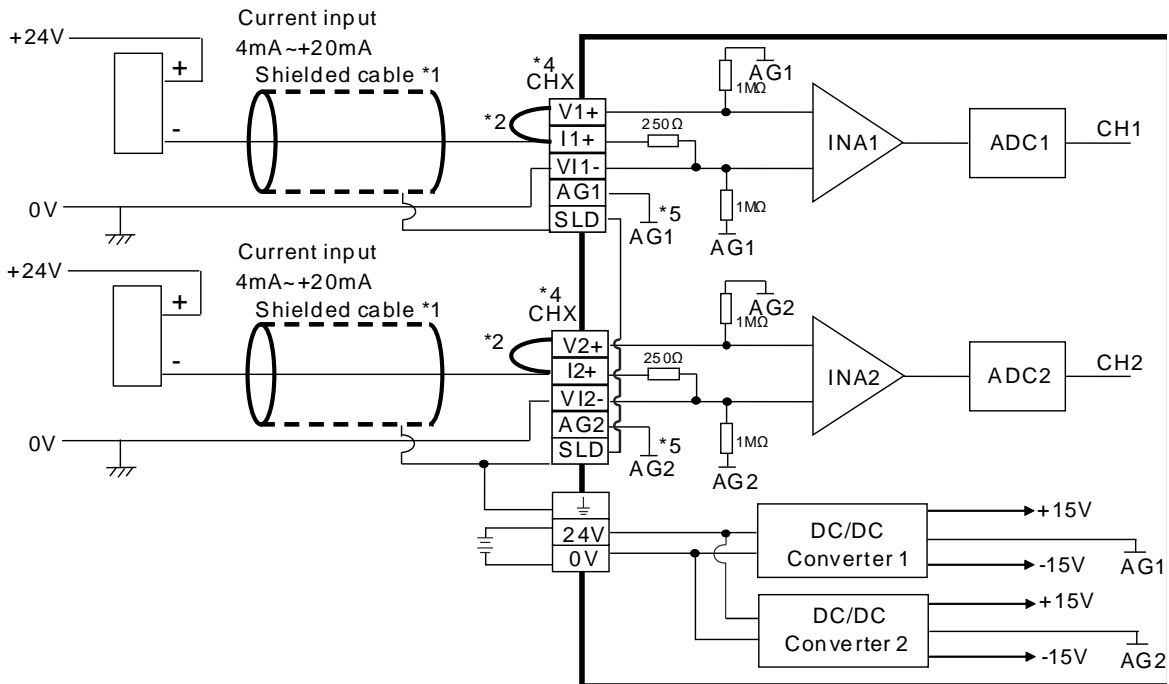

- *1. Use shielded cables to isolate the analog input signal cable from other power cables.
- *2. If the module is connected to a current signal, the terminals V_n and I_n ($n=1-2$) must be short-circuited.
- *3. If variability in the input voltage results in interference within the wiring, connect the module to a capacitor with a capacitance between 0.1–0.47 μF and a working voltage of 25 V.
- *4. The wording “CHX” indicates that very channel can operate with the wiring presented above.
- *5. If the environment is severe or there is interferences in 24 V pwer supply, short-circuit AG_n ($n=1-2$) and the input signal.

4.10 Wiring Temperature Measurement Modules

4.10.1 Wiring AS04RTD-A

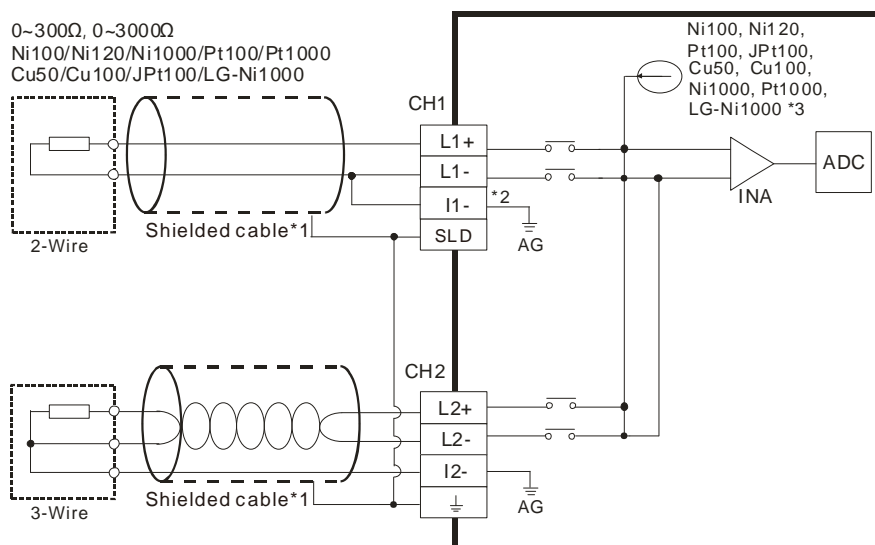

*1. Use shielded twisted pair cables for temperature sensors, and keep them away from power cables and other cables that generate noise.

*2. If you use two-wire temperature sensors, L_n- and I_n- must be short-circuited (where n is between 1–4).

*3. There are two different internal excitation currents. If you are using temperature sensors, such as Ni100, Ni120, Pt100, JPt100, Cu50/Cu100, or a 0~300 Ω resistance sensor, the internal excitation current is 1.0 mA. If you are using a Ni1000 temperature sensor, a Pt1000 temperature sensor, a LG-Ni1000 sensor, or a 0~3000 Ω resistance sensor, the internal excitation current is 0.2 mA.

Note: use cables with the same length (less than 200 m) and use terminal resistors of less than 200 ohm.

4.10.2 Wiring AS06RTD-A

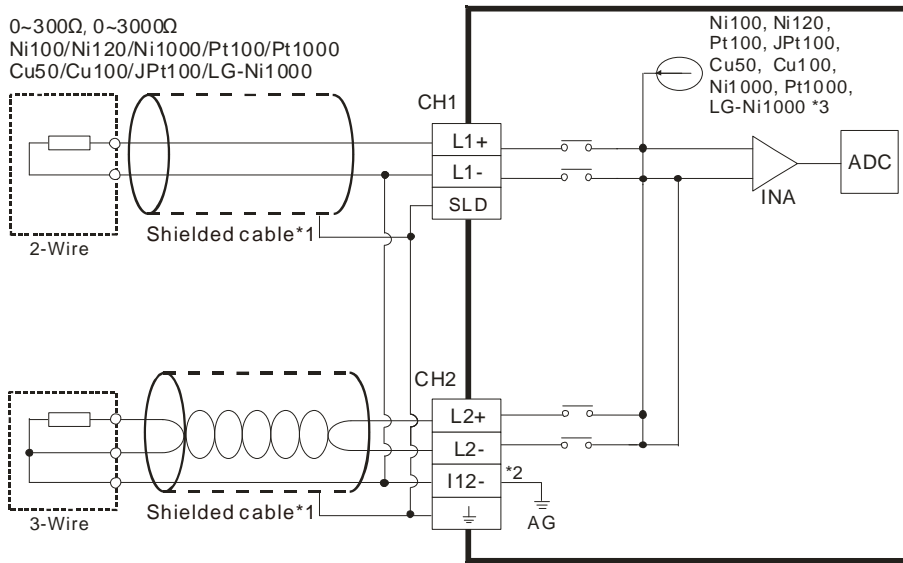

*1. Use shielded twisted pair cables for temperature sensors and keep them away from power cables and other cables that generate noise.

*2. Terminal "I12-" indicates " I1- & I2-", terminal "I34-" indicates " I3- & I4-", and terminal "I56-" indicates " I5- & I6-". If you use two-wire temperature sensors, Ln- and In- must be short-circuited (where n is between 1-6).

*3. There are two different internal excitation currents. If you are using temperature sensors, such as Ni100, Ni120, Pt100, JPt100, Cu50/Cu100, or a 0~300 Ω resistance sensor, the internal excitation current is 1.0 mA. If you are using a Ni1000 temperature sensor, a Pt1000 temperature sensor, a LG-Ni1000 sensor, or a 0~3000 Ω resistance sensor, the internal excitation current is 0.2 mA.

Note: use cables with the same length (less than 200 m) and use terminal resistors of less than 200 ohm.

4.10.3 Wiring AS04TC-A / AS08TC-A

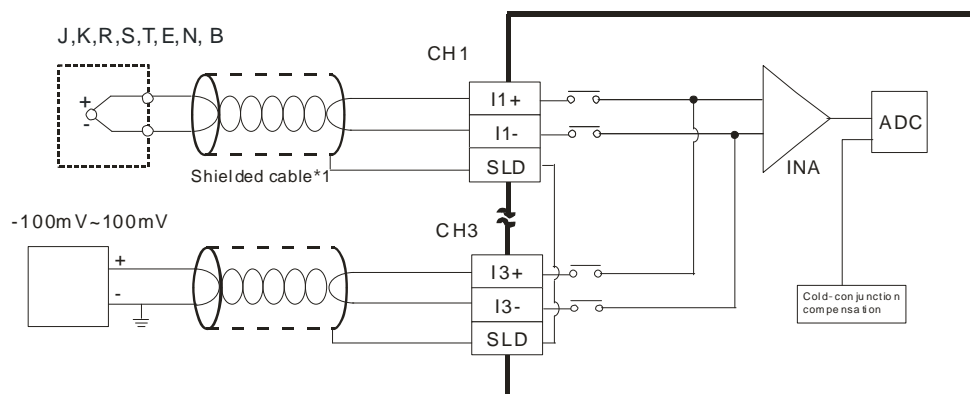

*1. The cable connected to the input terminal should be the cable or the shielded twisted pair cable connected to a type J, K, R, S, T, E, N, B thermocouple. It should be kept separate from other power cables and cables that generate noise.

Note1: do not wire empty terminals.

Note2: only use copper conducting wires with a temperature rating of 60/75°C and the length must be less than 50 m.

Note3: TC modules must run for 30 minutes before they start to take any temperature measurement.

4.11 Wiring Positioning Modules and Counter Modules

4.11.1 Wiring AS02PU-A

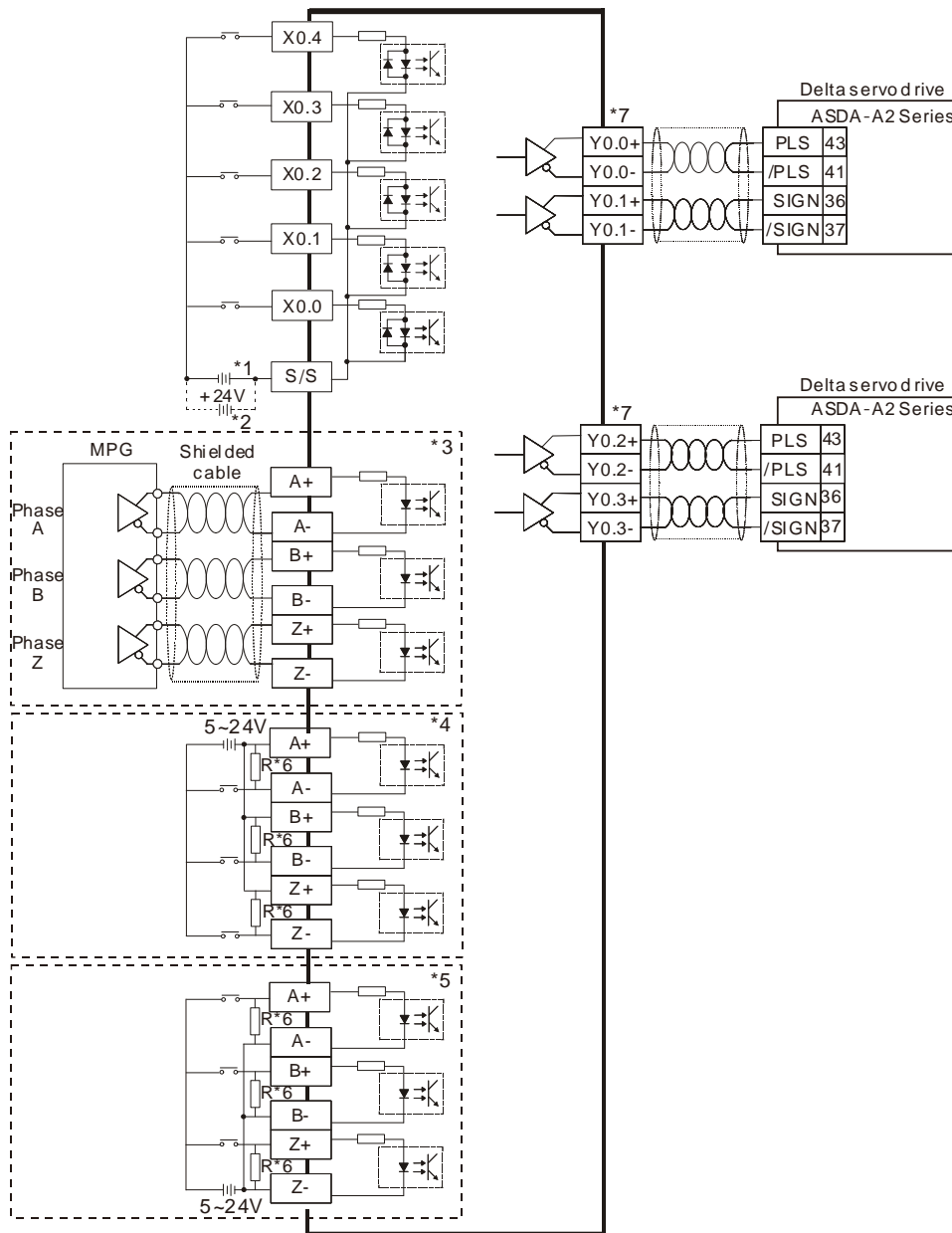

*1. Sinking

*2. Sourcing

*3. Differential input

*4. Open collector sinking

*5. Open collector sourcing

*6. Open collector sinking/sourcing to connect to phase A/B/Z and if the input frequency is higher than 100 kHz, add a 3W/470 ohm resistor between + the positive end and – the negative end.

*7. Refer to API1402 in AS Series Programming Manual and Delta Servo Drive Manual for more information on the output mode.

4.11.2 Wiring AS04PU-A

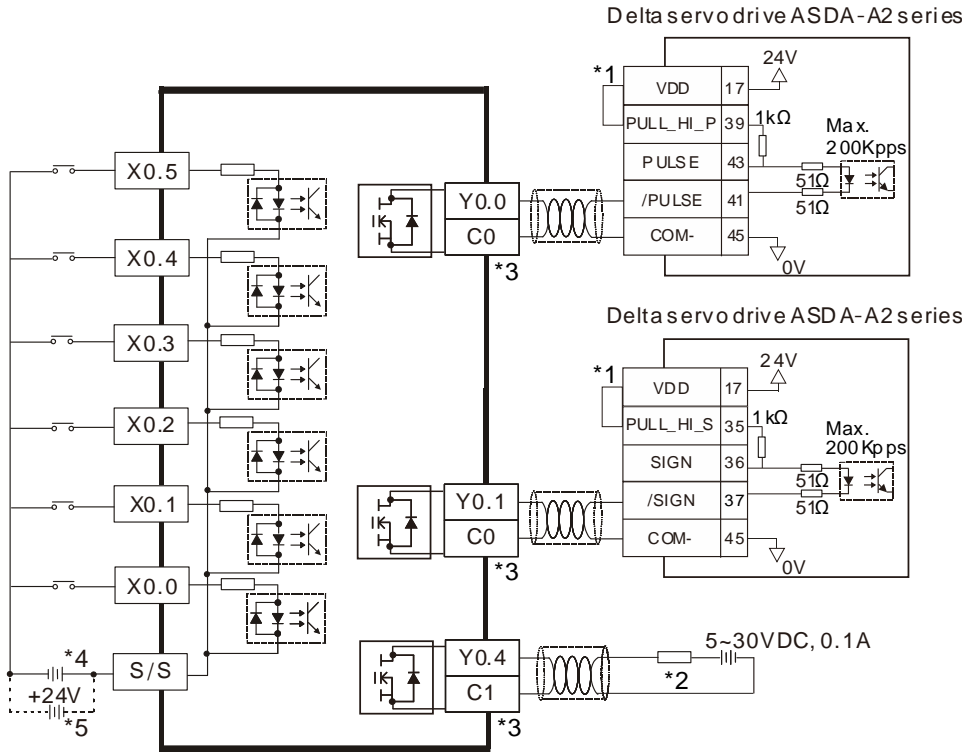

- *1. VDD and COM are seen as a group and its power is provided by Delta servo drive.
- *2. It is a load or an input point.
- *3. Use the same power supply for the same COM group.
- *4. Sinking
- *5. Sourcing

4.11.3 Wiring AS02HC-A

4.11.3.1 Pulse Input

- Sinking

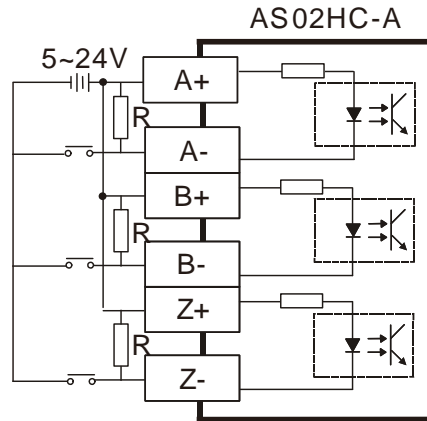

- Sourcing

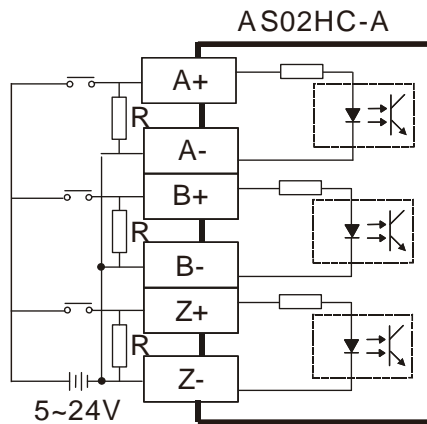

Note: Open collector sinking/sourcing to connect to phase A/B/Z and if the input frequency is higher than 100 kHz, add a 3W/470 ohm resistor between + the positive end and – the negative end.

- 5V differential output encoder

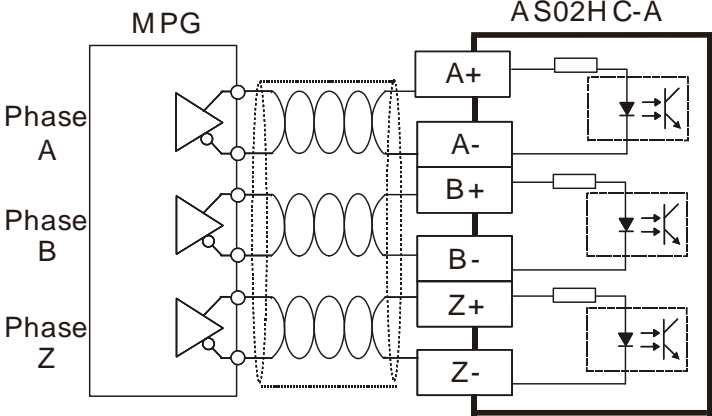

4.11.3.2 SSI Input / Output Encoder

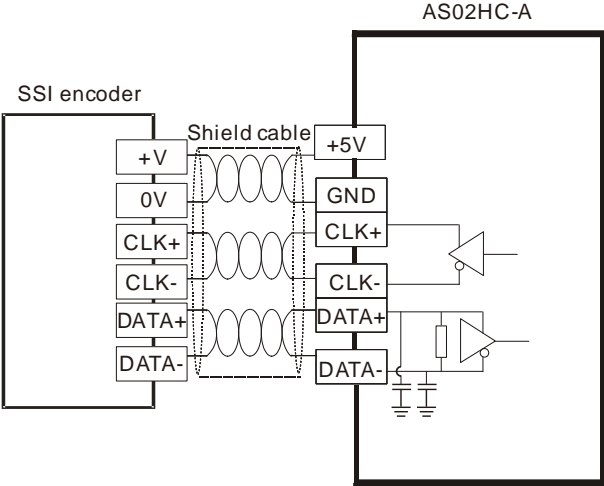

Note: The power supply of the SSI encoder you are using may NOT be 5 VDC, check for the actual power supply of your SSI encoder.

4.11.3.3 External Output

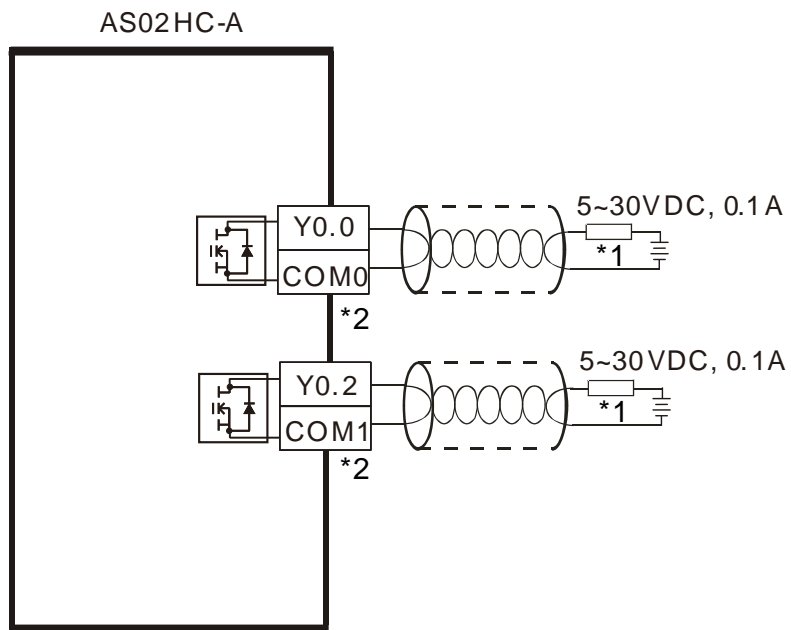

*1: A load or an input point

*2: The same COM should use power from the same supply.

4.12 Load Cell Modules

4.12.1 Wiring AS02LC-A

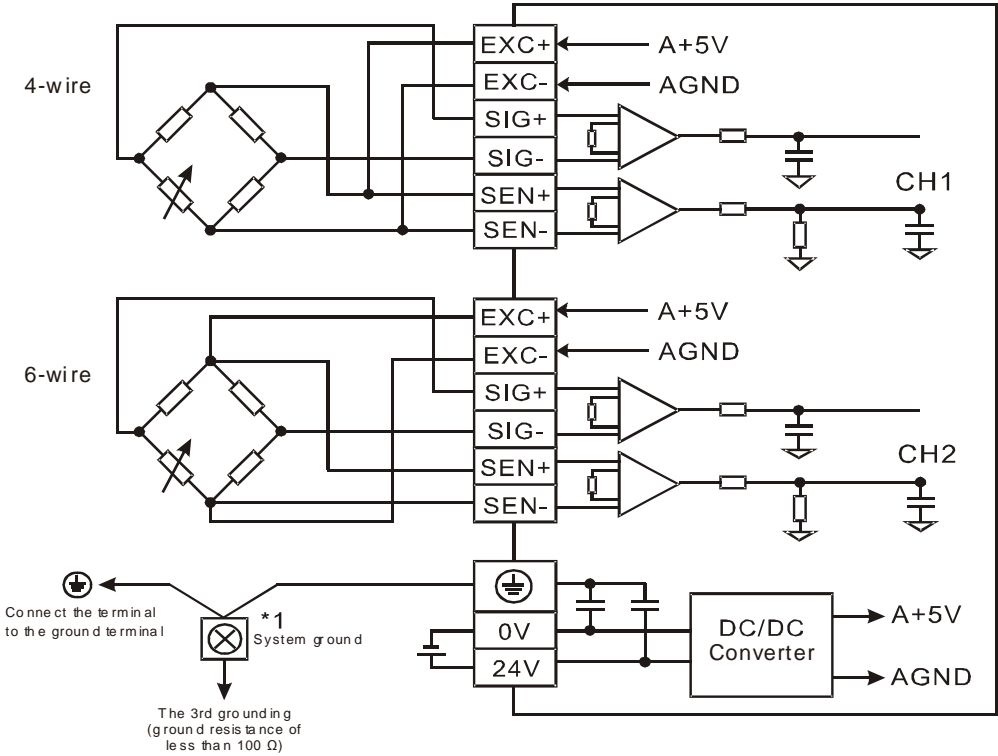

4

- Multiple load cells connected to one load cell module:

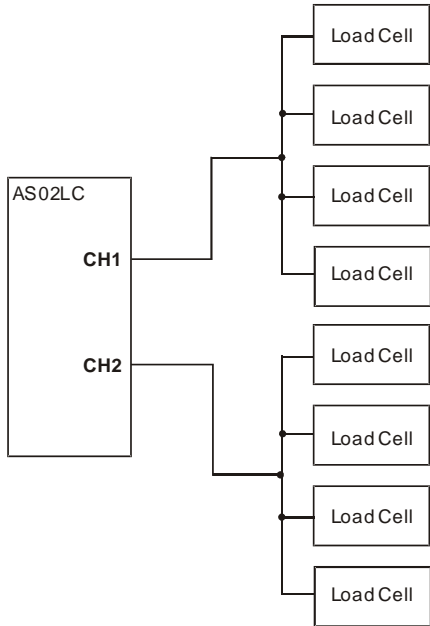

*1. Connect the \oplus of the power module and the \oplus of the load cell module to the system ground terminal. Use the system ground as the third grounding or connect it to the control box.

*2. When connecting multiple load cells, the total resistance of the load cells should be greater than 40 Ω.

4.13 Wiring Network Modules

4.13.1 AS00SCM-A

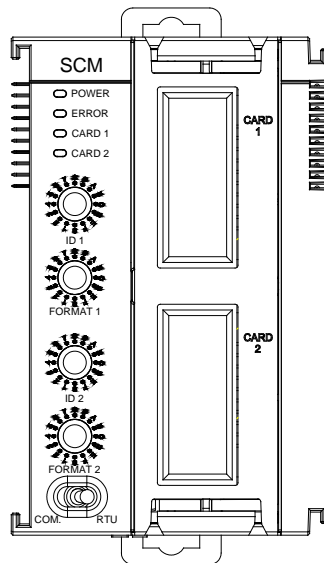

4.13.2 Wiring AS00SCM-A

4.13.2.1 AS00SCM-A module wiring for communication

- COM communication mode
AS00SCM-A module has with two function card slots, CARD1 and CARD2, supporting function cards AS-F232, AS-F422, and AS-F485. Refer to Section 4.14 for wiring.
- RTU remote control mode
The card slot CARD2 supports AS-FCOPM and both CARD1 & CARD2 support AS-FEN02 and AS-PFN02. Refer to Section 4.14 for wiring.

4.13.2.2 AS00SCM-A module wiring for power

- COM: extension via serial ports
Switch the dip switch of the AS00SCM-A module to COM and install the module on the right side of the AS300 series CPU module. To avoid errors, do not supply extra power to this module.
- RTU remote control mode
Switch the dip switch of the AS00SCM-A module to RTU. This module uses an independent direct-current power supply. Note the following when wiring.
 - (1) Keep the input cables, the output cables, and the power cable separate from one another as shown in the following illustration. Use an independent power supply for this module.
 - (2) The 24 VDC cable should be twisted and connected to a module within a short distance. Do not

bundle 110 VAC cable, 220 VAC cable, 24 VDC cable, the (high-voltage high-current) main circuit, and the I/O signal cable together. The distance between adjacent cables should be more than 100 millimeters.

- (3) Use single-wire cables or two-wire cables with a diameter of 20 AWG to 14 AWG. Only use copper conducting wires with a temperature rating of 60/75°C.

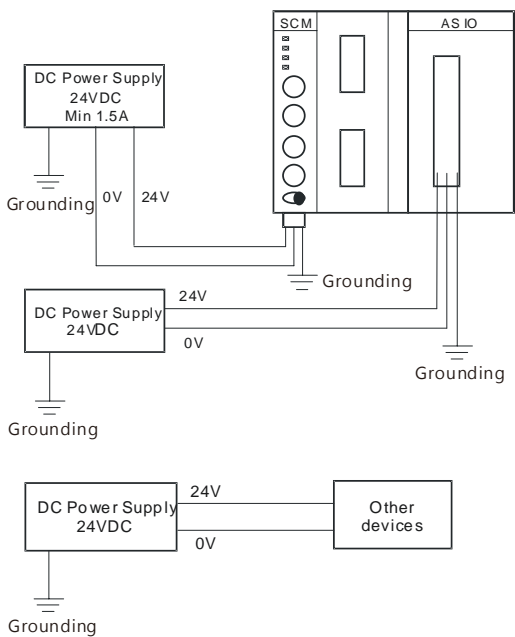

4.13.3 AS01DNET-A

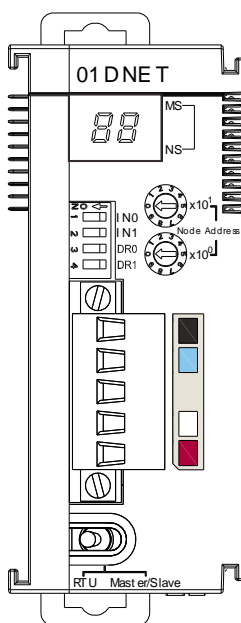

4.13.4 Wiring AS01DNET-A

The network requires one or multiple supply powers to supply the power to each piece of network equipment via the bus cable. Delta DeviceNet communication cable consists of five wires, among which the power cable and signal cable occupy two wires respectively and the one on the left is the shielded wire as the above figure shows. The supply power for the bus is optional and could be a single supply power or multiple supply powers according to the actual demand.

- **Single Supply Power**

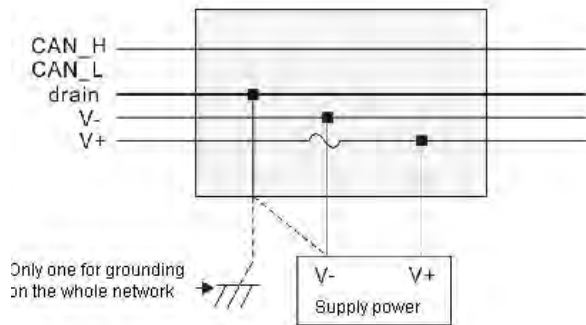

- **Multiple Supply Powers**

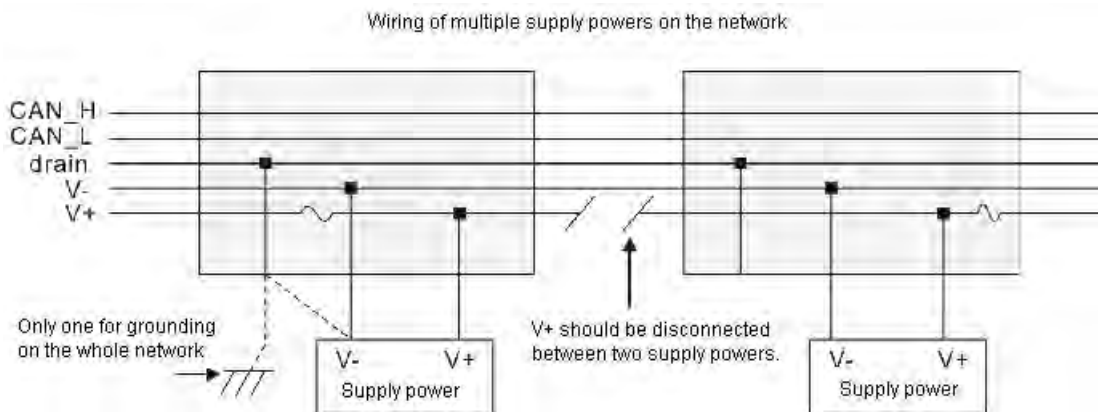

4.13.5 AS04SIL-A

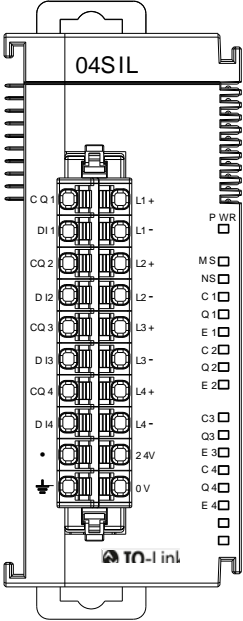

4.13.6 Wiring AS04SIL-A

4.13.6.1 IO-Link mode communication and power wiring

- (1) Keep the input cables, output cables, and power cable separate from one another. It is suggested to use independent power for AS04SIL-A. See the example below.

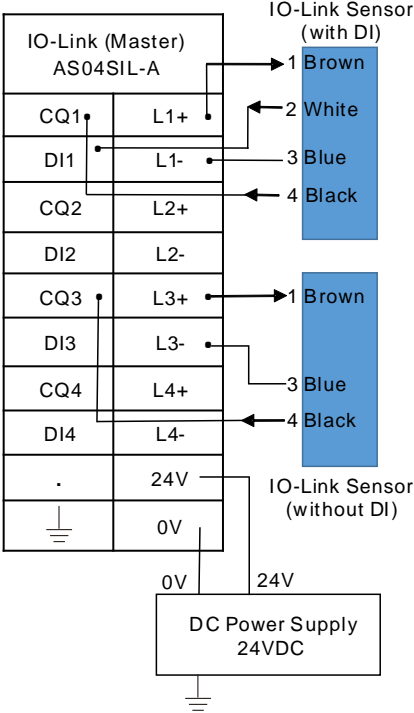

- (2) The 24 VDC cable should be twisted and connected to a module within a short distance.
- (3) Do not bundle 110 VAC cable, 220 VAC cable, 24 VDC cable, the (high-voltage high-current) main circuit, and the I/O signal cable together. The distance between adjacent cables should be more than 100 millimeters.
- (4) Connect a cable with a diameter of 14 AWG or higher to ground.
- (5) Use single-wire cables or two-wire cables with a diameter of 20 AWG to 14 AWG. Only use copper conducting wires with a temperature rating of 60/75°C.

4.13.6.2 Digital Input Wiring (SIO Mode)

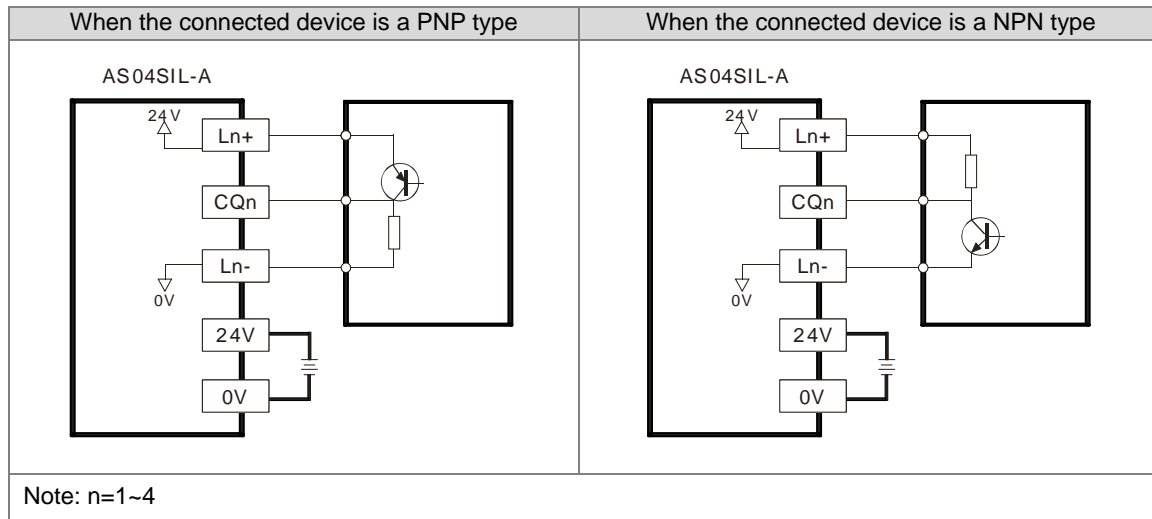

4.13.6.3 Digital Output Wiring (SIO Mode)

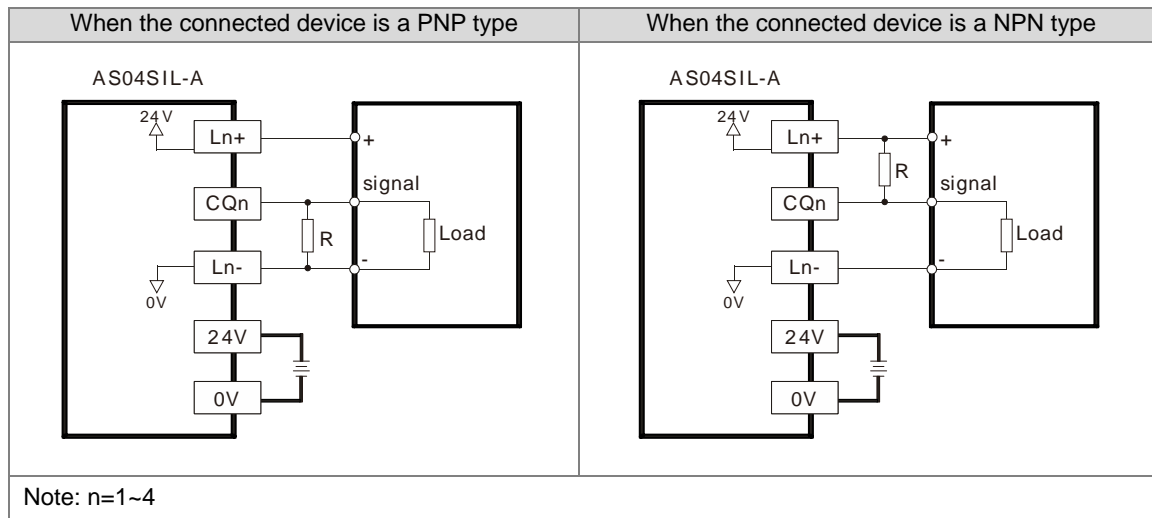

4.13.6.4 Digital Input Wiring

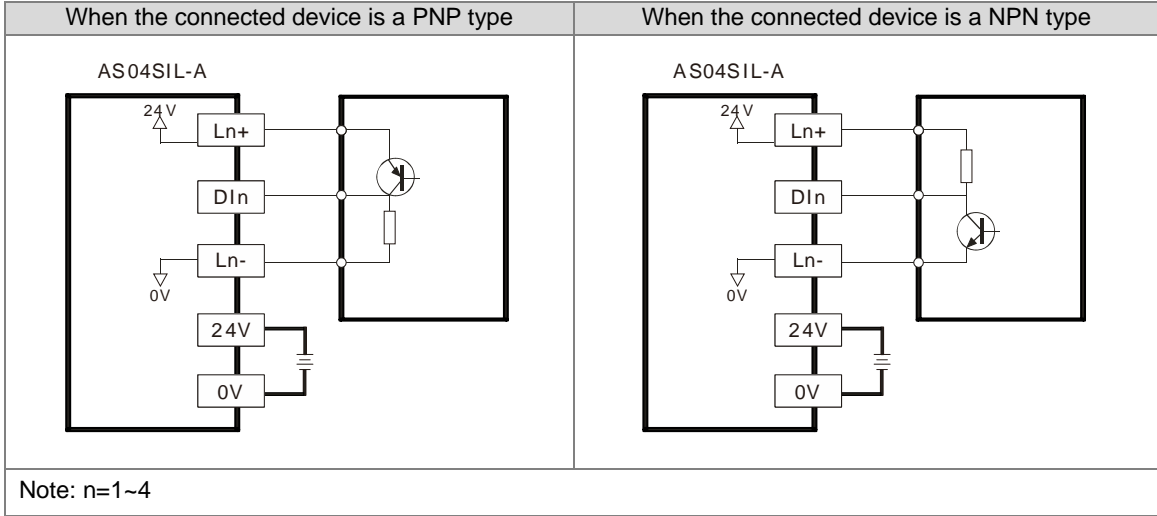

4.14 Wiring Function Cards

4.14.1 Communicational Function Card Profiles and the Pin Definitions

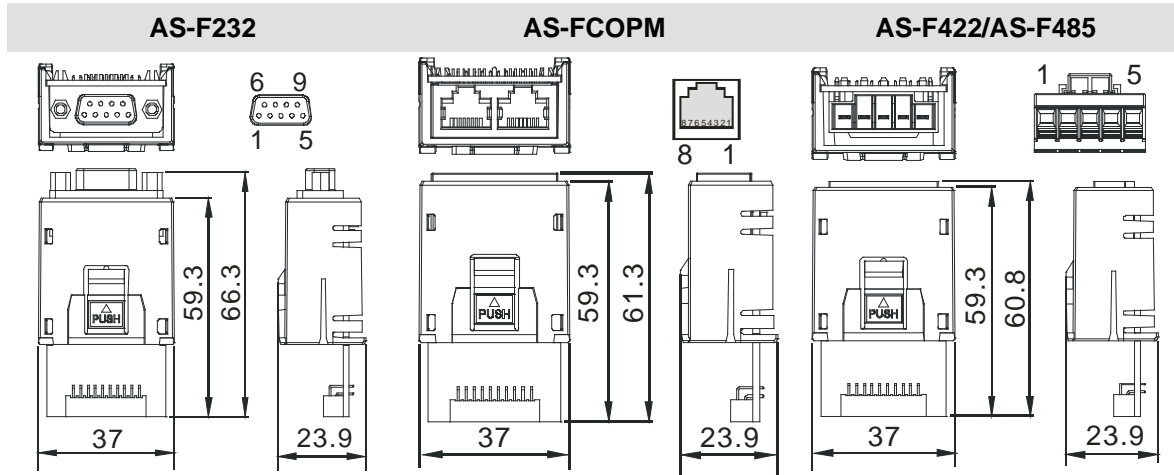

Pin no.	AS-F232	AS-FCOPM	AS-F422	AS-F485
1	-	CAN_H	R+	-
2	TX	CAN_L	R-	-
3	RX	GND	T+	D+
4	-	-	T-	D-
5	GND	-	SG	SG
6-9	-	-		

AS-FEN02 / AS-PPFN02 / AS-FECAT

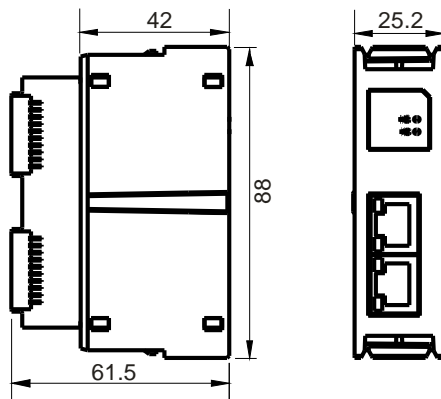

1 TX+	2 TX-	3 RX+	4 N/C	
5 N/C	6 RX-	7 N/C	8 N/C	

● AS-FFTP01

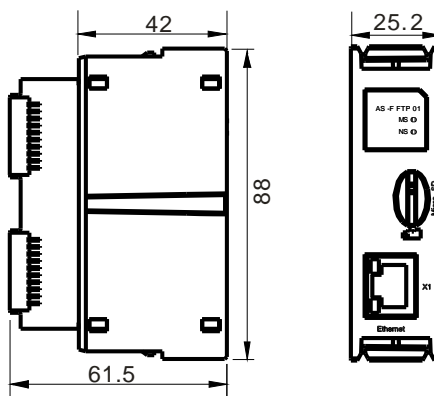

1 TX+	2 TX-	3 RX+	4 N/C	 8-1
5 N/C	6 RX-	7 N/C	8 N/C	

4.14.2 Wiring the Communicational Function Cards

■ AS-F232 wiring example:

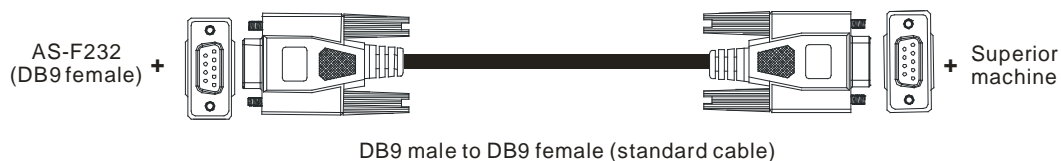

■ AS-F422 wiring example:

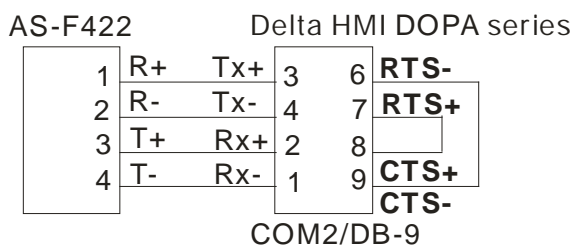

■ AS-F485 wiring example:

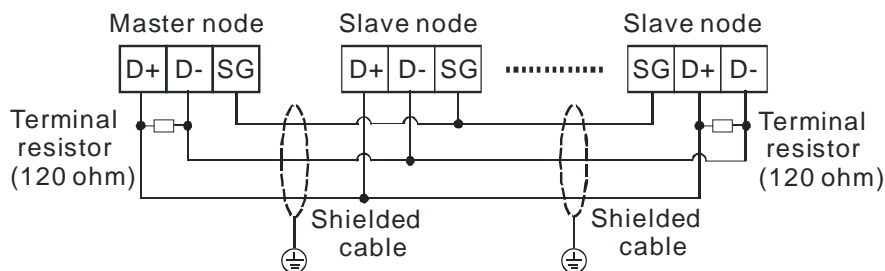

■ AS-FCOPM wiring example:

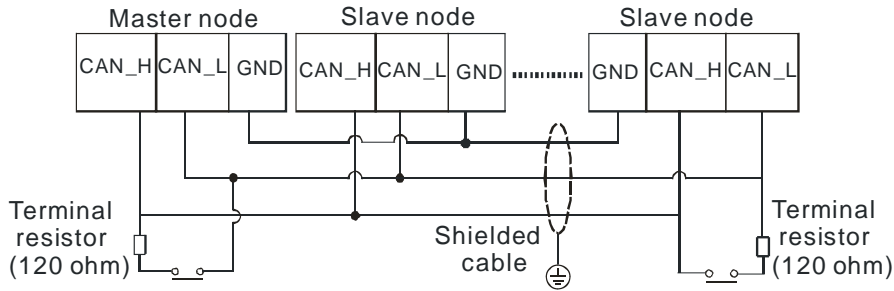

■ AS-FEN02 wiring example:

● Linear Topology

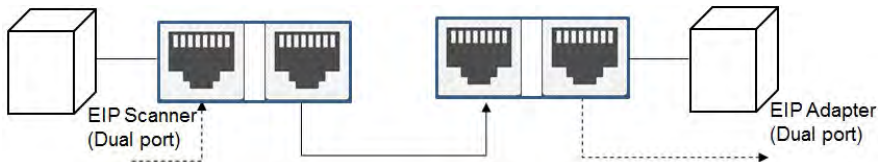

● Star Topology

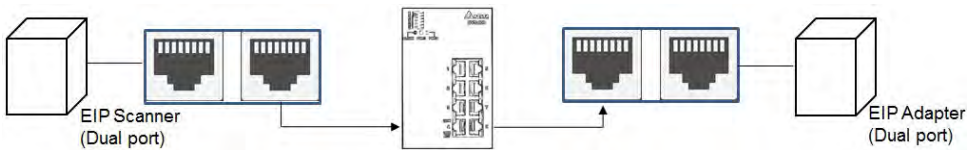

● Ring Topology

A DLR function is required to create a ring topology.

When a switch is needed for topology, the switch should support the DLR function. If not, the connection might fail.

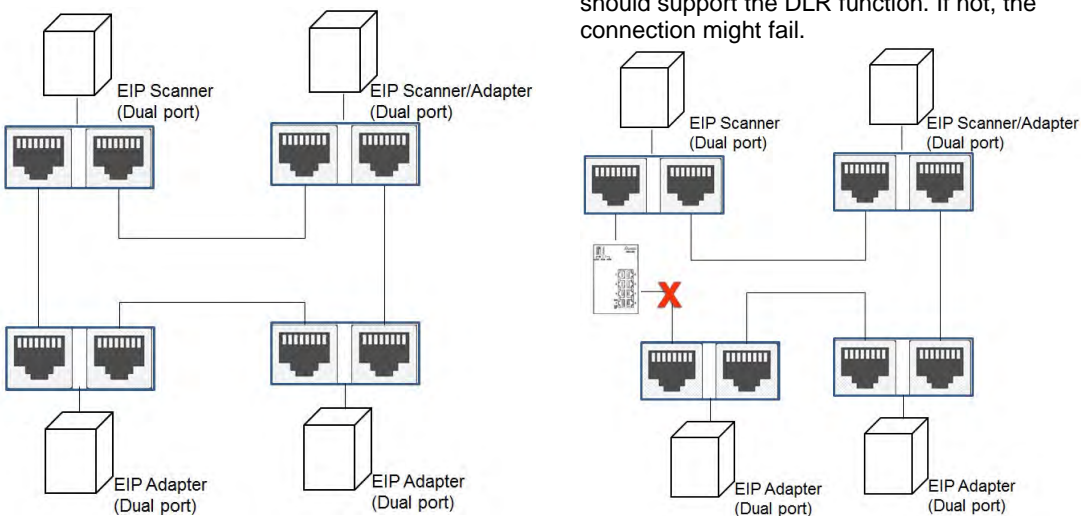

■ AS-FPFN02 wiring example:

● Linear Topology

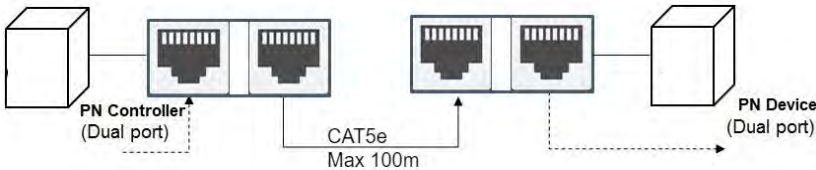

● Star Topology

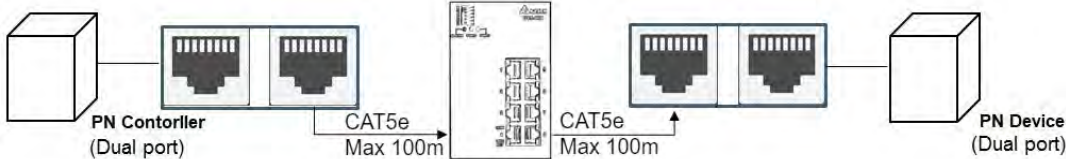

■ AS-FECAT (EtherCAT OFF)

● Linear Topology



● Star Topology

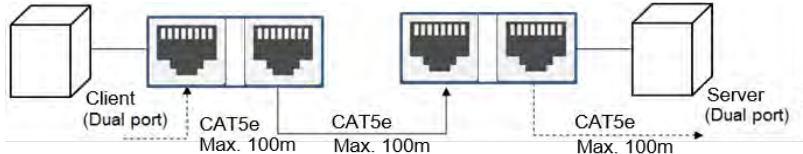

■ AS-FECAT sets EtherCAT Master Port via HWCONFIG (EtherCAT ON)

● Use Port x1 as EtherCAT Master

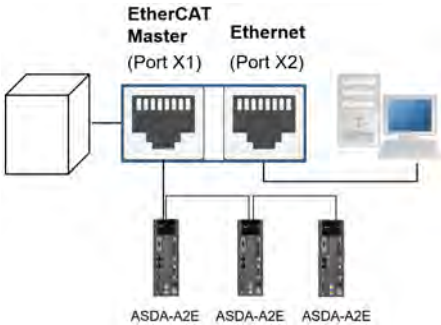

- Use Port x2 as EtherCAT Master

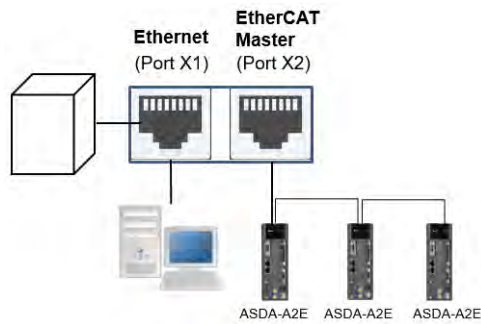

4.14.3 Analog Function Card Profiles and the Pin Definitions

4

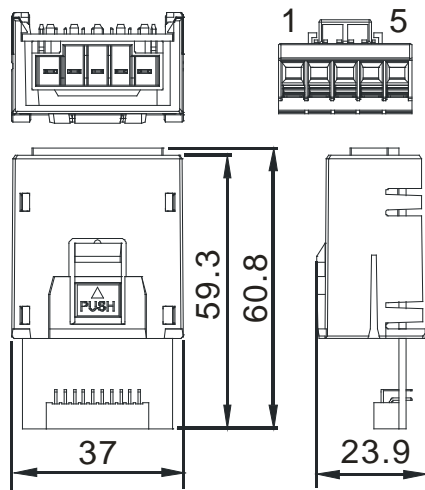

Pin no.	AS-F2AD	AS-F2DA
1	V1+	VO1
2	I1+	IO1
3	V2+	VO2
4	I2+	IO2
5	COM	COM

4.14.4 Wiring AS-F2AD

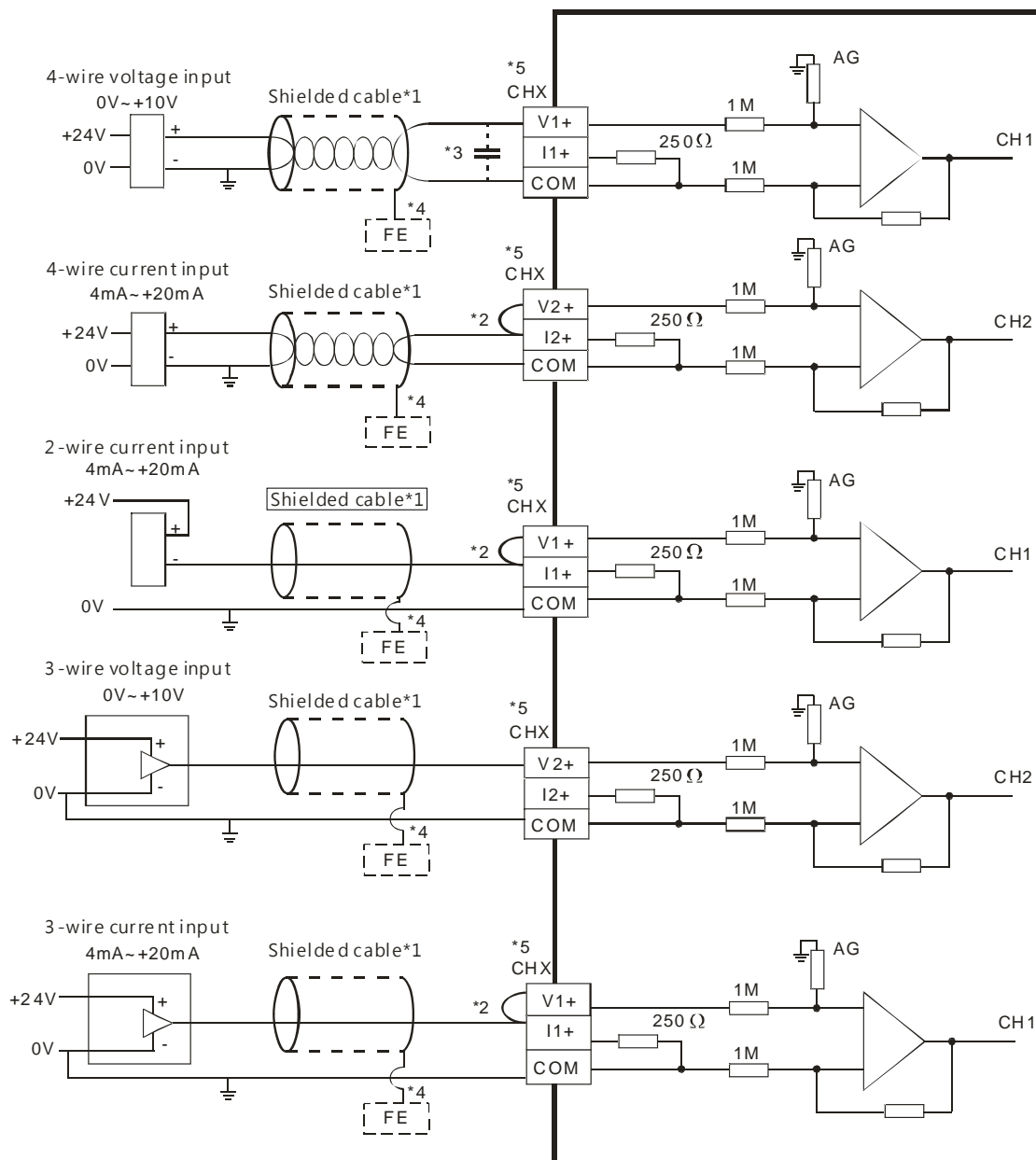

- *1. Use shielded cables to isolate the analog input signal cable from other power cables.
- *2. If the module is connected to a current signal, the terminals V_n and I_{n+} ($n=1-2$) must be short-circuited.
- *3. If noise in the input voltage results in noise interference in the wiring, connect the module to a capacitor with a capacitance between 0.1–0.47 μF with a working voltage of 25 V.
- *4. Connect FE of the shielded cable to ground.
- *5. CHX: Every channel can work with the input wiring shown above.

4.14.5 Wiring AS-F2DA

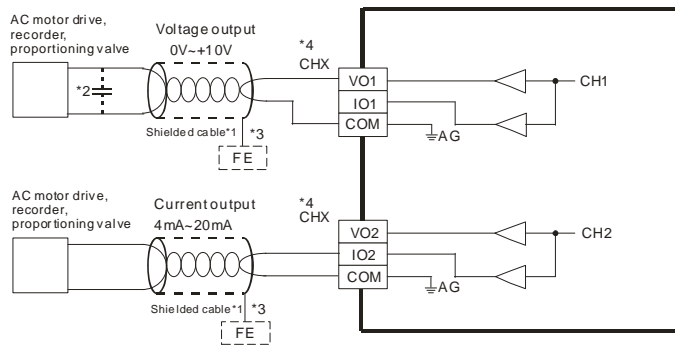

- *1. Use shielded cables to isolate the analog input signal cable from other power cables.
- *2. If noise in the input voltage results in noise interference in the wiring, Connect the module to a capacitor with a capacitance between 0.1–0.47 μF with a working voltage of 25 V.
- *3. Connect FE of the shielded cable to ground.
- *4. CHX: Every channel can work with the input wiring shown above.

Chapter 5 Devices

Table of Contents

5.1 Introduction of Devices	5-2
5.1.1 Device Table	5-2
5.1.2 Basic Structure of I/O Storages.....	5-3
5.1.3 Relation Between the PLC Action and the Device Type.....	5-4
5.1.4 Latched Areas in the Device Range.....	5-5
5.2. Device Functions	5-6
5.2.1 Values and Constants	5-6
5.2.2 Floating-point Numbers.....	5-9
5.2.3 Strings	5-11
5.2.4 Input Relays (X)	5-12
5.2.5 Output Relays (Y)	5-13
5.2.6 Auxiliary Relays (M)	5-13
5.2.7 Special Auxiliary Relays (SM).....	5-13
5.2.8 Stepping Relays (S)	5-14
5.2.9 Timers (T)	5-14
5.2.10 16-bit Counters	5-16
5.2.11 32-bit Counters (HC)	5-18
5.2.12 Data Registers (D)	5-20
5.2.13 Special Data Registers (SR).....	5-21
5.2.14 Index Register (E).....	5-21
5.2.15 File Registers (FR).....	5-21
5.3. Assigning I/O Addresses for Modules.....	5-22
5.4 Module Addresses Defined by Software.....	5-23
5.4.1 Starting Addresses for Digital Input/Output Modules	5-23
5.4.2 Starting Addresses for Analog Input/Output Modules.....	5-24
5.4.3 Starting Addresses for Temperature Measurement Modules.....	5-25
5.4.4 Starting Addresses for Positioning/Counter Modules.....	5-25
5.4.5 Starting Addresses for Network Modules.....	5-26
5.4.6 Starting Addresses for Load Cell Modules	5-27
5.5 Remote Module Addresses Defined by Software	5-28
5.5.1 Starting Addresses for Digital Input/Output Modules	5-31
5.5.2 Starting Addresses for Analog Input/Output Modules.....	5-32
5.5.3 Starting Addresses for Temperature Measurement Modules.....	5-33
5.5.4 Starting Addresses for Load Cell Modules	5-33
5.5.5 Starting Addresses for AS04SIL-A Modules	5-34

5.1 Introduction of Devices

This section describes the values and strings processed by the PLC. It also describes the functions of devices that include input, output, and auxiliary relays, as well as timers, counters, and data registers. The PLC simulates external devices in the PLC's internal memory, so the word "device" is a generic name that refers to all the internal memory locations in the PLC. A device can be a bit device or a word device. Bit devices simulate coils, contacts and flags, while word devices simulate registers.

5.1.1 Device Table

Type	Device name		Number of devices	Range
Bit device	Input relay	X	1024	X0.0–X63.15
	Output relay	Y	1024	Y0.0–Y63.15
	Data register	D	48,0000	D0.0–D29999.15
		W	48,0000	W0.0–W29999.15 *4
	Auxiliary relay	M	8192	M0–M8191
	Special auxiliary relay	SM	4096	SM0–SM4095
	Relay	S	2048	S0–S2047
	Timer	T	512	T0–T511
	Counter	C	512	C0–C511
	32-bit counter	HC	256	HC0–HC255
Word device	Input relay	X	64	X0–X63
	Output relay	Y	64	Y0–Y63
	Data register	D	30000	D0–D29999
		W	30000	W0–W29999 *4
	Special auxiliary relay	SR	2048	SR0–SR2047
	File register	FR	65536	FR0–FR65535
	Timer	T	512	T0–T511
	Counter	C	512	C0–C511
	32-bit counter	HC	256 (512 words)	HC0–HC255
	Index register	E	10	E0–E9
5			E10–E14 *4	
Constant*1	Decimal system	K	16 bits: -32768 to 32767 32 bits: -2147483648 to 2147483647	

Type	Device name		Number of devices	Range
Constant*2	Hexadecimal system	16#	16 bits: 16#0–16#FFFF 32 bits: 16#0–16#FFFFFFFF	
	Single-precision floating-point number	F	32 bits: $\pm 1.17549435^{38}$ to $\pm 3.40282347^{38}$	
String*3	String	"\$"	1–31 characters	

*1: Constants are indicated by K in the device lists in Chapter 5 and Chapter 6 in the AS Series Programming Manual. An example when "K50" appears in the AS Series Programming Manual, enter only the number 50 in ISPSof / DIADesigner.

*2: Floating-point numbers are indicated by F/DF in the device lists in Chapter 5 and Chapter 6 in the AS Series Programming Manual, but they are represented by decimal points in ISPSof. For example, for the floating-point number F500, enter 500.0 in ISPSof / DIADesigner.

*3: Strings are indicated by "\$" in Chapter 5 and Chapter 6 in the AS Series Programming Manual, but they are represented by quotes (" ") in ISPSof / DIADesigner. For example, for the string 1234, enter "1234" in ISPSof / DIADesigner.

*4: This is used for editing in ISPSof only.

5.1.2 Basic Structure of I/O Storages

Device	Function	Access by bits	Access by words	Modify by ISPSof / DIADesigner	Force the bit ON/OFF
X	Input relay	OK	OK	OK	OK
Y	Output relay	OK	OK	OK	OK
M	Auxiliary relay	OK	-	OK	-
SM	Special auxiliary relay	OK	-	OK	-
S	Relay	OK	-	OK	-
T	Timer	OK	OK	OK	-
C	Counter	OK	OK	OK	-
HC	32-bit counter	OK	OK	OK	-
D	Data register	OK	OK	OK	OK
SR	Special data register	-	OK	OK	-
FR	File register	-	OK*1	-	-

Device	Function	Access by bits	Access by words	Modify by ISPSOft / DIADesigner	Force the bit ON/OFF
E	Index register	-	OK	OK	-

*1: Use an instruction for writing to an FR.

5.1.3 Relation Between the PLC Action and the Device Type

PLC action		Device type		Non-latched area		Latched area	
		Device Y	Other devices	File register	Other devices		
Power: OFF→ON		Cleared	Cleared	Retained	Retained		
Restore to defaults		Cleared	Cleared	Cleared	Cleared		
STOP ↓ RUN*1	This clears the non-latched area state.	Cleared	Cleared	Retained	Retained		
	This retains the non-latched area state.	Retained	Retained	Retained	Retained		
RUN ↓ STOP*1	This clears the device Y.	SM203 = OFF	Cleared	Retained	Retained	Retained	Retained
	This retains the device Y.	SM203 = OFF	Retained	Retained	Retained	Retained	Retained
	This clears the device Y.	SM203 = ON*3	Cleared	Cleared	Retained	Retained	Retained
	This retains the device Y.	SM203 = ON	Retained	Cleared	Retained	Retained	Retained
SM204 is ON. This clears all non-latched areas.*2			Cleared	Cleared	Retained	Retained	Retained
SM205 is ON. This clears all latched areas.*2			Retained	Retained	Retained	Retained	Cleared

*1: For state setups, see HWCONFIG in ISPSOft. The PLC STOP->RUN default is “clear the non-latched area state”. The PLC RUN->STOP default is “clear the state of device Y”.

*2: The timing for clearing the SM is when SM turns from OFF to ON. After PLC completes clearing, the system turns SM from ON to OFF.

*3: When SM203 is ON, the system clears all non-latched area once when PLC is from RUN to STOP, available for AS PLC CPU with FW V1.08.30 or later.

5.1.4 Latched Areas in the Device Range

Device	Function	Device range	Latched area
X	Input relay	X0–X63	All devices are non-latched.
Y	Output relay	Y0–Y63	All devices are non-latched.
M*1	Auxiliary relay	M0–M8191	The default range is M6000–M8191.
SM	Special auxiliary relay	SM0–SM2047	Some devices are latched and cannot be changed. Refer to the list of special auxiliary relays for more information.
S*1	Relay	S0–S1023	The default range is S512–S1023
T	Timer	T0–T511	All devices are non-latched.
C*1	Counter	C0–C511	The default range is C448–C511
HC*1	32-bit counter	HC0–HC255	The default range is HC128–HC255
D*1	Data register	D0–D29999	The default range is D20000–D23999
		W0–W29999	Use this for editing in ISPSOft only.
FR	File register	FR0–FR65535	All devices are latched.
SR	Special data register	SR0–SR2047	Some are latched and cannot be changed. Refer to the list of special data registers for more information.
E	Index register	E0–E9	All devices are non-latched.
		E10–E14	Use this for editing in ISPSOft only.

*1: For the latched area setups, see HWCONFIG in ISPSOft. Setting the latched area means the other areas show as non-latched areas. The range of latched areas cannot exceed the device range. For example, if you set the M600–M7000 as latched areas, M0–M5999 and M7001–M8191 become non-latched areas.

5.2. Device Functions

Procedure for processing the program in the PLC:

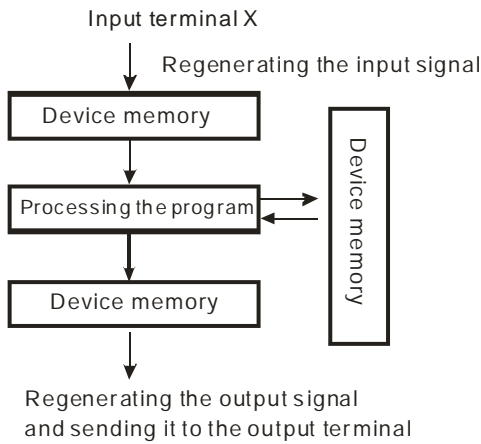

- Regenerating the input signal
 1. Before executing the program, the external input signal state is read into the memory for the input signal.
 2. When the program is executed, the state in the memory location for the input signal does not change even if the input signal changes from ON to OFF or from OFF to ON. The input signal is not refreshed until the next scan begins.
- Processing the program

After the input signal is refreshed, the instructions in the program are executed in order from the starting address of the program. The results are stored in the device memories.
- Regenerating the state of the output

After the instruction END is executed, the device memory state in the device memory is sent to the specified output terminal.

5.2.1 Values and Constants

Name	Description
Bit	A bit is the basic unit in the binary system. Its state is either 1 or 0.
Nibble	A nibble is composed of four consecutive bits (for example b3–b0). Nibbles can represent 0–9 in the decimal system or 0–F in the hexadecimal system.
Byte	A byte is composed of two consecutive nibbles (i.e. 8 bits, b7–b0). Bytes can represent 00–FF in the hexadecimal system.
Word	A word is composed of two consecutive bytes (i.e. 16 bits, b15–b0). Words can represent 0000–FFFF in the hexadecimal system.
Double word	A double word is composed of two consecutive words (i.e. 32 bits, b31–b0). Double words can represent 00000000–FFFFFFFF in the hexadecimal system.

The relation among bits, nibbles, bytes, words, and double words in the binary system is shown below.

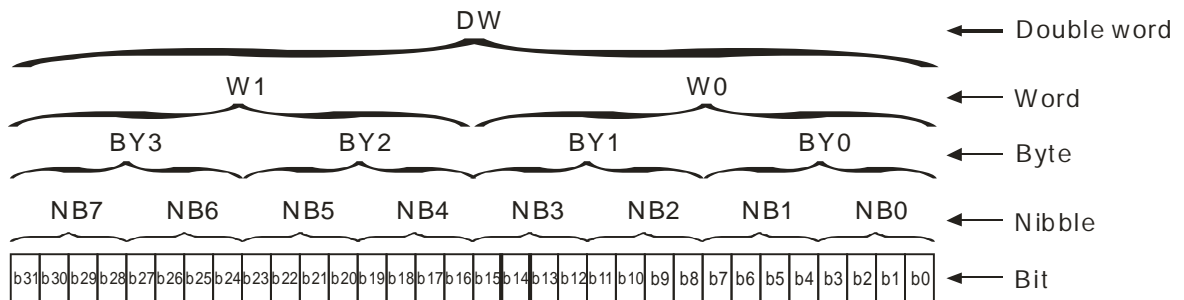

The PLC uses four types of values to execute the operation according to different control purposes. The following illustrates the values of these functions.:

1. Binary number (BIN)

The PLC uses the binary system to operate the values.

2. Decimal number (DEC)

The PLC uses decimal numbers for;

- The setting value of a timer (T) or the setting value of a counter (C/HC); for example, TMR C0 50 (**constant K**).
- The device number; for example, M10 and T30 (device number)
- The number before or after the decimal point; for example, X0.0, Y0.11, and D10.0 (device number).
- **The constant K:** used as the operand in an applied instruction. For example, MOV 123 D0 (**constant K**).

3. Binary-coded decimal (BCD)

A decimal value is represented by a nibble or four bits, so that sixteen consecutive bits represent a four-digit decimal value.

4. Hexadecimal number (HEX)

The PLC uses hexadecimal numbers for;

- **the constant 16#:** used as the operand in an applied instruction; for example, MOV 16#1A2B D0 (hexadecimal constant).

The following table shows the corresponding values.

Binary Number (BIN)	Decimal Number (DEC)	Binary Code Decimal (BCD)	Hexadecimal Number (HEX)
PLC internal execution	Constant K, Device number	BCD related instruction	Instant 16#, Device number
0000	0	0000	0
0001	1	0001	1
0010	2	0010	2
0011	3	0011	3
0100	4	0100	4
0101	5	0101	5
0110	6	0110	6
0111	7	0111	7
1000	8	1000	8
1001	9	1001	9
1010	10	-	A
1011	11	-	B
1100	12	-	C
1101	13	-	D
1110	14	-	E
1111	15	-	F
10000	16	0001 0000	10
10001	17	0001 0001	11

5.2.2 Floating-point Numbers

The floating-point numbers are represented by decimal points in ISPSOft / DIADesigner. For example, the floating-point number of 500 is 500.0. Refer to Section 2.2.2 in the AS Series Programming Manual for more information.

5.2.2.1 Single-precision Floating-point Numbers

Floating-point numbers are represented by the 32-bit register. The representation adopts the IEEE754 standard, and the format is as follows.

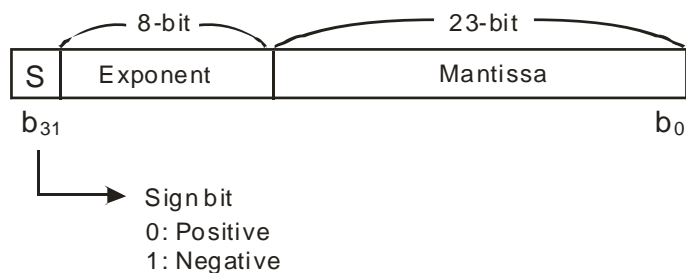

$$\text{Equation: } (-1)^S \times 2^{E-B} \times 1.M; B = 127$$

The single-precision floating-point numbers range from $\pm 2^{-126}$ to $\pm 2^{+128}$, and correspond to the range from $\pm 1.1755 \times 10^{-38}$ to $\pm 3.4028 \times 10^{+38}$.

The AS series PLC uses two consecutive registers to form a 32-bit floating-point number. Take (D1, D0) for example.

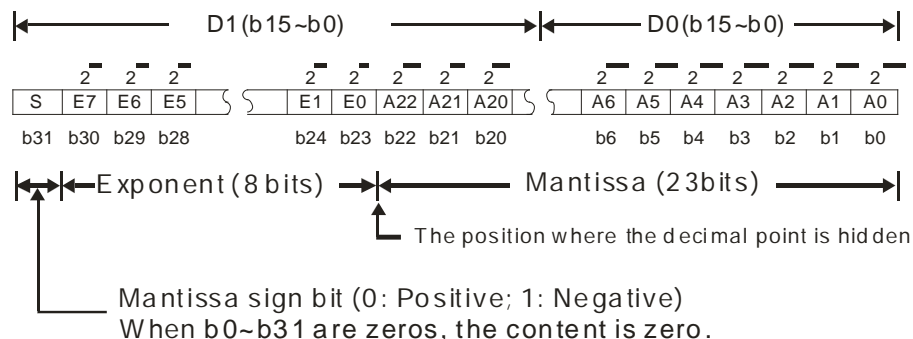

Example 1:

23 is represented by a single-precision floating-point number.

Step 1: Convert 23 into the binary number, i.e. $23.0 = 10111$.

Step 2: Normalize the binary number, i.e. $10111 = 1.0111 \times 2^4$ (0111 is the mantissa, and 4 is the exponent.).

Step 3: Get the value of the exponent.

$$\because E-B=4 \rightarrow E-127=4 \therefore E=131=100000112$$

Step 4: Combine the sign bit, the exponent, and the mantissa to form the floating-point number.

$$0\ 10000011\ 011100000000000000000000_2 = 41B80000_{16}$$

Example 2:

-23 is represented by a single-precision floating-point number.

Converting -23.0 into the floating-point number uses the same steps as converting 23.0 into the floating-point number, except that the sign bit is 1.

$$1\ 10000011\ 011100000000000000000000_2 = C1B80000_{16}$$

5.2.2.2 Decimal Floating-point Numbers

-23 is represented by a single-precision floating-point number.

Converting -23.0 into the floating-point number uses the same steps as converting 23.0 into the floating-point number, except that the sign bit is 1.

$$1\ 10000011\ 011100000000000000000000_2 = C1B80000_{16}$$

5.2.2.2 Decimal Floating-point Numbers

- Single-precision floating-point numbers and double-precision floating-point numbers can be converted into decimal floating-point numbers so people can read them. However, the PLC uses single-precision floating-point numbers and double-precision floating-point numbers internally.
- A 32-bit decimal floating-point number is represented by two consecutive registers. The constant is stored in the register whose number is smaller while the exponent is stored in the register whose number is bigger. Take (D1, D0) for example.

$$\text{Decimal floating-point number} = [\text{Constant } D0] * 10^{[\text{Exponent } D1]}$$

Base number D0 = ±1,000 to ±9,999

Exponent D1 = -41 to +35

The base number 100 does not exist in D0 because 100 is represented by $1,000 \times 10^{-1}$. 32-bit decimal floating-point numbers range from $\pm 1175 \times 10^{-41}$ to $\pm 402 \times 10^{+35}$.

5

5.2.3 Strings

The PLC can process strings composed of ASCII codes (*1). A complete string begins with a start character and ends with an ending character (NULL code). Strings can be a maximum of 31 characters, and the ending character 16#00 is added automatically in ISPSOft / DIADesigner.

1. No string (NULL code) is moved.

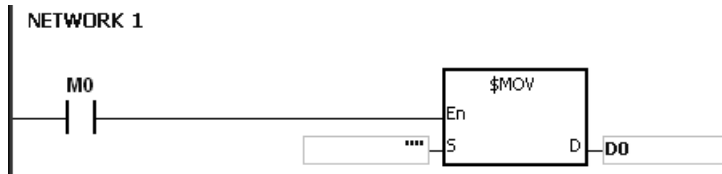

D0=0 (NULL)

2. The string has an even number of characters.

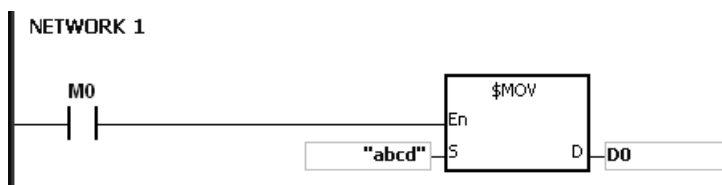

D0	16#62 (b)	16#61 (a)
D1	16#64 (d)	16#63 (b)
D2	0 (NULL)	

3. The string has an odd number of characters.

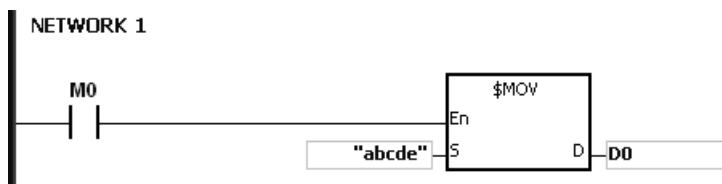

D0	16#62 (b)	16#61 (a)
D1	16#64 (d)	16#63 (b)
D2	0 (NULL)	16#65 (e)

*1: ASCII code chart

Hex	0	1	2	3	4	5	6	7	8	9	A	B	C	D	E	F
ASCII	☒	☒	☒	☒	☒	☒	☒	☒	☒	☒	☒	☒	☒	☒	☒	☒
Hex	10	11	12	13	14	15	16	17	18	19	1A	1B	1C	1D	1E	1F
ASCII	☒	☒	☒	☒	☒	☒	☒	☒	☒	☒	☒	☒	☒	☒	☒	☒
Hex	20	21	22	23	24	25	26	27	28	29	2A	2B	2C	2D	2E	2F
ASCII	SP	!	"	#	\$	%	&	()	*	+	·	-	.	/	
Hex	30	31	32	33	34	35	36	37	38	39	3A	3B	3C	3D	3E	3F
ASCII	0	1	2	3	4	5	6	7	8	9	:	;	<	=	>	?
Hex	40	41	42	43	44	45	46	47	48	49	4A	4B	4C	4D	4E	4F
ASCII	@	A	B	C	D	E	F	G	H	I	J	K	L	M	N	O
Hex	50	51	52	53	54	55	56	57	58	59	5A	5B	5C	5D	5E	5F
ASCII	P	Q	R	S	T	U	V	W	X	Y	Z	☒	☒	☒	☒	☒
Hex	60	61	62	63	64	65	66	67	68	69	6A	6B	6C	6D	6E	6F
ASCII	`	a	b	c	d	e	f	g	h	i	j	k	l	m	n	o
Hex	70	71	72	73	74	75	76	77	78	79	7A	7B	7C	7D	7E	7F
ASCII	p	q	r	s	t	u	v	w	x	y	z	{		}	~	☒

Note: ☒ represents an invisible character. Please do not use it.

5.2.4 Input Relays (X)

- Input function

The input is connected to the input device (external devices such as button switches, rotary switches, and number switches), and PLC reads the input signal. You can use input contact A or contact B several times in the program, and the ON/OFF input state varies with the ON/OFF input device state.

- Input number (the decimal number):

For the PLC, the input numbers start from X0.0. The number of inputs varies with the number of inputs on the digital input/output modules. The inputs are numbered according to the order in which the digital input/output modules are connected to the CPU module. The maximum number of inputs for the PLC is 8192, and the input number range is between X0.0 and X511.15.

- Input type: Inputs are classified into two types.

1. Regenerated inputs: PLC reads the state of a regenerated input before the program is executed. For example, LD X0.0.
2. Direct input: The state of a direct input is read by the PLC during the execution of the instructions. For example, LD DX0.0.

5.2.5 Output Relays (Y)

- Output function

The output sends the ON/OFF signal to drive the load connected to the output, such as an external signal lamp, a digital display, or an electromagnetic valve. There are four types of outputs: relays, transistors (NPN and PNP), and TRIACs (thyristors). You can use the output contact A or contact B several times in the program. Use output Y only once in the program; otherwise, according to the PLC's program-scanning principle, the state of the output depends on the circuit connected to the last output Y in the program.

- Output number (the decimal number)

For the PLC, the output numbers start from Y0.0. The number of outputs varies with the number of outputs on the digital input/output modules. The outputs are numbered according to the order in which the digital input/output modules are connected to the PLC. The maximum number of outputs on the PLC is 1024, and the range is between Y0.0 and Y63.15.

An output that is not used as an output device can be used as a general device.

- Output types

Outputs are classified into two types.

1. Regenerated output: The state of a regenerated output is not written until the program executes the instruction END according to the states of the outputs. For example, OUT Y0.0.
2. Direct output: The state of a direct output is written by the PLC during the execution of the instructions according to the states of the outputs. For example, OUT DY0.0.

5.2.6 Auxiliary Relays (M)

The auxiliary relay has contact A and contact B. It can be used several times in the program. You can combine the control loops with the auxiliary relay, but you cannot drive the external load with the auxiliary relay. You can use the auxiliary relays in either of two ways.

1. For general use: In general use, if an electrical power interruption occurs when the PLC is running, the auxiliary relay is reset to OFF. When the power is restored, the auxiliary relay remains OFF.
2. For latched use: In latched use, if an electrical power interruption occurs when the PLC is running, the state of the auxiliary relay states for latched use is retained. When the power supply is restored, the state remains the same as before the power interruption.

5.2.7 Special Auxiliary Relays (SM)

Every special auxiliary relay has its own specific function. Refer to section 2.2.7 in the AS Series Programming Manual for more information.

5.2.8 Relays (S)

Relay is the most basic device to set procedures, especially common in ladder diagram (LD) programming. Refer to the ISPSOFT User Manual for more information on using ladder diagram.

There are 2048 relays, (S0–S2047). Every relay (device S) is like an auxiliary relay (device M) which contains an output coil, contact A, and contact B. There is no limit on the number of usage in a program. For the retainable relays, their statuses can be retained after power loss. However, for the unretainable relays, the statuses cannot be retained after power loss and all the statuses will be restored to OFF after the power returns.

5.2.9 Timers (T)

- 100 millisecond timer: The timer specified by the instruction TMR takes 100 milliseconds as the timing unit.
- 1 millisecond timer: The timer specified by the instruction TMRH takes 1 millisecond as the timing unit.
- The accumulative timers are ST0–ST511. If you want to use the device-monitoring function, these timers can monitor T0–T511.
- If you use the same timer repeatedly in a program, including in different instructions TMR and TMRH, the timer setting value is the one that the timer matches first.
- If you use the same timer repeatedly in a program, the timer is OFF when one of the conditional contacts is OFF.
- If you use the same timer in a program as the timer for a subroutine's exclusive use and an accumulative timer in the program, it is OFF when one of the conditional contacts is OFF.
- When the timer is switched from ON to OFF and the conditional contact is ON, the timer is reset and counts again.
- When the instruction TMR is executed, the specified timer coil is ON and the timer begins to count. When the value of the timer matches the timer setting value (value of the timer \geq setting value), the contact state is ON.

A. General-purpose timer

When the instruction TMR is executed, the general-purpose timer begins to count. When the value of the timer matches the timer setting value, the output coil is ON.

- When X0.0=ON and the timer takes 100 ms as the timing unit, the output coil T0 is ON when the value of the timer = setting value100.
- When X0.0=OFF or the power is off, the value of the timer is 0 and the output coil T0 is OFF.

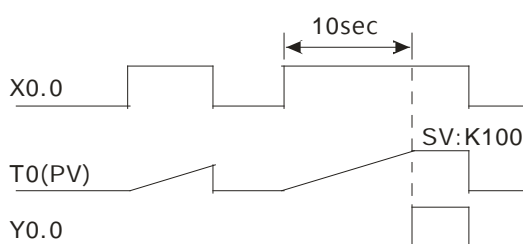
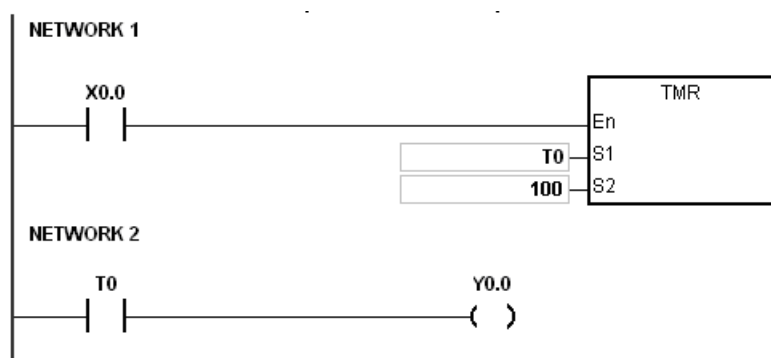

B. Accumulative timer

When the instruction TMR is executed, the accumulative timer begins to count. When the value of the timer matches the timer setting value, the output coil is ON. As long as you add the letter S in front of the letter T, the timer becomes an accumulative timer. When the conditional contact is OFF, the value of the accumulative timer is not reset. When the conditional contact is ON, the timer counts from the current value.

- When X0.0=ON and the timer T250 takes 100 ms as the timing unit, the output coil T250 is ON when the value of the timer = timer setting value100.
- When X0.0=OFF or the power is off, the timer T250 stops counting, and the value of the timer stays the same. When X0.0=ON, the value of the timer is accumulating value When the accumulated value = timer setting value 100, the output coil T250 is ON.

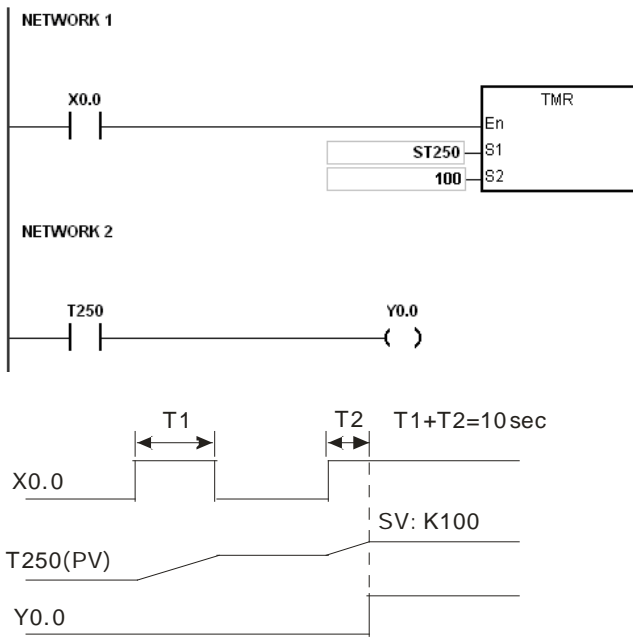

C. Timer used in the function block

Use the T412–T511 timers for the function block or the interrupt.

When the instruction TMR or END is executed, the timer used in the functional block begins to count.

When the value of the timer matches the timer setting value, the output coil is ON.

If you use the general-purpose timer is used in the function block or the interrupt, and the functional or interrupt is not executed, the timer cannot count correctly.

5.2.10 16-bit Counters

- Characteristics of the 16-bit counter

Item	16-bit counter
Type	General type
Number	C0–C511
Direction	Counting up
Setting value	0–32,767
Specifying the counter setting value	The setting value can be either the constant or the value in the data register.
Change of the current value	The counter stops counting when the value of the counter matches the setting value.
Output contact	The contact is ON when the value of the counter matches the setting value.

Item	16-bit counter
Reset	When the instruction RST is executed, the current value is cleared to zero, and the contact is reset to OFF.
Action of the contact	After the scan completes, the contact acts.

- Counter function

Each time the input switches from OFF to ON, the value of the counter is the same as the output coil. Use either the decimal constant or the value in the data register as the counter setting value.

- 16-bit counter:

1. Setting range: 0–32,767. The setting values 0 and 1 both mean the same thing in that the output contact is ON when the counter counts for the first time.
2. For the general-purpose counter, the current value of the counter is cleared when there is a power interruption. If the counter is latching, the current value of the counter and the state of the contact before the power interruption are retained. The latched counter counts from the current value when the power supply is restored.
3. If you use the instruction MOV or ISPSOft / DIADesigner to transmit a value bigger than the counter setting value to the current value register C0, the contact of the counter C0 is ON and the current value becomes the same as the counter setting value next time X0.1 switches from OFF to ON.
4. Use either the constant or the value in the data register as the counter setting value.
5. The counter setting value can be a positive or negative value. If the counter counts up from 32,767, the next value is 0.
6. Here we use the most common application as an example. You can use this counter with API 1003 CNT instruction; refer to CNT instruction for more description.

Example:

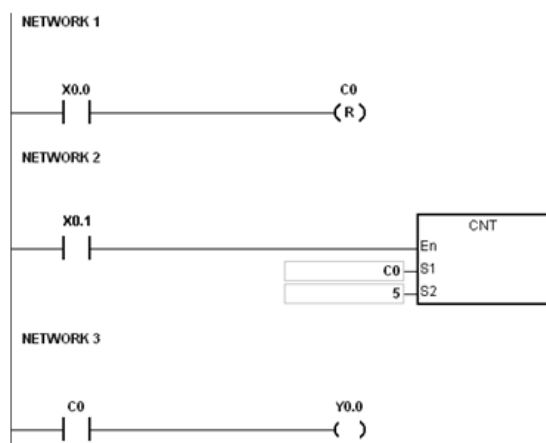

1. When X0.0=ON, the instruction RST will be executed and the current value of C0 will be reset to zero and the output contact of the counter C0 will be FF.
2. When X0.1 is from OFF to ON, the value of the counter increases by one increment.
3. When the value of the counter C0 reached the setting value 5, the contact of the counter C0 will be ON (the current value of C0 = the setting value = 5). After that the trigger from X0.1 will not be accepted by C0 and the current value of C0 will stay at the value 5.

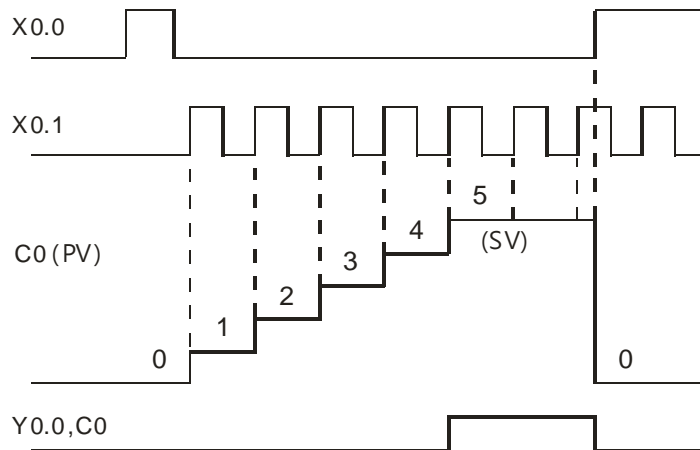

5.2.11 32-bit Counters (HC)

- Characteristics of the 32-bit counter

Item	32-bit counter		
	Up/down counter	Up counter	High-speed counter
Type	Up/down counter	Up counter	High-speed counter
Number	HC0–HC63	HC64–HC199	HC200–HC255
Direction	Counting up/down	Counting up	Counting up/down
Setting value	-2,147,483,648 to +2,147,483,647		
Specification of the setting value	The setting value can be either the constant or the value occupying two data registers (32-bit).		
Change of the current value	The counter keeps counting even after the value of the counter matches the setting value.		
Output contact	The contact is ON when the value of the addition counter matches the setting value. The contact is reset to OFF when the value of the subtraction counter matches the setting value.		
Reset	When the RST instruction is executed, the current value is cleared to zero, and the contact is reset to OFF.		

Item	32-bit counter
Action of the contact	After the DCNT instruction scan is complete, the contact activates.

- 32-bit general-purpose addition/subtraction counter
 1. Setting range: -2,147,483,648 to 2,147,483,647
 2. The switch between the 32-bit general-purpose addition counters and the 32-bit general-purpose subtraction counters depends on the states of the special auxiliary relays SM621–SM684. For example, the counter HC0 is the addition counter when SM621 is OFF, but HC0 is the subtraction counter when SM621 is ON. Use either the constant or the value in the data registers as the setting value for the counter, and the setting value can be a positive or a negative number. If you use the value in the data registers as the setting value of the counter, the setting value occupies two consecutive registers.
 3. For the general-purpose counter, the current value of the counter is cleared when there is a power interruption. If the counter is latched, the current value of the counter and the state of the contact before the power interruption are retained. The latched counter counts from the current value when the power supply is restored.
 4. If the counter counts up from 2,147,483,647, the next current value is -2,147,483,648. If the counter counts down from -2,147,483,648, the next current value is 2,147,483,647.
 5. Here we uses the most common application as an example. You can use this counter with API 1004 DCNT instruction; refer to DCNT instruction for more description.
- 32-bit high speed addition/subtraction counter

Refer to the DCNT instruction description (API 1004) in the AS Series Programming Manual for more details.

Example:

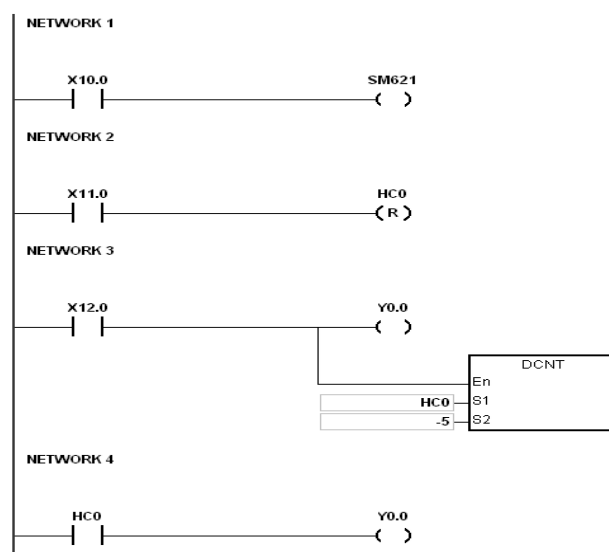

1. X10.0 drives SM621 to determine counting direction (up/down) of HC0.
2. When X11.0 goes from OFF to ON, RST instruction executes, the PV in HC0 is cleared to 0, and its contact is OFF.
3. When X12.0 goes from OFF to ON, PV of HC0 counts up (plus 1) or down (minus 1).
4. When PV in HC0 changes from -6 to -5, the contact HC0 goes from OFF to ON. When PV in HC0 changes from -5 to -6, the contact HC0 goes from ON to OFF.

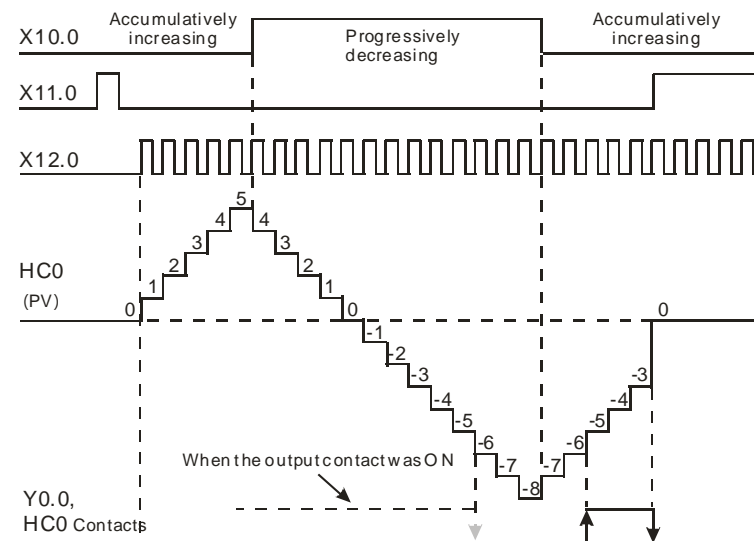

5.2.12 Data Registers (D)

The data register stores 16-bit data. The highest bit represents either a positive sign or a negative sign, and the values that you can store in the data registers are between -32,768 to +32,767. Two 16-bit registers can be combined into a 32-bit register, that is, (D+1, D) in which the register whose number is smaller represents the lower 16 bits. The highest bit represents either a positive sign or a negative sign, and the values that you can store in the data registers are between -2,147,483,648 to +2,147,483,647. Four 16-bit registers can be combined into a 64-bit register; that is, (D+3, D+2, D+1, D) in which the register whose number is smaller represents the lower 16 bits. The highest bit represents either a positive sign or a negative sign, and the values which can be stored in the data registers are between -9,223,372,036,854,776 to +9,223,372,036,854,775,807. You can also use the data registers to refresh the values in the control registers in the modules other than digital I/O modules. Refer to the ISPSOft / DIADesigner User Manual for more information about refreshing the values in the control registers.

The registers can be classified into three types according to their properties.

1. General-purpose register: when the PLC begins to run or is disconnected, the value in the register clears to zero. To retain the data when the PLC begins to RUN, refer to the ISPSOft / DIADesigner User Manual for more information. Notice that the value still clears to zero when the PLC is disconnected.
2. Latched register: if the PLC is disconnected, the data in the latched register is not cleared. In other words, the value before the disconnection is still retained. To clear the data in the latched area, use the RST or ZRST instruction.
3. Data exchange area: When the PLC is connected with a module, the PLC exchanges data with the connected module at every scan cycle. And the data is stored in data registers D26000 to D29999. Refer to the ISPSOft > HWCONFIG > Module > Device Setting > Normal Exchange Area to see the data register range and refer to Chapter 8 for more descriptions.

5.2.13 Special Data Registers (SR)

Every special data register has its definition and specific function. Refer to section 2.2.14 in the AS Series Programming Manual for more information.

5.2.14 Index Register (E)

The index register is a 16-bit data register. Like the general register, you can read data from it and write data into it. However, it is mainly used as the index register. The index registers range from E0–E9. Refer to section 4.4 in the AS Series Programming Manual for more information about using index registers.

5.2.15 File Registers (FR)

The AS Series PLC provides you with file registers for storing larger numbers of parameters. You can edit, upload, and download the system parameters with ISPSOft / DIADesigner. You can read the values in a file register can be read while operating the PLC. Refer to the MEMW instruction (API 2303) in the AS Series Programming Manual for more information about how to write to a file register.

5.3. Assigning I/O Addresses for Modules

This chapter explains how to assign input and output devices to an AS Series input/output module in ISPSOft. For DIADesigner operation, refer to section 6.1 from DIADesigner software manual.

Using HWCONFIG in ISPSOft

The following picture shows the **HWCONFIG** window in ISPSOft. Please refer to Chapter 8 for more information on the hardware configuration.

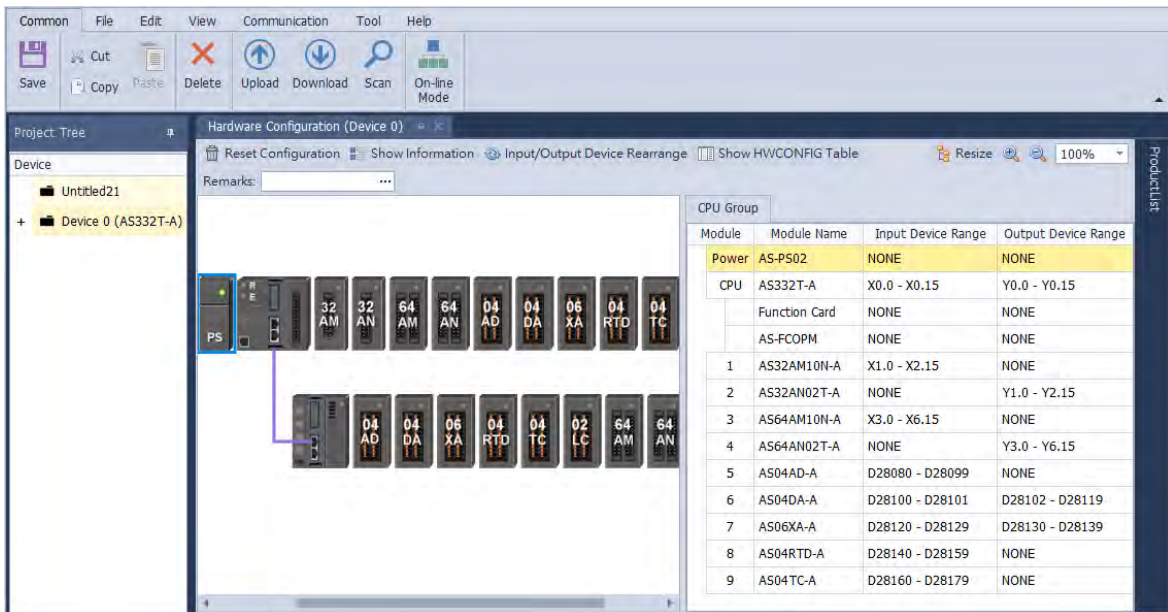

- **Module addresses defined by software**

Through HWCONFIG, the system automatically assigns a starting address to every slot of an input/output module in ISPSOft.

- **Remote module addresses defined by software**

You use HWCONFIG to assign a starting address to a remote module in ISPSOft. Double-click the CPU module and select Function Card 2. Change the Card 2 Detect mode to Manual and then select AS-FCOPM from the Manual Select Card. You can assign a starting address to the first remote module installed on the right side of the I/O module slot. Then the following I/O modules are assigned addresses automatically and consecutively.

5.4 Module Addresses Defined by Software

This section uses ISPSOft for demonstration. For DIADesigner operation, refer to section 6.1 from DIADesigner software manual.

5.4.1 Starting Addresses for Digital Input/Output Modules

HWCONFIG automatically assigns input/output devices to a digital input/output module in ISPSOft according to the number of inputs and outputs in the digital input/output module (X0.0–X0.15, X1.0–X1.15, X2.0–X2.15...; Y0.0–Y0.15, Y1.0–Y1.15, Y2.0–Y2.15). The default starting addresses are shown below.

Note: each digital I/O module reserves 20 words of data devices and it assigns consecutive data devices automatically starting from D28000.

- AS332T/AS332P: There are 16 inputs. The input and output device range occupies 16 bits. (Xn.0–Xn.15), (Yn.0–Yn.15) and 20 words of data devices.
- AS324MT: There are 16 outputs. The input and output device range occupies 16 bits. (Xn.0–Xn.15), (Yn.0–Yn.15) and 20 words of data devices.
- 08AM: There are eight inputs. The input device range occupies 16 bits (Xn.0–Xn.15) and 20 words of data devices.
- 08AN: There are eight outputs. The output device range occupies 16 bits (Yn.0–Yn.15) and 20 words of data devices.
- 16AM: There are 16 inputs. The input device range occupies 16 bits (Xn.0–Xn.15) and 20 words of data devices.
- 16AN: There are 16 outputs. The output device range occupies 16 bits (Yn.0–Yn.15) and 20 words of data devices.
- 16AP: There are eight inputs and eight outputs. The input and output device range occupies 16 bits. (Xn.0–Xn.15), (Yn.0–Yn.15) and 20 words of data devices.
- 32AM: There are 32 inputs. The input device range occupies 32 bits (Xn.0–Xn+1.15) and 20 words of data devices.
- 32AN: There are 32 outputs. The output device range occupies 32 bits (Yn.0–Yn+1.15) and 20 words of data devices.
- 64AM: There are 64 inputs. The input device range occupies 64 bits (Xn.0–Xn+3.15) and 20 words of data devices.
- 64AN: There are 64 outputs. The output device range occupies 64 bits (Yn.0–Yn+3.15) and 20 words of data devices.



CPU Group			
Module	Module Name	Input Device Range	Output Device Range
Power	AS-PS02	NONE	NONE
CPU	AS332T-A	X0.0 - X0.15	Y0.0 - Y0.15
	Function Card	NONE	NONE
	Function Card	NONE	NONE
1	AS04AD-A	D28000 - D28019	NONE
2	AS08AM10N-A	X1.0 - X1.7	NONE
3	AS08AN01R-A	NONE	Y1.0 - Y1.7
4	AS16AM10N-A	X2.0 - X2.15	NONE
5	AS16AN01T-A	NONE	Y2.0 - Y2.15
6	AS16AP11T-A	X3.0 - X3.7	Y3.0 - Y3.7
7	AS32AM10N-A	X4.0 - X5.15	NONE
8	AS32AN02T-A	NONE	Y4.0 - Y5.15
9	AS64AM10N-A	X6.0 - X9.15	NONE
10	AS64AN02T-A	NONE	Y6.0 - Y9.15

Note: though there is no information on the occupied data devices in the image shown above, the CPU reserves 20 words of data devices.

5.4.2 Starting Addresses for Analog Input/Output Modules

HWCONFIG automatically assigns consecutive input and output data registers starting from D28000 to an analog input/output module in ISPSOft according to the number of registers defined for the analog input/output module.

- 04AD: There are four input channels. The input device range occupies 20 data registers.
- 08AD: There are eight input channels. The input device range occupies 20 data registers.
- 004DA: There are four output channels. The input device range occupies two data registers and the output device range occupies 18 data registers.
- 06XA: There are four input channels and two output channels. The input device range occupies 10 data registers, and the output device range occupies 10 data registers.



CPU Group			
Module	Module Name	Input Device Range	Output Device Range
Power	AS-PS02	NONE	NONE
CPU	AS332T-A	X0.0 - X0.15	Y0.0 - Y0.15
	Function Card	NONE	NONE
	Function Card	NONE	NONE
1	AS04AD-A	D28000 - D28019	NONE
2	AS08AD-B	D28020 - D28039	NONE
3	AS04DA-A	D28040 - D28041	D28042 - D28059
4	AS06XA-A	D28060 - D28069	D28070 - D28079

5.4.3 Starting Addresses for Temperature Measurement Modules

HWCONFIG automatically assigns consecutive input and output data registers starting from D28000 to a temperature measurement module in ISPSOft according to the number of registers defined for the temperature measurement module.

1. 04RTD: There are four input channels. The input device range occupies 20 data registers.
2. 06RTD: There are six input channels. The input device range occupies 20 data registers.
3. 04TC: There are four input channels. The input device range occupies 20 data registers.
4. 08TC: There are eight input channels. The input device range occupies 20 data registers.



CPU Group			
Module	Module Name	Input Device Range	Output Device Range
Power	AS-PS02	NONE	NONE
CPU	AS332T-A	X0.0 - X0.15	Y0.0 - Y0.15
	Function Card	NONE	NONE
	Function Card	NONE	NONE
1	AS04RTD-A	D28000 - D28019	NONE
2	AS06RTD-A	D28020 - D28039	NONE
3	AS04TC-A	D28040 - D28059	NONE
4	AS08TC-A	D28060 - D28079	NONE

5.4.4 Starting Addresses for Positioning/Counter Modules

HWCONFIG automatically assigns consecutive input and output data registers starting from D28000 to a network module in ISPSOft according to the number of registers defined for the network module.

1. 02PU: The input device range occupies 20 data registers.
2. 04PU: The input device range occupies 20 data registers.
3. 02HC: The input device range occupies 20 data registers.



CPU Group			
Module	Module Name	Input Device Range	Output Device Range
Power	AS-PS02	NONE	NONE
CPU	AS332T-A	X0.0 - X0.15	Y0.0 - Y0.15
	Function Card	NONE	NONE
	Function Card	NONE	NONE
1	AS02PU-A	D28000 - D28019	NONE
2	AS04PU-A	D28020 - D28039	NONE
3	AS02HC-A	D28040 - D28059	NONE

5.4.5 Starting Addresses for Network Modules

HWCONFIG automatically assigns consecutive input and output data registers starting from D28000 to a network module in ISPSOft according to the number of registers defined for the network module.

- SCM, as a general COM communication module:
Communication status and communication method; the input device range occupies 20 data registers, and the output device range occupies 20 data registers.



CPU Group			
Module	Module Name	Input Device Range	Output Device Range
Power	AS-PS02	NONE	NONE
CPU	AS332T-A	X0.0 - X0.15	Y0.0 - Y0.15
	Function Card	NONE	NONE
	Function Card	NONE	NONE
1	AS00SCM-A	D28000 - D28019	D28020 - D28039
	Function Card	NONE	NONE
	Function Card	NONE	NONE

- Remote module SCM: the input device range and output device range each occupy 10 data registers.



Group_1			
Module	Module Name	Input Device Range	Output Device Range
Remote	AS00SCM-A	D29000 - D29009 ...	D29010 - D29019
	AS-FCOPM	NONE	NONE
1	AS08AM10N-A	X1.0 - X1.7	... NONE
2	AS08AN01T-A	NONE	Y1.0 - Y1.7 ...
3	AS16AM10N-A	X2.0 - X2.15	NONE
4	AS16AN01T-A	NONE	Y2.0 - Y2.15
5	AS16AP11T-A	X3.0 - X3.7	Y3.0 - Y3.7
6	AS32AM10N-A	X4.0 - X5.15	NONE
7	AS32AN02T-A	NONE	Y4.0 - Y5.15
8	AS64AM10N-A	X6.0 - X9.15	NONE

- AS01DNET-A: when selecting the COM communication mode, its communication status and communication method: the input device range occupies 20 data registers, and the output device range occupies 20 data registers.



CPU Group			
Module	Module Name	Input Device Range	Output Device Range
Power	AS-PS02	NONE	NONE
CPU	AS332T-A	X0.0 - X0.15	Y0.0 - Y0.15
	Function Card	NONE	NONE
	Function Card	NONE	NONE
1	AS01DNET-A	D28000 - D28019	D28020 - D28039
	Data Exchange	D26000 - D26099	D26100 - D26199

- AS04SIL-A: when selecting the COM communication mode, its communication status and communication method: the input device range occupies 20 data registers.



CPU Group			
Module	Module Name	Input Device Range	Output Device Range
Power	AS-PS02	NONE	NONE
CPU	AS332T-A	X0.0 - X0.15	Y0.0 - Y0.15
	Function Card	NONE	NONE
	Function Card	NONE	NONE
1	AS04SIL-A	D28000 - D28019	NONE
	Data Exchange	D26000 - D26099	D26100 - D26199

5.4.6 Starting Addresses for Load Cell Modules

HWCONFIG automatically assigns consecutive input and output data registers starting from D28000 to a load cell module in ISPSOft according to the number of registers defined for the load cell module.

- 02LC: The input device range occupies 7 data registers and the output device range occupies 13 data registers.



CPU Group			
Module	Module Name	Input Device Range	Output Device Range
Power	AS-PS02	NONE	NONE
CPU	AS332T-A	X0.0 - X0.15	Y0.0 - Y0.15
	Function Card	NONE	NONE
	Function Card	NONE	NONE
1	AS02LC-A	D28000 - D28006	D28007 - D28019

5.5 Remote Module Addresses Defined by Software

This section uses ISPSOft for demonstration. For DIADesigner operation, refer to section 6.1 from DIADesigner software manual.

Double-click the CPU module to see the setting page where you can set up the PLC parameters. Select options on the left under the General or Data Exchange tab, you can see the setting items on the right under the tab of the option you have selected.

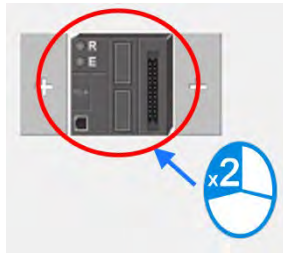

- Click **Function Card2** on the left to see the Function Card 2 Setting tab on the right and find setting items under the tab.

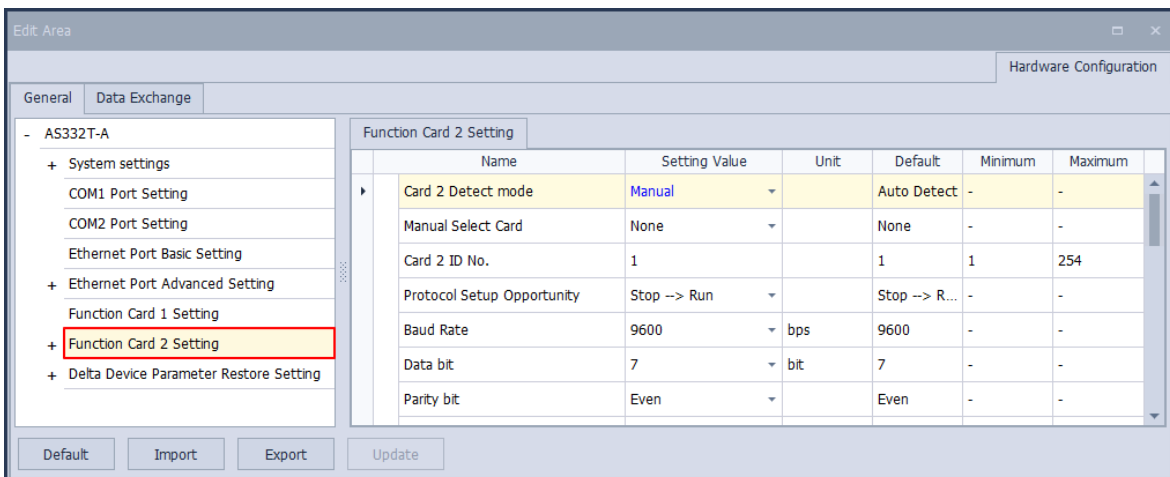

- For **Card 2 Detect mode**, select **Manual**. For **Manual Select Card**, select **AS-FCOPM Card**.

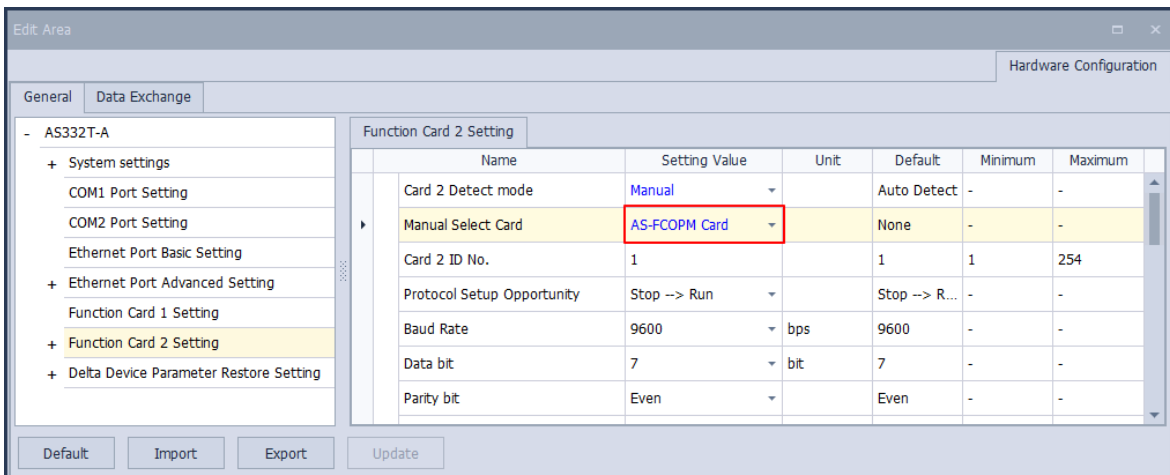

- For **AS-FCOPM Working mode**, select **AS Remote Communication**, and then enter the number of the connected AS Remote module. Click **Update** and then close the setting page.

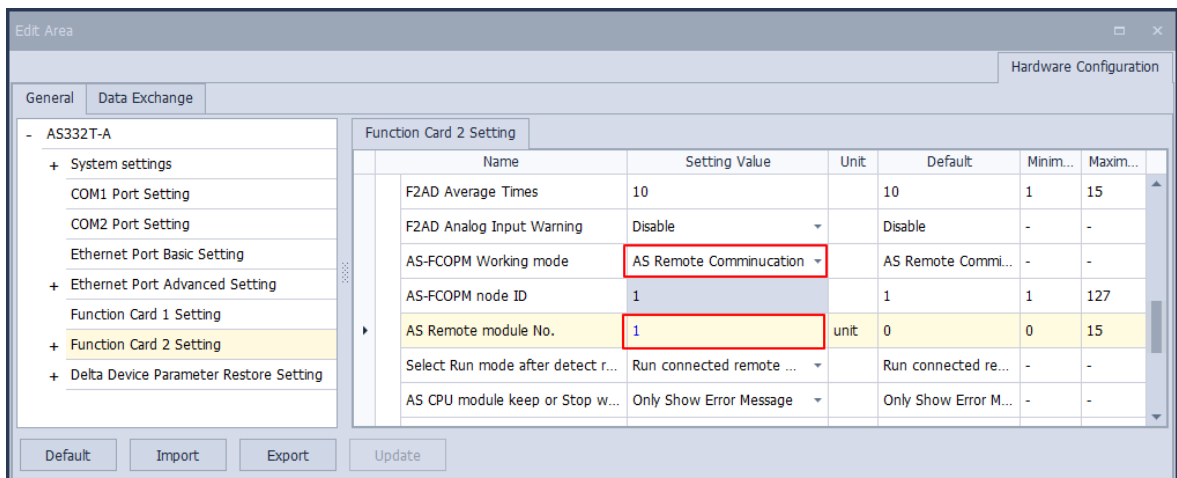

- You can see the new remote module on the main page. For the configurations of remote modules, refer to the configurations of modules.

Note: You can add up to 15 modules in the remote group. The total number of I/O modules and connected remote modules cannot exceed 32. Only digital I/O modules, analog I/O modules, temperature measurement modules, load cell modules and AS04SIL-A can be used for remote modules.

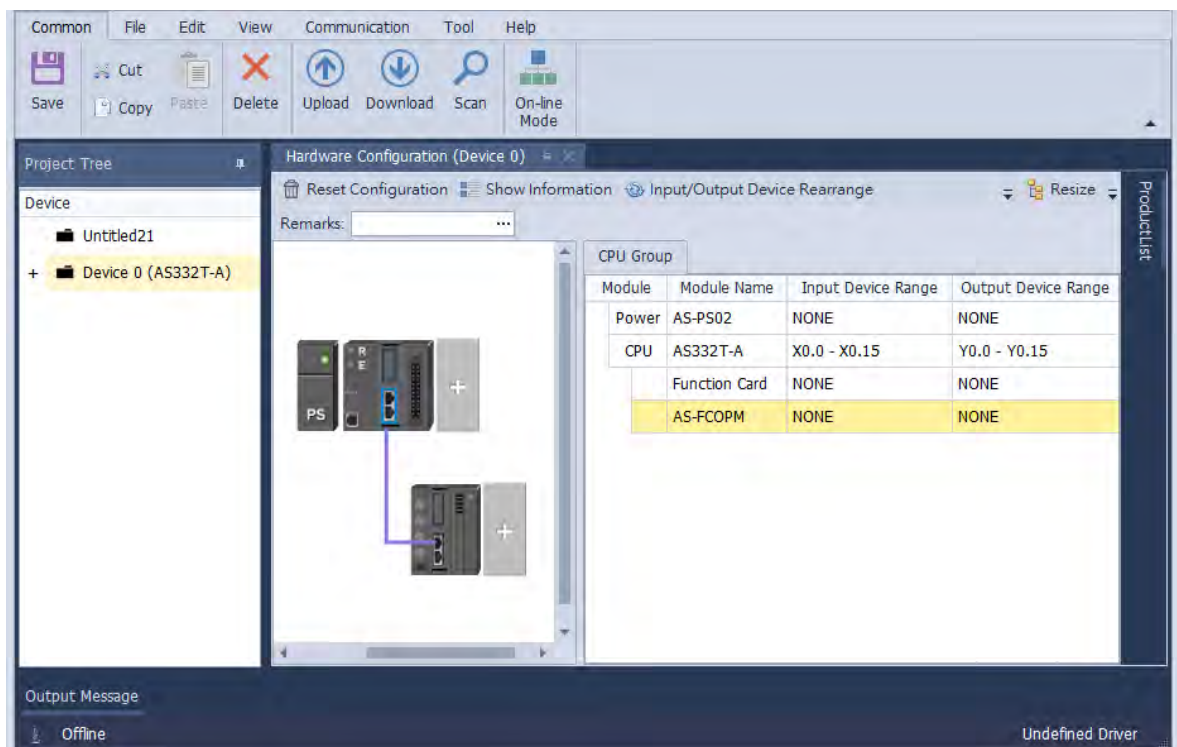

- Change the address of the remote module

You can change the remote module address by simply double-click the **...** behind the Input Device Range and then you can see the Manual Assignment window. Define the starting address of your remote module and click OK to confirm and save the change.

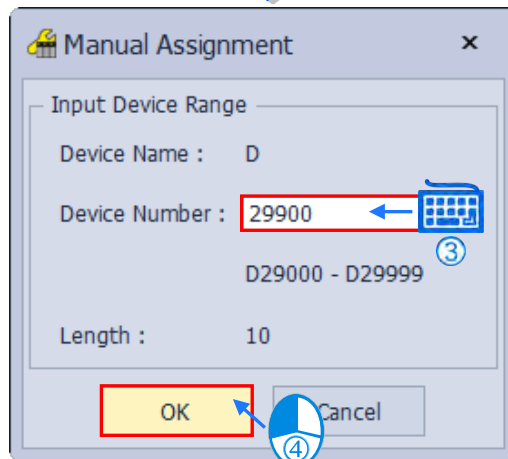
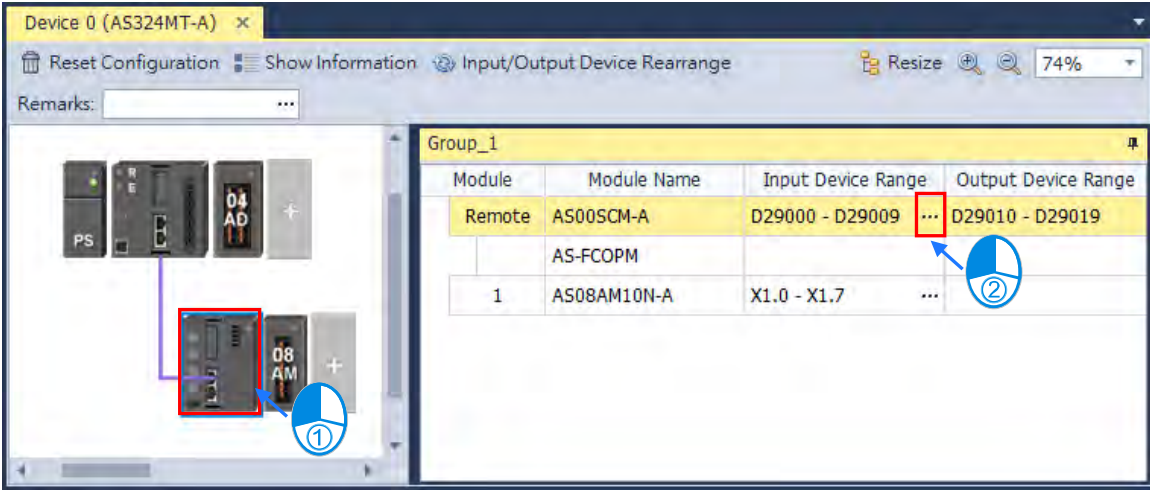

Module	Module Name	Input Device Range	Output Device Range
Remote	AS00SCM-A	D29900 - D29909 ...	D29910 - D29919

5.5.1 Starting Addresses for Digital Input/Output Modules

The remote module AS00SCM-A can connect to up to eight modules on its right side. HWCONFIG automatically assigns input and output devices to a digital input/output module in ISPSOft according to the number of inputs/outputs in the digital input/output module (X1.0–X1.15, X2.0–X2.15... ; Y0.0–Y0.15, Y1.0–Y1.15, Y2.0–Y2.15). The default starting addresses are shown below.

Note: each digital I/O module reserves 20 words of data devices and it assigns consecutive data devices automatically starting from D29000.

- 08AM: There are eight inputs. The input device range occupies 16 bits (Xn.0–Xn.15) and 20 words of data devices.
- 08AN: There are eight outputs. The output device range occupies 16 bits (Yn.0–Yn.15) and 20 words of data devices.
- 16AM: There are 16 inputs. The input device range occupies 16 bits (Xn.0–Xn.15) and 20 words of data devices.
- 16AN: There are 16 outputs. The output device range occupies 16 bits (Yn.0–Yn.15) and 20 words of data devices.
- 16AP: There are eight inputs and eight outputs. The input and output device range occupies 16 bits. (Xn.0–Xn.15), (Yn.0–Yn.15) and 20 words of data devices.
- 32AM: There are 32 inputs. The input device range occupies 32 bits (Xn.0–Xn+1.15) and 20 words of data devices.
- 32AN: There are 32 outputs. The output device range occupies 32 bits (Yn.0–Yn+1.15) and 20 words of data devices.
- 64AM: There are 64 inputs. The input device range occupies 64 bits (Xn.0–Xn+3.15) and 20 words of data devices.
- 64AN: There are 64 outputs. The output device range occupies 64 bits (Yn.0–Yn+3.15) and 20 words of data devices.



Group_1			
Module	Module Name	Input Device Range	Output Device Range
Remote	AS00SCM-A	D29000 - D29009 ...	D29010 - D29019
	AS-FCOPM	NONE	NONE
1	AS04AD-A	D29020 - D29039	NONE
2	AS08AM10N-A	X1.0 - X1.7 ...	NONE
3	AS08AN01T-A	NONE	Y1.0 - Y1.7 ...
4	AS16AM10N-A	X2.0 - X2.15	NONE
5	AS16AN01T-A	NONE	Y2.0 - Y2.15
6	AS32AM10N-A	X3.0 - X4.15	NONE
7	AS32AN02T-A	NONE	Y3.0 - Y4.15
8	AS04AD-A	D29160 - D29179	NONE

5.5.2 Starting Addresses for Analog Input/Output Modules

HWCONFIG automatically assigns input and output data registers to an analog input/output module in ISPSOft according to the number of registers defined for the analog input/output module. The default starting address is D29000.

- 04AD: There are four input channels. The input device range occupies 20 data registers.
- 08AD: There are eight input channels. The input device range occupies 20 data registers.
- 004DA: There are four output channels. The input device range occupies two data registers and the output device range occupies 18 data registers.
- 06XA: There are four input channels, and two output channels. The input device range occupies 10 data registers, and the output device range occupies 10 data registers.



Group_1			
Module	Module Name	Input Device Range	Output Device Range
Remote	AS00SCM-A	D29000 - D29009 ...	D29010 - D29019
	AS-FCOPM	NONE	NONE
1	AS04AD-A	D29020 - D29039	NONE
2	AS08AD-B	D29040 - D29059	NONE
3	AS04DA-A	D29060 - D29061	D29062 - D29079
4	AS06XA-A	D29080 - D29089	D29090 - D29099

5.5.3 Starting Addresses for Temperature Measurement Modules

You can use HWCONFIG to assign input registers to a temperature measurement module in ISPSOft. The default starting address is D29000.

1. 04RTD: There are four input channels. The input device range occupies 20 data registers.
2. 06RTD: There are six input channels. The input device range occupies 20 data registers.
3. 04TC: There are four input channels. The input device range occupies 20 data registers.
4. 08TC: There are eight input channels. The input device range occupies 20 data registers.



Group_1			
Module	Module Name	Input Device Range	Output Device Range
Remote	AS00SCM-A	D29000 - D29009 ...	D29010 - D29019
	AS-FCOPM	NONE	NONE
1	AS04RTD-A	D29020 - D29039	NONE
2	AS06RTD-A	D29040 - D29059	NONE
3	AS04TC-A	D29060 - D29079	NONE
4	AS08TC-A	D29080 - D29099	NONE

5.5.4 Starting Addresses for Load Cell Modules

HWCONFIG automatically assigns input data registers to a load cell module in ISPSOft according to the number of registers defined for the load cell module. The default starting address is D29000.

- 02LC: The input device range occupies 7 data registers and the output device range occupies 13 data registers.



Group_1			
Module	Module Name	Input Device Range	Output Device Range
Remote	AS00SCM-A	D29000 - D29009 ...	D29010 - D29019
	AS-FCOPM	NONE	NONE
1	AS02LC-A	D29020 - D29026	D29027 - D29039

5.5.5 Starting Addresses for AS04SIL-A Modules

- AS04SIL-A: when selecting the COM communication mode, its communication status and communication method: the input device range occupies 20 data registers.

Group_1			
Module	Module Name	Input Device Range	Output Device Range
Remote	AS00SCM-A	D29000 - D29009 ...	D29010 - D29019
	AS-FCOPM	NONE	NONE
1	AS04SIL-A	D29020 - D29039	NONE
	Data Exchange	D26000 - D26099	D26100 - D26199

Chapter 6 Writing a Program

Table of Contents

6.1 Quick Start	6-2
6.1.1 Example	6-2
6.1.2 Hardware.....	6-2
6.1.3 Program	6-3
6.2 Procedure for Creating a Project in ISPSoft.....	6-4
6.3 Creating a Project.....	6-5
6.4 Hardware Configuration	6-6
6.5 Creating a Program	6-7
6.5.1 Adding a Ladder Diagram.....	6-7
6.5.2 Basic Editing – Creating a Contact and a Coil	6-9
6.5.3 Basic Editing – Inserting a Network and Typing an Instruction	6-12
6.5.4 Basic Editing – Selecting a Network and Operation.....	6-14
6.5.5 Basic Editing – Connecting a Contact in Parallel.....	6-17
6.5.6 Basic Editing – Editing a Comment	6-18
6.5.7 Basic Editing – Inserting an Applied Instruction	6-19
6.5.8 Basic Editing – Creating a Comparison Contact and Typing a Constant.....	6-21
6.5.9 Writing a Program.....	6-22
6.5.10 Checking and Compiling a Program.....	6-23
6.6 Testing and Debugging a Program.....	6-24
6.6.1 Creating a Connection	6-24
6.6.2 Downloading a Program and Parameters	6-27
6.6.3 Connection Test.....	6-29
6.7 Setting a Real-time Clock	6-37

6.1 Quick Start

This section uses ISPSOft for demonstration. For DIADesigner operation, refer to Chapter 8 from DIADesigner software manual.

This chapter provides a simple example showing you how to create a traditional ladder diagram in ISPSOft. Because you may not be familiar with IEC 61131-3 and may not understand the functions provided by ISPSOft, the chapter does not introduce programming concepts related to IEC 61131-3. For example, the chapter does not include POU, function blocks, variables, and so on.

6.1.1 Example

When the equipment in this example operates, the parts on the conveyor move from left to right. If a sensor senses that a part is under an injector, the PLC sends a trigger signal to the injector, and the injector injects the glue. The injection length is set externally and is not controlled by the PLC program. However, the PLC program must be able to turn the trigger signal OFF so that the trigger signal can be sent next time. There are two injectors above the conveyor, and the two injectors inject glue in the same way.

There is a sensor at the left side of the conveyor. When a part passes the sensor, the sensor value increases by one increment. When the sensor value is 100, the internal completion flag is set to ON. The flag state can be used by other procedures later. However, this example does not introduce the use of flag states.

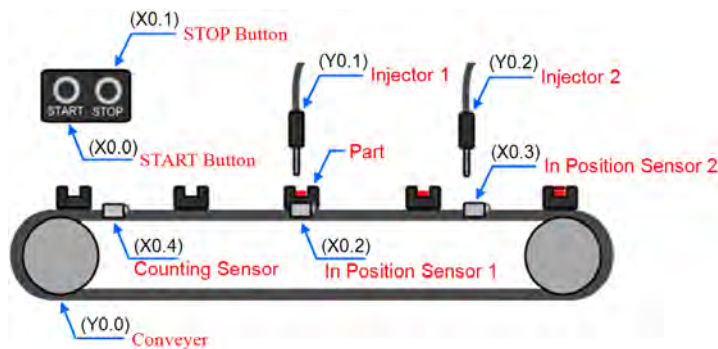

6.1.2 Hardware

In this example, the AS series CPU module used is the **AS332T-A**.

Type	ID	Description
Digital input	X0.0	START button
Digital input	X0.1	STOP button
Digital input	X0.2	In position sensor 1
Digital input	X0.3	In position sensor 2

Type	ID	Description
Digital input	X0.4	Counting sensor
Digital output	Y0.0	Conveyer
Digital output	Y0.1	Trigger signal for injector 1
Digital output	Y0.2	Trigger signal for injector 2

6.1.3 Program

- (1) When the START button (X0.0) switches from OFF to ON, the internal operation flag is set to ON, and the conveyer (Y0.0) starts. When the STOP button (X0.1) switches from OFF to ON, an error occurs (the error flag is ON), the operation flag is reset to OFF, and the conveyer stops.
- (2) When the in position sensor 1 (X0.2) is ON, the trigger signal for injector 1 (Y0.1) is set to ON. When the in position sensor 1 is OFF, the trigger signal for injector 1 is reset to OFF.
- (3) When the in position sensor 2 (X0.3) is ON, the trigger signal for injector 2 (Y0.2) is set to ON. When the in position sensor 2 is OFF, the trigger signal for injector 2 is reset to OFF.
- (4) When the counting sensor (X0.4) switches from OFF to ON, the sensor value increases by one increment. If the sensor value is larger than or equal to 100, the internal completion flag is set to ON.

6.2 Procedure for Creating a Project in ISPSOft

This section shows you the procedure for creating a project in ISPSOft. You can adjust the procedure according to your needs.

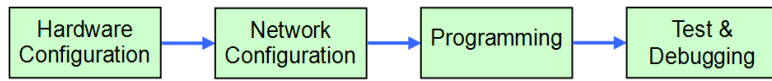

- **Hardware configuration**

You set the parameters such as a range of latched devices and a port number in a PLC. You configure the modules with an AS Series CPU module, and set the parameters in these modules.

- **Network configuration**

If a system uses a network architecture, or devices need to exchange data, use the network configuration tool **NWCONFIG** in ISPSOft to configure a network and exchange data with COM as well as Ethernet.

- **Programming**

After you write a program in ISPSOft, compile the program. If the compiling is unsuccessful, messages in the **Compile Message** page show where the errors occur.

- **Testing and debugging**

Download the compiled program, the hardware configuration, and the network configuration to a PLC. You can then test and debug the program online with the functions provided by ISPSOft.

Because the example introduced in this chapter does not discuss a network configuration, you only perform

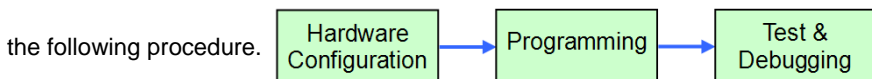

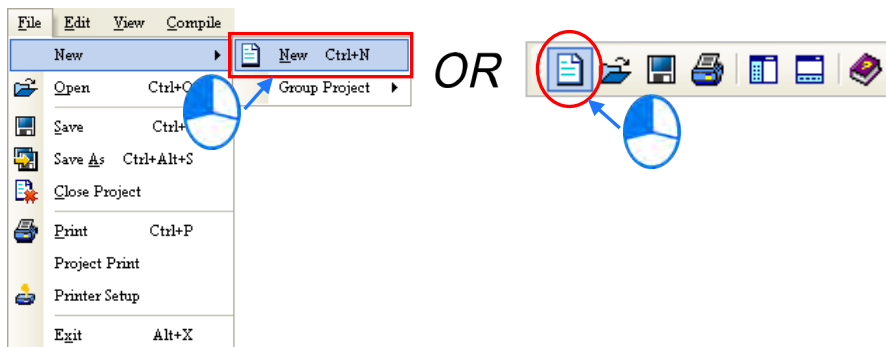

6.3 Creating a Project

After you start ISPSOft, on the **File** menu, point to **New**, and then click **New** to create a new project. You can also create a new project by clicking  on the toolbar after you start ISPSOft.

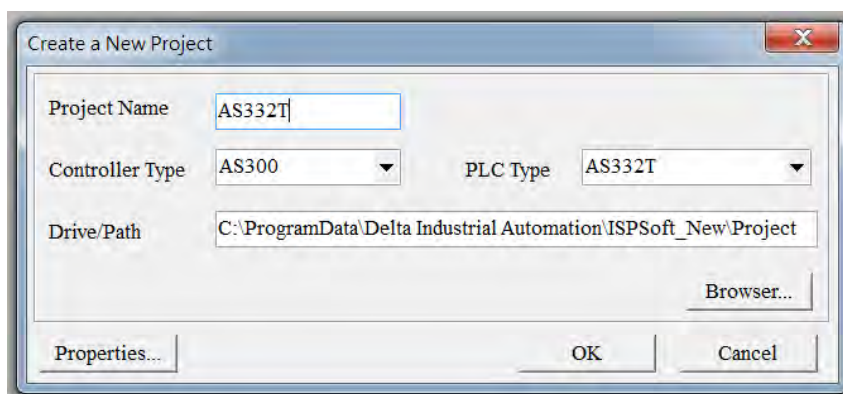

In the **Create a New Project** dialog box, type a project name in the **Project Name** box and a path in the **Drive/Path** box, select a PLC in the **PLC Type** drop-down list box, and then click **OK**. The PLC in this example is the AS332T.



After you create the project, a project management area appears at the left side of the main screen. The relation between the items listed in the project management area is represented by a hierarchical tree structure. If the project management area does not appear, on the **View** menu, click **Workspace**, or click  on the toolbar.

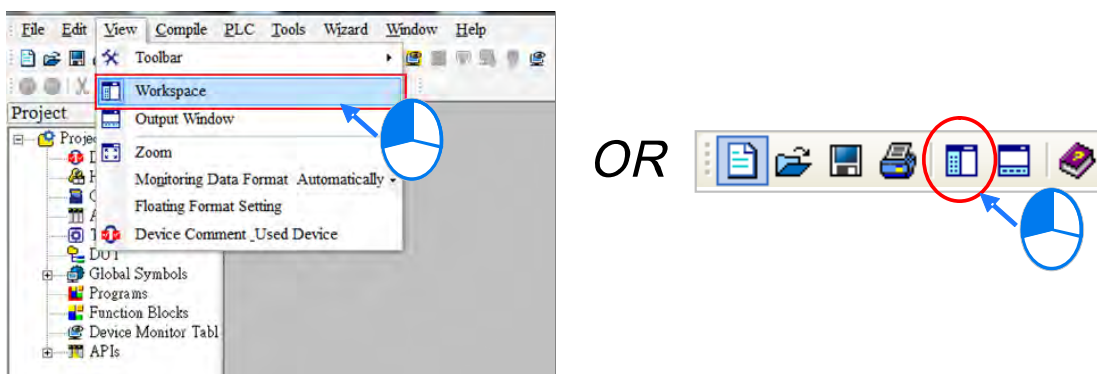

6.4 Hardware Configuration

After you double-click **HWCONFIG** in the project management area, the **HWCONFIG** window appears.

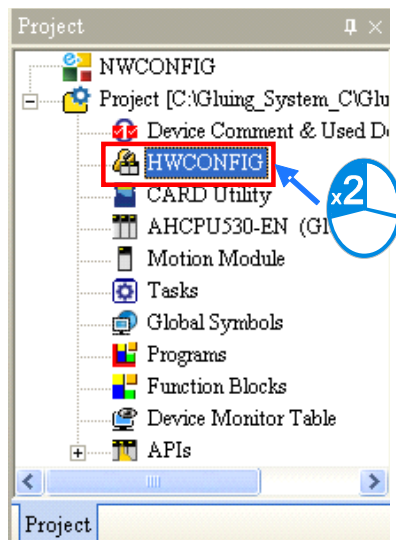

In the **HWCONFIG** window, the default setting is for a CPU module. Refer to Chapter 8 for more information on settings for other types of modules.

When the hardware configuration is complete, download the configuration and the settings to the CPU module to take effect. Save the configuration and settings now, and you can download them with the program later in the project. After that close the **HWCONFIG** window.

6.5 Creating a Program

The following sections show you how to create a traditional ladder diagram in ISPSOft. The sections include creating a POU, editing a traditional diagram, and compiling a program.

6.5.1 Adding a Ladder Diagram

- (1) Right-click **Programs** in the project management area, point to **POU** (program organization unit), and then click **New....**

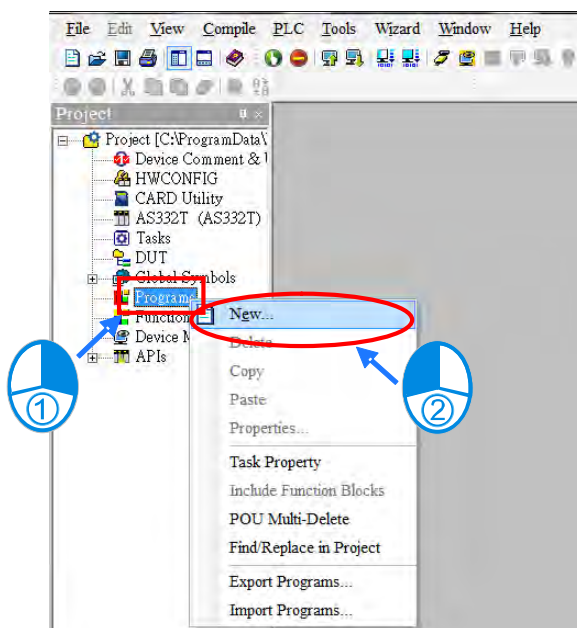

- (2) In the Create Program dialog box, type a program name in the **POU Name** box, select **Ladder Diagram (LD)** in the **Language** section, and keep the other default values. Click **OK** after the setting is complete. A new program organization unit (POU) appears under **Programs** in the project management area.

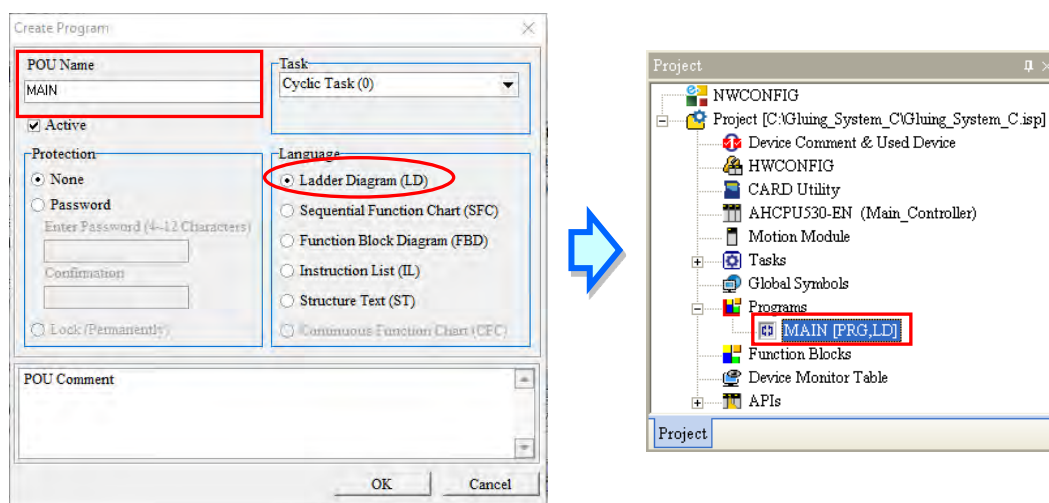

(3) After you add the POU, a program editing window appears in the main working area.

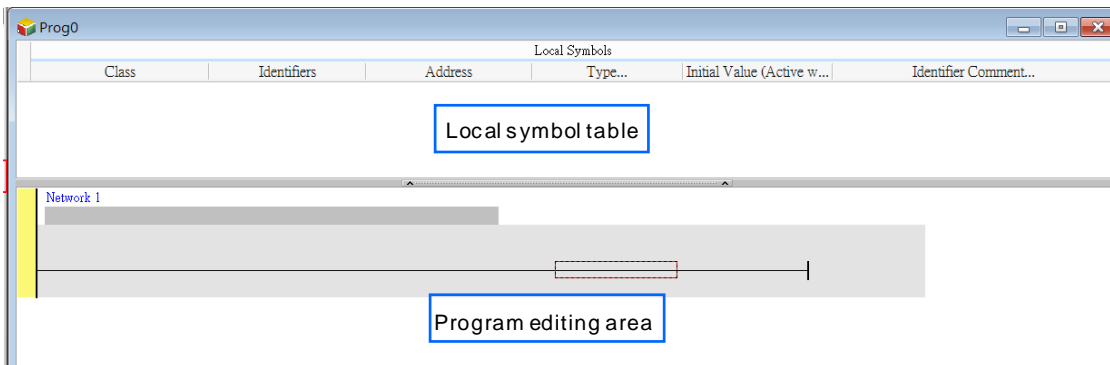
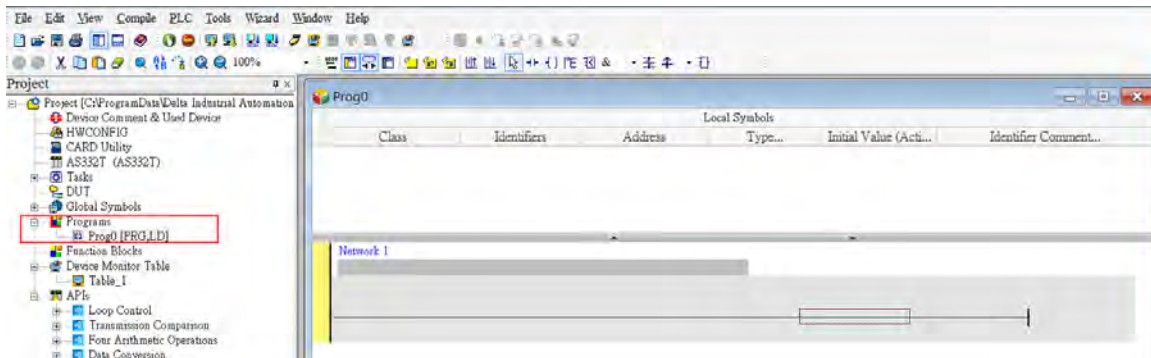

After the program editing window opens, the corresponding toolbar appears in the window. The list below describes the functions.



Icon	Keyboard shortcut	Function
	None	Switches to the address mode
	Shift+Ctrl+C	Display/hides the comments on the networks
	None	Displaying/hides the commands on the devices
	Shift+Ctrl+B	Adds a bookmark to the selected network selected or deletes a bookmark from the selected network
	Shift+Ctrl+P	Goes to the previous bookmarked position
	Shift+Ctrl+N	Goes to the next bookmarked position
	Ctrl+I	Puts a network above the selected network
	Shift+Ctrl+I	Put a network under the selected network
	ESC	Selects an item
	Typing an instruction	Inserts a contact

Icon	Keyboard shortcut	Function
	Typing an instruction	Inserts a coil
	Typing an instruction	Inserts a comparison contact
	Typing an instruction	Selects a type of comparison contact
	Typing an instruction	Inserts a block logic instruction (NP/PN/INV/FB_NP/FB_PN)
	Typing an instruction	Selects a type of block logic instruction (NP/PN/INV/FB_NP/FB_PN)
	Shift+Ctrl+U	Inserts an instruction or a function block

*. Refer to Section 6.5.3 for more information about typing an instruction.

6.5.2 Basic Editing – Creating a Contact and a Coil

- Click on the toolbar, and then move the mouse cursor to the red frame in Network 1. The mouse cursor changes to a contact when the mouse cursor is moved to the left, right, or bottom of the red frame. Decide where to insert a contact. If you edit a ladder diagram, the mouse cursor must be near a position you want to edit. The system automatically arranges an inserted object; you cannot move the object.

In this example, you do not need to decide where to insert the contact. Place the mouse cursor near the red frame and click the left mouse button.

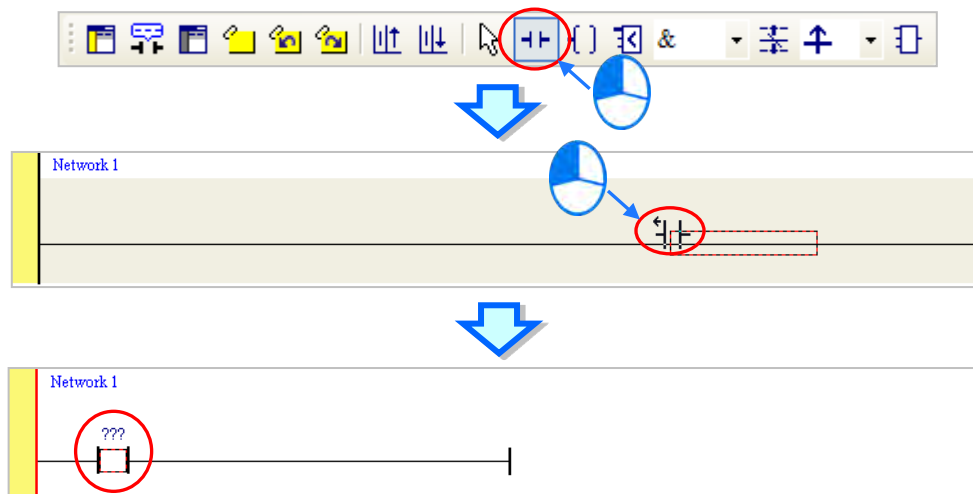

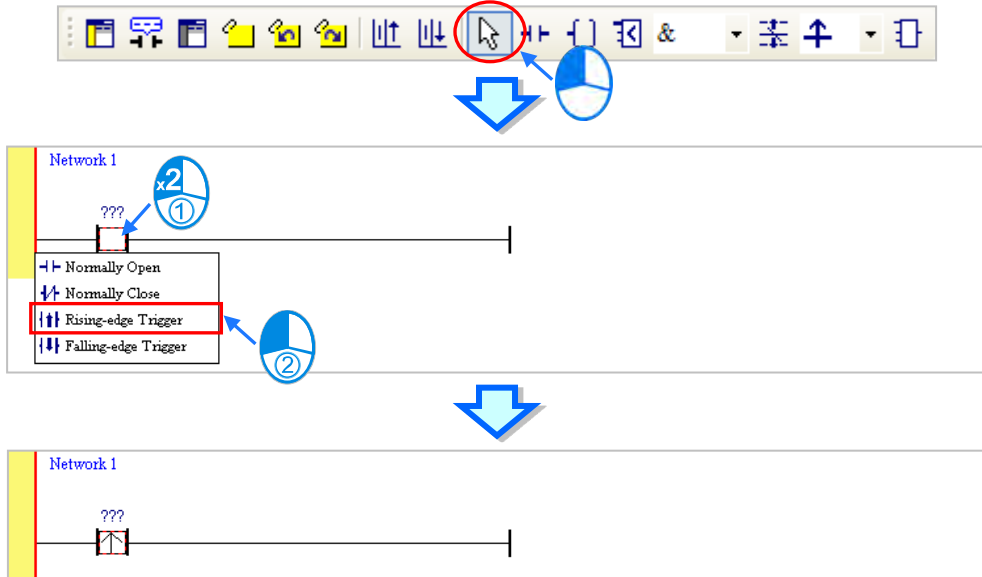

- (2) Click  on the toolbar, or press Esc on the keyboard. After you double-click the contact, a list appears. The items on the list are **Normally Open**, **Normally Close**, **Rising-edge Trigger**, and **Falling-edge Trigger**. In this example, click **Rising-edge Trigger**.

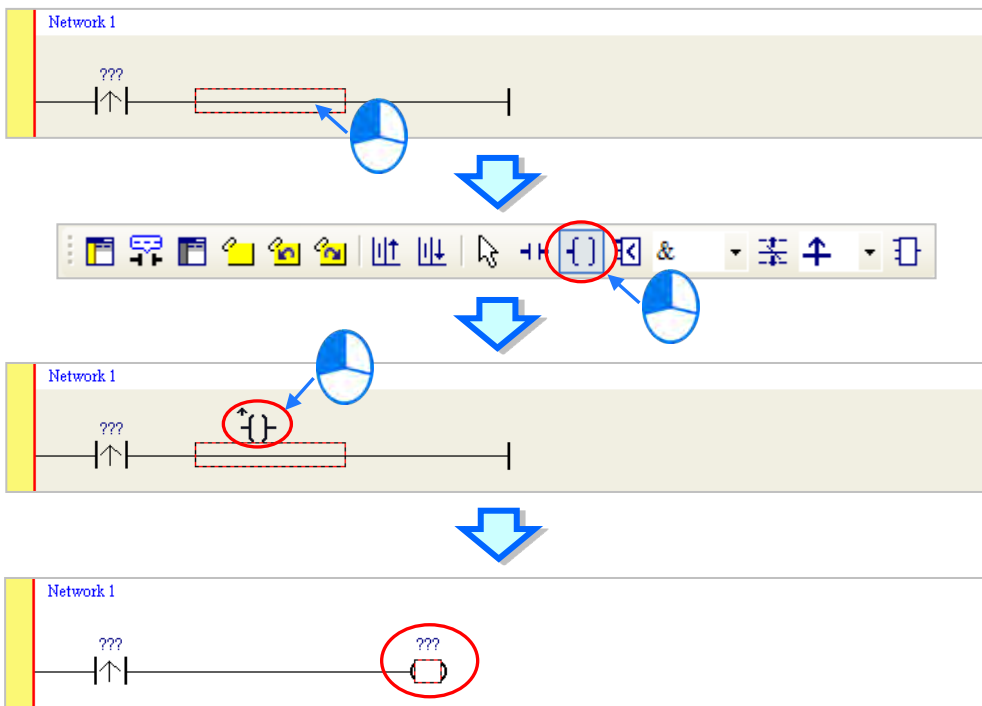

- (3) Click the line at the right side of the contact, click  on the toolbar, and then move the mouse cursor to the red frame. The mouse cursor changes to a coil when the mouse cursor is above or under the red frame. Decide where to insert the coil.

In this example, you do not need to decide where to insert the coil. Place the mouse cursor near the red frame and click the left mouse button.



- (4) Click  on the toolbar, or press Esc on the keyboard. After you double-click the coil, a list appears. The items on the list are **Out**, **Set**, and **Reset**. In this example, click **Set**.

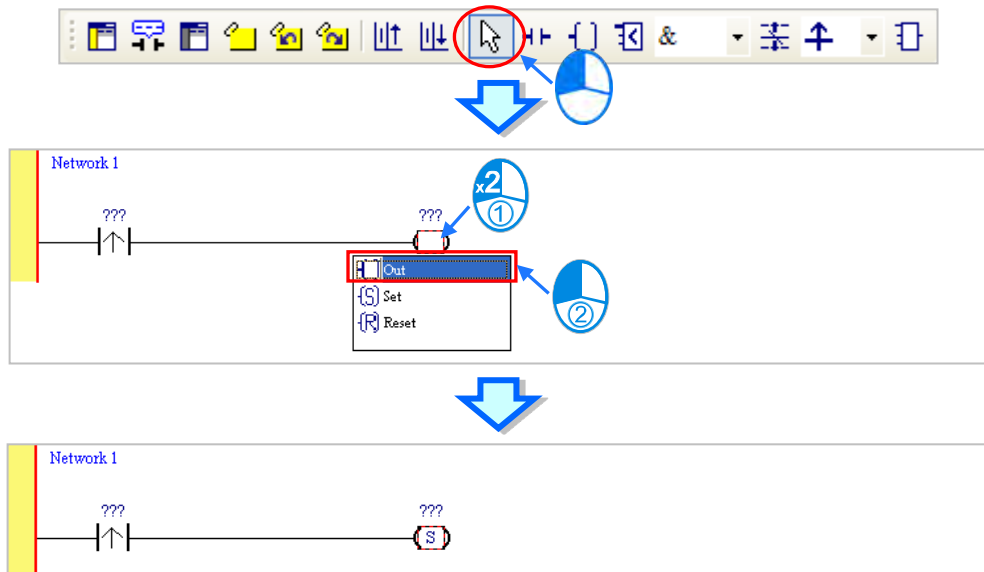

- (5) Click **???** above the contact, type a device address in the box, and then press Enter on the keyboard to jump to the next box in the network. After you type a device address in the box, press Esc on the keyboard to complete the editing. In this example, type X0.0 in the box for the contact, and type M0 in the box for the coil.

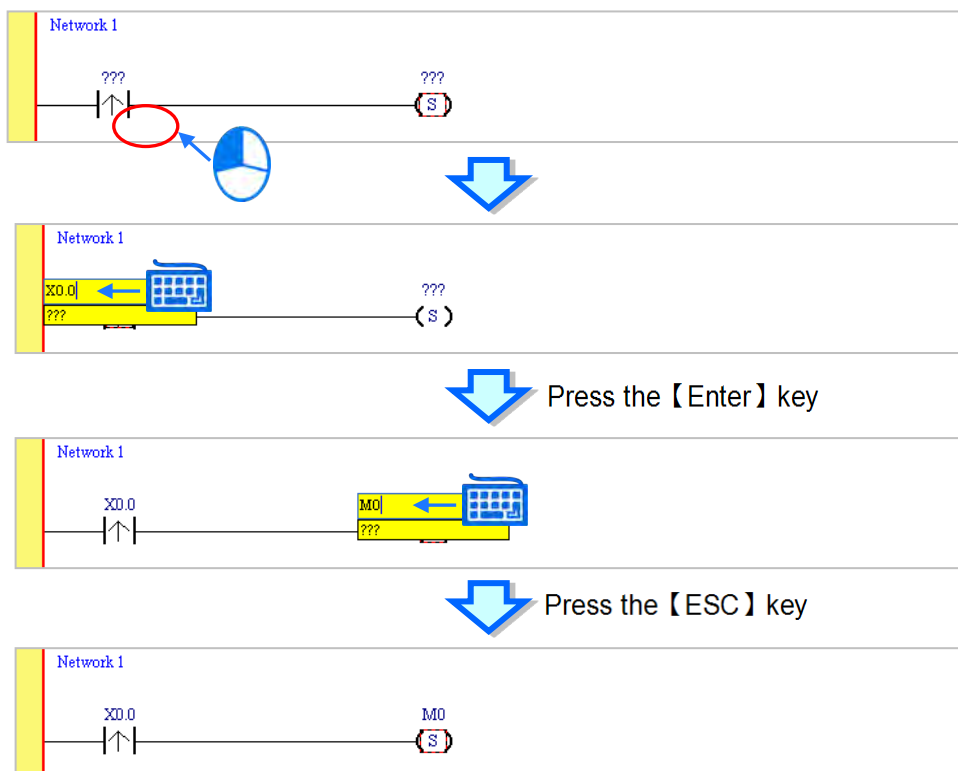

Additional remark

After you click a network and press Enter on the keyboard, you can edit a box. Press Enter on the keyboard to edit the next box in the network. Press Tab on the keyboard to select the next network. Use the keyboard to edit boxes. After you finish the editing, press Enter on the keyboard to jump to the next box. Press Esc on the keyboard to exit editing.

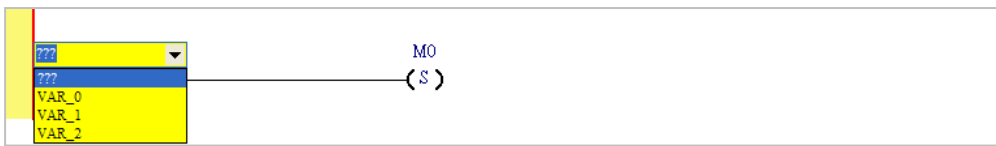

If you have declared symbols, click  in a box, or press Page Down on the keyboard when you edit the box. The symbols on the drop-down list are the symbols that you can assign to the object. Select a symbol with the mouse or the up/down key on the keyboard. Refer to Chapter 6 in the ISPSOft User Manual for more information about symbols.

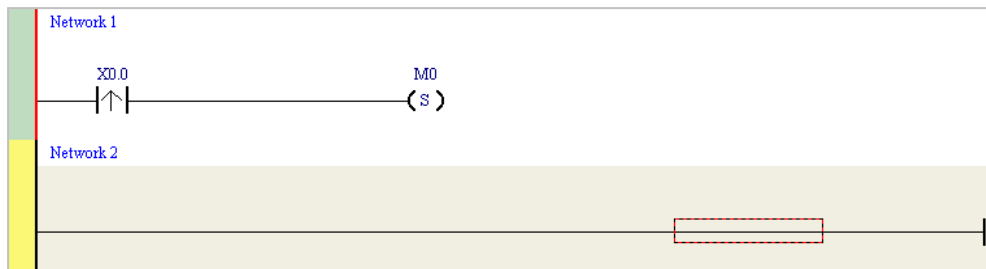

6.5.3 Basic Editing – Inserting a Network and Typing an Instruction

Click  on the toolbar to select a network. Click  on the toolbar to place another network above the selected network. In this example, Network 2 is under Network 1.



Create a contact and a coil by clicking  and  on the toolbar or by typing instructions.

(1) Click the line in Network 2.

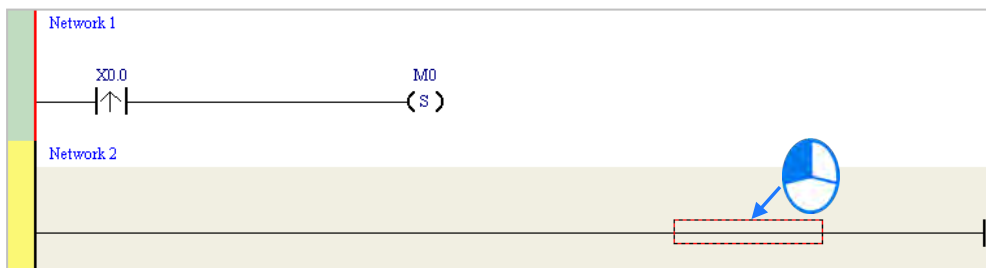

- (2) Type the IL instruction “LD M0”. This instruction is not case-sensitive. As soon as you type the IL instruction, a box which you can edit appears. After you finish typing the IL instruction, press Enter on the keyboard or click **OK** at the right side of the box.

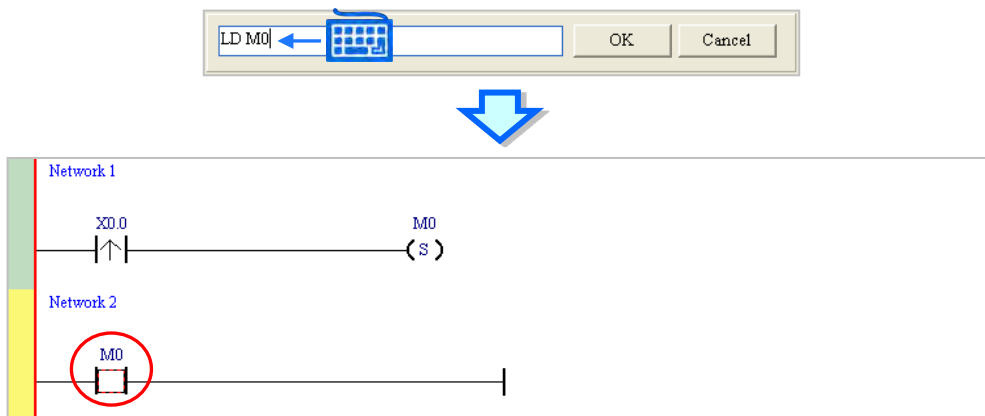

- (3) Type the IL instruction “OUT Y0.0”, and write the program shown below.

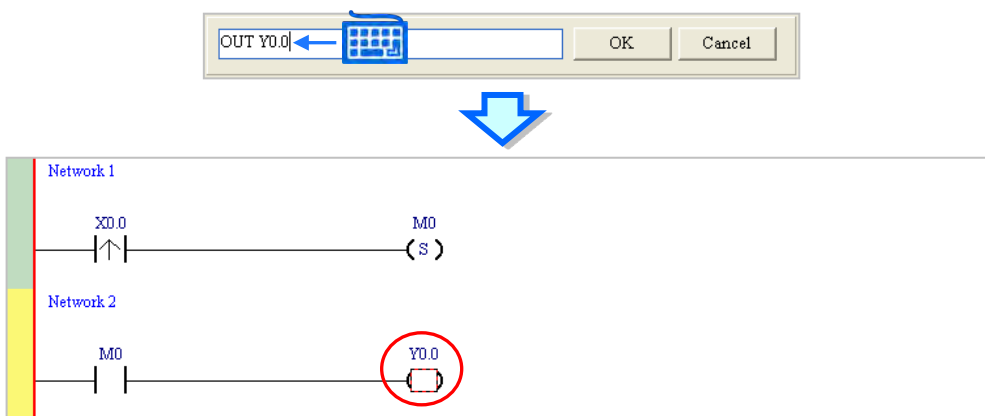

Additional remark

You create a contact and a coil by typing simple instructions. Refer to the description below. The instructions typed are not case-sensitive.

- To Insert a normally-open contact (contact A), type “A <device address>”

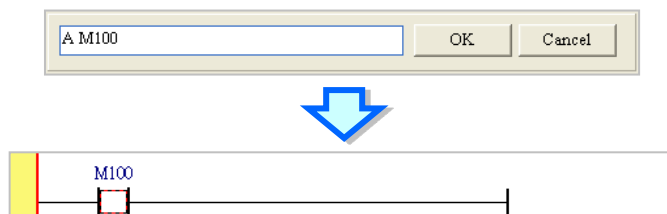

- To insert a normally-closed contact (contact B), type “B <device address>”

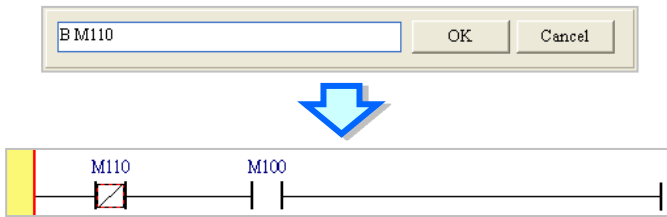

- To insert an output coil (OUT), type “O <device address>”

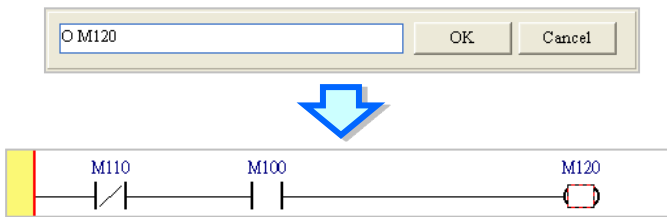

6.5.4 Basic Editing – Selecting a Network and Operation

Before you select an object in a network, press Esc on the keyboard, or click  on the toolbar. After the cursor appears as a small arrow, click the object in the network. The basic selection shows below.

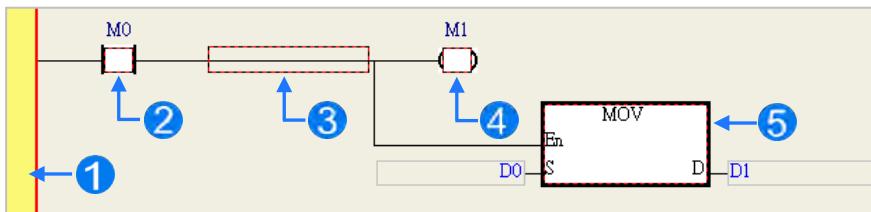

- 1 Select the network
- 2 Select the input contact
- 3 Select the network
- 4 Select the output coil
- 5 Select the block

To select a group of devices, click a device and drag it to draw a frame around the group of devices. You can also select the group of devices by clicking the first device, pressing Ctrl+B on the keyboard, clicking the last device, and then pressing Ctrl+B on the keyboard. You must draw a frame around devices that are in the same network, and the devices must be adjacent to one another. Input and output devices cannot be in the same frame.

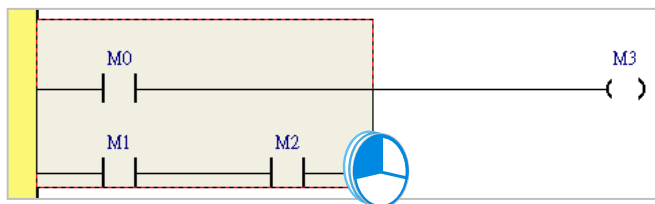

To select several networks, press and hold the Ctrl key on the keyboard and click the networks. You can also select a range of networks by pressing and holding Shift on the keyboard, clicking the first network within the range, and then clicking the last network within the range.

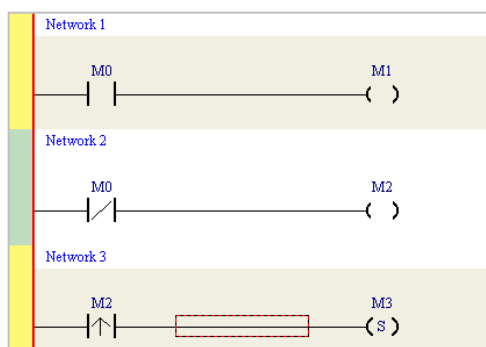

Right-click an object after selecting it to show the context menu.

Item	Function
Undo	Undo the last action. You can undo up to 20 previous actions.
Redo	You can redo an action that has been undone.
Cut	Cut a device, block, or network.
Copy	Copy a device, block, or network.
Paste	Paste an object that has been copied or cut into the present position.
Paste right	Paste an object at the right side of the selected position. The object is connected in series to the selected position.
Paste under	Paste an object under the selected position. The object is connected in parallel to the selected position.
Delete	Delete a device, block, or network.
Activate/Inactivate Network	Activate or deactivate the selected network. The deactivated network is ignored when you compile the program.
Fold/Unfold Network	Fold or unfold the network section.
Auto Generate Symbols	Used on the contacts of the function block to generate symbols automatically.

Item	Function
Add to Device Monitor Table	Used on the selected contacts to quickly add the device to the Monitor Table.

Proceed with the steps in the example below.

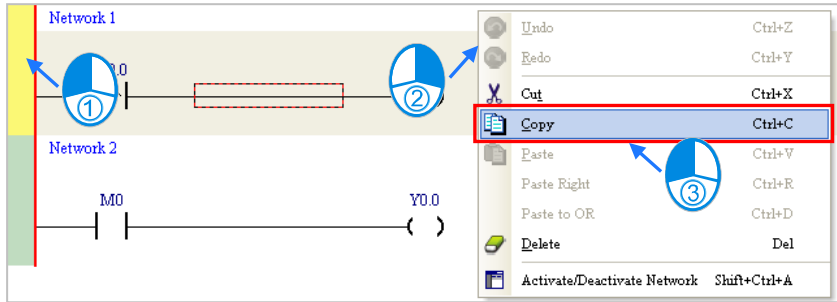

- (1) Select Network 1, then right-click Network 1, and then click **Copy**.

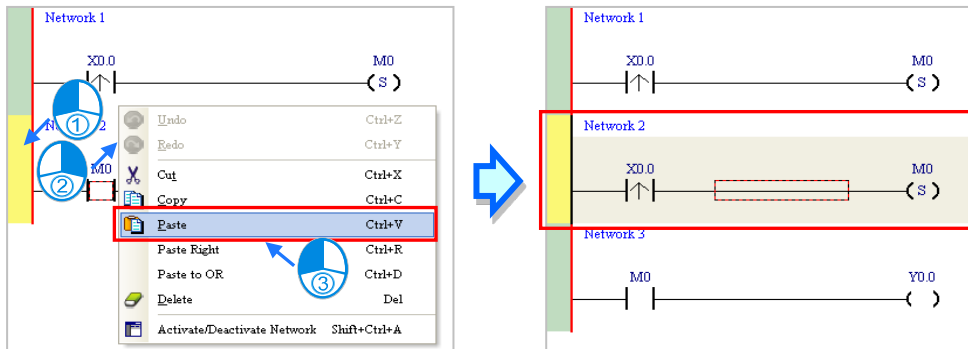

- (2) Select Network 2, right-click Network 2, and then click **Paste**. A copy of Network 1 is put above Network 2, and Network 2 becomes Network 3.



6.5.5 Basic Editing – Connecting a Contact in Parallel

- (1) Click  on the toolbar, and then move the mouse cursor to the input contact in Network 2. The mouse cursor changes to a contact. Move the mouse cursor to the input contact in Network 2. After the mouse cursor changes to , click the left mouse button. This connects a contact in parallel with the input contact in Network 2.

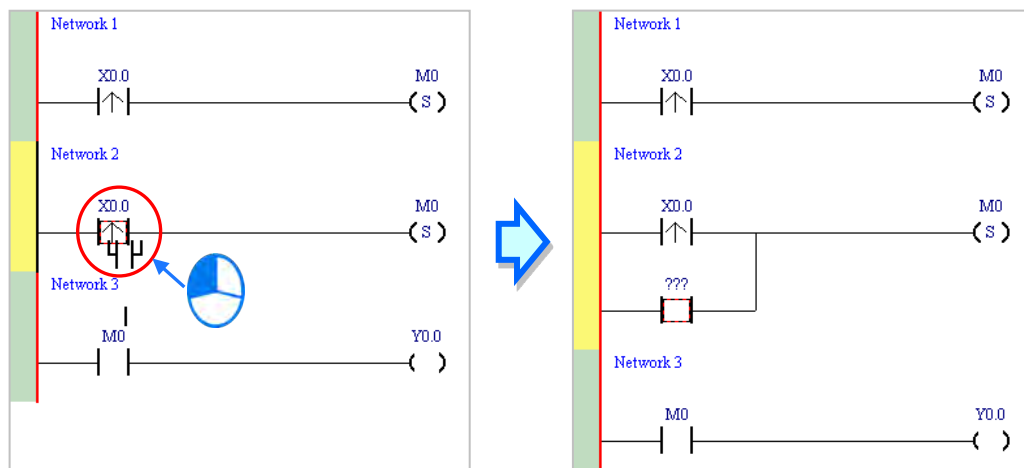

- (2) Write the program in Network 2 shown below.

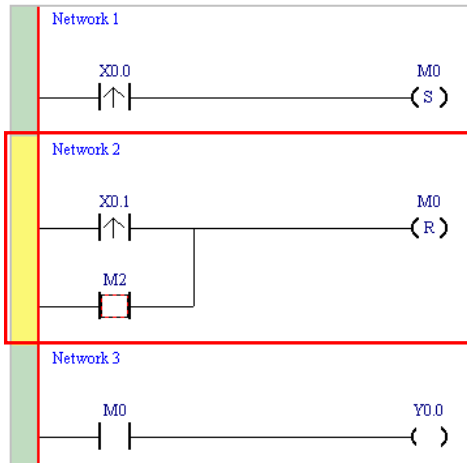

Additional remark

After you select a group of contacts, connect a contact to the group of contacts as described above.

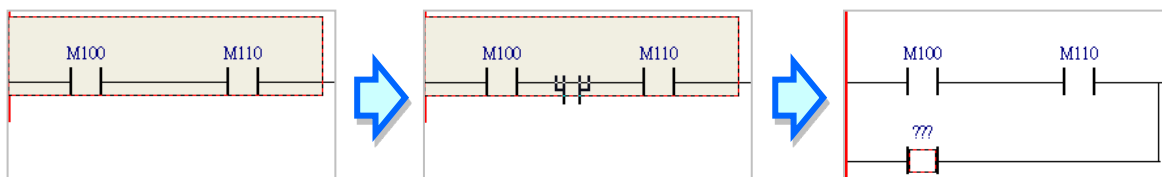

6.5.6 Basic Editing – Editing a Comment

- (1) Press  on the toolbar. Click the position above a device name, type a comment in the box, and then press Enter on the keyboard.

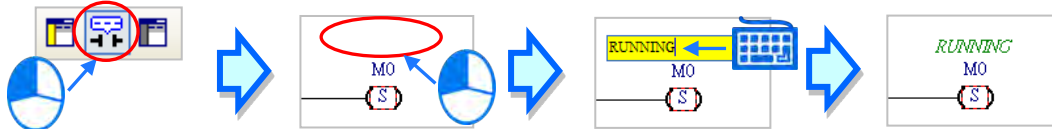

- (2) Press  on the toolbar. Click the position under a network number, and then type a comment in the box. To start a new line of text, press Shift+Enter on the keyboard. Press Enter on the keyboard after the you complete the editing.

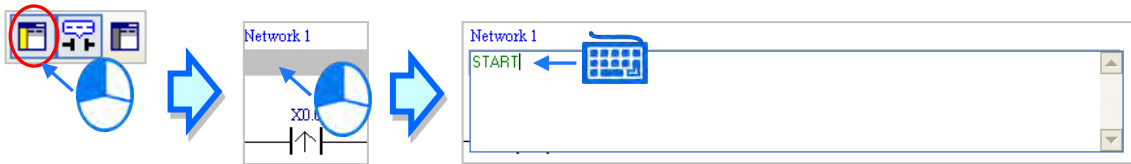

- (3) Write the program shown below.

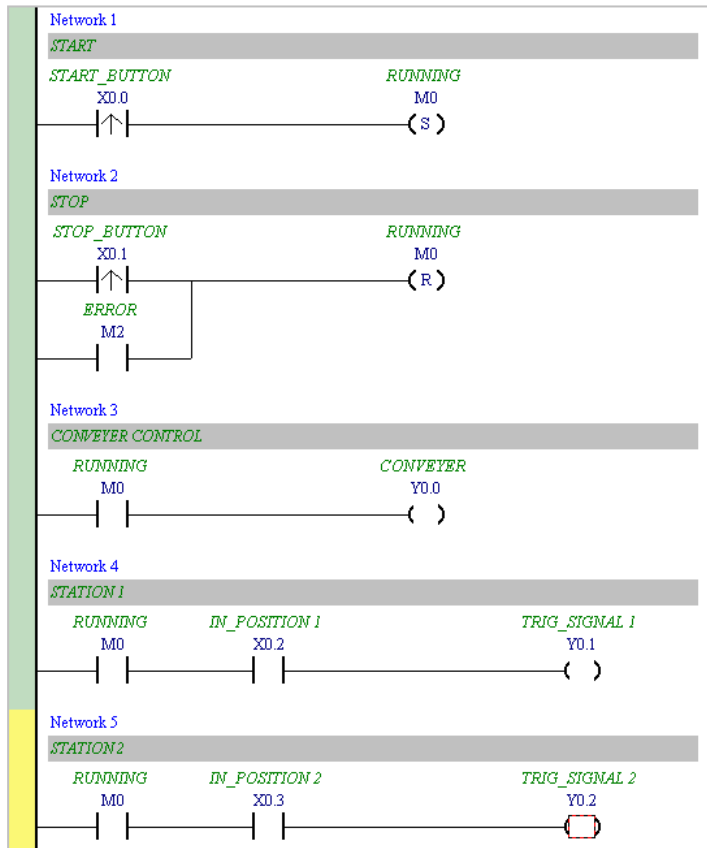

6.5.7 Basic Editing – Inserting an Applied Instruction

Add Network 6 under Network 5, and then write the program shown below. Insert an applied instruction in one of the three ways described below.

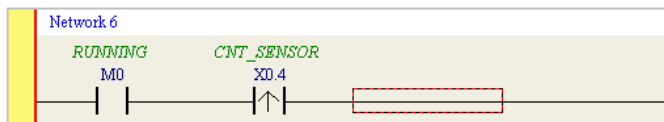

- Method 1

Click the position where you want to insert an instruction, type the instruction (INC in this example), and then press Enter on the keyboard.

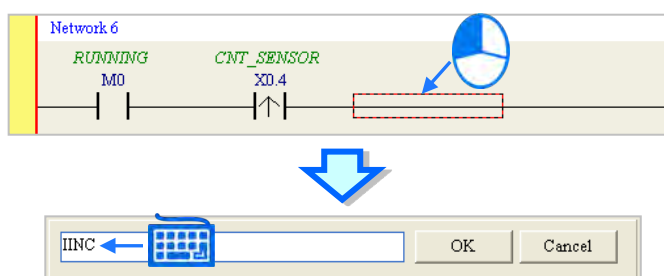

- Method 2

Click **APIs** in the project management area and find the instruction type.

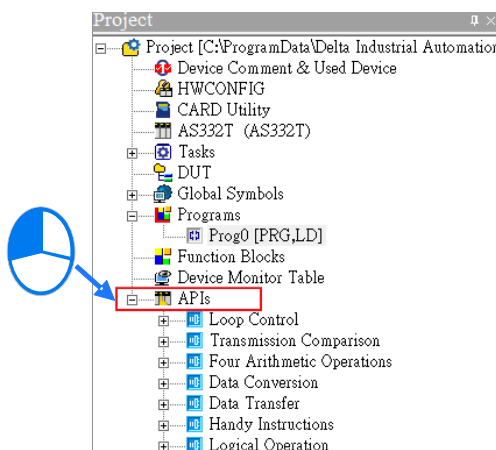

Click the instruction (INC in this example) that you want to insert, and then drag it to the desired position.



- Method 3

Click the position where you want to insert an instruction, click  on the toolbar, select the instruction (INC in this example) to insert in the **API/FB** dialog box, and then click **Insert**.

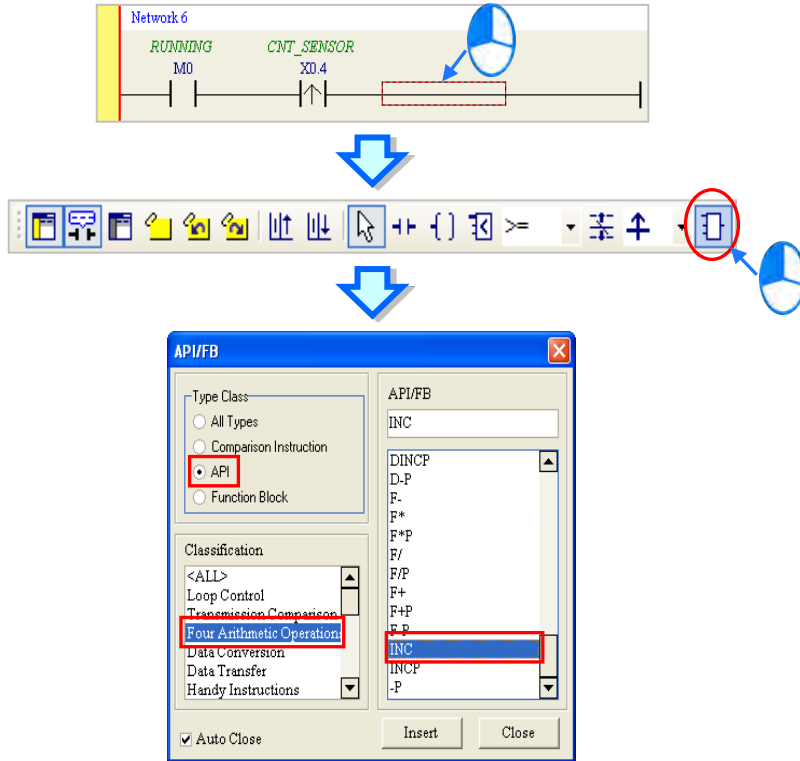

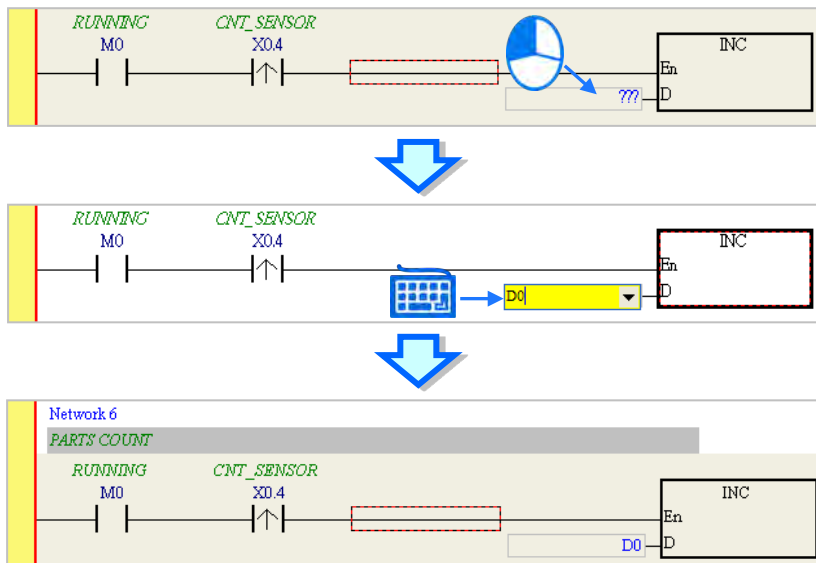

After you insert the instruction, assign a device address to the operand, and write the program shown below.

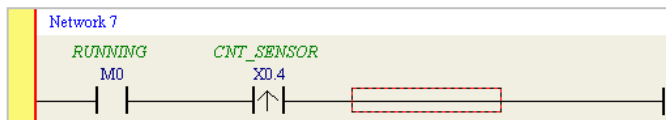

6.5.8 Basic Editing – Creating a Comparison Contact and Typing a Constant

You can insert a comparison contact with the following steps. Add Network 7 under Network 6, and write the program shown below.



- (1) Click  on the toolbar, and then select an operator (\geq in this example).



- (2) Click  on the toolbar, and then move the mouse cursor to the position where you want to insert the comparison contact. The mouse cursor changes to a comparison contact when you move the mouse to the left, right, or bottom of the red frame. Decide where to insert the comparison contact, and then click the left mouse button to insert the comparison contact.

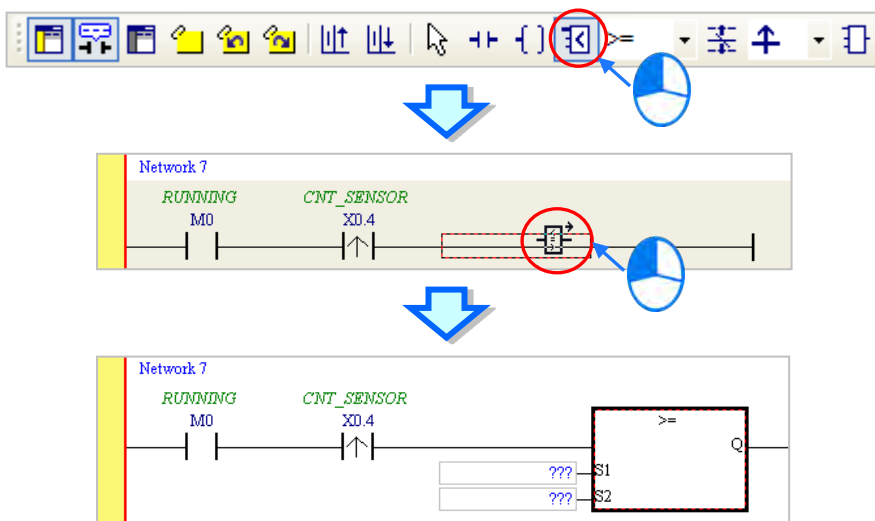

Write the program shown below. In ISPSOft, K precedes a decimal value and H precedes a hexadecimal value. To type a decimal value in ISPSOft, type it directly. To type a hexadecimal value in ISPSOft, type “16#” and the hexadecimal value; e.g. 16#7FFF. In ISPSOft, 8# precedes an octal value, and 2# precedes a binary value.

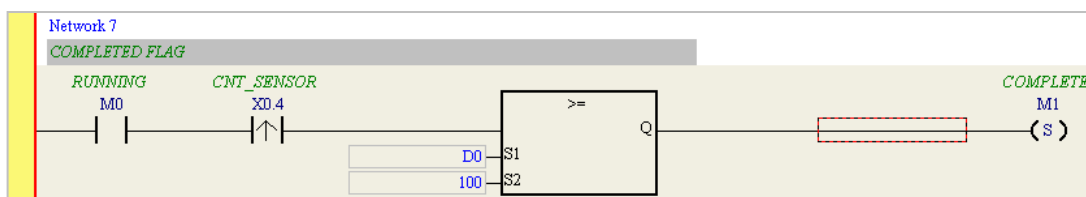

6.5.9 Writing a Program

The previous sections introduced creating a traditional ladder diagram in ISPSOft. Write the program shown below. Because the program is not yet compiled for the PLC, the mother line at the left side of the ladder diagram is colored red while you write the program. The following sections show how to compile and download the compiled program for testing.

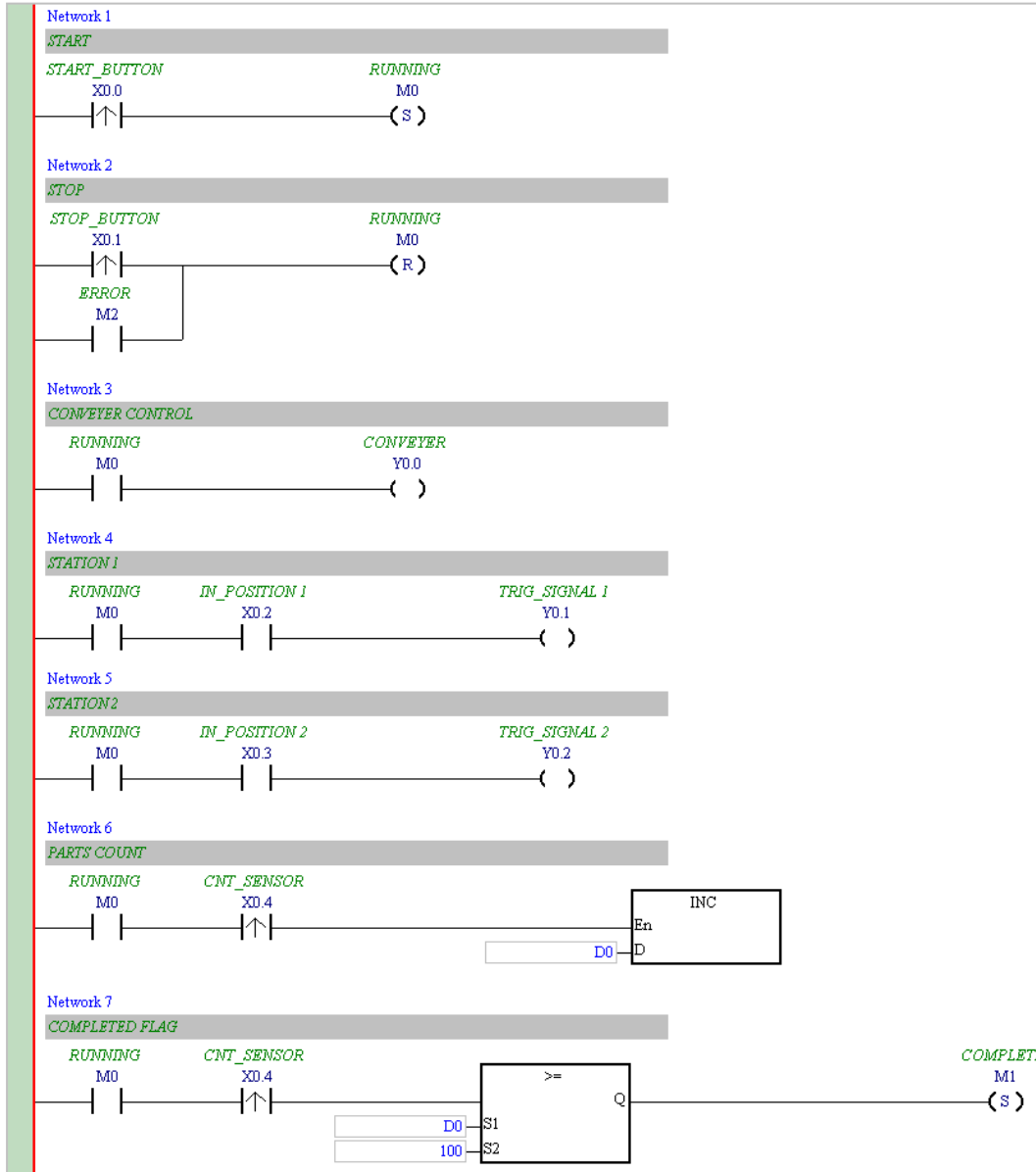

*1. The program above saves in the folder ...\ISPSOft x.xx\Project\Example\Gluing_System_C.

*2. Refer to Chapter 10 in the ISPSOft User Manual for more information about creating a ladder diagram.

6.5.10 Checking and Compiling a Program

After you write a program, check the syntax of the programming language or compile the program. The syntax and structure in the present window are checked after you run the **Check** function. The system checks the entire project after you run the **Compile** function. If the system does not find any errors in the project, it automatically generates execution code. After you successfully compile the program, the mother line at the left side of the ladder diagram becomes black.

- **Check**

From the **Compile** menu, click **Check**, or  on the toolbar.



- **Compile**

From the **Compile** menu, click **Compile**, or  on the toolbar.



After you complete the check, the **Compile Message** page shows the check result. If there are any errors in the project, the **Compile Message** window shows the related message. After you click the message, the system automatically shows you where the error occurs. You can run the **Check** function or the **Compile** function after you correct the error.

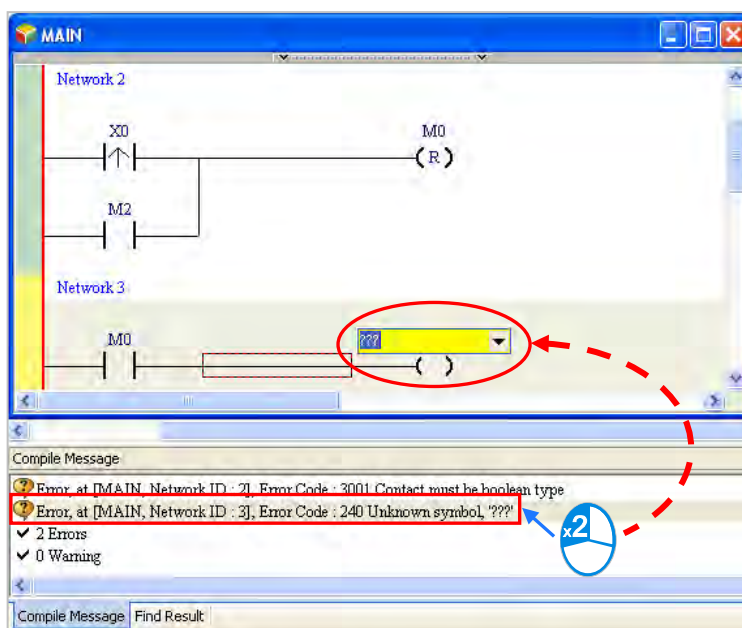

6.6 Testing and Debugging a Program

6.6.1 Creating a Connection

Before you download a program and parameters to a PLC or monitor them online, connect ISPSOft to the PLC. In this example, connect ISPSOft to the CPU module AS332T-A with a USB cable. Refer to Section 2.4 in the ISPSOft User Manual for more information about connecting ISPSOft to a PLC in other ways. Refer to the AS Operation Manual for more information about wiring.

You can skip this section if you have connected ISPSOft to a PLC successfully as described in Section 2.4 in the ISPSOft User Manual.

- (1) Install the modules on the main backplane to match the hardware configuration in HWCONFIG. Make sure that the wiring is correct, and then power on the CPU module.
- (2) Connect the CPU module to the computer with a USB cable. If the USB driver for the AS series CPU module is installed on the computer, **Delta PLC** appears in the **Device Manager** window, and a port number is assigned to **Delta PLC**. Refer to Appendix A for more information about installing a USB driver.
- (3) Make sure that COMMGR is started and the icon representing COMMGR is displayed on the system tray. If the icon representing COMMGR is not displayed on the system tray, start COMMGR by clicking the shortcut on the **Start** menu (**Start > Programs > Delta Industrial Automation > Communication > COMMGR**).

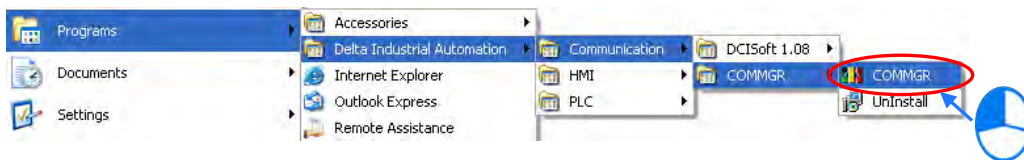

- (4) Double-click the icon representing COMMGR on the system tray to open the **COMMGR** window. Click **Add** in the **COMMGR** window to create a driver.

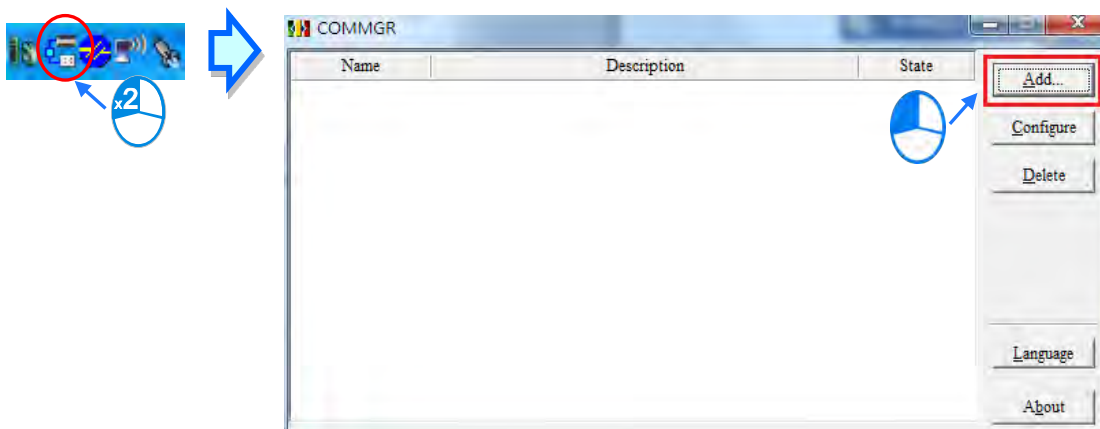

- (5) Set the parameters in the **Driver Properties** dialog box, and then click **OK**.

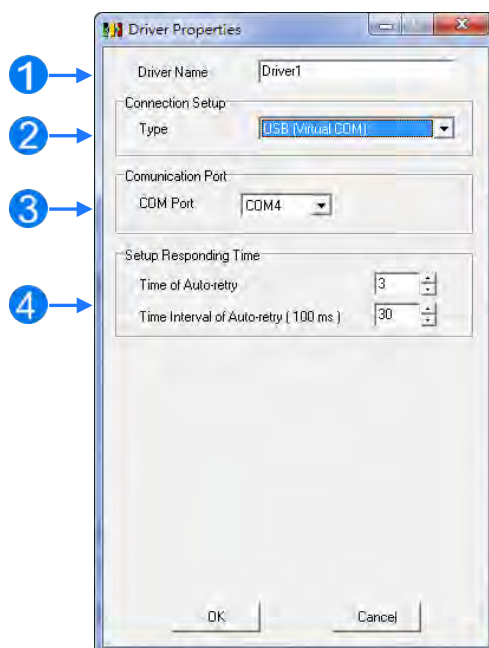

- ① Type a driver name in the **Driver Name** box.
 - ② Select **USB (Virtual COM)** in the **Type** list in the **Connection Setup** section.
 - ③ Select a communication port in the **COM Port** list. If the first two steps are complete, the connected PLC and its communication port display in the **COM Port** list.
 - ④ Select the number of times to retry the sending of a command if a connection error occurs in the **Time of Auto-retry** box, and select a retry interval in the **Time Interval of Auto-retry** box.
- (6) After you finish the setup, USB_Driver appears in the COMMGR window. When the connection is normal, OK appears in the Status column.

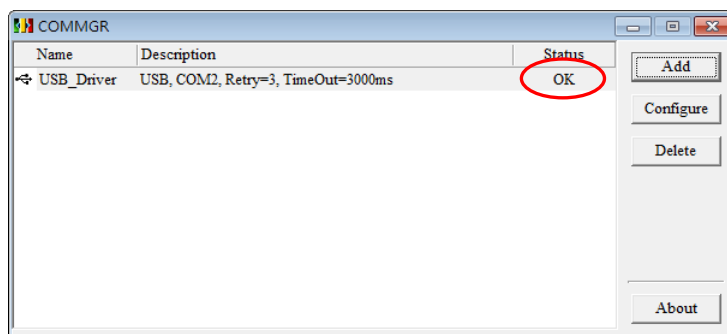

- (7) Click the driver you created in the **COMMGR** window, and then click **Start**. Start ISPSOFT, and then on the **Tools** menu, click **Communication Settings....** In the **Communication Setting** dialog box, select the driver you created in the **Driver** list, select 0 in the **Station Address** list, and then click **OK**. The driver information displays in the ISPSOFT status bar.

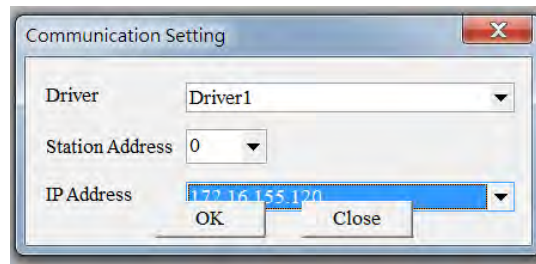
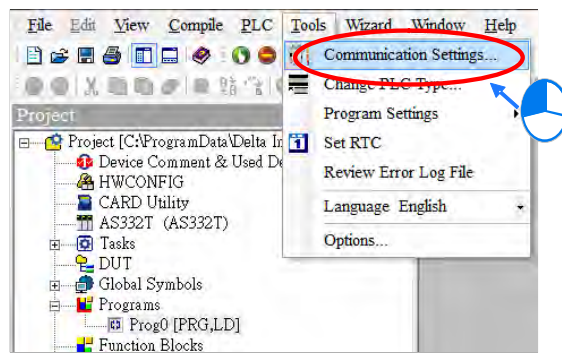

- (8) On the **PLC** menu, click **System Information**. ISPSOft retrieves related information from the PLC. If the computer communicates with the CPU module normally, the related information retrieved from the PLC displays in the **System Information** dialog box.

6

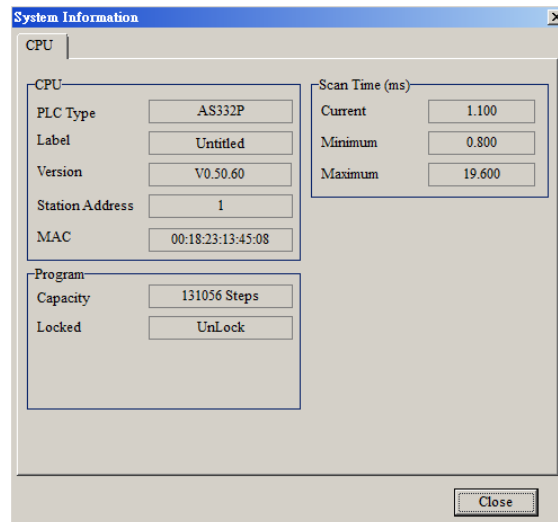

6.6.2 Downloading a Program and Parameters

If ISPSOft is correctly connected to a PLC, you can download the parameters and program in the project to the PLC. First, start ISPSOft and open the project you created in the previous sections. In this example, you download two types of parameters to the CPU module: hardware configuration and the program itself.

- **Downloading the hardware configuration**

- (1) Double-click **HWCONFIG** in the project management area to open the **HWCONFIG** window.

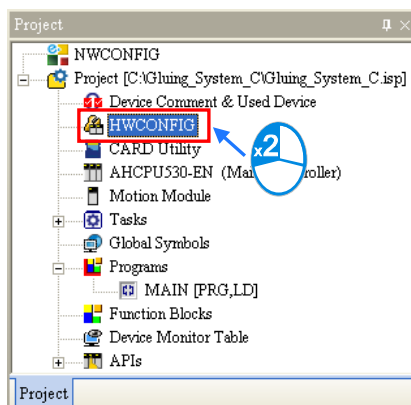

- (2) The hardware configuration displays in the window. Before you download the hardware configuration to the CPU module, make sure the actual hardware configuration is the same as the hardware configuration in the window.
- (3) Click **Download** under the Communication tab to see the Download page. Select the PLC parameters that you'd like to download to the PLC and then click **OK** to download.

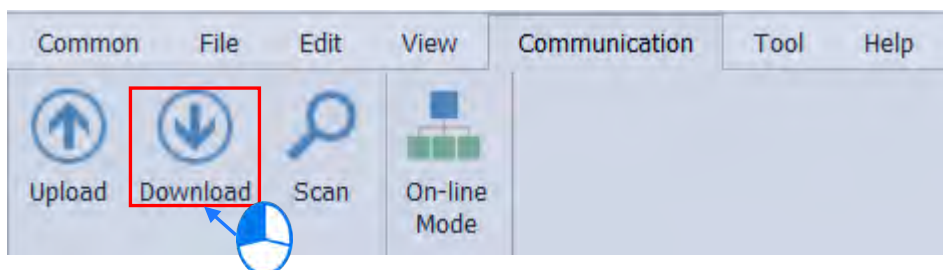

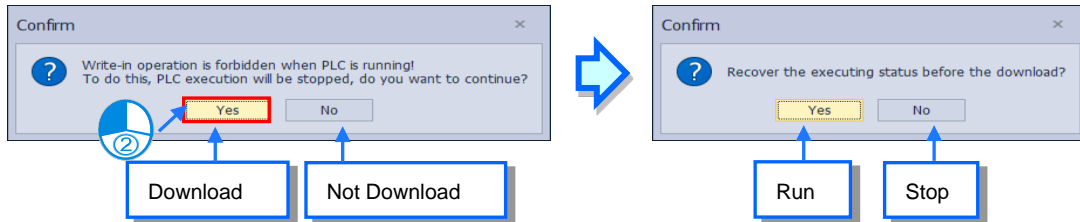
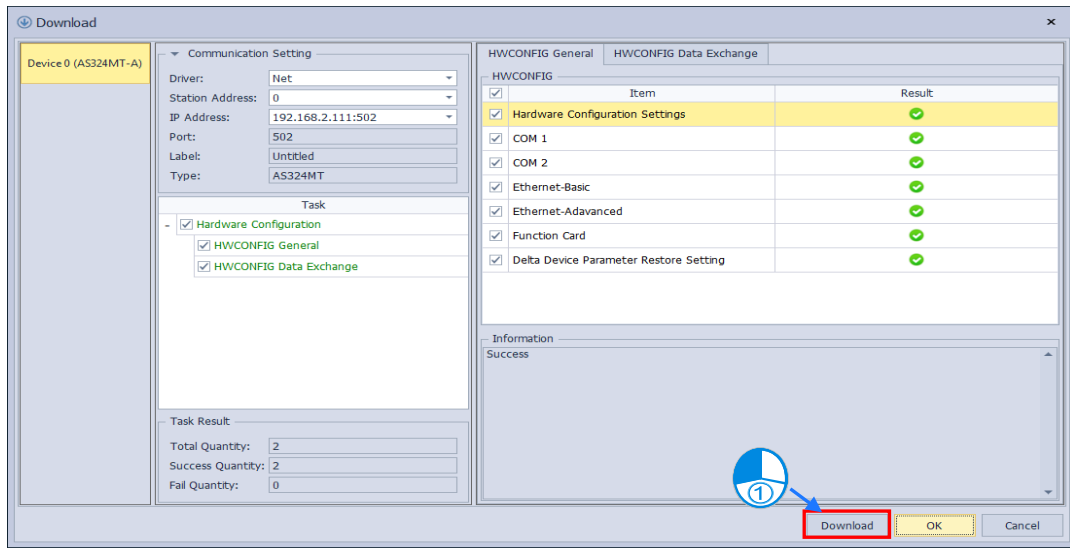

- (4) After you successfully download the hardware configuration to the CPU module, the BUS FAULT LED indicator on the CPU module is OFF. Close the **HWCONFIG** window. If the BUS FAULT LED indicator on the CPU module is still ON or blinking, the CPU module is in an abnormal state. Make sure the actual hardware configuration is the same as the hardware configuration in the **HWCONFIG** window, and refer to the operation manual for more information about eliminating the error. Refer to Chapter 8 for more information about HWCONFIG.

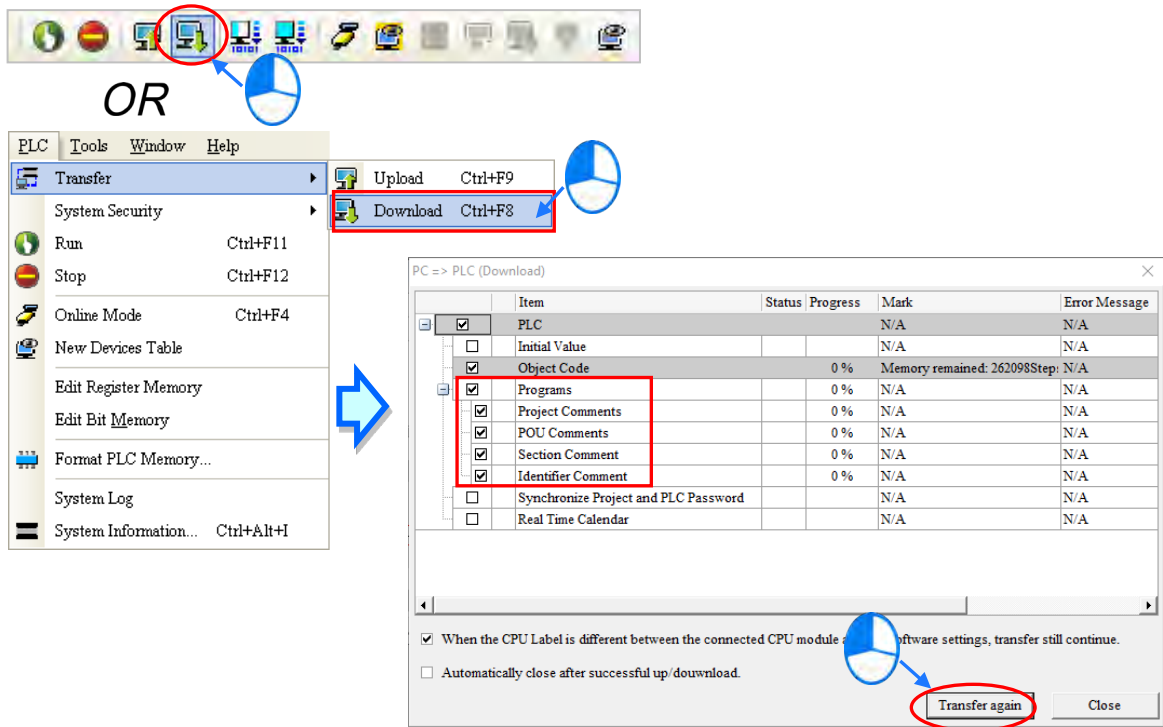

● **Downloading the program**

After the program is compiled, select **Transfer** under the PLC tab and click **Download** to see the Download page. You can also click  on the toolbar to see the Download page. Select the **Program** and the **Comments** so that you can upload the program in the CPU module later, and then click **Transfer** again.



6.6.3 Connection Test

After you download a program to a PLC, you can monitor the execution status of the PLC through ISPSOft. ISPSOft provides two monitoring modes; device monitoring mode and program monitoring mode.

Monitoring mode	Description
 Device monitoring mode	You can monitor the status of the devices in the PLC through the monitoring table. In this mode, ISPSOft updates only the status of the devices. The current program in ISPSOft does not have to be the same as the program in the PLC.
 Program monitoring mode	In this mode, the operating status of the program is displayed in the program editing window. The present program in ISPSOft must be the same as the program in the PLC.

*. You can enable the device monitoring function without program monitoring; however, if you enable the program monitoring function, the device monitoring function is also enabled.

On the **PLC** menu, click **Online Mode**, or  on the toolbar, to enable the online monitoring function. The system also enables device monitoring mode and program monitoring mode.

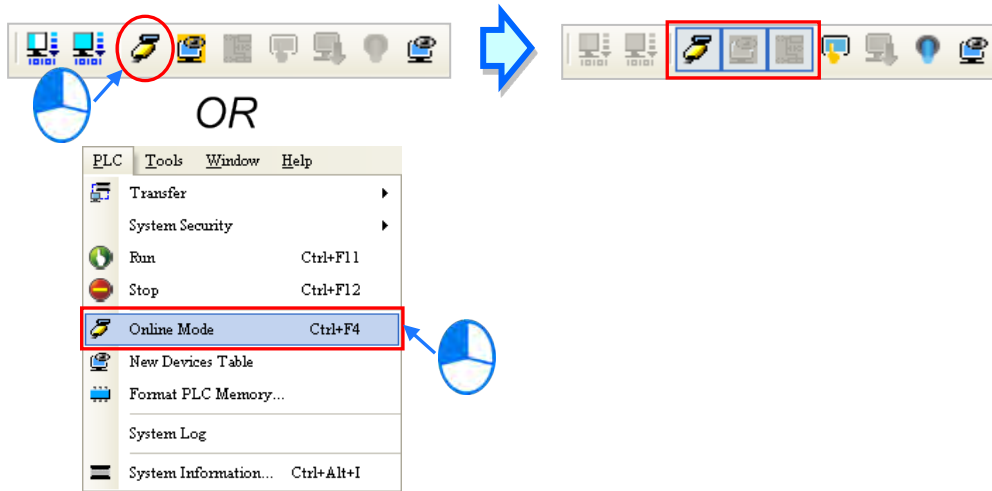



In the online monitoring mode, you can view the present scan time, the communication status, and the status of the PLC in the status bar in ISPSOft.

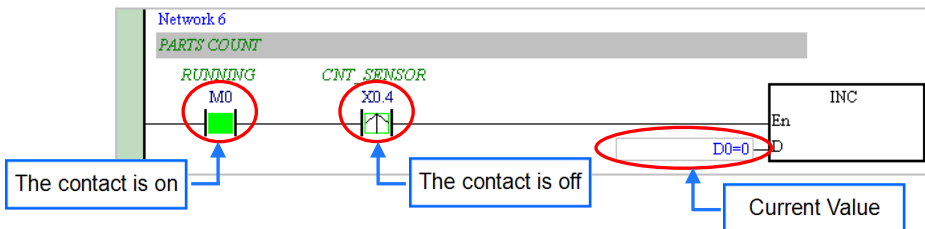

The present status of the devices display in the original program editing window after you enable the program monitoring function.



You can change the operating state of a PLC with the RUN/STOP switch on the PLC. You can also change the operating status of a PLC with the functions provided by ISPSOft. On the **PLC** menu, click **Run** or  on the toolbar to start the PLC. On the **PLC** menu, click **Stop** or  on the toolbar to stop the PLC.

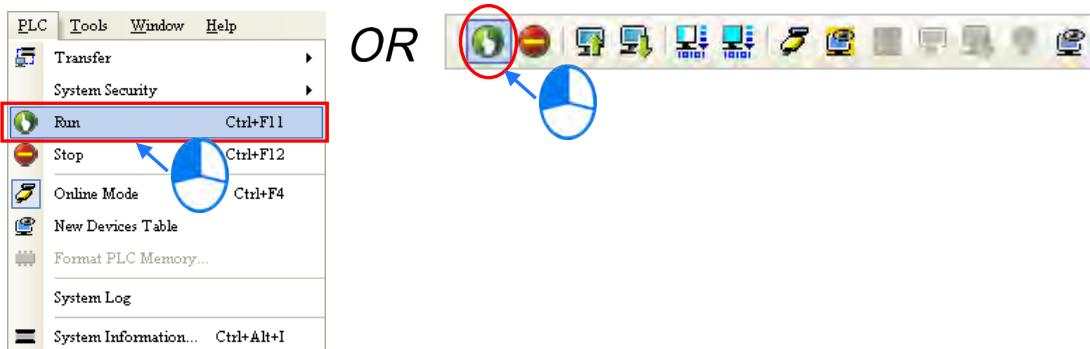

In the online monitoring mode, you can select a device, then right-click the device, and then click a command on the context menu. During a test, you can change the status of a device or the value in a device by clicking an item on the context menu.

⚠ Before you change the status of a device, make sure the operation does not cause damage to equipment or personnel.

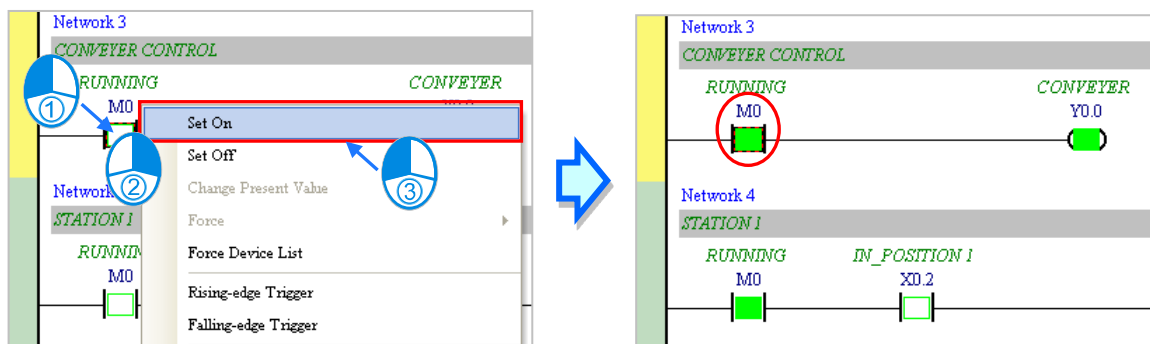

The table below describes the items in the context menu. The **Force** command only applies to input and output contacts.

Item	Description
Set On	Set the contact selected to ON
Set Off	Set the contact selected to OFF
Rising-edge Trigger	No matter what the state of the selected contact is, the system sets the contact to OFF, and then sets it to ON.
Falling-edge Trigger	No matter what the state of the selected contact is, the system sets the contact to ON, and then sets it to OFF.
Force	Force an input contact or output contact ON or OFF
Force Device List	Force several input contacts or output contacts in the tables ON or OFF

To change the value in a device, right-click the device, click **Change Present Value**, and set a present value in the **Enter Present Value** dialog box.

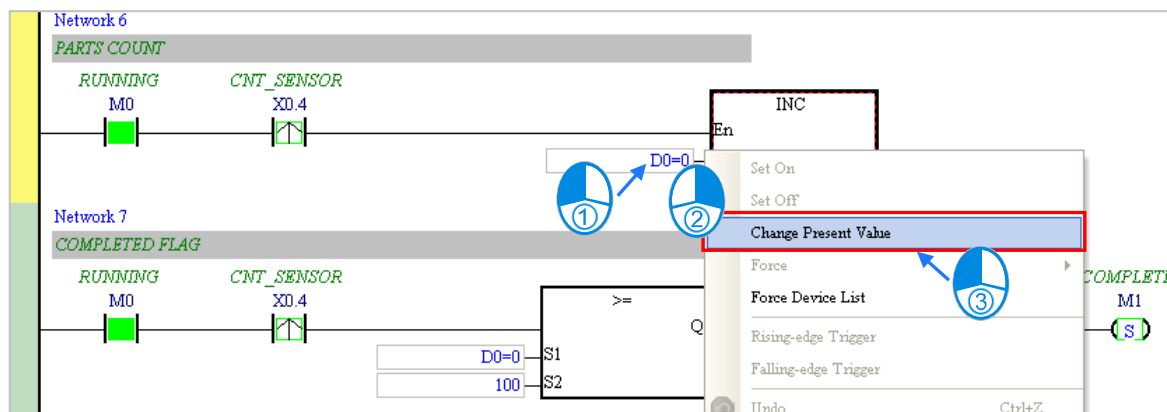

The list below describes the **Enter Present Value** dialog box.

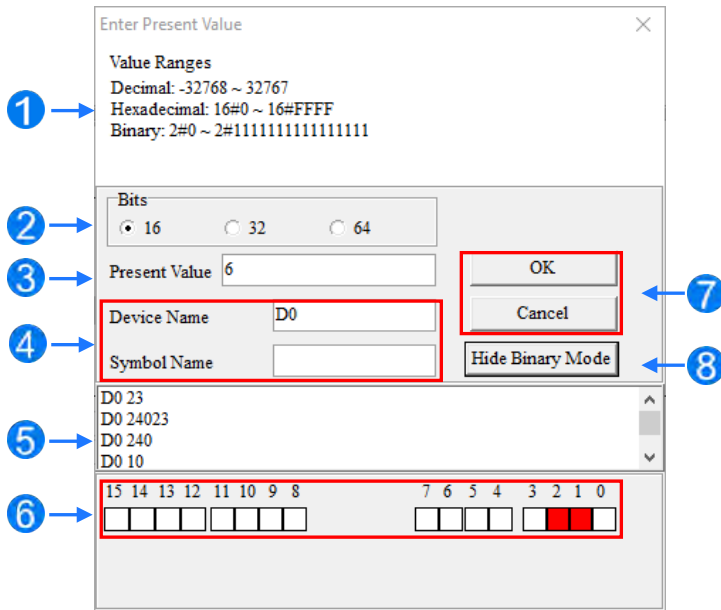

- ❶ Message
- ❷ Type a 16-bit, 32-bit or 64-bit value.
- ❸ Type a value in the **Present Value** box.
- ❹ Type the name of a device or a symbol whose present value you want to change
- ❺ Value change history (Format: Device name Value)
- ❻ In binary mode, use the mouse to set the bit states.
- ❼ Click **OK** to apply the setting values. Click **Cancel** to close the window without applying the values.
- ❽ Display or hide binary mode.

In this example, X0.0–X0.15 and Y0.0–Y0.15 are input and output devices assigned to the digital I/O module AS332T-A. After you download the hardware parameters to the CPU module, the states of X0.0–X0.15 are the same as the states of the inputs on the actual module. Even if you set X0.0–X0.15 to ON or OFF in the program editing window, the actual input signals update the states of X0.0–X0.15.

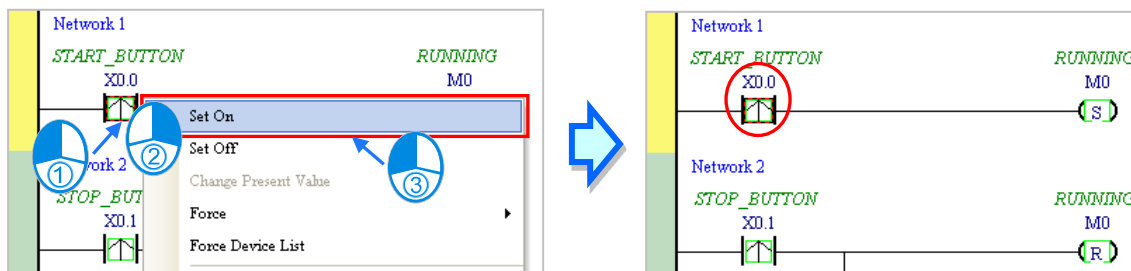

However, you can force an input contact ON or OFF during a test. Click an input or output contact to set, right-click the contact, point to **Force**, and click **On (X/Y)**, **Off (X/Y)**, **Release (X/Y)**, or **Release All**. If you force an input or output contact ON or OFF, a lock symbol appears at the left side of the contact.

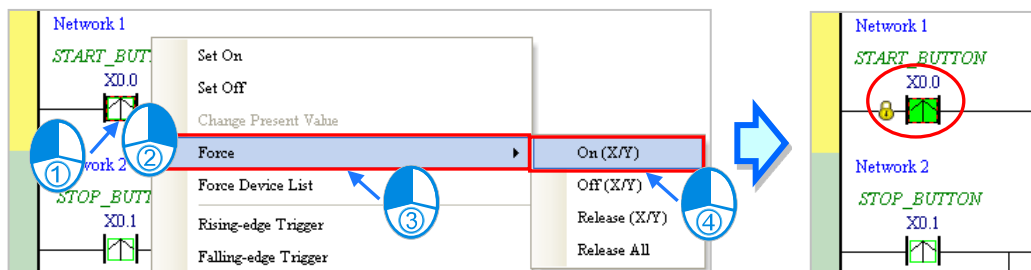

Force	Description
On (X/Y)	Force the selected input or output contact ON
Off (X/Y)	Force the selected input or output contact OFF
Release (X/Y)	Release the contact from the locked state
Release All	Release all the contacts from the locked states

If you force an output contact in the program ON or OFF, the program execution result does not affect the output state of this contact.



*. If you disable the online monitoring function, the contacts are not automatically released from the locked states. You must check whether the contacts need to be released from the locked states after you complete the test.

You can create a monitoring table online or offline.

● **Method 1**

On the **PLC** menu, click **New Devices Table**, or  on the toolbar.

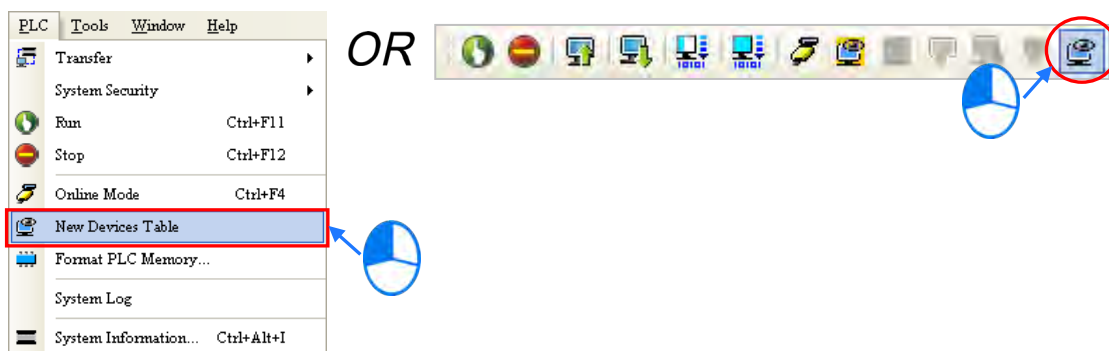

- **Method 2**

Right-click **Device Monitoring Table** in the project management area, and click **New**.

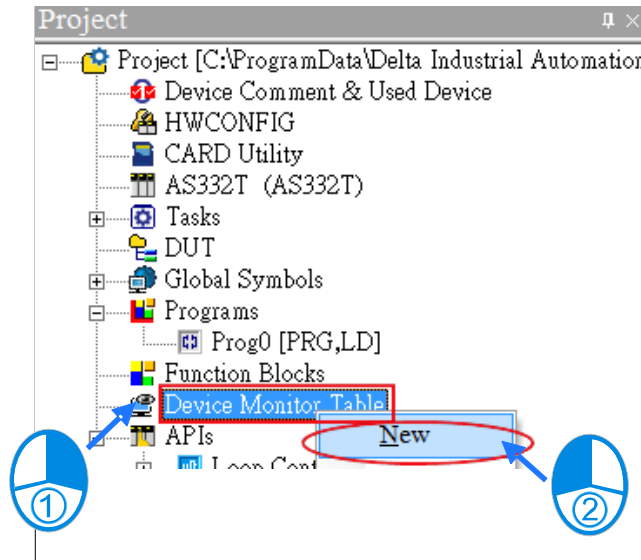

Type a table name in the **Add Monitor Table** dialog box, and then click **OK**. An item appears under **Device Monitor Table** in the project management area. Double-click the item to open the monitoring table. You can create several monitoring tables in the project, and the monitoring tables are saved with the project.

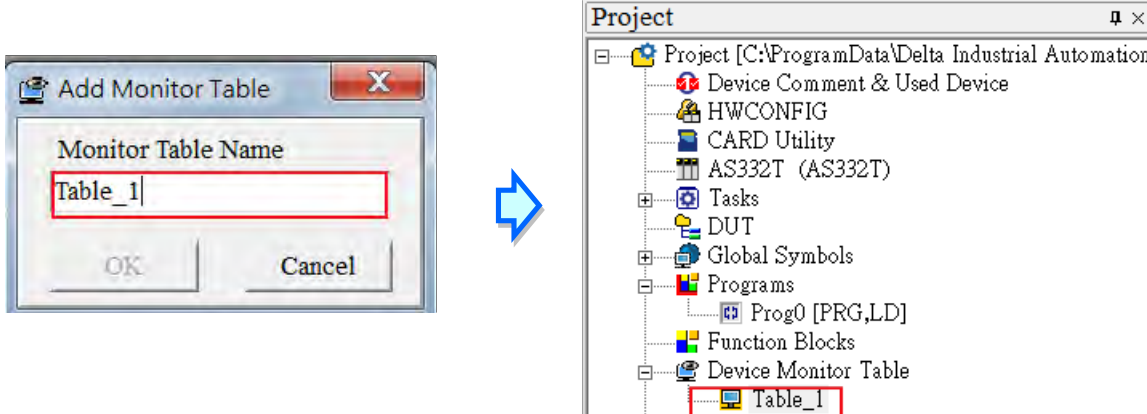

After you double-click the item, a item monitoring window appears. You can add items to be monitored to the window. To add an item to the window, double-click the blank space in the monitoring table, type a device name, type a start address, and the number of devices to be monitored in the **Device Monitor Input** dialog box. You can add up to 100 items to a monitoring table.

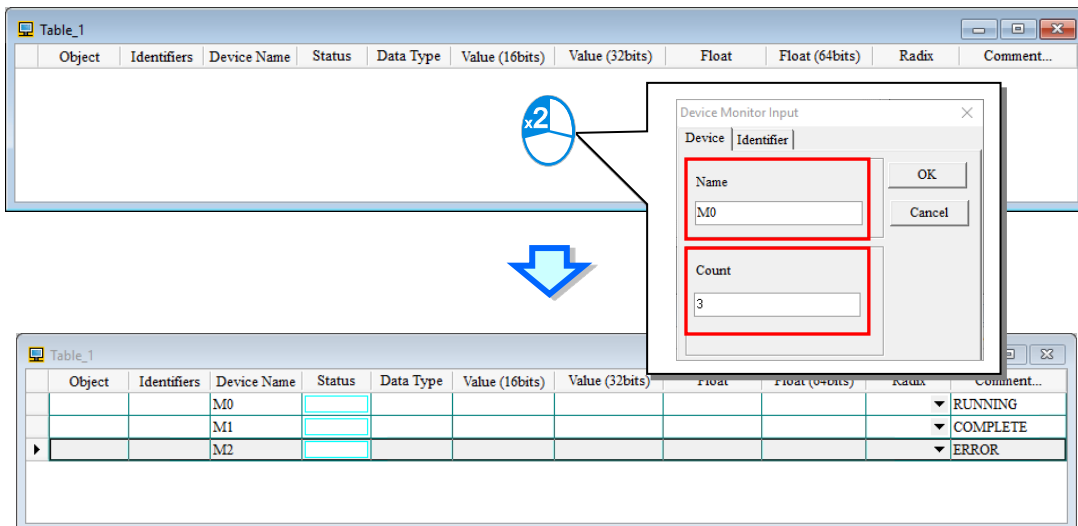

Press Insert on the keyboard to switch between inserting and replacing an item in the monitoring table. The selected mode displays in the status bar in ISPSOFT.

If you select insert mode, the new item is added above the selected item in the monitoring table. If you select replacement mode, the new item overwrites the selected item in the monitoring table.



To hide certain columns in the monitoring table, right-click the monitoring table, point to **Set the Fields**, and clear certain items. After you clear an item, the corresponding column disappears.

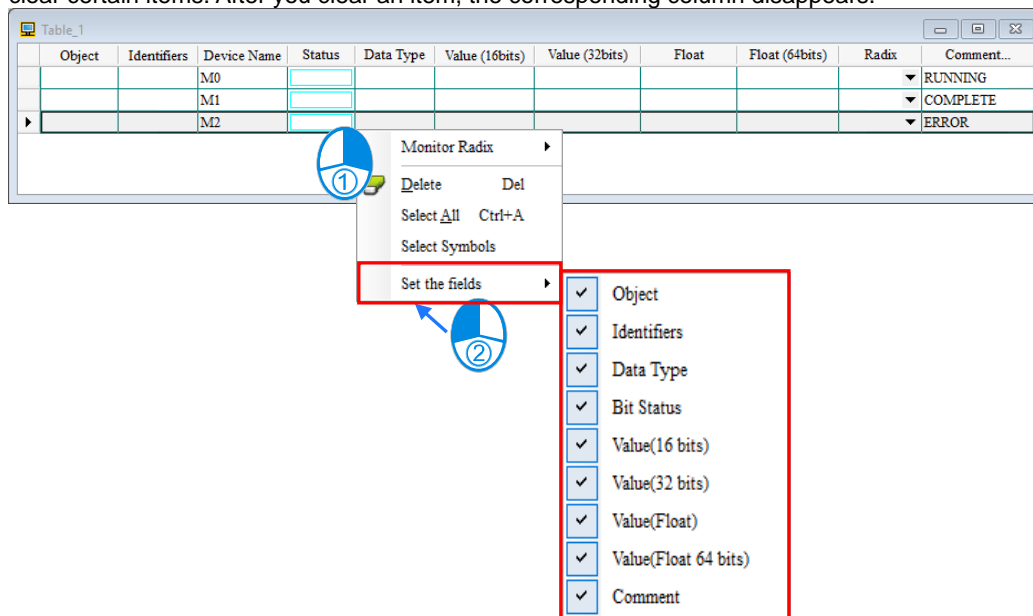

The following describes the columns in the monitoring table.

Column	Description
Source	Source of a symbol
Identifier	Identifier of a symbol
Device name	Name of a monitored device
Status	State of a monitored bit device or a contact (ON or OFF).
Data type	Data type of a monitored symbol.
Value (16 bits)	In online mode, displays a 16-bit value.
Value (32 bits)	In online mode, displays a 32-bit value.
Value (32-bit floating-point value)	In online mode, displays a 32-bit floating-point number.
Value (64-bit floating-point value)	In online mode, displays a 64-bit floating-point number.
Radix	Select a format to represent a value.
Comment	Display the comments on a device or on a symbol.

6

After you create the monitoring table, you can monitor the items in the monitoring table in online mode. Right-click an item in the monitoring table in online mode to display a context menu which is the same as the context menu in the program editing window. You can change the item state or the item value by clicking an item in this context menu.

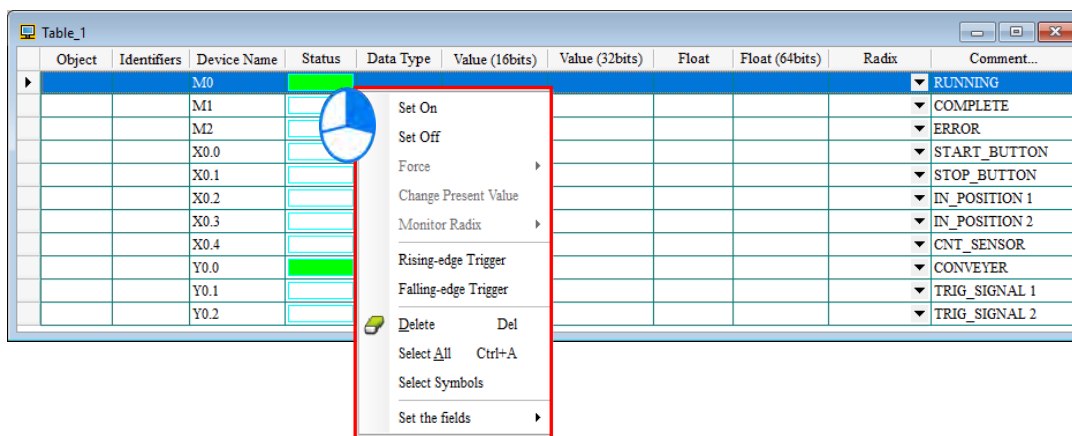

You can test and debug the program you created in this chapter through the monitoring table you created in this section. Refer to Chapter 18 in the ISPSOFT User Manual for more information about testing and debugging a program.

6.7 Setting a Real-time Clock

After you connect an AS Series CPU module to a computer, you can set the real-time clock in the CPU module through ISPSoft.

- (1) On the **Tools** menu, click **Set RTC**.

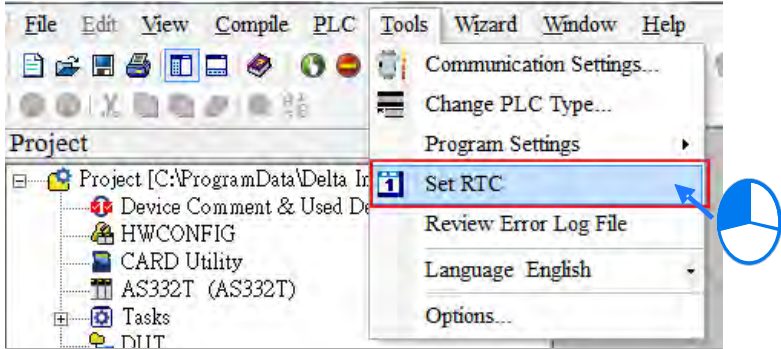

- (2) Select **Computer**, and then click **Synchronize** to complete setting the real time clock.

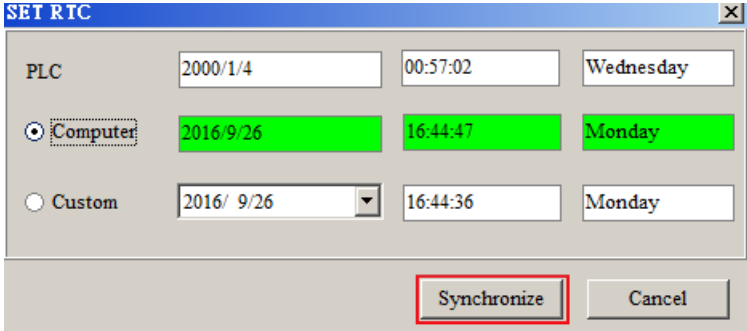

MEMO

Chapter 7 Memory Card

Table of Contents

7.1	Overview of Memory Cards	7-2
7.1.1	Appearances of Memory Cards.....	7-2
7.1.2	Memory Card Specifications	7-2
7.2	Before using a Memory Card	7-3
7.2.1	Formatting a Memory Card.....	7-3
7.3	Installing and Removing a Memory Card	7-4
7.3.1	Memory Card Slot in a CPU Module	7-4
7.3.2	Installing a Memory Card	7-4
7.3.3	Removing a Memory Card	7-4
7.4	Memory Card Contents	7-5
7.4.1	Initializing a Memory Card	7-5
7.4.2	Folder Structure in a Memory Card.....	7-5
7.5	Introduction to the CARD Utility	7-7
7.6	Backing Up a Project	7-10
7.7	Restoring a Project	7-15
7.8	Restoration Starts Once CPU is supplied with Power	7-19
7.9	CPU Error Log	7-20

7.1 Overview of Memory Cards

The AS Series CPU modules support standard MicroSD cards that meet the specifications in this chapter. This chapter describes the specifications and usage for the MicroSD cards supported by the AS series CPU modules.

7.1.1 Appearances of Memory Cards

SD cards are classified into three types according to size: SD cards, MiniSD cards, and MicroSD cards. AS Series CPU modules support MicroSD cards.

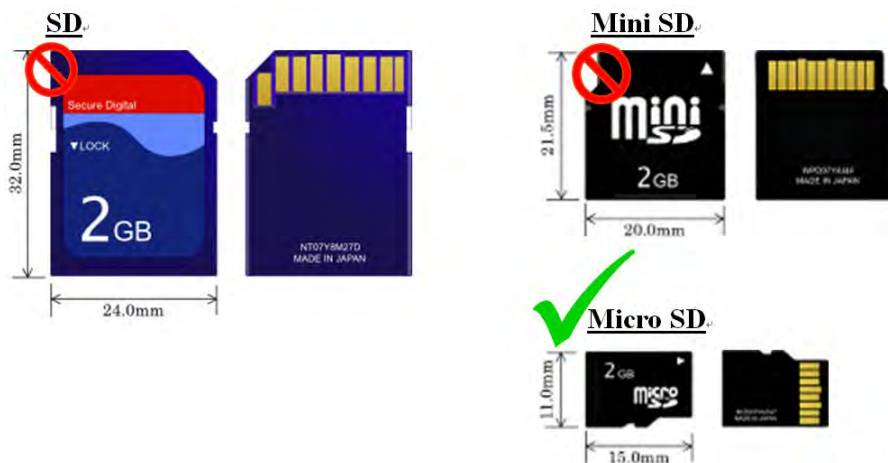

7.1.2 Memory Card Specifications

SD cards are also classified into three types according to capacity: SD cards, SDHC cards, and SDXC cards. The AS Series currently only supports a maximum of 32GB in FAT32 format. SD card families are shown in the table below. The Micro SDHC in the SDHC column indicates the specifications supported by the AS Series. Be sure to purchase products that meet these specifications.

- SD card families

Type	SD	SDHC			SDXC	
Capacity	32MB~2GB	4GB~32GB			32GB~2TB	
File system	FAT16/FAT32	FAT32			exFAT (FAT64)	
Size	SD	SDHC	Mini SDHC	Micro SDHC	SDXC	Micro SDXC
Speed class rating	N/A	CLASS 2 (Min. 2MB/Sec.) CLASS 4 (Min. 4MB/Sec.) CLASS 6 (Min. 6MB/Sec.) CLASS 10 (Min. 10MB/Sec.)			CLASS 2 (Min. 2MB/Sec.) CLASS 4 (Min. 4MB/Sec.) CLASS 6 (Min. 6MB/Sec.) CLASS 10 (Min. 10MB/Sec.)	

7.2 Before using a Memory Card

7.2.1 Formatting a Memory Card

You may need to format a new SDHC memory card with the FAT32 file system before you use it for the first time. You cannot use an unformatted SDHC memory card in an AS Series CPU module.

The following example introduces the most common way to format an SDHC card: formatting an SDHC card through a card reader. Also carefully read the documents provided by the SDHC card manufacturer.

 When you format a memory card, you also delete all the data in the memory card. Verify whether you need to back up the data in a memory card before you format the memory card.

- (1) Insert the SDHC card into a card reader. The operating system detects a new storage device.
- (2) Right-click the new storage device, and then click **Format**.
- (3) You must format the memory card with the FAT32 file system. Do not change any other default settings. Click **Quick Format**, and then click **Start**.
- (4) After you click **OK** in the warning window, the SDHC card formats.

7.3 Installing and Removing a Memory Card

7.3.1 Memory Card Slot in a CPU Module

The memory card slot is on the front side of the AS Series PLC.



7.3.2 Installing a Memory Card

Insert a memory card into the CPU module memory card slot and push it in until it clicks. Be sure the memory card is fixed firmly in the slot; if the memory card is loose, it is not installed correctly. The memory card can only be inserted in one direction. Do not force the memory card or you may damage the CPU module. The following example uses AS300 Series PLC CPU to show you a correct way to insert the memory card.



7.3.3 Removing a Memory Card

Remove a memory card by pushing it in and the card then springs from the slot. (uses AS300 as an example)



7.4 Memory Card Contents

7.4.1 Initializing a Memory Card

When you insert an SDHC card into a CPU module that is powered on, and use ISPSOft -> CARD Utility to back up a project, the system initializes the SDHC card, and creates a default folder named according to the model of the CPU module. (If the folder is already existed, the system does not create a second folder for the same model.)

When the system initializes an SDHC card, it automatically adds any missing folders to the directory structure. However, if the initialization of a SDHC card fails, you cannot initialize the SDHC card again until you reformat it.

When you initialize a memory card, the SYSTEM indicator in the software blinks.

7.4.2 Folder Structure in a Memory Card

The image below shows the default folder group created by an AS System. The folder name is AS100/200/300. Several subfolders are contained inside the AS100/200/300 folder. Related files created by you and the AS system are stored in the subfolders.

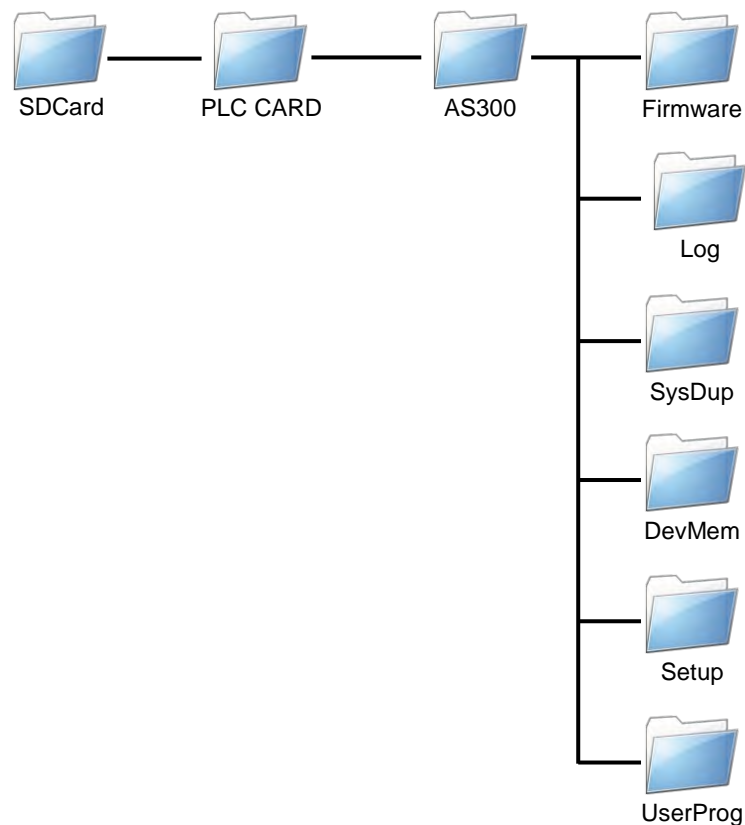

Folder	Description
Firmware	Stores firmware files (.ext) You can store firmware file here for a firmware upgrade; after that use the USB port on the computer to connect to the USB port of the AS Series PLC CPU for a firmware upgrade.
Log	Stores Log files (.log)
SysDup	Stores backup files (.dup)
UserProg	Stores device memory files (.txt, .dmd, .csv)
DevMem, Setup	Reserved for the system use

7.5 Introduction to the CARD Utility

The AS Series CPU modules include SDHC slots, and you can back up and restore PLC CPU data with a memory card. ISPSOFT includes the CARD Utility for the AS Series CPU modules. With this utility, you can back up and restore data in an AS Series CPU module or backup and restore an ISPSOFT project. The backup can include the program code, parameter settings, hardware configuration, network configuration, and the values in the latched area in an AS series CPU module. Refer to AS Series Manuals for more information about the specifications and usage of SDHC cards with AS Series CPU modules.

For AS Series PLC CPU firmware V1.08.20 or previous versions, the PLC CPU backs up and restores the following data:

- Programs includes PLC execution code, PLC programs, project password, and PLC ID.
- Parameters includes HWCONFIG settings, configurations of CPU module and modules, data exchange table, and positioning planning table.
- Retainable data includes device setting range, values in retainable devices.

Note: Ethernet/IP and CANopen DS301 data exchange tables created by the network planning tool cannot be backed up or restored.

For AS Series PLC CPU firmware V1.10.00 or later versions, the PLC CPU backs up and restores the above-mentioned data and the following data:

- User Language C execution code
- Device default value table
- E-CAM table
- Data Logger parameters
- Ethernet/IP Tag
- Ethernet/IP data exchange table
- OPC UA Tag
- IOLINK device parameters of AS04SIL
- CANopen DS301 data exchange table

NOTE: if the backup file created by the PLC CPU whose firmware is different from the one you are going to perform restoring, things will be like one of the followings:

* Backing up on the older firmware version of the PLC CPU and restoring to a later firmware version of the PLC CPU: Backup file can be restored on the later firmware version of the PLC.

* Backing up on the later firmware version of the PLC CPU and restoring to an older firmware version of the PLC CPU: Backup file can NOT be restored on the older firmware version of the PLC. It is suggested to upgrade the PLC firmware or use a backup file created by the same firmware version of the PLC CPU to perform restoring.

The list below describes the functions supported by the CARD Utility, including a flowchart.

- If you export data from an AS Series CPU module as a backup file (*.dup), you can save the exported data in the memory card in the module or in a folder on the computer. You can also decide whether to back up the values in the devices in the AS Series CPU module.
- If you export an ISPSOft project for an AS Series CPU module as a backup file (*.dup), you can only save the exported ISPSOft project in a folder in the computer. You can see data such as register editing (*.dvl), device status editing (*.dvh), file register editing (*.wft) for the AS Series as values in the device and back them up. You can put a memory card with the backup file into the AS series CPU module. You can copy a backup file (*.dup) saved on the computer into the AS series CPU module connected to the computer, or restore the backup file to an ISPSOft project. If you choose to restore the backup file to an ISPSOft project, the system automatically skips the values in the devices and the hardware configuration in the backup file.
- If you restore the backup file (*.dup) from the PC to an ISPSOft project for an AS Series CPU module, you can also restore data such as register editing (*.dvl), device status editing (*.dvh), and file register editing (*.wft) for the AS Series.

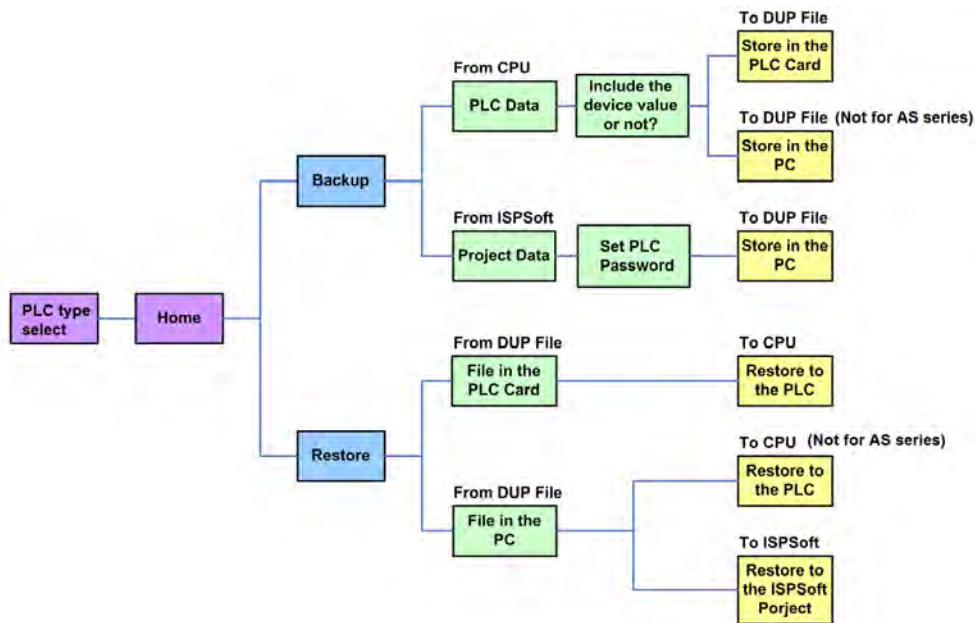

Double-click **CARD Utility** in the project management area to open the **CARD Utility** wizard. After selecting the controller type, click “Next” to proceed.

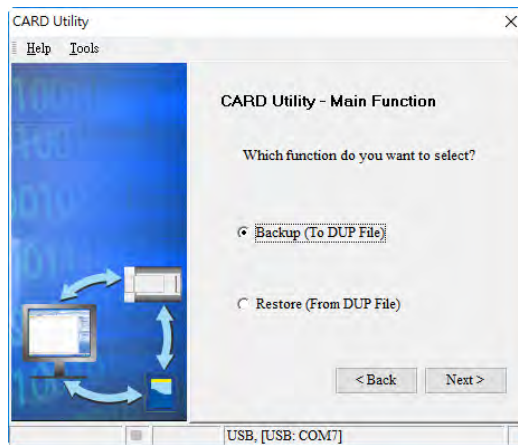
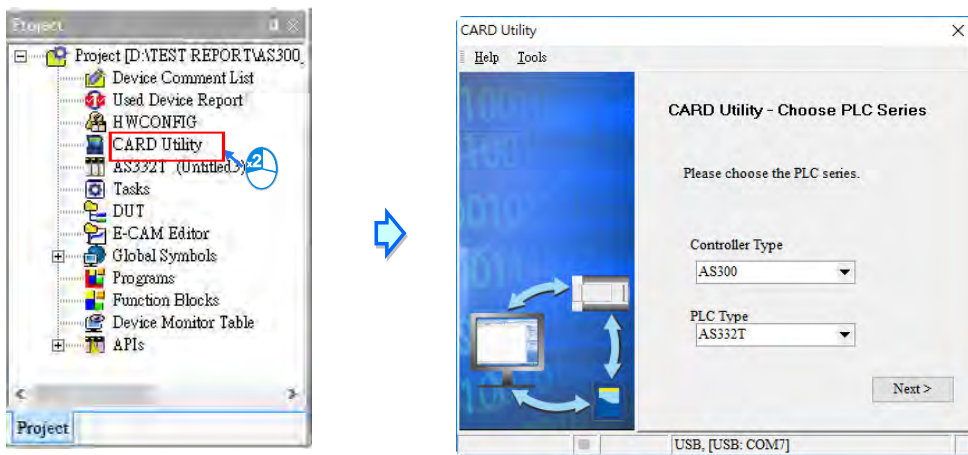

7.6 Backing Up a Project

If the backup source or backup destination is an AS Series CPU module or memory card, make sure that ISPSOft is connected to the AS Series CPU module. During backup, the CPU LED and Error LED blinks alternatively and SM452 flag is ON. After the backup is done, the CPU LED and Error LED stops blinking and SM452 flag is OFF. Refer to Section 2.4 in the ISPSOft User Manual for more information.

- (1) Select the **Backup (To DUP File)** option button in the **CARD Utility** wizard and then click **Next**.

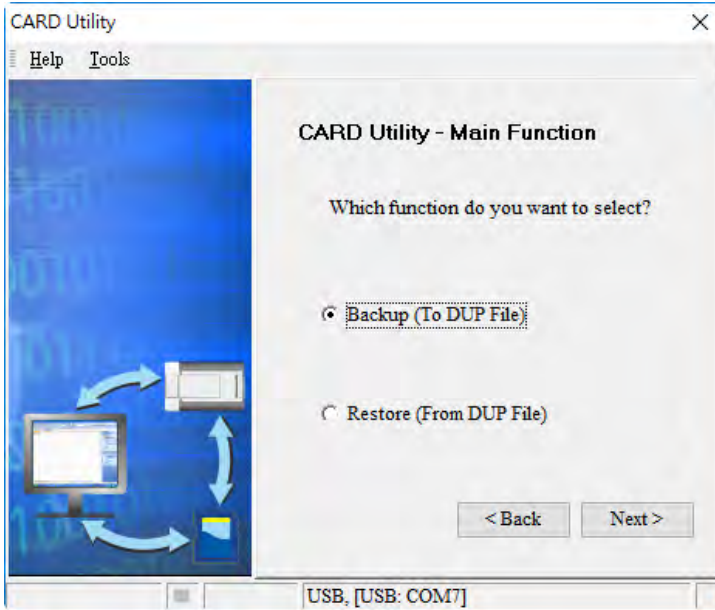

- (2) Select a backup source, and then click **Next**.

- a. If you select the **CPU (Need Connection)**, the backup file is stored in the memory card.

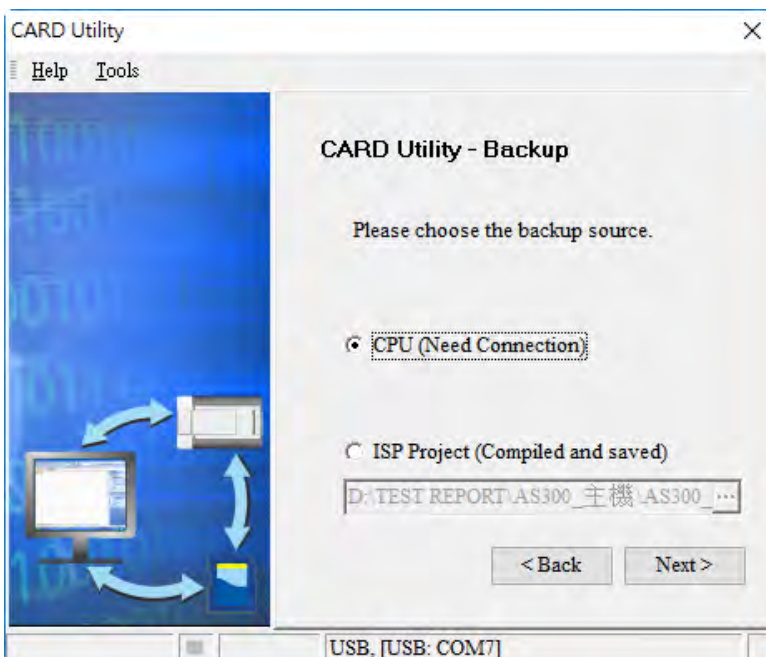

- b. If you select the **ISP Project (Compiled and saved)**, the backup file is stored in your computer. Click  and select an isp file in the **Open** dialog box. If the program in the isp file selected is not compiled, a message appears when you back up the isp file. Open the isp file with ISPSOft, compile the program in the isp file, and then save the isp file. After the program in the isp file is compiled, you can back up the isp file.

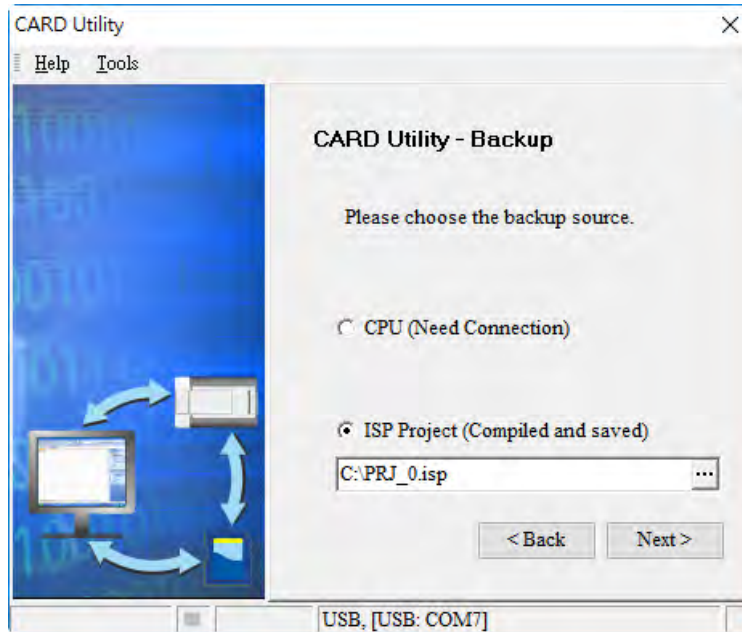

- (3) After you select **CPU (Need Connection) / ISP Project (Compiled and saved)**, click **Next**,
- a. If you select the **CPU (Need Connection)**, a prompted window appears. And you need to decide whether to back up the values in devices on the AS Series CPU module that is connected to ISPSOft.

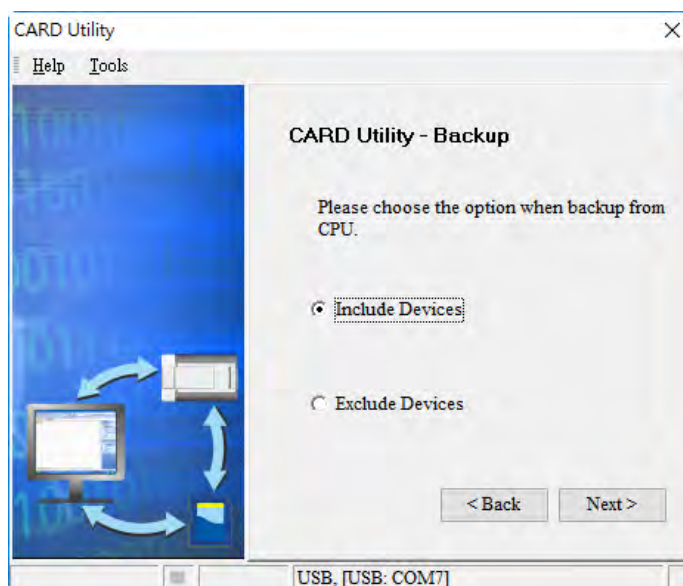

- b. If you select the **ISP Project (Compiled and saved)**, the backup file is stored in your computer. Click  and select an isp file in the **Open** dialog box and then decide the file path where you'd like to store the backup file in your computer and then define its file name.

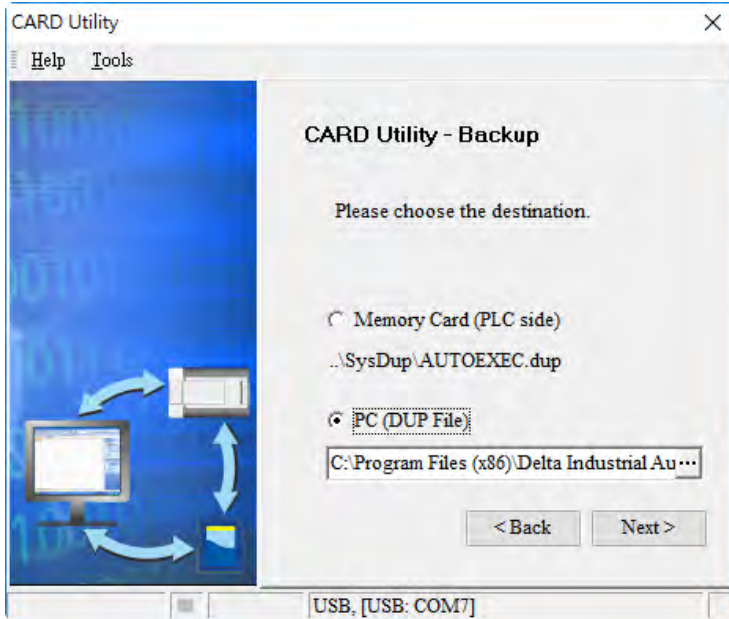

- (4) Select a backup destination. If the backup source is an ISPSOft project, the backup destination must be a computer.

- a. If you select **Memory Card (PLC Side)**, the filename of the backup file is **AUTOEXEC.dup**, and the backup file paths for AS100, AS200 and AS300 are shown below.

AS100: Root directory of the memory card\SDCard\PLC CARD\AS100\SysDup\AUTOEXEC.dup

AS200: Root directory of the memory card\SDCard\PLC CARD\AS200\SysDup\AUTOEXEC.dup

AS300: Root directory of the memory card\SDCard\PLC CARD\AS300\SysDup\AUTOEXEC.dup

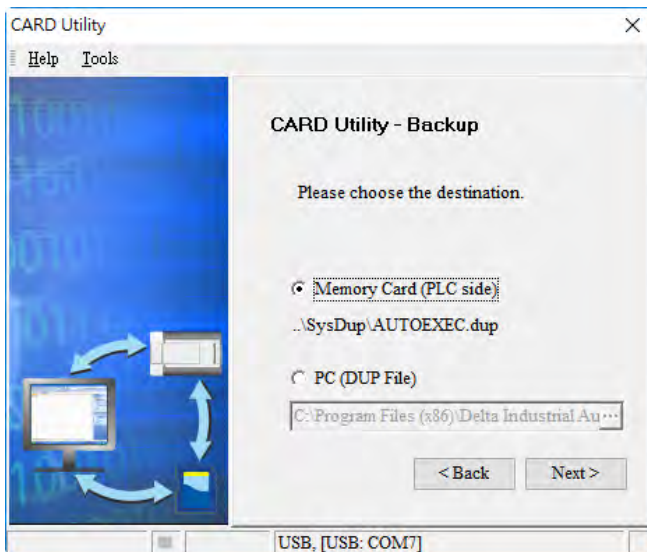

- b. If you select **PC (DUP File)**, click , select a folder in the **Save in** list in the **Save As** dialog box, and type a filename in the **File name** box. When you select the backup source for the ISPSOFT Project, set the PLC password. You can set the password to be the same as the Project password, set a new PLC password, or not set a PLC password. If you do not set a password for the Project, the PLC password is also not set. When you select **Setting new PLC password**, the wizard looks like the following image. And you can set new PLC password and number of the attempt times.

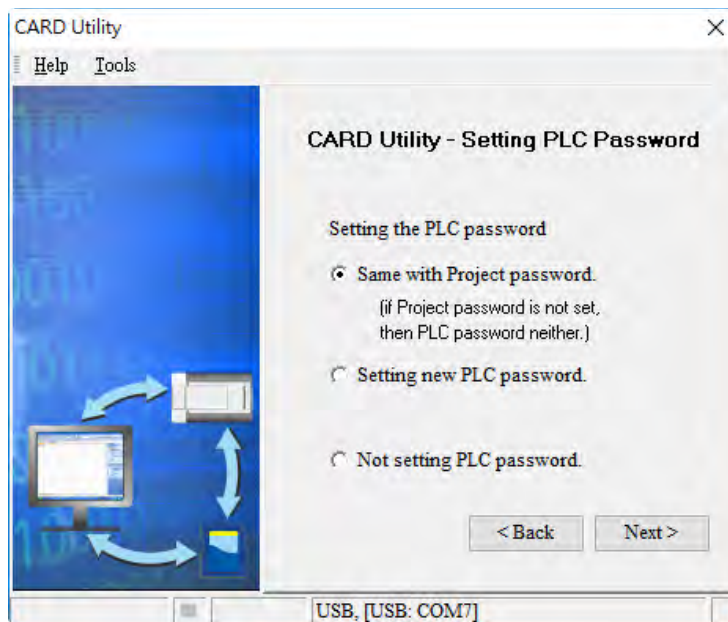

- (5) After that you can see the summary. Make sure that the summary in the **CARD Utility** wizard is consistent with the data backup you want to perform, and then click **Execute**.

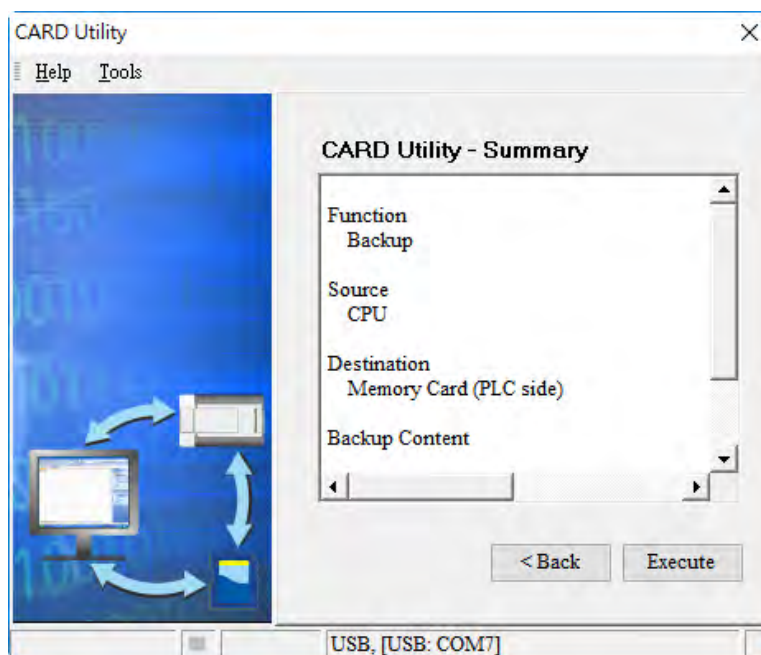

- (6) The AS Series CPU module still performs the data backup even if you click **Cancel**. You can turn off the AS Series CPU module to stop the data backup; however, the backup file produced is not a complete backup file, and you must delete the backup file from the memory card.

If you select **Memory Card (PLC Side)**, the filename of the backup file is **AUTOEXEC.dup**, and the backup file path is **Root directory of the memory card\AS300\SysDup\AUTOEXEC.dup**. If there is an old backup file in the memory card, the **Warning** message appears. Click **Replace**, **Archive**, or **Cancel** in the Warning message.

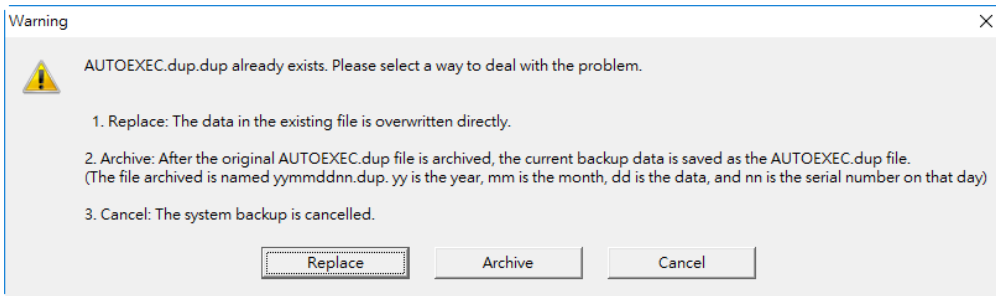

If the backed up data is protected by passwords, these passwords are also backed up.

Data backup	Description
CPU module → Memory card	The backed up data includes the PLC ID and the PLC password set in the CPU module.
ISPSOft project → Computer	The backed up data includes the program ID and the project password set in the ISPSOft project.



- (7) After you perform the data backup, click **Home** or **Close** in the **CARD Utility** wizard.

7.7 Restoring a Project

If the restoration source or restoration destination is an AS Series CPU module or memory card, make sure that ISPSOFT is connected to the AS Series CPU module. During restoration, the CPU LED and Error LED blinks alternatively and SM452 flag is ON. After restoration is done, the CPU LED and Error LED stops blinking and SM452 flag is OFF. Refer to Section 2.4 in the ISPSOFT User Manual for more information.

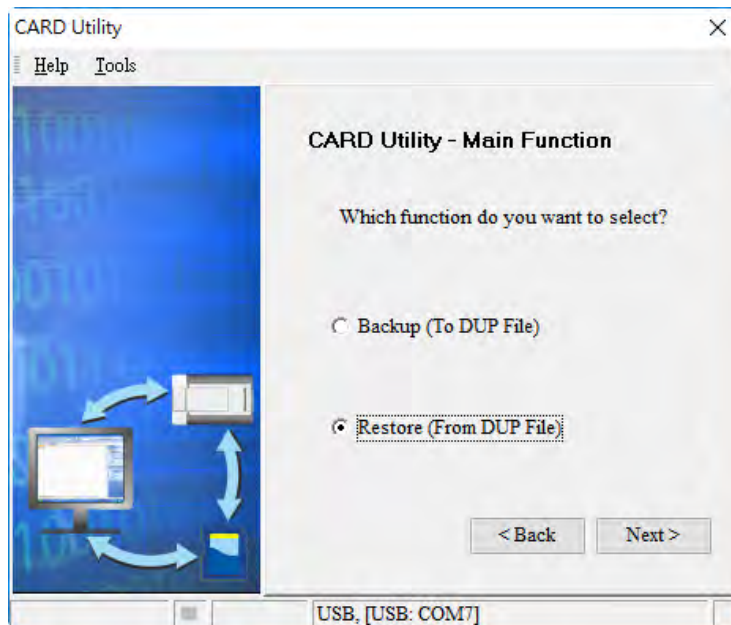
- (1) Select **Restore (From DUP File)** in the **CARD Utility** wizard and then click **Next**.



- (2) Select a restoration source, click  and then select a backup file to be restored.
 - a. If you select **Memory Card (PLC side) (Need Connection)**, the backup files in the memory card display in a window after you click . Double-click a backup file in the window to choose it.

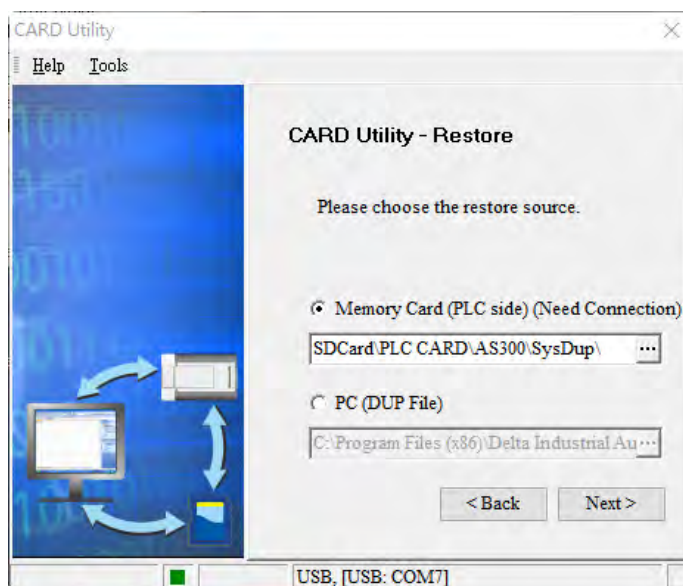

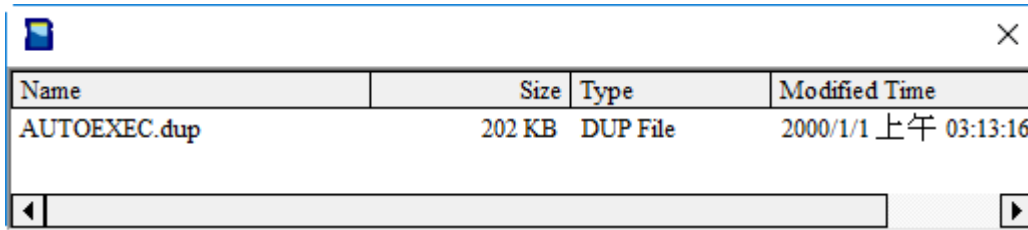

- b. If you select **PC (Need Connection)**, the backup files in the PC display in a window after you click . Double-click a backup file in the window to choose it.

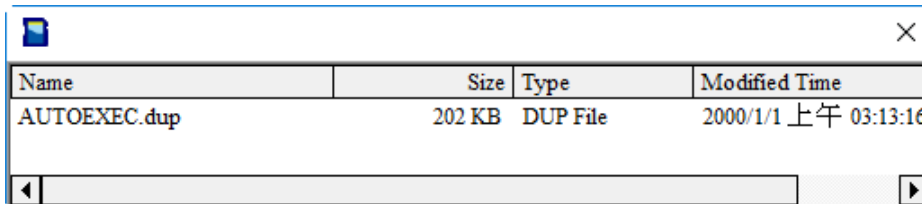
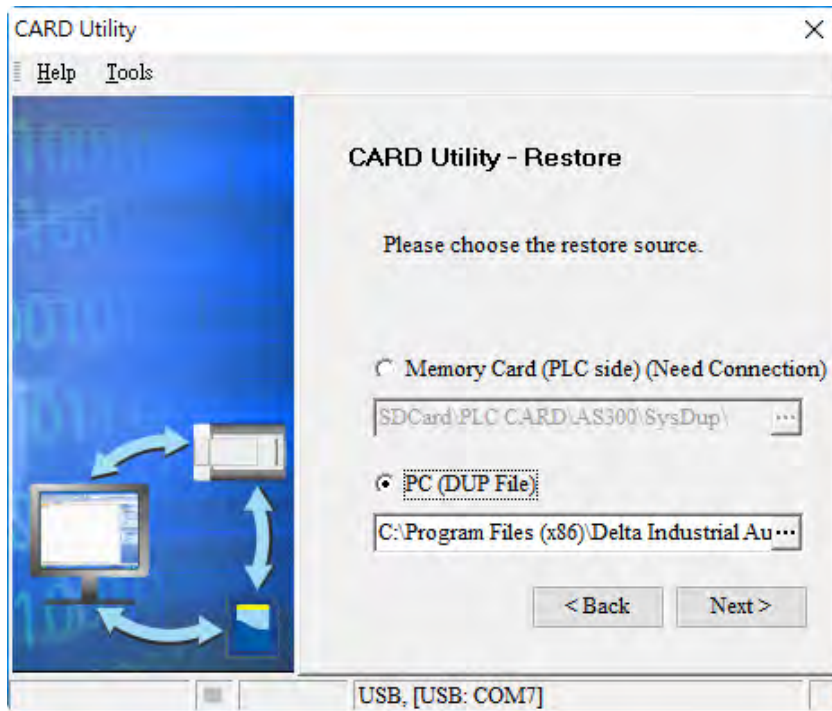

- (3) Select a restoration destination, and then click **Next**.
- a. To put the selected backup file into the AS Series CPU module, select **CPU (Need Connection)**. If the restoration source is the **CPU (Need Connection)**, the restoration destination must be the AS Series CPU module.

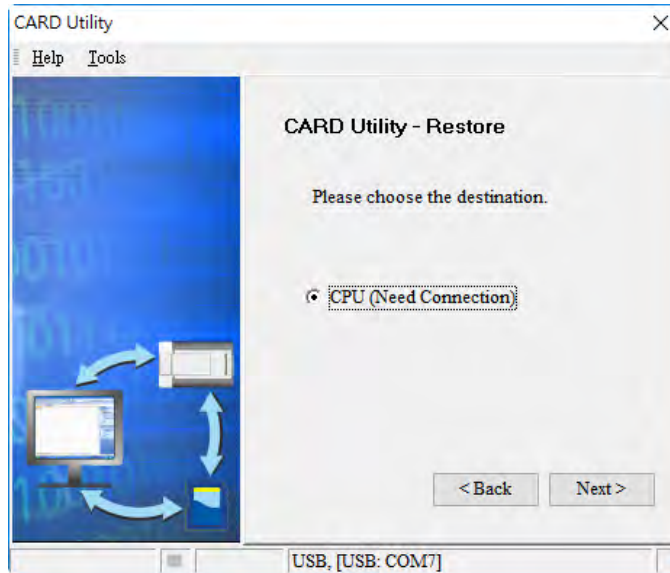

- b. If you select **ISP Project**, click **...** and then specify a filename and a path. If the path specified point to a file that already exists, the file is overwritten when you restore the data.

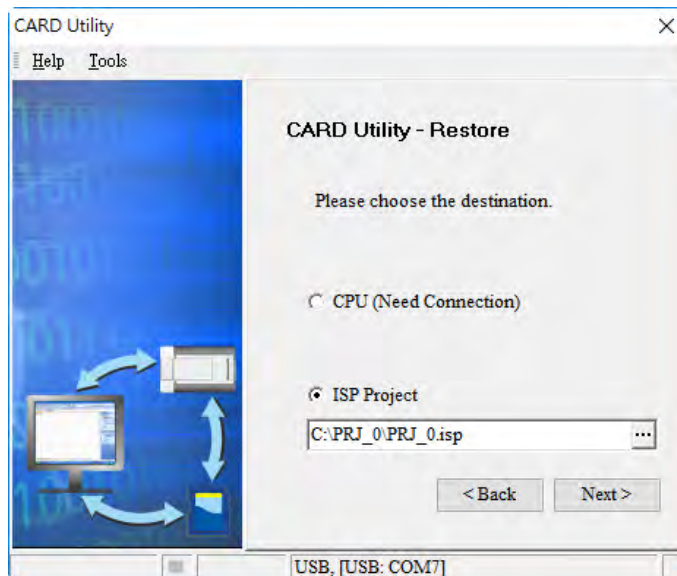

- (4) Make sure that the summary in the **CARD Utility** wizard is consistent with the data restoration you want to perform and then click **Execute**.

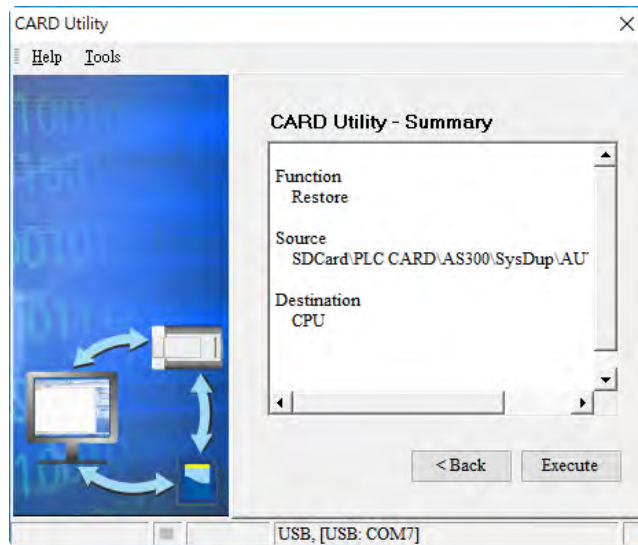

If you click **Cancel** in the process of restoring data to the AS Series CPU module, the data is not completely restored. The AS Series CPU module still performs the data restoration even if you click **Cancel** in the process of restoring a backup file in the memory card. You can turn off the AS Series CPU module to stop the data restoration from being performed. To prevent the AS Series CPU module from operating incorrectly, restore the AS Series CPU module to the factory setting, or perform the data restoration again.

The restoration source or restoration destination may contain a password and an ID. The following table describes the password and the ID process.

Data restoration	Description
Memory card → PU module	a. The ID in the backup file must be the same as the ID in the CPU module; otherwise the data is not restored. b. If there is a PLC password in the CPU module, the password in the backup file must be the same as the PLC password in the CPU module. Otherwise the data is not restored. c. If there is no PLC password in the CPU module, and there is a password in the backup file, the system restores the data, and the password in the backup file becomes the PLC password in the CPU.
Computer→ ISPSOft project	The ID and the password in the backup file become the program ID and the project password in the ISPSOft project.

- (5) After you perform the data restoration, click **Home** or **Close** in the **CARD Utility** wizard.

7.8 Restoration Starts Once CPU is supplied with Power

When the backup file in the memory card is consistent with the specific path and file name, the CPU can perform restoration once it is supplied with power. During restoration, the CPU LED and Error LED blinks alternatively and SM452 flag is ON. After restoration is done, the CPU LED and Error LED stops blinking and SM452 flag is OFF.

Operation Steps:

- (1) Set up the backup file path and file name for the memory card backup file. The filename of the backup file is **BACKUP.dup** and the backup file paths for AS100, AS200 and AS300 are shown below.

AS100: Memory card root directory**SDCard\PLC CARD\AS100\SysDup\AS200 BACKUP.dup**

AS200: Memory card root directory**SDCard\PLC CARD\AS200\SysDup\AS200 BACKUP.dup**

AS300: Memory card root directory**SDCard\PLC CARD\AS300\SysDup\AS300 BACKUP.dup**

Insert the memory card into the card slot when the CPU power is off.

- (2) When the CPU power is on, it automatically checks if the memory card data is consistent with the PLC data. If not, the restoration begins. The data check is specifically on the data in CPU programs and HWCONFIG parameters.
- (3) During the restoration, the CPU LED and Error LED blinks alternatively. Once the restoration is done, the blinking stops.

7.9 CPU Error Log

The system stores CPU error messages in the memory card whenever the quantity of the error messages reached to 20. You can also use special flag SM36 and special device SR36 to read the CPU error messages and state change logs. If there is error logs recorded in the memory card, the memory card keeps storing the error logs. You can change the file path to store other error logs or change the file name to store other error logs.

Special Device	Function Code Description
SR36	a. when the value is 0, it indicates there is no recording. b. when the value is 1234, it indicates the logs are stored in the memory card. c. when the value is 3456, it indicates the error logs and state change logs are stored in the memory card.

Operation Steps to read CPU error logs and state change logs:

Make sure the memory card is in the slot before reading the CPU error logs and state change logs.

(1) Set SM36 to ON and the value in SR36 to 1234 or 3456 to read the CPU error logs and state change logs.

(2) The root directory path of the memory card for the error log is

AS100: Memory card root directory[SDCard\PLC CARD\AS100\Log\Error.log](#)

AS200: Memory card root directory[SDCard\PLC CARD\AS200\Log\Error.log](#)

AS300: Memory card root directory[SDCard\PLC CARD\AS300\Log\Error.log](#)

Use ISPSOft to read the error logs. ISPSOft Tools -> Review Error Log File -> Open Log File

The root directory path of the memory card for the status log is

AS100: Memory card root directory[SDCard\PLC CARD\AS100\Log\STATUS.log](#)

AS200: Memory card root directory[SDCard\PLC CARD\AS200\Log\STATUS.log](#)

AS300: Memory card root directory[SDCard\PLC CARD\AS300\Log\STATUS.log](#)

(3) Use ISPSOft to read the status logs. ISPSOft Tools -> Review Error Log File -> Open Log File

Chapter 8 Hardware Configuration and Data Exchange Setups

Table of Contents

8.1	Hardware Configuration Tool for AS Series Modules - HWCONFIG.....	8-2
8.1.1	Introduction of the HWCONFIG Environment	8-2
8.1.2	Configuring a Module.....	8-4
8.2	Setting the Parameters in an AS Series CPU Module.....	8-23
8.2.1	System Settings – System Information	8-23
8.2.2	System Settings – System Parameter	8-24
8.2.3	System Settings – Device Range Setting	8-30
8.2.4	System Settings – Input Point Filter Time	8-31
8.2.5	System Settings – Position Control Parameter	8-32
8.2.6	System Settings – Daylight Saving Timing	8-33
8.2.7	Options - COM1 Port Setting & COM2 Port Setting.....	8-34
8.2.8	Options - Ethernet Port Basic Setting	8-35
8.2.9	Ethernet Port Advance Setting – IP Filter	8-36
8.2.10	Ethernet Port Advance Setting – NTP.....	8-36
8.2.11	Ethernet Port Advance Setting – Email	8-37
8.2.12	Ethernet Port Advance Setting – Socket.....	8-41
8.2.13	Ethernet Port Advance Setting – RTU Mapping	8-43
8.2.14	Function Card 1 Setting.....	8-44
8.2.15	Function Card 2 Setting.....	8-45
8.2.16	Data Exchange	8-48

8.1 Hardware Configuration Tool for AS Series Modules - HWCONFIG

This section uses ISPSOft for demonstration. For DIADesigner operation, refer to Chapter 6 from DIADesigner software manual.

HWCONFIG is a built-in hardware configuration tool in ISPSOft. You can configure CPU and module parameters, download/upload parameters, detect a hardware configuration online, and make a diagnosis through HWCONFIG. The examples used below are from HWCONFIG 4.0 (ISPSOft V3.11). Refer to previous versions of ISPSOft Manual or AS Series Operation Manual for the operation examples on the previous versions of HWCONFIG.

You must download all parameters set in HWCONFIG to the CPU module for them to take effect.

The data exchange area set in HWCONFIG for modules cannot be used repeatedly for other communication data and vise versa.

8.1.1 Introduction of the HWCONFIG Environment

In ISPSOft, double-click **HWCONFIG** in the project management area to start **HWCONFIG**.

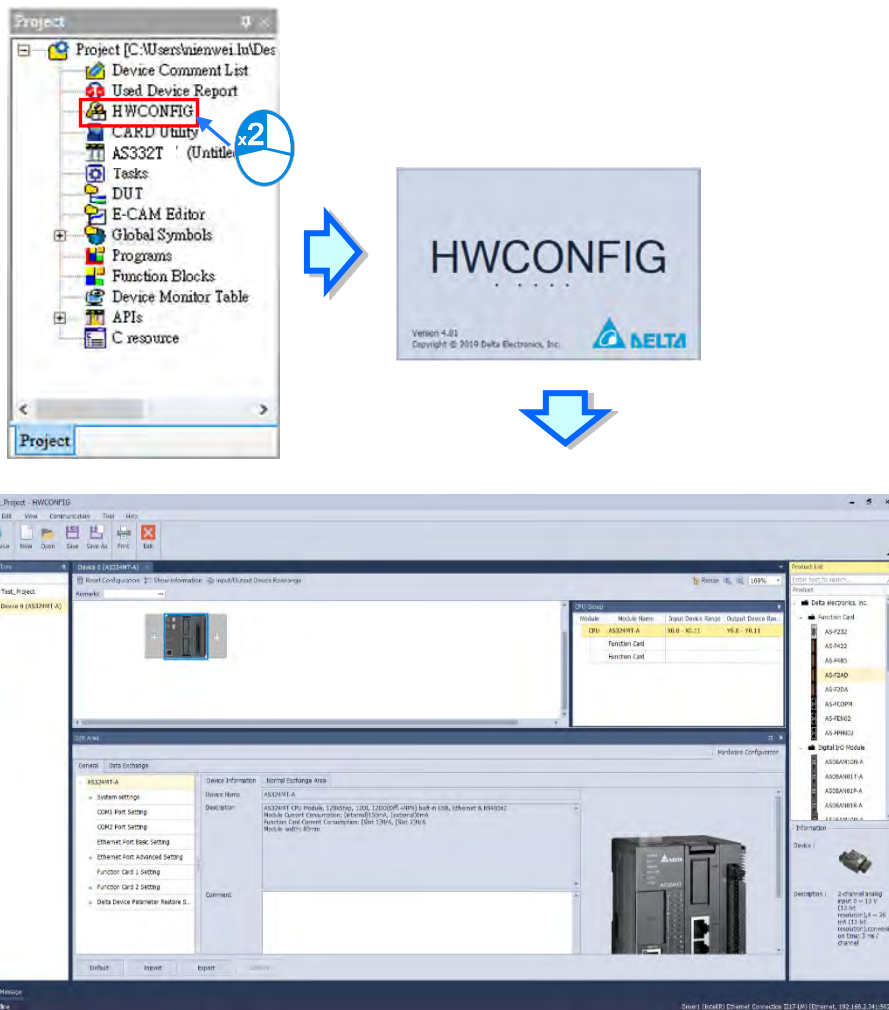

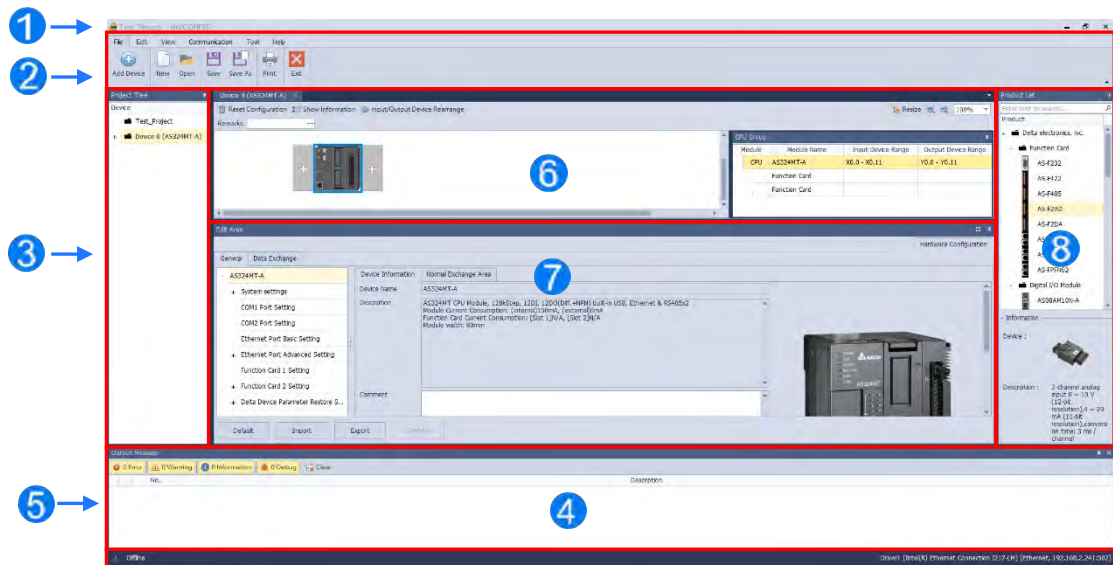

- ❶ **Window Title:** Here shows the current project name and the program name.
- ❷ **Tool Bar:** There are 6 tabs on the tool bar.
- ❸ **Project Tree:** Tree-structured projects for easier management
- ❹ **Output Message Section:** Here shows project related information.
- ❺ **Status Bar:** Here shows the connection status and the communication parameters.
- ❻ **Hardware Configuration Area:** You can set up hardware configuration here.
- ❼ **Edit Area:** You can set up parameters for PLC CPU and modules.
- ❽ **Product list:** Available hardware is listed in the catalog.

8.1.2 Configuring a Module

8.1.2.1 Adding a Module

- **Method 1**

Double-click the module you want to add in the project or select it from the **Product List** and drag that module to the desired position. There will be a suggestive dotted line to indicate the legitimate position for the selected module.

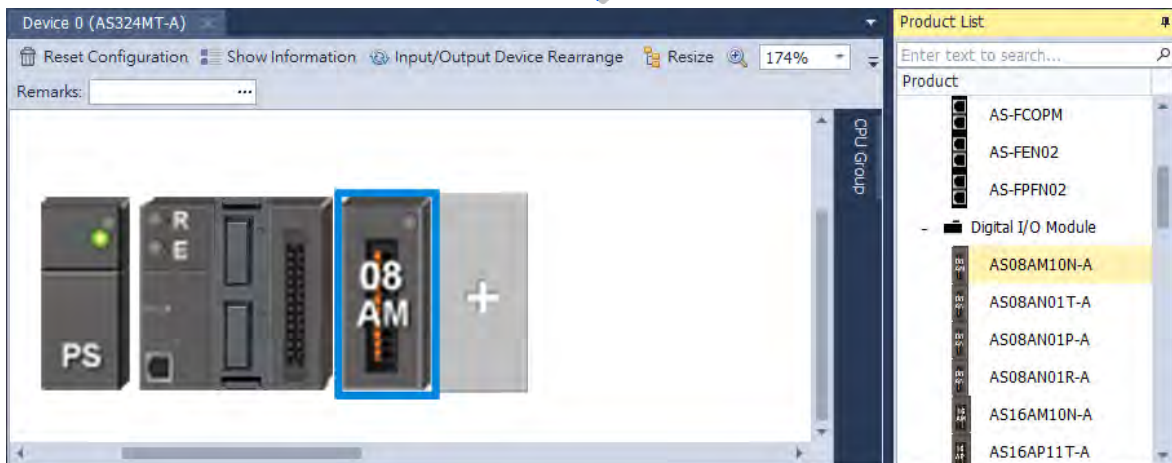
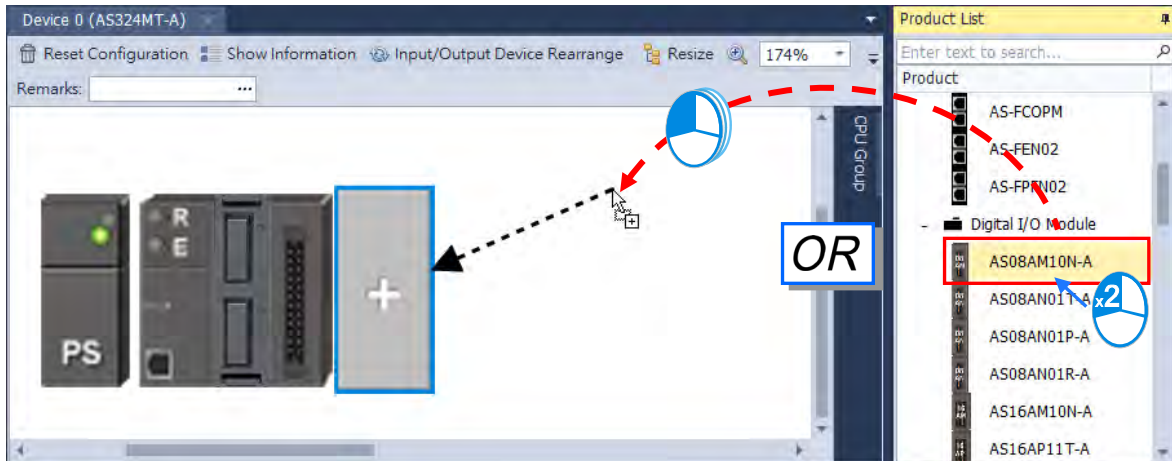

● **Method 2**

- (1) Double-click a vacant slot or right-click the slot and choose **Add**.

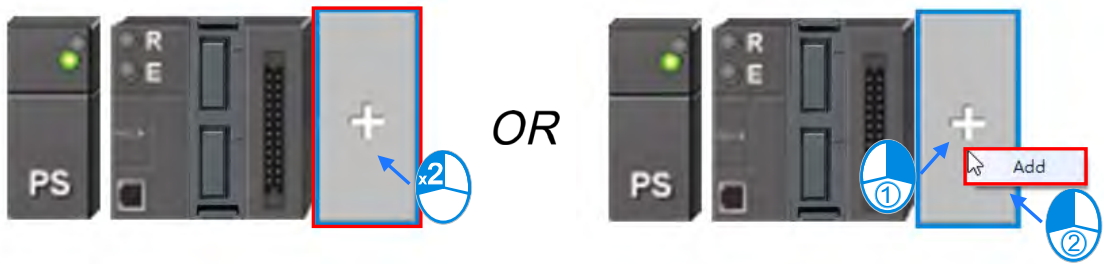

- (2) Double-click the selected module to add. You can repeat these two steps to add more modules in.

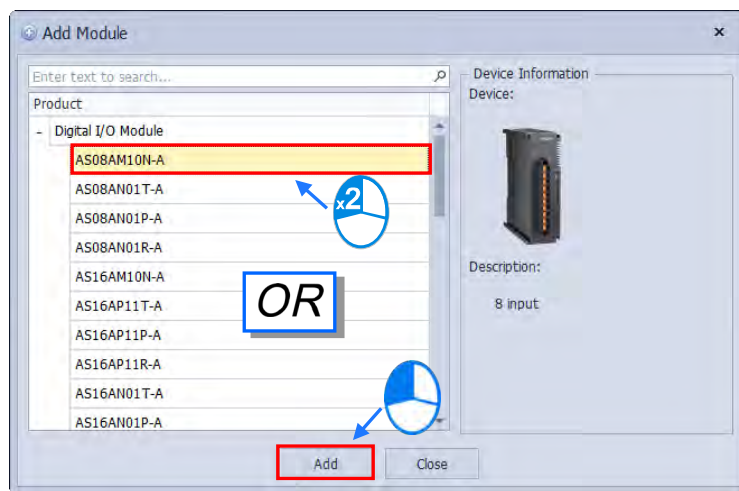

● **Method 3**

In the **Product List** section, double-click the selected module or select the desired module and press **Enter** on the keyboard to add the selected module in the hardware configuration area.

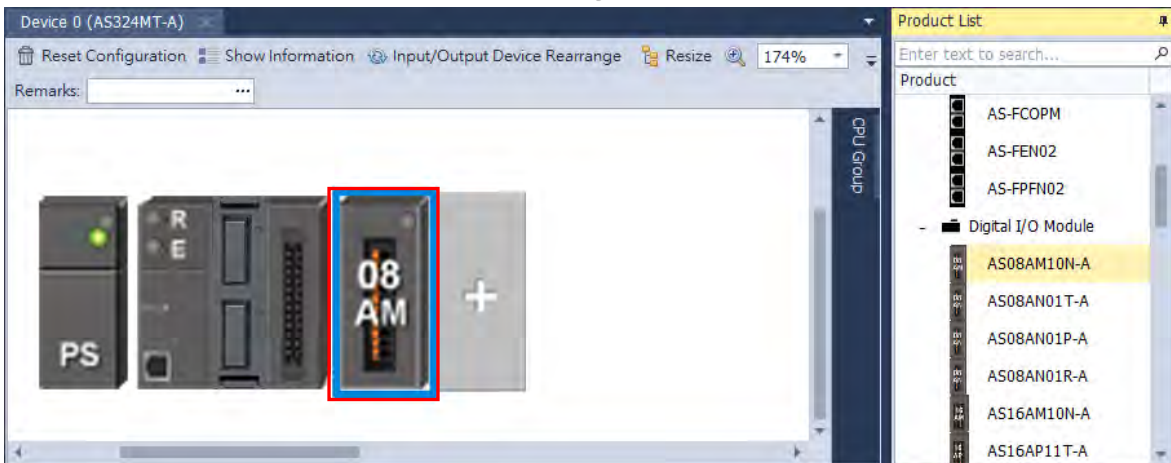
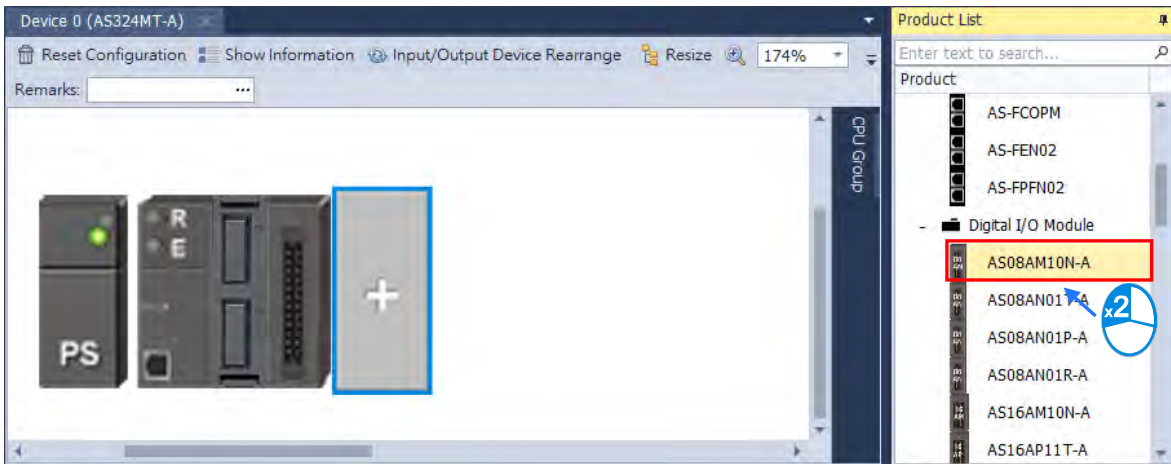

● **Add More Modules at the Same Time**

In the **Product List** section, right-click the selected module that you need for more than one, and you will see the context menu showing three options **Expand All**, **Collapse All**, and **Add Multiple**. Click **Add Multiple**, and then an Add Multiple Modules (your desired module name) window appears, use the up and down arrows to increase or decrease the quantity number that you need and then click **OK** to confirm the setting.

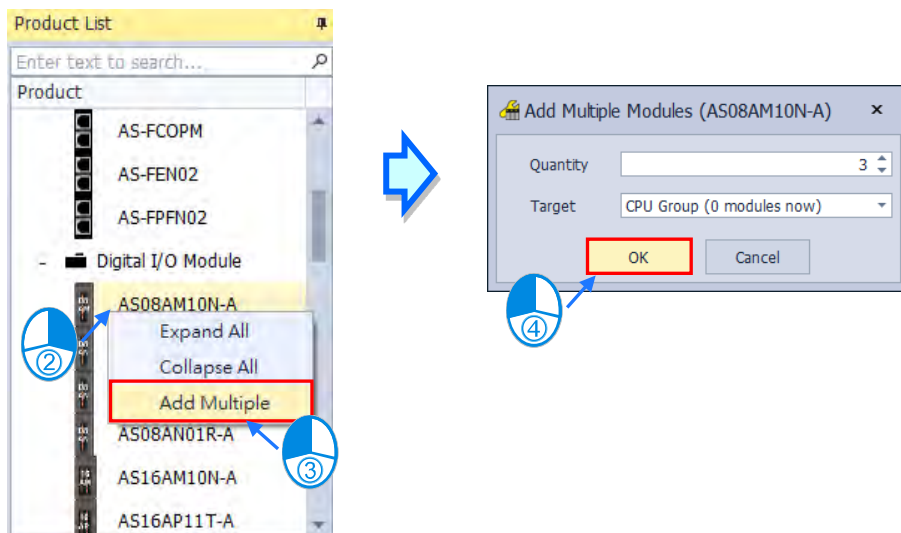
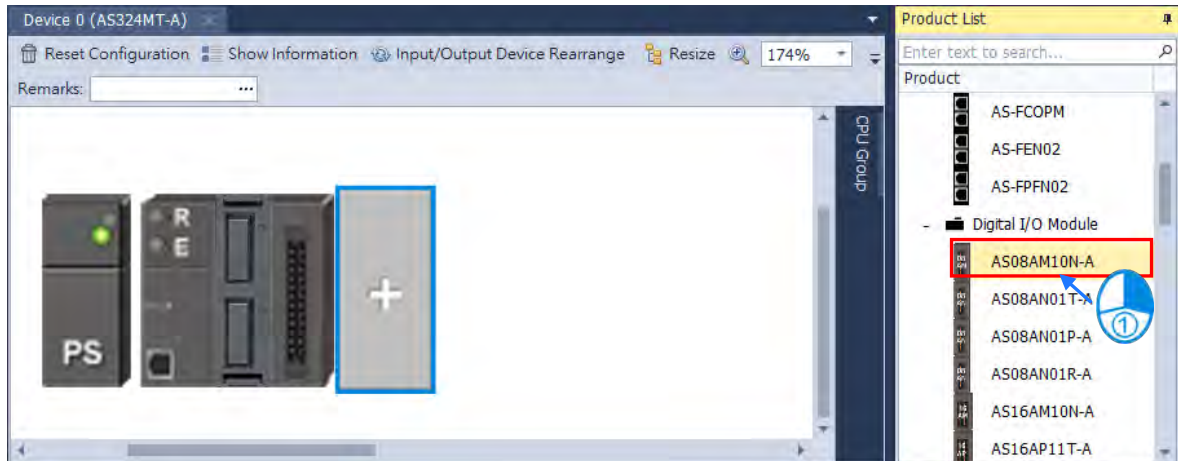

8.1.2.2 Replacing the Module

The following steps show you how to replace the module.

- (1) Select and right-click the module for replacement in **Hardware Configuration** area or from **CPU Group Information** section.

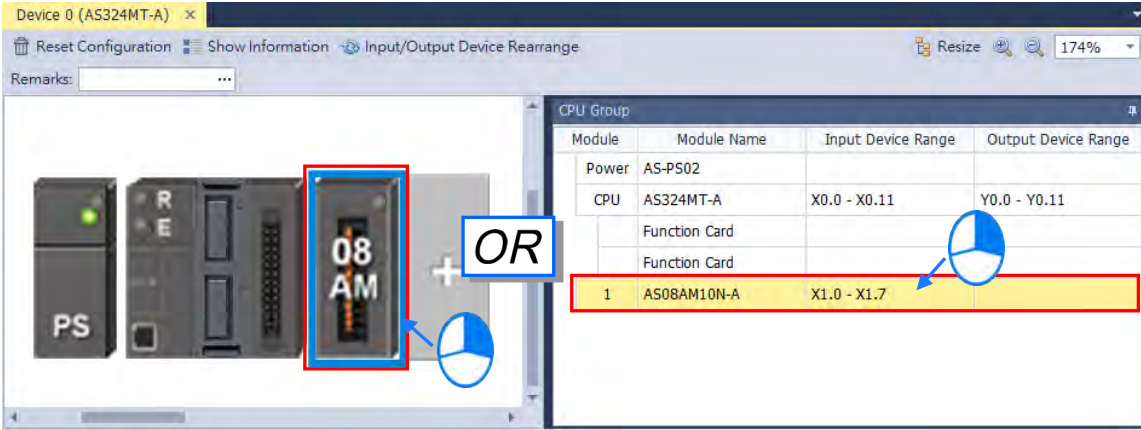

- (2) Choose **Replace** on the context menu. After that you can see two different types of replacements for selection, **Same Type** and **All Type**.

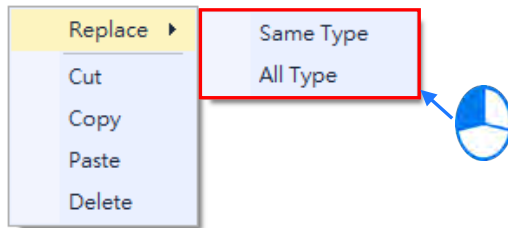

➤ **Same Type**

Replace only the selected module with the same type module. The new module **Input/Output Device Range** will be the same, while other parameters may return to system defaults if they cannot be matched.

➤ **All**

Replace selected module to be any type of module. The result is similar to deleting the original module by adding a new one, so the new module **Input/Output Device Range** will be re-configured and other parameter settings will also return to system defaults.

- (3) Once the replace type is selected, the Module Selection window appears with modules available for the selected replace type. Double click or select the module you want to replace with and click **OK**.

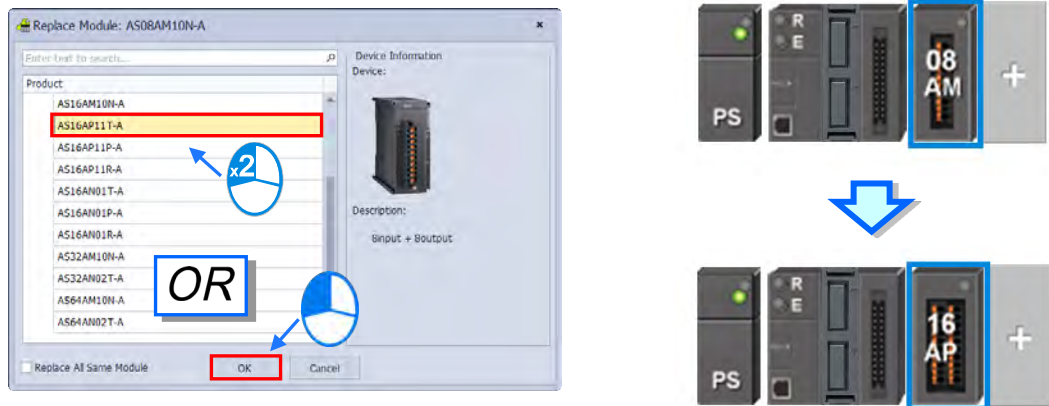

8.1.2.3 Rearrange Module Position by Drag and Drop

Except CPU modules, you can drag and drop all module graphics in Hardware Configuration area to rearrange their positions.

AS Series PLC is non-backplane designed. When the module is dragged to a position between two modules, a red arrow mark appears indicating the position where the module will be after dropping.

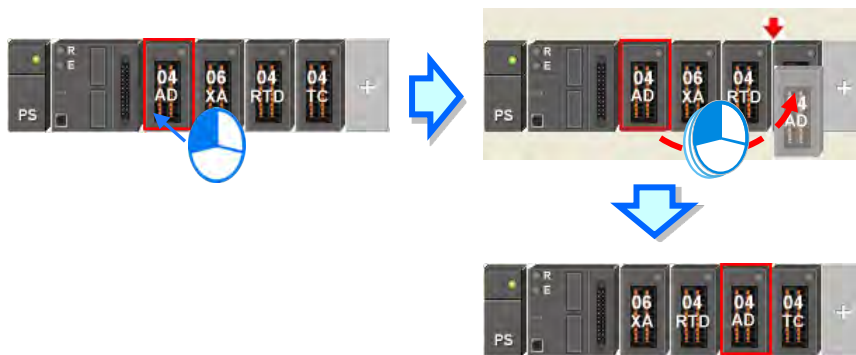

* When rearranging the module position, the input/output device range, comment, internal parameters, corresponding device D and advanced parameters for intelligent modules are also rearranged with the module.

8.1.2.4 Remarks and Comments

- **Remarks for the project**

Click **Remarks** field on the top of the **Hardware Configuration** area and a blank box appears for you to leave remarks for the project. After typing the remarks, press **Enter** on the keyboard or click **Close** to save the remarks.

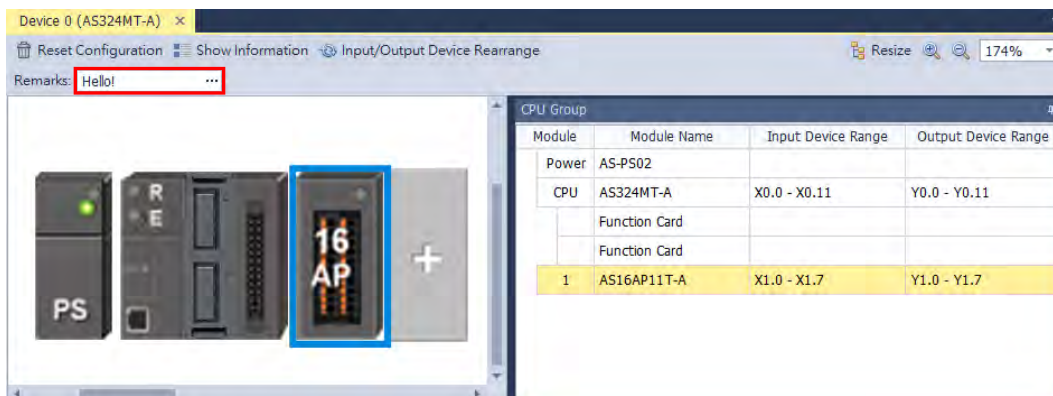
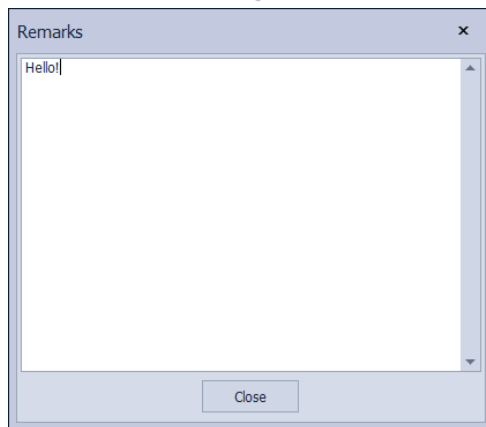
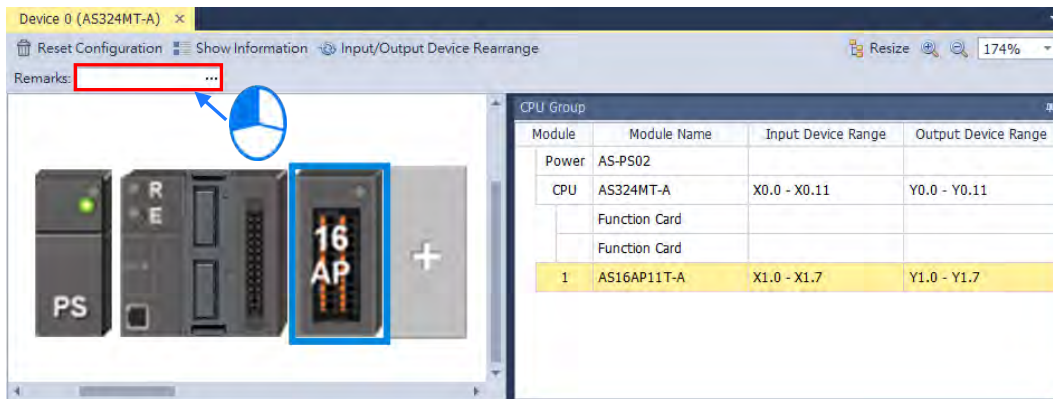

- **Comments for PLC CPU and Modules**

Click the module graphic and you can see its details in the Edit Area. You can leave comments for the PLC CPU and Modules. After typing the comments, it saves the comments automatically.

The screenshot displays the SIMATIC Manager hardware configuration interface. At the top, a rack of modules is shown, with the 16AP module highlighted by a red box. A blue callout circle with the number 1 points to this module. To the right, the 'CPU Group' table lists the modules:

Module	Module Name	Input Device Range	Output Device Range
Power	AS-PS02		
CPU	AS324MT-A	X0.0 - X0.11	Y0.0 - Y0.11
	Function Card		
	Function Card		
1	AS16AP11T-A	X1.0 - X1.7	Y1.0 - Y1.7

The 'Edit Area' at the bottom shows the details for the selected 'AS16AP11T-A' module. The 'Comment' field is highlighted with a red box and contains a calendar icon, indicating where to enter comments.

8.1.2.5 Hardware Configuration Area – Reset Configuration

Use the functional button **Reset Configuration** to set the PLC configurations back to default values.

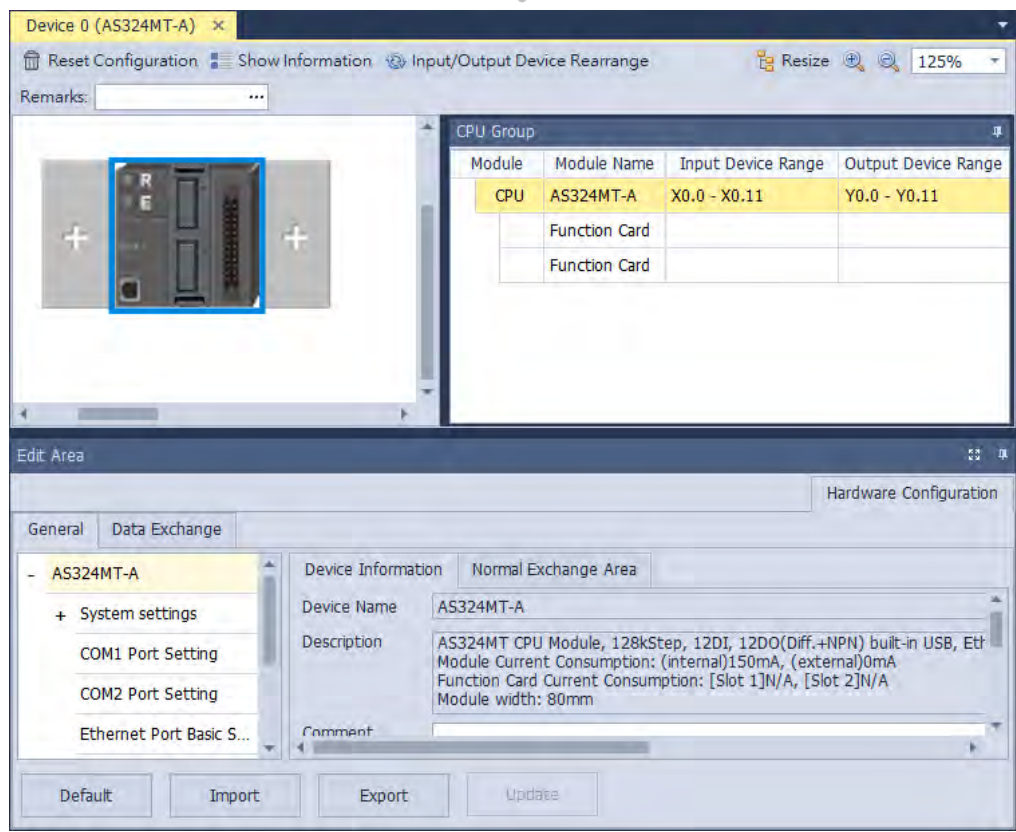
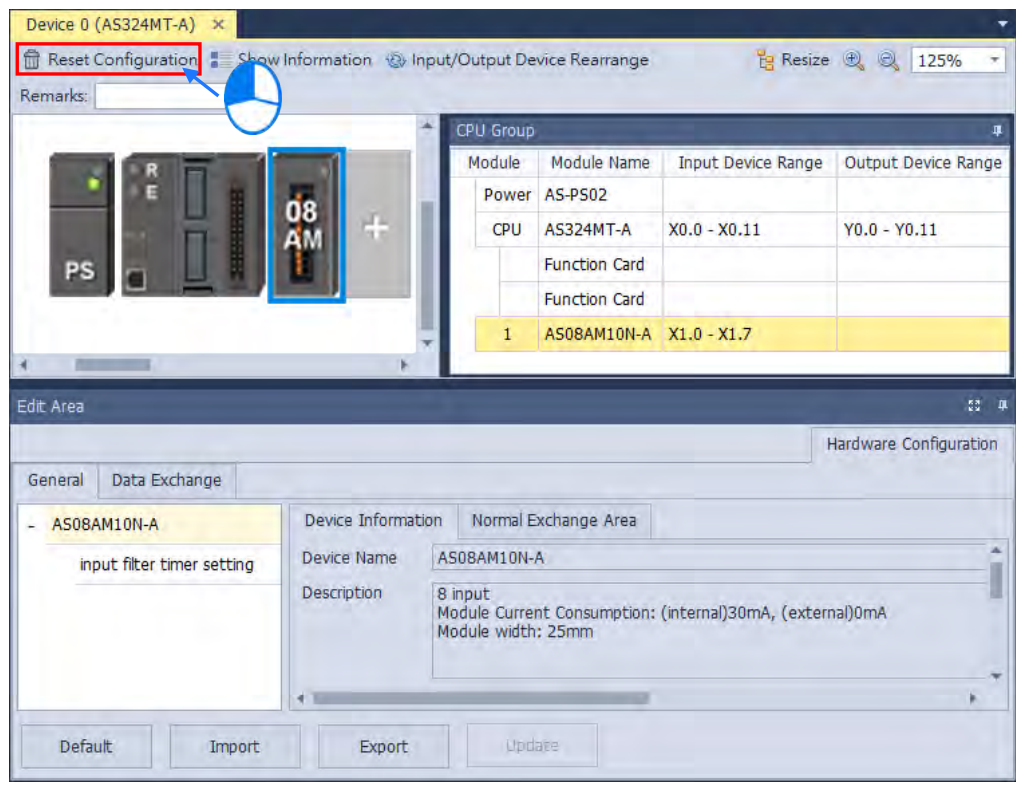

8.1.2.6 Hardware Configuration Area – Show Information

Use the functional button **Show Information** to show / hide the hardware configurations.

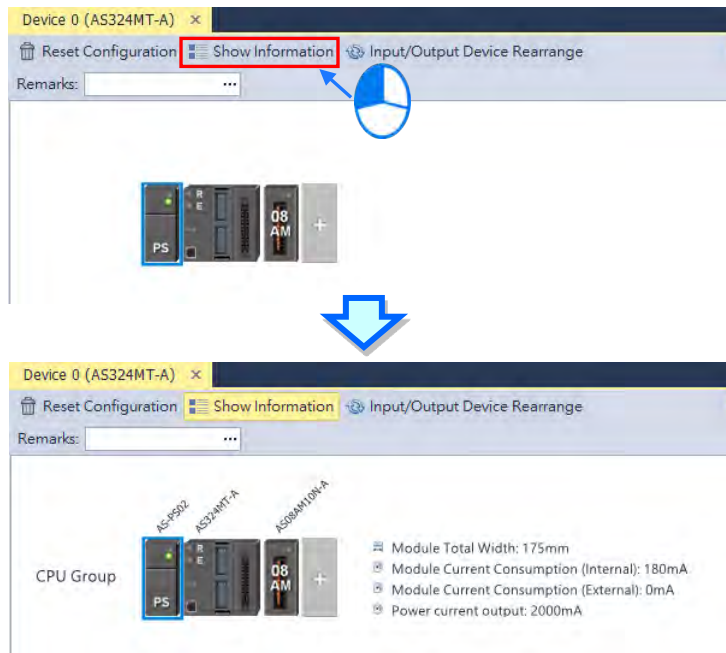

8.1.2.7 Hardware Configuration Area – Input / Output Device Rearrange

Use the functional button **Input / Output Device Rearrange** to rearrange the device ranges and assign the devices to the very beginning of the range.

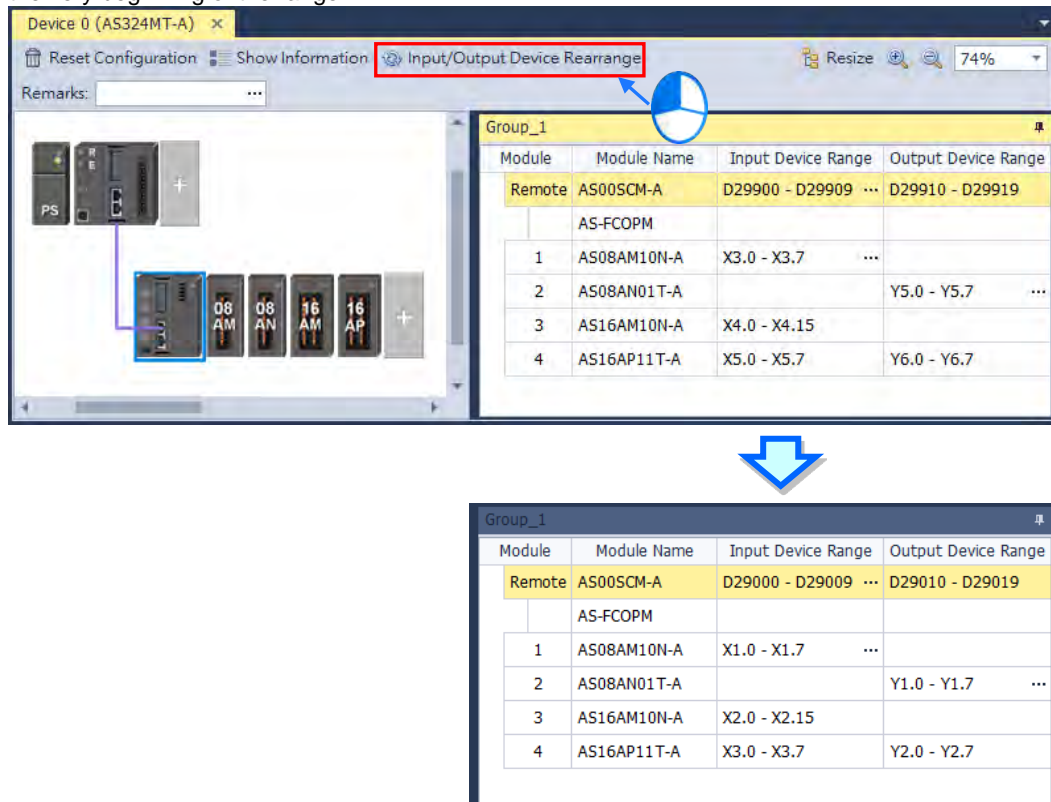

8.1.2.8 Assigning I/O Addresses

The AS Series does not support manually assigned addresses. Addresses are automatically assigned to an input/output module through HWCONFIG in ISPSOft. You assign a start address to the first remote module installed on the right side of the I/O module slot (SCM module). The following I/O module is automatically assigned with the next address. For remote module configuration, refer to Section 8.1.2.9 for more details.

The following table shows the addresses (devices) that are automatically assigned to an input/output module through HWCONFIG in ISPSOft. Refer to the following table to see the actual allowable range for program design, while editing a PLC program. Below, local indicates the IO module is connected on the right side of the CPU and Remote indicates the IO module is connected on the right side of remote module.

Module type	X/Y device range	D device range	Remark
Digital module (DIO)	Input points: X1.0 ~ X63.15 Output points: Y1.0 ~ Y63.15	Local: D28000 ~ D28999 Remote: D29000 ~ D29999 ^{#1} Each module takes 20 devices.	Data device number will not be shown; it is only for PLC internal use. Maximum points in total: 1024 points. For modules with less than 16 points, they will be counted as 16 points.
Analog module (AIO)	N/A	Local: D28000 ~ D28999 Remote: D29000 ~ D29999 ^{#1} Each module takes 20 devices.	Up to 16 AIO modules are configurable.
Positioning module (PIO)	N/A	Local: D28000 ~ D28999 PU module takes 40 devices. HC module takes 20 devices.	Up to 8 PIO modules are configurable locally, but not available remotely.
Network module (NIO)	N/A	Local: D28000 ~ D28999 Remote: D29000 ~ D29999 ^{#1} Each module takes 20 devices. Communication data area: D26000 ~ D27599 Each module takes 400 devices.	Up to 4 NIO modules are configurable locally. SCM module can be used as remote module but not on the right-side of the remote module. DNET modules can only be connected locally. SIL modules can either be used locally or remotely.

Note: #1: the remote module itself also takes 20 devices.



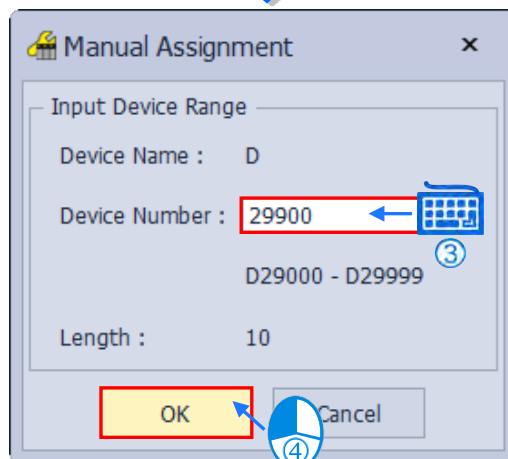
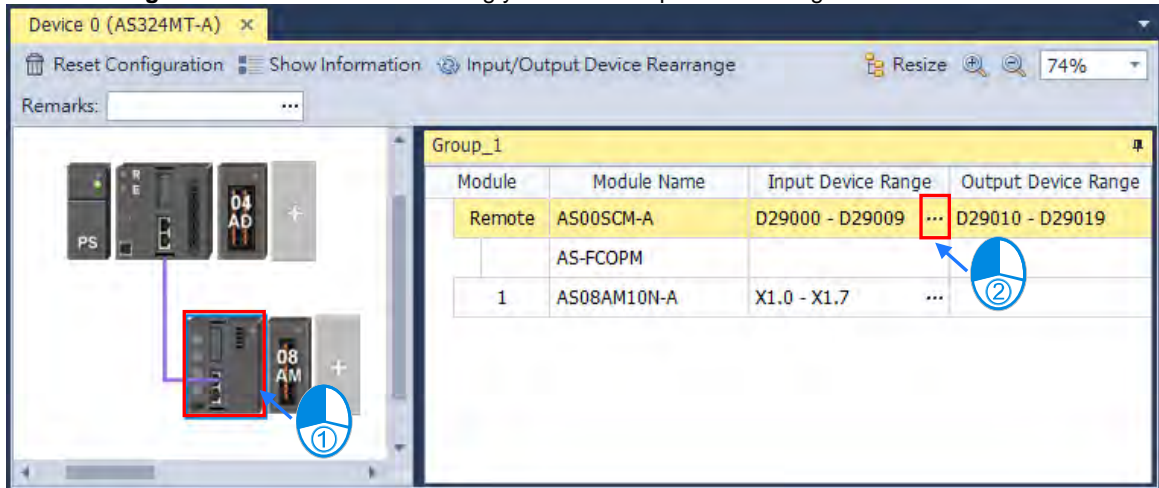

8.1.2.9 Hardware Configuration Area - Change Input Device Range of the Remote Modules

Click the remote module and then you can see ... in the column of **Input Device Range**. Double-click it to see the **Manual Assignment** window and start editing your desired input device range.

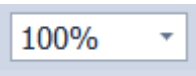

Module	Module Name	Input Device Range	Output Device Range
Remote	AS00SCM-A	D29900 - D29909 ...	D29910 - D29919

8.1.2.10 Hardware Configuration Area - Resize

Use the functional buttons ,  or  to rearrange the size of the device images in Hardware Configuration Area. Use  to set the display of the configuration area back to its default values (shown at 100% and in the center).

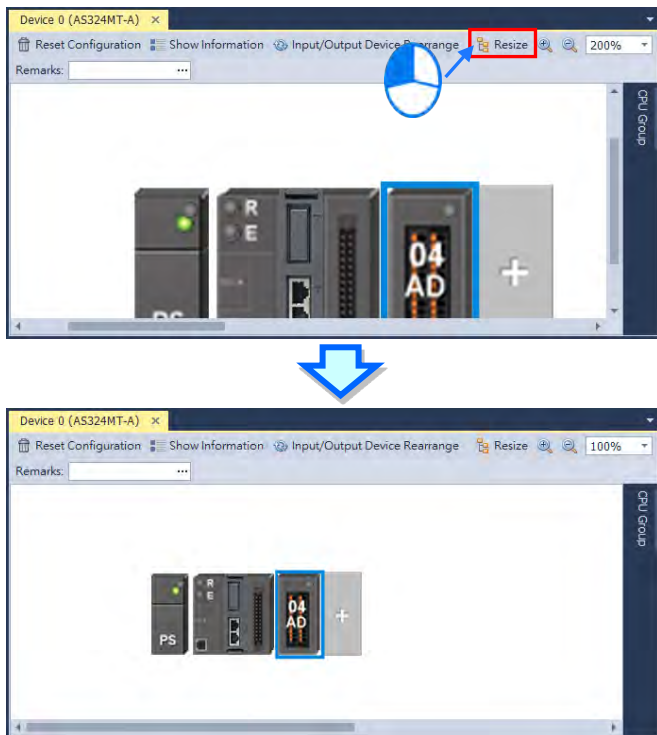

8.1.2.11 Edit Area – Import and Export

You can import/export the module parameters in .dep format. Click the **Import** button and then choose a file to import. Click the **Export** button and then choose a path and enter a file name for the exported file. Click the **Import** button to import. When importing, the system checks if the file format and the module name are matched. If not, an error message shows up. If the addresses of the imported data device are already taken, the addresses will be assigned to other available addresses.

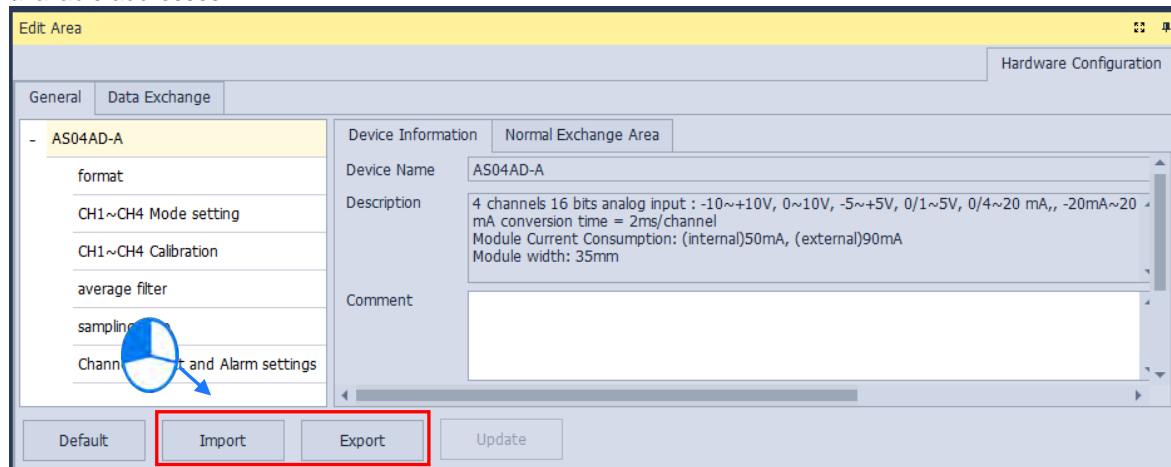

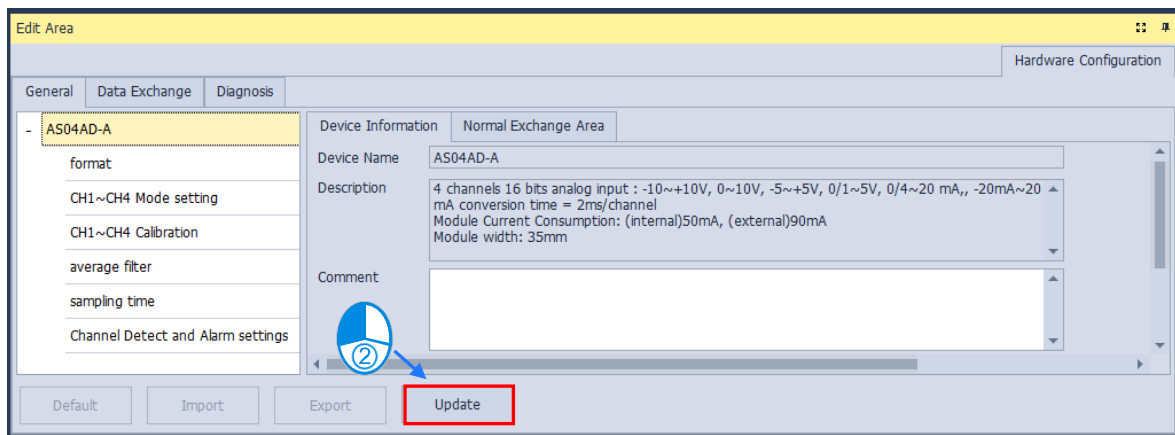

8.1.2.12 Edit Area – Update

To update the module parameters, first you need to be in the online mode. Select the module that you want to update its parameters and then click the **Update** button. This functionality is only available for digital IO modules, analog IO modules and network modules.





8.1.2.13 Show or Hide the Display

Click  or  to hide the display area and after that only its tab remains shown. Move your cursor to the tab to have the hidden display area shown. Click  to pin and lock the display area to keep it shown.

8.1.2.14 Module State and Diagnosis

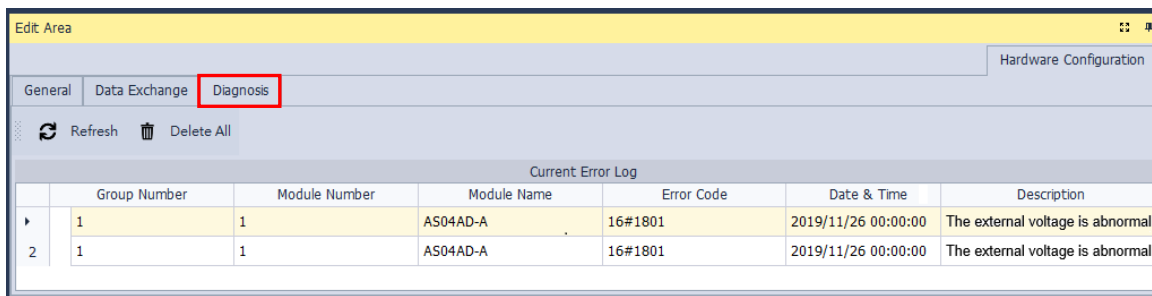
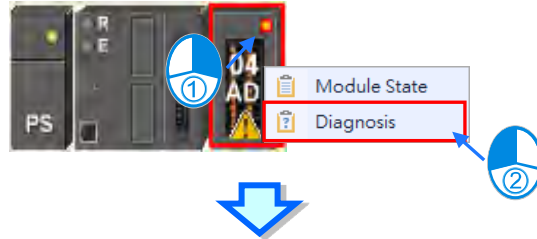
To check the module state and diagnosis, first you need to be in the online mode. Right-click the module that you want to check its module state and diagnosis and then a context menu appears.



After you click Diagnosis, you can see a table with three tabs. On the Diagnosis tab, you can see the Current Error Log table. When the error is cleared, you can use  to clear the error log stored in the module and the module state can be restored to normal. Use  to update the module state.

8.1.2.15 Change Module State in Online Mode

You can change the module state in online mode.

 Before changing the module state, make sure no personnel or system will be affected.

- **Change the module operation state**

Right-click the PLC CPU to see the context menu and click **Run** for the PLC CPU and module to start running (RUN LED ON) or click **Stop** for the PLC CPU and module to stop running.

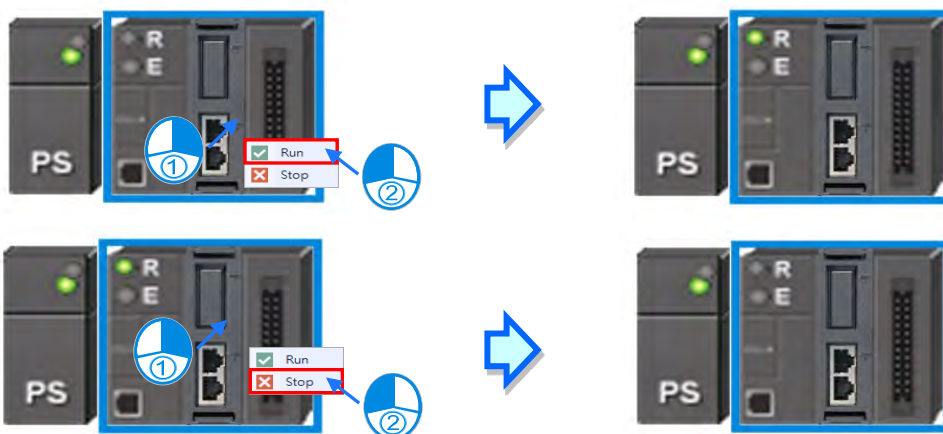

- **Change the module I/O state**

This functionality is only available for digital IO modules, analog IO modules and temperature modules. Right-click the module to see the context menu and click **Module State** and then you can see an IO state table shows up. For digital IO modules, you can right-click to set the input/output channel to ON or OFF, when the PLC CPU and the module are on the RUN state.

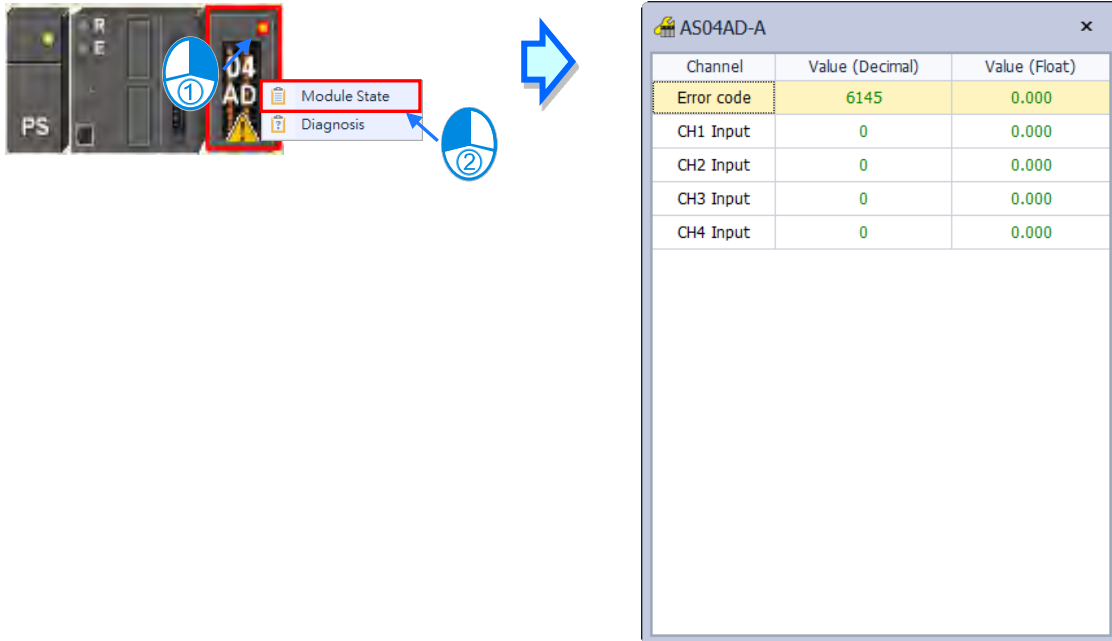

- **Force to ON** : Force to set the channel state to ON
- **Force to OFF** : Force to set the channel state to OFF
- **Release** : Release the selected channel from the force
- **Release all** : Release all channels from the force

8.1.2.16 Configure a Remote Module

Drag AS-FCOPM from the Product List to the Function Card Slot 2 of the PLC CPU. After that you can set the Working Mode for the AS-FCOPM as AS Remote Communication and then you can set the quantity of the Remote Modules that you want to connect.

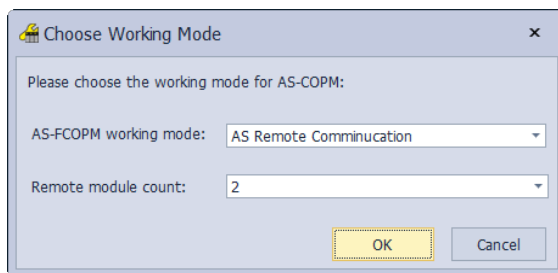
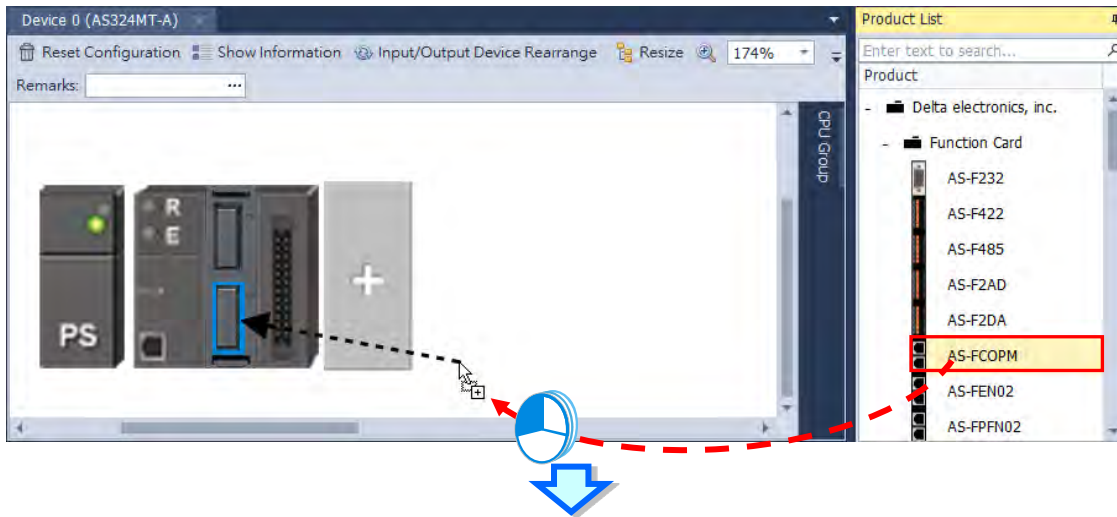

If you set the Remote module count to 2 and click OK, you can see two remote modules connected to the PLC CPU.

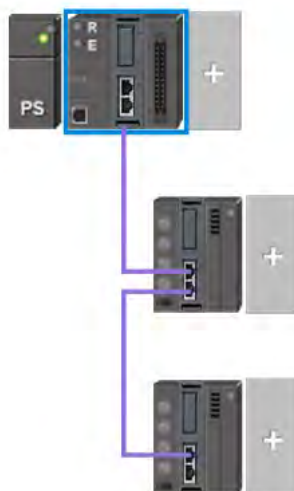

You can add more digital IO modules or analog modules to the remote module.

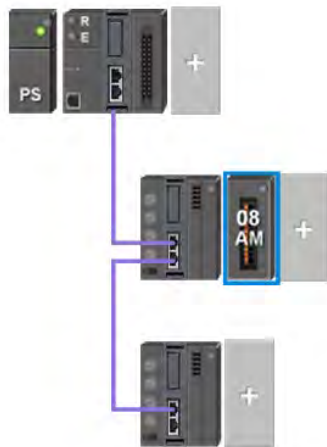
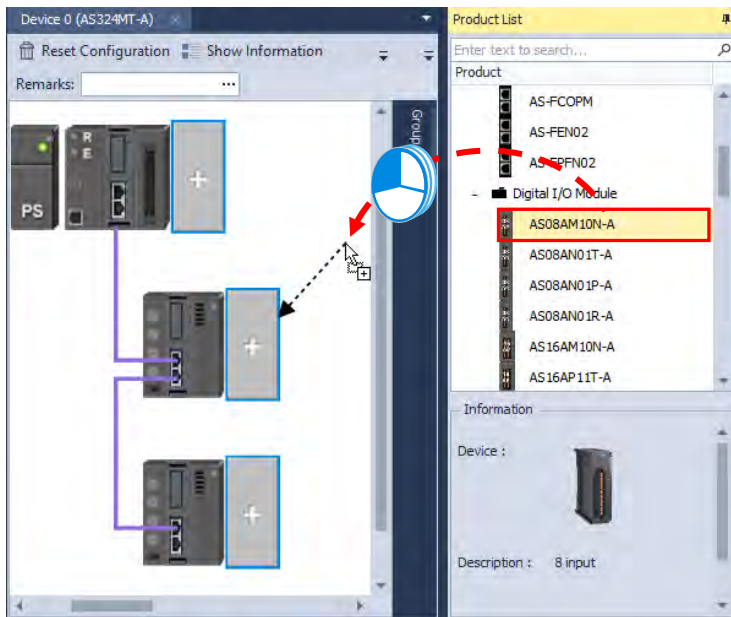

And then you can click the module to open its configuration page to configure.

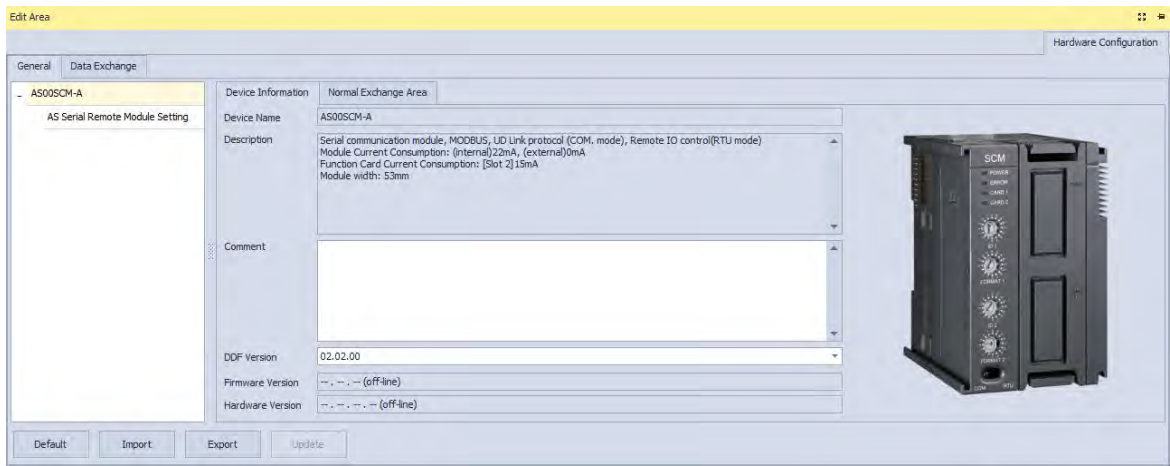
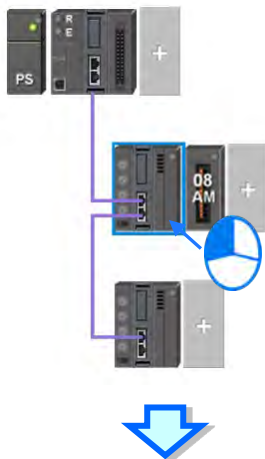

8.1.2.17 Open Communication Software from HWCONFIG

Right-click the PLC CPU and click **Communication Software** to see which software is available for this PLC CPU. If the software option is grayed out, you may need applicable function cards to work along with the project.

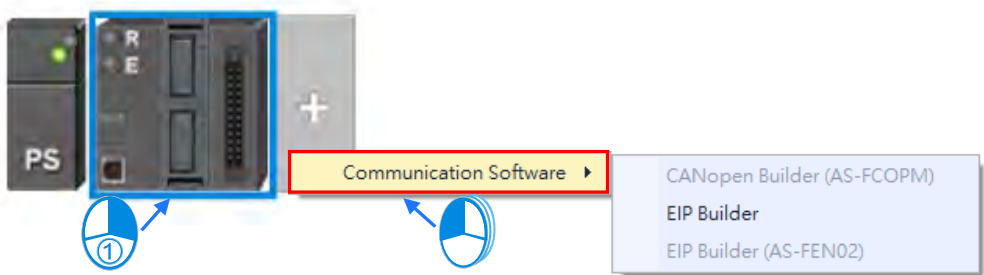

8.2 Setting the Parameters in an AS Series CPU Module

8.2.1 System Settings – System Information

In the Edit Area, select the option **System Settings** and you can find two items, **PLC Label** and **Comment** under this option. You can input up to 16 characters in the value field of **PLC Label** and 32 characters in the value field of **Comment**. You can use all in the fields, including special characters and spaces. Note: One Chinese character occupies two characters. characters

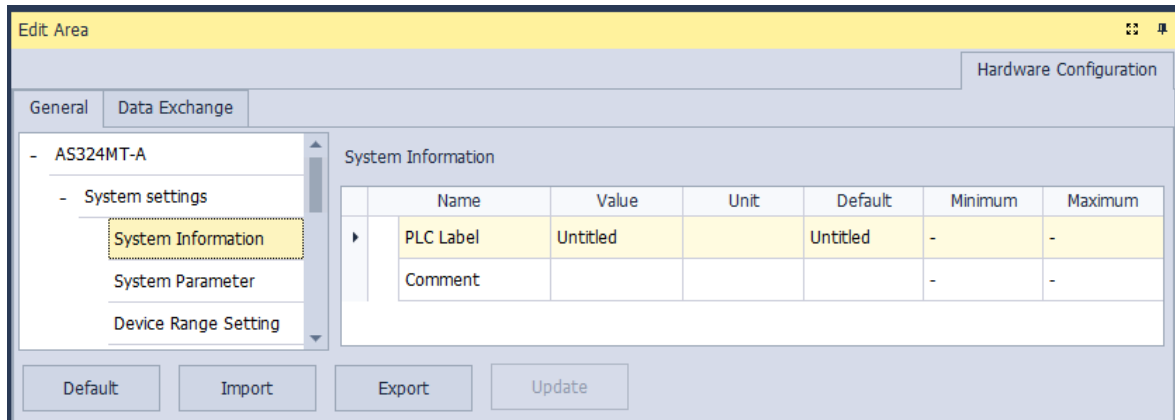

After the project is created, you can find the PLC label behind the product name in the project management area. You can change the PLC label in HWCONFIG as it is mentioned above. The PLC label is very useful when you have more than one PLC in the project. This label can be seen as the PLC identity. So that you will not change other PLC parameters by mistake. To prevent errors, when you download/upload the program, the system will remind you to check the name of the PLC CPU and the PLC label.

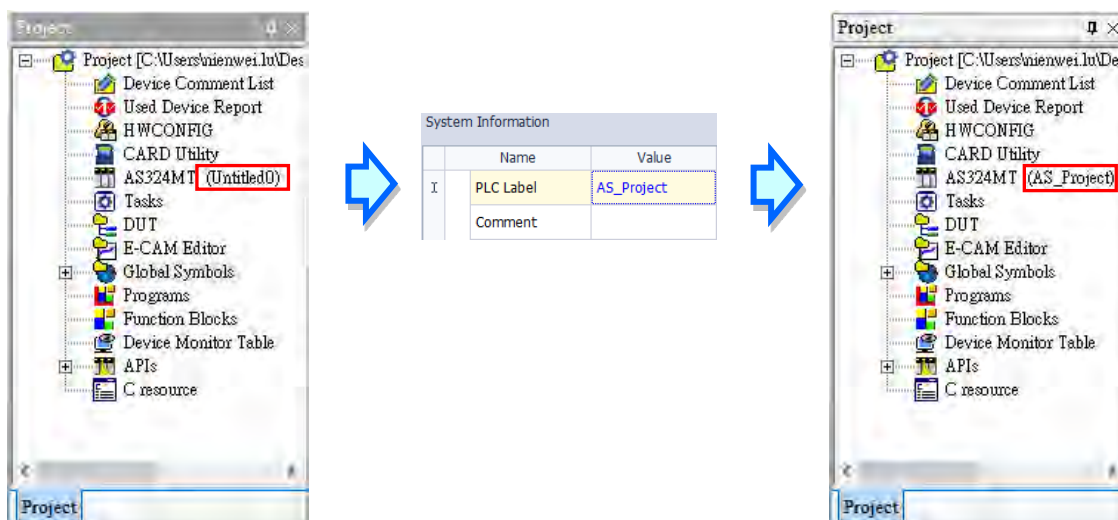

8.2.2 System Settings – System Parameter

The parameters on **System Parameter** table are shown in the following window. You can set appropriate values via a drop-down list or type the values in the box.

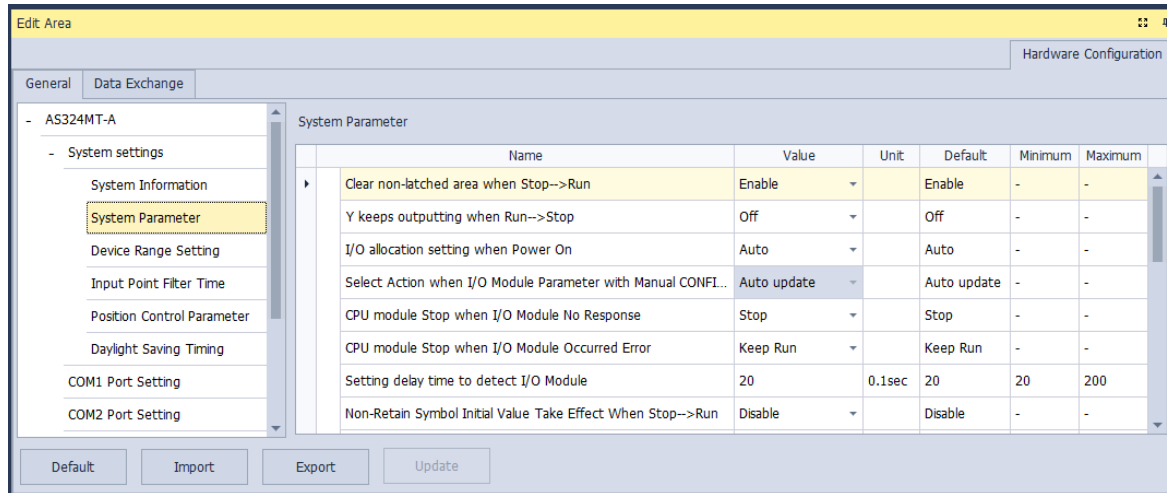

- **Clear Non-latched area when Stop →Run**

This determines whether the states and values of the non-latched devices are cleared when the PLC changes from Stop to Run.

- **Disable:** All the states and values in the non-latched devices stay the same.
- **Enable:** All the states and values in the non-latched devices are cleared and restored to defaults.

- **Y keeps outputting when RUN →Stop**

This determines the states of the Y devices when the CPU module begins to run or stop.

- **Off:** All Y devices are set to OFF.
- **Keep:** The states of the Y devices stay the same.

- **I/O allocation setting when Power On**

This determines whether the CPU module is automatically configured, or you configure the parameters in HWCONFIG.

- **Auto:** Operates based on actual connected modules without any module and parameters set.
- **Manual:** You configure the parameters in HWCONFIG and PLC checks the parameters automatically once it is supplied with power.
- **Manual + Flags (only I/O module of CPU module):** This function is available for PLC with firmware V1.06.00 or above and you need to use ISPSOft V3.07 or above to execute this function. Firstly you can create the largest possible module allocation design and use this option along with the SM flags (refer to Chapter 2 in AS Series Programming Manual for more information on SM flags) to activate or deactivate the modules on the right-side of the PLC CPU to set up a smaller I/O application without changing the PLC program, the original I/O allocation table or its corresponding device address.

- **Manual + Flags (I/O module of CPU and Remote module):** This function is available for PLC with firmware V1.08.50 or above and you need to use ISPSOft V3.12 or above to execute this function. Selected this option, you can control both the right-side modules of the PLC CPU and the remote modules. The operation is the same as the operation of the option above, Manual + Flags (only I/O module of CPU module). Refer to the explanation on Manual + Flags (only I/O module of CPU module) for more details.

- **Select Action when I/O Module Parameter with Manual CONFIG Different**

This determines which action is taken when the actual settings are NOT the same as the parameters that you manually set when the previous setting option is set to **Manual**.

 - **Auto update:** the CPU module is automatically configured.
 - **Show error:** the CPU module shows an error.

- **CPU module Stop when I/O Module No Response**

This determines how the CPU module and other modules react when a connected extension module is not responding.

 - **Stop:** the CPU module stops running and sends an error.
 - **Keep Run:** the CPU module and I/O modules keep running.

- **CPU module Stop when I/O Module Occurred Error**

This determines how the CPU module reacts when a minor module error occurs.

 - **Stop:** the CPU module stops running and sends an error.
 - **Keep Run:** the CPU module keeps running and sends an error.

- **Setting delay time to detect I/O Module**

This sets the timing when to start detecting the connected I/O module after CPU module is power-on.

Normally the CPU module detects its connected I/O module once it is supplied with power. But you can set the delay time (unit: 0.1 second) for the CPU module to postpone detecting. This function is very useful when it takes time for the supply power to be stable or when the remote I/O module is not supplied with power at the same time as the CPU module is. With a set delay time, the detection on the connected sets can be more accurate. Refer to the image below for the time frame.

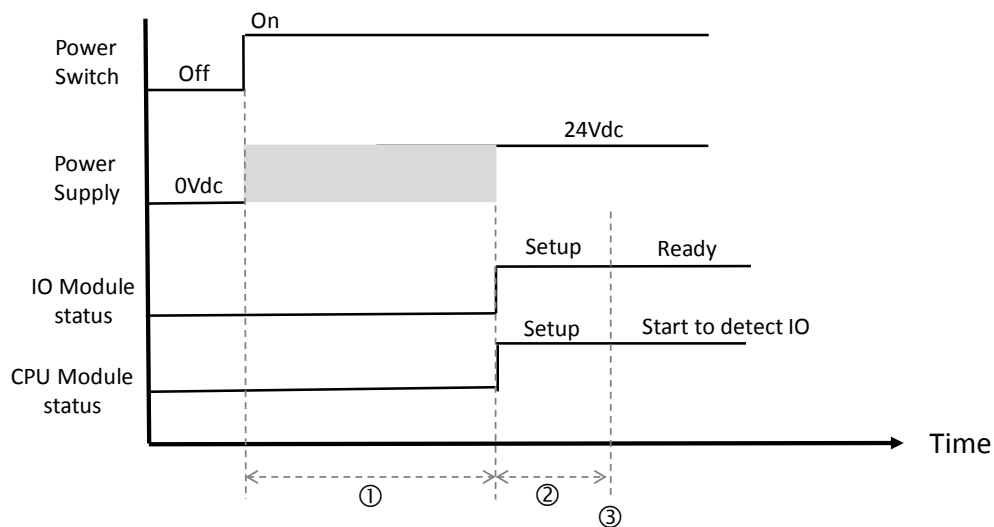

- ① When the power is switched from OFF to ON, the power supply will be unsteady for a short time. During this short period of time, the CPU module and I/O module are not ready to operate normally.
- ② When the supply power for the CPU module and the I/O module is stable, the system starts to initialize for about 1 second. After that the I/O module is ready to be detected by the CPU module.
- ③ The CPU module starts to wait for the set delay time to pass. Once the delay time is up, it starts to detect the connected I/O modules locally and remotely.

It is suggested using ① + ② to set the delay time. Default delay time is 2 seconds.

● Non-Retain Symbol Initial Value Take Effect When Stop → RUN

This determines whether the states and values of the non-latched devices are restored to initial values when the PLC changes from Stop to Run.

- **Disable:** All the states and values in the non-latched devices stay the same.
- **Enable:** All the states and values in the non-latched devices are restored to initial values when the PLC changes from Stop to Run. .

● Retain Symbol Initial Value Take Effect When Stop → RUN

This determines whether the states and values of the latched devices are restored to initial values when the PLC changes from Stop to Run.

- **Disable:** All the states and values in the latched devices stay the same.
- **Enable:** All the states and values in the latched devices are restored to initial values when the PLC changes from Stop to Run. .

● Assign X Input Point Control Run/Stop

This assigns an input point to have the CPU module run or stop.

- **Disable:** Run or stop the CPU module by the dip switch of the CPU module.

➤ **Enable:** Run or stop the CPU module by the assigned input point, and the dip switch of the CPU module still controls the run stop state of the CPU module.

- **Select X Input Point**

If you select **Enable** in the previous option, you can select one input point to control the Run or Stop state of the CPU module from the dropdown list.

- **Constant Scan Cycle Time**

This sets the minimum scan cycle time.

➤ **Disable:** Disables this function.

➤ **Enable:** When the actual scan cycle time is less than the setting time, the CPU module waits until the setting time is met, and then starts the next scan. When the actual scan time is longer than the setting time, the CPU module starts the next scan after the actual scan time completes.

- **Input Constant Time**

If you selected **Enable** in the previous option, you set the scan cycle time here. If the actual scan time is less than the setting time, the CPU module waits to begin the next scan until the setting time is met. If the actual scan time is larger than the setting time, the CPU module ignores the setting time and operates according to the actual scan time. If you set the scan time longer than the watchdog timeout set, a watchdog timeout occurs when the CPU module operates.

- **Setting Watchdog Time**

This parameter sets a timeout during which the program is scanned. The CPU module sends an error if the program execution exceeds the watchdog time.

- **Show Battery Low Voltage Error (BAT.LV)**

This parameter sets whether to show an alarm when the lithium battery for the real-time clock has low voltage or is not installed in the AS Series PLC.

➤ **Disable:** Disables this function.

➤ **Enable:** Enables the alarm by keeping the low voltage LED ON when the lithium battery has low voltage or is not installed.

Note: If the PLC self-checks and finds an error in the RTC, this low voltage LED will be ON, even if this option is disabled.

- **Save Error History Info**

This specifies where to store the error log.

- **PLC:** Store error logs in the PLC. The PLC can store up to twenty error logs. If there are more than twenty error logs, the oldest error log is overwritten by the latest error log.
- **PLC & SD Card:** When there are more than twenty error logs, the oldest error log is backed up to the memory card before the oldest error log is overwritten in the PLC.

- **COM Communication Error Record**

This parameter sets whether to enable the error record when there is an error at the COM port.

- **Disable:** Disables this function.
- **Enable:** Enables this function and starts recording COM errors in the error log.

- **Select Action When 24Vdc Input Unstable**

What to do when the 24Vdc power is unstable: When the power is unstable, this incident will be recorded in error log and SM7 will be ON.

- **Continue Running when power stable:** When the power is unstable for 20 to 100 ms, the AS Series PLC CPU pauses, and after the power stabilizes for at least 2 seconds, the PLC continues running.
- **Into Error Status:** When the power is unstable, the error LED blinks and the AS Series stops running. The voltage is unstable and the communication will also be affected. You need to cut the power off and then solve the power problem. After that you can power-on again and AS Series PLC CPU will start running. If the communication is not affected, it indicates the power is back to normal. But you still need to find out what went wrong.

- **Communication Module Refreshed Priority**

- **Scan time first:** Only refresh the data that is different from the original ones to save scan time.
- **Synchronous Data first:** Scan and refresh all the data to ensure all data are synchronized.

- **AS remote module updated method**

- **PLC Scan cycle first:** update according to PLC program scan cycle. Whenever the instruction END is scanned, one remote module is updated.
- **Update one remote module by one scan time:** update one remote module at one scan time. Whenever the instruction END is scanned, one remote module is updated and its output points are outputting at the same time.
- **Update all remote modules at one scan time:** update all remote modules at one scan time. Whenever the instruction END is scanned, all remote modules are updated and all output points are outputting at the same time.

- **I601 Timer interrupt Setting Time Base**

Sets the interval for triggering the 1601 timer interrupt. This function is used together with Timer Interrupt 0. If you need to modify the time of the I601 timer interrupt during the PLC program execution, you can use SR421 for editing.

- **I602 Timer interrupt Setting Time Base**

Sets the interval for triggering the 1602 timer interrupt. This function is used together with Timer Interrupt 1. If you need to modify the time of the I601 timer interrupt during the PLC program execution, you can use SR422 for editing.

- **I603 Timer interrupt Setting Time Base**

Sets the interval for triggering the 1603 timer interrupt. This function is used together with Timer Interrupt 2. If you need to modify the time of the I601 timer interrupt during the PLC program execution, you can use SR423 for editing.

- **I604 Timer interrupt Setting Time Base**

Sets the interval for triggering the 1604 timer interrupt. This function is used together with Timer Interrupt 3. If you need to modify the time of the I601 timer interrupt during the PLC program execution, you can use SR424 for editing.

8.2.3 System Settings – Device Range Setting

The parameters on **Device Range Setting** table are shown in the following window.

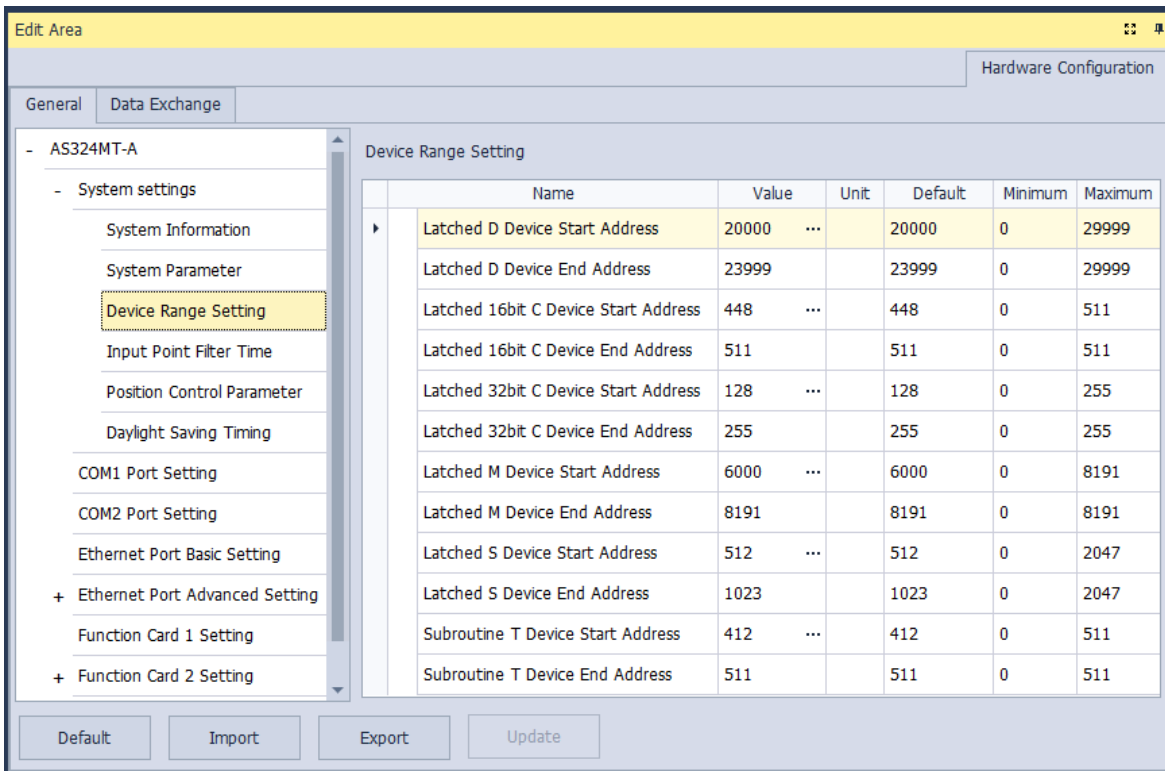

Click **...** to open the parameter dialog box to set the start and end address. In the dialog box, click **Default** to restore the setting to the default values; click **Clear** to clear the set values; click **OK** to save the values and close the dialog box; click **Cancel** to discard the setting and close the dialog box.

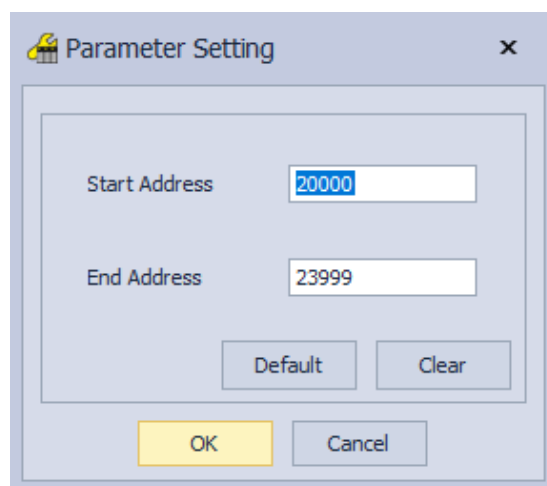

8.2.4 System Settings – Input Point Filter Time

On the Input Point Filter Time page, you can set the input point filter time for each input. If the duration of the received signal time is less than the filter time setting value, it is processed as noise and filtered out. Select an appropriate filter time according to your needs.

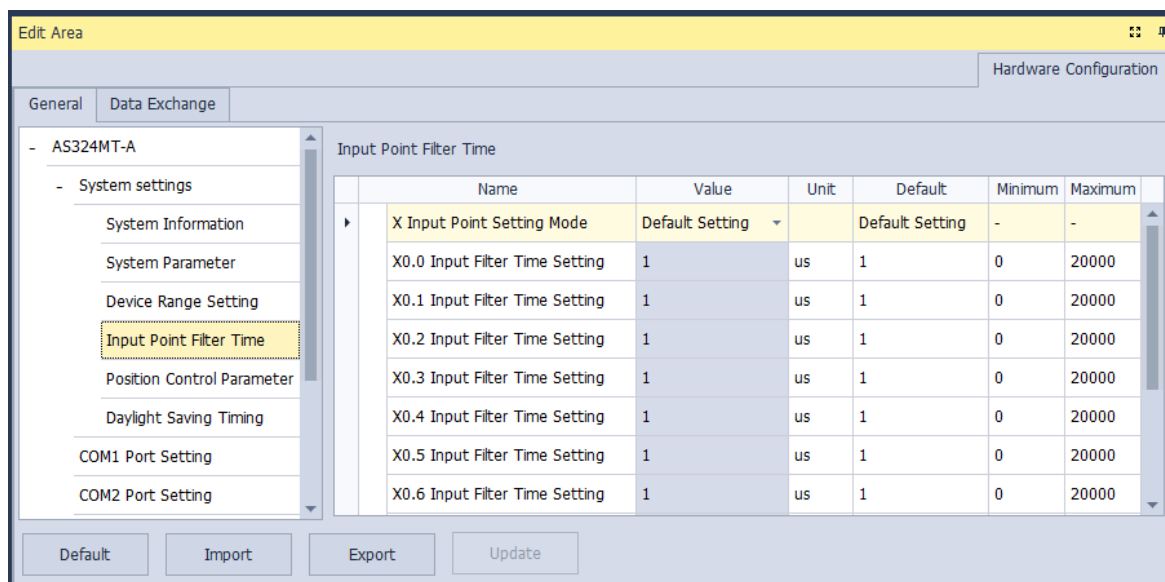

- X Input Point Filter for CPU module
 - **Default Setting:** uses the default values in the input point filter.
 - **Manual Setting:** uses the values you enter for the filter time for each X input point.
- X0.0–X0.15 Input Point Filter Time

If you select **Manual Setting** for the previous parameter, you can set the filter time individually for X0.0–X0.15.

8.2.5 System Settings – Position Control Parameter

The parameters on **Position Control Parameter** table set to specify input points as the positive and negative limits of axis 1~ axis 6 channels. 12 limit points can be set at most. Axis No. 1~6 can also be set as Z phase triggers, home function finish points and clear output selects or positive/negative limited position.

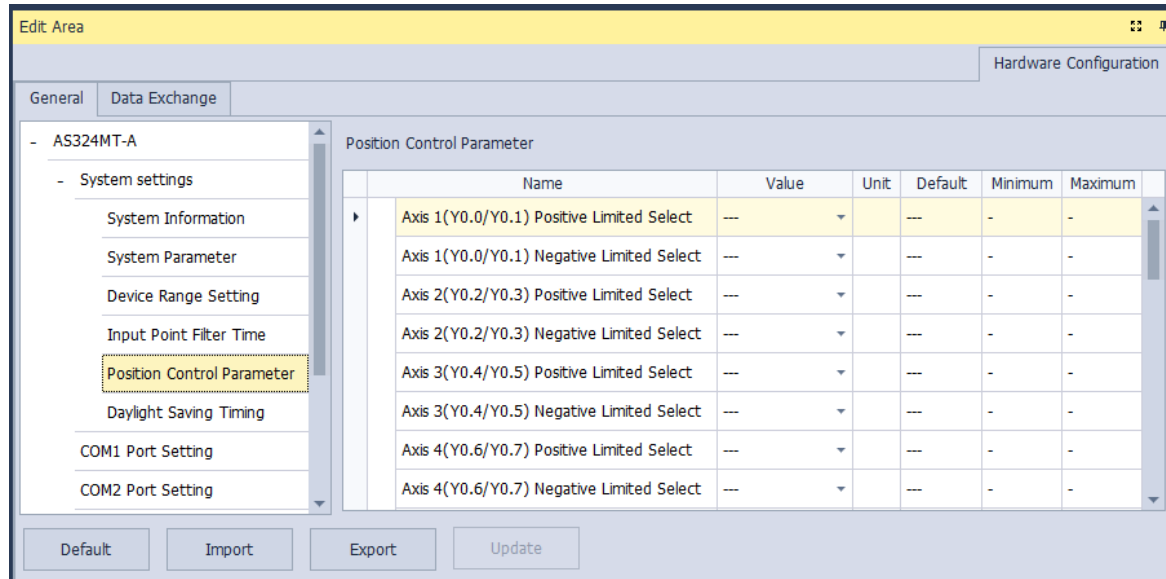

- **Axis1 (Y0.0/Y0.1) Positive/negative Limited Select ~ Axis 6 (Y0.10/Y0.11) Positive/negative Limited Select.**
Select the rising or falling edge trigger and X input point on the drop-down list.
- **Axis1 (Y0.0/Y0.1) Z Phase Trigger ~ Axis6 (Y0.10/Y0.11) Z Phase Trigger**
Select the rising or falling edge trigger and X input point on the drop-down list.
- **Axis1 (Y0.0/Y0.1) Home Function Finish and Clear Output Select ~ Axis6 (Y0.10/Y0.11) Home Function Finish and Clear Output Select**
Select the rising or falling edge trigger and X input point on the drop-down list.
- **Axis1 (Y0.0/Y0.1) Positive/negative Limited Position ~ Axis6 (Y0.10/Y0.11) Positive/negative Limited Position**
Set up the number of pulses as the positive or negative limited position in axis 1~6; setting range is - 2147483647 ~ 2147483647.

8.2.6 System Settings – Daylight Saving Timing

The parameters on **Daylight Saving Timing** table are used to enable or disable the function of daylight saving time and set the date when the daylight saving is conducted. The clock will automatically set the daylight saving time in advance based on the period of time set after the function is enabled.

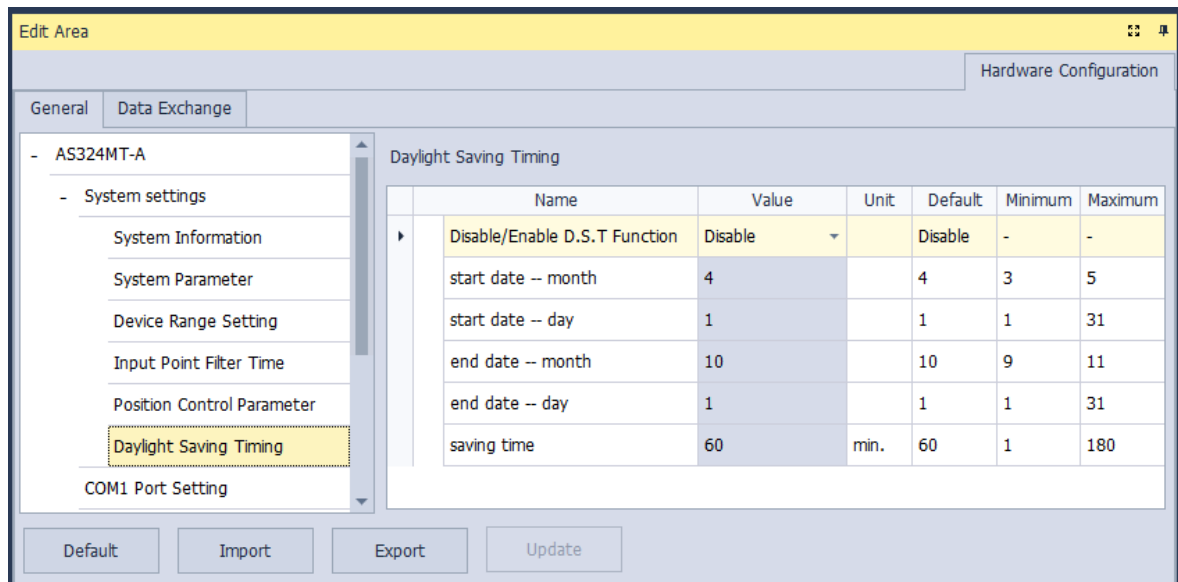

- **Disable/Enable D.S.T Function**

The parameter sets to enable or disable daylight saving time.

- **Start date- month**

The parameter sets the month from which the daylight saving time starts.

- **Start date- day**

The parameter sets the date on which the daylight saving time starts.

- **End date- month**

The parameter sets the month in which the daylight saving time ends.

- **End date- day**

The parameter sets the date on which the daylight saving time ends.

- **Saving time**

The parameter is used to adjust to the earlier daylight saving time with the unit of minute.

Example explanation: example from the above image and all the options are enabled.

Date shown in SR	Time shown in SR	PLC time (Real Time Clock)	Remarks
3/31	23:59:58	23:59:58	Normal
3/31	23:59:59	23:59:59	
4/01	01:00:00	00:00:00	Shown after 60 minutes
4/01	01:00:01	00:00:01	
: (to)	: (to)	: (to)	

9/30	23:59:59	22:59:59	
10/01	00:00:00	(9/30) 23:00:00	
: (to)	: (to)	: (to)	
10/01	00:59:59	(9/30) 23:59:59	
10/01	00:00:00	00:00:00	Normal
10/01	00:00:01	00:00:01	

8.2.7 Options - COM1 Port Setting & COM2 Port Setting

PLC modules are equipped with one or two COM ports based on different models. COM1 and COM2 parameters are set by clicking **COM1 Port Setting** and **COM2 Port Setting** in the list on the left-side of the following window. And the setting items for the two COM ports are the same.

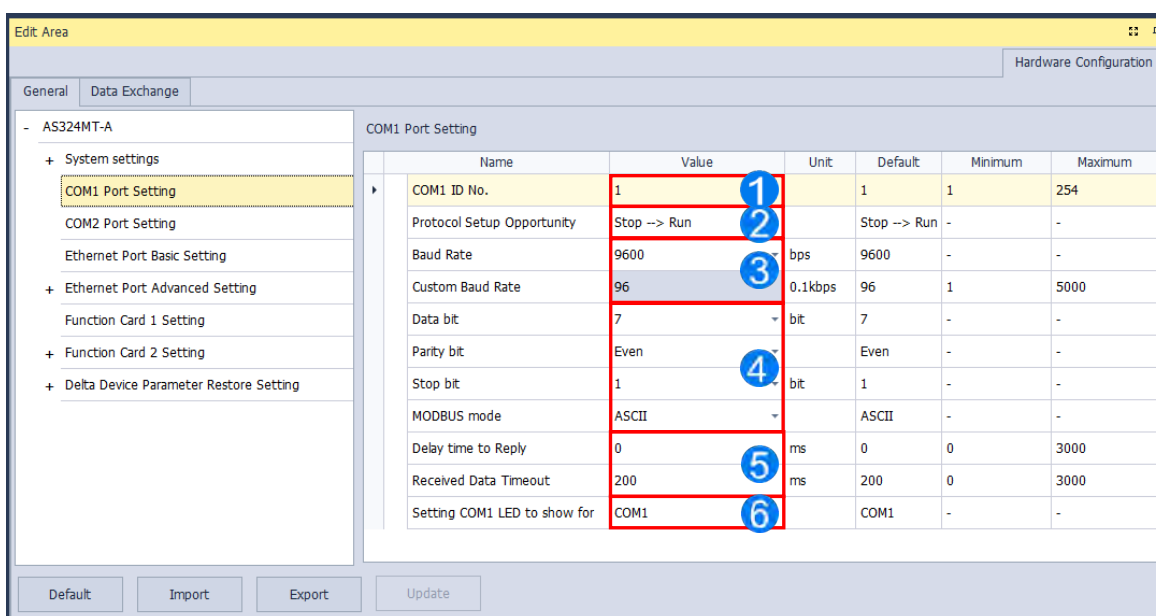

- ❶ Set a station address. You can identify a device on a network by the station address. The station address cannot be the same as the station address for another device on the same network. If the communication port functions as a slave, and there are other slaves, the station address of the communication port cannot be 0. Station address 0 broadcasts to all slaves in a communication protocol. If a master specifies in a data packet that data must be sent to station address 0, the data is sent to all slaves. No matter what the station address of these slaves are, these slaves receive the data packet addressed to station address 0.
- ❷ Set when the communication port runs. Select **Stop --> Run**, and communication works when the CPU module switches from Stop to Run. If you instead select **Power-on**, the communication starts working when you Power-on the module.
- ❸ Select a communication speed in the **Baud Rate** list, or select **Custom** and enter a new rate.
- ❹ Set the communication parameters for the port.
- ❺ Set the **Delay Time to Sending** when the AS CPU is in Slave mode, after receiving communication, the time you set here indicates the time it waits before responding. For AS CPU (FW V1.08 or later), this function also works

for data exchange application. You can set the time it waits before exchanging any data. This is useful for some Slaves with slower responses in communication. **Received Data Timeout** applies when the AS Series CPU module acts as a server to send out communications. The timeout is how long the module waits before the received data times out.

- ⑥ Set COM1 LED to show: when COM1 is selected from the drop-down list, it shows the RS485 communication status of the COM1. If CARD1 is selected, it shows the CARD1 communication status.
- Set COM2 LED to show: when COM2 is selected from the drop-down list, it shows the RS485 communication status of the COM2. If CARD2 is selected, it shows the CARD2 communication status.

8.2.8 Options - Ethernet Port Basic Setting

The communication parameters can be set for the Ethernet port in the CPU module in this page. Refer to other related documents or manuals for more information about Ethernet.

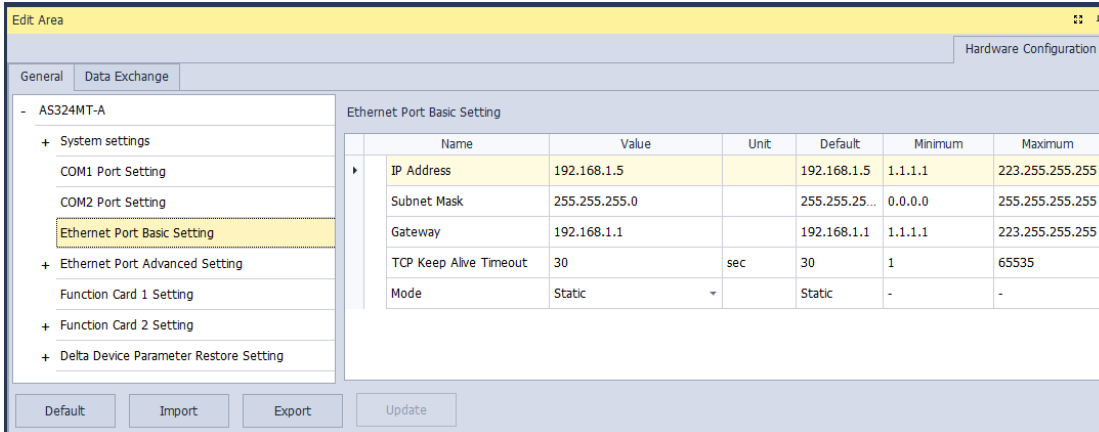

Name	Value	Unit	Default	Minimum	Maximum
IP Address	192.168.1.5		192.168.1.5	1.1.1.1	223.255.255.255
Subnet Mask	255.255.255.0		255.255.25...	0.0.0.0	255.255.255.255
Gateway	192.168.1.1		192.168.1.1	1.1.1.1	223.255.255.255
TCP Keep Alive Timeout	30	sec	30	1	65535
Mode	Static		Static	-	-

Mode sets the addressing mode of the IP of the CPU module.

If users select **Static**, they can specify an IP address directly. If **DHCP** or **BOOTP** is selected, the IP address is assigned dynamically by a DHCP/BOOTP server.

8.2.9 Ethernet Port Advance Setting – IP Filter

IP Filter sets the filter function of network devices. Devices whose IP addresses are listed in the table are allowed to communicate with the CPU module; the CPU module discards data packets sent from devices whose IP addresses are not in the table. Devices on a network are filtered. This setting ensures that objects communicating with the CPU module are known devices. You can set up to 8 address ranges for allowed devices.

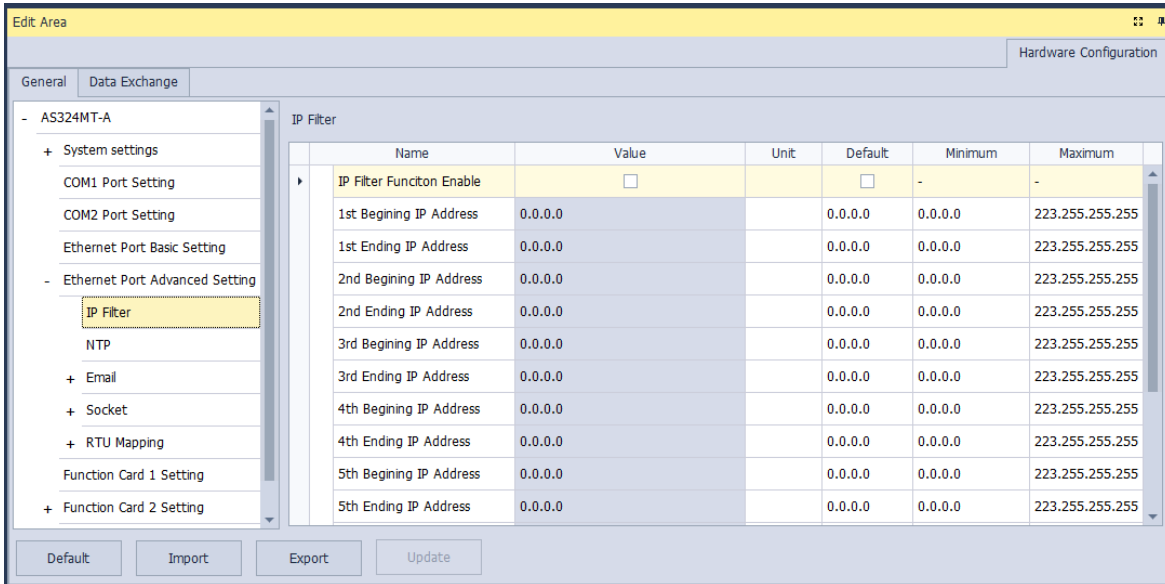

Select **IP Filter Function Enable** checkbox to enable the IP filter function and type the start address and end address of group 1~8 IP.

8.2.10 Ethernet Port Advance Setting – NTP

You can use **NTP** table to enable the CPU module and adjust time via NTP server. Relevant parameters are set here. For more information on NTP, refer to related literature and manuals.

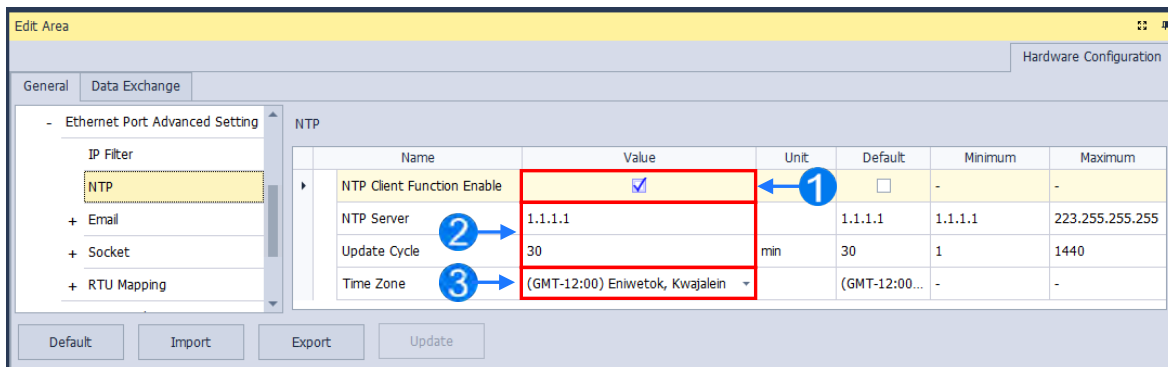

- ❶ Select **NTP Client Function Enable** checkbox to enable the function.
- ❷ Set the address of NTP server and cycle of constant update. Take the figure above as an example. The CPU module connects to the NTP server every 30 minutes.
- ❸ Set up the time zone for the daylight saving time area.

8.2.11 Ethernet Port Advance Setting – Email

Email table is for users to set the email-related functions. The email will be sent to the set email address after the email function is enabled. Total four groups of email sending conditions and four groups of email addresses can be set.

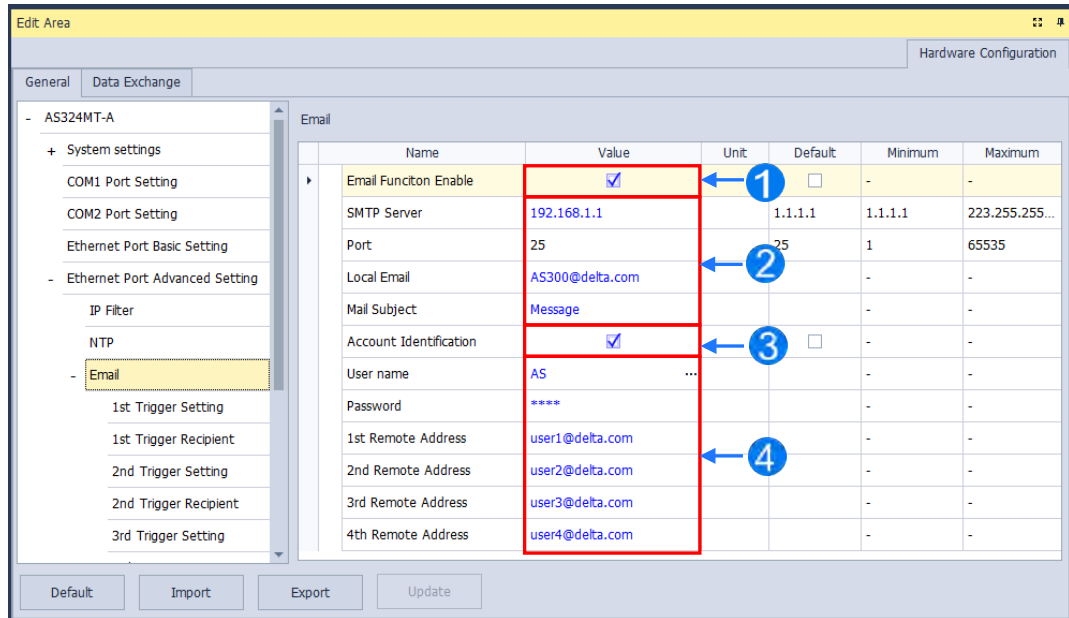

- ❶ Select **Email Function Enable** to enable the function and then start setting the following parameters.
- ❷ Set an IP address of SMTP server. Set the COM port of SMTP server at the COM port and set the sender's email box at local email address. Type a mail subject as the start of the subject of every email.
- ❸ Select **Account identification** checkbox to enable the function. Users can set to authenticate themselves with a user name and a password before logging in to an SMTP server.
- ❹ Type the target email address of a receiver.

Type a trigger name in **Trigger Name box** and a minimum interval in **Trigger Min Cycle** in the **Trigger Setting** table. And then select a trigger condition on the drop-down list. When the sending condition is met, the system will send an email every a period of time. But the same email will not be sent again within the set interval.

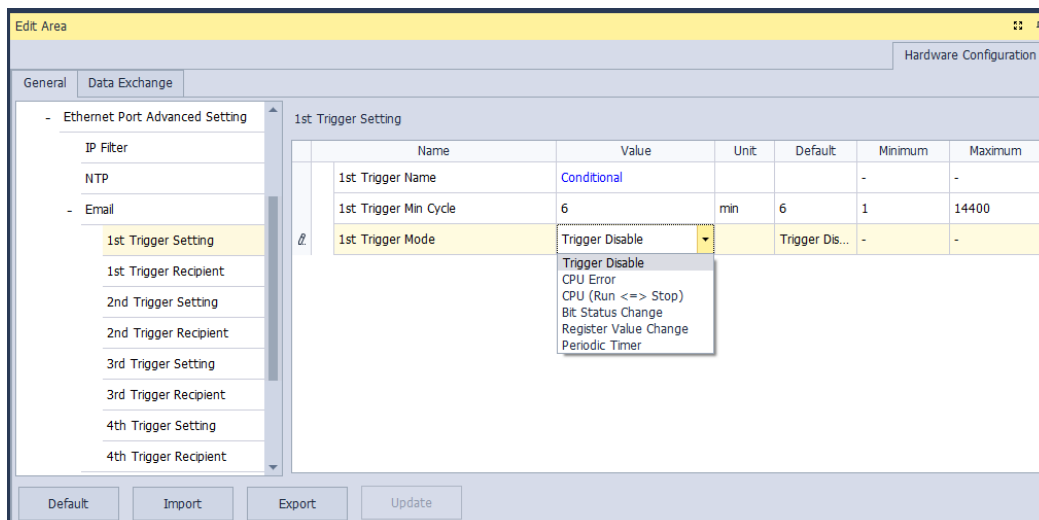

Trigger modes can be set as follows.

● **CPU Error**

If an error occurs in the CPU module, the condition of triggering the sending of an email is met. Please refer to operation manuals for more information about errors occurring in CPU modules. After users select the **CPU Error** option button, they have to select **Fatal Error Only** or **All Errors** in the drop-down list at the right side of the option button.

- a) **Fatal Error Only:** If a fatal error occurs in the CPU module, the condition of triggering the sending of an email is met and an email will be sent.
- b) **All Errors:** If an error occurs in the CPU module, the condition of triggering the sending of an email is met and an email will be sent.

● **CPU (RUN<=>STOP)**

When the CPU module begins to run, or when the CPU module stops running, the condition of triggering the sending of an email is met and an email will be sent.

● **Bit Status Change**

If the state of a bit device specified meets a condition set, the sending of an email will be triggered and an email will be sent. For example, if X0.0 is turned from OFF to ON, the condition of triggering the sending of an email will be met. If users want to set a condition, they can click  button in the following window.

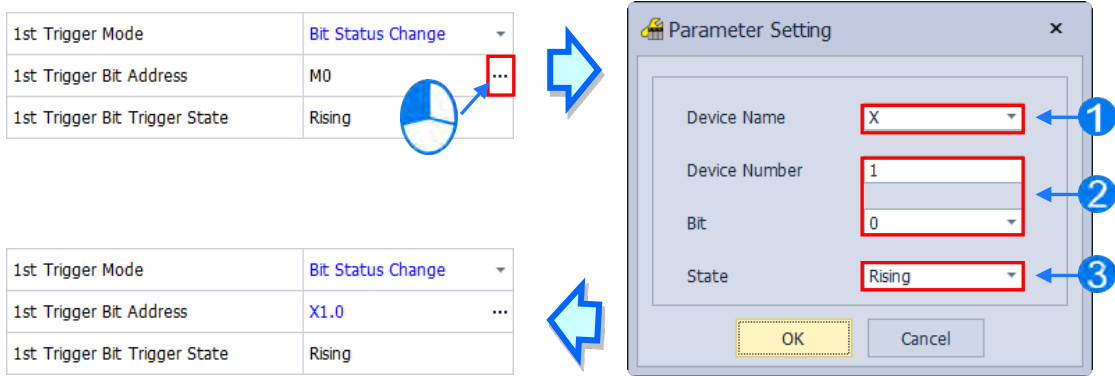

1st Trigger Mode	Bit Status Change
1st Trigger Bit Address	M0
1st Trigger Bit Trigger State	Rising

Parameter Setting

Device Name: X

Device Number: 1

Bit: 0

State: Rising

OK Cancel

1st Trigger Mode	Bit Status Change
1st Trigger Bit Address	X1.0
1st Trigger Bit Trigger State	Rising

- 1 **Device Name:** Users can select a device type in the **Device Name** drop-down list box.
- 2 **Device Number & Bit:** Users can type a device address in the **Device Number** box. If the device type selected is X/Y, the users have to specify a bit number.
- 3 **State:** Users can select **Rising** or **Falling** in the **State** drop-down list.

● **Register Value Change**

If the value in a device specified meets a set condition, the sending of an email will be triggered and an email will be sent. For example, if the value in D0 is larger than 10, the condition of triggering the sending of an email will be met and an email will be sent. If users want to set a condition, they can they can click **...** button in the following window.

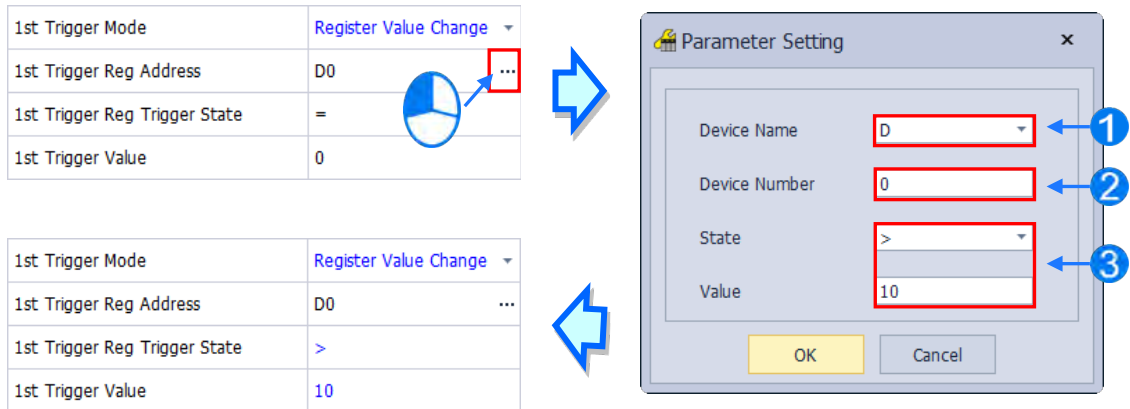

- ① **Device Name:** Users can select a device type in the **Device Name** drop-down list.
- ② **Device Number:** Users can type a device address in the **Device Number** field.
- ③ **State & Value:** Users can set s condition of triggering the sending of an email here.

● **Periodic Timer**

An email is sent periodically. How often an email is sent depends on the interval typed in the **Trigger Min Cycle** box in the **Trigger Setting** section.

Where any trigger mode is set, the user message and error log related parameters will show up.

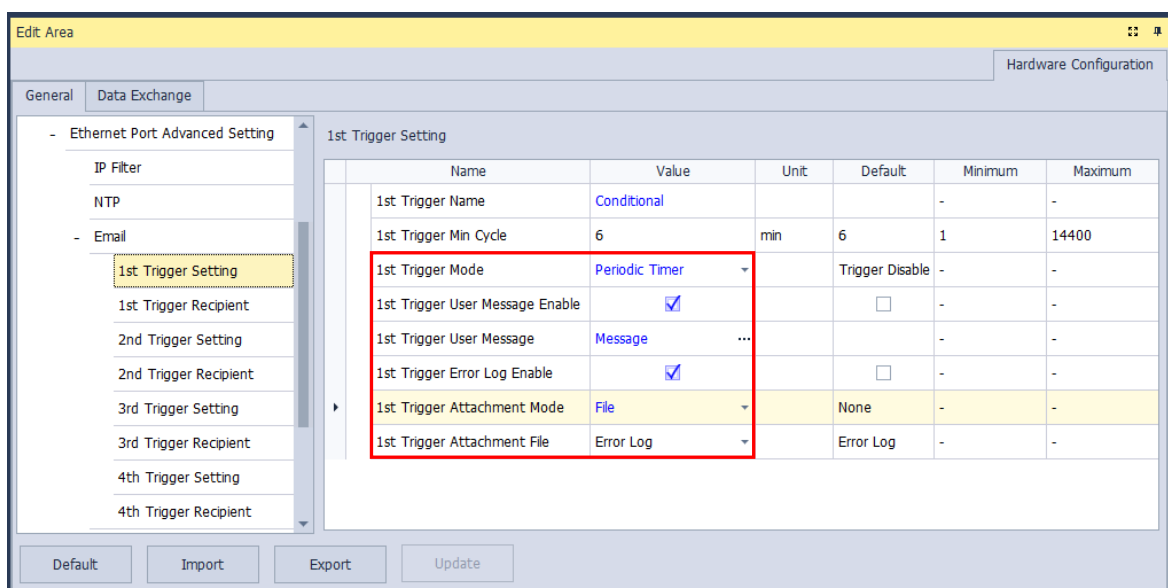

Select the **Trigger User Message Enable** box and then click **...** button to the right side of **Trigger User Message**.

Type some content as the email text in the pop-up window.

If users select the **Error Log Enable** checkbox in the **Trigger Setting** table, the error log will be added to the email content automatically.

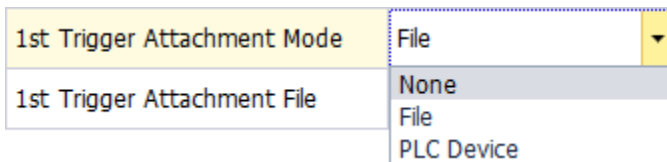

The options on the drop-down menu of **Trigger Attachment Mode** decide whether to add an attachment to the email. Please make sure the maximum size of the email file allowed before setting an attachment. For more information, refer to relevant operation manuals.

- **None**

If this option button is selected, no attachment will be inserted.

- **File**

Users can select an error log in the memory card, or the system backup file in the memory card as the attachment of the email.

- **PLC Device**

If this option button is selected, the system automatically retrieves the states of the devices, or the values in the devices listed in the table as the attachment when the email is sent. After this option button is selected, users can click **...** button in the following window to open the **Attachment** window. Two groups of devices at most can be set. For example, if the condition is met, the values in D0~D9 will be sent as an attachment.

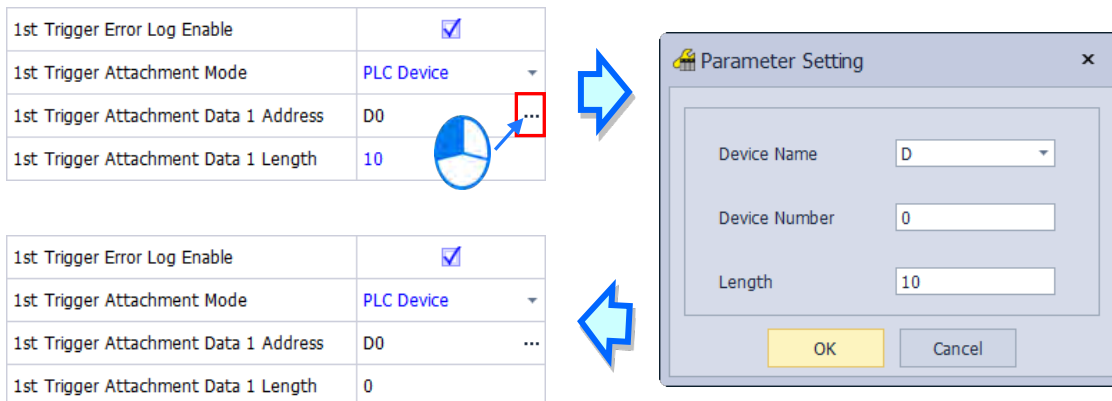

Select the target email address of a receiver when the condition of sending an email is met in **Trigger Receiving** table. And the specific email box is set in the **Email** section.

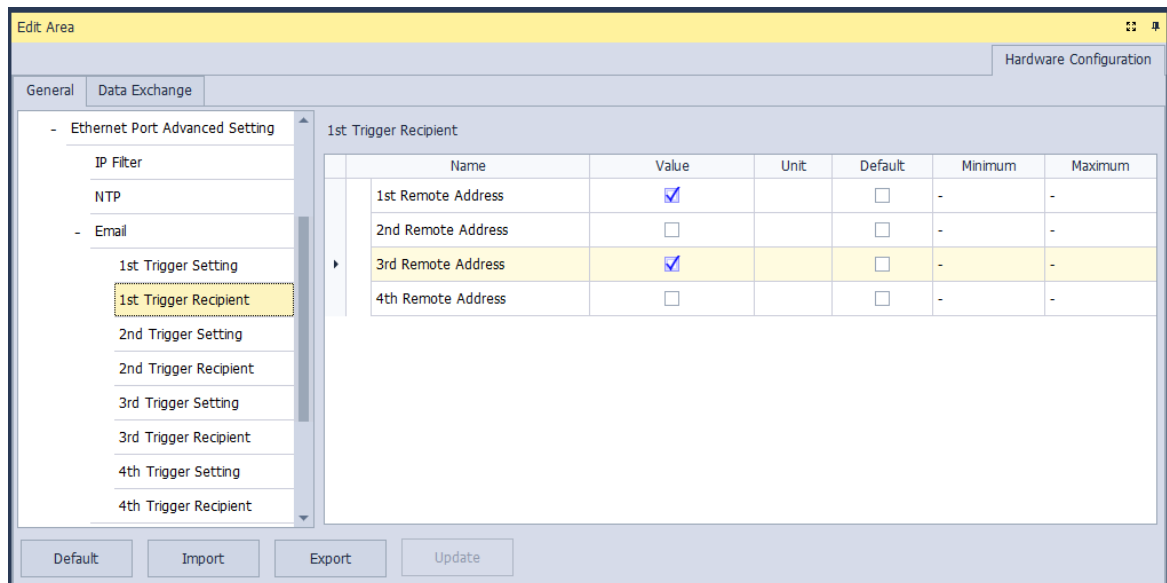

8.2.12 Ethernet Port Advance Setting – Socket

In the **Socket** table, you can set COM port parameters for data transmission through Ethernet; however, you need to use this function along with specific API instructions. For more details, refer to the AS Series Programming Manual. The AS300 Series PLC supports data transmissions between the CPU module and other CPU module or device through sockets and the communication protocols including TCP and UDP are supported; four groups of connections can be set respectively for each protocol. As for AS100 and AS200 Series PLC, two groups of connections are supported respectively.

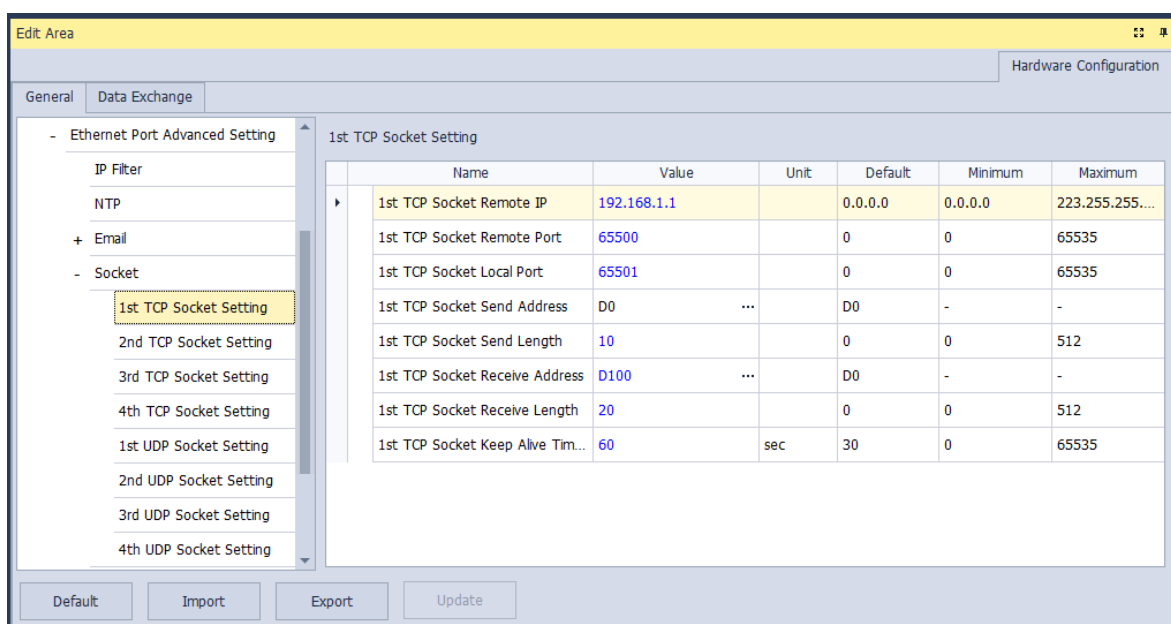

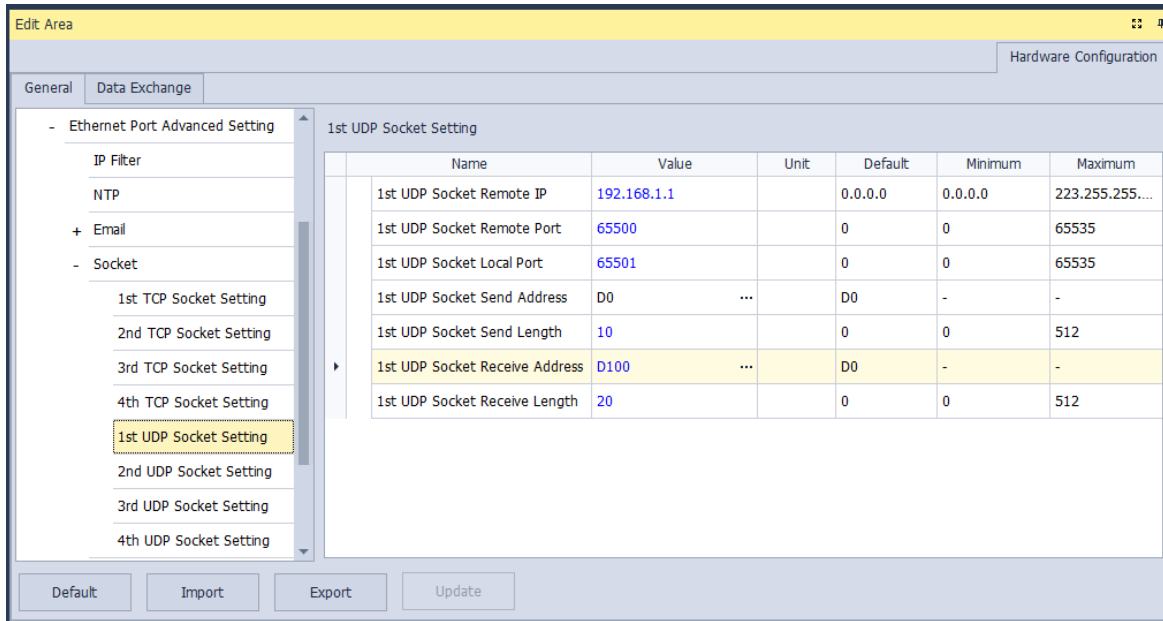

The parameters in the **TCP Socket Setting** are the same as the parameters in the **UDP Socket Setting** except that there is no **Keep Alive Timer** parameter in the UDP Socket Setting. The parameters in the TCP and UDP Socket Setting are described below.

- **Remote IP:** Users can set a remote IP address.
- **Remote Port:** Users can set a communication port used by the remote device for this TCP connection. The port number must be within the range between 0 and 65535.
- **Local Port:** Users can set a communication port used by the local CPU module for this connection. The port number must be within the range between 0 and 65535.
- **Send Address:** Users can set the initial device in the CPU module where data which will be sent is stored.
- **Send Length:** Users can set the length of data which will be sent by the local CPU module. The length must be within the range between 0 and 200 bytes. For PLC CPU with FW V1.06.20 or later, the range is between 0 and 512 bytes.
- **Receive Address:** Users can set an initial device in the CPU module where data which will be received is stored.
- **Receive Length:** Users can set the length of data which will be received by the local CPU module. The length must be within the range between 0 and 200 bytes. For PLC CPU with FW V1.06.20 or later, the range is between 0 and 512 bytes.
- **Keep Alive Timer:** Users can set a maximum keep alive time for the connection. If no data is transmitted, and the keep alive period has elapsed, the CPU module will terminate the connection automatically.

The port number used by the local CPU module and the port number used by the remote device cannot be the same, and the devices where data which will be sent is stored cannot overlap the devices where data which will be received is stored. If the IP address of the remote device is 192.168.1.100, the port number used by the remote device is 65500, and the port number used by the local CPU module is 65501, the remote device and the local CPU module can transmit data through this TCP connection.

If the local CPU module wants to send 10-word data to the remote device, the data will be stored in D0~D9 before the data is sent. If the local CPU module receives 20-word data from the remote device, the data will be stored in D100~D119.

If the length of data received is larger than the length set, the first 20-word data will be stored in D100~D119, and the data after the first 20-word data will be discarded. Likewise, if the length of data received is less than the length set, the data will be stored in the devices starting from D100, and the values in devices where no new data is stored will be retained.

If no data is transmitted, and 60 seconds have elapsed, the CPU module will close the socket, and terminate the connection.

8.2.13 Ethernet Port Advance Setting – RTU Mapping

In the **RTU Mapping** table, users can set Delta RTU-EN01 slave in connection with PLC CPU. The remote device can be controlled via Ethernet. For the setting and operation of RTU-EN01, refer to the operation manual.

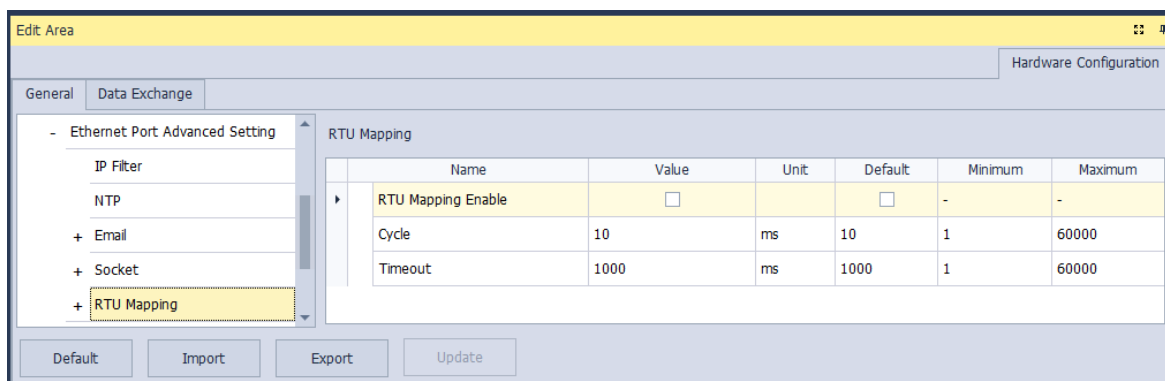

Select RTU Mapping Enable checkbox to enable the function of connection between RTU module and PLC CPU. Set the update cycle in **Cycle** box and a timeout in **Timeout** box. It means a timeout when RTU does not give a reply within the timeout set.

The data mapping between each group of RTU-EN01 and PLC CPU is set in the **RTU Mapping** section. RTU-EN01 and I/O module connected to it are set via DCISoft. For more information on DCISoft, refer to the operation manual.

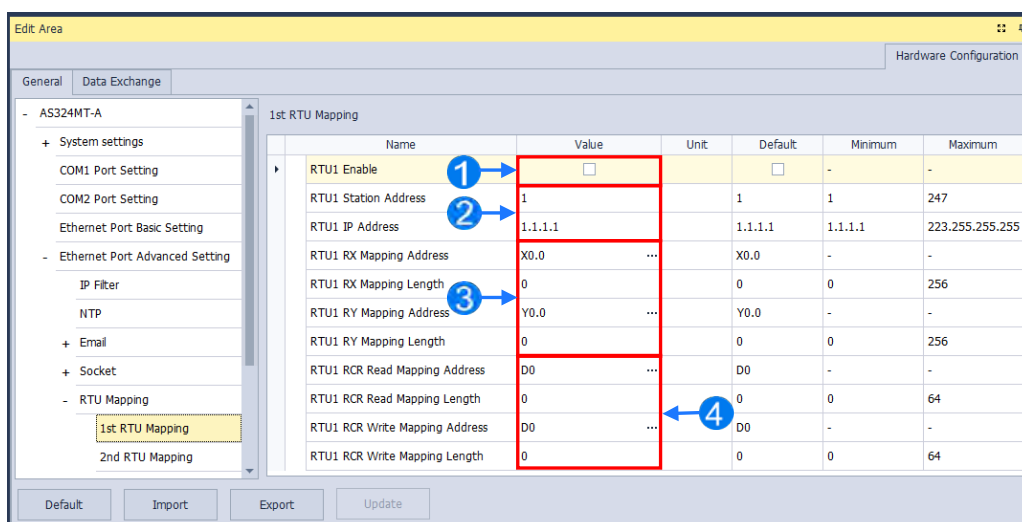

- ❶ Users can select RTU1 Enable to enable this RTU function. Each RTU can be set individually.
- ❷ Users can set a station address and IP address.
- ❸ Users can set RX mapping address and RX mapping length to make the digital input points of DI module connected to RTU mapped to X/M devices and length of PLC CPU. While, the RY mapping address and length set is used for making the digital output points of DO module mapped to Y/M devices and length of PLC CPU.
- ❹ Users can set RCR Read mapping address and RCR Read mapping length to make the analog input points of AI module connected to RTU mapped to D/SR devices and length of PLC CPU. While, the RCR Write mapping address and length set is used for making the analog output points of AO module mapped to D/SR devices and length of PLC CPU.

8.2.14 Function Card 1 Setting

The **Function Card 1 Setting** table is used for setting parameters of function card in AS300 series CPU module, which is installed by inserting to the slot. For AS100 and AS200 Series PLC CPU, there is no Function Card 1 and thus there is no settings for Function Card 1.

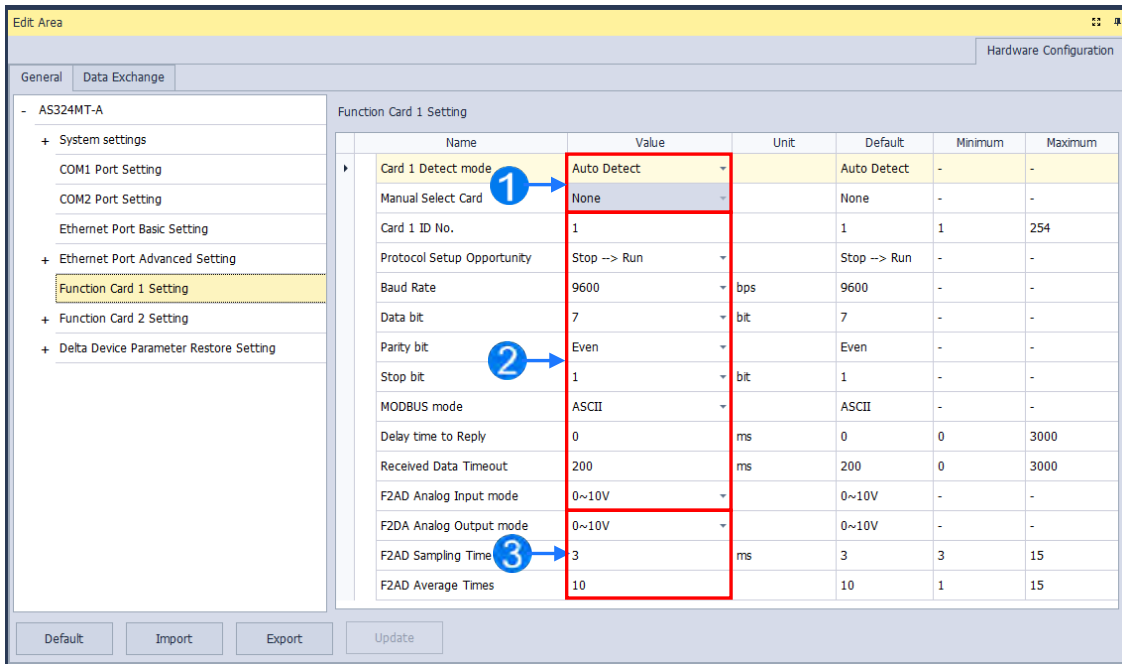

- ❶ Users can select **Auto** in **Card1 Detect mode** box to detect the actual card model and setting or **Manual** to select the AS--F232/ F422/ F485/F2AD/F2DA function card which need be configured in the **Manual Select Card** box.
- ❷ For the setting of parameters in AS--F232/ F422/ F485.
- ❸ Users can set **F2AD** to receive the signal of 0~10V or 4~20mA in **F2AD Analog Input Mode** box and set F2AD to send the signal of 0~10V or 4~20mA in **F2DA Analog Output Mode** box. The average times are set in **F2AD Sampling Time** and **Average Times** boxes respectively.

8.2.15 Function Card 2 Setting

The Function Card 2 Setting table is used for setting parameters of Function Card 2 in AS300 Series PLC CPU, which is installed by inserting to the slot. Besides settings for Function Card 2, settings for AS-FPFN02, AS-FOPC02, AS-FEN02, AS-FECAT and IP filter are also included. The only difference between Function Card 1 and Function Card 2 is the settings options of AS-FCOPM, AS-FPFN02, AS-FOPC02, AS-FEN02, AS-FECAT are added in **Manual Select Card** box for Function Card 2. For AS100 and AS200 Series PLC CPU, the AS-FCOPM is used for internal communication port and no changes can be made. If you have inserted AS-FCOPM or AS-FEN02 in AS300 Series PLC CPU, you can set up their parameters here. For AS-FCOPM card, the parameters can be set as shown in the following window.

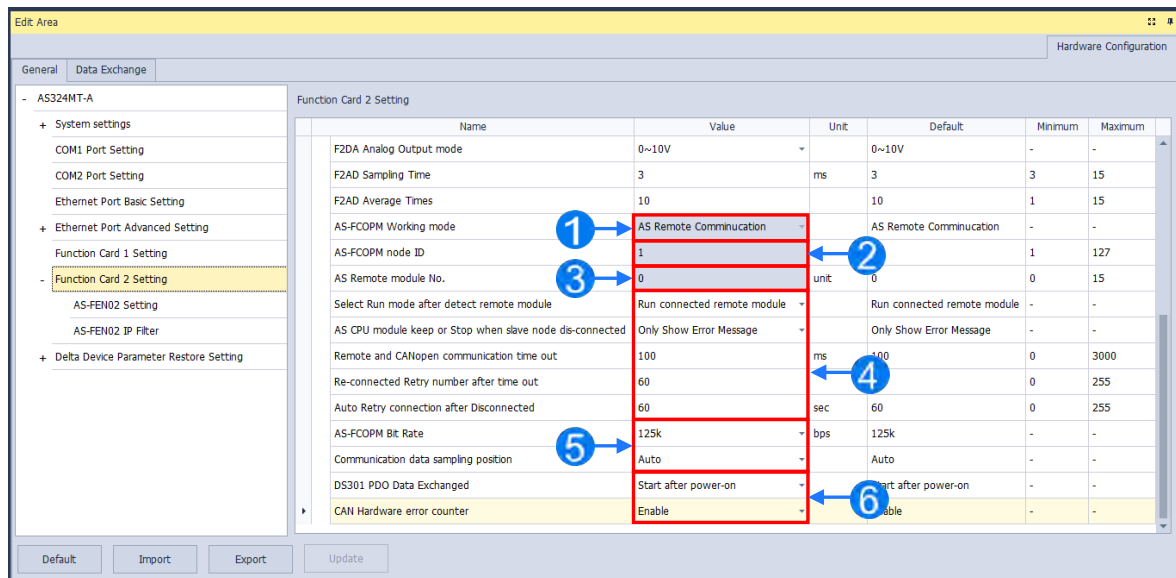

- ❶ Select AS Remote Control/Delta Servo Drives and AS Remote Module/CANopen DS301 from the **AS-FCOPM working mode** box. The AS Remote Module and Delta Servo Drives adopts communication protocols exclusive to Delta servo products and AC motor drives. In addition, the AS Remote Module and Delta Servo Drives are also applied in connecting remote I/O AS series as well as CANopen DS301 for the application of DS301 standard protocol.
- ❷ Set the address of the station when CANopen DS301 is selected from the **AS-FCOPM working mode** box.
- ❸ The remote I/O parameters can be set if AS Remote Mode is selected from the AS-FCOPM working mode box. The **AS Remote Module No.** sets the number of remote I/O modules and each one can connect one expansion module.
- ❹ If AS Remote Mode/Delta servo drives and AS Remote Mode is selected from the AS-FCOPM working mode box, you can set the followings:

The actions after detecting the remote modules in **Select run mode after detect remote module: Run connected remote module** or **All remote module stop**.

The actions when the remote I/O module is disconnected during operation in **AS CPU module keep or Stop when slave node dis-connected: only Shows Error Message** or **PLC Stop & Show Error Message**.

You can define after how long the remote I/O module does not give a reply can be seen as timeout in **Remote**

and CANopen Communication Timeout.

You can define the times of trying to connect after a timeout occurs in **Auto Retry connection after Disconnected.**

- ⑤ All three AS-FCOPM working modes can set the **AS-FCOPM Bit Rate.**

Communication data sampling position: It is suggested to select **Auto**, but if the communication with the slave is unstable, you can select the data sampling position in percentage.

- ⑥ When CANopen DS301 protocol is selected from the AS-FCOPM working mode box, you can set **DS301 PDO Data Exchanged: Start after power-on** or **Start after CPU running**

Insert AS-PPFN02, AS-FOPC02, AS-FEN02, or AS-FECAT by clicking the function card slot 2 and selecting the inserted function card, as the image shown below.

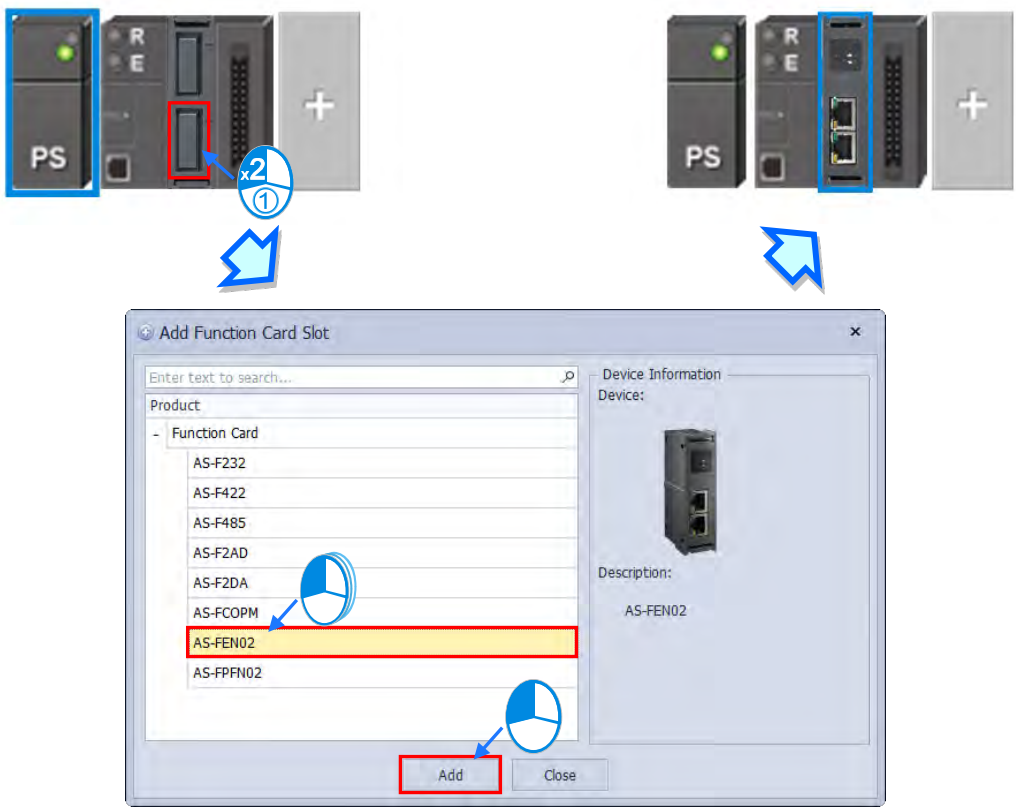

You can also set AS-FPFN02, AS-FOPC02, AS-FEN02, or AS-FECAT in the Edit Area. Set AS-FPFN02, AS-FOPC02, AS-FEN02, or AS-FECAT 2 as **Manual Select Card** (Note: If AS-FPFN02, AS-FOPC02, AS-FEN02, or AS-FECAT is selected from **Manual Select Card**, then Function Card 1 cannot be set.) After that you can set up Ethernet communication parameters.

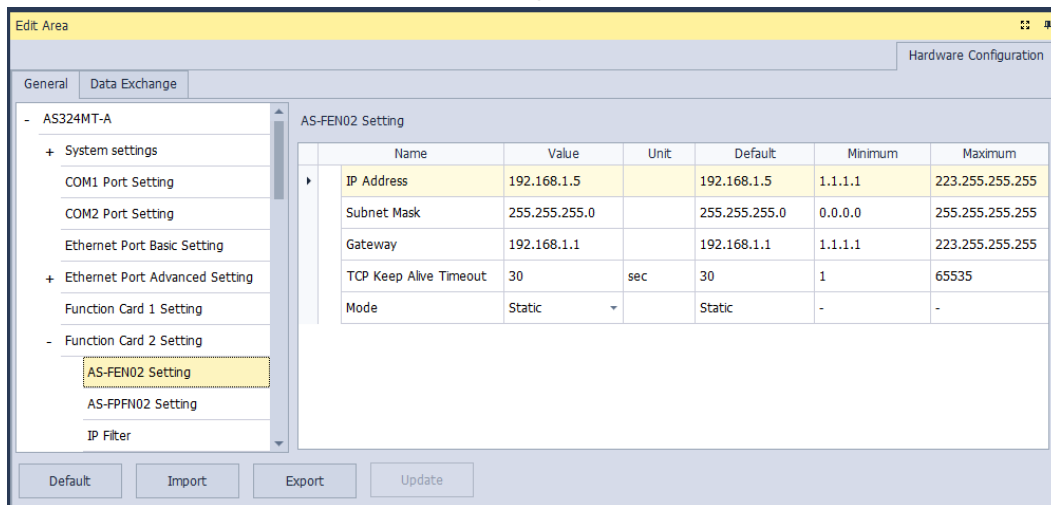
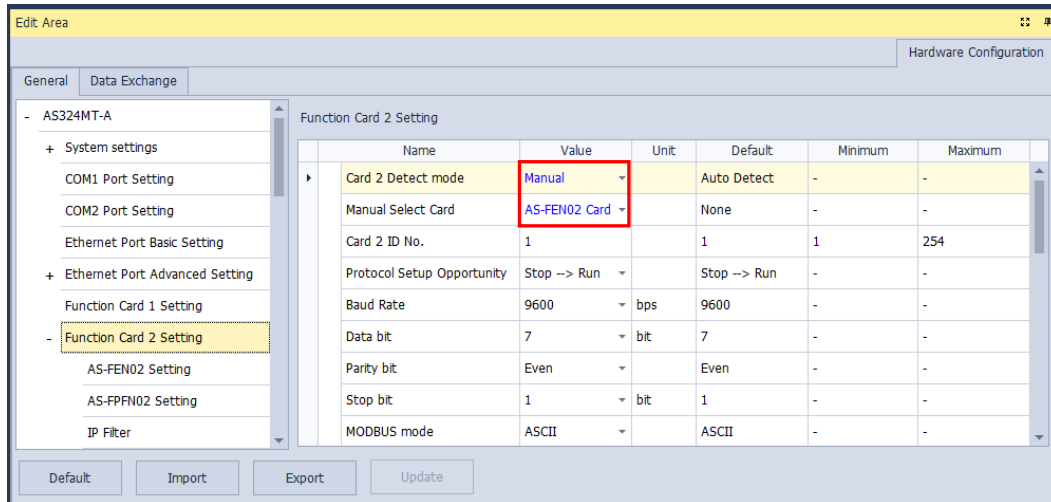

The IP filter adds another layer of confirmation to ensure the devices for communication are permitted. This function can also limit communication objects. When IP filter function enables, only the devices within the listed IP address from the IP filter table are allowed to communicate with AS-FPFN02, AS-FOPC02, AS-FEN02, or AS-FECAT. By selecting **IP Filter Function Enable**, users can input the beginning and ending of 1-8 set of IP address.

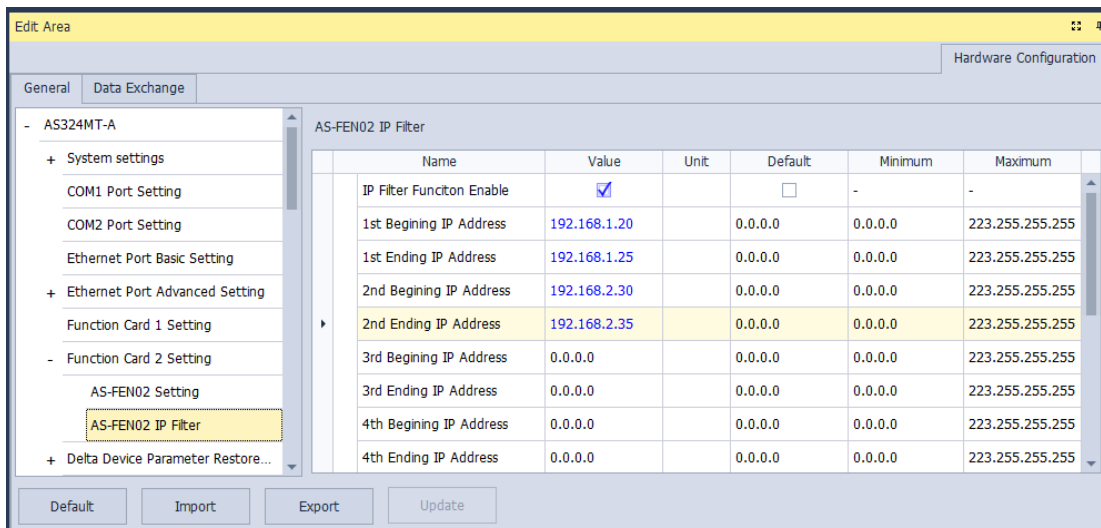

When AS-FECAT is installed on AS300 Series PLC CPU, you can use the INITEC instruction (API2820) to initialize EtherCAT communication and then set up one of the AS-FECAT port as the EtherCAT Master's port in HWCONFIG. As for the other port, it can be used by Server of Modbus TCP. Two ports work independently. If the EtherCAT communication is NOT initialized, the two ports of AS-FECAT can be used by Servers of Modbus TCP.

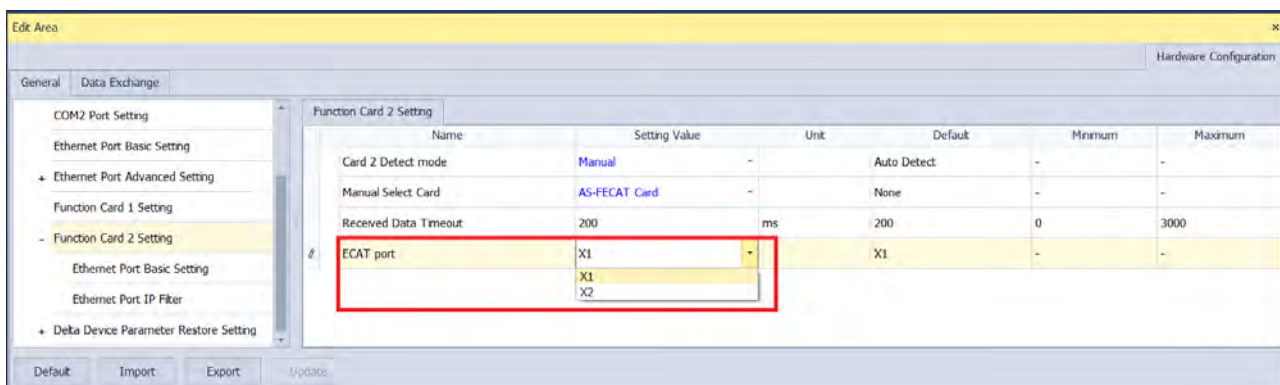

8.2.16 Data Exchange

AS Series PLC CPU is equipped with the data exchange function through standard Modbus TCP. You can find the relevant settings under the Data Exchange tab.

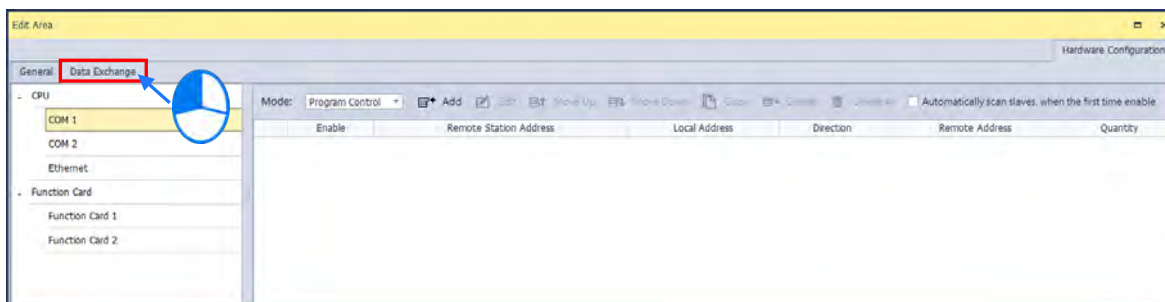

AS Series PLC CPU is built with two ports, two COM ports or one COM port and one Ethernet port varied by different models. When acted as a Master and performs data exchange with a remote Slave, the data exchange through

COM1 and COM2 is via the Modbus protocol; if the data exchange through Ethernet is via the Modbus TCP protocol. The setting items for COM1, COM2 and Ethernet are the same.

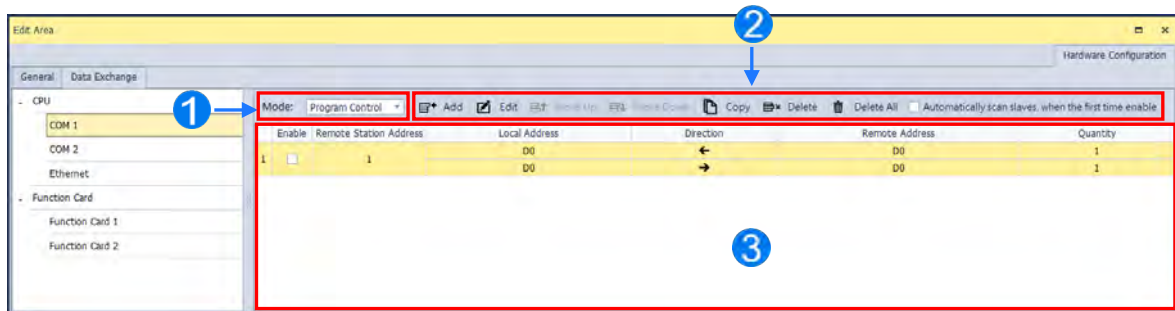



❶ You can set the three Modes to start data exchange.

A. Program Control: PLC decides whether or not to execute the set flags for data exchange. Refer to special flags (SM) descriptions for more details in AS Series Programming Manual.

B. PLC Run: The set data exchange will be executed automatically when PLC is in RUN state. If the PLC is in STOP state, the communication will stop.



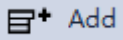
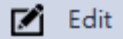
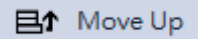
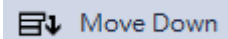
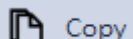

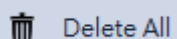
C. Always Enable: The data exchange will be executed constantly after PLC is powered on.

❷ Function buttons and descriptions:

Function Button	Description
 Add	Click Add to add a new data exchange item in area ❶.
 Edit	Click Edit to enter the selected data exchange setting page.
 Move Up  Move Down	Select the data exchange item and click Move Up and Move Down to rearrange the order of data exchange table.
 Copy	Select the data exchange item and click Copy and the copied item will be pasted to the last row of the data exchange table.
 Delete	Select the data exchange item and click Delete to delete the selected item.
 Delete All	Click Delete All to delete all data exchange items presented.
<input checked="" type="checkbox"/> Automatically scan slaves, when the first time enable	Select this option to detect if the assigned slaves of the data exchange table exist. If the slave does NOT exist, the connection to the slave will stop to increase efficiency. Note: It is suitable for applications that the time it takes

Function Button	Description
	for the slaves to power-on is less than the master does. If not, do not select this option.

⑨ Items on the data exchange table:

Name	Description
Item	The number of the block for data exchange.
Enable	Selects whether to enable the data exchange table when the data exchange is performed.
Station Address/ IP Address	The slave station address for the data exchange table. You can set one address for multiple data exchange tables. It is a station address under the COM1 and COM2 tabs, and an IP under the Ethernet tab.
Local Address	The device address range used by the master in the data exchange table
 	 : Input: the data block where the master reads from a slave  : Output: the data block where the master writes to a slave
Remote Address	This is the device address range used by a slave in the data exchange table. The device range is in hexadecimal if the slave in the data exchange table is a user-defined Modbus Device.
Quantity	This is the size of the data exchange table, which is consistent with the result calculated from the device range.

Data Exchange Setting Page

Under the Data Exchange Tab, you can set up data exchange for COM communication, Ethernet communication and Function Card. Click **Add** and then **Edit** or double-click the data exchange table to open the editing page.

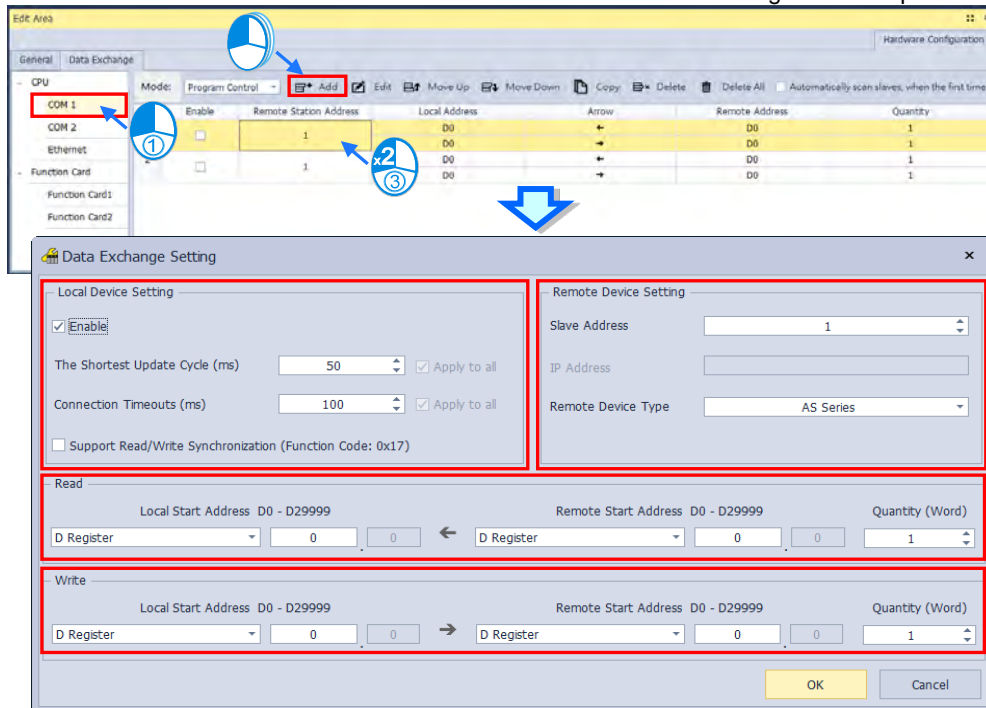

● Local Device Setting

Select the option **Enable** for data exchange to start. You can set the shortest update cycle and connection timeout time in ms. If there is no response from the target device for a period of time that you have set, that is considered as a timeout. If you select the option **Support Read/Write Synchronization (Function Code: 0x17)**, the master PLC CPU can use Modbus function code to complete read and write synchronization at one execution. However you need to make sure all the devices support Modbus function codes; otherwise, the slaves devices may NOT recognize the function code and fail to complete read/write synchronization.

● Remote Device Setting

Slave Address: station number of the slave device for data exchange

IP Address: IP address of the slave device (only available for EtherNet)

Remote Device Type: slave device model type, such as Delta PLC or standard Modbus devices

● **Read:** When PLC CPU reads data from the remote device: PLC CPU defines a device range to store data including the device type, starting address and quantity which are read from the remote device. Define the device type, starting address and quantity in the remote device that will be read by PLC CPU.

Local Start Address: Device type and start address of devices where PLC CPU store data

Remote Start Address: Device type and start address of the remote device to be read

Quantity: Data length of input

● **Write:** PLC CPU writes data to a remote device; PLC CPU defines a device range for the remote device to read the following data, the device type, starting address and quantity. Define the device type, starting address and quantity in the remote device that will be written by the PLC CPU.

Local Start Address: Device type and start address of the source data of PLC CPU

Remote Start Address: Device type and start address of the remote device where data are to be written

Quantity: Data length of output

MEMO

Chapter 9. EtherNet/IP Specification and Operation

Table of Contents

9.1	Introduction	9-3
9.1.1	Section Overview	9-3
9.1.2	EtherNet/IP	9-3
9.1.3	Definitions of Common Network Terms	9-3
9.1.4	Ethernet Features	9-4
9.2	Installation	9-6
9.2.1	EtherNet/IP Device	9-6
9.2.2	Network Cable Installation	9-6
9.2.3	Network Communication Parameter Setting	9-9
9.3	Specifications	9-10
9.3.1	Ethernet Specification	9-10
9.3.2	EtherNet/IP Specification	9-12
9.3.3	PROFINET Specification	9-14
9.3.4	EtherNet Communication Port	9-15
9.4	EtherNet/IP Software	9-16
9.4.1	Run HWCONFIG via an Ethernet/IP Scanner	9-16
9.4.2	Set up the IP Address	9-19
9.4.3	Network	9-24
9.4.4	Add New Devices	9-27
9.4.5	Data Exchange – Implicit Message	9-32
9.4.6	EtherNet/IP Tags	9-43
9.4.7	Diagnosis	9-47
9.5	Explicit Message	9-49
9.6	Troubleshooting.....	9-49
9.6.1	Error Code Classification	9-49
9.6.2	Error Codes & How to fix them	9-50

9.6.3 AS-PPFN02 Error Codes & How to fix them	9-53
9.7 Software Operation	9-54
9.7.1 Operation Demonstration I	9-54
9.7.2 Operation Demonstration II	9-57
9.8 CIP Object	9-69
9.8.1 Object List	9-69
9.8.2 Data Type	9-71
9.8.3 Identity Object (Class ID: 01 Hex)	9-74
9.8.4 Message Router Object (Class ID: 02 Hex)	9-77
9.8.5 Assembly Object (Class ID: 04 Hex)	9-78
9.8.6 Connection Manager Object (Class ID: 06 Hex)	9-82
9.8.7 Port Object (Class ID: F4 Hex)	9-84
9.8.8 TCP/IP Interface Object (Class ID: F5 Hex)	9-86
9.8.9 Ethernet Link Object (Class ID: F6 Hex)	9-90
9.8.10 X Register (Class ID: 350 Hex)	9-93
9.8.11 Y Register (Class ID: 351 Hex)	9-94
9.8.12 D Register (Class ID: 352 Hex)	9-95
9.8.13 M Register (Class ID: 353 Hex)	9-96
9.8.14 S Register (Class ID: 354 Hex)	9-97
9.8.15 T Register (Class ID: 355 Hex)	9-98
9.8.16 C Register (Class ID: 356 Hex)	9-99
9.8.17 HC Register (Class ID: 357 Hex)	9-100
9.8.18 SM Register (Class ID: 358 Hex)	9-101
9.8.19 SR Register (Class ID: 359 Hex)	9-102
9.9 Delta EIP Product List	9-103
9.9.1 Delta EIP Products	9-103
9.9.2 Delta EIP Products, DLR (Device Level Ring) supported	9-103
9.9.3 Delta EIP Products, Scanner supported	9-104
9.10 Network Security	9-104
9.11 Operation and Monitor on the Web	9-105
9.11.1 Getting Started	9-105
9.11.2 Device Information	9-109
9.11.3 Network configuration	9-110
9.11.4 Data Monitoring	9-113
9.11.5 Diagnostic	9-118
9.11.6 Configurations	9-120

9.1 Introduction

9.1.1 Section Overview

This section uses ISPSOft for demonstration. For DIADesigner operation, refer to Chapter 7 from DIADesigner software manual.

This section introduces Ethernet communication. Section 9.2 is about Ethernet network installation. Section 9.3 is about the specifications of Ethernet and EtherNet/IP. Section 9.4 to section 9.9 are for EtherNet/IP specification and operations. Section 9.11 is about operations and monitoring from the webpage.

9.1.2 EtherNet/IP

EtherNet/IP (“IP” stands for “Industrial Protocol”) is an industrial Ethernet network managed by ODVA, Inc. (formerly Open DeviceNet Vendors Association, Inc.), a global trade and standards development organization.

EtherNet/IP works on a TCP/UDP/IP based Ethernet network and uses the most widely deployed collections of Ethernet standards to provide a broad range of applications in different industries that require high-speed and stability including Factory Automation (FA), Building Automation (BA), Process Automation (PA) and many more.

Delta covers a full range of controller and drive products supported by EtherNet/IP, including Programmable Logic Controllers (PLC), inverters, Human Machine Interfaces (HMI) and so on. Refer to Section 9.9 for a full product list that support EtherNet/IP. In addition, you can also use EDS files to connect to other brands of EtherNet/IP devices. Find HWCONFIG in ISPSOft software to edit EtherNet/IP devices. Download the ISPSOft software at: [Delta | Download Center \(deltawww.com\)](http://Delta | Download Center (deltawww.com))

9.1.3 Definitions of Common Network Terms

Term	Definition
ODVA	Open DeviceNet Vendor Association for EtherNet/IP
EIP	EtherNet/IP, an industrial Ethernet network, provides interoperability for system providers. IP stands for Industrial Protocol. The term “EIP” (EtherNet/IP) is used in this manual.
I/O Connection	Use the I/O connection to connect to EtherNet/IP and to exchange data cyclically.
Explicit Message	Connect to EtherNet/IP and to exchange data non-cyclically. Data is exchanged piece by piece through instructions.
RPI	Requested Packet Interval, through the I/O connection to connect to EtherNet/IP to exchange data at regular time intervals.
ACD	Address Conflict Detection to detect IP address duplications.
Produced/Consumed Tag (P/C Tag)	<ul style="list-style-type: none"> ● You use Tags for assigning and referencing memory locations for Rockwell PLCs, the same as registers for Delta PLCs. ● Produced tag: A tag that a controller makes available for other controllers. Multiple controllers can simultaneously consume (receive) the data. A produced tag sends its data to consumed tags (consumers) without using logic. ● Consumed Tag: A tag that receives the data of a produced tag. The data type of the consumed tag and the produced tag must match (including any array dimensions). ● The data is transferred over Ethernet/IP. For example, PLC-A needs data from

	PLC-B, so PLC-B sends the data to PLC-A. Therefore, PLC-B is the producer and PLC-A is the consumer.
EDS	Electronic Data Sheets: EDS files are simple text files used by EtherNet/IP network configuration tools to help you identify EtherNet/IP products and easily commission them on a network.
Data Exchange	Exchanging data between devices
EIP Scanner	The master station is called an EIP Scanner in EtherNet/IP.
EIP Adapter	The slave station is called an EIP Adapter in EtherNet/IP.
DLR	Device Level Ring (DLR) provides fault-tolerant network design for daisy-chain and linear topology. The DLR protocol provides high network availability in a ring topology. It was intended primarily for implementation in EtherNet/IP end-devices that have two Ethernet ports and embedded switch technology, providing fast network fault detection and reconfiguration to support the most demanding control applications.
Modbus TCP	This is a Modbus variant used for communications over TCP/IP networks.

9.1.4 Ethernet Features

9.1.4.1 Delta EIP Architecture

This typical Delta EIP architecture includes an EIP Scanner and Adapters; data exchange is achieved between devices through an I/O connection and explicit messaging. The AS Series supports single port Ethernet; thus you can install and configure devices with embedded switch technology over EtherNet/IP.

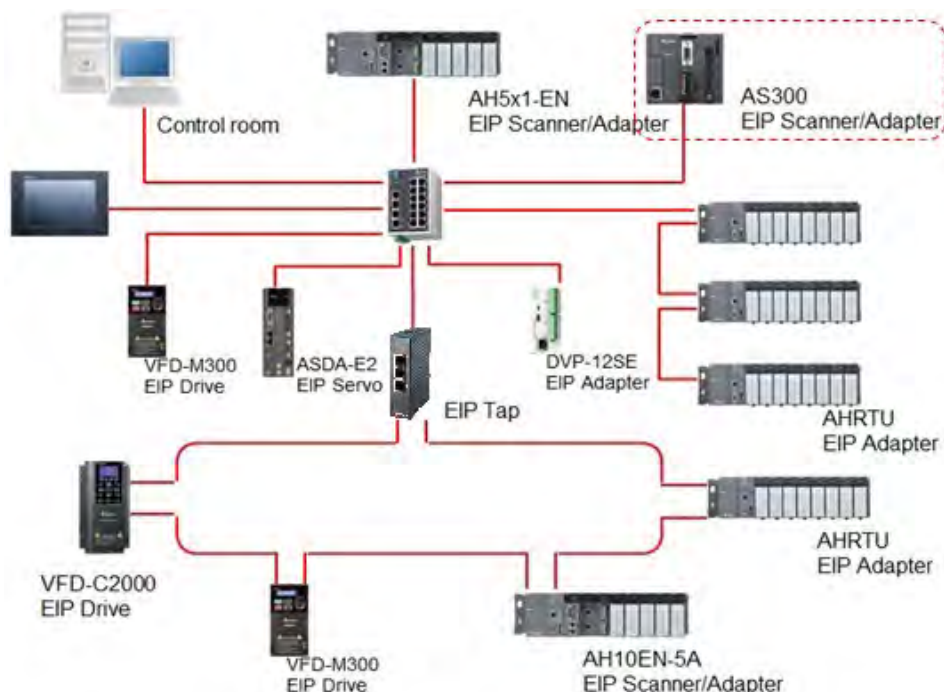

9.1.4.2 EIP Features

- **Flexibility**

- Flexible topology: EIP devices may include single port Ethernet as well as dual port Ethernet, and provide applicable networks such as linear topology, ring topology and ring topology for faster expansion and easier management.
- EtherNet/IP works on a TCP/UDP/IP based Ethernet network, uses most widely deployed collections of Ethernet standards, and supports Wi-fi connection. Even personnel with no IT background can build the network easily.
- Applicable networks include linear topology, ring topology, star topology, Ethernet, EtherNet/IP, one or more LANs, etc. You can set configuration through USB or an interface.

- **Simplicity**

- With a connector: Delta provides a full range of products, including human machine interfaces (HMI), programmable logic controllers (PLC), and inverter drives for application in an industrial operation. You can build a network simply through an RJ-45 connector, saving costs on cables and other connecting tools.
- Single network: in place of the 3-tier industrial architecture, single network architecture provides 100MB/bits high-speed cyclical and non-cyclical data exchange functions, ensuring complete network diagnosis and effectively shortening debugging time.
- Graphical user interface software: the HWCONFIG uses a graphical user interface designed for intuitive operation.

- **Integration**

- Data exchange: the HWCONFIG provides a consistent setting interface, allowing you to reduce the time to learn and set up configurations.
- Listed device parameters: the HWCONFIG presents the device parameters in a list. Instead of looking them up in the user manual, you can quickly check on the parameters in the list.
- EDS file: you can connect to Delta and other brands of EtherNet/IP products with EDS files.

9.2 Installation

9.2.1 EtherNet/IP Device

A Delta EtherNet/IP (EIP) device allows you to build a linear topology, ring topology, and star topology networks. A Delta EIP device includes the EIP Builder software, EIP Scanner, EIP Adapter, EIP Tap, and an Ethernet switch. EIP Scanners and EIP Adapters can be further divided into single port and dual port devices. The AS Series are single port devices. Refer to Section 9.2.2.1 for the single port setup and refer to Section 9.2.2.3 for the software installation.

9.2.2 Network Cable Installation

Each EtherNet/IP device is connected to an Ethernet switch with a CAT 5e cable. Please use Delta standard cables and the DVS series industrial switches. Refer to the Delta PLC/HMI Cable Selection Guide for more information.

9.2.2.1. Single Port Device

You can use a single port device to build up either a linear or a star network topology. An Ethernet switch and an Ethernet tap are required to create a star topology or a ring topology.

Linear Topology

- Linear Topology 1

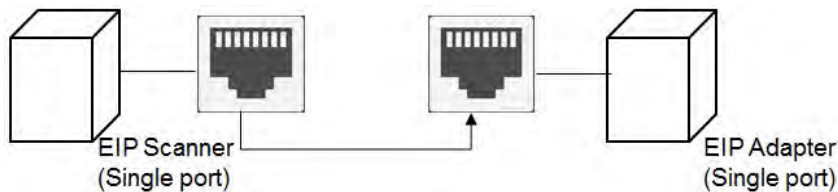

- Linear Topology 2

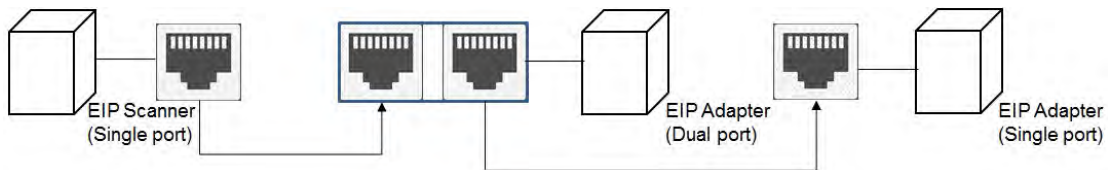

Star Topology

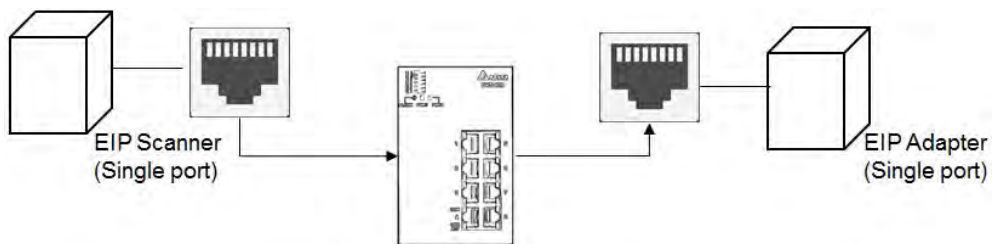

9.2.2.2. Dual Port Device

You can use a dual port device to build a linear, a star or a ring network topology. A DLR function is required to create a ring topology. Refer to Section 9.9.2 for DLR supported series.

Linear Topology

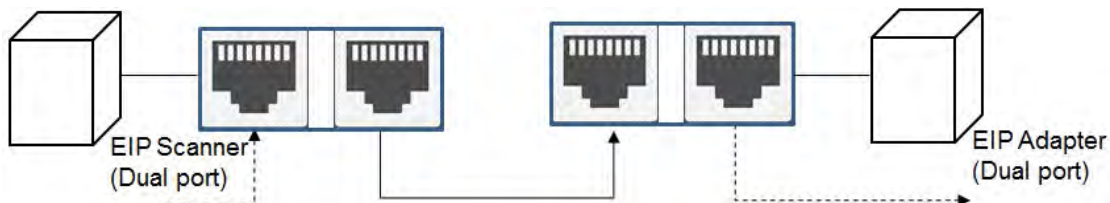

Star Topology

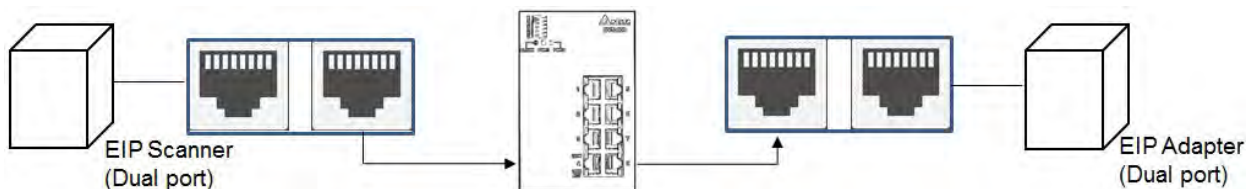

Ring Topology

A DLR function is required to create a ring topology. Refer to Section 9.9.2 for DLR supported devices.

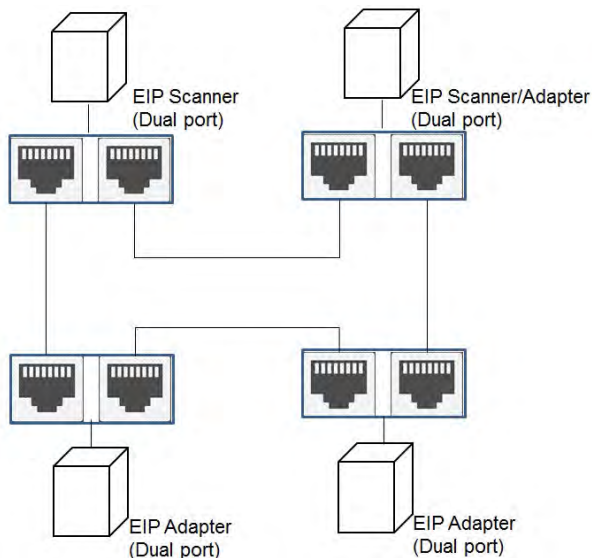

When a switch is needed for the particular topology, the switch should support the DLR function. If not, the connection might fail. Since AS Series PLC CPU does NOT support DLR function, you will need a DLR switch DVS-103I02C-DLR for a ring topology.

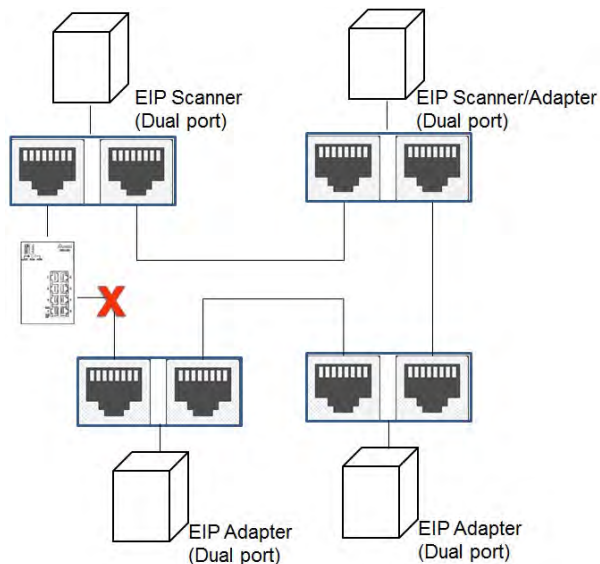

9.2.2.3 EIP Builder Software

Linear and star topology

Firstly install the EIP editing software on your PC to monitor and configure the EIP devices and use a switch to connect to the EIP Scanner and EIP Adapter.

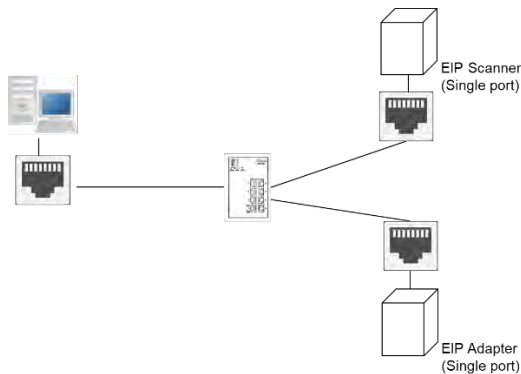

If there is a duo port on the EIP Adapter, you can also take this advantage to start a Daisy-chain topology.

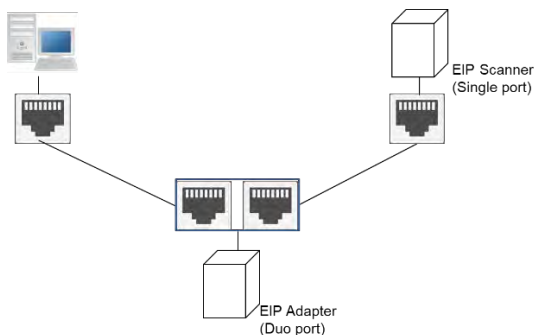

Ring topology

Install the EIP editing software on your PC to monitor and configure the EIP devices. If there is no DLR switch (DVS-103I02C-DLR), you need to save a network connection for your PC to connect to the EIP device.

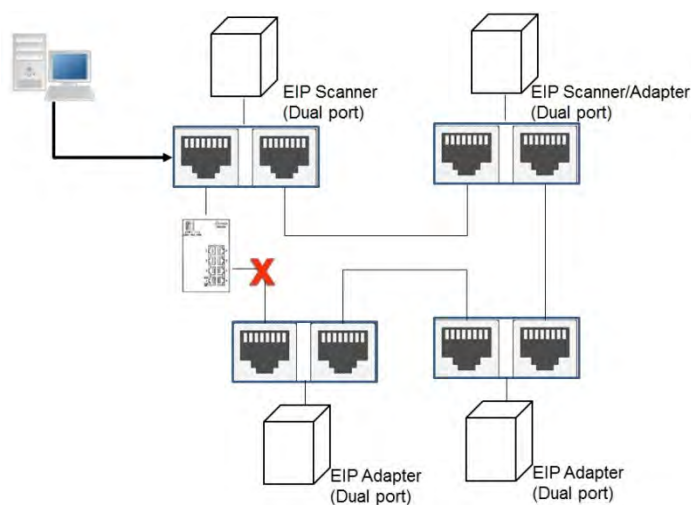

If you have a DLR switch (DVS-103I02C-DLR), you can connect your PC to the Device port of the switch so that the ring topology stays intact.

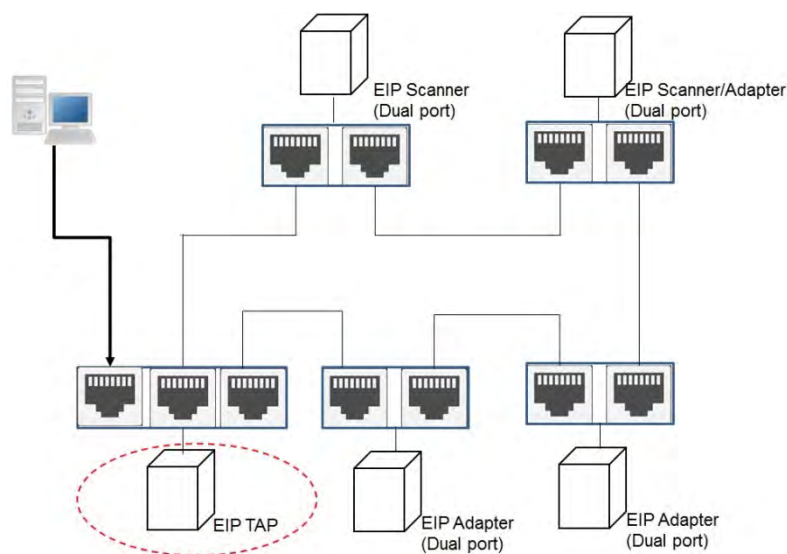

9.2.3 Network Communication Parameter Setting

In ISPSOft you can edit, upload, download and monitor AS PLC CPU programs through Ethernet communication. Refer to section 2.4.3.4 in ISPSOft User Manual for more details. Go to *ISPSOft -> Help -> ISPSOft User Index* and then find section concerning **Communication Parameter Setting – Ethernet** for more details.

9.3 Specifications

9.3.1 Ethernet Specification

Model	AS300 & AS200 & AS100 Series
Communication Protocols	EtherNet/IP Scanner / Adapter, Modbus TCP
Protocols	BOOTP, DHCP, SMTP, NTP, Socket, HTTP
Communication Speed	10/100 Mbps Auto-Detection
Communication Interface	RJ-45 with Auto MDI/MDIX
Numbers of the Ethernet Port	1

Model	AS-FEN02 (work with AS300 Series)
Communication Protocols	EtherNet/IP Scanner / Adapter, Modbus TCP
Protocols	BOOTP, DHCP, SMTP, NTP, Socket, HTTP
Communication Speed	10/100 Mbps Auto-Detection
Communication Interface	RJ-45 with Auto MDI/MDIX
Numbers of the Ethernet Port	2

Model	AS-FPFN02 (work with AS300 Series)
Communication Protocols	PROFINET RT
Protocols	PROFINET IO
Communication Speed	100 Mbps Auto-Detection
Communication Interface	RJ-45 with Auto MDI/MDIX
Numbers of the Ethernet Port	2

Model	AS-FECAT (work with AS300 Series)
Communication Protocols	EtherCAT Master, Modbus TCP
Protocols	BOOTP, DHCP, HTTP
Communication Speed	10/100 Mbps Auto-Detection
Communication Interface	RJ-45 with Auto MDI/MDIX
Numbers of the Ethernet Port	2

Item / per transmission		Specification			
		AS300	AS200 / AS100	AS-FEN02	AS-FECAT
Modbus TCP	Maximum connection quantity for Client *1	32	16	8	0
	Maximum connection quantity for Server*1	32	16	8	1
	Max. data length	100 words			
Socket (communication port)*1	TCP connection quantity	4	2	N/A	N/A
	UDP connection quantity				
	Max. data length	200 bytes			
SMTP (for emailing)	Emailing quantity	4	4		

*1: Numbering is used for connections via the communication port. You can use connection 1 in TCP mode or UDP mode and up to 4 connections can be made per transmission. If connection 1 is used in TCP mode, the same connection number cannot be used in UDP mode.

9.3.2 EtherNet/IP Specification

Item		AS300		AS200 / AS100		AS-FEN02
		Scanner	Adapter	Scanner	Adapter	Adapter
General	Device type	Scanner / Adapter				Adapter
	Topology type	Star topology				Star, linear topologies
CIP Network I/O Connection	CIP connection number (data exchange)	32	8	16	8	8
	TCP connection number	16 (Clients + Servers)		8 (Clients + Servers)		8
	Requested Packet Interval (RPI)	5 ms – 1000 ms				1 ms – 1000 ms
	Max. Transmission Speed	3,000 pps				10,000 pps
	Max. Data Length/per transmission	500 bytes				200 bytes
	Supported devices, registers, and flags	FMV1.08 or previous versions: D FW V1.10 or later: D/M*	D, X, Y, SR	FMV1.08 or previous versions: D FW V1.10 or later: D/M*	D, X, Y, SR	D, X, Y, SR
CIP Network Explicit Message	Class 3 (Connected Type)	16	8	8	8	8
	UCMM (Non-Connected Type, only uses TCP connections)	Total 16 (for all connection types)		Total 8 (for all connection types)		Total 8 (for all connection types)
	CIP Objects	Identity Object (16#01) Message Router Object (16#02) Assembly Object (16#04) Connection Manager Object (16#06) Port Object (16#F4) TCP/IP Interface Object (16#F5)				

Item	AS300		AS200 / AS100		AS-FEN02
	Scanner	Adapter	Scanner	Adapter	Adapter
	Ethernet Link Object (16#F6)				
CIP Network Tag	Max. Consumed Tag Number	32	16		N/A
	Max. Produced Tag Number	32	16		
	Max. Data Length	500 bytes (IO Connection) 400 bytes (Explicit Message)**			
	Requested Packet Interval (RPI)	5 ms – 1000 ms			

Maximum number of connections when using AS300 to connect to other devices through Ethernet/IP:

- AS300 can act as a Scanner and an Adapter simultaneously. It can be connected up to 16 devices (for example 8 Scanners and 8 Adapters).
- When AS300 acts as a Scanner, it can connect to up to 16 devices. Each device can establish up to 32 connections for data exchange. Data exchange types can be I/O connection and Consumed Tag. You can use explicit message for data exchange at the same time, up to 16 explicit message connections can be created.
- When AS300 acts as an Adapter, it can connect to up to 16 devices. Each device can establish up to 8 connections for data exchange. Data exchange types can be I/O connection and Produced Tag. You can use explicit message for data exchange at the same time, up to 8 explicit message connections can be created.

* Using device D or device M takes 2 bytes (16 bits) as a unit in data length for IO connections, for example M0 to M15 (16 bits), M12 to M43 (32 bits). If you need to store the data of 200 bits from M100, the data length should be set in a value larger than 200 bits and in bytes it will be 26 bytes (26 bytes = 208 bits), the actual devices to be mapped will be M100 to M307. D0.0 will be stored in M100 (the first bit).

** Array-typed tags are NOT supported in explicit messages.

9.3.3 PROFINET Specification

When AS-FPFN02 is installed on AS300 PLC CPU, this communication card can work independently and does NOT occupy the communication port of PLC CPU. AS-FPFN02 can act as a PROFINET adapter and connect to a PROFINET scanner to exchange data on the PROFINET Network (PN) Refer to section 10.2.8 of AS Module Manual for more information.

Item	Specification
Communication Protocol	PROFINET
EtherNet/IP Interface	100 Mbit with 2 x RJ45
Device Type	PROFINET Devices
Network Cable Length	100 meter
Error Indicator	System Fail (SF): Red; Bus Fail (BF): Red
Max. IO Slot Supported	17
Register to Read and Write	AS300 series data registers are supported to read and write
Minimum Time for Data Exchange to Operate	10 ms
Maximum Data Length/Per Transmission	Input: 250 words Output: 250 words
PROFINET Configuration	Download PROFINET Configurations from PN Controller

9.3.4 EtherNet Communication Port

9.3.4.1 Communication Port Pin Assignment

Delta EtherNet/IP devices use CAT5e industrial Ethernet cables and can be connected via RJ-45 communication port.

Pin	Signal	Description	Pin	Signal	Description
1	Tx+	Transmit plus	5	--	N/C
2	Tx-	Transmit negative	6	Rx-	Receive negative
3	Rx+	Receive plus	7	--	N/C
4	--	N/C	8	--	N/C

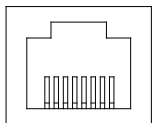

8 ← 1

9.3.4.2 Communication LED Indicator

LED Indicator		LED Status	Description
LINK	Green	ON	<ul style="list-style-type: none"> ● Communication port is connected. ● Connected to Ethernet
		OFF	<ul style="list-style-type: none"> ● Communication port is not connected. ● Not Connected to Ethernet
ACK	Yellow	Blinking	<ul style="list-style-type: none"> ● Packets transmitting/receiving ● Packets transmitting/receiving over Ethernet
		OFF	<ul style="list-style-type: none"> ● No packets transmitting/receiving ● No packets transmitting/receiving over Ethernet

Note: The LED indicator is at the RJ45 connection.

9.4 EtherNet/IP Software

EtherNet/IP related parameters are set through HWCONFIG, which is embedded in ISPSOft. Call HWCONFIG from ISPSOft (version 3.12 and above). Download the ISPSOft software at: [Delta | Download Center \(deltaww.com\)](http://Delta | Download Center (deltaww.com))

9.4.1 Run HWCONFIG via an Ethnet/IP Scanner

You can call HWCONFIG from Delta EIP Scanner's ISPSOft project. The Delta EIP Scanner is the EtherNet/IP communication PLC and the EtherNet/IP module. When using a Delta EIP Scanner, you set up an Ethnet/IP module through HWCONFIG in ISPSOft. Make sure the current communication is via EtherNet in ISPSOft. Refer to Section 9.9.3 for a list of Delta EIP Scanner products supported by HWCONFIG.

1. Operation Steps

1. Open COMMGR: click the **Start** menu and go to **Programs > Delta Industrial Automation > COMMGR**
Add a new Driver, Ethernet. And start searching for IP addresses of the current devices.

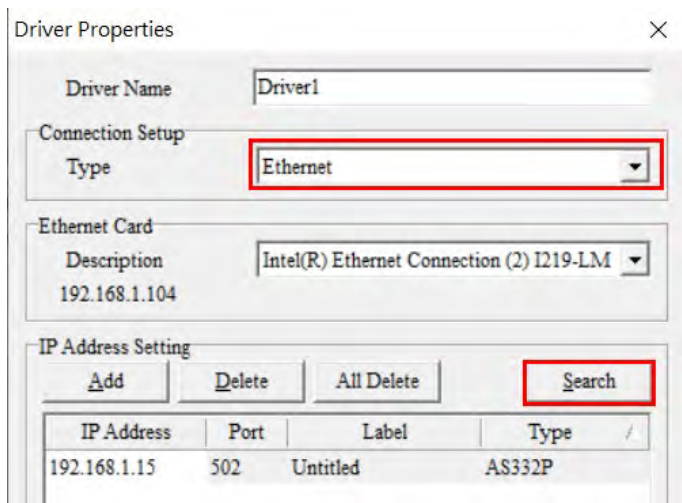

2. Open ISPSOft: click the **Start** menu and go to *Programs -> Delta Industrial Automation -> ISPSOft*
3. *ISPSOft -> Tools -> Communication Settings*: Select the previous set Ethernet driver and the IP address.
4. ISPSOft : Create a new project: on the **File** menu, click **New** to display the Create a New Project dialog box.

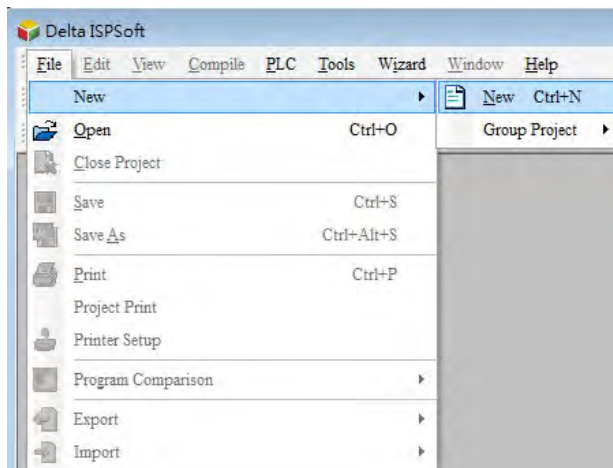

5. Select a PLC: in the Create a New Project dialog box, select a PLC that supports Ethernet/IP.

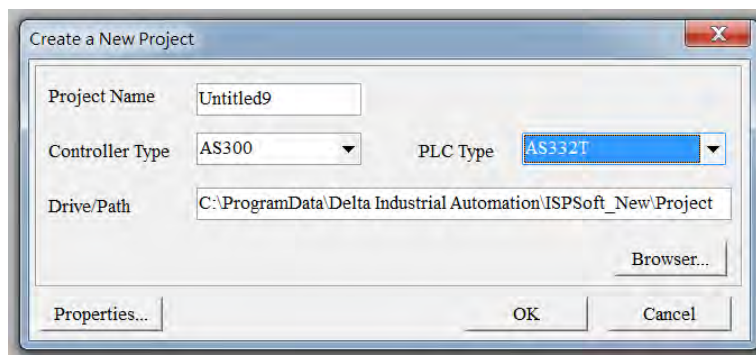

6. Open HWCONFIG: double-click **HWCONFIG** in the Project window.

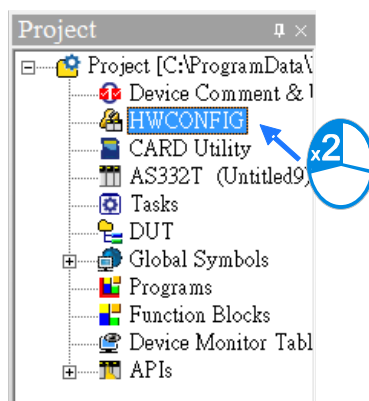

7. Upload settings to HWCONFIG: click **Upload** to copy the parameters from the PLC to HWCONFIG. If there's any change on the module configuration, you can use **Scan** to update the parameters in HWCONFIG.
8. Save and download the settings from HWCONFIG : on the **File** menu click **Save** to save the settings and then click the download button on the toolbar to download the file to PLC. You must save the configuration in HWCONFIG before opening the other communication tools. While working in the communication tools, you cannot work in HWCONFIG.

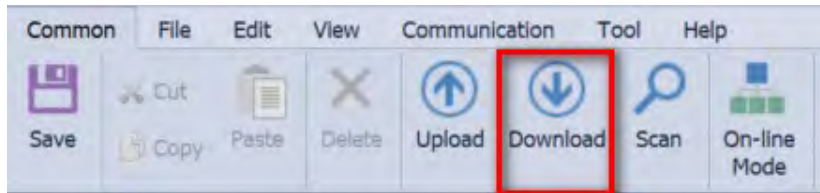

9. Open EtherNet/IP editing page: right-click the CPU module in the system configuration area to see the EtherNet/IP button. Click the button to open the EtherNet/IP editing page.

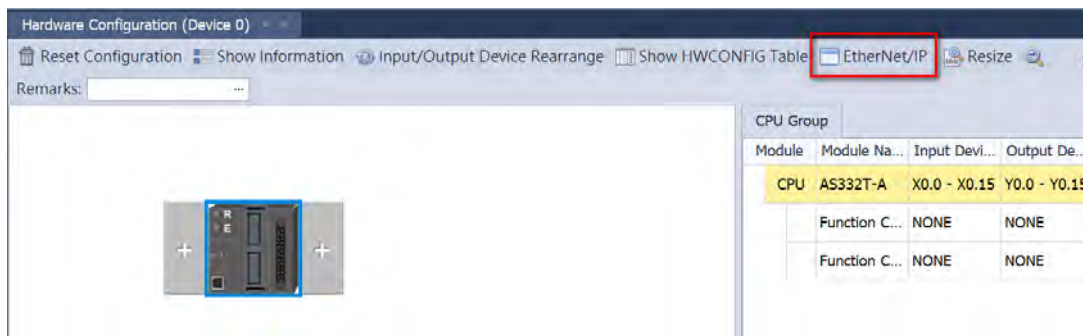

9.4.2 Set up the IP Address

This section provides an overview on how to set up IP address for AS Series modules. Set up the IP address before configuring the EIP related parameters or data exchange settings. For the editing on the network parameters, you need to go to HWCONFIG -> Edit Area -> General -> Ethernet Port Basic Setting.

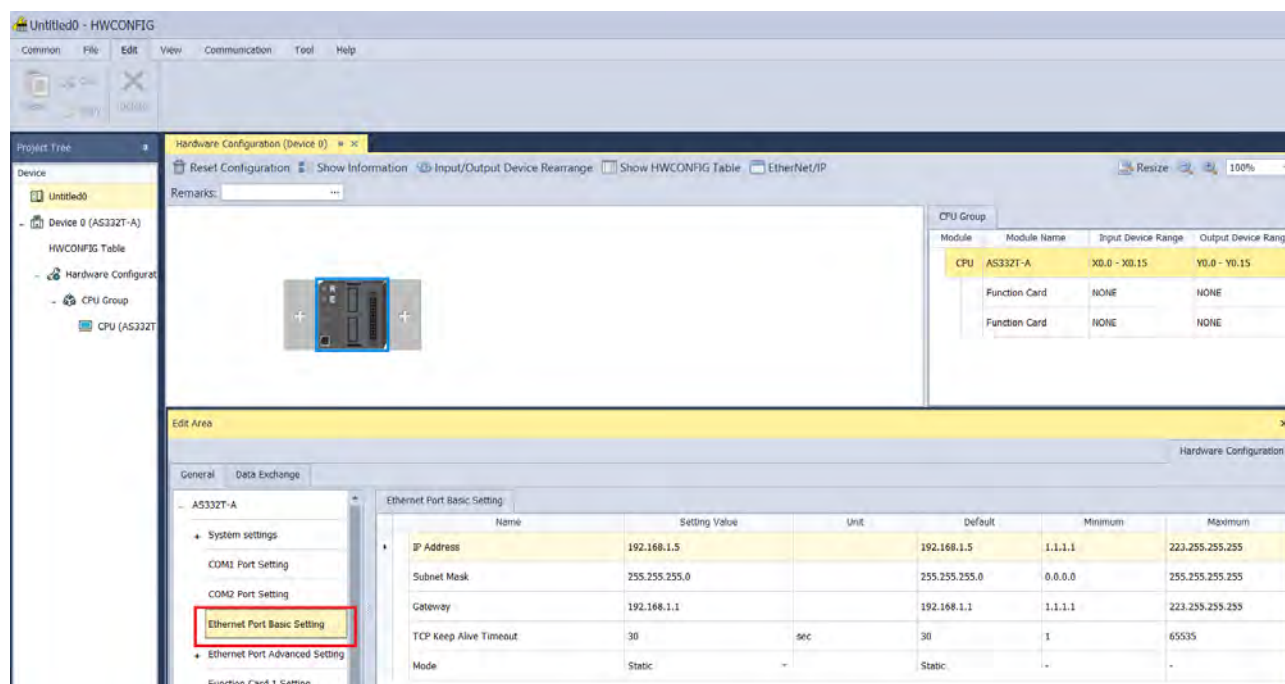

9.4.2.1 IP Address Types

The AS Series supports 3 types of IP addressing, BOOTP, DHCP and static IP address.

Type of IP Address	Definition
BOOTP	Uses the TCP/IP Bootstrap Protocol (BOOTP) to set up the IP address, netmask and gateway. A BOOTP server may require some configuration. The BOOTP protocol is designed for a network in which each host has a permanent network connection.
DHCP	Uses the Dynamic Host Configuration Protocol (DHCP) to automatically obtain IP address, netmask, gateway, main computer name and the WINS server.
Static IP	You manually set the IP address, netmask and gateway.

9.4.2.2 Set the IP Address (Static IP)

- **Steps to set the IP address**

When using an EIP product with a static IP address, set up the IP address in HWCONFIG in ISPSOft. The following example uses the AS Series.

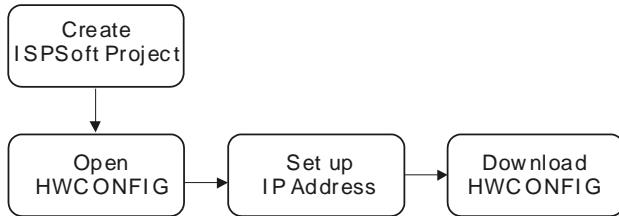

1. Configure the network parameters
 - ◆ Double-click the AS Series module in HWCONFIG to see the Edit Area.
 - ◆ On the **Ethernet Port Basic Setting** tab, set the IP address and then click **OK**.

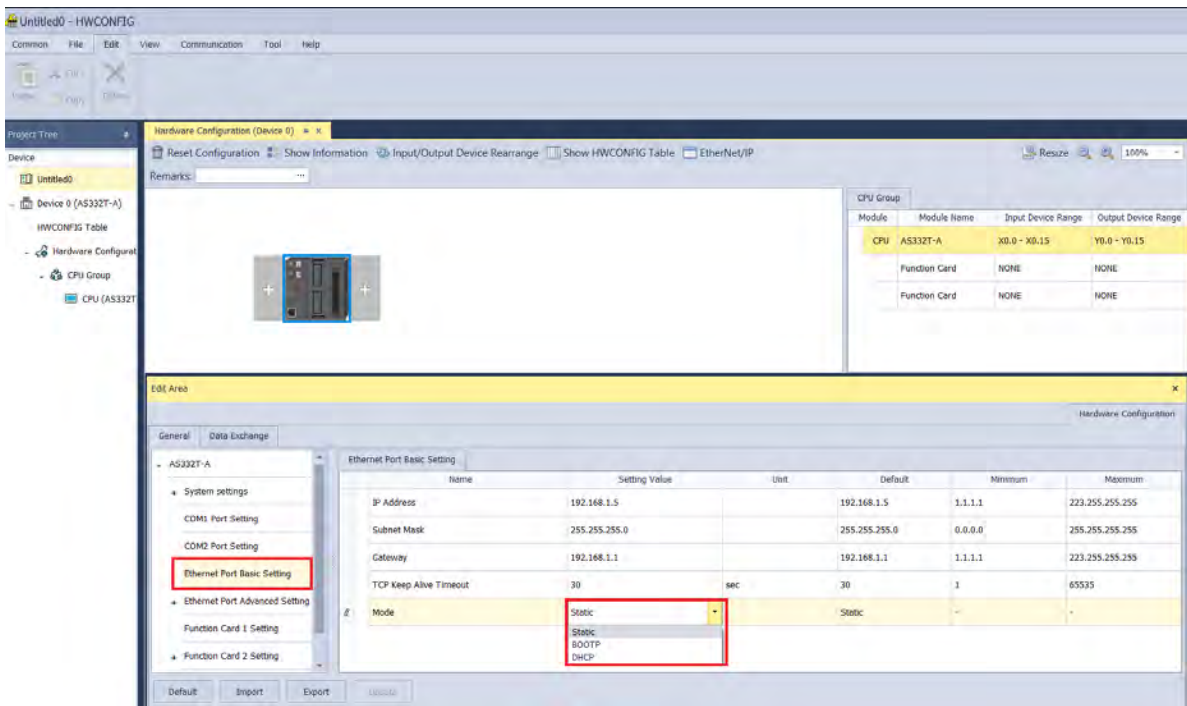

2. Save and download the settings from HWCONFIG: on the **File** menu click **Save** to save the settings and then click Download button on the toolbar.

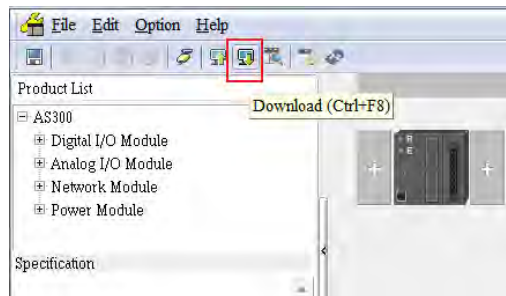

9.4.2.3 Set up the IP Address (BOOTP/DHCP)

When using an EtherNet/IP product with a BOOTP/DHCP IP address, users can set up the IP address through the IP Manager Tool in HWCONFIG.

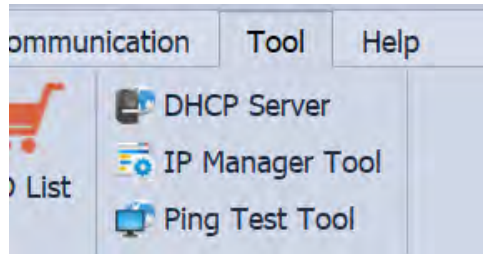

If the default IP type is DHCP, open DHCP Server to set up the IP address.

DHCP :

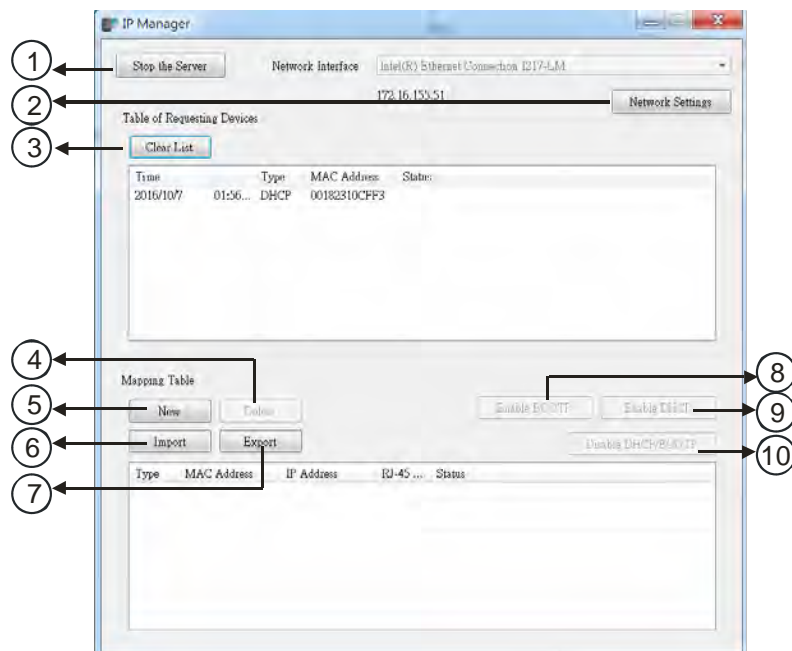

Item	Definition	
①	Stop the Server	Stops the BOOTP/DHCP server; the IP manager does not request an IP addresses from the BOOTP/DHCP server.
②	Network Settings	Opens a dialog box to set up the subnet mask, gateway, primary DNS, secondary DNS, and domain name.
③	Clear List	Clears the contents of the list.
④	Delete	Deletes the selected item from the list.
⑤	New	Adds a new IP/MAC address.
⑥	Import	Imports the IP/MAC address list; the file format is .CSV.
⑦	Export	Exports the IP/MAC address list; the file format is .CSV.

⑧	Enable BOOTP	Enables the BOOTP to assign an IP address for the selected item.
⑨	Enable DHCP	Enables the DHCP to assign an IP address to the selected item.
⑩	Disable BOOTP/DHCP	Disables the BOOTP/DHCP on the device; the device does not request an IP addresses from the server.

● **Steps to set the IP address:**

1. MAC address: find the MAC address on the EIP device. The MAC address uniquely identifies the device.

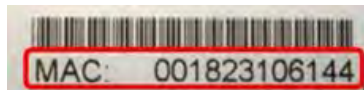

2. Open the DHCP Server

◆ HWCONFIG : Click **Tool** and then click **DHCP Server**.

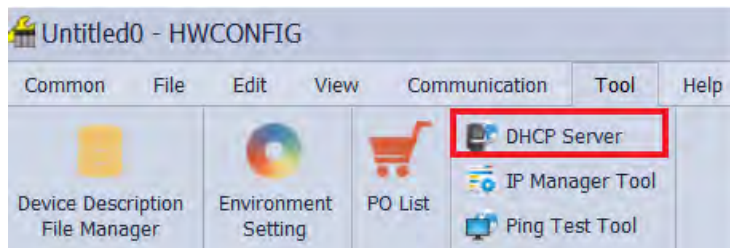

◆ The IP Manager can be the BOOTP/DHCP Server, receiving IP address requests from devices. The IP Manager window is shown below.

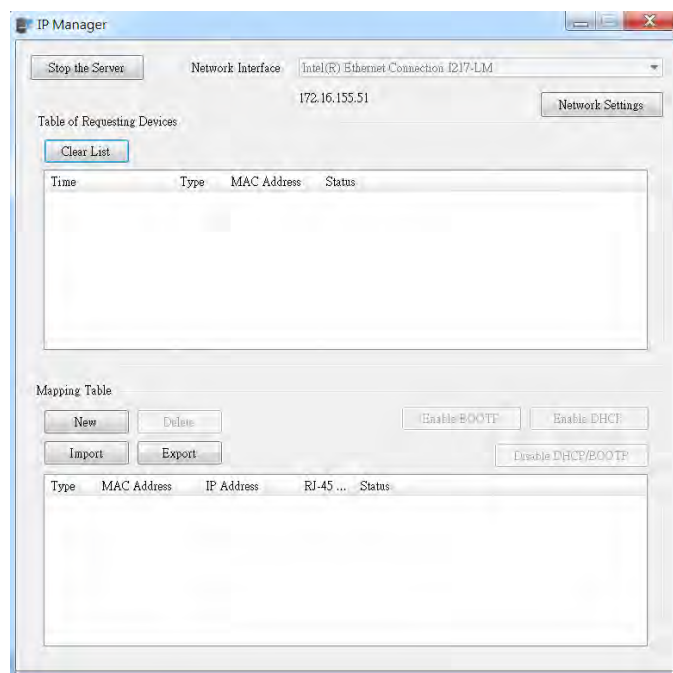

3. Set up the IP address

- ◆ Double-click the listed MAC address for your device to open the Input Data dialog box.

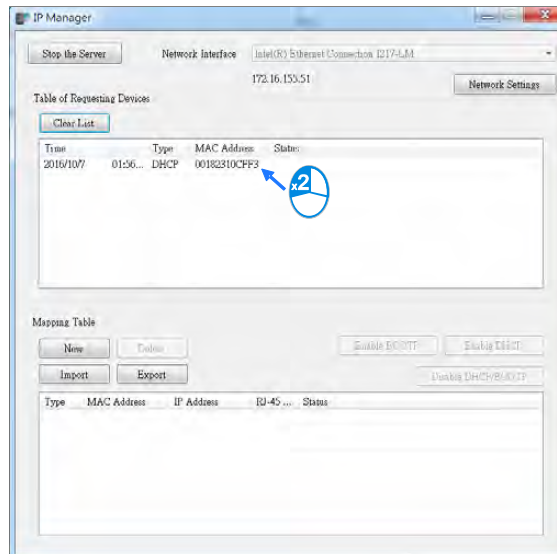

- ◆ Enter the IP address and click **OK**.

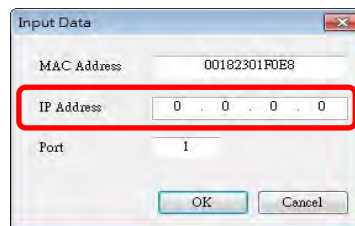

4. Disable DHCP/BOOTP

Click the device in the Exchange Table that you want to disable, then click **Disable DHCP/BOOTP**. The selected device does not send DHCP/BOOTP requests. To change the IP address receiving mode, refer to Section 9.4.2.2 for more information.

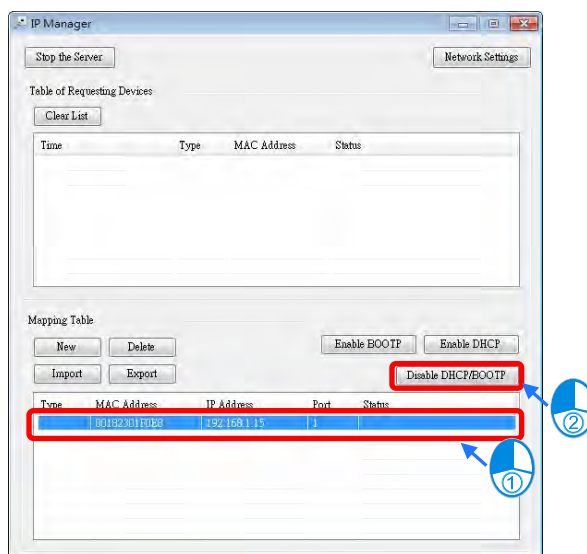

Notes

- Enable BOOTP: when the IP address receiving mode is BOOTP (BOOTP is enabled), the IP address is assigned, and the device sends out BOOTP requests for IP addresses during each power-on.
- Enable DHCP: when the IP address receiving mode is DHCP (DHCP is enabled), the IP address is assigned, and the device sends out DHCP requests for IP addresses during each power-on.
- Disable DHCP/BOOTP: when BOOTP is disabled, the device does not send out any DHCP/BOOTP requests for IP addresses during each power-on.

9.4.3 Network

HWCONFIG provides a graphical user interface, and you can see the devices and their EtherNet/IP connections in the Network View.

EtherNet/IP Page

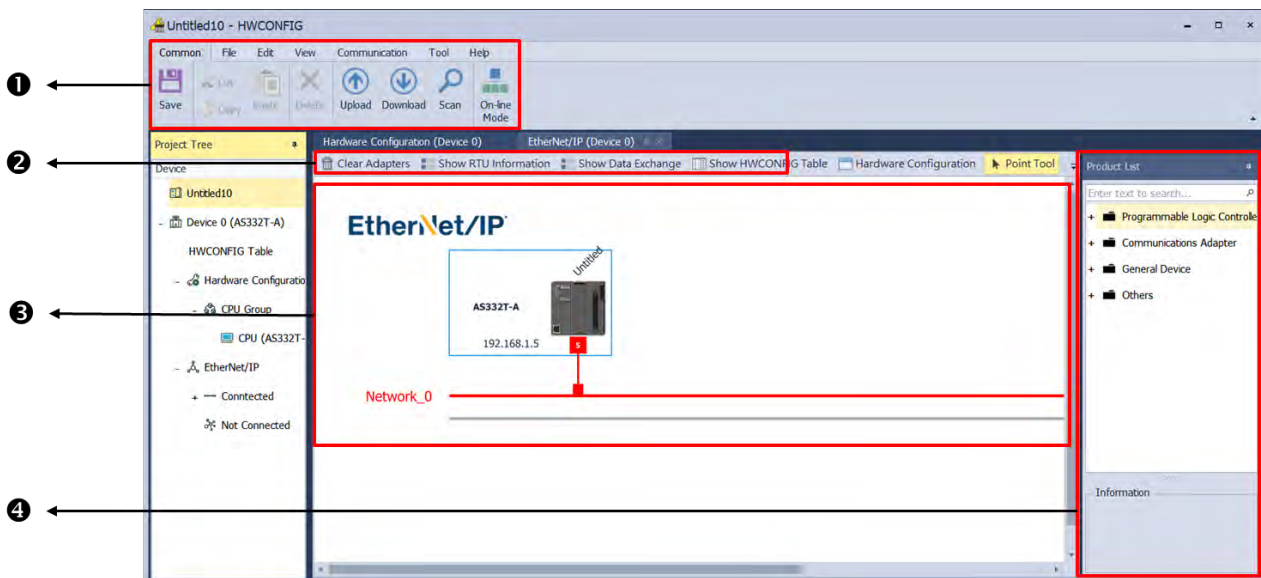

	Item	Definition
❶	Toolbar	Toolbar buttons
❷	Network View	Displays the connected devices and their connection status
❸	Configuration Area	Displays the configurations and allows you to set the parameters
❹	Product List	Displays the available devices that can be connected to EtherNet/IP

Function Buttons

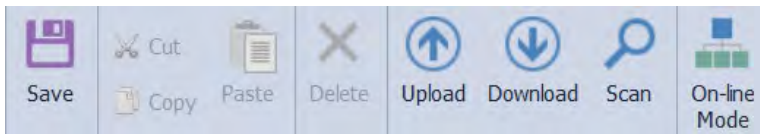

Icon	Name	Definition
	Save	Saves the project
	Cut	Cuts the selected item
	Copy	Copies the selected item
	Paste	Pastes the selected item
	Delete	Deletes the selected item
	Uploader	Uploads from a device
	Downloader	Downloads to a device
	Scan Network	Scans the network for device availability
	On-line Mode	Switches to on-line mode

Setting Area



- Clear Adapters: Use this button to clear EIP Builder of the network and the data exchange table.
- Show RTU Information: Use this button when the PLC works with AS00SCM-RTU (AS-FEN02) and once you click this option, the placement of RTU will show up.

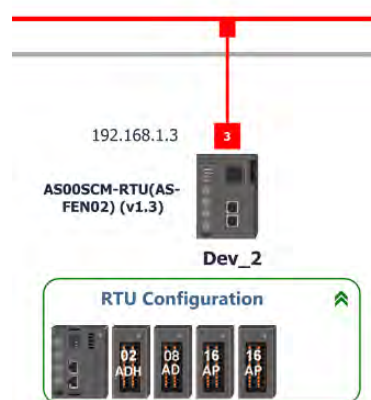

- Show Data Exchange: Use this button to open the data exchange table. More information on data exchange will be given in the following sections.
- Show HWCONFIG Table: Use this button when the PLC works with AS00SCM-RTU (AS-FEN02). Refer to Chapter 9 from AS Series Module Manual for more information.
- Hardware Configuration: Use this button to switch back to HWCONFIG main page.

Network View

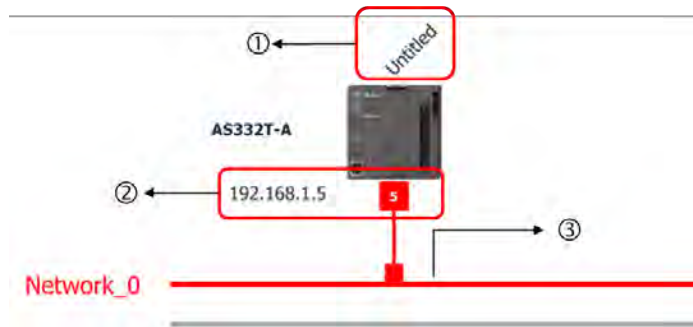

	Name	Definition
①	Device name	Name of the device; Scanner name can be edited in hardware configuration, while Adapter name can be changed here.
②	IP address	Shows the IP address of the device; the red box indicates it is the communication port and the number shown is the last digit of the device IP address.
③	Network_0	Displays the connection status; devices on the same line indicate they are in the same network.

Product List

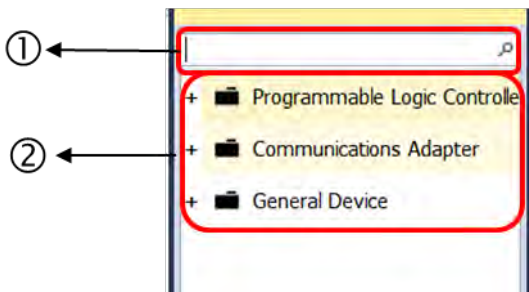

	Name	Definition
①	Search Bar	Type the module name you want to find; if no match is found, that means there is no EDS file in the system matching the module name.
②	Product List	Categorizes the devices according to the EtherNet/IP definition; devices from third parties are in the Others folder.

9.4.4 Add New Devices

Scan Network

- **Steps to add new devices by scanning the network**

1. Click the **Scan** button to scan the network and the scanned devices are shown in the Adapter Scan.
2. Select the devices to add to the Network View, and then click **OK** to add the selected devices.

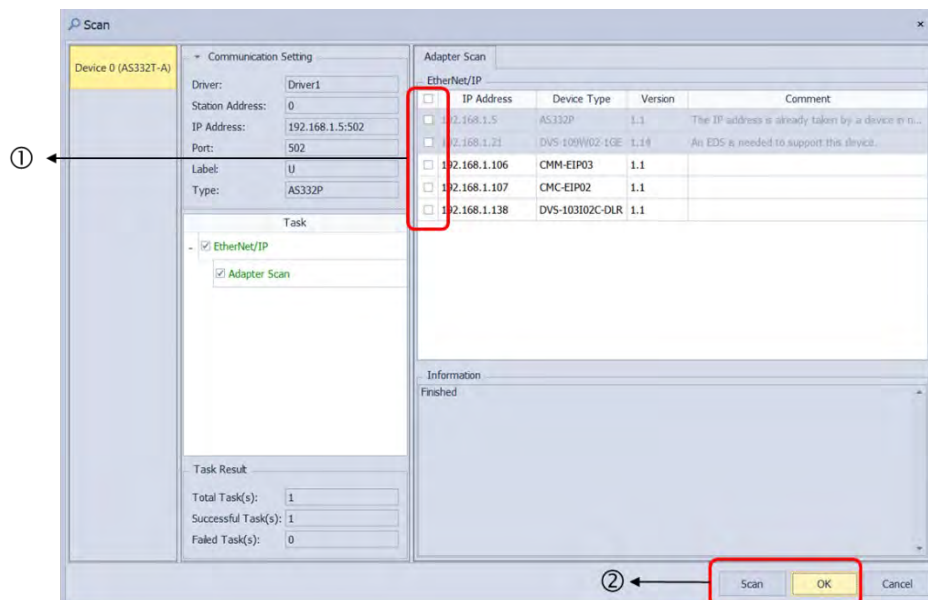

	Name	Definition
①	Selection checkboxes	Select the devices you want to add to the network view.
②	Scan	Scan the network again
②	OK	Add the selected device to the network view

Add devices (Manually)

- **Steps to add new devices manually**

1. Select the devices to add from the Product List. You can also enter the module name in the search bar. Drag the device onto the Network View.



2. Double-click the IP address of the added device to edit its IP address.

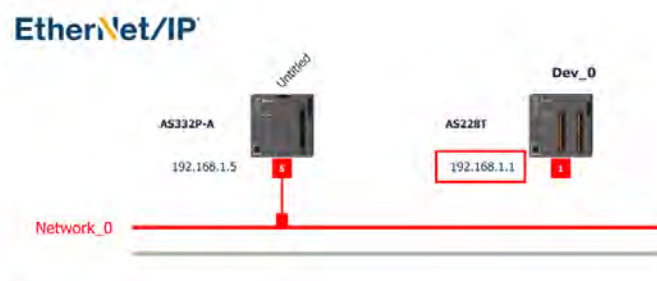

Set EIP parameters

1. **Create the network**

- (a) Drag the Ethernet communication port (the red box) of the device to the network to create a new connection.



- (b) Right-click on the blank area to see the **Fast Connect** option and then click it to see a list of available devices. Select the ones you need to add multiple devices at the same time to the network.

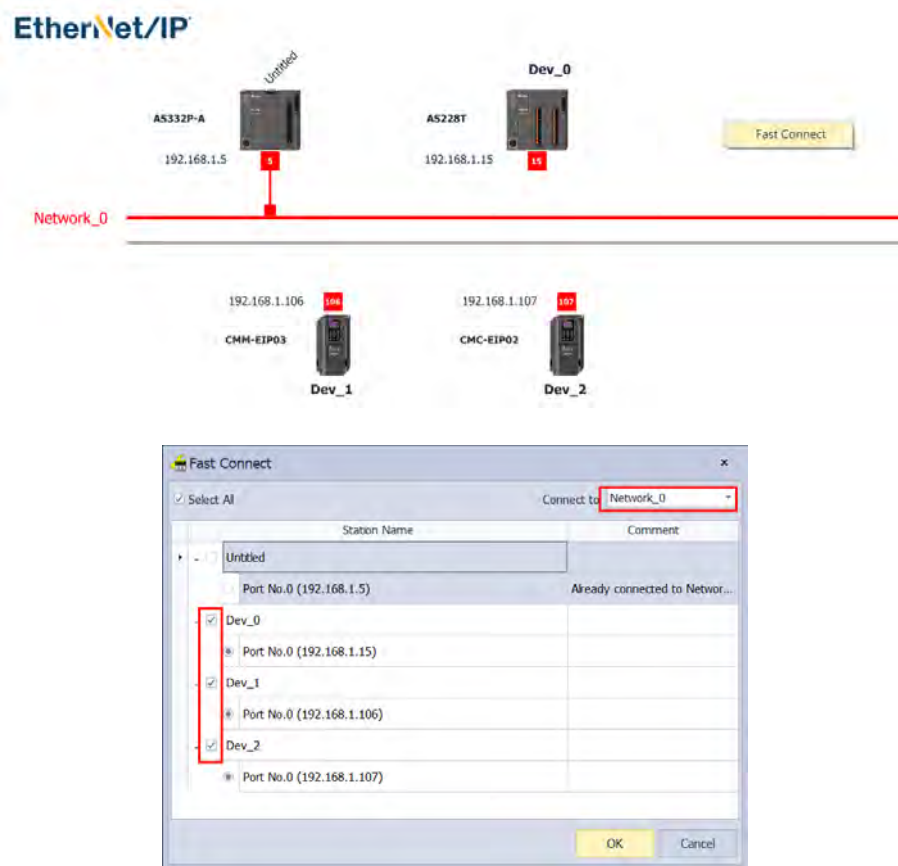

- (c) Once the connection is established, click the network line “Network_0” to see all the connected devices in this network in the Information window.

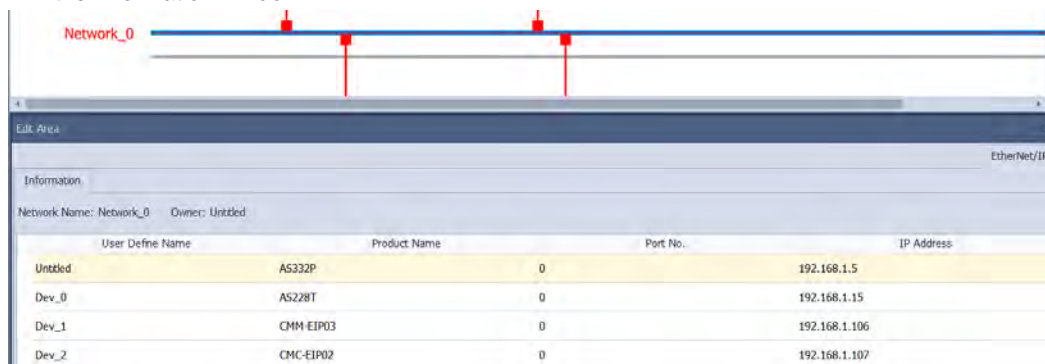

2. Set the parameters

Click the tabs in the Information window to view and edit the Data Exchange, Information and the Device Parameter.



- **Data Exchange**

Only when the selected device is an EIP Scanner, this tab can be functional. Refer to section 9.4.5 for more information on Data Exchange.

- **Information / EIP Parameter**

When offline, this tab is shown as Information. You can check information in the EDS file. When adding an EIP Adapter, you will need to set up the device IP address here. Refer to section 9.4.4.2 for more information.

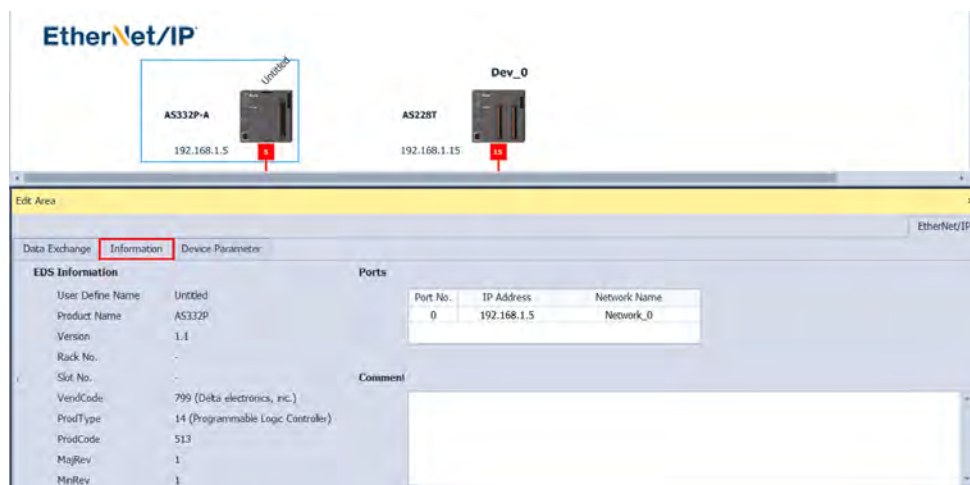

When the device is connected, this tab is shown as EIP Parameter. You can click the **Upload** button to upload the related parameters from the device. Or click the **Download** button to download the related parameters to the device.

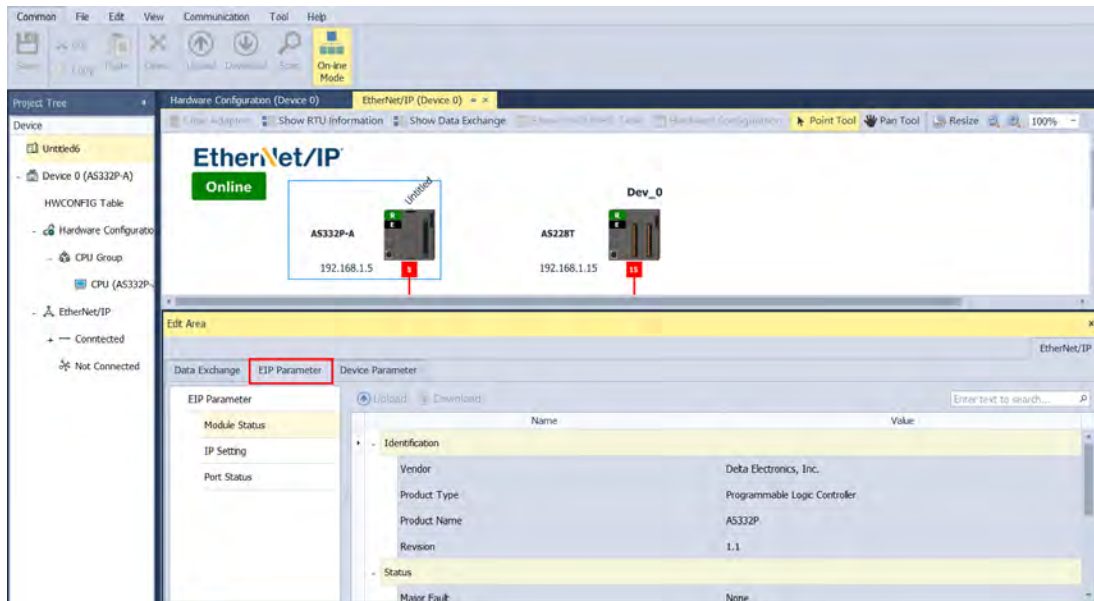

	Name	Definition
①	Module Status	<ul style="list-style-type: none"> ● Identification: displays information regarding Vendor, Product Type, Product Name, Revision, etc. ● Status: displays connection status, including Major Fault, Minor Fault, Internal State, Configuration Status, and Module Identity.
②	IP Setting	<ul style="list-style-type: none"> ● Port1: indicates port 1 of the device, for editing IP Address, Subnet Mask, Gateway Address, and Host Name. <p>Note: when there is a Port2, that means there are 2 Ethernet communication ports.</p>
④	Port Status	<ul style="list-style-type: none"> ● Displays Link Status, Speed, Duplex, Negotiation Status and Hardware Fault.

9.4.5 Data Exchange – Implicit Message

When the connection between devices is established, you can use exchange data between devices. This section provides an overview of how to create a data exchange table.



9.4.5.1 Data Exchange page

1. Data Exchange Table

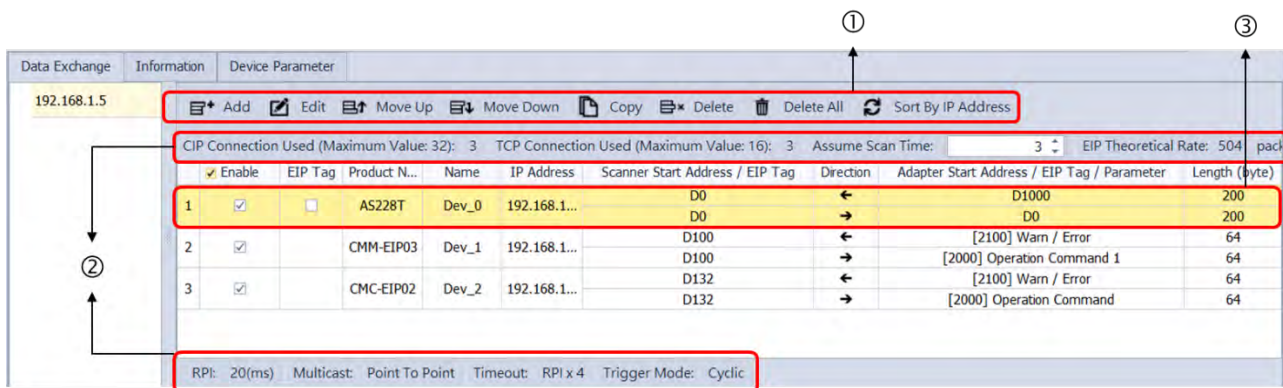

No.	Category	Item	Description
①	Tool bar	Add	Use this button to add new item for data exchange. Click the IP address column of the newly added row to select the IP address of the to-be-added device.
		Edit	Use this button to open the data exchange table for editing.
		Move Up / Move Down	Use this button to change the order of data exchange. (this order is related to the order in SR1020 to SR1083, the EtherNet/IP connection 1 to 32).
		Copy / Delete	Use this button to copy or delete the selected row.
		Delete All	Use this button to delete the whole data exchange table.
		Sort By IP Address	Use this button to arrange the order of data exchange by IP addresses.
②	Information bar	Number of connections	<ul style="list-style-type: none"> ● CIP Connection Used: the total number of connections for data exchange ● TCP Connection Used: the total number of connected devices Connection for data exchange; each row represents one independent EtherNet/IP connection. The number of connections cannot exceed the maximum number of connections for the Scanner. For example, AS Series can be connected to up to 16 adapters and the maximum number of connections for data exchange is 32.
		Communication capacity	Enter the assumed PLC scan time to estimate the network loading for the data exchange. Refer to section 9.3.2 for more information.
		Communication parameters	Display the essential parameters of the selected row.
③	Data	Enable	Enable or disable the data exchange of the connection.

No.	Category	Item	Description
	exchange table	EIP Tag	<p>You must create a Consumed Tag in the Global Symbols in ISPSOft before using this function.</p> <p>Use EIP Tag to perform data exchange with adapters.</p> <p>After selecting this check box,</p> <ul style="list-style-type: none"> ● The directional arrow points left of (←) (READ only) ● Registers cannot be used in this row. ● The length format is defined by the data format in the Global Symbols; you cannot change the length format here. ● Refer to section 9.4.6 for more information.
		Product name	Once you select the IP address, its name is displayed. And it cannot be changed here.
		Name	Go to the network view to change the device name. Refer to section 9.4.3.3 for more information.
		IP Address	The IP address of the Adapter for the Scanner to connect to. After the data exchange connection is established, the system loads the connected devices' IP addresses. After that you can select the device's IP address from the list to add or edit the connection.
		Scanner Start Address / EIP Tag	<p>Starting address of the Scanner register in the data exchange table</p> <p>FW V1.08 or previous versions support device D.</p> <p>FW V1.10 or later version support device D and M.</p> <p>Using device D or device M takes 2 bytes as a unit in data length.</p>
		Adapter Start Address / EIP Tag / Parameter	Starting address of the target Adapter register in the data exchange table / EIP Tag / Parameters
		Length (byte)	Set the data exchange length. The data length is set according to EDS file and the maximum is 500 bytes; unit: byte. You cannot change the length here when using EIP Tag.

2. Data Exchange Parameters

Click **Data Exchange** tab and click the Data Exchange device. After that click **Edit** to open the data exchange setting page.

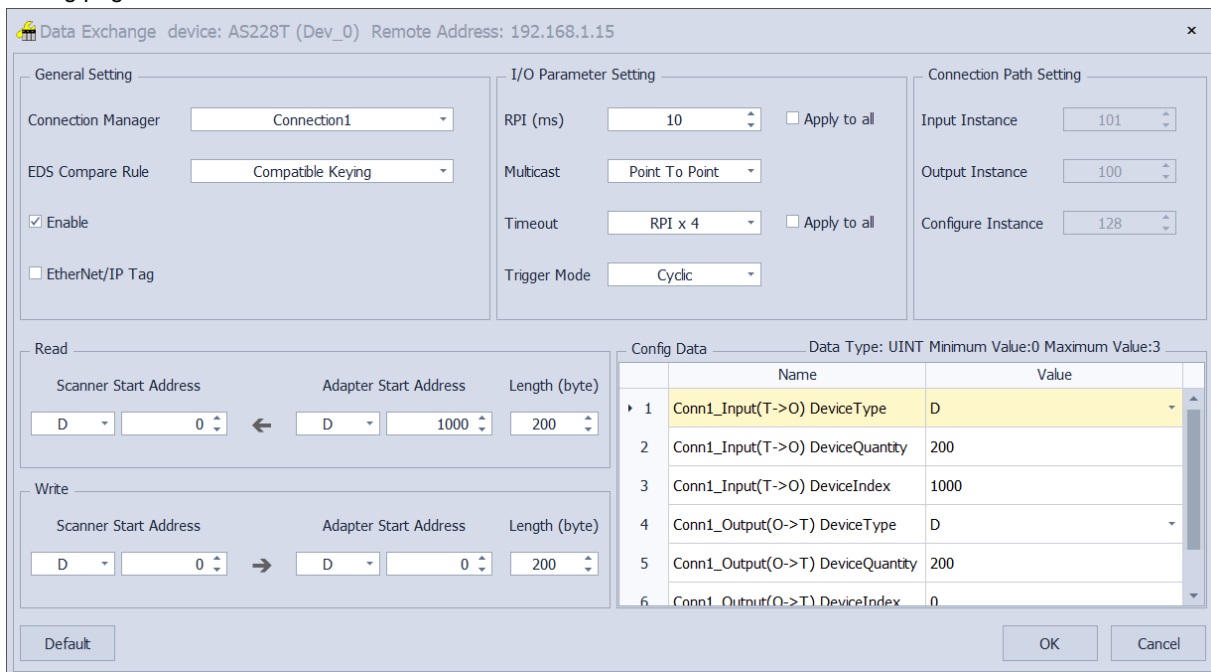

Name	Item	Description
General Setting	Connection Manager	Select the connection from the EDS file. Different connections may have different exchange parameters.
	EDS Compare Rule	EIP Scanner checks the followings according to the setting: <ul style="list-style-type: none"> ● Disable keying: Disable key checking the product information and versions. ● Compatible keying: Check the product information (Vendor ID, Device Type, Product Code), and Major Revision (should be matched). Minor revision is not checked. ● Exact match: Check the product information, major revision and minor version should be matched with what stated in EDS file.
	Enable	Enable or disable the data exchange.
	EtherNet/IP Tag	Use EtherNet/IP Tag to perform data exchange with adapters. You must create a Consumed Tag in the Global Symbols in ISPSOft before using this function. After selecting this check box, <ul style="list-style-type: none"> ● The directional arrow points left of (←) (READ only) ● Registers cannot be used in this row. ● The length format is defined by the data format in the Global Symbols; you cannot change the length format here. ● Refer to section 9.4.6 for more details
I/O Parameter Setting	Requested Packet Interval (RPI)	<ul style="list-style-type: none"> ● Time interval to request packets through the I/O connection, unit: ms ● Click Apply to all: to apply the I/O parameter settings to all the items on the data exchange list.
	Multicast	<ul style="list-style-type: none"> ● Communication mode setup: Multicast or Point-to-Point ● Point-to-Point is more common; use Multicast when the connection is Listen_only.
	Timeout	<ul style="list-style-type: none"> ● Sets the timeout according to the RPI or a multiple of RPI (RPI*X). ● Click Apply to all: to apply the settings to all the items on

Name	Item	Description
		<p>the data exchange list.</p> <ul style="list-style-type: none"> The minimum value is 100 ms. When a value that is less than 100 ms, the PLC will automatically double the timeout setting. For example, if the RPI=20 ms and the multiple value is set to 4, the total will be 80 which is less than 100. PLC will automatically double the multiple value from 4 to 8 to make the timeout setting value bigger than 100 ms.
	Trigger Mode	<p>Data refreshing trigger mode; common use: cyclic</p> <ul style="list-style-type: none"> Cyclic: refreshing data cyclically Change of State: refreshing data once there is any change Application: refreshing data according to product definition
Connection Setting	Path	<ul style="list-style-type: none"> The instance number is the same as the data exchange connection number. You can tell the mapped data is from which corresponding device by the instance number. The parameters are read from the EDS file, when connected, if the connection of the Connection Manager changes, this section updates values accordingly. You can edit input instance, output instance and configure instance in some of the EDS files. If not the section is grayed-out.
	Input Instance	
	Output Instance	
Input (T->O) Instance Output (O->T) Instance	Address	<ul style="list-style-type: none"> Delta controller products: you can set the register address for data exchange. Delta drive products: the supported products are listed on the editing page. Click "...” on the editing page for more information.
	Length	<ul style="list-style-type: none"> Set the length for data exchange; unit: byte and 2 bytes When device M is used in the beginning address of the scanner; the data length unit can be set to 2 bytes (16 bits).
Configure Instance	<p>You can use self-defined parameters. But the parameters are set according to the EDS file from the EIP Adapter. After editing, download the parameters to EIP Scanner and then after the connection is established, write the parameters into EIP Adapter.</p>	

9.4.5.2 Delta Adapter

1. Refer to section 9.4.4 to add new devices and create connections for all the added devices.
2. Click Show Data Exchange to open the editing page for data exchange.

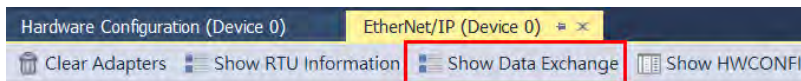

EtherNet/IP

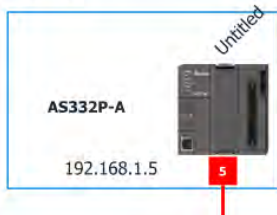

3. Set up the address for data exchange

Set up the register address for the Scanner. Make sure the register address is free for use. The following examples use 3 different types of devices for demonstrations.

- PLC Controller - AS200

Multiple data exchanges can be executed for one PLC controller at a time. One connection is for one data exchange. You can edit the addresses and data lengths for data exchange. Unit: 2 bytes.

Enable	EIP Tag	Product Name	Name	IP Address	Scanner Start Address / EIP Tag	Direction	Adapter Start Address / EIP Tag / Parameter	Length (byte)
<input checked="" type="checkbox"/>	<input type="checkbox"/>	AS228T	Dev_0	192.168.1.15	D0	←	D1000	200
<input checked="" type="checkbox"/>	<input type="checkbox"/>	AS228T	Dev_0	192.168.1.15	D100	←	D1100	200
<input checked="" type="checkbox"/>	<input type="checkbox"/>	AS228T	Dev_0	192.168.1.15	D200	←	D1200	200
					D200	→	D200	200

- Servo drive – CMM-EIP02 (MS300)

- 1) Only one data exchange can be executed for one servo drive at a time. The data length is fixed and cannot be edited.
- 2) Click “...” to see more servo drive settings.

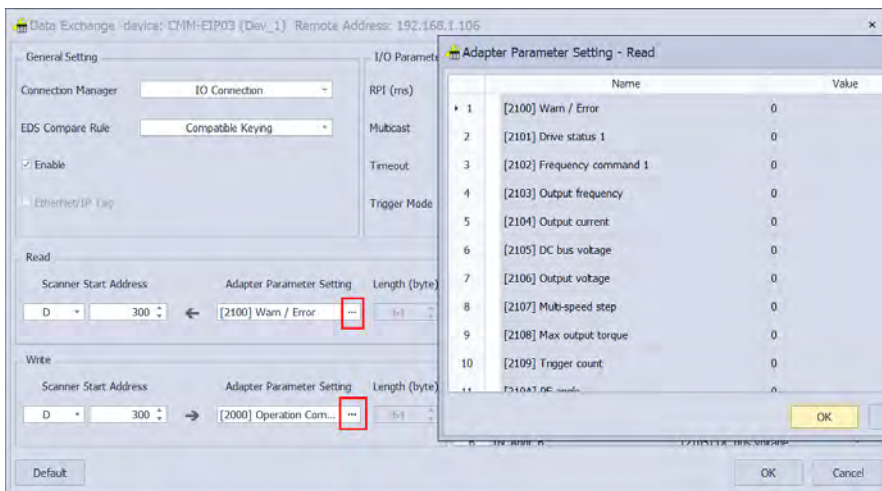

- 3) Most of the functions in the data exchange area are fixed. Some self-defined options are in HWCONFIG. Make sure your ISPSOft is up to date.

	Name	Value
23	[6106] Output Torque 2	0
24	Reserved	0
25	Reserved	0
26	User Defined	... 0
27	User Defined	... 0
28	User Defined	... 0
29	User Defined	... 0
30	User Defined	... 0
31	User Defined	... 0
32	User Defined	... 0

- 4) Refer to Delta High Frequency Motor Drive C2000 User Manual for more details.

● Delta Temperature Controller (DTME)

- 1) Multiple data exchanges can be executed for one PLC controller at a time. One connection indicates one module. Connection 1 represents the CPU and connection 2 represents the first DTME module and so forth.
- 2) You can edit all the corresponding parameters.

	Name	Value
▶ 1	[X268] MON-PV1 CH1 Present Value	... 0
2	[X269] MON-PV2 CH2 Present Value	... 0
3	[X26A] MON-PV3 CH3 Present Value	... 0
4	[X26B] MON-PV4 CH4 Present Value	... 0
5	[X26C] MON-PV5 CH5 Present Value	... 0
6	[X26D] MON-PV6 CH6 Present Value	... 0
7	[X26E] MON-PV7 CH7 Present Value	... 0

- 3) Refer to Delta Temperature Controller Operating Manual for more details.

9.4.5.3 The 3rd Party Adapter

If you need to use a 3rd party adapter, you should read its user manual carefully or work closely with its trained and competent personnel to obtain the EDS file. The followings demonstrate how to add devices in with and without EDS files.

● **With EDS Files:**

1. Import the EDS file to HWCONFIG and the wizard will guard you through the process to add the 3rd party device in the network. The parameters of the 3rd party device will be brought in automatically.
2. Click **Device Description File Manager** to open the wizard.

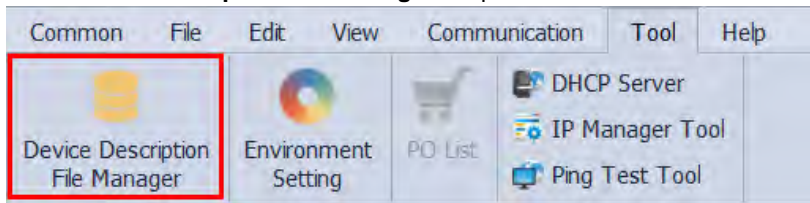

3. Select **Install Description File** and click **Next**.

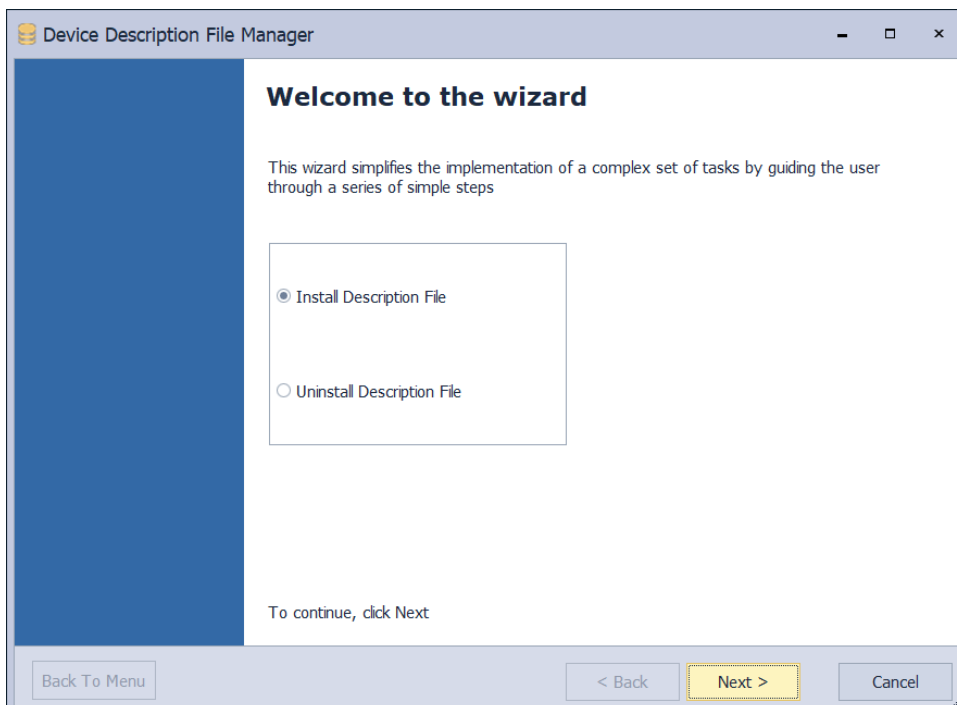

4. Select **EDS (Electronic Data Sheet)** and click **Next**.

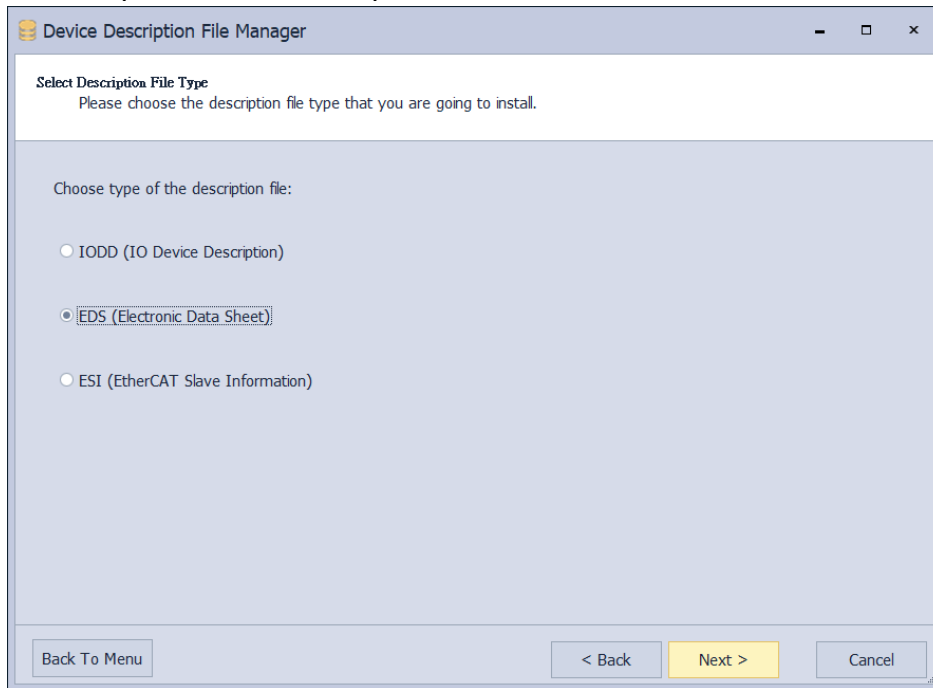

5. Select and locate where you store the EDS file and then follow the wizard to complete the import.
6. After the import is done, you can scan the network to add the device in or select it from the group of Others in Product List.

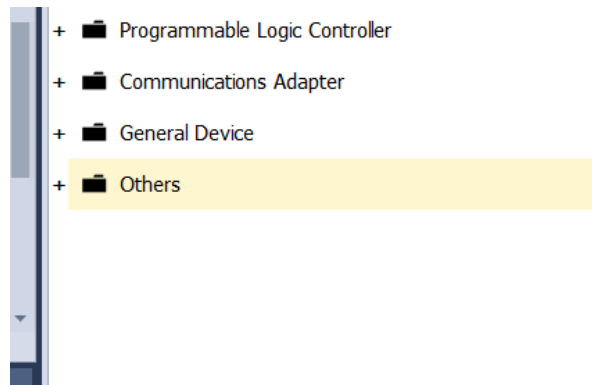

● **Without EDS Files:**

1. When there is no EDS file, you can use **General Device** to set up.
 - a) Select General Device from the Product List and add it to the network.
 - b) Set up the IP address for the 3rd party device.

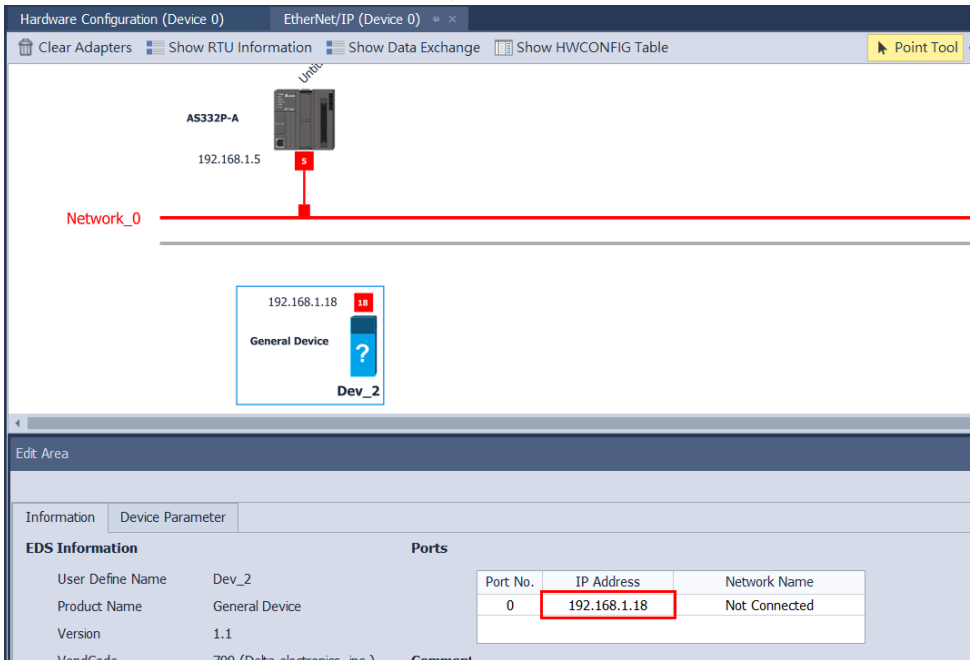

- c) Connect the device to Network_0.

2. Open Data Exchange setting page to set up.



- a) General Setting: No need to change anything here.
- b) I/O Parameter Setting: You can edit the settings here according to your requirements.
- c) Connection Path Setting (required): You need to set up the instances for the device.
- d) Length (required): Each input/output instances has its own data length. Refer to its user manual and input the data length in. If the data here is incorrect, the connection may fail to be created.
- e) Input/output Transfer Format: For common use, input: Pure data; output: 32-bit run or Idle header.
- f) Port: No need to change anything here.
- g) Config Data: Refer to its user manual and size value in.

9.4.5.4 I/O Parameters

- Click **Data Exchange** tab and click the Data Exchange device. After that click **Edit** to open the data exchange setting page.
- Set the data exchange interval time in RPI to have Scanner and Adapter to exchange data at a regular time interval, for example, every 20 ms.

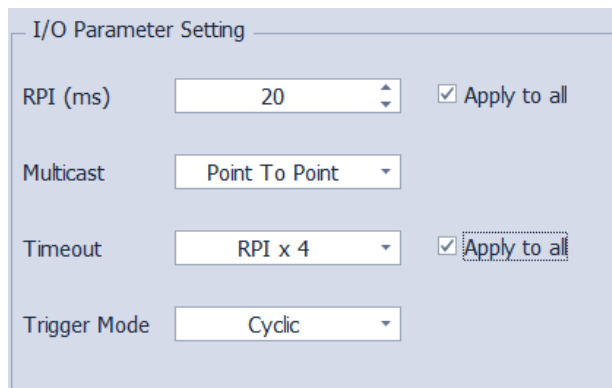

9.4.5.5 Download Parameters

- Click **Download** on the tool bar of the EtherNet/IP page to open the Download setting page.

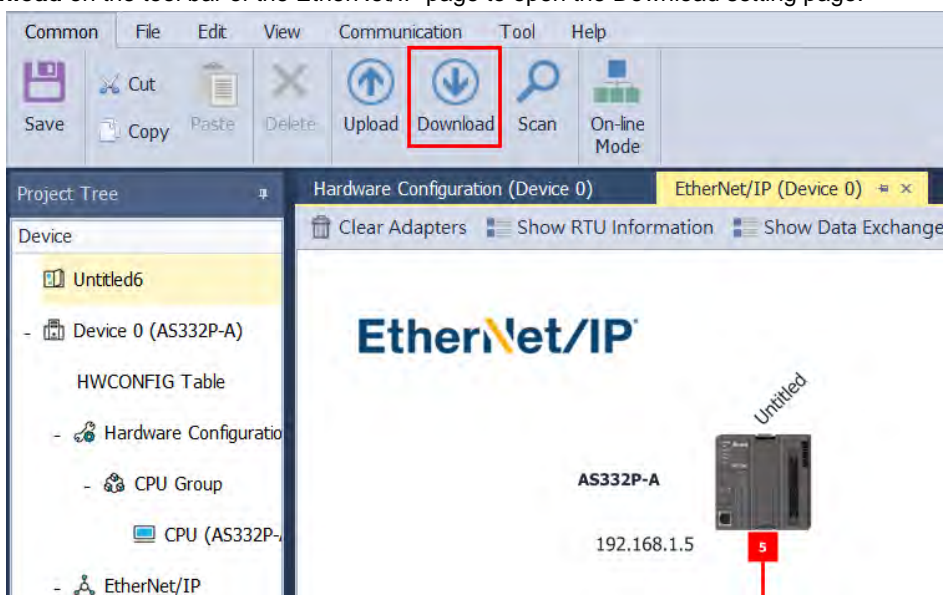

9.4.5.6 Listen Only Connection

When using Listen only connection, multiple devices can read the same data from one EIP Adapter, but only one device can write data into the EIP Adapter. This type of connection is the least-frequently used. Setting steps are as follows.

1. Create a dual connection (input/output) between one Exclusive Owner and EIP Adapter.
2. When creating a connection to EIP Adapter, you need to select the corresponding Listen only connection. For example, when the Exclusive Owner is using Connection 1, you need to select Connection 1_ Listen only.

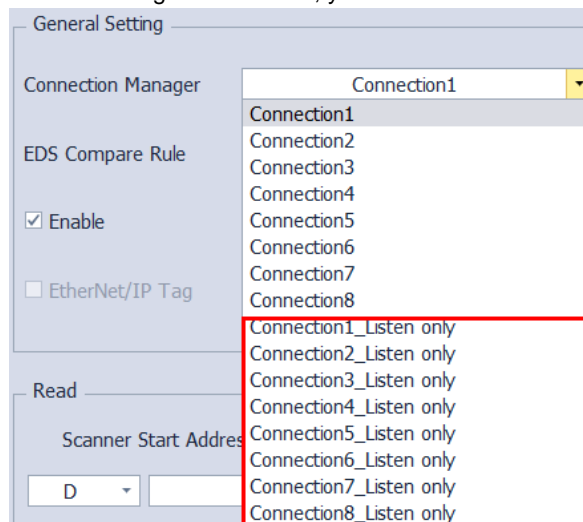

3. When the connection is established, the Exclusive Owner can read/write data on EIP Adapter. For Listen only connection, the device can read data that is as what the Exclusive Owner reads. But the device cannot write data into the EIP Adapter.
4. When the connection of Exclusive Owner and the EIP Adapter is disconnected, the Listen only connection will be closed too. After the connection of Exclusive Owner and the EIP Adapter is reconnected, the Listen only connection will be resumed.

9.4.6 EtherNet/IP Tags

EtherNet/IP Tag can be used for data transfer among different controllers. Create the tags from global symbols in ISPSOft. And then you can use tags to communication with Delta HMI and the 3rd party devices while they are attached to the same EtherNet/IP network.

- Tags can be further defined as Produced Tag and Consumed Tag.
 - Produced Tag: a tag that a controller makes available for other controller. Multiple controllers (EIP scanner devices) can simultaneously consume (receive) the data. A produced tag sends its data to consumed tags (consumers).
 - Consumed Tag: a tag that receives the data of a produced tag. The data type of the consumed tag and the produced tag must be matched (including any array dimensions).
- Before connecting to a Produced Tag, you should check the IP address and the names of the tags (Produced Tag and Consumed Tag). One controller can have multiple Tags created, including produced Tag and consumed Tag. See the example below:

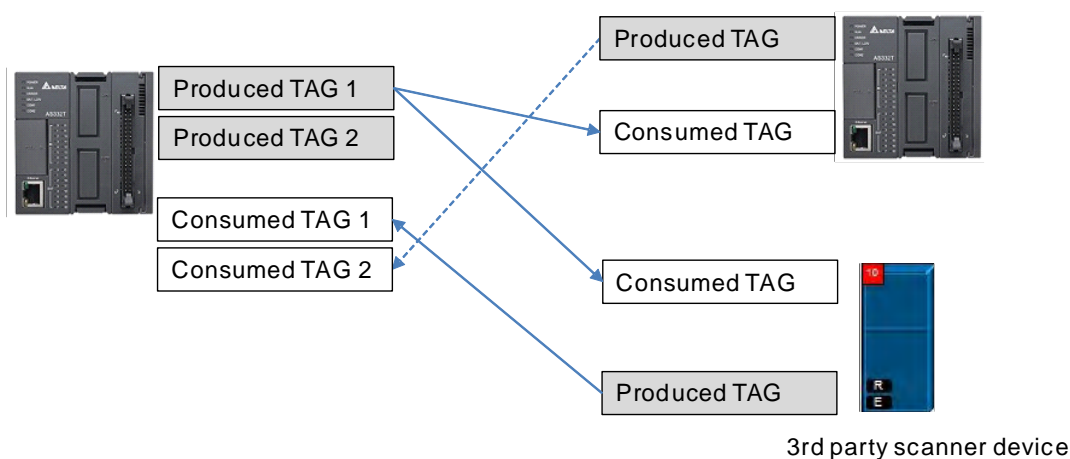

- The following Delta products support Tag function:
 - AS Series PLC CPU: V1.08.20 or later
 - ISPSOft software: V3.09 or later
 - DOPSoft software (Delta HMI editing software for DOP-100 series): V4.00.07 or later

● Creating symbols as tags in ISPSOft

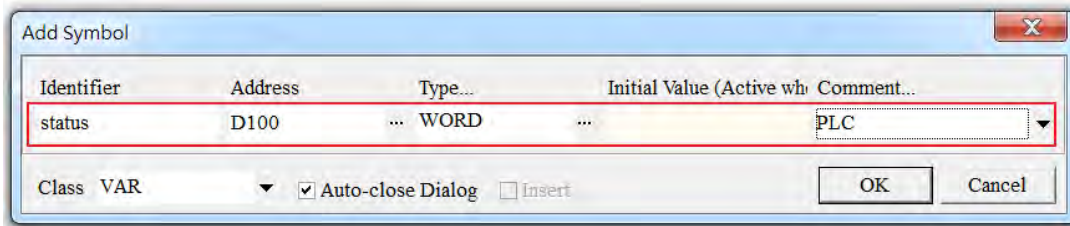

Name	Description
Identifier	User can create a name for the tag in the PLC; up to 40 characters can be used.
Address	The address is corresponding to the registers or bits in the PLC; selections are data register and M bits.
Data Type	The data type BOOL, WORD, DWORD, INT, DINT, REAL, and ARRAY are supported. One-dimensional array is supported; up to 512 byte can be used.
Initial Value	N/A
Comment	Descriptions can be added to describe the Tag; up to 128 characters are supported.

9.4.6.1 Produced Tag

How to create a Produced Tag:

1. Open the ISPSOft software and unfold the Global Symbols item to see the EtherNet/IP Table (Produced Tag) and EtherNet/IP Table (Consumed Tag). Double click the EtherNet/IP Table (Produced Tag).

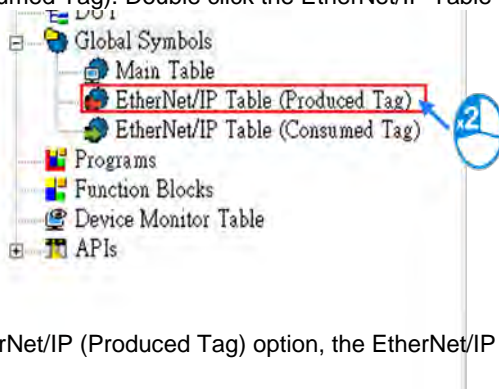

2. After double clicking the EtherNet/IP (Produced Tag) option, the EtherNet/IP Table (Produced Tag) will show up for editing.
3. Right click on the EtherNet/IP Table (Produced Tag) to see the context menu and select the option “Add a Symbol”. And then an Add Symbol window will appear.

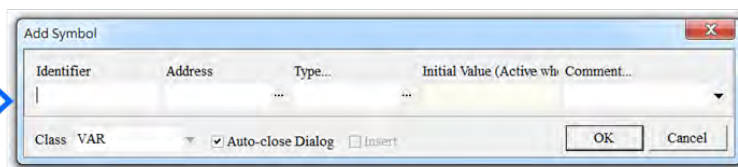
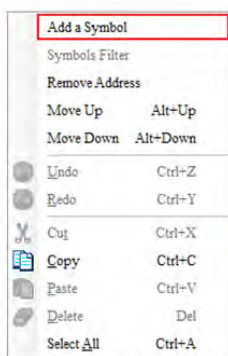

4. Set up the Produced Tag: as the example shown below.

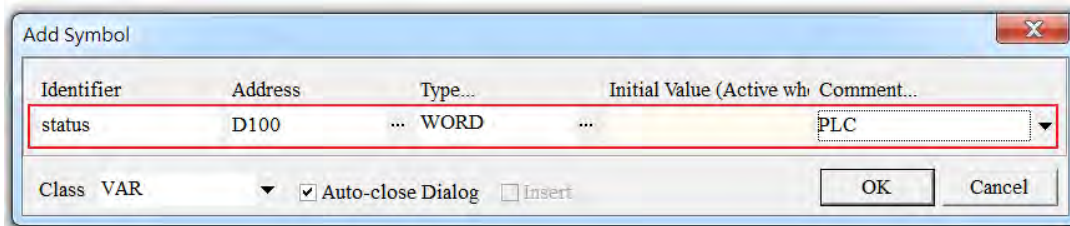

After the setups are complete, download the parameters to the PLC. Other controllers can receive the data of a produced tag via the consumed tag. For the creation of a consumed Tag, refer to the manual from the controller to be used for data transmissions.

Example of using DOP-100WS to read the Produced Tag created by AS332P.

1. Create Produced Tag in ISPSOFT.

VAR	From_AS_D0_A_20	D0	ARRAY [20] OF WORD	N/A	
VAR	From_AS_D50	D5000	WORD	N/A	

2. Right-click on blank area to bring out the context menu. Click Export Global Symbol in ISPSOFT.

3. Open DOPSOFT and select Communication Settings under Options tab.

DOPSOFT - EIP_TAG - [Screen_1]

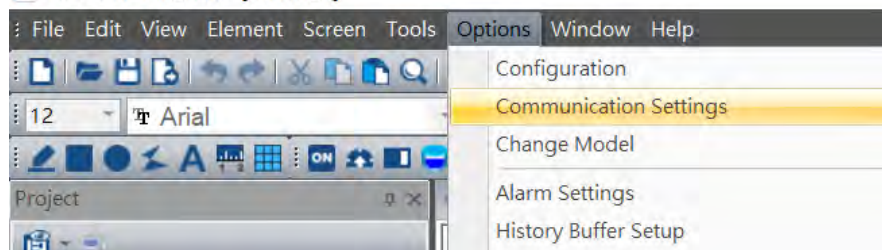

4. Select **00-EtherLink1** and set the controller to **Delta EtherNet/IP (Use Tags)**. After that enter the IP address of AS332P. And then click **Import** to import the .csv file that was exported from the previous step to DOPSOFT.

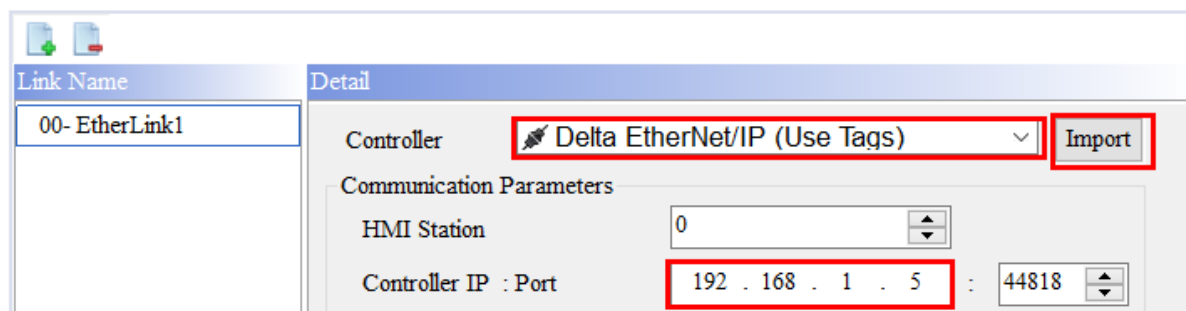

5. Create a component and then you can use the imported tags from the previous step.

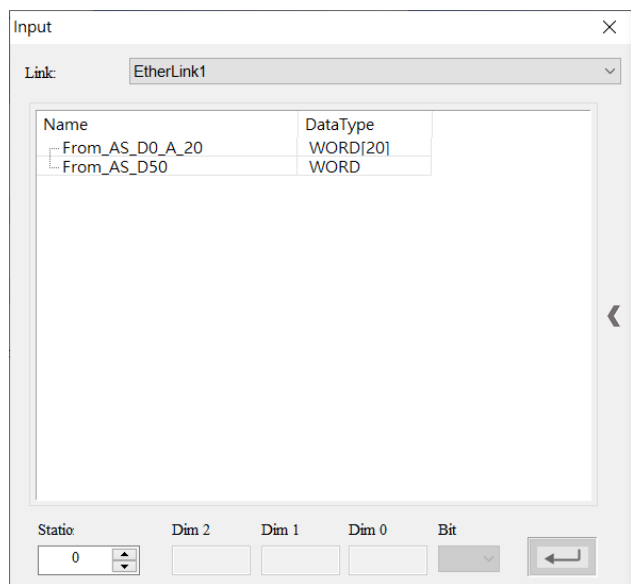

6. After the setting is complete, download the DOPSoft project to HMI.

9.4.6.2 Consumed Tag

The way to create a consumed Tag is the same the way to create a Produced Tag. Refer the section above for more information. After the setups are complete, download the parameters to the PLC, even if using one’s own EIP data exchange table.

9.4.6.3 Use Tag to Execute Data Exchange

1. Make sure Consumed Tag is created. After the ISPSOft project is saved, open HWCONFIG.

VAR	TAG1	D100	WORD	N/A
VAR	TAG2	D500	WORD	N/A

2. Refer to section 9.4.3 to 9.4.4 for adding devices in the network. And then Enter the IP address of the Produced Tag device to be connected. The length of the produced tag and the consumed tag should be exactly the same.

3. Switch to the data exchange setting page.

4. Once you select the Tag check box, the directional arrow is to the left with (←) (READ only)

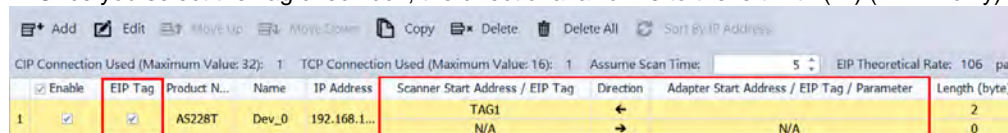

5. Select the created Consumed Tag from ISPSOft and HWCONFIG will bring in the length automatically. It does not require further setting.

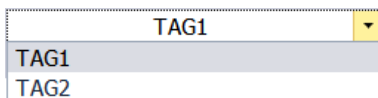

6. Enter the Produced Tag name of the remote device in the Adapter’s EIP tag table. After that you can download the EIP tag table in HWCONFIG.

7. For the 3rd party device, after importing the EDS file, the procedures of using tags to perform data exchange are the same. EDS file. If there is no EDS file, you can use **General Device** to set up. The only requirement is the IP address, no need to set up input, output, instances, you can use tags to perform data exchange.

9.4.7 Diagnosis

HWCONFIG provides diagnostic information on the connection and data exchange status. For the connection status, refer to the Adapter connection status and indicator. For data exchange status and error codes, refer to Data Exchange tab.

First, click On-line Mode on the tool bar.



◆ Connection Status

- a) Check the device status from the indicators: for example RUN / STOP and Error indicators for the PLC.

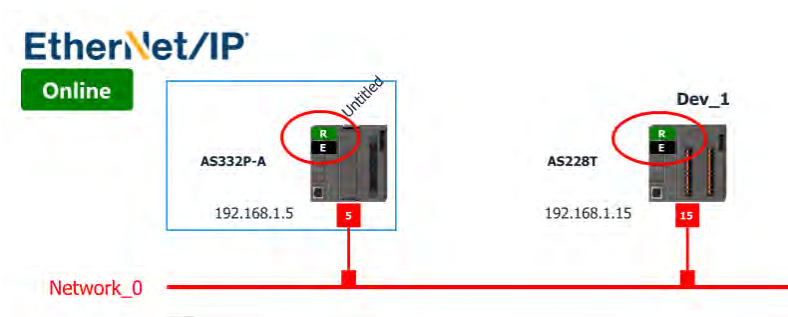

- b) The status of connection has nothing to do with EtherNet/IP data exchange. It is the network connection status. HWCONFIG sends an ICMP request (ping) to devices, if nothing returns, it is seen as disconnected from the network. The dotted line and the warning sign indicate a connection error, as shown below.

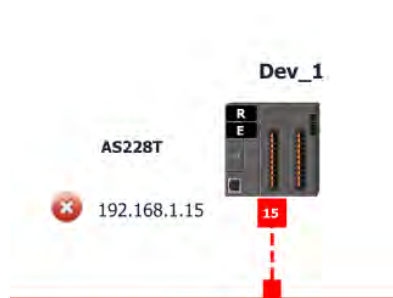

◆ Data Exchange

a) Normal communication:

CIP Connection Used (Maximum Value: 32): 1 TCP Connection Used (Maximum Value: 16): 1 Assume Scan Time: 5 EIP Theoretical Rate: 106 packet per second (PPS)											
Status	Message	Enable	EIP Tag	Pr...	N...	IP Address	Scanner Start Address / EIP Tag	Direction	Adapter Start Address / EIP Tag / Parameter	Length (byte)	
1	-	<input checked="" type="checkbox"/>	<input type="checkbox"/>	AS...	De...	192.168.1.15	D0 D0	← →	D1000 D0	200 200	

b) Error occurs during communication. Check the data exchange status and the error codes. For error code definitions, refer to Section 9.6.2.

CIP Connection Used (Maximum Value: 32): 1 TCP Connection Used (Maximum Value: 16): 1 Assume Scan Time: 5 EIP Theoretical Rate: 106 packet per second (PPS)											
Status	Message	Enable	EIP Tag	Pr...	N...	IP Address	Scanner Start Address / EIP Tag	Direction	Adapter Start Address / EIP Tag / Parameter	Length (byte)	
1	The connection timeout. (16#0203)	<input checked="" type="checkbox"/>	<input type="checkbox"/>	AS...	De...	192.168.1.15	D0 D0	← →	D1000 D0	200 200	

9.5 Explicit Message

All connections in EtherNet/IP can be divided into explicit messaging connections and implicit (or I/O) messaging connections. Explicit messaging uses TCP/IP and request/response communications or client/server connections, requiring that the instruction include the memory location of the data to be sent to the client. Implicit messaging uses UDP/IP, in which a server sends information from predefined memory locations to a client at a given interval, using a requested packet interval (RPI) parameter to specify the interval. For details on using implicit messages, please refer to Section 9.4.5. This section provides an overview of how the AS Series uses explicit messaging instructions.

When EtherNet/IP uses CIP Objects as parameters and the AS Series PLC CPU acts a Scanner, you can use the EIPRW instruction (API 2208) to read and write Adapter's objects. Each object includes various parameters, you need to obtain relative object parameters from the Adapter's manual. For details on the EIPRW instruction (API 2208), please refer to the AS Series Programming Manual. For details on Objects that are supported by the AS Series, please refer to Section 9.8.

9.6 Troubleshooting

This section provides an overview of error codes and troubleshooting for the AS Series.

9.6.1 Error Code Classification

There are two types of error code categories for the AS Series: Configuration Errors, and Application Errors. These error codes are defined by the ODVA for EtherNet/IP errors. Refer to the following table for AS Series error codes.

Error Code Classification		Description
1 st Phase	2 nd Phase	
Category	Item	
Configuration error	EDS files mismatched	Mismatched EDS files lead to I/O connection failure. *
	Data exchange setup error	Data exchange setup error lead to I/O connection failure. *
Application error	Ethernet/IP error	EtherNet/IP communication failure *

* Only the last 2 bytes of the error code are shown; for example, only 011C appears for the error code H'1101011C.

9.6.2 Error Codes & How to fix them

9.6.2.1 Configuration Errors

(HWCONFIG only shows Low word error codes)

Category	Error Code	Description	How to fix them
EDS Files Mismatched	H'1101011C	The Transport Class field values of the Transport Class and Trigger in the EDS file are mismatched.	<ol style="list-style-type: none"> 1. Check if the product information and the EDS file match. 2. Reload the EDS file. 3. Ask the vendor of the device for the EDS file.
	H'11010114	The Vender ID or the Product Code in the EDS file is mismatched.	<ol style="list-style-type: none"> 1. Check if the product information and the EDS file match. 2. Reload the EDS file. 3. Ask the vendor of the device for the EDS file.
	H'11010115	The device type parameters in the EDS file are mismatched.	<ol style="list-style-type: none"> 1. Check if the product information and the EDS file match. 2. Reload the EDS file. 3. Ask the vendor of the device for the EDS file.
	H'11010116	The revision parameters in the EDS file are mismatched.	<ol style="list-style-type: none"> 1. Check if the product information and the EDS file match. 2. Reload the EDS file. 3. Ask the vendor of the device for the EDS file.
	H'1101011E	The direction parameters in the EDS file are mismatched.	<ol style="list-style-type: none"> 1. Check if the product information and the EDS file match. 2. Reload the EDS file. 3. Ask the vendor of the device for the EDS file.
	H'1101011F	The fixed / variable output flag in the EDS file is mismatched.	<ol style="list-style-type: none"> 1. Check if the product information and the EDS file match. 2. Reload the EDS file. 3. Ask the vendor of the device for the EDS file.
	H'11010120	The fixed / variable input flag in the EDS file is mismatched.	<ol style="list-style-type: none"> 1. Check if the product information and the EDS file match. 2. Reload the EDS file. 3. Ask the vendor of the device for the EDS file.
	H'11010121	The output priority in the EDS file is mismatched.	<ol style="list-style-type: none"> 1. Check if the product information and the EDS file match. 2. Reload the EDS file. 3. Ask the vendor of the device for the EDS file.

Category	Error Code	Description	How to fix them
	H'11010122	The input priority in the EDS file is mismatched.	<ol style="list-style-type: none"> 1. Check if the product information and the EDS file match. 2. Reload the EDS file. 3. Ask the vendor of the device for the EDS file.
	H'11010123	The output connection type parameters in the EDS file are mismatched.	<ol style="list-style-type: none"> 1. Check if the product information and the EDS file match. 2. Reload the EDS file. 3. Ask the vendor of the device for the EDS file.
	H'11010124	The input connection type parameters in the EDS file are mismatched.	<ol style="list-style-type: none"> 1. Check if the product information and the EDS file match. 2. Reload the EDS file. 3. Ask the vendor of the device for the EDS file.
	H'11010125	The redundant ownership output parameters in the EDS file are mismatched.	<ol style="list-style-type: none"> 1. Check if the product information and the EDS file match. 2. Reload the EDS file. 3. Ask the vendor of the device for the EDS file.
	H'11010126	The configuration size parameters in the EDS file are mismatched.	<ol style="list-style-type: none"> 1. Check if the product information and the EDS file match. 2. Reload the EDS file. 3. Ask the vendor of the device for the EDS file.
	H'11010129	The configuration path parameters in the EDS file are mismatched.	<ol style="list-style-type: none"> 1. Check if the product information and the EDS file match. 2. Reload the EDS file. 3. Ask the vendor of the device for the EDS file.
	H'11010132	The EDS file does not support Null forward open.	<ol style="list-style-type: none"> 1. Check if the product information and the EDS file match. 2. Reload the EDS file. 3. Ask the vendor of the device for the EDS file.
Data Exchange Setup Error	H'12010100	I/O connections duplicated	<ol style="list-style-type: none"> 1. Check if the system has created the I/O connections. 2. Change the connection type to Listen Only.
	H'12010106	Scanner ownership of I/O connections conflicts	<ol style="list-style-type: none"> 1. Check the scanner owner. 2. Reconfigure the invalid scanner. 3. Change the connection to multicast.
	H'12010110	Incorrect adapter configuration	<ol style="list-style-type: none"> 1. Check the I/O connection status. 2. Activate the I/O connections again.

Category	Error Code	Description	How to fix them
	H'12010111	Adapter RPI not supported	3. Check the RPI for the adapter.
	H'12010113	Insufficient I/O connections	1. Check if the number of connections exceeds the limit. 2. Reduce the number of the product connections.
	H12010119	The connection of non-Listen only is not established.	1. Check if the system has created the I/O connections. 2. Check the scanner I/O connection status.
	H'12010127	Incorrect adapter input size	Check the module number and the product setup file to see if they match.
	H'12010128	Incorrect adapter output size	Check the output size in the connection parameters.
	H'1201012D	Consumed Tag does not exist.	Check if the parameters in the Consumed tag are set correctly.
	H'1201012E	Produced Tag does not exist.	Check if the parameters in the Produced tag are set correctly.
	H'12010204	I/O connection connecting timeout	No response from the adapter; check if the power and the network connection for the adapter are working properly.
	H'12010302	Network bandwidth NOT available for data	1. Check the I/O connection limit between the scanner and the adapter. 2. Increase the RPI value or reduce the number of connections.
	H'12010315	Incorrect adapter input/output instance	Check the module number and the product setup file to see if they match.

9.6.2.2 Application Error

Category	Error Code	Description	How to fix them
EtherNet/ IP Error	H'00010203	I/O connection timeout	1. Check the network connection status. 2. Check if the module is working properly. 3. Increase the RPI value.

9.6.3 AS-FPFN02 Error Codes & How to fix them

9.6.3.1 LED Indicators

Description	Procedure
System Fail (SF) indicator RED light ON	Check if the parameters downloaded to the Controller are the same as the actual placement
Bus Fail (BF) indicator RED light BLINKING	<ol style="list-style-type: none"> 1. Check if the upper device is well-connected 2. Check if the device name set in the software is the same as the device name shown in the function card 3. Check if the MAC address and the device name are assigned correctly
Bus Fail (BF) indicator RED light ON	<ol style="list-style-type: none"> 1. Check if the network cable is securely connected 2. Check if the controller and the function card are both supplied with power

9.6.3.2 Status Registers of Siemens S7-1500

Status Register (Siemens S7-1500)	Description
Input Data Available %I0.0	<p>If the value is TRUE, the input data is valid.</p> <p>If the value is 0, the input data is invalid.</p> <p>Check if the AS300 firmware version is V1.08 or higher.</p>
Connection Status %I4.0 - %I4.7	<p>Indicates PN connection status of Slot 1 ~ Slot 8.</p> <p>If the value is TRUE, the Slot is with a working PN connection (with IO module)</p> <p>If the value is FALSE, the Slot is without a working PN connection.</p>
Connection Status %I5.0 - %I5.7	<p>Indicates PN connection status of Slot 9 ~ Slot 16.</p> <p>If the value is TRUE, the Slot is with a working PN connection (with IO module)</p> <p>If the value is FALSE, the Slot is without a working PN connection.</p>

9.7 Software Operation

This section provides an overview using Ethernet/IP to connect to a Delta Ethernet/IP PLC with third party software.

9.7.1 Operation Demonstration I

The example EIP Scanner uses Ethernet to connect to a Delta Adapter.



9.7.1.1 Creating a New Project and a Scanner

1. Open the editing software and under **Create**, click **New Project**.
2. Select a PLC and select the chassis.
3. Click **Finish** to create the new project.
4. After creating the project, Studio 5000 displays the Controller Organizer and workspace.
5. Add the Ethernet/IP module, and then connect to the Ethernet/IP devices through the Ethernet/IP module.

9.7.1.2 Connecting to Delta Adapter

This section provides an overview of connecting to a Delta Ethernet/IP Adapter with the example software.

- Import an EDS file from Delta Official Website
 1. Under the **Tools** menu, click **EDS Hardware Installation Tool**.
 2. Select **Register an EDS file(s)** and click **Next**.
 3. Select **Register a single file** and click **Browse** to find the EDS file to import.
 4. Follow the instructions in the wizard and then click **Finish** to complete importing the EDS file.
- Creating an Adapter
 1. In example software, in the Controller Organizer under EtherNet/IP Scannerr, right-click **Ethernet** and then click **New Module**.
 2. Type the module number of the imported Delta EDS file in the filter field, click the Delta module, and then click **Create**.
 3. Verify that the product name and IP address are the same as the information shown in the **Module Definition** section.
 4. Click **Change** if you need to make a change to the module definition.

5. Modify the module definition
 - 1) Name: Click the arrow button to select a valid connection.
 - 2) Size: The example PLC supports maximum 500 bytes data size. (Data for input contains 2 bytes of Serial Number and for output contains 4 bytes 32-bit Run-idle header and 2 bytes of Serial Number.) If using AS300, you can set the maximum data length 498 SINT for input and 494 SINT for output.
 - ※ In general, there is no need to change the parameters from the imported EDS files which can usually be used without modification.
6. In the New Module dialog box, click the **Connection** tab to modify the **Requested Packet Interval** and **Input Type** settings. The RPI uses the I/O connection to a Scanner to exchange data at regular intervals, and the units are micro-seconds. For **Input Type** select either **Unicast** or **Multicast**. The Input Type selections may vary for different products.
7. Click **OK** to create the adapter. The new Delta Adapter appears in the Controller Organizer tree.

9.7.1.3 Editing Corresponding Addresses for AS300

Refer to section 9.8.5 Assembly Object for defaults of exchange address. Refer to section 9.7.1.5 on how to open Program Tag and modify the contents of Tag:C to edit the exchange addresses. Refer to section 9.8.5 Assembly Object for details on Tag:C.

You can edit the corresponding addresses of input and output for each connection through Configuration.

Configuration address	Data type	Description	Defaults (Connection 1)
Word[0]	UINT	Corresponding components for input 0: D, 1: X, 2: Y	0
Word[1]	UINT	Reserved	200
Word[2-3]	DWORD	Number of corresponding component for input	1000
Word[4]	UINT	Corresponding components for output 0: D, 2: Y	0
Word[5]	UINT	Reserved	200
Word[6-7]	DWORD	Number of corresponding component for output	0

9.7.1.4 Download

The next step is to download the project to the PLC and go online.

1. In Studio 5000, on the **Communications** menu, click **Who Active**. To establish a connection, select the Scanner connected to the PC, and then on the **Communications** menu click **Download**.
2. After the connection is successfully established, the I/O status shows green by **I/O OK**.

9.7.1.5 Data Exchange

In the Controller Organizer, you can map data, including Configuration, Input and Output parameters. When you create a device I/O Configuration, the tags are added automatically.

1. Click **Program Tags** to display the Tags window.
2. Tags are listed in the **Name** column. Tag names begin with a product name and end with **C** or **I1** or **O1**, separated from the name by a colon (:).
3. Tag name : C indicates the tag contains information from the Adapter EDS file, including Input and Output parameters (refer to section 9.7.1.3). You can edit these parameters in the example software.
4. Tag name : I1 indicates that the exchange starts from Tag : I1[0], and is mapped to the first parameters of the Adapter output. The length is the output length provided by the Adapter.
5. Tag name: O1, indicates that the exchange starts from Tag : O1[0], and is mapped to the first parameters of the Adapter Input. The length is the input length provided by the Adapter.

9.7.2 Operation Demonstration II

Delta EtherNet/IP PLC connects to the example EtherNet/IP Adapter through Ethernet communication.

9.7.2.1 Tag Connection

This section demonstrates how to use Tag Connection to execute EtherNet/IP communication with the example PLC. Firstly create Produced Tag from the example PLC and then create Consumed Tag from Delta PLC.

- **Create Produced Tag**

1. Start the example software Sysmac Studio. Select **Connect to Device**. Configure the parameters and then click **Connect**.
2. After the connection is successfully established, click **Tools** on the menu bar. And then select **EtherNet/IP Connection Settings** to access the EtherNet/IP connection settings.
3. Right-click the cell of the Node Address you'd like to edit its EtherNet/IP settings and then select **Edit** to open the EtherNet/IP communication setting window.
4. Double-click **Global Variables** under **Programming - Data** in the Multiview Explorer. Right-click in the global variable table and select **Create New** from the menu.
5. Right-click in the global variable table and select **Create New** from the menu.
*Click **Controller** on the menu bar and change the **Project** to **Disconnected** before creating a new global variable.
6. Set the Network Publish to **Output**.
And then with this attribute, you can access a variable from external devices through CIP communications or a tag data link. For tag data links, this can be a variable for data output (from the local Controller to another Controller).
7. Select the tab of **Built-in EtherNet/IP Connection Settings** and select the **Tag Set** from the left. Right-click in the editing area and select **Create New Tag Set** from the menu and then name the tag set as ToAS. Data type: ARRAY[0..99] OF WORD.
8. Right-click on the created Tag Set and select **Create New Tag** from the menu.
9. The tag is added in the created tag set.
10. Click **Controller** and then **Synchronize...** from the menu bar to synchronize the setting with OMRON Scanner.
11. Create Tag sets in **Network Configurator**. Open **Network Configurator** and *select Option-> Select Interface-> Ethernet I/F*.
12. *Select Network -> Connect*
13. Select **Interface** and click **OK** to confirm the setting.
14. The blue light indicates the connection is working normally.
15. Drag the example PLC from the EtherNet/IP Hardware section to the network view.
16. Right-click the example PLC (the scanner) and **select Parameter -> Edit** from the menu.
17. Click **Edit Tags** on the **Tag Sets** tab and click **New** on the **Out-Produce** tab to create a new tag with the same name and length as the one from the "output" tag set in Sysmac. Set the size of ToAS to 200 bytes.
18. The new tag is created.
19. After setting, click *Network -> Download*.
20. After downloading, the Network Configurator dialog box is displayed.

● **Create a Consumed Tag**

1. Start ISPSOft and click *Tools -> Communication Settings* and select a driver with Ethernet communication.
 - ※ Before setting the communication, make sure COMMGR is working normally and save the driver settings.

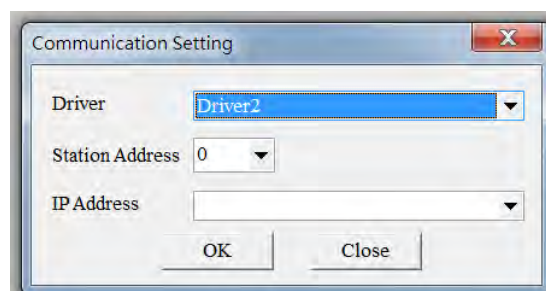
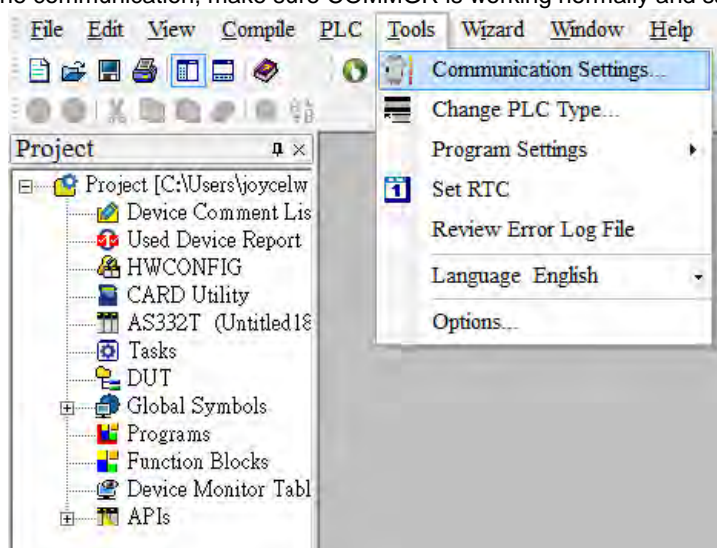

2. Click **Global Symbols** to expand the tree node and see the options. Double-click **EtherNet/IP Table (Consumed Tag)** from the Project section on the left. Right-click the blank area and select **Add a Symbol**.

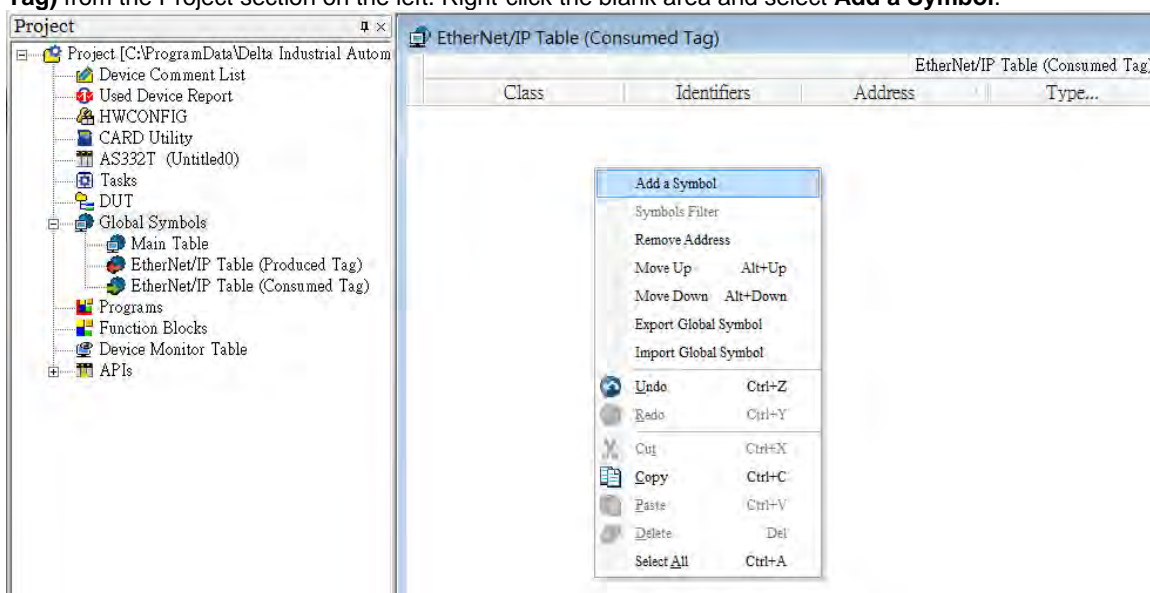

3. Set the data type to **ARRAY[200] OF WORD** and then click **OK** to confirm the setting.
- ※ Data size should be the same as the Produced Tag data size set in the scanner.

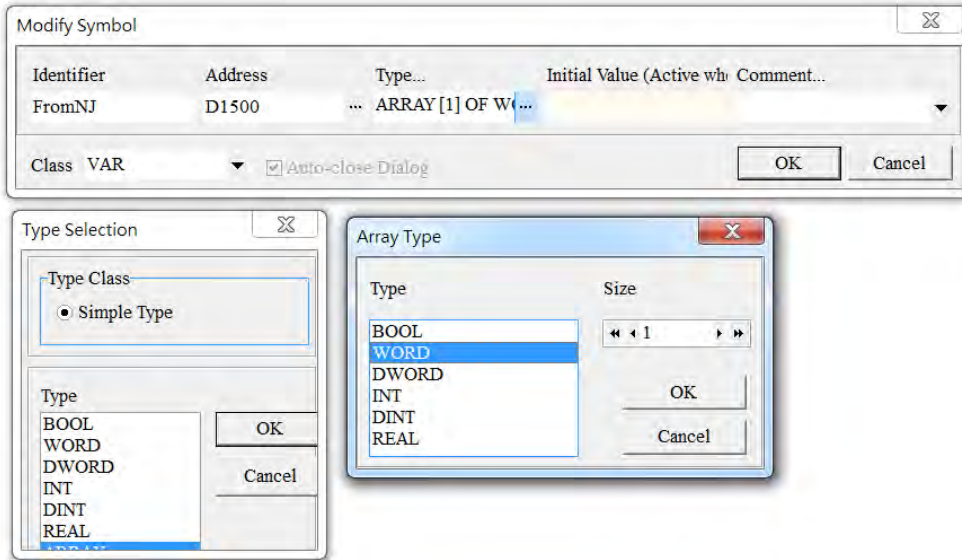

A symbol is added, as the image shown below.

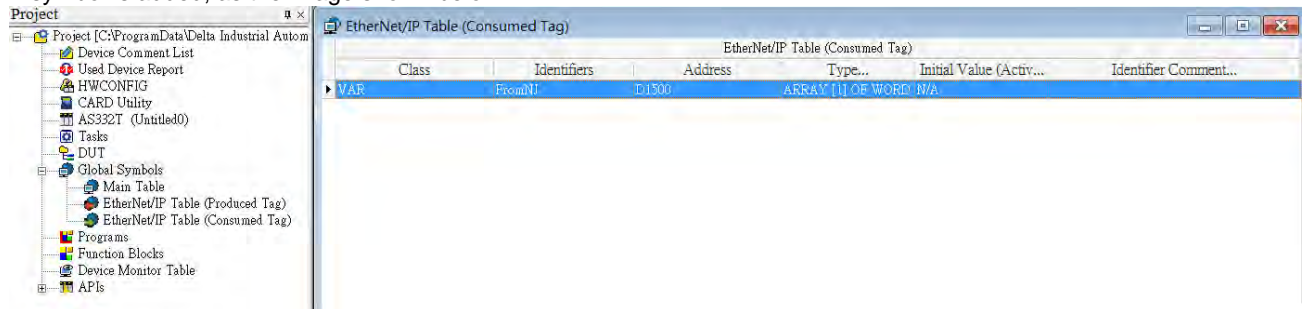

4. Go to **PLC-> Transfer -> Download** to download the parameters to the Scanner.

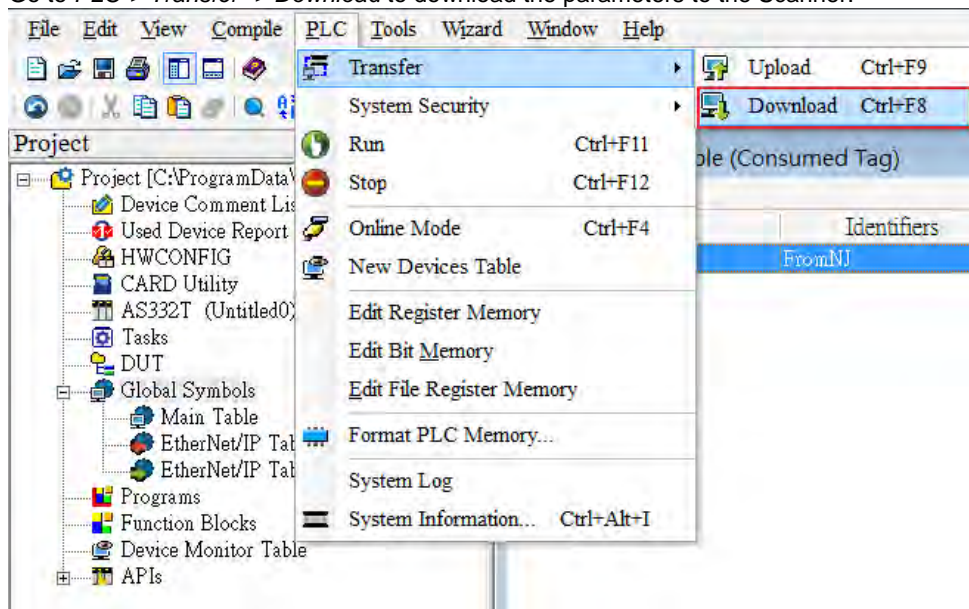

- Double-click **HWCONFIG** from the Project section on the left to start HWCONFIG.

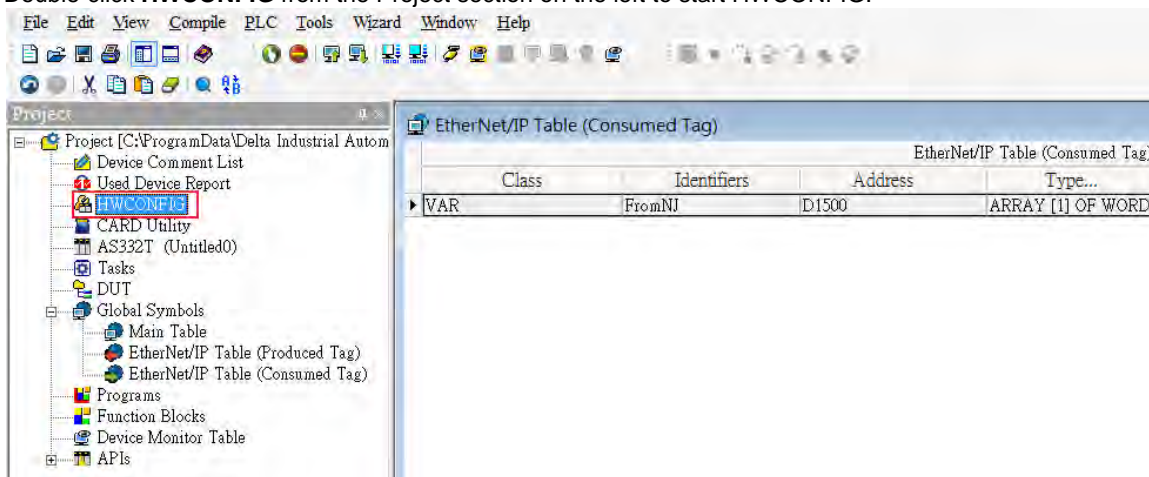

- Right-click the **PLC** and select **Communication Software -> EIP Builder** to start EIP Builder.
For ISPSOft V3.12 or later, you can edit EtherNet/IP communication parameters in HWCONFIG.

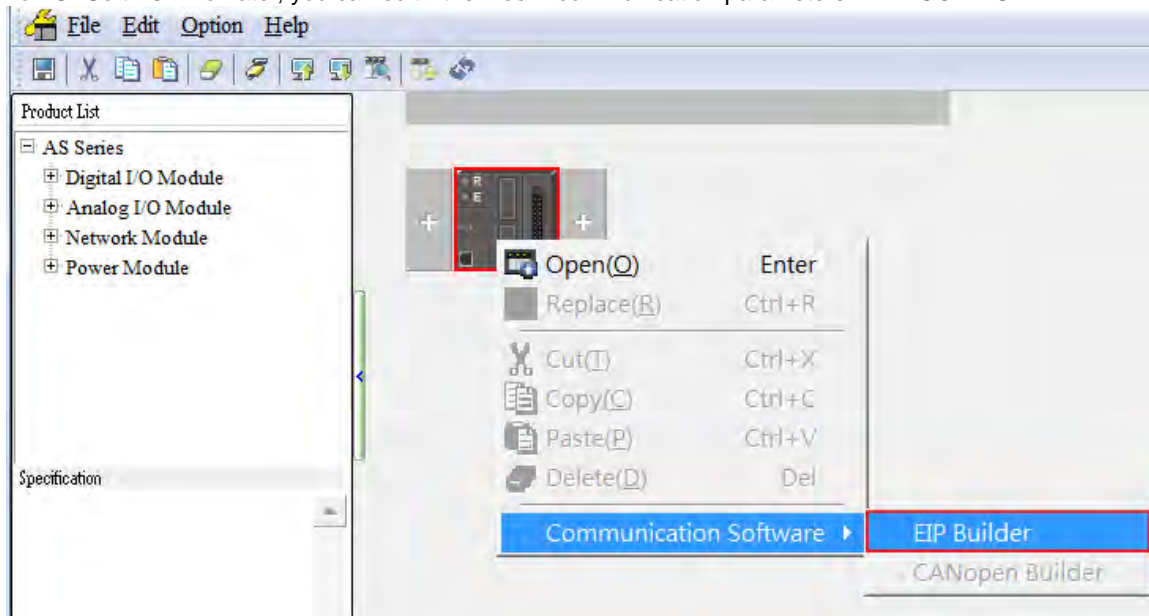

- Click **Tool-> DDF(EDS) Manager** to import the EDS File.

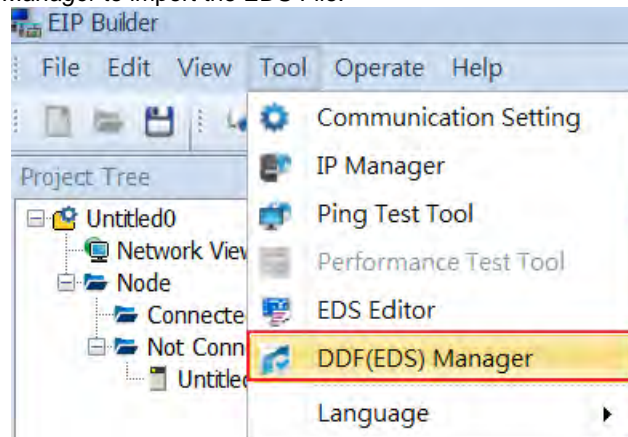

8. Drag and drop the device from the Product List on the right to add have it added in the Network View.
- ※ You can select the device and click the **Information** tab to edit its IP address.

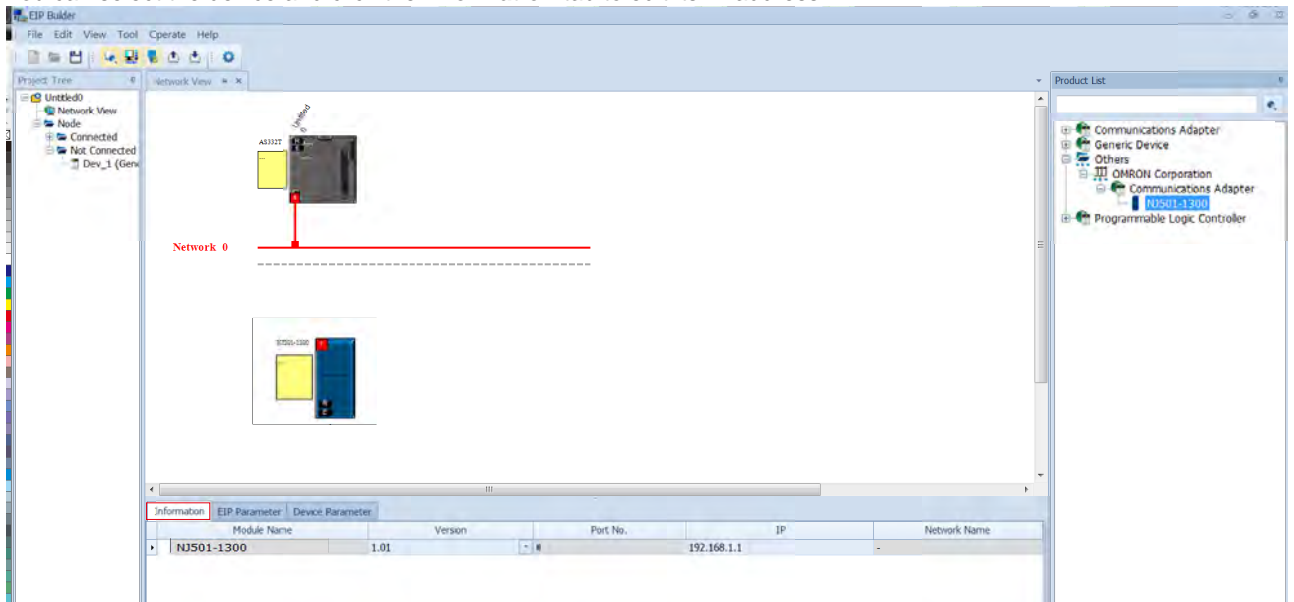

9. Drag and drop the red spare to have the Ethernet communication port connected to the network.

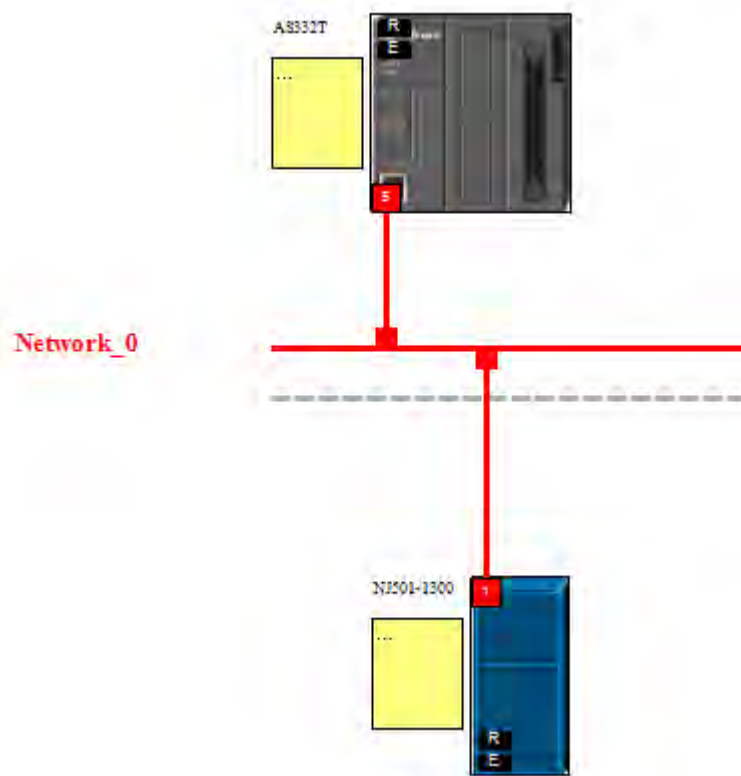

- Right-click the CPU's communication port and select **Data Exchange** to create a data exchange table.

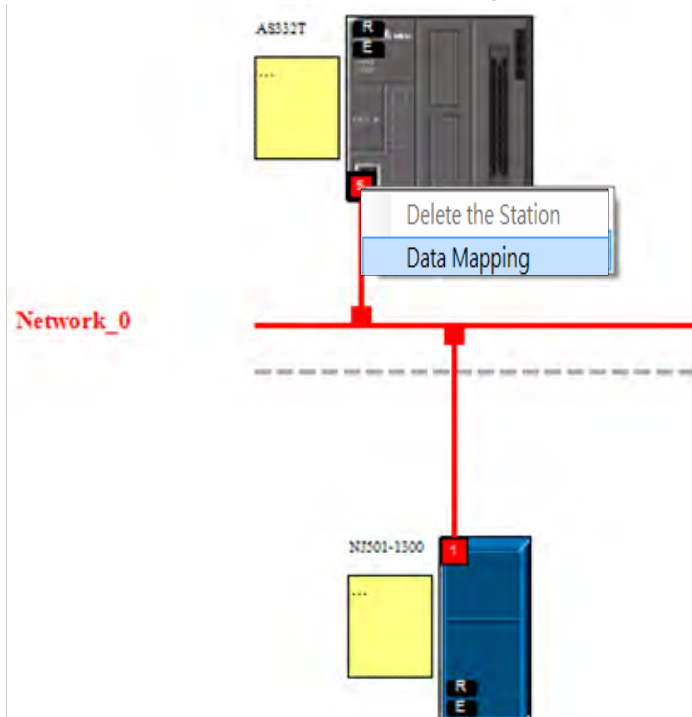

- Make sure the data below CPU Address/Tag and Adapter/Tag is correct.

※ CPU Address/Tag: Consumed Tag

Adapter /Tag: Produced Tag, created by Producer

The screenshot shows a software window titled 'Network View' with a sub-window 'Network_0'. The network diagram is identical to the one above. Below the diagram is a table with the following data:

Connection Count	Enable	TAG	IP Address	Adapter Name	CPU Address/TAG	Adapter	Length	Property
1	<input checked="" type="checkbox"/>	<input checked="" type="checkbox"/>	192.168.250.1	User Define	FromNJ	ToAS	2	...

12. Click *Operate*-> *Downloader* to download the parameters to the Scanner.

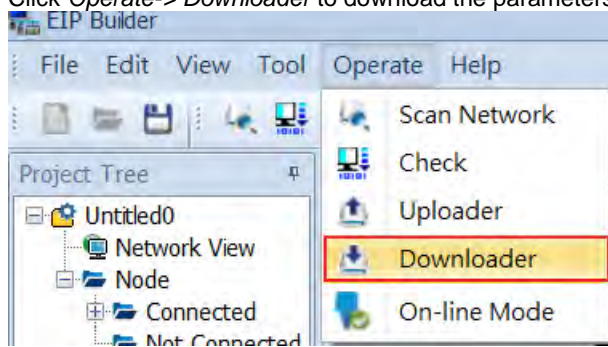

- **Connection Check**

1. Click  to have the project in On-line Mode and see if the network lines are solid ones.

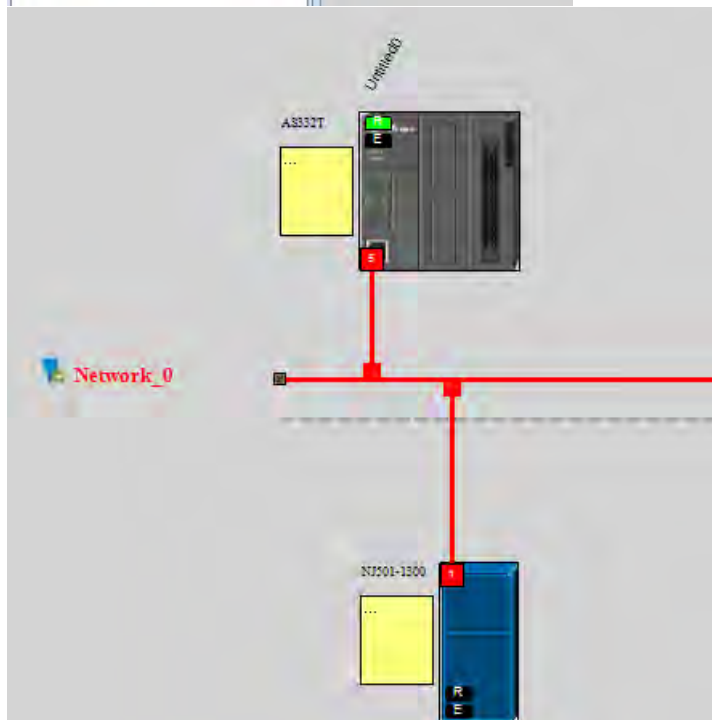
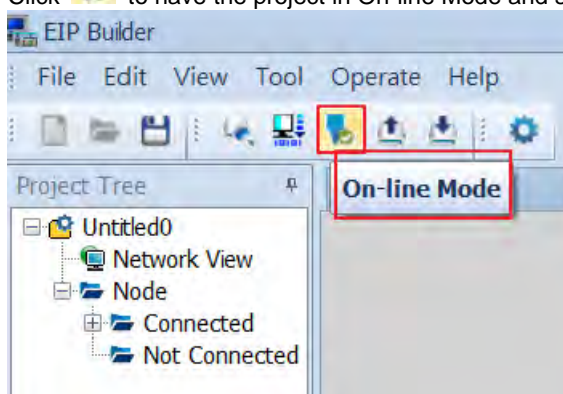

2. The solid network lines indicate the data exchange is being monitored successfully.

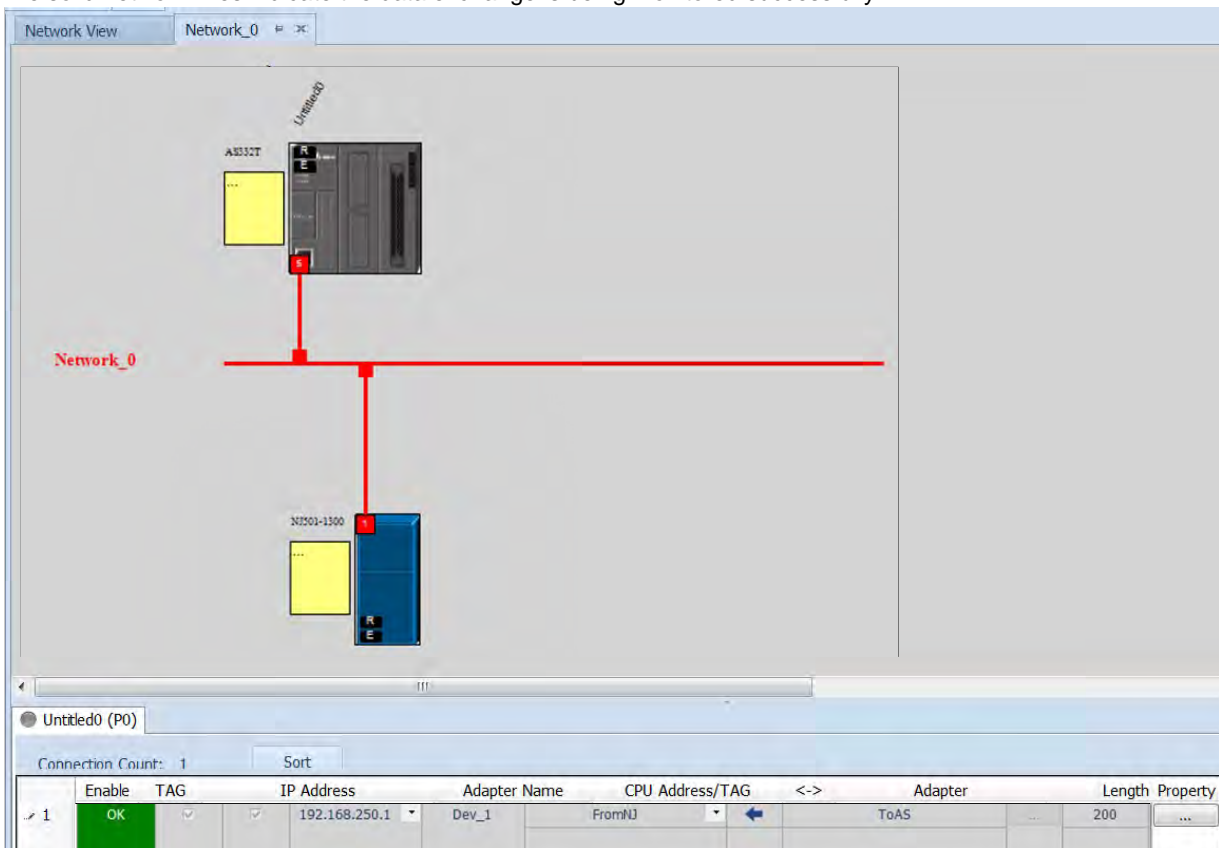

9.7.2.2 IO Connection

This section demonstrates how to use IO Connection to execute EtherNet/IP communication with the example PLC. Here Delta PLC acts as an EtherNet/IP Scanner.

- **Set up an IO Connection from a Slave**

1. Create two variables and set the rule of one variable as **input** and set the rule of the other variable as **output**. Set the data type and length as **Array[0..99] of word**.
2. Go to *Tools -> Export Global Variables -> Network Configurator* on the menu bar.
3. Start **Network Configurator** and then add and edit the example PLC from the **Ethernet Hardware List** on the left. Select *Parameter -> Edit* and click *To/From File -> Export to File* on lower right corner of the Tag Sets page.
4. After the file is imported, make sure the input and output variables are imported in In-Consume and Out-Produce sections.
5. Click the variable in In-Consume section and select **Edit**.
6. Click **Advanced** button in the Edit Tag Set window and set the Instance ID to **Manual** and then input the Instance ID you'd like to use for IDs in In-Consume section. Set Instance ID = 100.
7. Use the same method to set the Instance ID manually for IDs in In-Consume section as you have set for IDs in Out-Produce section. Set Instance ID = 110.
8. When the settings for Instance ID are done, click **OK** to confirm the settings on Edit Device Parameter.
9. Click *Network -> Download* to download the parameters to the slave.

- **Set up an IO Connection from a Master**

1. Start EIP Builder and drag and drop a **General Device** into the Network View area and set up network connection. For ISPSOft V3.12 or later, you can edit EtherNet/IP communication parameters in HWCONFIG.

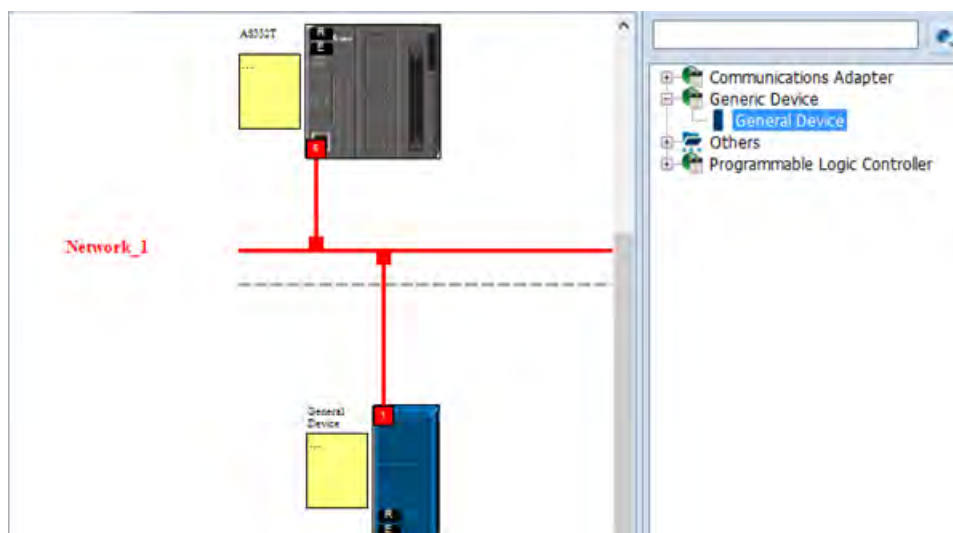

2. Click slave icon and set up its IP address and then configure the parameters in the EIP Parameter tab.

Information	EIP Parameter	Device Parameter				
Module Name	Version	Port No.	IP	Network Name		
General Device	1.01	- 0	192.168.1.1	Network_1		

Name	Value
Electronic keying	Disable Keying
Transport Type	Exclusive Owner
Input	
Assembly instance	101
Size (Byte)	200
Input Transfer Format	Pure data
Output	
Assembly instance	100
Size (Byte)	200
Output Transfer Format	Pure data
Configure	
Assembly instance	128
Size (Byte)	0
Port	
Port Segement Enable	Enable
Port number	1
Link address	0

3. Set up the slave IO connection:
 - a. Master Output Instance ID = Slave Input (In-Consume) Instance ID
 - b. Master Input Instance ID = Slave Output (Out-Produce) Instance ID
 ※ Refer to slave's operation manual for more information on Instance IDs.
4. Set up the connection and start data exchange.

Connection Count	Enable	TAG	IP Address	Adapter Name	CPU Address/TAG	<->	Adapter	Length	Property
1	<input checked="" type="checkbox"/>	<input type="checkbox"/>	192.168.250.1	Dev_1	D0	←	Input	200	...
					D500	→	Output	200	...

5. Download the EIP parameters to the master.

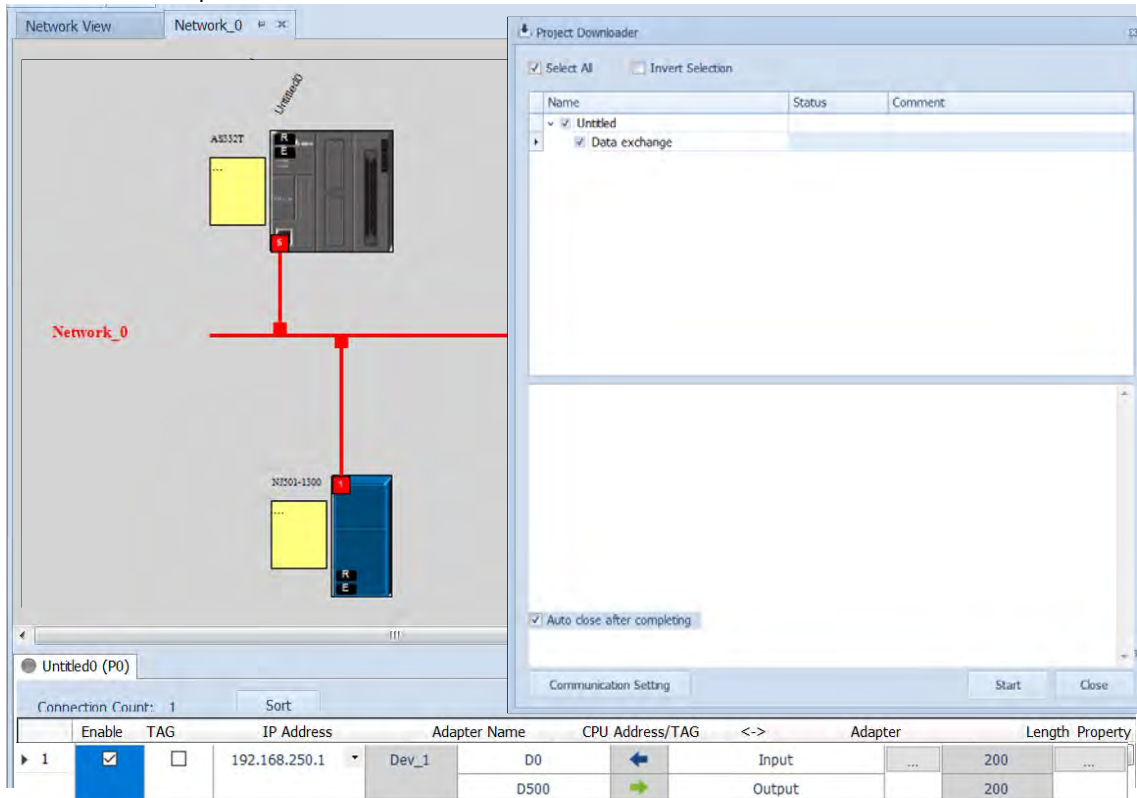

● **Connection status**

1. After the parameters are downloaded, change the project to Online Mode. And make sure the monitoring on the network and the data exchange table is normal.

Network View

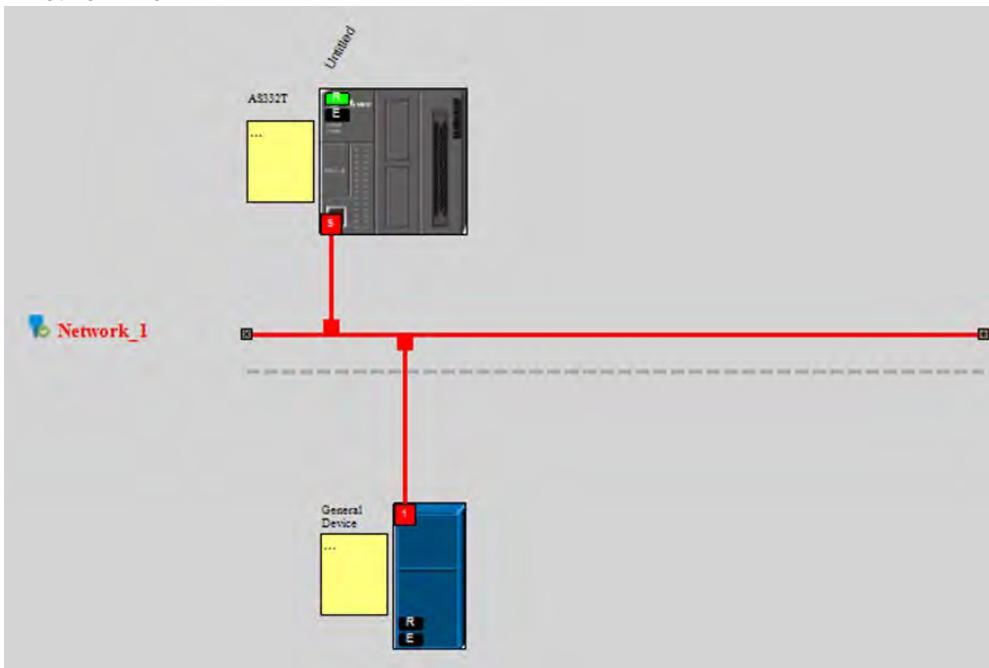

Data exchange status

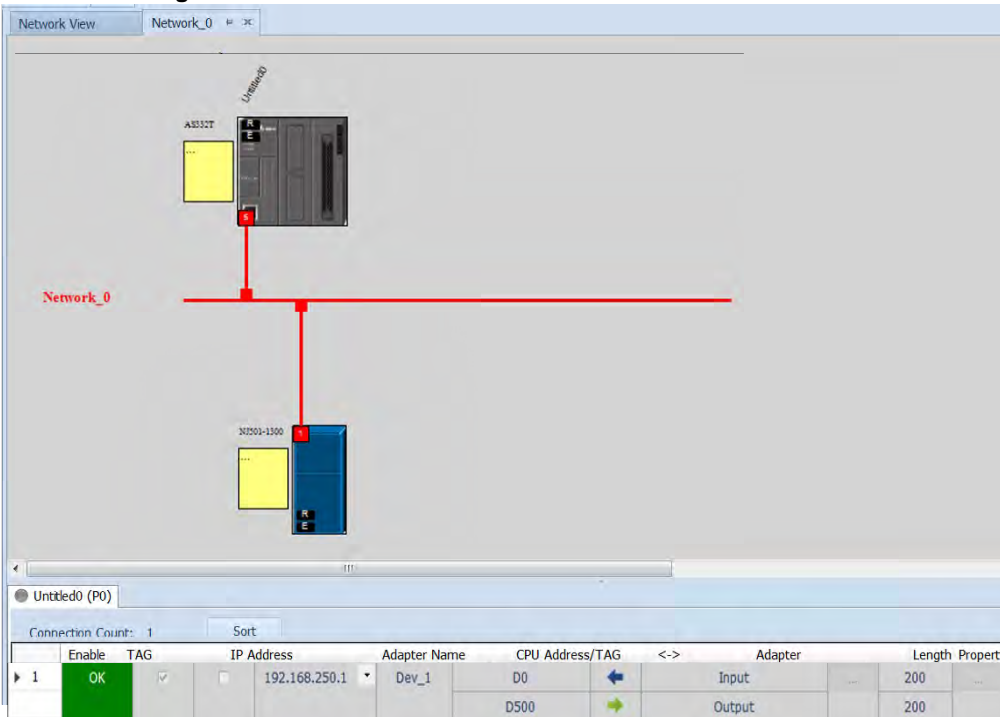

Master_Address		Slave_Address
D0	←	ToAS_IO (Instance ID=110)
D500	→	FromAS_IO (Instance ID=100)

9.8 CIP Object

9.8.1 Object List

CIP requires objects (groups of related data and behaviors associated with this data) to describe a device, how it functions, communicates, and to define its unique identity. Objects can be further defined by Class (a set of objects representing the same type of system), Instance (a copy of an object), and Attribute (data values). An object's instance and class have attributes, providing services and implementing behaviors. Instance 0 contains the basic information for every object, that is: version and length. Instance 1–N contains parameters for creating connections. You can get product parameters from the supported service code through objects.

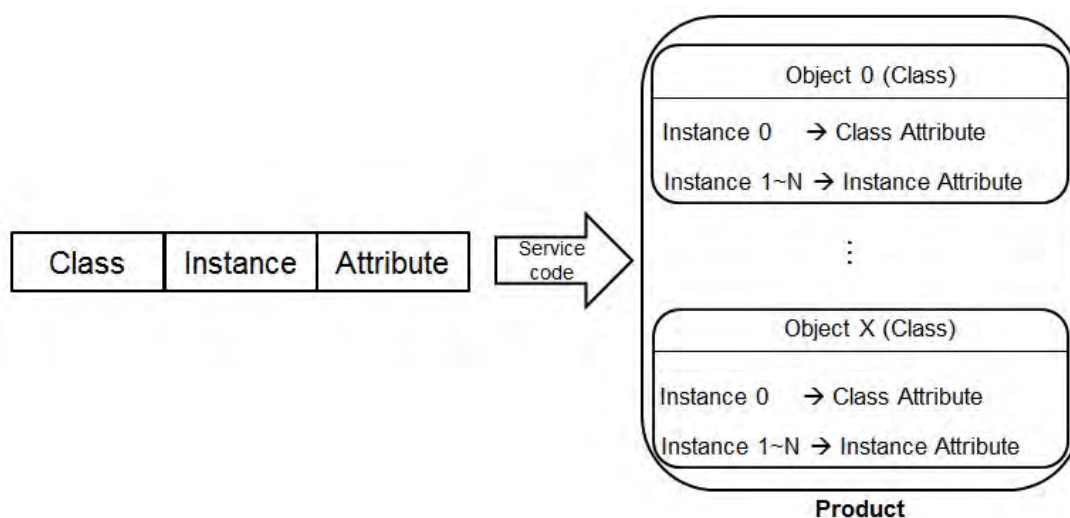

You can use API 2208 EIPRW instruction or explicit messages to read / write objects. The supported EtherNet/IP objects are listed in the following table. Refer to Section 9.8.2 for the data type definitions. Refer to Section 9.8.3 ~ 9.8.19 for object contents.

Object Name	Function	Class ID
Identity Object	Provides identification of general information about the device.	1 (H'01)
Message Router Object	Provides a messaging connection point through which a client can address a service to any object class or instance residing in the physical device.	2 (H'02)
Assembly Object	Binds attributes of multiple objects, which allows data to or from each object to be sent or received over a single connection and can be used to bind input data or output data.	4 (H'04)
Connection Manager Object	Provides connection and connectionless communications, including establishing connections across multiple subnets.	6 (H'06)
Port Object	Describes the communication interfaces that are present on the device and visible to CIP, including USB, Ethernet/IP and more.	244 (H'F4)

Object Name	Function	Class ID
TCP/IP Interface Object	Provides the mechanism to configure a device's TCP/IP network interface; examples of configurable items include the device's IP Address, Network Mask, and Gateway Address.	245 (H'F5)
Ethernet Link Object	Maintains link-specific counters and status information for an IEEE 802.3 communications interface.	246 (H'F6)
X Register	Bit/Word Register	848 (H'350)
Y Register	Bit/Word Register	849 (H'351)
D Register	Bit/Word Register	850 (H'352)
M Register	Bit Register	851 (H'353)
S Register	Bit Register	852 (H'354)
T Register	Bit/Word Register	853 (H'355)
C Register	Bit/Word Register	854 (H'356)
HC Register	Bit/Word Register	855 (H'357)
SM Register	Bit Register	856 (H'358)
SR Register	Word Register	857 (H'359)

9.8.2 Data Type

This section provides an overview of the data types supported by objects.

Data Type	Description																																													
BOOL	False (H'00) or True (H'01)																																													
SIGNED INTEGER	SINT (1 byte), INT (2 bytes), DINT (4 bytes), LINT (8 bytes)																																													
	<table border="1"> <thead> <tr> <th>Number</th> <th>1st</th> <th>2nd</th> <th>3rd</th> <th>4th</th> <th>5th</th> <th>6th</th> <th>7th</th> <th>8th</th> </tr> </thead> <tbody> <tr> <td>SINT</td> <td>0LSB</td> <td></td> <td></td> <td></td> <td></td> <td></td> <td></td> <td></td> </tr> <tr> <td>INT</td> <td>0LSB</td> <td>1LSB</td> <td></td> <td></td> <td></td> <td></td> <td></td> <td></td> </tr> <tr> <td>DINT</td> <td>0LSB</td> <td>1LSB</td> <td>2LSB</td> <td>3LSB</td> <td></td> <td></td> <td></td> <td></td> </tr> <tr> <td>LINT</td> <td>0LSB</td> <td>1LSB</td> <td>2LSB</td> <td>3LSB</td> <td>4LSB</td> <td>5LSB</td> <td>6LSB</td> <td>7LSB</td> </tr> </tbody> </table>	Number	1st	2nd	3rd	4th	5th	6th	7th	8th	SINT	0LSB								INT	0LSB	1LSB							DINT	0LSB	1LSB	2LSB	3LSB					LINT	0LSB	1LSB	2LSB	3LSB	4LSB	5LSB	6LSB	7LSB
	Number	1st	2nd	3rd	4th	5th	6th	7th	8th																																					
	SINT	0LSB																																												
	INT	0LSB	1LSB																																											
DINT	0LSB	1LSB	2LSB	3LSB																																										
LINT	0LSB	1LSB	2LSB	3LSB	4LSB	5LSB	6LSB	7LSB																																						
Example: DINT value = H'12345678																																														
<table border="1"> <thead> <tr> <th>Number</th> <th>1st</th> <th>2nd</th> <th>3rd</th> <th>4th</th> </tr> </thead> <tbody> <tr> <td>DINT</td> <td>78</td> <td>56</td> <td>34</td> <td>12</td> </tr> </tbody> </table>	Number	1st	2nd	3rd	4th	DINT	78	56	34	12																																				
Number	1st	2nd	3rd	4th																																										
DINT	78	56	34	12																																										
UNSIGNED INTEGER	USINT (1 byte), UINT (2 bytes), UDINT (4 bytes), ULINT (8 bytes)																																													
	Ex: UDINT value = H'AABBCCDD <table border="1"> <thead> <tr> <th>Number</th> <th>1st</th> <th>2nd</th> <th>3rd</th> <th>4th</th> </tr> </thead> <tbody> <tr> <td>UDINT</td> <td>DD</td> <td>CC</td> <td>BB</td> <td>AA</td> </tr> </tbody> </table>	Number	1st	2nd	3rd	4th	UDINT	DD	CC	BB	AA																																			
Number	1st	2nd	3rd	4th																																										
UDINT	DD	CC	BB	AA																																										
STRING	ASCII CODES, 1 or 2 bytes/words																																													
	STRING: 2 bytes character count + 1 byte character																																													
	<table border="1"> <thead> <tr> <th></th> <th colspan="2">Contents (Char count)</th> <th colspan="4">Contents (String contents)</th> </tr> </thead> <tbody> <tr> <td>STRING</td> <td>04</td> <td>00</td> <td>4D</td> <td>69</td> <td>6C</td> <td>6C</td> </tr> </tbody> </table>		Contents (Char count)		Contents (String contents)				STRING	04	00	4D	69	6C	6C																															
		Contents (Char count)		Contents (String contents)																																										
	STRING	04	00	4D	69	6C	6C																																							
	STRING2: 2 bytes character count + 2 byte character																																													
<table border="1"> <thead> <tr> <th></th> <th colspan="2">Contents (Char count)</th> <th colspan="8">Contents (String contents)</th> </tr> </thead> <tbody> <tr> <td>STRING2</td> <td>04</td> <td>00</td> <td>4D</td> <td>00</td> <td>69</td> <td>00</td> <td>6C</td> <td>00</td> <td>6C</td> <td>00</td> </tr> </tbody> </table>		Contents (Char count)		Contents (String contents)								STRING2	04	00	4D	00	69	00	6C	00	6C	00																								
	Contents (Char count)		Contents (String contents)																																											
STRING2	04	00	4D	00	69	00	6C	00	6C	00																																				
SHORT_STRING: 1 bytes character count + 1 byte character																																														
<table border="1"> <thead> <tr> <th></th> <th colspan="1">Contents (Char count)</th> <th colspan="4">Contents (String contents)</th> </tr> </thead> <tbody> <tr> <td>STRING</td> <td>04</td> <td>4D</td> <td>69</td> <td>6C</td> <td>6C</td> </tr> </tbody> </table>		Contents (Char count)	Contents (String contents)				STRING	04	4D	69	6C	6C																																		
	Contents (Char count)	Contents (String contents)																																												
STRING	04	4D	69	6C	6C																																									

Data Type	Description								
Fixed LENGTH BIT STRING	BYTE (1 byte), WORD (2 bytes), DWORD (4 bytes), LWORD (8 bytes)								
		1st	2nd	3rd	4th	5th	6th	7th	8th
	Byte	7...0							
	WORD	7...0	15...8						
	DWORD	7...0	15...8	23...16	31...24				
LWORD	7...0	15...8	23...16	31...24	39...32	47...40	55...48	63...56	
STRINGI	A single string consists of multiple language representation								
	Name	Data Type	Meaning						
	Number	USINT	The number of internationalized character strings						
	Strings	Array of: Struct of:	Array of individual internationalized character strings						
	LanguageChar1	USINT	The first ASCII character of the ISO 639-2/T language						
	LanguageChar2	USINT	The second ASCII character of the ISO 639-2/T language						
	LanguageChar3	USINT	The third ASCII character of the ISO 639-2/T language						
	CharStringStruct	USINT	The structure of the character string, limited to the Elementary Data type value 0xD0 (STRING), 0xD5 (STRING2), 0xD9 (STRINGN) and 0xDA (SHORT_STRING)						
	CharSet	UINT	The character set which the character string is based on which comes from IANA MIB Printer Code (RFC 1759).						
	International String	Defined in CharStringStruct	An array of 8-bit octet elements which is the actual international character string						
	ISO 639-2/T language:								
Language	First Character	Second Character	Third Character						
English	e	n	G						
French	f	r	e						

Data Type	Description								
	Spanish		s	p	a				
	Italian		i	t	a				
STRUCT	STRUCT of: Composed of any data types. Ex.: STRUCT of { BOOL, UINT, DINT } = { TRUE, H'1234, H'56789ABC }								
		1st	2nd	3rd	4th	5th	6th	7th	
	Byte	01	34	12	BC	9A	78	56	
ARRAY	Array of: Composed of one data type. Ex.: ARRAY of UINTs = { 1 · 2 · 3 }								
	Number	1st	2nd	3rd	4th	5th	6th		
	Array	01	00	02	00	03	00		
EPATH	A path that consists of multiple segments and references the class, instance and attribute of another object. Example : Identity Object, Instance attribute 5 = " 20 01 24 01 30 05 "								

9.8.3 Identity Object (Class ID: 01 Hex)

This object stores identity information that consists of the Vendor ID, Device Type, Product Code and Major Revision for your device.

- Service Code

Service code	Service Name	Attribute		Description
		Class Attribute	Instance Attribute	
H'01	Get_Attributes_All	X	V	Read all attributes
H'05	Reset	X	V	Resets the drive to the start-up state.
H'0E	Get_Attribute_Single	V	V	Read one attribute

- Class

- Class ID: H'01

- Instance

- H'00: Class Attribute
- H'01: Instance Attribute
- When Instance = 0, the Class Attributes are listed below.

Class Attribute	Name	Access Rule	Data Type	Values	Description
H'01	Revision	Get	UINT	H'1	Revision of this object
H'02	Max Instance	Get	UINT	H'1	Maximum instance number of this object
H'03	Number of Instance	Get	UINT	H'1	Number of object instances currently created at this class level of the device

- When Instance = 0, the Instance Attributes are listed below.

Instance Attribute	Name	Access Rule	Data Type	Values	Description
H'01	Vendor ID	Get	UINT	H'31F	Delta Electronics, Inc.

Instance Attribute	Name	Access Rule	Data Type	Values	Description
H'02	Device Type	Get	UINT	H'0C	Communication Adapter
H'03	Product Code	Get	UINT	H'4000	Product Code
H'04	Revision	Get	STRUCT	--	Revision of this device: Major / Minor
	Major Revision		USINT	H'01	Major Revision Range: H'01–H'7F
	Minor Revision		USINT	H'01	Minor Revision Range: H'01–H'FF
H'05	Status	Get	WORD	H'00	Status, refer to the following *1 table
H'06	Serial Number	Get	UDINT	H'abcd	The last 4 characters of the MAC address, ab:cd
H'07	Product Name	Get	STRING	"AS300T"	The maximum length of a product name is 32 characters.

*1 Status Description (H'05)

Bit (s)	Name	Description
0	Owned	Does the device has an owner connection? 0: No 1: Yes
1	Reserved	0 · Always OFF
2	Configured	Is the device configured? 0: No 1: Yes
3	Reserved	0 · Always OFF
4-7	Extended Device Status	0: Self-testing 1: Firmware update 2: At least one faulted I/O connection 3: No I/O connections established 4: Non-volatile configuration error 5: Major fault 6: At least one I/O connection in run mode 7: At least one I/O connection established, all in idle mode. 8-15: Reserved
8	Minor Recoverable Fault	0: No minor recoverable fault detected

Bit (s)	Name	Description
		1: Minor recoverable fault detected
9	Minor Unrecoverable Fault	0: No minor unrecoverable fault detected 1: Minor unrecoverable fault detected
10	Major Recoverable Fault	0: No major recoverable fault detected 1: Major recoverable fault detected
11	Major Unrecoverable Fault	0: No major unrecoverable fault detected 1: Major unrecoverable fault detected

9.8.4 Message Router Object (Class ID: 02 Hex)

This object provides a messaging connection point through which a client may address a service to any object class or instance residing in the physical device.

- Service Code

Service Code	Service Name	Support		Description
		Class Attribute	Instance Attribute	
H'0E	Get_Attribute_Single	V	V	Read a single attribute

- Class

- Class ID: H'02

- Instance

- H'00: Class Attribute
- H'01: Instance Attribute
- When Instance = 0, the Class Attributes are listed below.

Class Attribute	Name	Access Rule	Data Type	Values	Description
H'01	Revision	Get	UINT	H'01	Revision of this object

- When Instance = 0, the Instance Attributes are listed below.

Instance Attribute	Name	Access Rule	Data Type	Values	Description
H'02	Number Available	Get	UINT	H'0	The maximum number of connections
H'03	Number Active	Get	UINT	H'0	The number of connected connections

9.8.5 Assembly Object (Class ID: 04 Hex)

This object binds attributes of multiple objects, which allows data to or from each object to be sent or received over a single connection and can be used to bind input data or output data.

- Service Code

Service Code	Service Name	Support		Description
		Class Attribute	Instance Attribute	
H'0E	Get_Attribute_Single	V	V	Read a single attribute
H'10	Set_Attribute_Single	X	V	Edit a single attribute

- Class

- Class ID : H'04

- Instance

- H'00 : Class Attribute
- H'64 : I/O Connection Output 1
- H'65 : I/O Connection Input 1
- H'66 : I/O Connection Output 2
- H'67 : I/O Connection Input 2
- H'72 : I/O Connection Output 8
- H'73 : I/O Connection Input 8
- H'74-H'7A Reserved
- H'80 : Configuration 1
- H'81 : Configuration 2
- H'87 : Configuration 8
- H'C : Listen-Only Connection Number
- When Instance = 0, the Class Attributes are listed below.

Class Attribute	Name	Access Rule	Data Type	Values	Description
H'01	Revision	Get	UINT	H'2	Revision of this object

H'02	Max Instance	Get	UINT	H'C7	The maximum number of instances
------	--------------	-----	------	------	---------------------------------

- When Instance = 64–87, the Instance Attributes are listed below. (Length of input and output is editable. The maximum length is 250 words; supports only even bytes)

I/O Message Connection			
Connection No.	Function	Instance Attribute	Length
Connection 1	Input (T→O)	0x65	D1000~D1099
	Output (O→T)	0x64	D0~D99
	Configuration	0x80	Refer to the table below
Connection 2	Input (T→O)	0x67	D1100~D1199
	Output (O→T)	0x66	D100~D199
	Configuration	0x81	Refer to the table below
Connection 3	Input (T→O)	0x69	D1200~D1299
	Output (O→T)	0x68	D200~D299
	Configuration	0x82	Refer to the table below
Connection 4	Input (T→O)	0x6B	D1300~D1399
	Output (O→T)	0x6A	D300~D399
	Configuration	0x83	Refer to the table below
Connection 5	Input (T→O)	0x6D	D1400~D1499
	Output (O→T)	0x6C	D400~D499
	Configuration	0x84	Refer to the table below
Connection 6	Input (T→O)	0x6F	D1500~D1599
	Output (O→T)	0x6E	D500~D599
	Configuration	0x85	Refer to the table below
Connection 7	Input (T→O)	0x71	D1600~D1699
	Output (O→T)	0x70	D600~D699
	Configuration	0x86	Refer to the table below
Connection 8	Input (T→O)	0x73	D1700~D1799
	Output (O→T)	0x72	D700~D799
	Configuration	0x87	Refer to the table below

- Instance Attribute

Instance Attribute	Name	Access Rule	Data Type	Values	Description
H'03	Data	Get/Set	UINT	H'0	The maximum number of connections
H'04	Size	Get	UINT	H'0	The number of connected connections

* For connection input data, WRITE function is not supported.

* When IO connection is established, and the status of CPU module is RUN, WRITE function cannot be executed.

Configure the contents of input and output to edit the exchange address.

Configuration Address	Data Type	Contents	Defaults (Connection 1)
Word[0]	UINT	Input corresponding element 0: D, 1:X, 2: Y	0
Word[1]	UINT	Reserved	200
Word[2-3]	DWORD	Input corresponding element number	1000
Word[4]	UINT	Output corresponding element 0: D, 2: Y	0
Word[5]	UINT	Reserved	200
Word[6-7]	DWORD	Output corresponding element number	0

- Examples of objects to be read and written

(1) Read data from connection 1 input:

Service code: H'0E

Class ID: H'04

Instance ID: H'65

Attribute ID: H'03

(2) Read data length of connection 2 output:

Service code: H'0E

Class ID: H'04

Instance ID: H'66

Attribute ID: H'04

(3) Read data from connection 2 output:

Service code: H'10

Class ID: H'04

Instance ID: H'66

Attribute ID: H'03

Data byte [0 ~ 200]: 00112233

(The range of data length is determined by configurations; default: 100 words)

9.8.6 Connection Manager Object (Class ID: 06 Hex)

Use this object for connection and connectionless communications, including establishing connections across multiple subnets.

- Service Code

Service Code	Service Name	Support		Description
		Class Attribute	Instance Attribute	
H'0E	Get_Attribute_Single	V	X	Read a single attribute
H'4E	Forward_Close	X	V	Close a connection
H'54	Forward_Open	X	V	Open a connection; the maximum data size is 511 bytes.

- Class

- Class ID : H'06

- Instance

- H'00 : Class Attribute
- H'01 : Instance Attribute
- When Instance = 0, the Class Attributes are listed below.

Class Attribute	Name	Access Rule	Data Type	Values	Description
H'01	Revision	Get	UINT	1	Revision of this object
H'02	Max Instance	Get	UINT	1	Maximum instance number of this object

- When Instance = 1, the Instance Attributes are listed below.

Attribute	Name	Access Rule	Data Type	Values	Description
H'01	Open Requests	Get	UINT	H'0	Number of Forward Open service requests received.

Attribute	Name	Access Rule	Data Type	Values	Description
H'02	Open Format Rejects	Get	UINT	H'0	Number of Forward Open service requests that were rejected due to bad format.
H'03	Open Resources Rejects	Get	UINT	H'0	Number of Forward Open service requests that were rejected due to lack of resources.
H'04	Open Other Rejects	Get	STRUCT	H'0	Number of Forward Open service requests that were rejected for reasons other than bad format or lack of resources.
H'05	Close Requests	Get	WORD	H'0	Number of Forward Close service requests received.
H'06	Close Format Rejects	Get	UDINT	H'0	Number of Forward Close service requests that were rejected due to bad format.
H'07	Close Other Rejects	Get	STRING	H'0	Number of Forward Close service requests that were rejected for reasons other than bad format.
H'08	Connection Timeouts	Get	UINT	H'0	Total number of connection timeouts that have occurred in connections controlled by this Connection Manager.

9.8.7 Port Object (Class ID: F4 Hex)

This section describes the communication interfaces that are present on the device and visible to CIP, including USB, EtherNet/IP and more.

- Service Code

Service Code	Service Name	Support		Description
		Class Attribute	Instance Attribute	
H'01	Get_Attributes_All	X	V	Returns a predefined listing of this objects' attributes
H'0E	Set_Attribute_Single	V	V	Returns the contents of the specified attribute.

- Class

- Class ID : H'F4

- Instance

- H'00 : Class Attribute
- H'01 : Instance Attribute
- H'N: Instance #N Attribute, the number of the Ethernet port

- When Instance = 0, the Class Attributes are listed below.

Class Attribute	Name	Access Rule	Data Type	Values	Description
H'01	Revision	Get	UINT	1	Revision of this object
H'02	Max Instance	Get	UINT	1	Maximum instance number of this object
H'03	Number of Instance	Get	UINT	1	Number of object instances currently created at this class level of the device
H'08	Entry Port	Get	UINT	1	Communication port for EtherNet/IP
H'09	Port Instance Info	Get	ARRAY of STRUCT of	--	Port Instance information: Port Type + Port Number

Class Attribute	Name	Access Rule	Data Type	Values	Description
	Port Type		UINT	H'04	EtherNet/IP, refer to the following *1
	Port Number		UINT	H'01	Identifies each communication port

- When Instance = 1, the Instance Attributes are listed below.

Instance Attribute	Name	Access Rule	Data Type	Values	Description
H'01	Port Type	Get	UINT	H'04	EtherNet/IP, refer to the following *1
H'02	Port Number	Get	UINT	H'01	Identifies each communication port
H'03	Link Object	Get	STRUCT of	--	Identifies Object attached to this port. Path length + Link Path
	Path Length		UINT	--	Path length
	Link Path		EPATH	--	Path segment
H'04	Port Name	Get	SHORT_ STRING	EIP1	Name of the communication port
H'07	Port Number and Node Address	Get	EPATH	01 01	Communication port number and node number of this device on port.

*1 Communication Port Type

Communication Port Type	Description
1	Self-defined
2	ControlNet
3	ControlNet Redundant
4	EtherNet/IP
5	DeviceNet
201	Modbus/TCP
203	SERCOS III

9.8.8 TCP/IP Interface Object (Class ID: F5 Hex)

This object provides the mechanism to configure a device's TCP/IP network interface. Examples of configurable items include the device's IP Address, Network Mask, and Gateway Address.

- Service Code

Service Code	Service Name	Support		Description
		Class Attribute	Instance Attribute	
H'01	Get_Attributes_All	X	V	Read all attributes
H'0E	Get_Attribute_Single	V	V	Read one attribute
H'10	Set_Attribute_Single	X	V	Write one attribute

- Class

- Class ID = H'F5

- Instance

- H'00 : Class Attribute
- H'01 : Instance Attribute
- H'N: Instance #N Attribute, number of IP addresses that the device supported
- When Instance = 0, the Class Attributes are listed below.

Class Attribute	Name	Access Rule	Data Type	Values	Description
H'01	Revision	Get	UINT	H'2	Revision of this object
H'02	Max Instance	Get	UINT	H'2	Maximum instance number of this object
H'03	Number of Instance	Get	UINT	H'2	Number of object instances currently created at this class level of the device

- When Instance = 1, the Instance Attributes are listed below.

Instance Attribute	Name	Access Rule	Data Type	Values	Description
H'01	Status	Get	DWORD	H'2	IP status, refer to the following *1
H'02	Configuration Capability	Get	DWORD	H'15	Configuration capability, refer to the following *2
H'03	Configuration Control	Get/Set	DWORD	H'0	Configuration Control, refer to the following *3
H'04	Physical Link Object :	Get	STRUCT of	--	Path to physical link object
	Path Size		UINT	H'0	Size of Path
	Path		EPATH	--	Logical segments identifying the physical link object
H'05	Interface Configuration :	Get/Set	STRUCT of	--	TCP/IP network interface configuration.
	IP Address		UDINT	H'C0A80005	The device's IP address; 192.168.1.5
	Network Mask		UDINT	H'FFFFFF00	The device's network mask: 255.255.255.0
	Gateway Address		UDINT	H'C0A80001	Default gateway address: 192.168.0.1
	Name Server		UDINT	0	Primary name server
	Name Server 2		UDINT	0	Secondary name server
	Domain Name		STRING	00 00	Default domain name
H'06	Host Name	Get/Set	STRING	AS300T	Device name
H'13	Encapsulation Inactivity Timeout	Get/Set	UINT	120	EIP device active connection time; unit:0-3600 seconds

- ※ When the device is communicating with the CPU module, the Instance Attribute H'03 and H'05 cannot be written.

- Examples of objects to be read and written

(1) Read data from Instance Attribute H'03:

Service code: H'0E

Class ID: H'F5

Instance ID: H'01

Attribute ID: H'03

(2) Write data into Instance Attribute H'05:

Service code: H'10

Class ID: H'F5

Instance ID: H'01

Attribute ID: H'05

Data Byte[0~3]: IP Address

Byte[4~7]: Network Mask

Byte[8~11]: Gateway Mask

Byte[12~15]: Name Server

Byte[16~19]: Name Server2

Byte[20~25]: Domain Name

(Ex: AS300, 05 41 53 33 30 30; the first byte indicates the string length, its following bytes is for ASCII data.)

***1 Interface Status**

Status	Description
0	The Interface Configuration attribute has not been configured.
1	The Interface Configuration attribute contains valid configuration obtained from BOOTP, DHCP or non-volatile memory.
2	The Interface Configuration attribute contains valid configuration obtained from hardware.

***2 Interface Capability Flags**

Bit	Description
0	BOOTP Client
1	DNS Client
2	DHCP Client
3	DHCP-DNS Update
4	Configuration Settable
5	Hardware Configurable
6	Interface Configuration Change Requires Reset

***3 Interface Configuration Control**

Status	Description
0	The device uses the interface configuration values previously stored (for example, in non-volatile memory or through hardware switches).
1	The device obtains its interface configuration values through BOOTP.
2	The device obtains its interface configuration values through DHCP on start-up.

9.8.9 Ethernet Link Object (Class ID: F6 Hex)

This object maintains link-specific counters and status information for an IEEE 802.3 communications interface.

- Service Code

Service Code	Service Name	Support		Description
		Class Attribute	Instance Attribute	
H'01	Get_Attributes_All	X	V	Read all attributes
H'0E	Get_Attributes_Single	V	V	Read one attribute

- Class

- Class ID: H'F6

- Instance

- H'00: Class Attribute
- H'01: Instance Attribute
- H'N: Instance #N Attribute, the number of the Ethernet port
- When Instance = 0, the Class Attributes are listed below.

Class Attribute	Name	Access Rule	Data Type	Values	Description
H'01	Revision	Get	UINT	H'03	Revision of this object
H'02	Max Instance	Get	UINT	H'021	Maximum instance number of this object
H'03	Number of Instance	Get	UINT	H'01	Number of object instances currently created at this class level of the device

- When Instance = 1, the Instance Attributes are listed below.

Instance Attribute	Name	Access Rule	Data Type	Values	Description
H'01	Interface Speed	Get	DWORD	H'64	Interface speed currently in use 10(H'0A), 100(H'64), 1000(H'3E8) Mbps
H'02	Interface Flags	Get	DWORD	H'F	Ethernet port status, refer to the following *1
H'03	Physical Address	Get	ARRAY of 6 USINTs	By Product	MAC address
H'0A	Interface Label	Get	SHORT_S TRING	NA	Define the name of the Ethernet port For example: for port 1, the definition of the name in string is 01 31.
	Length		USINT	NA	The maximum length of the name is 16 words.
	Interface name		SHORT_S TRING	NA	Use ASCII characters to name the Ethernet port name.
H'0B	Interface Capability	Get	STRUCT of:	--	Ethernet interface capability bits table *2
	Capability Bits		DWORD	H'0000000 7	Ethernet interface capability bits definition
	Speed/Duplex Options		STRUCT of:	--	Ethernet interface capability speed & duplex option definition
	Speed/Duplex Array Count		USINT	H'04	Ethernet interface capability speed & duplex array count
	Speed/Duplex Array		ARRAY of STRUCT of:	--	Ethernet interface capability speed & duplex array contents
	Interface Speed		UINT	NA	Ethernet interface speed; ex: H'0A: 10 bps and H'64: 100 bps
	Interface Duplex Mode		USINT	NA	Ethernet interface duplex mode; H'00: duplex mode and H'01: full duplex mode

*1 Interface Flag Table

Bit (s)	Name	Description
0	Link Status	0 indicates an inactive link 1 indicates an active link
1	Half/Full Duplex	0 indicates half duplex 1 indicates full duplex
2-4	Negotiation Status	0 : Auto-negotiation in progress 1 : Auto-negotiation and speed detection failed 2 : Auto negotiation failed but detected speed 3 : Successfully negotiated speed and duplex 4 : Auto-negotiation not attempted. Forced speed and duplex.
5	Manual Setting Requires Reset	Set to zero
6	Local Hardware Fault	0: the interface detects no local hardware fault 1: a local hardware fault is detected
7-31	Reserved	0

*2 Interface Capability Bits

Bits	Item	Description
0	Manual Setting Requires Reset	Indicates if the device requires a reset when instance attribute #6 (Interface Control attribute) changes. 0 indicates the device does not require a reset 1 indicates the device requires a reset
1	Auto-negotiate	0 indicates the interface does not support auto-negotiation 1 indicates the interface supports auto-negotiation
2	Auto-MDIX	0 indicates the interface does not support auto MDIX operation 1 indicates the interface supports auto MDIX operation
3	Manual Speed/Duplex	0 indicates the interface does not support speed/duplex setting. (Instance attribute #6, Interface Control attribute) 1 indicates the interface supports speed/duplex setting
4-31	Reserved	Should be 0

9.8.10 X Register (Class ID: 350 Hex)

- Service Code

Service Code	Service Name	Support		Description
		Class Attribute	Instance Attribute	
H'0E	Get_Attribute_Single	X	V	Read one attribute
H'32	Read_Parameter	X	V	Read Parameter

- Class

- Class ID : H'350

- Instance

- H'01 : Instance Attribute, Bit Register
- H'02 : Instance Attribute, Word Register
- When Instance = 1, the Instance Attributes are listed below.

Instance Attribute	Name	Access Rule	Data Type	Values	Description
H'00	X0.0	Get	BOOL	H'00	X0.0 bit register
H'01	X0.1	Get	BOOL	H'00	X0.1 bit register
H'02-H'03FE	X0.2-X63.14	Get	BOOL	H'00	X0.2 -X63.14 bit register
H'3FF	X63.15	Get	BOOL	H'00	X63.15 bit register

- When Instance = 2, the Instance Attributes are listed below.

Instance Attribute	Name	Access Rule	Data Type	Values	Description
H'00	X0	Get	INT	H'00	X0 word register
H'01	X1	Get	INT	H'00	X1 word register
H'02-H'3E	X2-X62	Get	INT	H'00	X2-X62 word register
H'3F	X63	Get	INT	H'00	X63 word register

9.8.11 Y Register (Class ID: 351 Hex)

- Service Code

Service Code	Service Name	Support		Description
		Class Attribute	Instance Attribute	
H'0E	Get_Attribute_Single	X	V	Read one attribute
H'10	Set_Attribute_Single	X	V	Write one attribute
H'32	Read_Parameter	X	V	Read Parameter
H'33	Write_Parameter	X	V	Write Parameter

- Class

- Class ID : H'351

- Instance

- H'01 : Instance Attribute, Bit Register
- H'02 : Instance Attribute, Word Register
- When Instance = 1, the Instance Attributes are listed below.

Instance Attribute	Name	Access Rule	Data Type	Values	Description
H'00	Y0.0	Get/Set	BOOL	H'00	Y0.0 bit register
H'01	Y0.1	Get/Set	BOOL	H'00	Y0.1 bit register
H'02-H'03FE	Y0.2-Y63.14	Get/Set	BOOL	H'00	Y0.2-Y63.14 bit register
H'3FF	Y63.15	Get/Set	BOOL	H'00	Y63.15 bit register

- When Instance = 2, the Instance Attributes are listed below.

Instance Attribute	Name	Access Rule	Data Type	Values	Description
H'00	Y0	Get/Set	INT	H'00	Y0 word register
H'01	Y1	Get/Set	INT	H'00	Y1 word register
H'02-H'3E	Y2-Y62	Get/Set	INT	H'00	Y2-Y62 word register
H'3F	Y63	Get/Set	INT	H'00	Y63 word register

9.8.12 D Register (Class ID: 352 Hex)

- Service Code

Service Code	Service Name	Support		Description
		Class Attribute	Instance Attribute	
H'0E	Get_Attribute_Single	X	V	Read one attribute
H'10	Set_Attribute_Single	X	V	Write one attribute
H'32	Read_Parameter	X	V	Read Parameter
H'33	Write_Parameter	X	V	Write Parameter

- Class

- Class ID : H'352

- Instance

- H'01 : Instance Attribute, Bit Register
- H'02 : Instance Attribute, Word Register
- When Instance = 1, the Instance Attributes are listed below.

Instance Attribute	Name	Access Rule	Data Type	Values	Description
H'00	D0.0	Get/Set	BOOL	H'00	D0.0 bit register
H'01	D0.1	Get/Set	BOOL	H'00	D0.1 bit register
H'02-H'752FE	D0.2-D29999.14	Get/Set	BOOL	H'00	D0.2-D29999.14 bit register
H'752FF	D29999.15	Get/Set	BOOL	H'00	D29999.15 bit register

- When Instance = 2, the Instance Attributes are listed below.

Instance Attribute	Name	Access Rule	Data Type	Values	Description
H'00	D0	Get/Set	INT	H'00	D0 word register
H'01	D1	Get/Set	INT	H'00	D1 word register
H'02-H'752E	D2-D29998	Get/Set	INT	H'00	D2-D29998 word register
H'752F	D29999	Get/Set	INT	H'00	D29999 word register

9.8.13 M Register (Class ID: 353 Hex)

- Service Code

Service Code	Service Name	Support		Description
		Class Attribute	Instance Attribute	
H'0E	Get_Attribute_Single	X	V	Read one attribute
H'10	Set_Attribute_Single	X	V	Write one attribute
H'32	Read_Parameter	X	V	Read Parameter
H'33	Write_Parameter	X	V	Write Parameter

- Class

- Class ID : H'353

- Instance

- H'01 : Instance Attribute, Bit Register

- When Instance = 1, the Instance Attributes are listed below.

Instance Attribute	Name	Access Rule	Data Type	Values	Description
H'00	M0	Get/Set	BOOL	H'00	M0 bit register
H'01	M1	Get/Set	BOOL	H'00	M1 bit register
H'02-H'1FFE	M2-M8190	Get/Set	BOOL	H'00	M2-M8190 bit register
H'1FFF	M8191	Get/Set	BOOL	H'00	M8191 bit register

9.8.14 S Register (Class ID: 354 Hex)

- Service Code

Service Code	Service Name	Support		Description
		Class Attribute	Instance Attribute	
H'0E	Get_Attribute_Single	X	V	Read one attribute
H'10	Set_Attribute_Single	X	V	Write one attribute
H'32	Read_Parameter	X	V	Read Parameter
H'33	Write_Parameter	X	V	Write Parameter

- Class

- Class ID : H'354

- Instance

- H'01 : Instance Attribute, Bit Register
- When Instance = 1, the Instance Attributes are listed below.

Instance Attribute	Name	Access Rule	Data Type	Values	Description
H'00	S0	Get/Set	BOOL	H'00	S0 bit register
H'01	S1	Get/Set	BOOL	H'00	S1 bit register
H'02-H'7FE	S2-S2046	Get/Set	BOOL	H'00	S2-S2046 bit register
H'7FF	S2047	Get/Set	BOOL	H'00	S2047 bit register

9.8.15 T Register (Class ID: 355 Hex)

- Service Code

Service Code	Service Name	Support		Description
		Class Attribute	Instance Attribute	
H'0E	Get_Attribute_Single	X	V	Read one attribute
H'10	Set_Attribute_Single	X	V	Write one attribute
H'32	Read_Parameter	X	V	Read Parameter
H'33	Write_Parameter	X	V	Write Parameter

- Class

- Class ID : H'355

- Instance

- H'01 : Instance Attribute, Bit Register
- H'02 : Instance Attribute, Word Register
- When Instance = 1, the Instance Attributes are listed below.

Instance Attribute	Name	Access Rule	Data Type	Values	Description
H'00	T0	Get/Set	BOOL	H'00	T0 bit register
H'01	T1	Get/Set	BOOL	H'00	T1 bit register
H'02-H'1FE	T2-T510	Get/Set	BOOL	H'00	T2-T510 bit register
H'1FF	T511	Get/Set	BOOL	H'00	T511 bit register

- When Instance = 2, the Instance Attributes are listed below.

Instance Attribute	Name	Access Rule	Data Type	Values	Description
H'00	T0	Get/Set	INT	H'00	T0 word register
H'01	T1	Get/Set	INT	H'00	T1 word register
H'02-H'1FE	T2-T510	Get/Set	INT	H'00	T2-T510 word register
H'1FF	T511	Get/Set	INT	H'00	T511 word register

9.8.16 C Register (Class ID: 356 Hex)

- Service Code

Service Code	Service Name	Support		Description
		Class Attribute	Instance Attribute	
H'0E	Get_Attribute_Single	X	V	Read one attribute
H'10	Set_Attribute_Single	X	V	Write one attribute
H'32	Read_Parameter	X	V	Read Parameter
H'33	Write_Parameter	X	V	Write Parameter

- Class

- Class ID : H'356

- Instance

- H'01 : Instance Attribute, Bit Register
- H'02 : Instance Attribute, Word Register
- When Instance = 1, the Instance Attributes are listed below.

Instance Attribute	Name	Access Rule	Data Type	Values	Description
H'00	C0	Get/Set	BOOL	H'00	C0 bit register
H'01	C1	Get/Set	BOOL	H'00	C1 bit register
H'02-H'1FE	C2-C510	Get/Set	BOOL	H'00	C2-C510 bit register
H'1FF	C511	Get/Set	BOOL	H'00	C511 bit register

- When Instance = 2, the Instance Attributes are listed below.

Instance Attribute	Name	Access Rule	Data Type	Values	Description
H'00	C0	Get/Set	INT	H'00	C0 word register
H'01	C1	Get/Set	INT	H'00	C1 word register
H'02-H'1FE	C2-C510	Get/Set	INT	H'00	C2-C510 word register
H'1FF	C511	Get/Set	INT	H'00	C511 word register

9.8.17 HC Register (Class ID: 357 Hex)

- Service Code

Service Code	Service Name	Support		Description
		Class Attribute	Instance Attribute	
H'0E	Get_Attribute_Single	X	V	Read one attribute
H'10	Set_Attribute_Single	X	V	Write one attribute
H'32	Read_Parameter	X	V	Read Parameter
H'33	Write_Parameter	X	V	Write Parameter

- Class

- Class ID : H'357

- Instance

- H'01 : Instance Attribute, Bit Register
- H'02 : Instance Attribute, Word Register
- When Instance = 1, the Instance Attributes are listed below.

Instance Attribute	Name	Access Rule	Data Type	Values	Description
H'00	HC0	Get/Set	BOOL	H'00	HC0 bit register
H'01	HC1	Get/Set	BOOL	H'00	HC1 bit register
H'02-H'FE	HC2-HC254	Get/Set	BOOL	H'00	HC2-HC254 bit register
H'FF	HC255	Get/Set	BOOL	H'00	HC255 bit register

- When Instance = 2, the Instance Attributes are listed below.

Instance Attribute	Name	Access Rule	Data Type	Values	Description
H'00	HC0	Get/Set	DINT	H'00	HC0 word register
H'01	HC1	Get/Set	DINT	H'00	HC1 word register
H'02-H'FE	HC2-HC254	Get/Set	DINT	H'00	HC2-HC254 word register
H'FF	HC255	Get/Set	DINT	H'00	HC255 word register

9.8.18 SM Register (Class ID: 358 Hex)

- Service Code

Service Code	Service Name	Support		Description
		Class Attribute	Instance Attribute	
H'0E	Get_Attribute_Single	X	V	Read one attribute
H'10	Set_Attribute_Single	X	V	Write one attribute
H'32	Read_Parameter	X	V	Read Parameter
H'33	Write_Parameter	X	V	Write Parameter

- Class

- Class ID : H'358

- Instance

- H'01 : Instance Attribute, Bit Register
- When Instance = 1, the Instance Attributes are listed below.

Instance Attribute	Name	Access Rule	Data Type	Values	Description
H'00	SM0	Get/Set	BOOL	H'00	SM0 bit register
H'01	SM1	Get/Set	BOOL	H'00	SM1 bit register
H'02-H'FFE	SM2-SM4094	Get/Set	BOOL	H'00	SM2-SM4094 bit register
H'FFF	SM4095	Get/Set	BOOL	H'00	SM4095 bit register

9.8.19 SR Register (Class ID: 359 Hex)

- Service Code

Service Code	Service Name	Support		Description
		Class Attribute	Instance Attribute	
H'0E	Get_Attribute_Single	X	V	Read one attribute
H'10	Set_Attribute_Single	X	V	Write one attribute
H'32	Read_Parameter	X	V	Read Parameter
H'33	Write_Parameter	X	V	Write Parameter

- Class

- Class ID : H'359

- Instance

- H'01 : Instance Attribute, Bit Register
- When Instance = 1, the Instance Attributes are listed below.

Instance Attribute	Name	Access Rule	Data Type	Values	Description
H'00	SR0	Get/Set	INT	H'00	SR0 word register
H'01	SR1	Get/Set	INT	H'00	SR1 word register
H'02-H'7FE	SR2-SR2046	Get/Set	INT	H'00	SR2-SR2046 word register
H'7FF	SR2047	Get/Set	INT	H'00	SR2047 word register

9.9 Delta EIP Product List

9.9.1 Delta EIP Products

Positioning	Product	Firmware Version
Mid-range PLC	AHCPU501-EN, AHCPU511-EN, AHCPU521-EN, AHCPU531-EN	V2.00
	AHCPU560-EN2	V1.00
	AH10EN-5A	V2.00
	AHRTU-ETHN-5A	V1.00
	AH10EMC-5A	V1.00
	AS300 Series	V1.00
	AS200 Series	V1.00
	AS100 Series	V1.10
	AS-FEN02 communication card (V1.06) for AS300 Series (V1.00)	V1.06
	AS-FEN02 communication card (V2.02) for AS00SCM-A Series (V1.00)	V2.02
Small PLC	DVP-ES2-E Series	V3.60
	DVP26SE Series	V1.00
	DVP-ES3 Series	V1.00
Inverter	CMM-EIP01/02 Communication Card for VFD-MS300 Series	V1.00
	CMM-EIP03 Communication Card for VFD-MS300 Series	V1.00
	CMC-EIP01 Communication Card for VFD-C2000 Series	V1.06
	CMC-EIP02 Communication Card for VFD-C2000 Series	V1.00

9.9.2 Delta EIP Products, DLR (Device Level Ring) supported

Positioning	Product	Firmware Version
Mid-range PLC	AHCPU560-EN2	V1.00
	AH10EN-5A	V2.00
	AHRTU-ETHN-5A	V1.00
Inverter	CMM-EIP03 Communication Card for VFD-MS300 Series	V1.00
	CMC-EIP02 Communication Card for VFD-C2000 Series	V1.00
Ethernet Switch	DVS-103I02C-DLR	V1.00

9.9.3 Delta EIP Products, Scanner supported

Positioning	Product	Firmware Version
Mid-range PLC	AHCPU501-EN, AHCPU511-EN, AHCPU521-EN, AHCPU531-EN	V2.00
	AHCPU560-EN2	V1.00
	AH10EN-5A	V2.00
	AS300 Series, AS200 Series	V1.00
	AS100 Series	V1.10
Small PLC	DVP-ES3 Series	V1.00

9.10 Network Security

To enhance security and performance of the system, it is suggested to use closed network or LAN with firewall protection to prevent cyber-attacks.

9.11 Operation and Monitor on the Web

9.11.1 Getting Started

You can enter AS Series PLC IP address in the search bar of your browser to connect to your device. After that you can set up and monitor AS Series PLC. This only works in local network (LAN). Do not use it remotely.

9.11.1.1 Exploring the Webpage

After connected to the module, you can see the AS300 webpage with 5 sections as the image shown below.

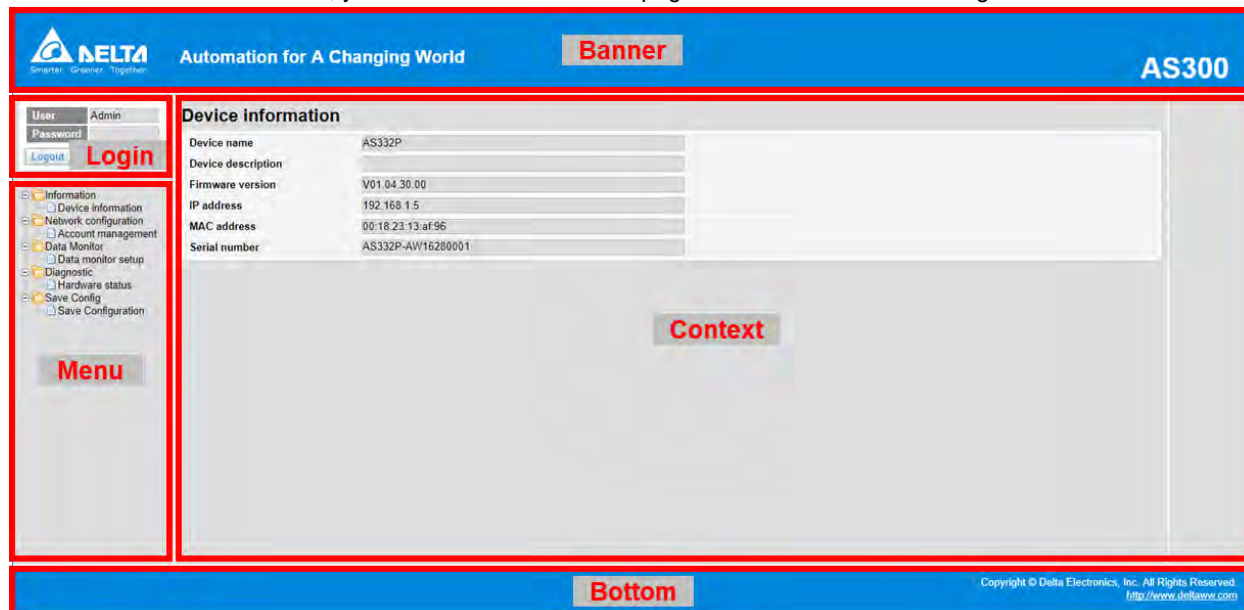

Descriptions:

Section	Contents
Banner	Delta logo and the name of the connected device
Login	Username and password
Menu	Sitemap is shown in tree diagram. (The menu shows data based on the permission of the current user.)
Context	Main contents; click an item on the menu section, its content appears here.
Bottom	Copyright information and Delta webpage information

9.11.1.2 Using the Webpage

List of browsers that support AS300 webpage:

Provider	Browser	Supported versions
Microsoft	Internet Explorer	V10.0 and later
Microsoft	Edge	V20 and later
Google	Chrome	V14 and later
Apple	Safari	V5.1 and later

- **Operation Steps:**

- Open your browser, enter AS300 PLC IP address in the search bar to connect to AS300 PLC.

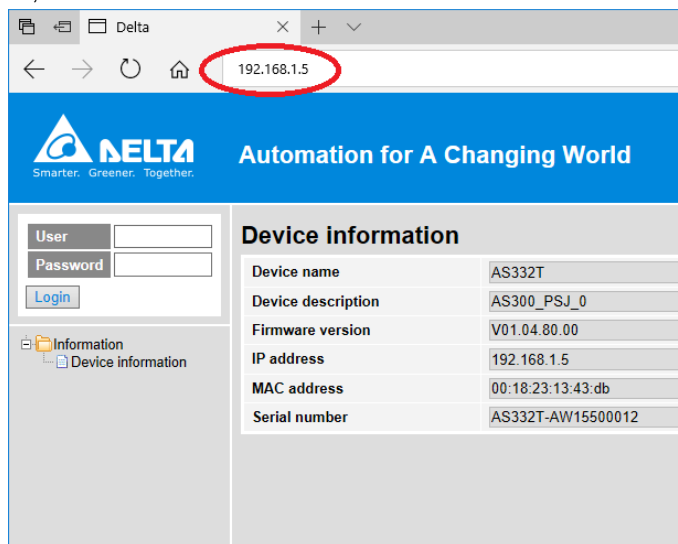

- After the webpage appears, enter "Admin" in the User section and click Login without entering any password. You can set up the password after login.

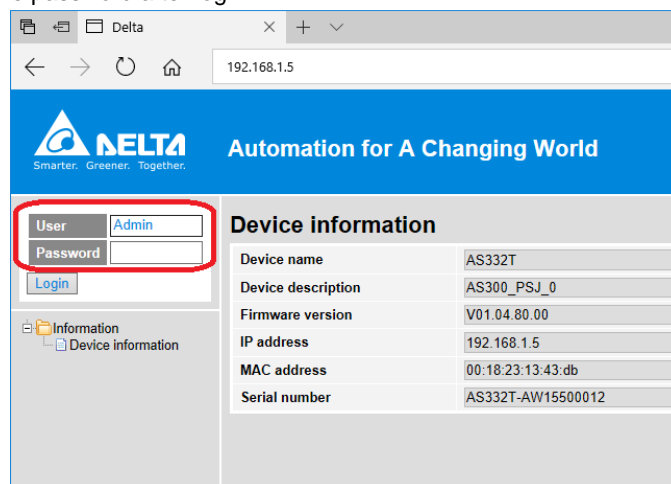

9.11.1.3 Login

You need to login to your account to set up.

- **Operation Steps:**

- Provide the login information to login.

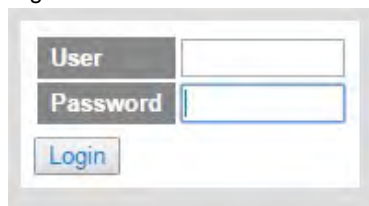

A screenshot of a login form. It features two input fields: one labeled 'User' and one labeled 'Password'. Below these fields is a button labeled 'Login'.

- After login successfully, the user field shows your account name (read only). After setting up, you can click **Logout** here to leave this webpage.

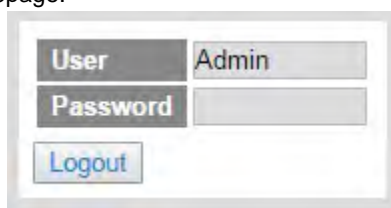

A screenshot of the login form after a successful login. The 'User' field now displays the text 'Admin' in a read-only state. The 'Password' field is empty. A button labeled 'Logout' is visible below the fields.

Item	Description
User	Your account name
Password	Your password
“Login” / “Logout”	Login: to enter the webpage Logout: to leave the webpage

9.11.1.4 Menu

The menu shows data based on the permission of the current user.

Nodes	Permission		
	Administrator	Write/Read	Read
Device information	V	V	V
Account management	V		
Data monitor setup	V		
Data monitor table 1 - 4	V	V	Read-only
Hardware status	V	Read-only	Read-only
Save configuration	V		

- Log in as an Administrator, the following nodes appear.

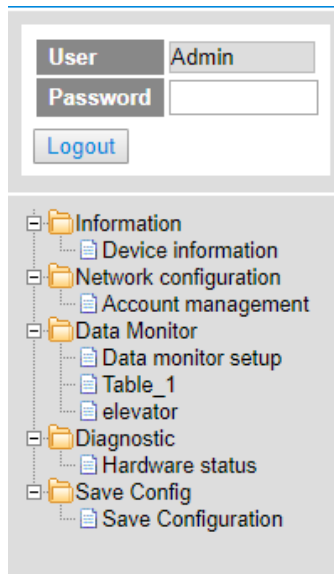

- Log in with Write/Read permission, the following nodes appear.

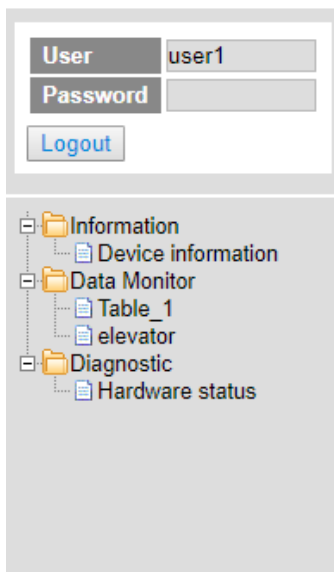

- Log in with Read only permission, the following nodes appear.



9.11.2 Device Information

Here provides AS Series PLC product information.

You do not need to log in to see the device information. This page is read only, not for editing.

Device information	
Device name	AS332P
Device description	
Firmware version	V01.04.30.00
IP address	192.168.1.5
MAC address	00:18:23:13:af:96
Serial number	AS332P-AW16280001

Item	Description
Device name	Product name
Device description	Device description that user defined in ISPsoft
Firmware version	Firmware version
IP address	Product IP address
MAC address	Product MAC address
Serial number	Product serial number

9.11.3 Network configuration

You can set network related configurations here.

9.11.3.1 Account management

You can set 3 kinds of access types for up to 8 user accounts.

Account management

No.	User ID	Password	Access type	Delete
1	Admin	<input type="text"/>	Administrator ▼	Delete
2	<input type="text"/>	<input type="text"/>	Administrator ▼	Delete
3	<input type="text"/>	<input type="text"/>	Administrator ▼	Delete
4	<input type="text"/>	<input type="text"/>	Administrator Write / Read Read	Delete
5	<input type="text"/>	<input type="text"/>	Administrator ▼	Delete
6	<input type="text"/>	<input type="text"/>	Administrator ▼	Delete
7	<input type="text"/>	<input type="text"/>	Administrator ▼	Delete
8	<input type="text"/>	<input type="text"/>	Administrator ▼	Delete

Item	Description
User ID	<p>To name your user ID, you can use up to 16 characters from the following characters, A through Z (case-insensitive), 0 through 9, _ (underscore) , (comma) and . (dot) .</p> <ul style="list-style-type: none"> The first default user ID is "Admin" (read only).
Password	<p>To name your password, you can use up to 16 characters from the following characters, A through Z (case-insensitive), 0 through 9, _ (underscore) , (comma) and . (dot) .</p> <ul style="list-style-type: none"> No password for the default user ID "Admin" (read only), you can set up the password later.
Access type	<p>Administrator: You can set up all parameters and have permission to edit the password and permission.</p> <p>Write/Read: You can open the data monitor pages and the diagnostic page. You can also edit the parameters.</p> <p>Read: You can open the data monitor pages and the diagnostic page. But you cannot edit parameters.</p> <ul style="list-style-type: none"> Default user is "Administrator".
"Delete"	Use "Delete" to clear the user ID and password.
"Apply"	Use "Apply" to save the settings.

- **Operation Steps:**

- After log in, double-click **Account management** to open the setting page.

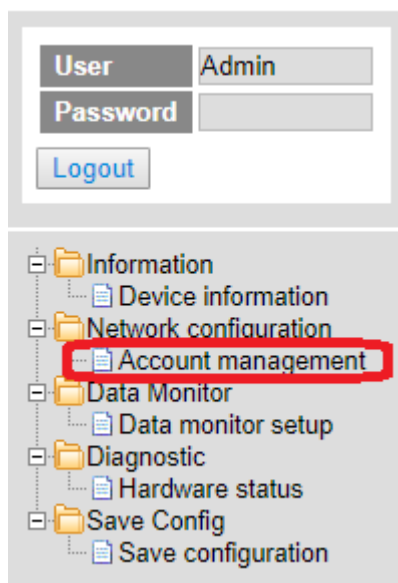

- Set up the User ID, the password and the access type. After editing, click “Apply” to save the setting or click “Delete” to clear the account.

Account management

No.	User ID	Password	Access type	Delete
1	Admin		Administrator ▼	Delete
2	user1	Write/Read ▼	Delete
3	user2	Read ▼	Delete
4			Administrator ▼	Delete
5			Administrator ▼	Delete
6			Administrator ▼	Delete
7			Administrator ▼	Delete
8			Administrator ▼	Delete

[Apply](#)

- c. Double-click **Save configuration** to open the setting page.

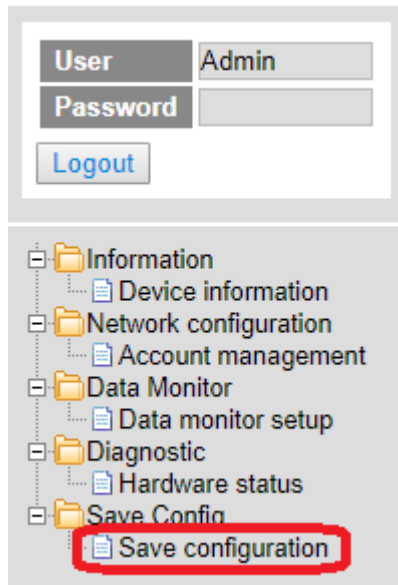

- d. Click "Save" to save and download the settings to the device.

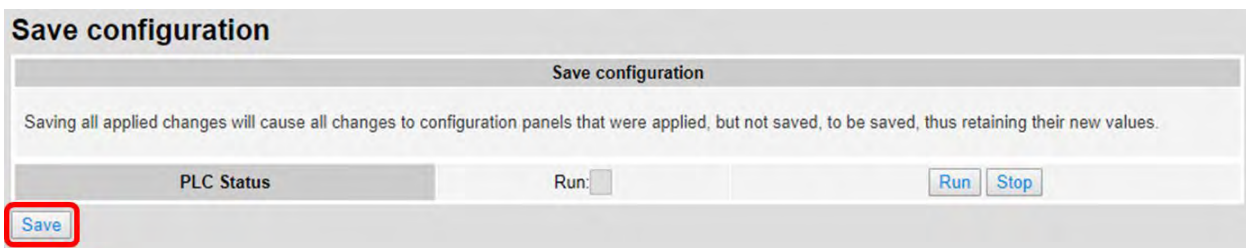

After download is complete, it will be prompted with a Download successful message.

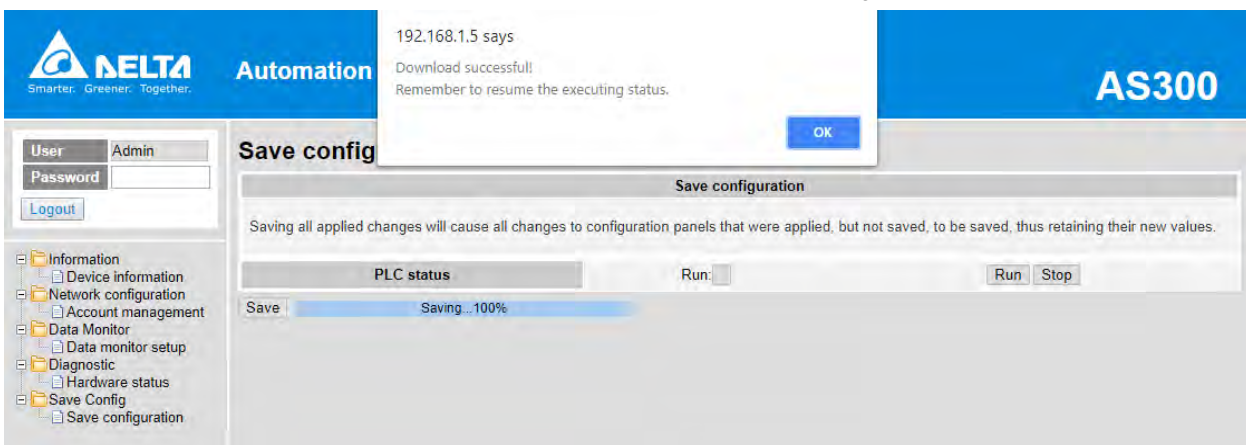

9.11.4 Data Monitoring

You can set monitoring related configurations here.

9.11.4.1 Data Monitoring Setup Page

You can set up 4 pages of monitoring data and up to 30 items can be monitored on each page.

No.	Table name	Device quantity	Default update cycle (1s-60s)	Edit	Delete
1	Table_1	17	1	Edit	Delete
2		0	10	Edit	Delete
3	Table_3	0	1	Edit	Delete
4	Table_4	0	5	Edit	Delete

No.	Device	Radix	Read only	Description
1	M0	Binary	<input type="checkbox"/>	
2		Signed Decimal	<input type="checkbox"/>	
3	Y0	Unsigned Decimal	<input type="checkbox"/>	
4	Y0.15	Hexadecimal	<input type="checkbox"/>	
5	H0	Octal	<input type="checkbox"/>	
6		Binary	<input type="checkbox"/>	
7	Y0.0	32bit Signed decimal	<input type="checkbox"/>	
8		32bit Unsigned decimal	<input type="checkbox"/>	
9	X0.0	32bit Hex	<input type="checkbox"/>	
10		32bit Octal	<input type="checkbox"/>	
11		32bit Binary	<input type="checkbox"/>	
12	D400	32bit Float	<input type="checkbox"/>	
13	D401	64bit Double	<input checked="" type="checkbox"/>	
14	D402	Signed Decimal	<input type="checkbox"/>	
15	D403	Signed Decimal	<input type="checkbox"/>	
16		Signed Decimal	<input type="checkbox"/>	
17	D400	Signed Decimal	<input type="checkbox"/>	32
18	D400	Signed Decimal	<input type="checkbox"/>	64
19	H0.123	Signed Decimal	<input type="checkbox"/>	
20		Signed Decimal	<input type="checkbox"/>	
21	C0	Signed Decimal	<input type="checkbox"/>	
22		Signed Decimal	<input type="checkbox"/>	
23		Signed Decimal	<input type="checkbox"/>	
24		Signed Decimal	<input type="checkbox"/>	
25		Signed Decimal	<input type="checkbox"/>	
26		Signed Decimal	<input type="checkbox"/>	
27		Signed Decimal	<input type="checkbox"/>	
28		Signed Decimal	<input type="checkbox"/>	
29		Signed Decimal	<input type="checkbox"/>	
30		Signed Decimal	<input type="checkbox"/>	

Item	Description
Table name	To name your table, you can use up to 16 characters from the following characters, A through Z (case-insensitive), 0 through 9, _ (underscore), (comma) and . (dot).
Device quantity	Device quantity to be monitored; default: read only
Default update cycle	Set up the updated cycle time; default: 5 seconds; unit: second
“Edit”	Click “Edit” to edit the table and the table name column turns green. The table contents appear below.
“Delete”	Click “Delete” to delete the table and its contents.

Item	Description
Device	Devices to be monitored; you can enter the following devices to monitor xX, yY, mM, sSmM, sSrR, dD, sS, tT, cC, hHcC and eE.
Radix	Positional numeral system to be shown on the monitoring page; available formats are Signed decimal, Unsigned decimal, Hexadecimal, Octal, Binary, 32bit Signed decimal, 32bit Unsigned decimal, 32bit Hexadecimal, 32bit Octal, 32bit Binary, 32bit Float and 64bit Double
Read only	Set up the monitored devices to read only or not.
Description	Add a description here for the table.
“Apply”	Click “Apply” to save the settings.

● **Operation Steps:**

- a. After log in, double-click **Data monitor setup** to open the setting page.

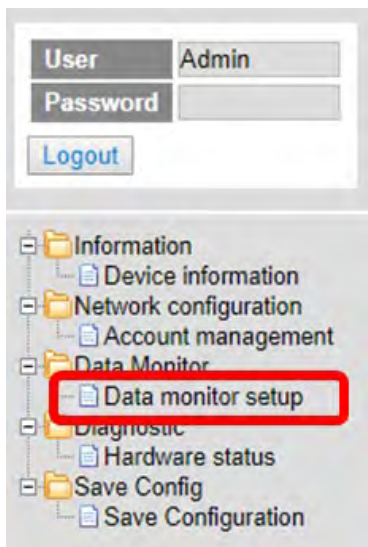

- b. Use “Edit” to edit the table name, device quantity, and update cycle time.

Data monitor setup

No.	Table name	Device quantity	Default update cycle (1s-60s)	Edit	Delete
1	Table_1	17	1	Edit	Delete
2		0	10	Edit	Delete
3	Table_3	0	1	Edit	Delete
4	Elevator	0	10	Edit	Delete

c. The corresponding table contents appear below.

Table name: Elevator				
No.	Device	Radix	Read only	Description
1		Signed Decimal ▼	<input type="checkbox"/>	
2		Signed Decimal ▼	<input type="checkbox"/>	
3		Signed Decimal ▼	<input type="checkbox"/>	
4		Signed Decimal ▼	<input type="checkbox"/>	
5		Signed Decimal ▼	<input type="checkbox"/>	

d. Edit the devices to be monitored, radix to be shown, read only or not and the description. After editing, click “Apply” to save the setting.

Table name: Elevator				
No.	Device	Radix	Read only	Description
1	M0	Binary ▼	<input type="checkbox"/>	
2		Signed Decimal ▼	<input type="checkbox"/>	
3	Y0	Signed Decimal ▼	<input type="checkbox"/>	
4	Y63.15	Binary ▼	<input type="checkbox"/>	
5	HC0	32bit Octal ▼	<input type="checkbox"/>	
6		Signed Decimal ▼	<input type="checkbox"/>	
7	Y0.0	Binary ▼	<input type="checkbox"/>	
8		Signed Decimal ▼	<input type="checkbox"/>	
⋮				
28		Signed Decimal ▼	<input type="checkbox"/>	
29		Signed Decimal ▼	<input type="checkbox"/>	
30		Signed Decimal ▼	<input type="checkbox"/>	

⋮

Apply

e. Double-click **Save configuration** to open the setting page.

User	Admin
Password	
Logout	

- Information
 - Device information
- Network configuration
 - Account management
- Data Monitor
 - Data monitor setup
 - Table_1
 - Table_3
- Diagnostic
 - Hardware status
- Save Config
 - Save configuration**

- f. Click "Save" to save and download the settings to the device.

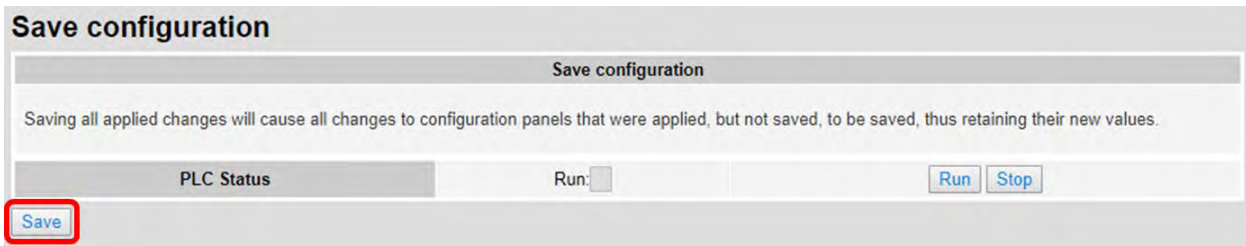

- g. Once the download is complete, you can see the newly added table to be monitored under the Data Monitor node.

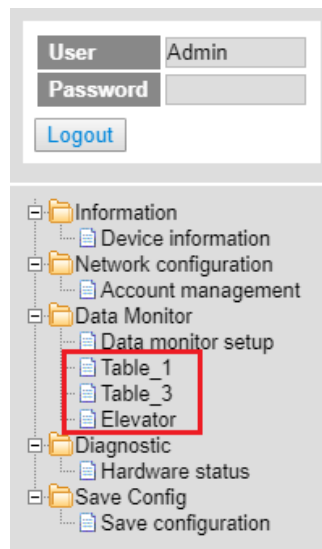

- h. Note: The data monitor table must be downloaded to the device otherwise even if the data monitor table is created, it cannot be monitored.

9.11.4.2 Data Monitor Table Pages

The setting results are shown as below.

No.	Device	Status	Value	Radix	Description	Set Status	Set value	Set
1	M0	<input type="checkbox"/>		Binary		<input type="button" value="ON"/> <input type="button" value="OFF"/>		<input type="button" value="Set"/>
2		<input type="checkbox"/>				<input type="button" value="ON"/> <input type="button" value="OFF"/>		<input type="button" value="Set"/>
3	Y0	<input type="checkbox"/>	K57	Signed Decimal		<input type="button" value="ON"/> <input type="button" value="OFF"/>	57	<input type="button" value="Set"/>
4	Y63.15	<input type="checkbox"/>		Binary		<input type="button" value="ON"/> <input type="button" value="OFF"/>		<input type="button" value="Set"/>
5	H00	<input type="checkbox"/>	000000000000	32bit Octal		<input type="button" value="ON"/> <input type="button" value="OFF"/>		<input type="button" value="Set"/>
6		<input type="checkbox"/>				<input type="button" value="ON"/> <input type="button" value="OFF"/>		<input type="button" value="Set"/>
7	Y0.0	<input checked="" type="checkbox"/>		Binary		<input type="button" value="ON"/> <input type="button" value="OFF"/>		<input type="button" value="Set"/>
8		<input type="checkbox"/>				<input type="button" value="ON"/> <input type="button" value="OFF"/>		<input type="button" value="Set"/>
9	X0.0	<input type="checkbox"/>		Binary		<input type="button" value="ON"/> <input type="button" value="OFF"/>		<input type="button" value="Set"/>
10		<input type="checkbox"/>				<input type="button" value="ON"/> <input type="button" value="OFF"/>		<input type="button" value="Set"/>
11		<input type="checkbox"/>				<input type="button" value="ON"/> <input type="button" value="OFF"/>		<input type="button" value="Set"/>
12	D400	<input type="checkbox"/>	H3576	Hexadecimal		<input type="button" value="ON"/> <input type="button" value="OFF"/>		<input type="button" value="Set"/>
13	D401	<input type="checkbox"/>	H4641	Hexadecimal		<input type="button" value="ON"/> <input type="button" value="OFF"/>		<input type="button" value="Set"/>
14	D402	<input type="checkbox"/>	H8000	Hexadecimal		<input type="button" value="ON"/> <input type="button" value="OFF"/>		<input type="button" value="Set"/>
15	D403	<input type="checkbox"/>	H4048	Hexadecimal		<input type="button" value="ON"/> <input type="button" value="OFF"/>		<input type="button" value="Set"/>
16		<input type="checkbox"/>				<input type="button" value="ON"/> <input type="button" value="OFF"/>		<input type="button" value="Set"/>
17	D400	<input type="checkbox"/>	12365.365	32bit Float	32	<input type="button" value="ON"/> <input type="button" value="OFF"/>		<input type="button" value="Set"/>
18	D400	<input type="checkbox"/>	55.000	64bit Double	64	<input type="button" value="ON"/> <input type="button" value="OFF"/>		<input type="button" value="Set"/>

Item	Description
Table name	Name of the table; read only
Monitor status	Status of the monitoring; read only Yellow light: reading, Green light: reading complete, Red light: reading error
Update cycle	Update cycle time; default is what you set up in data monitor setup page; unit: second
“-“	Minus; click once to decrease 1; the minimum value is 1
“+“	Plus; click once to increase 1; the maximum value is 60
Floating format setting	Floating point setting; round down; default: round the number down to three decimal places
Device	Devices to be monitored; read only
Radix	Positional numeral system to be shown on the monitoring page; available formats are Signed decimal, Unsigned decimal, Hexadecimal, Octal, Binary, 32bit Signed decimal, 32bit Unsigned decimal, 32bit Hexadecimal, 32bit Octal, 32bit Binary, 32bit Float and 64bit Double
Description	Add a description here for the table; read only
Status	Status of bit; read only Green LED: ON; No LED: OFF
Value	Values in devices to be monitored; read only Signed decimal: K+ Number Unsigned decimal: K+ Number Hexadecimal: H + hex Number Octal: O + octal Number Binary: B + binary Number 32bit Signed decimal: K+ Number 32bit Unsigned decimal: K+ Number 32bit Hexadecimal: H + hex Number 32bit Octal: O + octal Number 32bit Binary: B + binary Number 32bit Float: float Number 64bit Double: float Number
“On” / “Off”	“ON”: the status of Bit is ON. “OFF”: the status of Bit is OFF. ● If the authority level for the logged in user is READ, this column is read only.
Set Value	Change the value for the device to be monitored ● Type the value in and click “SET” and the changed value appears in the VALUE column as the image shown above. ● If the authority level for the logged in user is READ, this column is read only.
“Set”	Click “Set” to confirm the changed value. ● If the authority level for the logged in user is READ, this column is read only.

9.11.5 Diagnostic

You can set diagnostic related configurations here.

9.11.5.1 Hardware Status Page

This page displays information on hardware status, CPU module, power module, and function cards. You can set CPU to run or stop. Here also shows the CPU running status and error codes.

- For AS300, the hardware status page looks like below.

Hardware status

Refresh cycle (1s ~ 60s): - 10 +

Extension No.	Module name	Status	Error code
Power module			
CPU module	AS332T-A <input type="button" value="Run"/> <input type="button" value="Stop"/>	Run: <input type="checkbox"/> Err: <input type="checkbox"/>	
---Function card 1			
---Function card 2			
Module 1	AS00SCM-A	<input type="checkbox"/>	
---Function card 1	AS-F485		
---Function card 2	AS-F485		

- For AS200, the hardware status page looks like below.

Hardware status

Refresh cycle (1s ~ 60s): - 10 +

Extension No.	Module name	Status	Error code
Power module			
CPU module	AS228T-A <input type="button" value="Run"/> <input type="button" value="Stop"/>	Run: <input type="checkbox"/> Err: <input type="checkbox"/>	
Module 1	AS00SCM-A	<input type="checkbox"/>	
---Function card 1	AS-F485		
---Function card 2	AS-F485		

- For AS100, the hardware status page looks like below.

Hardware status

Refresh cycle (1s ~ 60s): - 10 +

Extension No.	Module name	Status	Error code
Power module			
CPU module	AS164T <input type="button" value="Run"/> <input type="button" value="Stop"/>	Run: <input type="checkbox"/> Err: <input type="checkbox"/>	
Module 1	AS00SCM-A	<input type="checkbox"/>	
---Function card 1	AS-F485		
---Function card 2	AS-F485		

Item	Description
Refresh cycle	Refresh cycle time; default: 10; unit: second
“-“	Minus; click once to decrease 1; the minimum value is 1
“+“	Plus; click once to increase 1; the maximum value is 60
Power module name	Name of the power module; read only
CPU module name	Name of the CPU module; read only
CPU Run LED	LED of CPU running status; read only Green light: RUN LED Not Lit: STOP
CPU Error LED	LED of CPU Error; read only
CPU Error code	Error codes of CPU module; read only
“Run” / “Stop”	Click “RUN” to set the running status to RUN Click “Stop” to set the running status to STOP <ul style="list-style-type: none"> ● If the authority level for the logged in user is WRITE/READ or READ, this column is read only.
Function card name	Name of the function card; read only <ul style="list-style-type: none"> ● For communication module, two extra rows for the names of the communication function cards are shown here
Module name	Name of the module; read only When the actual placement is not the same as the arrangement in HWCONFIG, the background of this column will be in red.
Module Error LED	LED of module error; read only
Module Error code	Error codes of module; read only

9.11.6 Configurations

9.11.6.1 Save Configuration Page

You can save the configurations and download the parameters to your device here.

Save configuration

Save configuration

Saving all applied changes will cause all changes to configuration panels that were applied, but not saved, to be saved, thus retaining their new values.

PLC Status

Run:

Item	Description
“Save”	Download the saved parameters to the device.
PLC Status	LED of PLC running status; read only Green light: RUN LED Not Lit: STOP
“Run” / “Stop”	Click “RUN” to set the running status to RUN Click “Stop” to set the running status to STOP

Note: The data monitor table must be downloaded to the device. If not, once you log out, close the page or restart the PLC, all the temporary saved parameters will be cleared.

Chapter 10 CANopen Function and Operation

Table of Contents

10.1 Introduction to CANopen	10-2
10.1.1 CANopen Function Descriptions.....	10-2
10.1.2 The Input/Output Mapping Areas.....	10-4
10.1.3 Refreshing Mechanism in the Input/Output Mapping Areas	10-5
10.2 Installation and Network Topology	10-9
10.2.1 The Dimensions of AS-FCOPM.....	10-9
10.2.2 AS-FCOPM on AS300 PLC	10-9
10.2.3 Configure the AS-FCOPM with HWCONFIG	10-10
10.2.4 The CAN Interface and Network Topology	10-11
10.3 The CANopen Protocol	10-16
10.3.1 Introduction to the CANopen Protocol	10-16
10.3.2 The CANopen Communication Object	10-17
10.3.3 The Predefined Connection Set.....	10-22
10.4 Sending SDO, NMT and Reading Emergency Message through the Ladder Diagram	10-24
10.4.1 Data Structure of SDO Request Message	10-24
10.4.2 Data Structure of NMT Message	10-27
10.4.3 Data Structure of EMERGENCY Request Message	10-28
10.4.4 Example of Sending SDO through the Ladder Diagram	10-30
10.5 Troubleshooting	10-32
10.5.1 CANopen Network Node State Display	10-32
10.6 Application Example	10-35
10.7 Object Dictionary	10-43

10.1 Introduction to CANopen

1. Because of its simple wiring, immediate and stable communication, strong debugging ability, and low cost, the CANopen network is widely used in fields such as industrial automation, the automotive industry, the medical equipment industry, and the building trades.
2. The AS300 Series PLC is compatible with CANopen when using the AS-FCOPM function card for the CAN port, and can work in master mode or slave mode. The CAN port conforms to the basic communication protocol CANopen DS301. It supports master and slave modes.
3. AS200 Series PLC is built with CAN communication port. The CAN port conforms to the basic communication protocol CANopen DS301. It supports master and slave modes.
4. This chapter explains the functions of CANopen. In master mode, CANopen can support up to 64 slaves, station addresses 1~64.
5. CANopen Builder is the CANopen network configuration software for the AS Series. You set the CANopen station address and the communication rate with this software. ISPSOft / DIADesigner is the programming software for the AS Series.
6. This chapter mainly focuses on the CANopen functions. Refer to Section 10.3 for more information.

10.1.1 CANopen Function Descriptions

The CAN port has the following functions when acting as a master.

1. It supports the standard CANopen protocol DS301 V4.02.
2. It supports the NMT (network management object) service.
 - It supports NMT state control.
Use NMT state control to control the state of a slave in the CANopen network.
 - It supports NMT error control.
Use NMT error control detect the disconnection of a slave. The NMT error control is classified into two types; Heartbeat and Node Guarding. The AS Series PLC does not support Node Guarding.
3. It supports the PDO (Process Data Object) service.
 - Use PDO messaging to transmit immediate input and output data.
 - It supports up to 256 RxPDO and 1894 bytes.
 - It supports up to 256 TxPDO and 1894 bytes.
 - It supports synchronous and asynchronous modes for the PDO transmission type.
4. It supports the SDO (Service Data Object) service.
 - Use SDO to read, write, or configure the slave parameters.
 - It supports standard SDO transmission mode.
 - It supports automatic SDO functions. You can write up to 20 pieces of data to a slave.
 - It supports using the SDO service in a PLC ladder diagram to read the data from a slave or write the data to a slave.

5. It supports the reading emergencies from a slave service.
 - Use this service to read an error or an alarm from a slave.
 - You can store up to 5 emergencies in a slave.
 - You can read emergencies from a slave through a PLC ladder diagram.
6. It supports the SYNC object (synchronous object) service.
7. Several devices can operate synchronously through the synchronous object service.
8. The supported CANopen communication rates are: 20K, 50K, 125K, 250K, 500K, and 1Mbps.

The supported mapping data types are:

Storage	Data type
8-bit	SINT USINT BYTE
16-bit	INT UINT WORD
32-bit	DINT UDINT REAL DWORD
64-bit	LINT ULINT LREAL LWORD

The CAN port has the following functions when acting as a slave.

- It supports the standard CANopen protocol DS301 V4.02.
- It supports the NMT (network management object) service.
 - It supports the NMT state control.
The state of the AS series in the CANopen network is controlled by a master.
 - It supports the NMT error control.
The AS Series supports Heartbeat but not Node Guarding.
- It supports the PDO (process data object) service.
 - The PDO message transmits the immediate input data and output data.
 - It supports up to 8 TxPDO and 8 RxPDO.
 - The PDO transmission type: synchronous mode and asynchronous mode
- It supports the emergency service.
If an error or an alarm occurs in the AS series, the master is notified through the emergency service.

10.1.2 The Input/Output Mapping Areas

The following table lists the CANopen DS301 specifications for the AS series PLC.

Type	Item	Description
Master	Maximum slave nodes	Up to 64 nodes
	Maximum transfer size of a PDO (Read + Write)	Up to 2000 Bytes (including some system configurations)
Slave	Maximum transfer size of a PDO (Read + Write)	Up to 8 PDOs; each PDO with up to 8 bytes can be transferred at a time

When the AS Series PLC acts as a Master, the output mapping areas are D25000-D25999, and the input mapping areas are D24000-D24999, as the following table shows.

Device in the PLC	Mapping area	Mapping length
D25000–D25031	SDO request information, NMT service information, and Emergency request information	64 bytes
D24000–D24031	SDO reply information, and Emergency reply information	64 bytes
D25032–D25978	RxPDO mapping area (Master → Slave)	1894 bytes
D24032–D24978	TxPDO mapping area (Master ← Slave)	1894 bytes

When the AS Series PLC acts as a Slave, the output mapping areas are D25032–25063, and the input mapping areas are D24032–24063 as the following table shows.

Device in the PLC	Mapping area	Mapping length
D24032–24063	RxPDO mapping area (Slave ← Master)	64 bytes
D25032–25063	TxPDO mapping area (Slave → Master)	64 bytes

10.1.3 Refreshing Mechanism in the Input/Output Mapping Areas

When AS PLC CPU acts as a Master, the factors including PLC scan time and the synchronization options affect the refreshing mechanism for data mapping in the input/output mapping area. Here we list three scenarios in synchronous mode and one scenario in non-synchronous mode for your reference.

- **Synchronous mode**

- **Scenario A: $\frac{1}{2}$ synchronization cycle time (for the slave to send data) > PLC scan time**

A half of the synchronization cycle time is longer than a PLC scan time: at least one PDO will be sent within one synchronization cycle time.

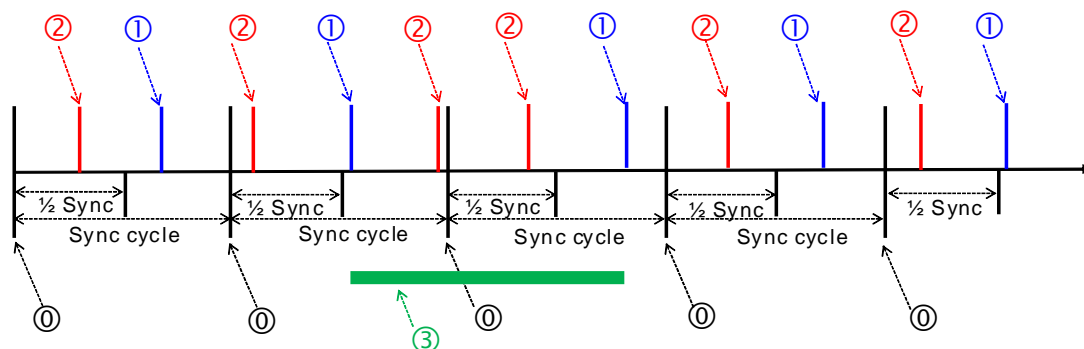

Explanation:

⓪: Once the synchronization cycle starts, the timer starts to count. The counted time should be longer than a half of the set synchronization time (a rounded-down number) for Master to send PDO to Slave.

①: After PLC scan time ends, PLC CPU refreshes to update the synchronization task:
PLC CPU sends PDO and then clears the counted time.

②: After PLC scan time ends, PLC CPU refreshes to update the synchronization task:
The counted time of the synchronization cycle is less than half of the synchronization cycle time (for the slave to send data), or the PDO had already been sent before, the PDO here cannot be sent and the time of the synchronization cycle continues to be counted.

③: From the cases in the green section, we know that the time for the PDO to be sent does NOT equal to the time to perform synchronization, but what we can be sure is that a Master can send at least one PDO within every synchronization cycle.

Scenario B:

Synchronous mode; $\frac{1}{2}$ synchronization cycle time (for the slave to send data) \leq PLC scan time $<$ synchronization cycle time

A half of the synchronization cycle time is less than a PLC scan time and the PLC scan time is less than or equals to a whole synchronization cycle time: it is possible that zero PDO will be sent during a synchronization cycle.

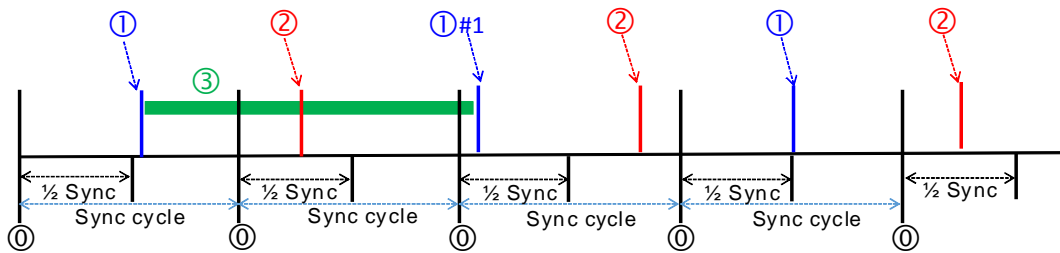

Explanation:

①: Once the synchronization cycle starts, the timer starts to count. The counted time should be longer than a half of the set synchronization time (a rounded-down number) for Master to send PDO to Slave.

①: After PLC scan time ends, PLC CPU refreshes to update the synchronization task: PLC CPU sends PDO and then clears the counted time.

①#1: There was no PDO sent from the previous synchronization cycle. Before PLC scan time ends, the next synchronization cycle comes and the counted time is longer than a half of the set synchronization time (a rounded-down number), PLC CPU sends PDO and then clears the counted time.

②: After PLC scan time ends, PLC CPU refreshes to update the synchronization task: The counted time of the synchronization cycle is less than half of the synchronization cycle time (for the slave to send data), the PDO here cannot be sent and the time of the synchronization cycle continues to be counted.

③: From the cases in the green section, we know that the time for the PDO to be sent does NOT equal to the time to perform synchronization, and it is possible that Master can send zero PDO during a synchronization cycle.

Scenario C:**Synchronous mode; synchronization cycle time \leq PLC scan time**

The synchronization cycle time is less than a PLC scan time: it is possible that zero PDO will be sent during a synchronization cycle.

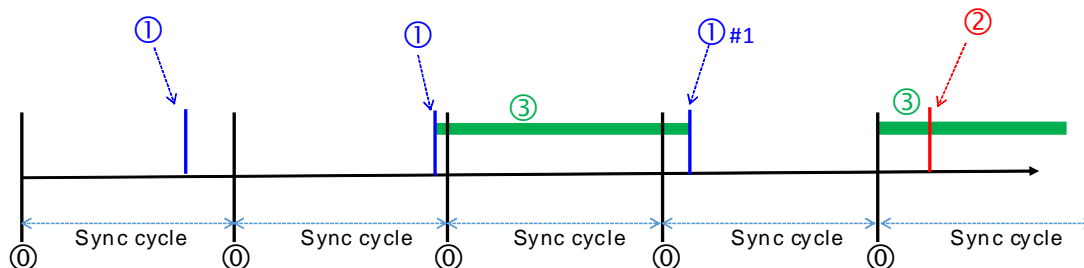
**Explanation:**

①: Once the synchronization cycle starts, the timer starts to count. The counted time should be longer than a half of the set synchronization time (a rounded-down number) for Master to send PDO to Slave.

①: After PLC scan time ends, PLC CPU refreshes to update the synchronization task: PLC CPU sends PDO and then clears the counted time.

①#1: There was no PDO sent from the previous synchronization cycle. Before PLC scan time ends, the next synchronization cycle comes and the counted time is longer than a half of the set synchronization time (a rounded-down number), PLC CPU sends PDO and then clears the counted time.

②: After PLC scan time ends, PLC CPU refreshes to update the synchronization task: The counted time of the synchronization cycle is less than half of the synchronization cycle time (for the slave to send data), the PDO here cannot be sent and the time of the synchronization cycle continues to be counted.

③: From the cases in the green section, we know that the time for the PDO to be sent does NOT equal to the time to perform synchronization, and it is possible that Master can send zero PDO during a synchronization cycle. The chance of Master not sending any PDO during a synchronization cycle is higher than what happened in scenario B.

● **Non-synchronous mode**

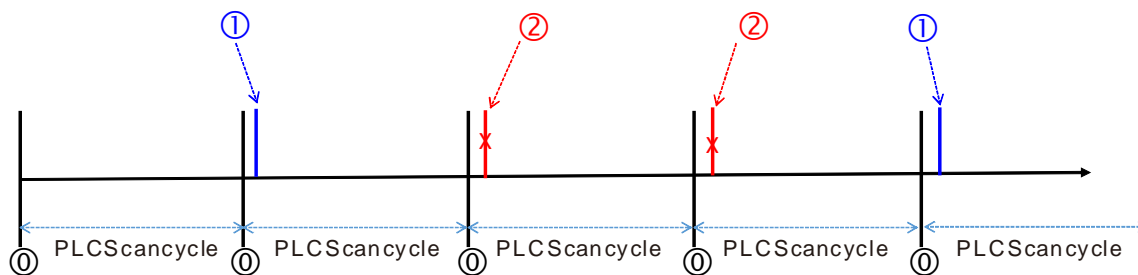

Explanation:

①: After PLC scan time ends, PLC CPU refreshes to update the task of sending PDO.

②: If the data in PDO changes, PLC CPU sends PDO.

③: The data in PDO remains the same, the PDO here is NOT sent.

Note: You can use the function of setting up the PLC scan time to ensure PLC CPU checks the task of sending PDO in every set scan time.

10.2 Installation and Network Topology

This section introduces the physical dimensions of AS-FCOPM function card, the HWCONFIG settings of the AS Series, the CAN interface, the CANopen network framework, and the maximum communication distance.

10.2.1 The Dimensions of AS-FCOPM

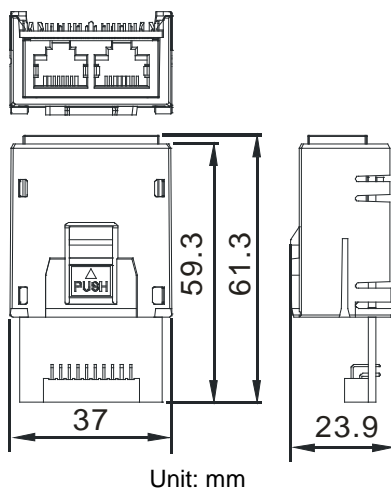

10.2.2 AS-FCOPM on AS300 PLC

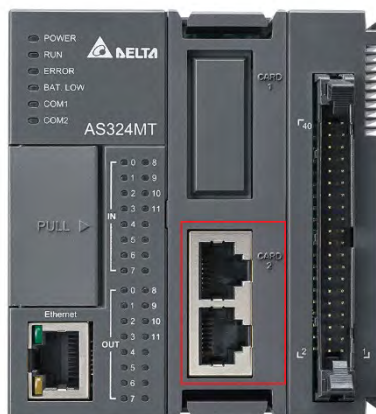

Note: the AS-FCOPM card can only be installed in the Card 2 slot in the AS series

10.2.3 Configure the AS-FCOPM with HWCONFIG

This section uses ISPSOft for demonstration. For DIADesigner operation, refer to Chapter 6 from DIADesigner software manual.

Before using the AS-FCOPM card in an AS300 Series PLC, use HWCONFIG in ISPSOft to configure the AS-FCOPM card. If you are using an AS100 or AS200 Series PLC, the first two steps can be ignored.

1. You can only install the AS-FCOPM in the card 2 slot as marked in red below. Double click the function card 2 slot to go to the Device Setting dialog box.



2. Select **Manual** for **Card 2 Detect mode** and select **AS-FCOPM Card** for **Manual Select Card**.

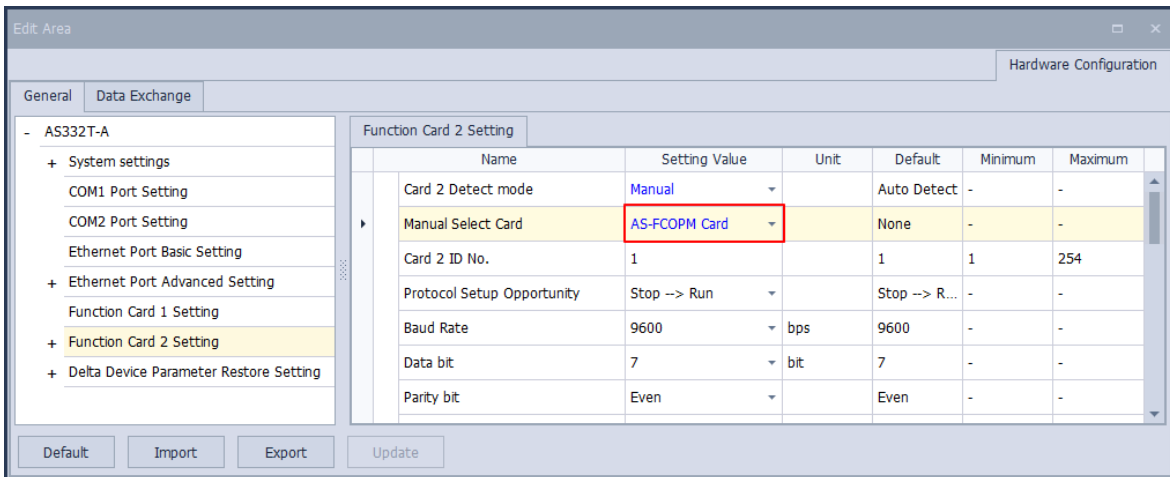

3. Select the working mode, node ID and the bit rate for AS-FCOPM.

- * Working mode: CANopen DS301
- * Node ID: 1
- * Bit rate: 125k bps (the default, or you can select your own bit rate)

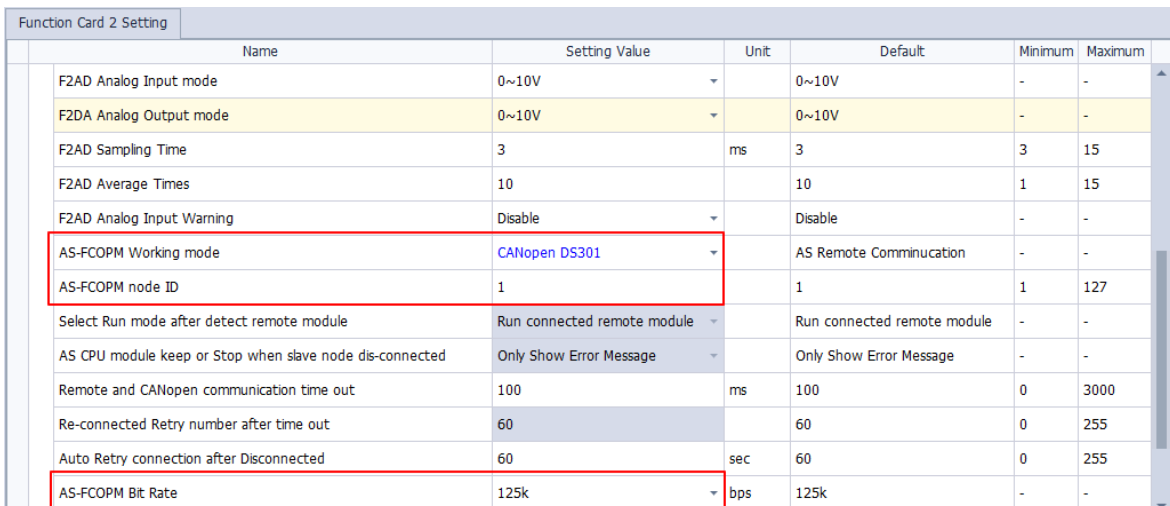

- When finished, click the **Download** button on the toolbar to download the settings to the PLC.

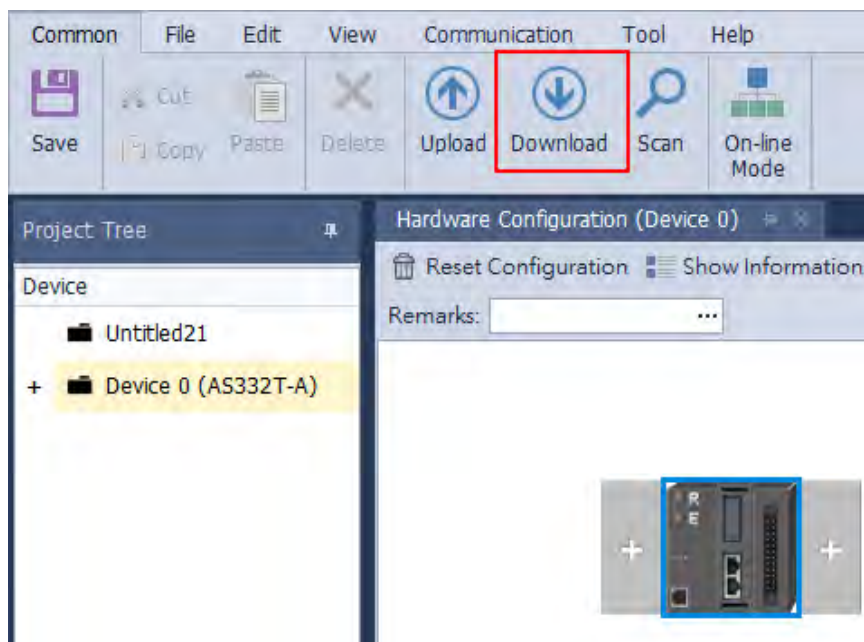

10.2.4 The CAN Interface and Network Topology

10.2.4.1 Definitions of the CAN Signal and Data Types

The CAN signal is a differential signal. The voltage of the signal is the voltage difference between CAN+ and CAN-. The CAN+ and CAN- voltages take SG as a reference point. The CAN network can be in one of two states. One state is a dominant level, and is indicated by the logical "0". The other state is a recessive level, and is indicated by the logical "1". The CAN signal level shows below.

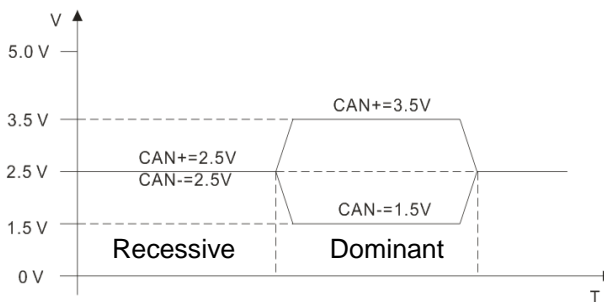

The following picture shows the data frame format. The CAN nodes transmit the CAN messages to the network from left to right.

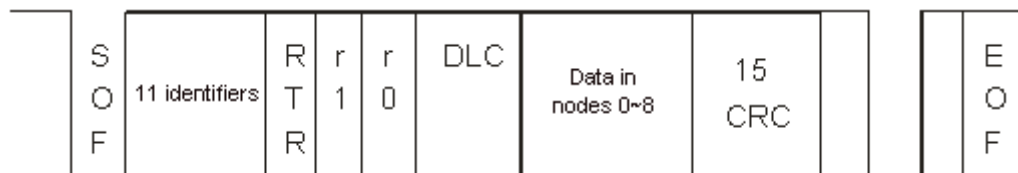

10.2.4.2 The CAN Network Endpoint and the Topology Structure

In order to make the CAN communication more stable, the two endpoints of the CAN network are connected to 120 ohm terminal resistors. The topology structure of the CAN network appears below.

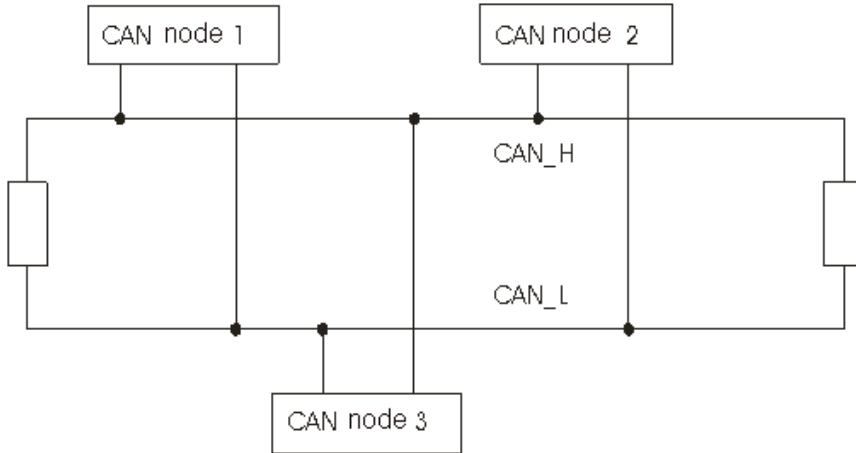

10.2.4.3 The Topology Structure of the CANopen Network

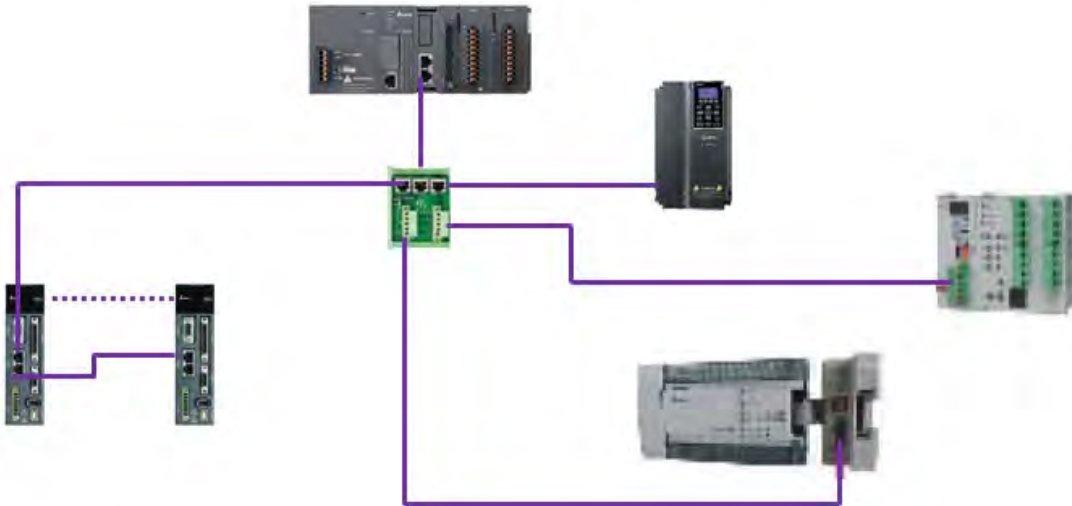











- 1) Use standard Delta cables when wiring the CANopen network. These cables are the thick cable UC-DN01Z-01A, the thin cable UC-DN01Z-02A, and the thin cable UC-DN01Z-02A. Separate the communication cables from any power cables to avoid interference.
- 2) Connect the CAN+ (white) and CAN- (blue), which are at the endpoints of the network, to 120 ohm resistors. The AS-FCOPM card is equipped with a 120 ohm resistor switch; you can enable the resistor with the switch. Purchase the standard Delta terminal resistor for use with the other devices and the RJ45 connector.
- 3) Note the limitation on the length of the CANopen network. The transmission distance of the CANopen network depends on the transmission rate of the CANopen network. The following table shows the relation between the transmission rate and the maximum communication distance.

Transmission rate (bit/seconds)	20K	50K	125K	250K	500K	1M
Maximum communication distance (meters)	2500	1000	500	250	100	25

4) The list below shows the Delta network products for the CANopen network.

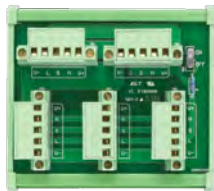
Product	Model	Function
	AS332T-A AS332P-A AS324MT-A AS320T-B AS320P-B AS300N-A	The AS300 series PLC can function as the CANopen master or slave when you install an AS-FCOPM function card. The AS-FCOPM is equipped with a 120 ohm resistor controlled by a switch.
	AS228T-A AS228P-A AS228R-A AS218TX-A AS218PX-A AS218RX-A	AS200 Series PLC is built with CAN communication port. The CAN port conforms to the basic communication protocol CANopen DS301. It supports master and slave modes. The CAN communication terminal is equipped with a 120 Ω resistor. You can use a short circuit to use this resistor.
	AS132P-A AS132T-A AS132R-A AS148P-A AS148T-A AS148R-A AS164P-A AS164T-A AS164R-A	AS100 Series PLC is built with CAN communication port. The CAN port conforms to the basic communication protocol CANopen DS301. It supports master and slave modes.
	DVP32ES300R DVP32ES300T DVP32ES311T DVP48ES300R DVP48ES300T DVP64ES300R DVP64ES300T DVP80ES300R DVP80ES300T	The DVP-ES3-C series PLC has a built-in CAN interface. The CAN port conforms to the basic communication protocol CANopen DS301. It supports master and slave modes.
	DVP32ES200RC DVP32ES200TC	The DVP-ES2-C series PLC has a built-in CAN interface. The CAN port conforms to the basic communication protocol CANopen DS301. It supports master and slave modes.
	DVPCOPM-SL	DVPCOPM-SL is a module connected to the left side of an S series PLC. It can function as the CANopen master or slave. The PLCs that you can connect to the DVPCOPM-SL are the DVP-28SV, DVP-28SV2, DVP-SX2, DVP-SA2, and DVP-EH2-L.

Product	Model	Function
	IFD9503	<p>The IFD9503 gateway converts CANopen to Modbus, and connects a device (with an RS-232 or RS-485 interface) that conforms to the standard Modbus protocol to a CANopen network. You can connect up to 15 devices.</p>
	DVPCP02-H2	<p>The CANopen slave module is connected to the right side of an EH2 series PLC. It can connect the EH2 series PLC to a CANopen network.</p>
	IFD6503	<p>This analyzes CANopen network data, and has ports both ends for a CAN interface and a USB interface. Use it to monitor CAN network data, or allow CAN nodes to transmit the data. The product is used with the Netview Builder software.</p>
	ASD-A2-xxxx-M servo driver	<p>This servo driver has a built-in CANopen interface. It controls positioning, speed, and torque.</p>
	VFD-C2000/CP2000/C200 series AC motor drives	<p>This AC motor drive has a built-in CANopen function, and controls positioning, speed, and torque. For the C2000/CP2000 series AC motor drives, you must purchase a CMC-COP01 to provide the CAN interface. Only the C200 series AC motor drive has the built-in CANopen interface.</p>
	VFD-EC series AC motor drive	<p>The EC series AC motor drive has a built-in CANopen interface. It controls speed and torque.</p>

Product	Model	Function
	TAP-CN01	This CANopen network topology distribution box has a 120 ohm resistor enabled with a switch.
	TAP-CN02	This CANopen network topology distribution box has a 120 ohm resistor enabled with a switch.
	TAP-CN03	This CANopen network topology distribution box has a 120 ohm resistor enabled with switch.
	UC-CMC003-01A UC-CMC005-01A UC-CMC010-01A UC-CMC015-01A UC-CMC020-01A UC-CMC030-01A UC-CMC050-01A UC-CMC100-01A UC-CMC200-01A	UC- These CANopen sub cables have RJ45 connectors at both ends. UC-CMC003-01A: 0.3 meters UC-CMC005-01A: 0.5 meters UC-CMC010-01A: 1 meter UC-CMC015-01A: 1.5 meters UC-CMC020-01A: 2 meters UC-CMC030-01A: 3 meters UC-CMC050-01A: 5 meters UC-CMC100-01A: 10 meters UC-CMC200-01A: 20 meters
	UC-DN01Z-01A UC-DN01Z-02A	CANopen network cable UC-DN01Z-01A: CANopen main cable UC-DN01Z-02A: CANopen sub cable
	TAP-TR01	This 120 ohm resistor has an RJ45 connector.

10.3 The CANopen Protocol

10.3.1 Introduction to the CANopen Protocol

The CAN (controller area network) fieldbus only defines the physical layer and the data link layer of a network. See the ISO11898 standard for information. The CAN fieldbus does not define the application layer. In practice, the hardware contains the physical layer and the data link layer. The CAN fieldbus itself is not complete, and needs a superior protocol to define the use of 11/29-bit identifier and 8-byte data.

The CANopen protocol is the superior protocol based on the CAN fieldbus. It is one of the protocols defined and maintained by CiA (CAN-in-Automation) and was developed on the basis of the CAL (CAN application layer) protocol, using a subset of the CAL communication and service protocols.

The CANopen protocol contains the application layer and the communication profile (CiA DS301). It also contains a framework for programmable devices (CiA 302), recommendations for cables and connectors (CiA 303-1), and SI units and prefix representations (CiA 303-2).

In the OSI model, the relation between the CAN standard and the CANopen protocol is described in the following diagram.

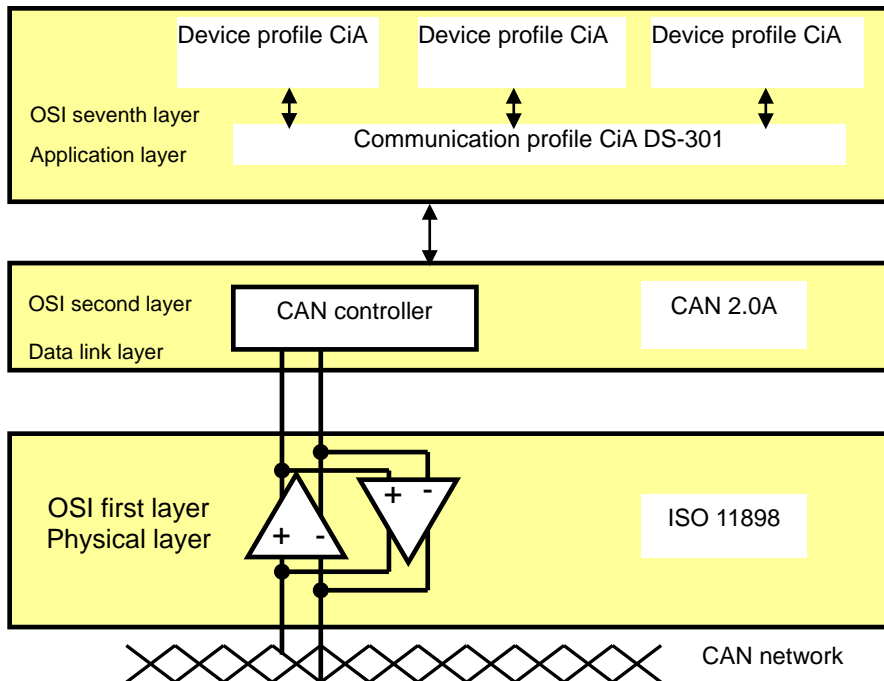

1. The object dictionary

CANopen uses an object-based method to define a standard device. Every device is represented by a set of objects and can be visited by the network. The diagram below illustrates the CANopen device model. The object dictionary is the interface between the communication program and the superior application program.

The core concept of CANopen is the device object dictionary (OD). It is an orderly set of objects. Every object has a 16-bit index for addressing and also defines an 8-bit subindex. Every node in the CANopen network has an object dictionary that includes the parameters that describe the device and the network behavior. The object dictionary of a node is also described in the electronic data sheet (EDS) for the device.

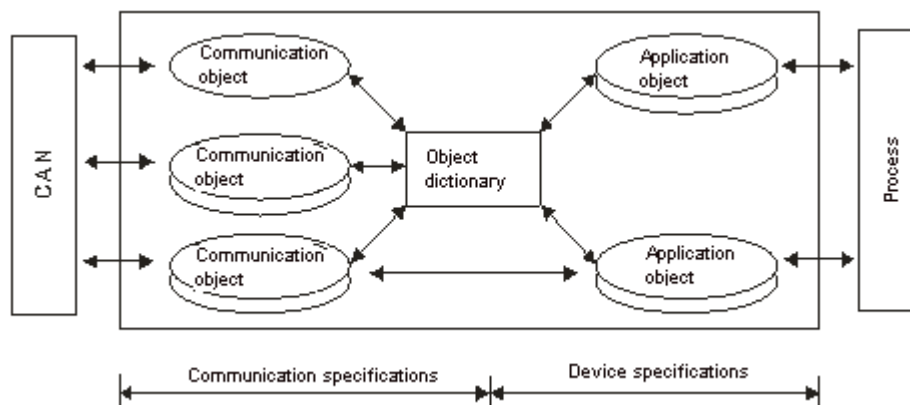

10.3.2 The CANopen Communication Object

The CANopen communication protocol contains the following communication objects.

1. PDO (process data object)

- The PDO provides the direct channel for the device application object, and transmits the real-time data. It has high priority. Every byte in the PDO CAN message data list transmits data, and the message usage rate is high.
- There are two kinds of uses for PDOs; data transmission and data reception. They are distinguished by Transmit-PDOs (TxPDOs) and Receive-PDOs (RxPDOs). Devices supporting TxPDOs are called PDO producers, and devices that receive PDOs are called PDO consumers.
- The PDO is described by the “producer/consumer mode”. The data transmits from one producer to one or many consumers. The data that can be transmitted is limited to between 1-byte and 8-byte data. After the producer transmits the data, the consumer does not need to reply to the data. Every node in the network detects the transmitted data and decides whether to process the received data .
- Every PDO is described by two objects in the object dictionary: the PDO communication parameters and the PDO mapping parameters

PDO communication parameters: the COB-ID used by PDO, the transmission type, the prohibition time, and the counter cycle

PDO mapping parameters: the object list in an object dictionary. These objects are mapped into the PDO, including the data length (in bits). To explain the contents of the PDO, the producer and the consumer both have to understand the mapping.

The PDO transmission modes: synchronous and asynchronous

Synchronous mode: synchronous periodic and synchronous non-periodic

Asynchronous: The producer transmits the PDO when the data changes, or after a trigger.

The following table lists supported transmission modes.

Type	PDO transmission				
	Periodic	Non-periodic	Synchronous	Asynchronous	RTR
0		X	X		
1 – 240	X		X		
254				X	
255				X	

Mode 0: The PDO information is transmitted only when the PDO data changes and the synchronous signal is received.

Modes 1–240: One piece of PDO information is transmitted every 1–240 synchronous signals.

Mode 254: The trigger is defined the manufacturer. The definition in the PLC is the same as mode 255.

Mode 255: The PDO is transmitted when the data changes, or it is transmitted after a trigger.

All the data in the PDO has to be mapped from the object dictionary. The following diagram shows an example of PDO mapping.

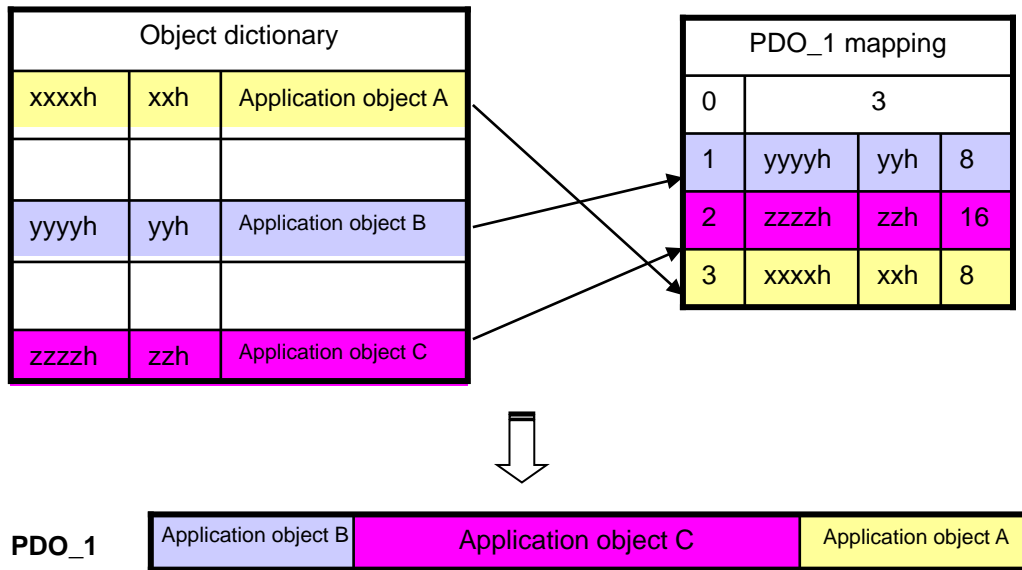

The following table shows the data format for RxPDO and TxPDO.

COB-ID	Byte 0	Byte 1	Byte 2	Byte 3	Byte 4	Byte 5	Byte 6	Byte 7
Object identifier	Data							

2. SDO (service data object)

- The SDO builds the client/server relation between two CANopen devices. The client device can read the data from the object dictionary on the server device and write the data into the object dictionary on the server device. The SDO visit mode is “client/server” mode. The mode which is visited is the SDO server. Every CANopen device has at least one service data object that provides the visit channel for the object dictionary of the device. SDO can read all the objects in the object dictionary, and write all objects into the object dictionary.
- The SDO message contains the index and subindex information used to position the objects in the object dictionary, and the composite data structure can easily be passed by the SDO visit. After the SDO client sends the reading/writing request, the SDO server replies. The client and the server can stop SDO transmission. The requested message and the reply message are separated by different COB-IDs.
- The SDO can transmit the data in any length. If the data length is more than 4 bytes, the data must be transmitted by segment. The last segment of the data contains an end flag.

- The following table shows the structures of the SDO requested message and reply message.

The format of the requested message:

COB-ID	Byte 0	Byte 1	Byte 2	Byte 3	Byte 4	Byte 5	Byte 6	Byte 7
600 (hex)	Requested code	Object index		Object subindex	Requested data			
+Node-ID		LSB	MSB		bit7-0	bit15-8	bit23-16	bit31-24

The definition of the requested code in the requested message:

Request code (hex)	Description
23	Writing 4-byte data
2B	Writing 2-byte data
2F	Writing 1-byte data
40	Reading data
80	Stopping the current SDO function

The format of the reply message:

COB-ID	Byte 0	Byte 1	Byte 2	Byte 3	Byte 4	Byte 5	Byte 6	Byte 7
580 (hex)	Reply code	Object index		Object subindex	Reply data			
+Node-ID		LSB	MSB		bit7-0	bit15-8	bit23-16	bit31-24

The definition of the reply code in the reply message:

Reply code (hex)	Description
43	Reading 4-byte data
4B	Reading 2-byte data
4F	Reading 1-byte data
60	Writing 1/2/4-byte data
80	Stopping the current SDO function

3. NMT (network management object)

The CANopen network management conforms to the master/slave mode. Only one NMT master exists in the CANopen network, and all other nodes are considered to be slaves. NMT includes three services: module control, error control, and boot-up services.

- **Module control services**

The master node in the CANopen network controls the slave by sending commands. The slave receives and executes the command, and does not need to reply. All CANopen nodes have internal NMT states. The slave node has four states: initialization, pre-operational, operational, and stop states. The following diagram illustrates the device states.

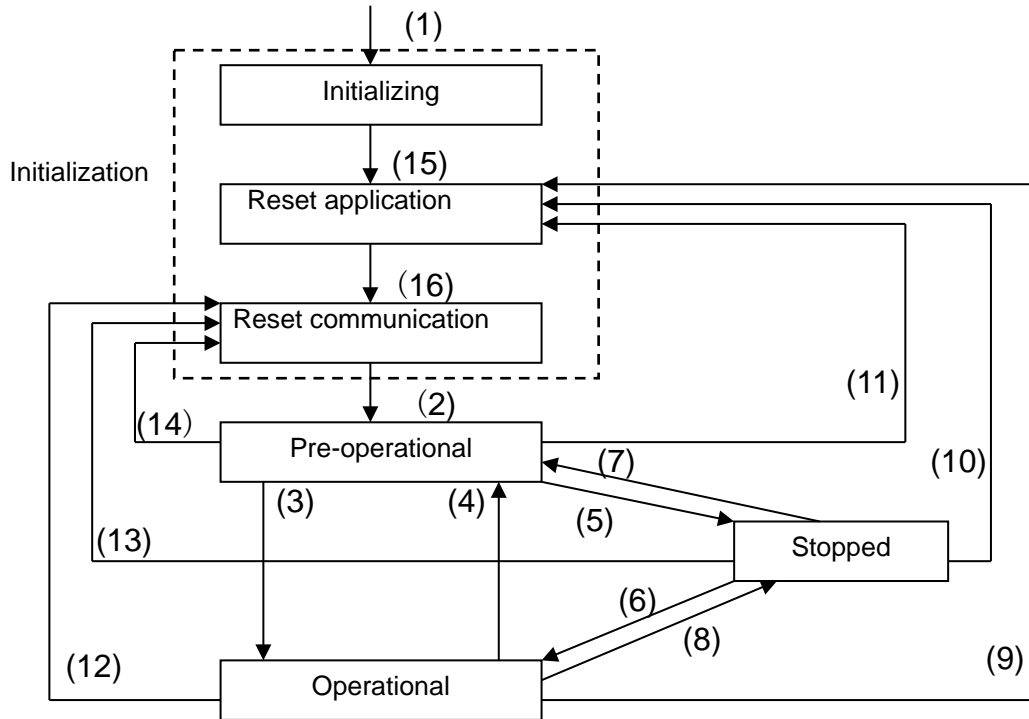

- (1) After power is supplied, the device automatically enters the initialization state.
- (2) After the initialization is complete, the device automatically enters the pre-operational state.
- (3)(6) The remote node starts.
- (4)(7) The device enters the pre-operational state.
- (5)(8) The remote node stops.
- (9)(10)(11) The application layer resets.
- (12)(13)(14) The communication resets.
- (15) After the initializing is complete, the device automatically enters the reset application state.
- (16) After the reset application state is complete, the device automatically enters the reset communication state.

The following table shows the relation between the communication object and the state. You can only execute the communication object service in the correct state. For example, you can only execute SDO in the operational state and pre-operational states.

	Initialization	Pre-operational	Operational	Stopped
PDO			X	
SDO		X	X	
SYNC		X	X	
Time Stamp		X	X	
EMCY		X	X	
Boot-up	X			
NMT		X	X	X

The control message format for the node state:

COB-ID	Byte 0	Byte 1
0	Command specifier (CS)	Slave address (0: Broadcast)

The command specifiers:

Command specifier (hex)	Function
01	Start the remote node
02	Stop the remote node
80	Enter the pre-operational state
81	Reset the application layer
82	Reset the communication

● **Error control services**

The error control service detects the disconnection of a network node. The error control services are classified into two types: Heartbeat and Node Guarding. The AS Series PLC only supports Heartbeat. For example, the master can detect the disconnection of the slave only after the slave enables the Heartbeat service.

The following illustrates the Heartbeat principle. The Heartbeat producer transmits the Heartbeat message according to the set Heartbeat producing time. One or many Heartbeat consumers detect the message transmitted by the Heartbeat producer. If the consumer does not receive the message transmitted by the producer within the timeout period, there is a problem in the CANopen communication or the producer is disconnected.

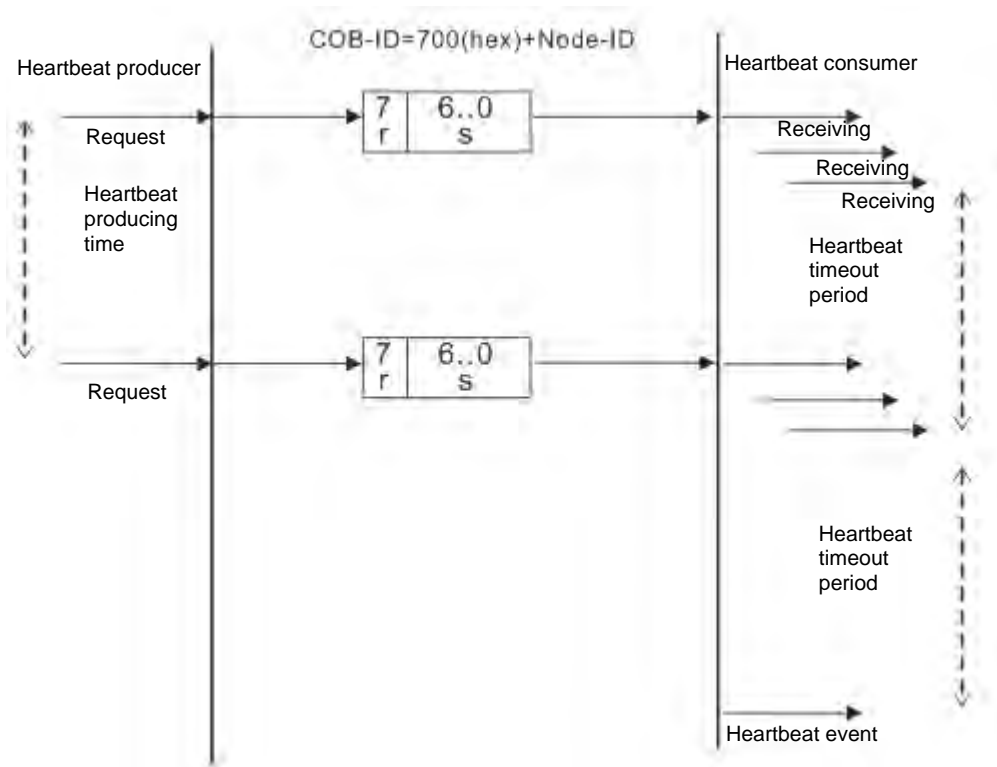

- **Boot-up services**

After the slave completes the initialization and enters the pre-operational state, it transmits the Boot-up message.

1. Other predefined CANopen communication objects (SYNC and EMCY)

- **SYNC Object (Synchronous object)**

The synchronous object is the message that the master node periodically broadcasts on the CANopen network. This object recognizes the network clock signal. Every device decides whether to use the event use synchronous communication with other network devices depending on its configuration. For example, when controlling a driving device, the devices do not act immediately after they receive the command sent by the master. They do act when they receive the synchronous message. This makes multiple devices act synchronously.

The format of the SYNC message:

COB-ID
80 (hex)

- **Emergency object**

The emergency object is used by a CANopen device to indicate an internal error. When an emergency error occurs in the device, the device sends the emergency message (including the emergency error code), and the device enters an error state. After the error is eliminated, the device sends another emergency message with emergency error code 0, and the device enters the normal state.

The format of the emergency message:

COB-ID	Byte 0	Byte 1	Byte 2	Byte 3	Byte 4	Byte 5	Byte 6	Byte 7
80 (hex) +Node-ID	Emergency error code		Error register	Factory-defined error code				
	LSB	MSB						

Note: The value in the error register is mapped to index 1001 (hex) in the object dictionary. If the value is 0, no error occurred. If the value is 1, a normal error occurred. If the value is H'80, an internal error occurred in the device.

10.3.3 The Predefined Connection Set

In order to decrease the configuration workload of the network, CANopen defines a default identifier. In the predefined connection set, the structure of the 11-bit identifier is as follows.

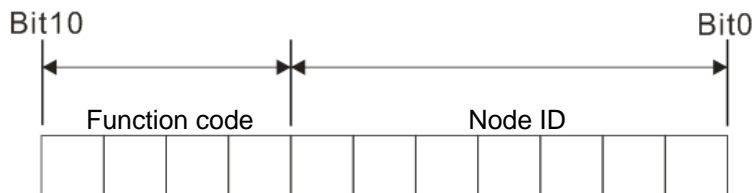

The following tables list the objects that are supported and the COB-IDs that are assigned to the objects.

1. The broadcast object in the predefined connection setting

Object	Function code	COB-ID	Index of the communication parameter
NMT	0000	0	-
SYNC	0001	128 (80h)	1005h, 1006h, 1007h
Time stamp	0010	256 (100h)	1012h, 1013h

2. The corresponding object in the predefined connection set

Object	Function code	COB-ID	Index of the communication parameter
Emergency	0001	129 (81h)–255 (FFh)	1014h, 1015h
PDO1 (TX)	0011	385 (181h)–511 (1FFh)	1800h
PDO1 (RX)	0100	513 (201h)–639 (27Fh)	1400h
PDO2 (TX)	0101	641 (281h)–767 (2FFh)	1801h
PDO2 (RX)	0110	769 (301h)–895 (37Fh)	1401h
PDO3 (TX)	0111	879 (381h)–1023 (3FFh)	1802h
PDO3 (RX)	1000	1025 (401h)–1151 (47Fh)	1402h
PDO4 (TX)	1001	1153 (481h)–1279 (4FFh)	1803h
PDO4 (RX)	1010	1281 (501h)–1407 (57Fh)	1403h
SDO (TX)	1011	1409 (581h)–1535 (5FFh)	1200h
SDO (RX)	1100	1537 (601h)–1663 (67Fh)	1200h
NMT Error Control	1110	1793 (701h)–1919 (77Fh)	1016h, 1017h

10.4 Sending SDO, NMT and Reading Emergency Message through the Ladder Diagram

You can edit the request message mapping area to affect the transmission of SDO, NMT and Emergency messages. The following table shows the corresponding relations between the request message mapping area, response message mapping area, and PLC device.

PLC device	Mapping area	Mapping length
D25000-D25031	SDO request message, NMT service message and Emergency request message	64 bytes
D24000-D24031	SDO response message and Emergency response message	64 bytes

The CANopen master can only send one SDO, NMT, or Emergency request message to the same device at a time. Clear the request message mapping area to zero when sending SDO, NMT, or Emergency request message through the WPL program.

10.4.1 Data Structure of SDO Request Message

Sending SDO through the ladder diagram reads or writes the slave parameter.

- The data format of the SDO request message:

PLC device	Request message		
		High byte	Low byte
D25000	Message Header	ReqID	Command (Fixed to 01)
D25001		Reserved	Size
D25002		Type	Node ID
D25003	Message Data	High byte of main index	Low byte of main index
D25004		Reserved	Sub-index
D25005		Datum 1	Datum 0
D25006		Datum 3	Datum 2
D25007 - D25031		Reserved	

- ReqID: the request ID. Whenever an SDO request message is sent out, the message is given a ReqID for CANopen master to identify. When reading/writing another SDO message, the original ID number must be changed. In other words, reading/writing SDO is triggered by changing of the value of "ReqID". The ReqID range is between 00–FF (Hex).
- Size: the length of the message data. The counting starts from D6253 with a byte as the unit. When reading, it is fixed to four and when writing, it is four plus the byte number of data types of index and subindex and the maximum value is eight. But when writing, if the data type of the index and subindex is word, the data length is six. The data length is file if the data type is byte.
- Node ID: the node address for the target equipment on a CANopen network.
- Type: 01 indicates the read access; 02 indicates the write access.

The following table shows the data format of the SDO response message.

PLC device	Response message		
		High byte	Low byte
D24000	Message Header	ResID	Status code
D24001		Reserved	Size
D24002		Type	Node ID
D24003	Message Data	High byte of main index	Low byte of main index
D24004		Reserved	Sub-index
D24005		Datum 1	Datum 0
D24006		Datum 3	Datum 2
D24007~D24031		Reserved	

- Status code:

The following table lists the status code values in the response message.

Status code	Explanation
0	No data transmission request
1	SDO message transmission succeeds.
2	SDO message is being transmitted.
3	Error: SDO transmission time-out
4	Error: Illegal command code
5	Error: the length of the transmitted data is illegal.
6	Error: the length of the response data is illegal.
7	Error: Equipment to be sent messages is busy.
8	Error: Illegal type
9	Error: Incorrect node address
0A	Error message (See the error code for SDO response message)
0B-FF	Reserved

- ResID: the same as the request ID in the request message.
- Size: the length of the message data, maximum of 20 bytes. The unit is bytes. When writing, the maximum is four; the data length is decided by the data type of index and subindex when reading.
- Node ID: the node address of the target equipment on CANopen network.
- Type: in the SDO response message, 43 (Hex) refers to reading four bytes of data; 4B (Hex) refers to reading two bytes of data; 4F (Hex) refers to reading one byte of data; 60 (Hex) refers to writing 1/2/4 byte(s) of data; 80 (Hex) refers to stopping SDO command.

Example 1: write 010203E8 (hex) to (Index_subindex) 212D_0 in slave of No. 3 through SDO; the data type of (Index_subindex) 212D_0 is double words (32 bits).

- Request data:

PLC device	Request message		
		High byte(Hex)	Low byte(Hex)
D25000	Message Header	ReqID=01	Command =01
D25001		Reserved =0	Size =8
D25002		Type =02	Node ID =03
D25003	Message data	Main index high byte =21	Main index low byte =2D
D25004		Reserved =0	Subindex =0
D25005		Datum 1=03	Datum 0=E8
D25006		Datum 3=01	Datum 2=02

- Response data:

PLC device	Response message		
		High byte(Hex)	Low byte(Hex)
D24000	Message Header	ResID =01	Command =01
D24001		Reserved =0	Size =4
D24002		Type =60	Node ID =03
D24003	Message data	Main index high byte =21	Main index low byte =2D
D24004		Reserved =0	Subindex =0
D24005		Datum 1=00	Datum 0=00
D24006		Datum 3=00	Datum 2=00

Example 2: read the value of (Index_subindex) 212D_0 in slave of No. 3 through SDO; the data type of (Index_subindex) 212D_0 is double words (32 bits).

- Request data:

PLC device	Request message		
		High byte(Hex)	Low byte(Hex)
D25000	Message Header	ReqID =01	Command =01
D25001		Reserved =0	Size =4
D25002		Type =01	Node ID =03
D25003	Message data	Main index high byte =21	Main index low byte =2D
D25004		Reserved =0	Subindex =0
D25005		Datum 1=0	Datum 0=0
D25006		Datum 3=0	Datum 2=0

10.4.2 Data Structure of NMT Message

Use the NMT service to manage the CANopen network such as start, operation, reset of nodes, etc.

The following table shows the data format of the NMT request message.

PLC device	Request message		
		High byte	Low byte
D25000	Message Header	ReqID	Command (Fixed to 01)
D25001		Reserved	Size (Fixed to 04)
D25002		Type (Fixed to 03)	Node ID
D25003	Message data	Reserved	NMT service code
D25004		Reserved	Node ID

- Command: Fixed to 01.
- ReqID: the request ID. Whenever an NMT request message is sent, the message is given a ReqID for the CANopen master to identify. Before another NMT request message is sent out, the original ID number must be changed. In other words, change the value of ReqID. The ReqID range is between 00–FF (Hex) to trigger sending the NMA request message.
- Node ID: the node address for the target equipment on the CANopen network (0: Broadcast).
- NMT service code:

NMT service code (Hex)	Function
01	Start remote node
02	Stop remote node
80	Enter the pre-operational state
81	Reset application
82	Reset communication

The following table shows the data format of the NMT Response message.

PLC device	Response message		
		High byte	Low byte
D24000	Message header	ResID	Status code
D24001		Reserved	Reserved
D24002		Reserved	Node ID

- When status code is 1, the NMT operation has succeeded. When status code is not equal to 1, the NMT operation has failed and you should verify that the data in NMT request message is correct.
- Node ID: the node address for the target equipment on the CANopen network.

Example 1: Stop slave of No. 3 through NMT

- Request data:

PLC device	Request message		
		High byte(Hex)	Low byte(Hex)
D25000	Message header	ReqID =01	Command =01
D25001		Reserved =0	Size =04
D25002		Type =03	Node ID =03
D25003	Message data	Reserved	NMT service code =02
D25004		Reserved	Node ID =03

- Response data:

PLC device	Response message		
		High byte(Hex)	Low byte(Hex)
D24000	Message header	ResID=01	Status code =01
D24001		Reserved =0	Reserved =0
D24002		Reserved =0	Node ID =03

10.4.3 Data Structure of EMERGENCY Request Message

The Emergency request message communicates the slave error and alarm information.

The following table shows the data format of the Emergency request message.

PLC device	Request message		
		High byte	Low byte
D25000	Message header	ReqID	Command (Fixed to 1)
D25001		Reserved	Size (Fixed to 0)
D25002		Type (Fixed to 04)	Node ID
D25003~D25031	Message data	Reserved	

- Command: Fixed to 01.
- ReqID: the request ID. Whenever an Emergency message is sent, the message is given a ReqID for the CANopen master to identify. Before another Emergency request message is sent out, the original ID number must be changed. In other words, change the value of ReqID. The ReqID range is between 00–FF (Hex) to trigger the sending the Emergency request message.
- Node ID: the node address of the target equipment on CANopen network.

The following table shows data format of the Emergency response message.

PLC device	Response message		
		High byte(Hex)	Low byte(Hex)
D24000	Message header	ResID	Status code
D24001		Reserved	Size Fixed to 2A
D24002		Type (Fixed to 04)	Node ID
D24003	Message data	Total number of data	Number of data stored
D24004		Datum 1	Datum 0
D24005		Datum 3	Datum 2

PLC device	Response message	
D24006	Datum 5	Datum 4
D24007	Datum 7	Datum 6
D24008-D24011	Emergency2	
D24012-D24015	Emergency3	
D24016-D24019	Emergency4	
D24020-D24023	Emergency5	
D24024-D24031	Reserved	

- Command: Fixed to 01(Hex).
- When status code is 1, reading the Emergency message has succeeded. When status code is not equal to 1, reading the Emergency message has failed and you should verify that the data in the Emergency message is correct.
- Node ID: the node address for the target equipment on the CANopen network.
- Total number of data: the total number of Emergency messages CANopen master receives from the slave.
- Number of data stored: the latest number of Emergency messages CANopen master receives from the slave (5 messages at most).
- An Emergency 1 consists of the data in D6004-D6007 and every Emergency message consists of 8 bytes of data.

The following table shows the data format of Emergency messages on the CAN bus. Datum 0–datum 7 in Emergency response message correspond to byte 0–byte 7 respectively.

COB-ID	Byte 0	Byte 1	Byte 2	Byte 3	Byte 4	Byte 5	Byte 6	Byte 7
80 (hex) +Node-ID	Emergency error code		Error storage register	Vendor custom error code				

Example 1: read the Emergency message from the slave No.2, and the Emergency messages the slave sends out successively.

COB-ID	Byte 0	Byte 1	Byte 2	Byte 3	Byte 4	Byte 5	Byte 6	Byte 7
82 (hex)	43	54	20	14	0	0	0	0

COB-ID	Byte 0	Byte 1	Byte 2	Byte 3	Byte 4	Byte 5	Byte 6	Byte 7
82 (hex)	42	54	20	15	0	0	0	0

- Request data:

PLC device	Request message		
D25000	Message header	High byte	Low byte
D25001		ReqID=01	Command =01
D25002		Reserved	Size =0
		Type =04	Node ID =03

- Emergency response data

PLC device	Response message		
		High byte	Low byte
D24000	Message header	ResID=01	Status code =01
D24001		Reserved =0	Size =2A (Hex)
D24002		Type =04	Node ID =03
D24003	Message data	Total number of data =1	Number of data stored =1
D24004		Datum 1=54	Datum 0=42
D24005		Datum 3=20	Datum 2=14
D24006		Datum 5=0	Datum 4=0
D24007		Datum 7=0	Datum 6=0

10.4.4 Example of Sending SDO through the Ladder Diagram

1. Control Requirement:

Read the value of P0-09 from the servo through SDO.

2. Hardware Connection:

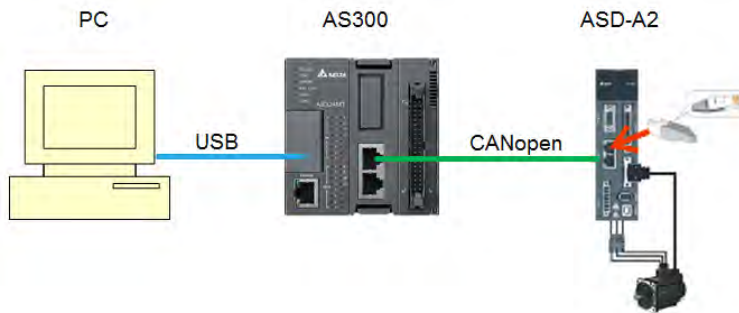

3. The Corresponding Relation between Slave Parameter and Index/Subindex

The index_subindex corresponding to P0-09 in servo is 2009_0. In the CANopen Builder network configuration software, right click the servo icon, and then click **Parameter Edit**. In the **Parameter Edit** dialog box, you can see the index_subindex corresponding to the servo parameter.

For more details on how to operate the network configuration interface, refer to Section 11.1.1 in the CANopen Builder software help file

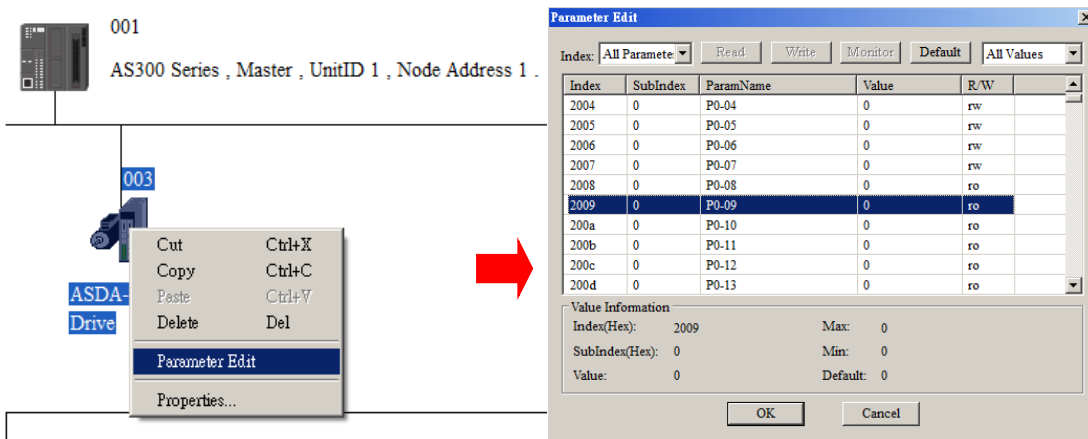

4. The Structure of the Request Message Devices:

PLC device	Content (Hex)	Explanation		
		High byte(Hex)	Low byte(Hex)	
SDO request message mapping area	D25000	0101	ReqID = 01	Command = 01
	D25001	0004	Reserved	Size = 04
	D25002	0102	Type = 01	Node ID = 03
	D25003	2009	Index high byte = 20	Index low byte = 09
	D25004	0000	Reserved	Subindex = 00

5. Editing the Ladder Diagram in ISPSOft

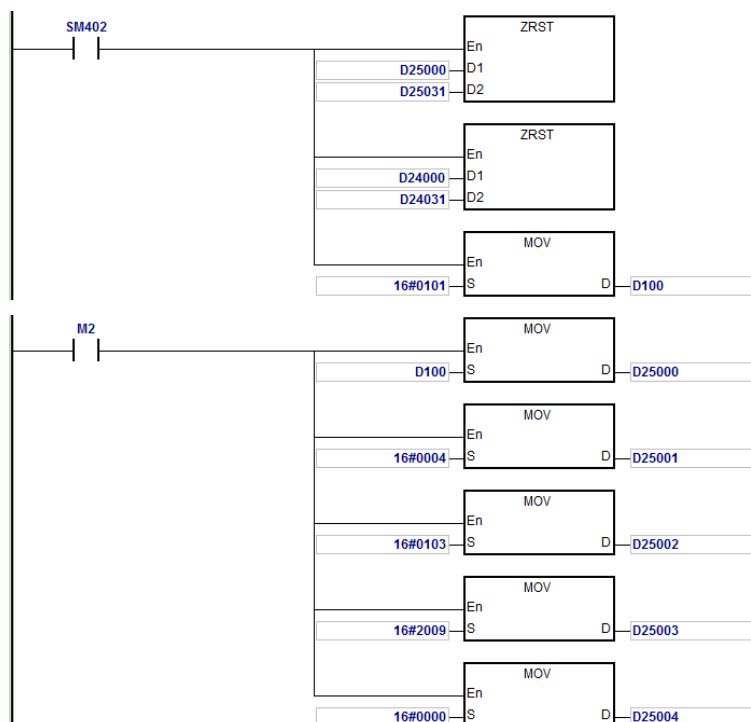

When M2=ON, after reading succeeds, the program stores the data from the target device in D24000–D24005. The value of D24005: 100 (hex) is the value read from P0-09.

6. The Structure of the Response Message Devices:

PLC device	Content (Hex)	Explanation		
		High byte(Hex)	Low byte(Hex)	
SDO response message mapping area	D24000	0101	ResID = 01	Status code = 01
	D24001	0006	Reserved	Size = 08
	D24002	4303	Type = 43	Node ID = 03
	D24003	2009	Main index high byte = 20	Index low byte = 09
	D24004	0004	Reserved	Subindex = 00
	D24005	0100	Datum 1 = 01	Datum 0 = 00

10.5 Troubleshooting

10.5.1 CANopen Network Node State Display

- In the AS Series PLC, while you enable the CANopen function, it uses SR825–893 as the special registers as shown in the following table.

Special register	Function
SR825	Displays the state of AS300 series PLC.
SR830–SR893	Displays the state of 64 nodes in the network
SR826	Flag for the state of the slave 1–16
SR827	Flag for the state of the slave 17–32
SR828	Flag for the state of the slave 33–48
SR829	Flag for the state of the slave 49–64
SR821	Version of CANopen DS301
SR822	Displays the CANopen baud rate (unit: 1kpps)

- As a master, the AS series PLC supports a maximum of 64 slaves ranging from node 1 to node 64. You can use SR826–829 to monitor the state of the nodes in the network. The 16 bits in SR826 correspond to 16 slaves and their corresponding relations are shown in the following table.

Bit	b7	b6	b5	b4	b3	b2	b1	b0
Node	Node 8	Node 7	Node 6	Node 5	Node 4	Node 3	Node 2	Node 1
Bit	b15	b14	b13	b12	b11	b10	b9	b8
Node	Node16	Node15	Node14	Node13	Node12	Node11	Node10	Node 9

When the node in the master node list is normal, the corresponding bit is OFF; when the node in the master node list is abnormal (for example, initializing fails or the slave is offline for some reason), the corresponding bit is ON.

- The error code of every node is displayed through the corresponding special register (SR830–893) and the relations between special register and corresponding node (1–16) is shown in the following table. (You can also judge for other correspondings that are not listed here.)

Special register	SR830	SR831	SR832	SR833	SR834	SR835	SR836	SR837
Node	Node 1	Node 2	Node 3	Node 4	Node 5	Node 6	Node 7	Node 8
Special register	SR838	SR839	SR840	SR841	SR842	SR843	SR844	SR845
Node	Node 9	Node10	Node11	Node12	Node13	Node14	Node15	Node16

4. Node codes displayed in SR830–893 when the ASSeries PLC is the master:

Code	Indication	How to correct
0	The node is error free or the node is not configured.	N/A
E0	ASSeries PLC master module receives the emergency message sent from slave.	Read the relevant message with the PLC program
E1	PDO data length returned from the slave is not consistent with the length set in the node list.	Set the PDO data length of the slave and re-download.
E2	PDO of slave is not received.	Check and ensure the setting is correct.
E3	Downloading auto SDO fails.	Check and ensure auto SDO is correct.
E4	Configuration of PDO parameter fails.	Ensure that the PDO parameter setting is legal.
E5	Error in key parameter setting.	Ensure that the connected slave device is consistent with the configured slave in the software.
E6	The slave does not exist in the network	Ensure that the power supply of slave is normal and slave is correctly connected to the network.
E7	Slave error control is timed-out.	
E8	The node IDs of master and slave repeat.	Set the node ID of the master and slave again and ensure their node IDs are unique.

5. Codes displayed in SR825 when the AS300 Series PLC is the master:

Code	Indication	How to correct
0	In CANopen DS301 mode: the PLC works as master and is working normally. Not in CANopen DS301 mode: the master mode function is not activated.	N/A
F1	No slave in the list	Add slave into the node list and then re-download the configuration data.
F2	The data are being downloaded to AS Series PLC	Wait to finish downloading the configuration data.
F3	The configuration receiving error in AS Series PLC	Download parameter configuration again.
F4	Bus-OFF is detected.	Check that the CANopen bus cables are properly connected and ensure that all the node devices run at the same baud rate before you reboot.
F5	AS Series PLC setting error such as incorrect node address	The node address in the AS300 Series PLC should be between: 1–127.
F8	Internal error; the error is detected in the internal memory	If the same error occurs after cycling the power, replace it with a new AS300 PLC.
FB	The sending buffer in the AS Series PLC is full.	Check that the CANopen bus cable is properly connected and then reboot.
FC	The receiving buffer in the AS Series PLC is full.	Check that the CANopen bus cable is properly connected and then reboot.

6. Codes displayed in SR825 when the AS Series PLC is the slave:

Code	Indication	How to correct
0	Working normally	N/A Note: When the heartbeat alarm function is not activated, if the connection is normal before a disconnection occurs, the code for the slave will still be working normally after the connection is back on.
A0	AS Series PLC is being initialized.	--
A1	AS Series PLC is pre-operational.	Check if the CANopen bus cable is properly connected. If the master communication is not activated, no handling is needed.
A3	The data are being downloaded to AS Series PLC	Wait to finish downloading the configured data.
B0	Heartbeat message time-out	Check if the CANopen bus cable is properly connected.
B1	PDO data length returned from the slave is not consistent with the length set in the node list.	Reset the PDO data length in the slave and download the new setting to the AS Series PLC.
F4	BUS-OFF state is detected.	Check if the CANopen bus cables are properly connected and ensure that all the node devices run at the same baud rate before you reboot.
FB	The sending buffer in the AS Series PLC is full.	Check if the CANopen bus cable is properly connected and then reboot.
FC	The receiving buffer in the AS Series PLC is full.	Check if the CANopen bus cable is properly connected and then reboot.

10.6 Application Example

The AS300 Series PLC can control Delta A2 servo rotation, and monitor the actual rotation speed of the motor in real time. It does this by mapping the relevant servo drive parameters to the corresponding PDO, and reads or writes the relevant servo drive parameters through the CAN bus.

1. Connecting the Hardware

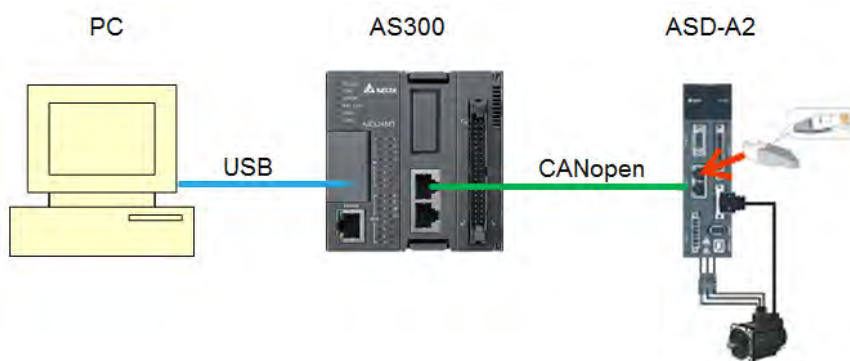

Note:

- Use a standard communication cable such as UC-DN01Z-01A / UC-DN01Z-02A / UC-CMC010-01A, and connect the terminal resistors (Delta standard terminal resistor TAP-TR01) to both ends of the network when you construct the network.
- M of ASD-A2-xxxx-M refers to the model code and currently only the M-model servo supports CANopen communication.

2. Setting Servo Parameters:

- Set servo parameters as shown in the following table.

Parameter	Setting	Explanation
3-00	03	Node ID of the A2 servo is 2
3-01	400	CAN communication rate is 1Mbps.
1-01	04	Speed mode
0-17	07	Drive displays the motor rotation speed (r/min)
2-10	101	Set DI1 as the signal for Servo On
2-12	114	Set DI3 as the signal _SPD0 for speed selection
2-13	115	Set DI4 as the signal _SPD1 for speed selection

3. Setting the CANopen Baud Rate and Node ID of AS300 Series PLC

The AS300 Series PLC uses the default setting values: Node ID: 1 and baud rate: 1Mbps.

You set the CANopen Node ID and baud rate for the AS300 series PLC in the CANopen Builder software, as shown in the following steps.

- A. Right click the AS300 Series PLC icon in HWCONFIG, then click **Communication Software**, and then click **CANopen Builder**.

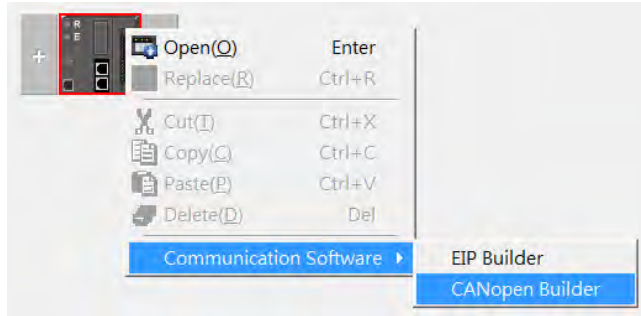

- B. IF AS300 is in master mode, you can skip this step. If not, you can go to Properties and set it in Master mode. After that download the parameter to AS300. Set AS300 Power off for 2 seconds and supply power again and then proceed to the next step.

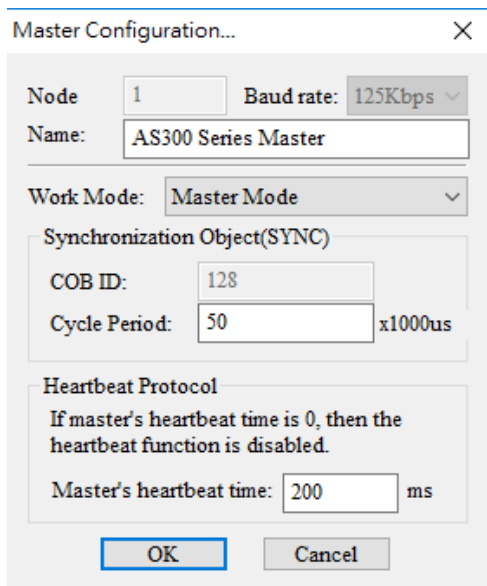
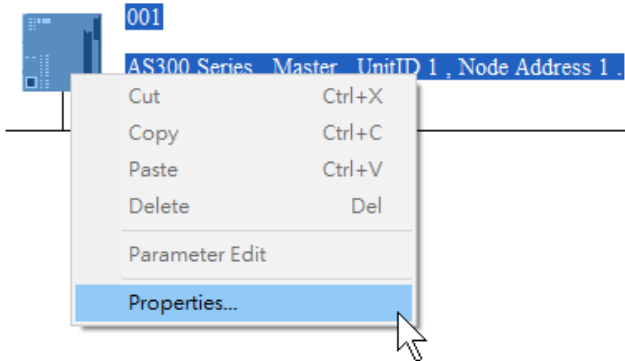

C. Click the Online  button on the Toolbar to enter on-line mode.

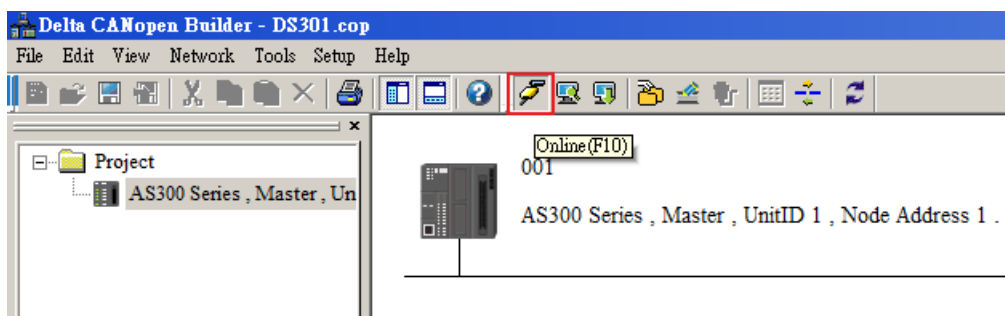

D. Click the Scan Network  button on the Toolbar to scan the network.

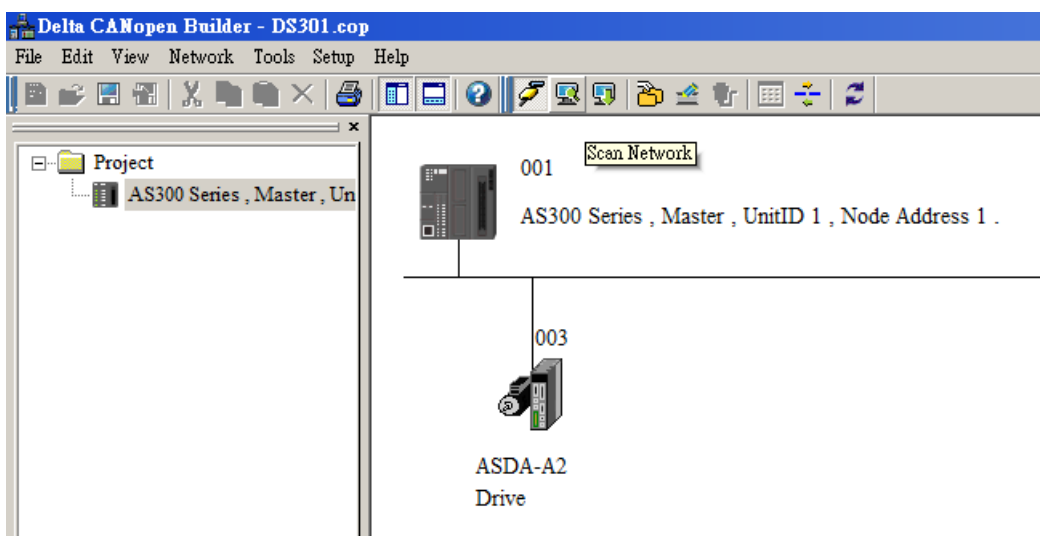

E. On the **Network** menu, click **Master parameter** to display the Master Configuration dialog box.

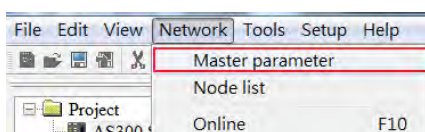

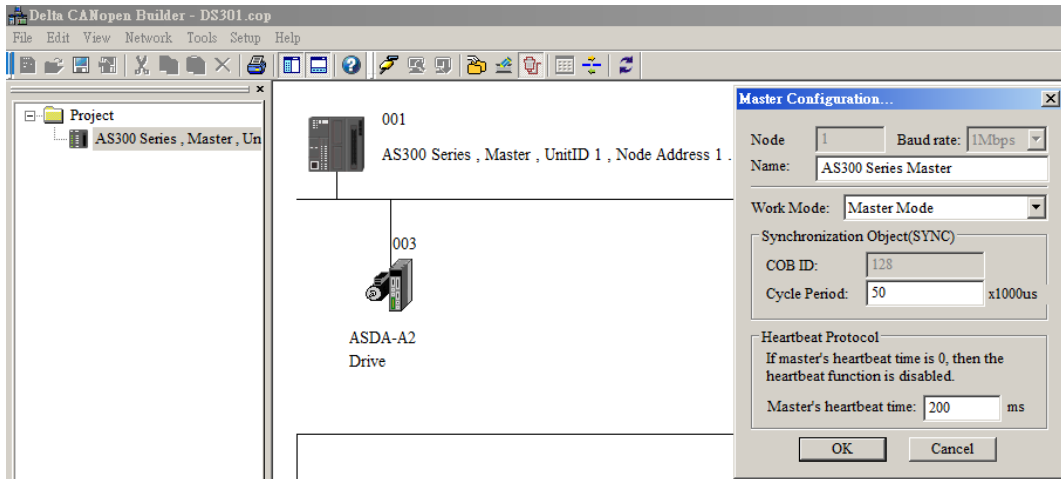

Item	Explanation	Default
Node ID	Node ID of AS300 series PLC on the CANopen network	1
Baud rate	CANopen communication rate	1M bit/second
Work mode	CANopen master/slave mode	Master
Cycle period	Cycle time for sending one SYNC message	50ms
Master heartbeat time	Interval time for sending the master heartbeat message	200ms

Configure the CANopen communication stations and rates in HWCONFIG.

- F. After you complete the previous steps, click the Download  button on the Toolbar to download the parameters to the PLC.

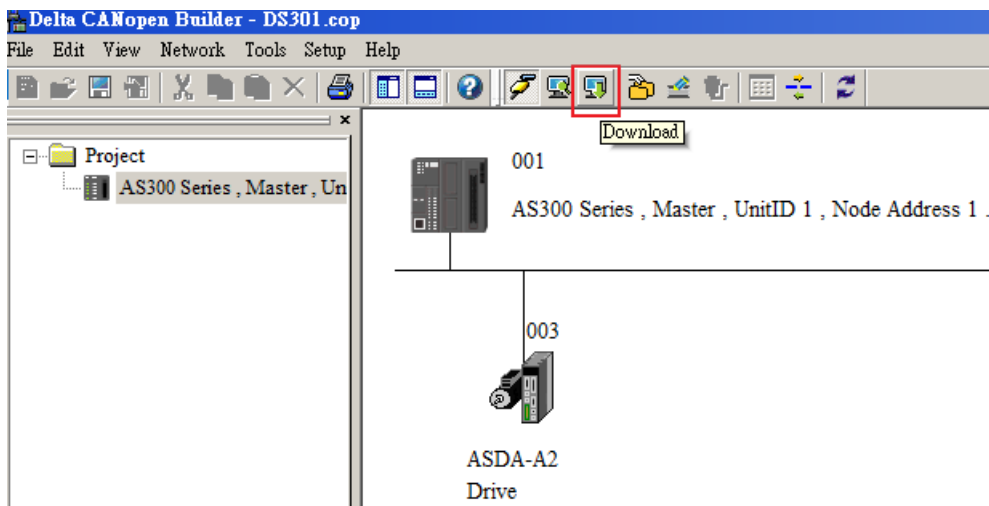

Note: you must reboot the AS300 Series PLC to enable the downloaded parameters.

4. Scanning the Network:

On the **Network** menu, click **Online** or click the  button to scan for the master and slaves on the CANopen network. The master and slave found by the scan appear in CANopen Builder. For more information, refer to Section 11.1.1 in the CANopen Builder software help file.

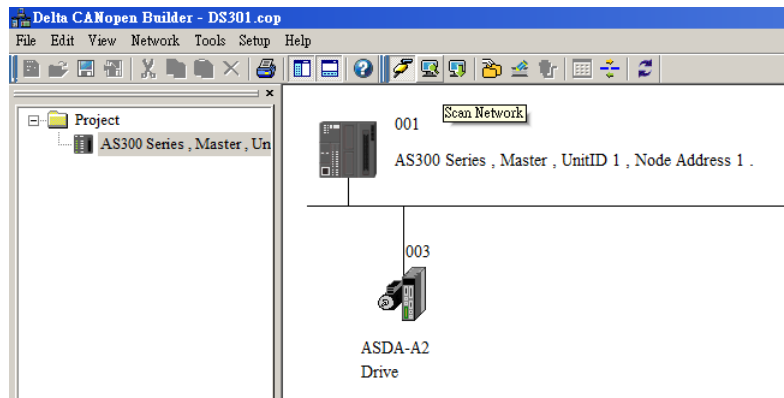

5. Configuring Nodes:

Double click the slave icon in CANopen Builder to display the **Node configuration** dialog box.

- **Error Control Protocol**

Sets the error control protocol for the master to monitor if the slave is offline.

- **Auto SDO Configuration**

Perform one write action to the slave parameter with SDO. The write action is finished when the slave enters the operational state from the pre-operational state. You can configure up to 20 SDOs by clicking Auto SDO configuration.

- **PDO Mapping and Properties**

Sets the mapping parameter and transmission type for the PDO.

For more details on the function of these buttons, refer to Section 11.1.1 in the CANopen Builder software help file.

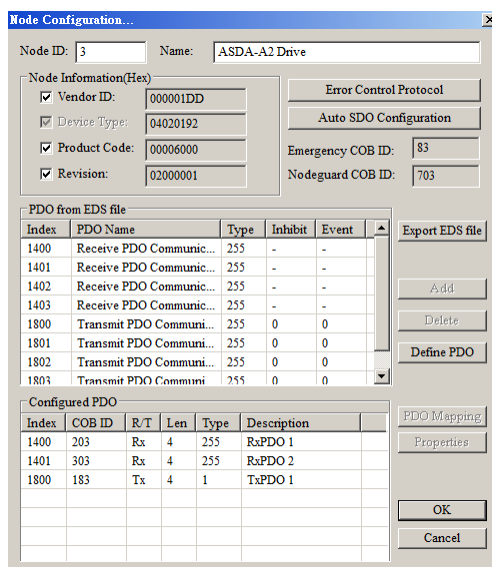

- PDO Mapping:

RxPDO1: mapping parameter P1-09; transmission type 255.

RxPDO2: mapping parameter P3-06, P4-07; transmission type 255.

TxPDO1: mapping parameter P0-09; transmission type 1.

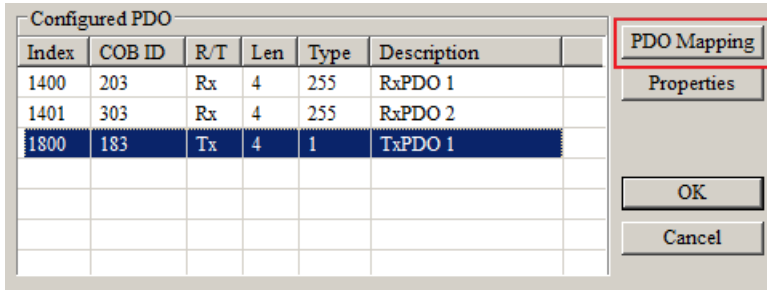

- PDO transmission type :

PDOs can be classified into RxPDO or TxPDO. RxPDO data are sent from master to slave and TxPDO data are sent from slave to master.

The PDO transmission types can be synchronous or asynchronous. In synchronous transmission, the master sends out the SYNC message in a fixed cycle. You set the length of the cycle in the Master Properties dialog box (default is 50ms). In asynchronous transmission, the message is sent out when the PDO mapping parameter changes.

The following table describes the PDO Transmission types.

Transmission Type		Description	Remark
0	RxPDO	When any change in the mapped data happens, RxPDO data is sent out immediately. The data the slave receives is valid only when receiving the next SYNCH message. RxPDO data is not sent out if there is no change in the data.	SYNCH non-cycle
	TxPDO	When any change in the mapped data happens and the slave receives the SYNC message, the data are sent out immediately. The TxPDO data are valid immediately after master receives them. TxPDO data is not sent out if there is no change in the data.	
N (N:1–240)	RxPDO	After N messages are sent out, and regardless of whether the mapped data changes, the data that the slave receives is valid only when receiving the next SYNCH message.	SYNCH cycle
	TxPDO	After N messages are sent out and regardless of whether the mapped data is changed, the data that the master receives is valid at once.	
254	RxPDO	The mapped data is sent out immediately when it changes and is valid when the slaves receives it. RxPDO data is not sent out if there is no change in the data.	ASYNCH

Transmission Type	Description	Remark
	<p>The slave sends out the data once every one Event timer time. After that, the TxPDO data is not allowed to be sent out within an inhibit timer time.</p> <p>When the Event timer and Inhibit timer are both equal to 0, the slave sends TxPDO data to the master immediately when the data changes, and the data that master receives is immediately valid.</p>	
255	Same as Type254	

Note:

- Synchronous transmission type can fulfill multi-axis motion at the same time.
- If you monitor a real-time changing parameter such as the actual rotation speed of the motor, set the TxPDO to the synchronous transmission type; otherwise the frequent change in the slave data can block the CANopen network.

After you finish setting the above parameters, double click the master device to display the **Node List Setting** dialog box. Select ASDA-A2 Drive, and click > to move the A2 drive to the right-side list, and then download the configured data.

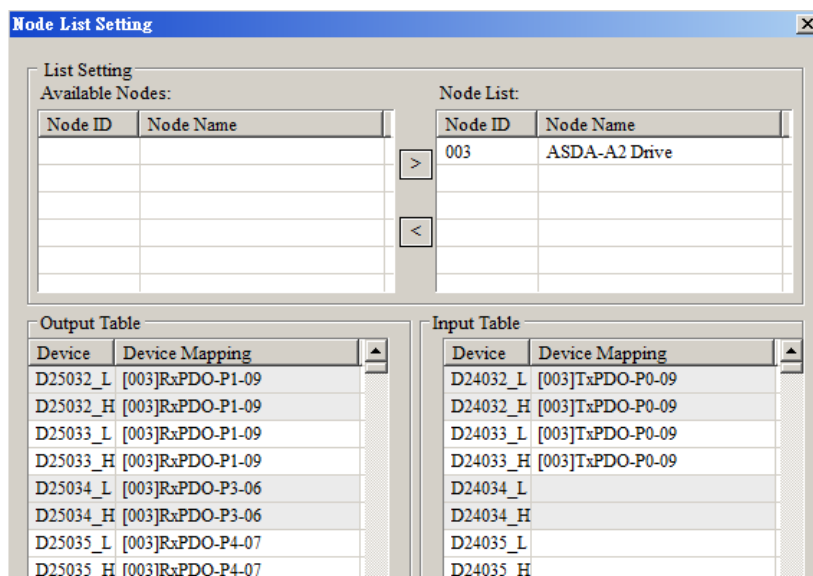

The mapping relation between master and slave:

AS300 Series PLC master register	Data transmission on CANopen bus	A2 device
D25032		Low word of P1-09 of servo
D25033		High word of P1-09 of servo
D25034		P3-06 of servo
D25035		P4-07 of servo

AS300 Series PLC master register	Data transmission on CANopen bus	A2 device
D24032	←	Low word of P0-09 of servo
D24033		High word of P0-09 of servo

6. Program control: D25032 is given the value 256 in ISPSOft; that is, the speed command is set as 256r/min in the following diagram.

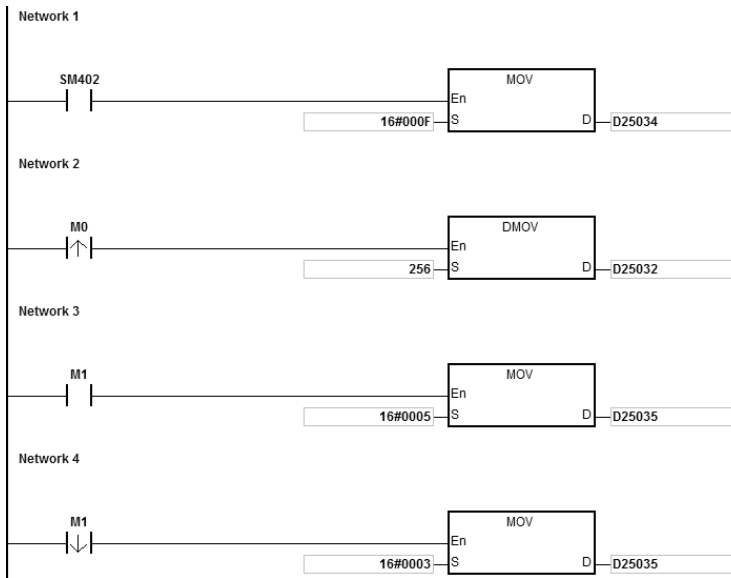

7. Program explanation

When the AS300 Series PLC runs for the first time, set the parameter P3-06 for servo drive to F.

- When M0 switches from OFF to ON, the instruction writes 256 to D25032 and then writes the value to the servo parameter P1-09 through RxD01.
- When M1 switches from OFF to ON, change P4-07 to 5. DI1 and DI3 are ON. DI1 means the SERVO is ON and DI3 calls the speed specified by parameter P1-09 for servo rotation.
- When M1 switches from ON to OFF, the speed command becomes 0 and the motor stops running.

10.7 Object Dictionary

The following table lists the communication objects in the object dictionary.

Index	Subindex	Object name	Data type	Attribute	Default value
H'1000	H'00	Device type	Unsigned 32 bits	R	0x00000000
H'1001	H'00	Error register	Unsigned 8 bits	R	0
H'1005	H'00	COB-ID SYNC	Unsigned 32 bits	RW	0x00000080
H'1008	H'00	Manufacturer device name	Vis-String	R	AS300 Series PLC
H'1014	H'00	COB-ID EMCY	Unsigned 32 bits	R	0x80 + Node-ID
H'1016	--	Consumer heartbeat time			
	H'00	Number of valid subindex	Unsigned 8 bits	R	1
	H'01	Consumer heartbeat time	Unsigned 32 bits	RW	0
H'1017	H'00	Producer heartbeat time	Unsigned 16 bits	RW	0
H'1018	--	Identity Object			
	H'00	Number of valid subindex	Unsigned 8 bits	R	3
	H'01	Vendor-ID	Unsigned 32 bits	R	0x000001DD
	H'02	Product code	Unsigned 32 bits	R	0x00000055
	H'03	Revision number	Unsigned 32 bits	R	0x00010002
H'1400	--	RxPDO1 communication parameter			
	H'00	Number of valid subindex	Unsigned 8 bits	R	3
	H'01	COB-ID of RxPDO1	Unsigned 32 bits	RW	0x00000200+Node-ID
	H'02	Transmission mode	Unsigned 8 bits	RW	0xFF
	H'03	Inhibit time	Unsigned 16 bits	RW	0
H'1401	--	RxPDO2 communication parameter			
	H'00	Number of valid subindex	Unsigned 8 bits	R	3
	H'01	COB-ID of RxPDO2	Unsigned 32 bits	RW	0x80000000
	H'02	Transmission mode	Unsigned 8 bits	RW	0xFF
	H'03	Inhibit time	Unsigned 16 bits	RW	0
H'1402	--	RxPDO3 communication parameter			
	H'00	Number of valid subindex	Unsigned 8 bits	R	3
	H'01	COB-ID of RxPDO3	Unsigned 32 bits	RW	0x80000000
	H'02	Transmission mode	Unsigned 8 bits	RW	0xFF
H'1402	H'03	Inhibit time	Unsigned 16 bits	RW	0
H'1403	--	RxPDO4 communication parameter			

Index	Subindex	Object name	Data type	Attribute	Default value
	H'00	Number of valid subindex	Unsigned 8 bits	R	3
	H'01	COB-ID of RxPDO4	Unsigned 32 bits	RW	0x80000000
	H'02	Transmission mode	Unsigned 8 bits	RW	0xFF
	H'03	Inhibit time	Unsigned 16 bits	RW	0
H'1404	--	RxPDO5 communication parameter			
	H'00	Number of valid subindex	Unsigned 8 bits	R	3
	H'01	COB-ID of RxPDO5	Unsigned 32 bits	RW	0x80000000
	H'02	Transmission mode	Unsigned 8 bits	RW	0xFF
	H'03	Inhibit time	Unsigned 16 bits	RW	0
H'1405	--	RxPDO6 communication parameter			
	H'00	Number of valid subindex	Unsigned 8 bits	R	3
	H'01	COB-ID of RxPDO6	Unsigned 32 bits	RW	0x80000000
	H'02	Transmission mode	Unsigned 8 bits	RW	0xFF
	H'03	Inhibit time	Unsigned 16 bits	RW	0
H'1406	--	RxPDO7 communication parameter			
	H'00	Number of valid subindex	Unsigned 8 bits	R	3
	H'01	COB-ID of RxPDO7	Unsigned 32 bits	RW	0x80000000
	H'02	Transmission mode	Unsigned 8 bits	RW	0xFF
	H'03	Inhibit time	Unsigned 16 bits	RW	0
H'1407	--	RxPDO8 communication parameter			
	H'00	Number of valid subindex	Unsigned 8 bits	R	3
	H'01	COB-ID of RxPDO8	Unsigned 32 bits	RW	0x80000000
	H'02	Transmission mode	Unsigned 8 bits	RW	0xFF
	H'03	Inhibit time	Unsigned 16 bits	RW	0
H'1600	--	RxPDO1 mapping parameter			
H'1600	H'00	Number of valid subindex	Unsigned 8 bits	RW	4
	H'01	The first mapped object	Unsigned 32 bits	RW	0x20000110
	H'01	The second mapped object	Unsigned 32 bits	RW	0x20000210

Index	Subindex	Object name	Data type	Attribute	Default value
	H'02	The third mapped object	Unsigned 32 bits	RW	0x20000310
	H'03	The fourth mapped object	Unsigned 32 bits	RW	0x20000410
H'1601	--	RxPDO2 mapping parameter			
	H'00	Number of valid subindex	Unsigned 8 bits	RW	0
	H'01	The first mapped object	Unsigned 32 bits	RW	0
	H'01	The second mapped object	Unsigned 32 bits	RW	0
	H'02	The third mapped object	Unsigned 32 bits	RW	0
	H'03	The fourth mapped object	Unsigned 32 bits	RW	0
H'1602	--	RxPDO3 mapping parameter			
	H'00	Number of valid subindex	Unsigned 8 bits	RW	0
	H'01	The first mapped object	Unsigned 32 bits	RW	0
	H'01	The second mapped object	Unsigned 32 bits	RW	0
	H'02	The third mapped object	Unsigned 32 bits	RW	0
	H'03	The fourth mapped object	Unsigned 32 bits	RW	0
H'1603	--	RxPDO4 mapping parameter			
	H'00	Number of valid subindex	Unsigned 8 bits	RW	0
	H'01	The first mapped object	Unsigned 32 bits	RW	0
	H'01	The second mapped object	Unsigned 32 bits	RW	0
	H'02	The third mapped object	Unsigned 32 bits	RW	0
	H'03	The fourth mapped object	Unsigned 32 bits	RW	0
H'1604	--	RxPDO5 mapping parameter			
	H'00	Number of valid subindex	Unsigned 8 bits	RW	0
H'1604	H'01	The first mapped object	Unsigned 32 bits	RW	0
	H'01	The second mapped object	Unsigned 32 bits	RW	0
	H'02	The third mapped object	Unsigned 32 bits	RW	0
	H'03	The fourth mapped object	Unsigned 32 bits	RW	0
H'1605	--	RxPDO6 mapping parameter			
	H'00	Number of valid subindex	Unsigned 8 bits	RW	0
	H'01	The first mapped object	Unsigned 32 bits	RW	0
	H'01	The second mapped object	Unsigned 32 bits	RW	0
	H'02	The third mapped object	Unsigned 32 bits	RW	0

Index	Subindex	Object name	Data type	Attribute	Default value
	H'03	The fourth mapped object	Unsigned 32 bits	RW	0
H'1606	--	RxPDO7 mapping parameter			
	H'00	Number of valid subindex	Unsigned 8 bits	RW	0
	H'01	The first mapped object	Unsigned 32 bits	RW	0
	H'01	The second mapped object	Unsigned 32 bits	RW	0
	H'02	The third mapped object	Unsigned 32 bits	RW	0
	H'03	The fourth mapped object	Unsigned 32 bits	RW	0
H'1607	--	RxPDO8 mapping parameter			
	H'00	Number of valid subindex	Unsigned 8 bits	RW	0
	H'01	The first mapped object	Unsigned 32 bits	RW	0
	H'01	The second mapped object	Unsigned 32 bits	RW	0
	H'02	The third mapped object	Unsigned 32 bits	RW	0
	H'03	The fourth mapped object	Unsigned 32 bits	RW	0
H'1800	--	TxPDO1 communication parameter			
	H'00	Number of valid subindex	Unsigned 8 bits	R	5
	H'01	COB-ID of TxPDO1	Unsigned 32 bits	RW	0x00000180+Node-ID
	H'02	Transmission mode	Unsigned 8 bits	RW	0xFF
	H'03	Inhibit time	Unsigned 16 bits	RW	50
H'1800	H'05	Timer	Unsigned 16 bits	RW	100
H'1801	--	TxPDO2 communication parameter			
	H'00	Number of valid subindex	Unsigned 8 bits	R	5
	H'01	COB-ID of TxPDO2	Unsigned 32 bits	RW	0x80000000
	H'02	Transmission mode	Unsigned 8 bits	RW	0xFF
	H'03	Inhibit time	Unsigned 16 bits	RW	50
	H'05	Timer	Unsigned 16 bits	RW	100
H'1802	--	TxPDO3 communication parameter			
	H'00	Number of valid subindex	Unsigned 8 bits	R	5
	H'01	COB-ID of TxPDO3	Unsigned 32 bits	RW	0x80000000
	H'02	Transmission mode	Unsigned 8 bits	RW	0xFF
	H'03	Inhibit time	Unsigned 16 bits	RW	50
	H'05	Timer	Unsigned 16 bits	RW	100
H'1803	--	TxPDO4 communication parameter			
	H'00	Number of valid subindex	Unsigned 8 bits	R	5
	H'01	COB-ID of TxPDO4	Unsigned 32 bits	RW	0x80000000
	H'02	Transmission mode	Unsigned 8 bits	RW	0xFF

Index	Subindex	Object name	Data type	Attribute	Default value
	H'03	Inhibit time	Unsigned 16 bits	RW	50
	H'05	Timer	Unsigned 16 bits	RW	100
H'1804	--	TxPDO5 communication parameter			
	H'00	Number of valid subindex	Unsigned 8 bits	R	5
	H'01	COB-ID of TxPDO5	Unsigned 32 bits	RW	0x80000000
	H'02	Transmission mode	Unsigned 8 bits	RW	0xFF
	H'03	Inhibit time	Unsigned 16 bits	RW	50
	H'05	Timer	Unsigned 16 bits	RW	100
H'1805	--	TxPDO6 communication parameter			
	H'00	Number of valid subindex	Unsigned 8 bits	R	5
	H'01	COB-ID of TxPDO6	Unsigned 32 bits	RW	0x80000000
	H'02	Transmission mode	Unsigned 8 bits	RW	0xFF
H'1805	H'03	Inhibit time	Unsigned 16 bits	RW	50
	H'05	Timer	Unsigned 16 bits	RW	100
H'1806	--	TxPDO7 communication parameter			
	H'00	Number of valid subindex	Unsigned 8 bits	R	5
	H'01	COB-ID of TxPDO7	Unsigned 32 bits	RW	0x80000000
	H'02	Transmission mode	Unsigned 8 bits	RW	0xFF
	H'03	Inhibit time	Unsigned 16 bits	RW	50
	H'05	Timer	Unsigned 16 bits	RW	100
H'1807	--	TxPDO8 communication parameter			
	H'00	Number of valid subindex	Unsigned 8 bits	R	5
	H'01	COB-ID of TxPDO8	Unsigned 32 bits	RW	0x80000000
	H'02	Transmission mode	Unsigned 8 bits	RW	0xFF
	H'03	Inhibit time	Unsigned 16 bits	RW	50
	H'05	Timer	Unsigned 16 bits	RW	100
H'1A00	--	TxPDO1 mapping parameter			
	H'00	Number of valid subindex	Unsigned 8 bits	RW	4
	H'01	The first mapped object	Unsigned 32 bits	RW	0x20010110
	H'02	The second mapped object	Unsigned 32 bits	RW	0x20010210
	H'03	The third mapped object	Unsigned 32 bits	RW	0x20010310
	H'04	The fourth mapped object	Unsigned 32 bits	RW	0x20010410
H'1A01	--	TxPDO2 mapping parameter			
	H'00	Number of valid subindex	Unsigned 8 bits	RW	0
	H'01	The first mapped object	Unsigned 32 bits	RW	0
	H'02	The second mapped object	Unsigned 32 bits	RW	0

Index	Subindex	Object name	Data type	Attribute	Default value
	H'03	The third mapped object	Unsigned 32 bits	RW	0
	H'04	The fourth mapped object	Unsigned 32 bits	RW	0
H'1A02	--	TxPDO3 mapping parameter			
	H'00	Number of valid subindex	Unsigned 8 bits	RW	0
	H'01	The first mapped object	Unsigned 32 bits	RW	0
	H'02	The second mapped object	Unsigned 32 bits	RW	0
H'1A02	H'03	The third mapped object	Unsigned 32 bits	RW	0
	H'04	The fourth mapped object	Unsigned 32 bits	RW	0
H'1A03	--	TxPDO4 mapping parameter			
	H'00	Number of valid subindex	Unsigned 8 bits	RW	0
	H'01	The first mapped object	Unsigned 32 bits	RW	0
	H'02	The second mapped object	Unsigned 32 bits	RW	0
	H'03	The third mapped object	Unsigned 32 bits	RW	0
H'1A04	--	TxPDO5 mapping parameter			
	H'00	Number of valid subindex	Unsigned 8 bits	RW	0
	H'01	The first mapped object	Unsigned 32 bits	RW	0
	H'02	The second mapped object	Unsigned 32 bits	RW	0
	H'03	The third mapped object	Unsigned 32 bits	RW	0
	H'04	The fourth mapped object	Unsigned 32 bits	RW	0
H'1A05	--	TxPDO6 mapping parameter			
	H'00	Number of valid subindex	Unsigned 8 bits	RW	0
	H'01	The first mapped object	Unsigned 32 bits	RW	0
	H'02	The second mapped object	Unsigned 32 bits	RW	0
	H'03	The third mapped object	Unsigned 32 bits	RW	0
	H'04	The fourth mapped object	Unsigned 32 bits	RW	0
H'1A06	--	TxPDO7 mapping parameter			
	H'00	Number of valid subindex	Unsigned 8 bits	RW	0
	H'01	The first mapped object	Unsigned 32 bits	RW	0
	H'02	The second mapped object	Unsigned 32 bits	RW	0
	H'03	The third mapped object	Unsigned 32 bits	RW	0
	H'04	The fourth mapped object	Unsigned 32 bits	RW	0
H'1A07	--	TxPDO8 mapping parameter			
H'1A07	H'00	Number of valid subindex	Unsigned 8 bits	RW	0
	H'01	The first mapped object	Unsigned 32 bits	RW	0
	H'02	The second mapped object	Unsigned 32 bits	RW	0
	H'03	The third mapped object	Unsigned 32 bits	RW	0
	H'04	The fourth mapped object	Unsigned 32 bits	RW	0

Chapter 11 CPU Module Operating Principles

Table of Contents

11.1	CPU Module Operations.....	11-2
11.1.1	Procedure	11-2
11.1.2	I/O Refreshing and Communication Service.....	11-3
11.1.3	Interrupts	11-3
11.2	CPU Module Operating Modes	11-4
11.2.1	Operating Modes.....	11-4
11.2.2	Status and Operation under Different Operating Modes.....	11-4

11.1 CPU Module Operations

11.1.1 Procedure

The following diagram describes the operation of the CPU module.

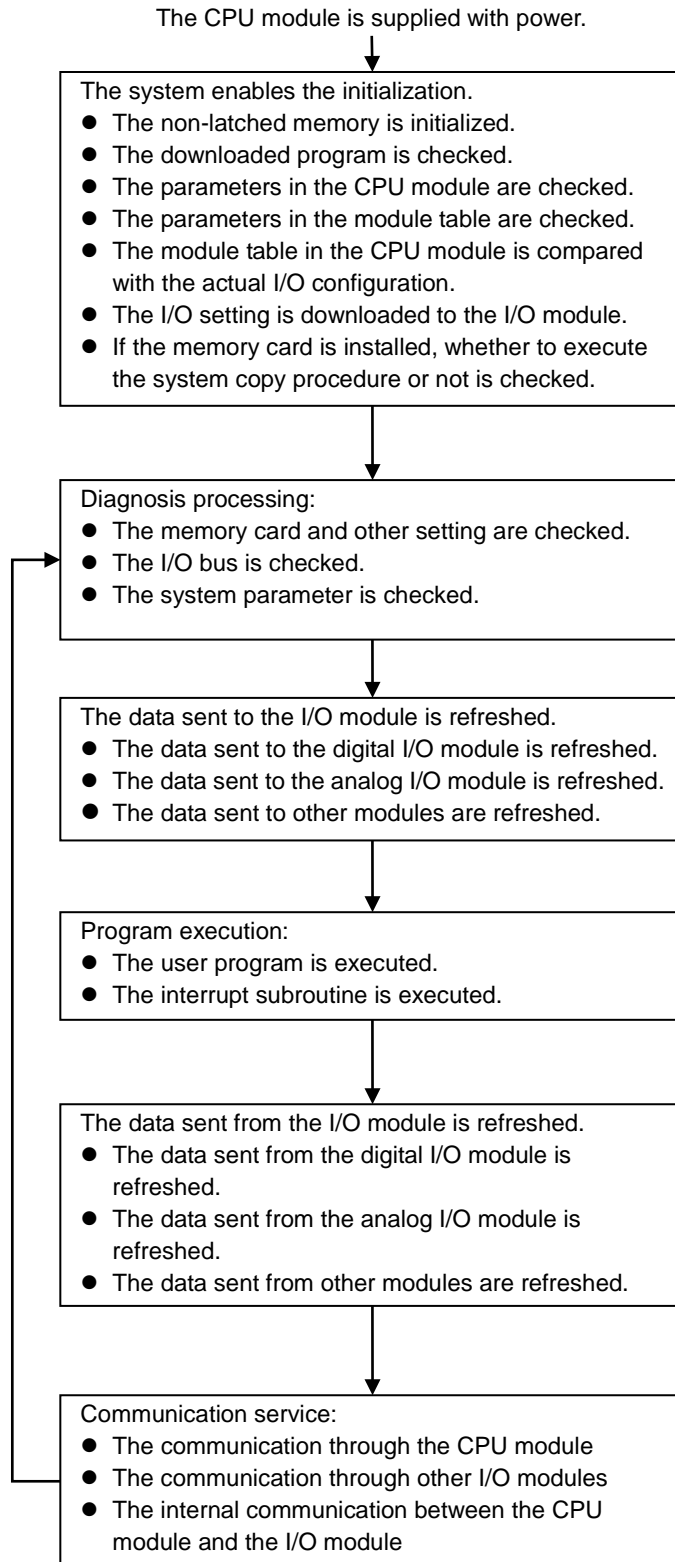

11.1.2 I/O Refreshing and Communication Service

- **Refreshing I/O**

The CPU module reads external I/O data periodically or outputs data to an external I/O. Refreshing the I/O includes the following.

- Refreshing data in a digital I/O module
- Refreshing data in an analog I/O module, temperature measurement module, loadcell module, positioning and counter module
- Refreshing data in a network module

All I/O refreshing executes in the same loop. The data in an input device refreshes before a program executes, and the data in an output device refreshes after the program executes.

Unit	Maximum data exchange	Data exchange area
Digital I/O module	Depends on the number of input/output channels in the unit.	Input relay/Output relay
Analog I/O module, temperature measurement module, loadcell module, positioning and counter module	Depends on the number of input/output channels in the unit.	Data register
Network module	Depends on the unit.	Data register

- **Communication service**

Communication service is the unscheduled communication service for a network module. It includes the communication requests sent from external equipment to a CPU module, and the communication requests sent from the CPU module to the external equipment. The communication requests may be received from time to time but the data or state refreshing on the devices or components will only start after the END instruction is scanned and executed if the communication is concerning the internal devices or components of the PLC CPU.

11.1.3 Execution Timing of Interrupts

Interrupts can be categorized into three types, periodic interrupts, timer interrupts, and condition interrupts. The timing to execute any interrupt is after the current executing instruction is complete and the position and state of the next to be executed instruction is retained. After the interrupt is executed, the execution of the next instruction will resume.

11.2 CPU Module Operating Modes

11.2.1 Operating Modes

There are two operating modes. They can be used to control a user program and all tasks.

STOP mode: A program is not executed in this mode. Users can download a module table, initialize CPU configuration and other setting, download a program, check a program, and force a bit ON/OFF.

RUN mode: A program is executed in this mode. Users can NOT download a module table, and initialize CPU configuration and other setting.

11.2.2 Status and Operation under Different Operating Modes

The following table lists the status and operation states for RUN and STOP modes.

- **Basic operation**

CPU mode	Program	I/O refreshing	External output	Program memory	
				Non-latched area	Latched area
STOP	The execution of the program stops.	I/O refreshing executes.	OFF. If you set the I/O module so that the final state of the external output on the I/O module is retained, the final state of the external output on the I/O module is retained.	The data in the program memories is retained.	
RUN	The program executes.	I/O refreshing executes.	The program controls the external output.	The program controls the program memories.	

- **Relationship between the operating modes and tasks**

Mode	Loop task	Interrupt task
STOP	Execution of a loop tasks stops.	Execution of an interrupt task stops.
RUN	<ul style="list-style-type: none"> ● The tasks that have not been executed are in the HALT state. ● If a task is active, or the instruction TKON is executed, the task executes. ● If a task is not active, or the instruction TKOFF 	If the condition of the interrupt is met, the interrupt task executes.

	executes, the task does not execute.	
--	--------------------------------------	--

- **Relationship between changing modes and the program memory**

Change of the mode	Non-latched area	Latched area
STOP→RUN	Data is cleared or retained depending on your setting.	The data is retained.
RUN→STOP	The data is retained.	The data is retained.

MEMO

Chapter 12 Troubleshooting

Table of Contents

12.1 Troubleshooting	12-3
12.1.1 Basic troubleshooting steps	12-3
12.1.2 Clear the Error States.....	12-3
12.1.3 Troubleshooting SOP	12-4
12.1.4 Viewing System Log and Error Step	12-5
12.2 Troubleshooting for CPU Modules	12-7
12.2.1 ERROR LED Indicators Are ON	12-7
12.2.2 ERROR LED Indicators Blinking Every 0.5 Seconds.....	12-7
12.2.3 ERROR LED Indicators Blinking Rapidly Every 0.2 Seconds.....	12-9
12.2.4 ERROR LED Indicators Slow Blinking Every 3 Seconds and Lighting up for 1 Second	12-9
12.2.5 BAT. LOW LED Indicators Are ON	12-10
12.2.6 BAT. LOW LED Indicators Blinking Every 0.5 Seconds.....	12-10
12.2.7 The LED RUN and ERROR Indicators are Blinking Simultaneously Every 0.5 Seconds.....	12-11
12.2.8 The RUN and LED Indicators are Blinking One After Another Every 0.5 Seconds.....	12-11
12.2.9 Other Errors (Without LED Indicators).....	12-11
12.3 Troubleshooting for I/O Modules	12-19
12.3.1 Troubleshooting for Analog Modules (AD/DA/XA) and Temperature Modules (RTD/TC).....	12-19
12.3.2 Troubleshooting for the Positioning Module AS02/04PU	12-20
12.3.3 Troubleshooting for the High-Speed Counter Module AS02HC	12-20
12.3.4 Troubleshooting for the Load Cell Module AS02LC.....	12-21
12.3.5 Troubleshooting for the Module AS04SIL IO-Link as a Communication Module	12-22
12.3.6 Troubleshooting for the Module AS00SCM as a Communication Module.....	12-25
12.3.7 Troubleshooting for the Module AS00SCM as a Remote Module.....	12-26
12.3.8 Troubleshooting for AS01DNET Modules	12-27
12.4 Error Codes and LED Indicators for CPU Modules	12-28
12.4.1 Error Codes and LED Indicators for CPU Modules	12-28
12.4.2 Error Codes and LED Indicators for Analog/Temperature Modules	12-36
12.4.3 Error Codes and LED Indicators for Positioning Module AS02 / 04PU ..	12-36
12.4.4 Error Codes and LED Indicators for High Speed Counter Module AS02HC.....	12-37
12.4.5 Error Codes and LED Indicators for Load Cell Module AS02LC	12-37
12.4.6 Error Codes and LED Indicators for Module AS04SIL IO-Link as a Communication Module	12-38
12.4.7 Error Codes and LED Indicators for Module AS00SCM as a Communication Module.....	12-39
12.4.8 Error Codes and LED Indicators for Module AS00SCM as a Remote	

	Module.....	12-39
12.4.9	Error Codes and LED Indicators for Module AS01DNET (Master/Slave Mode).....	12-39
12.4.10	Error Codes and LED Indicators for Module AS01DNET (RTU Mode)	12-41

12.1 Troubleshooting

This section uses ISPSOft for demonstration. For DIADesigner operation, refer to Chapter 18 from DIADesigner software manual.

12.1.1 Basic troubleshooting steps

This chapter includes the possible errors that can occur during operation, their causes, and corrective actions.

(1) Check the following:

- The PLC should be operated in a safe environment (consider environmental, electronic, and vibration safeties).
- Connect power supply correctly to the PLC.
- Secure the module, terminal, and cable installations.
- All LED indicators show correctly.
- Set all switches correctly.

(2) Check the following operational functions:

- Switch the RUN/STOP state
- Check the settings for the AS Series to RUN/STOP
- Check and eliminate errors from external devices
- Use the System Log function in ISPSOft to check system operation and logs

(3) Identify possible causes:

- AS Series or external device
- CPU or extension modules
- Parameters or program settings

12.1.2 Clear the Error States

Use the following methods to clear the error states. If the error source is not corrected, the system continues to show errors.

- (1) Switch the CPU model state to STOP and then to RUN.
- (2) Turn off the CPU and turn it on again.
- (3) Use ISPSOft to clear the error logs.
- (4) Reset the CPU to the default settings and download the program again.

12.1.3 Troubleshooting SOP

12

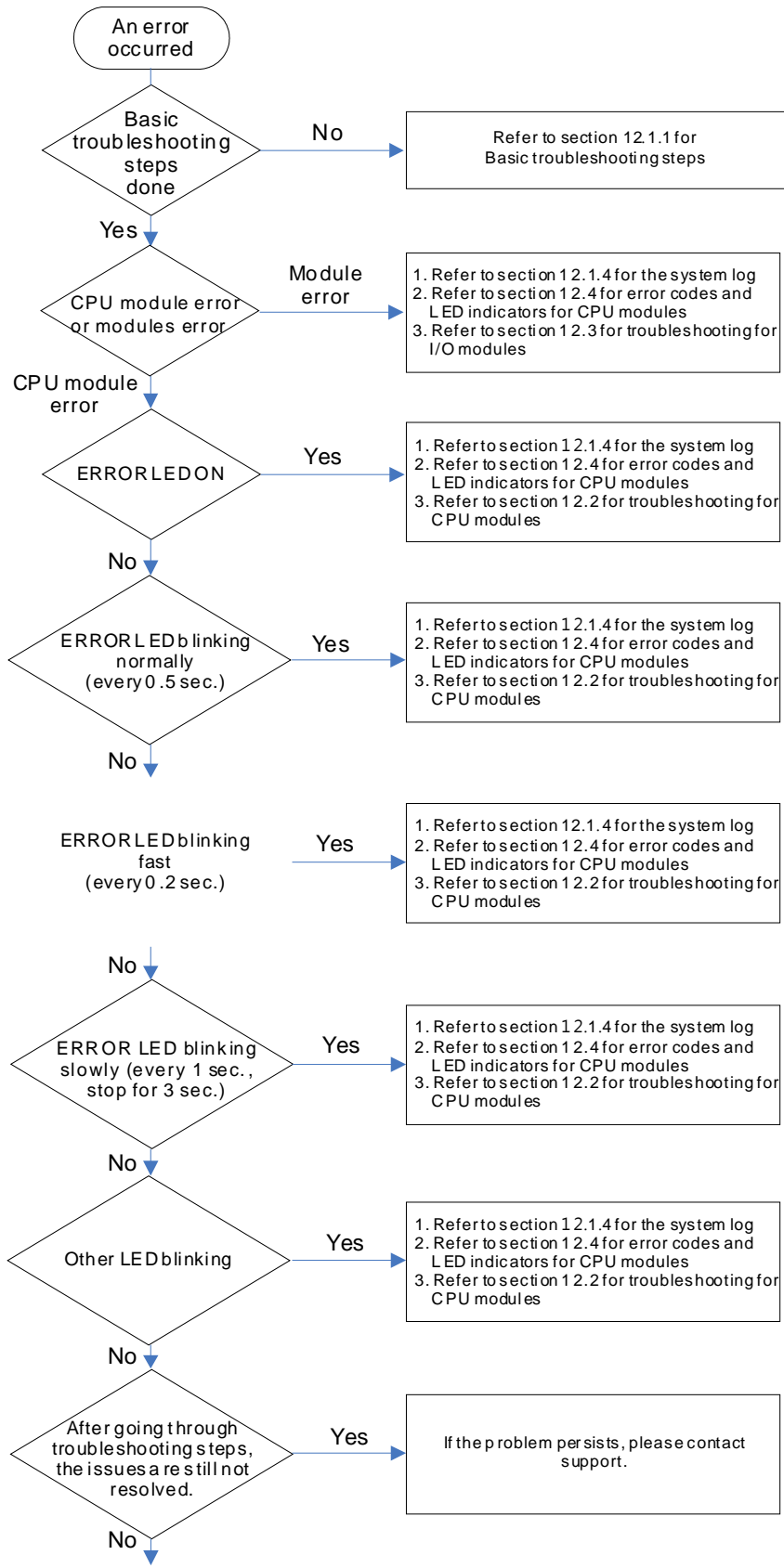

12.1.4 Viewing System Log and Error Step

If ISPSOft is connected to an AS Series, you can view actions and errors in the AS Series by clicking **System Log** on the **PLC** menu. The CPU can store up to 20 error log sets. After the 20 sets are stored, the 1st log is replaced with the 21st if there are new logs coming in, and the old logs are replaced with the new ones sequentially. When the memory card is installed in the CPU module, 20 sets of the old logs are backed up in the memory card and up to 1000 logs can be recorded. If the stored logs exceed 1000, the oldest 20 logs are replaced with the newest 20 logs in the memory card.

- (1) On the **PLC** menu, click **System Log**.

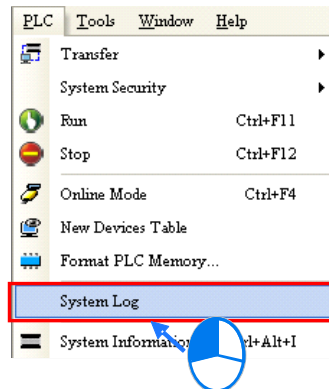

- (2) The **System Log** window appears. Click **Clear Log** to clear the error log in the window and the error log in the CPU module, and reset the CPU module.

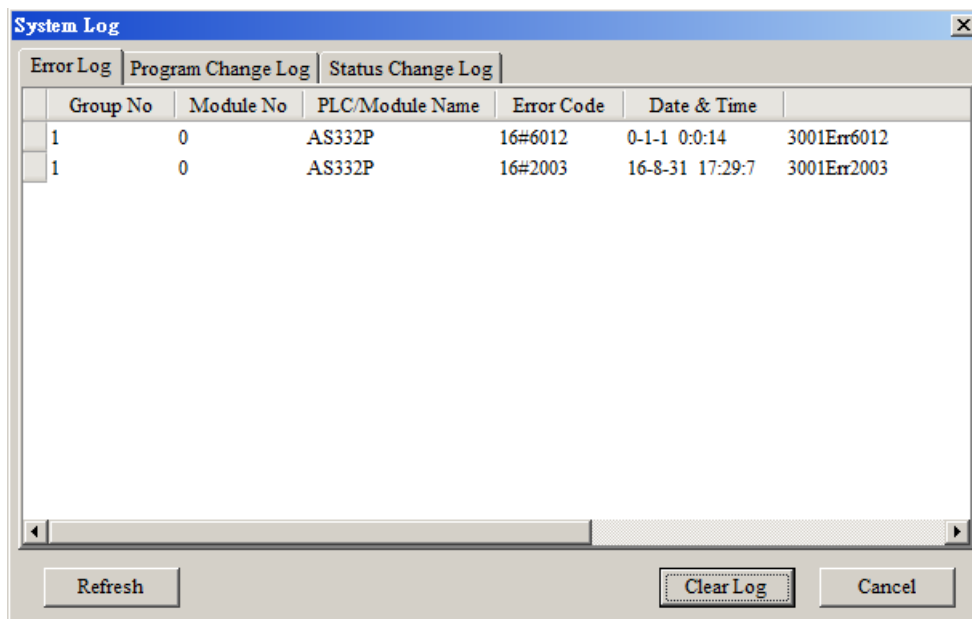

- **Group No.:** The number 1 indicates that the error occurred in the CPU module or the right-side module 1. The numbers 2–16 indicate the error occurred in the remote modules 1–15.
- **Module No.:** The number 0 indicates that the error occurred in the CPU module or the remote module. The numbers 1–32 indicate the error occurred in the right-side module of the CPU module / remote module. The number 1 represents the closest module to the CPU module or the remote module. This number increases from the closest to the furthest from the CPU module or the remote module. Note: up to eight extension modules can be connected to the right-side of the remote module.
- **PLC/Module name:** Model names of the CPU, remote, and extension modules.

- Error Code: Error codes in the error log.
 - Date & Time: The date and time the error occurred. The most recently occurring error is listed on the top.
 - The last column shows the descriptions for the error.
- (3) If the error occurred is an exceeding device range error (SM0 = ON; stored in SR4) or a program syntax error (SM5 = ON; stored in SR0), you can use the following steps to see the problematic step in the program.
- SM0 = ON: Check the value (32-bit) in SR1 to see the latest exceeding device range error in the program.
 - SM5 = ON: Check the value (32-bit) in SR5 to see the latest syntax error step in the program.
 - After knowing which the problematic step is, go to ISPSOft -> Edit -> Step positioning and then enter the number of the problematic step, the system will take you to the specified step in the program.

12

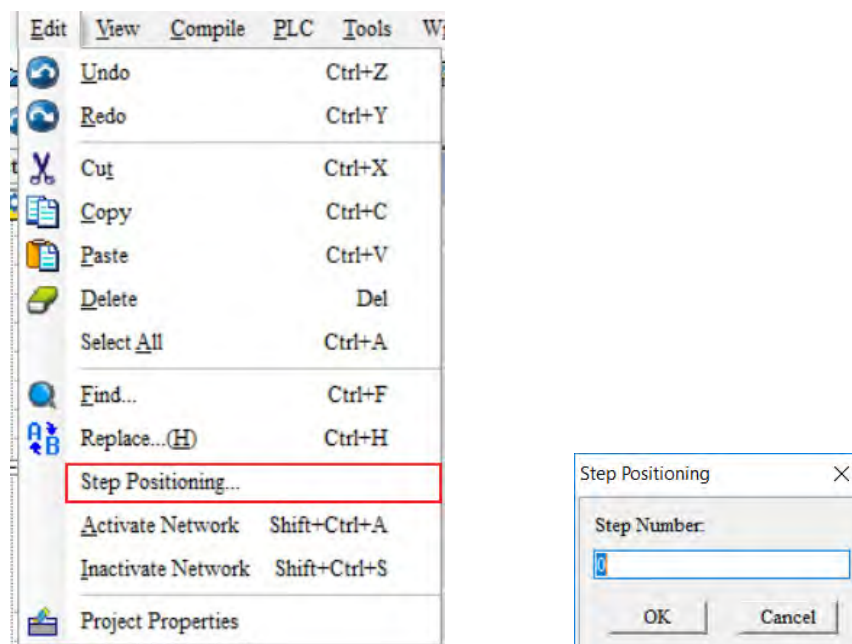

12.2 Troubleshooting for CPU Modules

Check the LED indicators and the error codes from the CPU module and refer to the following table for troubleshooting. V in the Log column indicates the error is recorded in the log. X in the Log column indicates the error is not recorded in the log. H in the Log column indicates whether or not you can set recording the error in the log in HWCONFIG. Error records will be also stored in SR; refer to Chapter 2 for more information on SR.

12.2.1 ERROR LED Indicators Are ON

Error Code (16#)	Description	Solution	Flag	Log
000A	Scan timeout	1. Check the setting of the watchdog timer in HWCONFIG. 2. Check whether the program causes a long scan time	SM8	V

12.2.2 ERROR LED Indicators Blinking Every 0.5 Seconds

Error Code (16#)	Description	Solution	Flag	Log
000C	The program in the PLC is damaged.	Download the program again.	SM9	V
000D	The initial value of the device and the PLC program are not completely downloaded.	Download the program again.	SM9	V
0010	CPU memory access is denied.	If the problem persists, contact the local authorized distributors.	SM9	V
0020	CPU operation speed is not at its highest.	If the problem persists, contact the local authorized distributors.	SM9	V
0021	Failed to restore Delta device parameters back to defaults	1. Check if the EDS file of the device is the same as the device that is to be restored to defaults. 2. Check if the network connection is normal for the PLC CPU and the device that is to be restored to defaults. 3. Check the compatibility of the device to be restored to defaults.	SM9	H
002E	CPU external memory access is denied.	If the problem persists, contact the local authorized distributors.	SM9	V
002F	PLC programs are not consistent with the system logs.	Download the program again.	SM34	V
0070	The arrangement of the function cards is not consistent with the settings.	Check whether the settings in HWCONFIG are consistent with the arrangement of the function cards.	SM10	V
0102	The interrupt number exceeds the range.	Check the syntax error step in the program. Modify and compile the program and then download the program again.	SM5	X
0202	The MC instruction exceeds the range.		SM5	X
0302	The MCR instruction exceeds the range.		SM5	X
0D03	The operands used in DHSCS are		SM5	X

Error Code (16#)	Description	Solution	Flag	Log
	not used properly.			
0E05	The operands HCXXX used in DCNT are not used properly.		SM5	X
1000 - 10FF	System error	If the problem persists, contact the local authorized distributors.	-	V
1300 - 130F	Errors occurred in the remote modules	Refer to Section 12.3.7 for more information on the error codes for the remote modules.	SM30	V
1402	The arrangement of the I/O modules is not consistent with the settings.	Check whether the settings in HWCONFIG are consistent with the arrangement of the I/O modules.	SM10	V
140B	The number of connected communication modules exceed the maximum number 4.	Check the total number of communication modules.	SM10	V
140C	The number of connected positioning modules exceed the maximum number 8.	Check the total number of positioning modules.	SM10	V
140D	The number of connected extension modules exceed the maximum number 32.	Check the total number of extension modules.	SM10	V
140E	More than eight remote modules on the right side of the CPU module.	Check the total number of remote modules on the right side of the CPU module (maximum is 8).	SM30	V
1600	The extension module ID exceeds the range.	1. Make sure the module is properly connected to the CPU module and turn the modules on again. 2. If the problem persists, contact the local authorized distributors.	SM10	V
1601	The extension module ID cannot be set.	1. Make sure the module is properly connected to the CPU module and turn the modules on again. 2. If the problem persists, contact the local authorized distributors.	SM10	V
1602	The extension module ID is duplicated.	1. Make sure the module is properly connected to the CPU module and turn the modules on again. 2. If the problem persists, contact the local authorized distributors.	SM10	V
1603	The extension module cannot be operated.	1. Make sure the module is properly connected to the CPU module and turn the modules on again. 2. If the problem persists, contact the local authorized distributors.	SM10	V
1604	Extension module communication timeout	1. Make sure the module is properly connected to the CPU module and turn the modules on again. 2. If the problem persists, contact the local authorized distributors.	SM10	V
1605	Hardware failure	If the problem persists, contact the local authorized distributors.	SM10	V
1606	Errors on the communication module function card	Make sure the function card is properly connected to the CPU module and turn the modules on again.	SM10	V
1607	The external voltage is abnormal.	Check whether the external 24 V power supply to the	SM10	V

Error Code (16#)	Description	Solution	Flag	Log
		module is normal.		
1608	The Internal factory calibration or the CJC is abnormal.	If the problem persists, contact the local authorized distributors.	SM10	V
1609 - 160F	Reserved (Error codes for the extension modules)			
200A	Invalid instruction	Check the syntax error step in the program. Modify and compile the program and then download the program again.	SM5	V
6010	The number of MODBUS TCP connections exceeds the range.	Check the number of superior devices (maximum is 32).	SM 1092	V
6011	The number of EtherNet/IP connections exceeds the range.	Check the number of connections (maximum is 16).	SM 1093	V
C000 - CFFF	The program syntax is incorrect.	Save the PLC program and hand the file to the company or the technicians.		

12.2.3 ERROR LED Indicators Blinking Rapidly Every 0.2 Seconds

The blinking happens when the power supply 24 VDC of the CPU module is disconnected, or the power supply is not sufficient, not stable or abnormal.

Error Code (16#)	Description	Solution	Flag	Log
002A	The external voltage is abnormal.	Check whether the external 24 V power supply to the module is normal.	SM7	V

12.2.4 ERROR LED Indicators Slow Blinking Every 3 Seconds and Lighting up for 1 Second

Error Code (16#)	Description	Solution	Flag	Log
0040	The converted value in the function card 1 (AS-F2AD) or in the built-in AD input channel 1 exceeds the setting range.	Check the actual input signal	SM27	H
0041	The converted value in the function card 1 (AS-F2AD) or in the built-in AD input channel 2 exceeds the setting range.	Check the actual input signal	SM27	H
0042	The converted value in the input channel 1 of the function card 2 (AS-F2AD) exceeds the setting range.	Check the actual input signal	SM27	H
0043	The converted value in the input channel 2 of the function card 2 (AS-F2AD) exceeds the setting range.	Check the actual input signal	SM27	H

0044	Connection lost in the mode of current input 4 mA - 20 mA for the function card 1 (AS-F2AD) or for the built-in AD input channel 1.	Check the connection cable.	SM27	H
0045	Connection lost in the mode of current input 4 mA - 20 mA for the function card 1 (AS-F2AD) or for the built-in AD input channel 2.	Check the connection cable.	SM27	H
0046	Connection lost in the mode of current input 4 mA - 20 mA for the input channel 1 of the function card 2 (AS-F2AD).	Check the connection cable.	SM27	H
0047	Connection lost in the mode of current input 4 mA - 20 mA for the input channel 2 of the function card 2 (AS-F2AD).	Check the connection cable.	SM27	H
1500	Connection lost in the remote modules	Check the network connection cable.	SM30	V
1502 - 150F	Errors occurred in the remote modules	Refer to Section 12.3.7 for more information on the remote module error codes.	SM30	V
1800 - 180F	Errors occurred in the extension modules	Refer to Section 12.3 for more information on the extension module error codes.	SM10	V
1900 - 191C	Heartbeat errors occurred in the slave in CANopen / ECAT communication.	1. Check the CANopen / ECAT connection cable. 2. Check if the specific slave is working properly. Note: The last 2 digits of the error code represent the ID number of the slave (convert hexadecimal to decimal).	-	V

12.2.5 BAT. LOW LED Indicators Are ON

The blinking happens when there is no battery (CR1620) or the power is low. Turn this option off in the HWCONFIG > CPU > Device Setting > Show Battery Low Voltage Error CPU when you don't need the RTC function to keep track of the current time (default is enabled).

Error Code (16#)	Description	Solution	Flag	Log
0027	Battery Low	Change battery or turn this option off	SM219	X

12.2.6 BAT. LOW LED Indicators Blinking Every 0.5 Seconds

The blinking happens when RTC cannot keep track of the current time.

Error Code (16#)	Description	Solution	Flag	Log
0026	RTC cannot keep track of the current time	If the problem persists, contact the local authorized distributors.	SM218	V
0028	No response from RTC	If the problem persists, contact the local authorized distributors.	SM217	V

12.2.7 The LED RUN and ERROR Indicators are Blinking Simultaneously Every 0.5 Seconds

The blinking happens when the firmware of the CPU module is being upgraded. If this happens once the power is supplied to the CPU module, it means errors occurred during the previous firmware upgrade. Users need to upgrade the firmware again or contact your point of purchase.

12.2.8 The RUN and ERROR LED Indicators are Blinking One After Another Every 0.5 Seconds.

The blinking happens when the CPU module memory card is backing up, restoring, or saving.

If you are using AS218 Series CPU and without engaging any SD card, the RUN and LED indicators blinking indicates the AIO firmware is being updated. If the blinking happens at the instant when the CPU is supplied with power, the blinking means AIO firmware update failed and you need to update the firmware again. If you are not updating the AIO firmware, the blinking indicates CPU error and you need to contact the local authorized distributors.

12.2.9 Other Errors (Without LED Indicators)

Error Code (16#)	Description	Solution	Flag	Log
0011	The PLC ID is incorrect.	Check the PLC ID.	SM34	V
0012	The PLC password is incorrect.	Check the PLC password.	SM34	V
002D	The PLC maximum password attempts exceeded.	Reset the CPU module or restore the CPU module to its default settings.	SM34	V
0050	The memories in the latched special auxiliary relays are abnormal.	1. Reset the CPU module or restore the CPU module to its default settings, and then download the program and the parameters again. 2. If the problem persists, contact the local authorized distributors.	SM6	V
0051	The latched special data registers are abnormal.	1. Reset the CPU module or restore the CPU module to its default settings, and then download the program and the parameters again. 2. If the problem persists, contact the local authorized distributors.	SM6	V
0052	The memories in the latched auxiliary relays are abnormal.	1. Reset the CPU module or restore the CPU module to its default settings, and then download the program and the parameters again. 2. If the problem persists, contact the local authorized distributors.	SM6	V
0054	The latched counters are abnormal.	1. Reset the CPU module or restore the CPU module to its default settings, and then download the program and the parameters again. 2. If the problem persists, contact the local authorized distributors.	SM6	V
0055	The latched 32-bit counters are abnormal.	1. Reset the CPU module or restore the CPU module to its default settings, and then download the program and the parameters again. 2. If the problem persists, contact the local authorized distributors.	SM6	V

0056	The latched special auxiliary relay is abnormal.	1. Reset the CPU module or restore the CPU module to its default settings, and then download the program and the parameters again. 2. If the problem persists, contact the local authorized distributors.	SM6	V
0059	The latched data registers are abnormal.	1. Reset the CPU module or restore the CPU module to its default settings, and then download the program and the parameters again. 2. If the problem persists, contact the local authorized distributors.	SM6	V
005D	The CPU module does not detect a memory card.	Check that the memory card is inserted correctly into the CPU module.	SM453	V
005E	The memory card is initialized incorrectly.	Check whether the memory card is broken.	SM453	V
0063	An error occurs when data is written to the memory card.	Check whether the file path is correct or whether the memory card is malfunctioning.	SM453	V
0064	A file in the memory card cannot be read.	Check whether the file path is correct, or whether the file is damaged.	SM453	V
1950	The initialization of the Delta ASD-A2 control has not yet been completed, the CANopen instructions cannot be executed.	1. Check the CANopen connection cable. 2. Check if the specific slave is working properly. 3. If nothing is wrong, initialize the Delta ASD-A2 again.	-	V
19B0	Heartbeat timeout occurred in the slave mode	Check the CANopen connection cable.	-	V
19B1	The data length of PDO (process data object) in the slave mode is not matched with the setting.	Revise the PDO data length setting in the slave mode and download the setting again.	-	V
Check the value in SR830~SR893 to see which slave (1~64) is experience an error and refer to the following error codes 19E1~19E8 to check the details.				
19E1	The data length of PDO (process data object) in the slave mode is not matched with the setting of the scan list. Refer to CANopen communication related descriptions in AS Series Operation Manual for more details on the error codes 19E1 to 19E8.	Revise the PDO data length setting in the slave mode and download the setting again.	-	V
19E2	PDO in the slave mode is not received.	Check if the configurations are correctly set.	-	V
19E3	The function of auto downloading SDO fails at the first startup.	Check if the SDO contents for auto downloading are correct.	-	V
19E4	PDO configurations are set incorrectly.	Make sure to set the PDO configurations correctly.	-	V
19E5	The main settings are not consistent with the connected slave.	Make sure the connected slaves are the ones configured in ISPSOft.	-	V
19E6	This slave does NOT exist in this network.	Make sure the power supply of slave is normal and slave is correctly connected to the network.	-	V
19E7	Timeout on the slave error control	Make sure the power supply of slave is normal and slave is correctly connected to the network.	-	V
19E8	The node IDs of master and slave are duplicated.	Set the node ID of the master and slave again and make sure their node IDs are unique.	-	V
19F3	Error in the configuration	1. Download the parameter configuration again. 2. If the problem persists, contact the local authorized distributors.	-	V
19F4	CANopen communication is in the BUS-	1. Check if the network cable is normal and the	-	V

	OFF state.	shielded cable is grounded. 2. Check if the start and end of the network cable are both connected with a 121Ω terminal resistor. 3. Check if all the node devices run at the same baud rate on the network.		
19FB	The sending registers exceed the range.	Revise the time to synchronize (suggested to use a longer time).	-	V
19FC	The receiving registers exceed the range.	Revise the time to synchronize (suggested to use a longer time).	-	V
2001	Not using the FCOMP card or not in the right mode for the ASDA-A2 while using the CANopen communication instruction.	1. Use the FCOMP card in the function card slot to check if the operation mode is correct. 2. Check the syntax error step in the program. Modify and compile the program and then download the program again.	SM0	V
2003	The device used in the program exceeds the device range.	Check the syntax error step in the program. Modify and compile the program and then download the program again.	SM0	V
200B	The operand n or the other constant operands K/H exceed the range.		SM0	V
200C	The operands overlap.		SM0	V
200D	The binary to binary-coded decimal conversion is incorrect.		SM0	V
200E	The string does not end with 00.		SM0	V
2012	Incorrect division operation		SM0	V
2013	The value exceeds the range of values that can be represented by the floating-point numbers.		SM0	V
2014	The task designated by the TKON or YKOFF instruction is incorrect or exceeds the range.		SM0	V
2017	The instruction BREAK is written outside of the FOR-NEXT loop.	SM0	V	
2027	No such position planning table number or the format is incorrect.	1. Check the syntax error step in the program. Modify and compile the program and then download the program again. 2. Check the settings of the position planning table.	SM0	V
2028	High speed output instruction is being executed. Only one instruction can be executed at a time.	Refer to SR28 for the record of the axis number and rearrange the output control procedures.	-	V
2030	During the execution of CSFO instruction, the output frequency exceeds the upper limit.	Modify the ratio of input / output frequency or lower the input frequency value.	-	V
2031	During the execution of CSFO instruction, when the output frequency is set to 0, but even after 2 seconds, the output is still not complete.		-	V
6004	The IP address filter is set incorrectly.	Set the Ethernet parameter for the CPU module in HWCONFIG again.	SM1108	X
600D	RJ45 port is not connected.	Check the connection.	SM1100	X

6012	There are devices using the same IP address.	<ol style="list-style-type: none"> 1. Check if there are devices using the same IP address. 2. Check if there is more than 1 DHCP or BOOTP server on the network. 	SM1101	V
6100	The email connection is busy.	Retry the email connection later. This error does not cause the PLC to stop running. Solve the problem by means of the related flag in the program.	SM1113	X
6103	The trigger attachment mode in the email is set incorrectly.	Set up the trigger attachment mode in HWCONFIG > CPU Module > Device Setting > Options > Ethernet Port Advanced > Email > Trigger Setting > Trigger Attachment Mode.	SM1113	X
6104	The attachment in the email does not exist.	Check whether the attachment exists in the memory card.	SM1113	X
6105	The attachment in the email is oversized.	Check the size of the attachment. If the size is over 2 MB, the file cannot be sent as an attachment.	SM1113	X
6106	There is an SMTP server response timeout.	Check for the correct address and set up the SMTP server in HWCONFIG > CPU Module > Device Setting > Options > Ethernet Port Advanced > Email again.	SM1113	X
6107	There is an SMTP server response timeout.	<ol style="list-style-type: none"> 1. Check whether the status of the SMTP server is normal. 2. Retry sending of the email later. This error does not cause the PLC to stop running. Solve the problem by means of the related flag in the program. 	SM1113	X
6108	SMTP verification failed	Check for the correct ID/Password and set up in HWCONFIG > CPU Module > Device Setting > Options > Ethernet Port Advanced > Email again.	SM1113	X
6200	The remote communication IP address set in the TCP socket function is illegal.	<ol style="list-style-type: none"> 1. Check the program and the related special data registers. 2. Set the Ethernet parameter for the CPU module in HWCONFIG CPU Module > Device Setting > Options > Ethernet Port Advanced > TCP Socket. 	-	X
6201	The local communication port set in the TCP socket function is illegal.	<ol style="list-style-type: none"> 1. Check the program and the related special data registers. 2. Set the Ethernet parameter for the CPU module in HWCONFIG CPU Module > Device Setting > Options > Ethernet Port Advanced > TCP Socket. 	-	X
6202	The remote communication port set in the TCP socket function is illegal.	<ol style="list-style-type: none"> 1. Check the program and the related special data registers. 2. Set the Ethernet parameter for the CPU module in HWCONFIG CPU Module > Device Setting > Options > Ethernet Port Advanced > TCP Socket. 	-	X
6203	The device from which the data is sent in the TCP socket function is illegal.	<ol style="list-style-type: none"> 1. Check the program and the related special data registers. 2. Set the Ethernet parameter for the CPU module in HWCONFIG CPU Module > Device Setting > Options > Ethernet Port Advanced > TCP Socket. 	-	X

6206	The device which receives the data in the TCP socket function is illegal.	<ol style="list-style-type: none"> 1. Check the program and the related special data registers. 2. Set the Ethernet parameter for the CPU module in HWCONFIG CPU Module > Device Setting > Options > Ethernet Port Advanced > TCP Socket. 	-	X
6208	The data received through the TCP socket exceeds the device range.	<ol style="list-style-type: none"> 1. Check the program and the related special data registers. 2. Set the Ethernet parameter for the CPU module in HWCONFIG CPU Module > Device Setting > Options > Ethernet Port Advanced > TCP Socket. 	-	X
6209	The remote communication IP address set in the UDP socket function is illegal.	<ol style="list-style-type: none"> 1. Check the program and the related special data registers. 2. Set the Ethernet parameter for the CPU module in HWCONFIG CPU Module > Device Setting > Options > Ethernet Port Advanced > UDP Socket. 	-	X
620A	The local communication port set in the UDP socket function is illegal.	<ol style="list-style-type: none"> 1. Check the program and the related special data registers. 2. Set the Ethernet parameter for the CPU module in HWCONFIG CPU Module > Device Setting > Options > Ethernet Port Advanced > UDP Socket. 	-	X
620C	The device from which the data is sent in the UDP socket function is illegal.	<ol style="list-style-type: none"> 1. Check the program and the related special data registers. 2. Set the Ethernet parameter for the CPU module in HWCONFIG CPU Module > Device Setting > Options > Ethernet Port Advanced > UDP Socket. 	-	X
620F	The device which receives the data in the UDP socket function is illegal.	<ol style="list-style-type: none"> 1. Check the program and the related special data registers. 2. Set the Ethernet parameter for the CPU module in HWCONFIG CPU Module > Device Setting > Options > Ethernet Port Advanced > UDP Socket. 	-	X
6210	The data received through the UDP socket exceeds the device range.	<ol style="list-style-type: none"> 1. Check the program and the related special data registers. 2. Set the Ethernet parameter for the CPU module in HWCONFIG CPU Module > Device Setting > Options > Ethernet Port Advanced > UDP Socket. 	-	X
6212	There is no response from the remote device after the timeout period.	Make sure that the remote device is connected.	-	X
6213	The data received exceeds the limit.	<ol style="list-style-type: none"> 1. Check the program and the related special data registers. 2. Set the Ethernet parameter for the CPU module in HWCONFIG CPU Module > Device Setting > Options > Ethernet Port Advanced > UDP Socket. 	-	X
6214	The remote device refuses the connection.	Make sure the remote device operates normally.	-	X
6215	The socket is not opened.	Check whether operational sequence in the	-	X

		program is correct.		
6217	The socket is opened.	Check whether operational sequence in the program is correct.	-	X
6218	The data has been sent through the socket.	Check whether operational sequence in the program is correct.	-	X
6219	The data has been received through the socket.	Check whether operational sequence in the program is correct.	-	X
621A	The socket is closed.	Check whether operational sequence in the program is correct.	-	X
7011	The device communication function code in COM1 is incorrect.	1. Check the communication setting in the master and the slave. 2. Check the communication cable.	-	H
7012	The device communication address used in COM1 is incorrect.	1. Check the communication setting in the master and the slave. 2. Check the communication cable.	-	H
7013	The device used in COM1 exceeds the device range.	1. Check the communication setting in the master and the slave. 2. Check the communication cable.	-	H
7014	The device length of the communication data in COM1 exceeds the limit.	1. Check the communication setting in the master and the slave. 2. Check the communication cable.	-	H
7017	The device checksum for the communication serial port of COM1 is incorrect.	1. Check the communication setting in the master and the slave. 2. Check the communication cable.	-	H
7021	The device communication function code in COM2 is incorrect.	1. Check the communication setting in the master and the slave. 2. Check the communication cable.	-	H
7022	The device communication address used in COM2 is incorrect.	1. Check the communication setting in the master and the slave. 2. Check the communication cable.	-	H
7023	The device used in COM2 exceeds the device range.	1. Check the communication setting in the master and the slave. 2. Check the communication cable.	-	H
7024	The device length of the communication data in COM2 exceeds the limit.	1. Check the communication setting in the master and the slave. 2. Check the communication cable.	-	H
7027	The device checksum for the communication serial port of COM2 is incorrect.	1. Check the communication setting in the master and the slave. 2. Check the communication cable.	-	H
7031	The device communication function code in the Ethernet is incorrect.	1. Check the communication setting in the master and the slave. 2. Check the communication cable.	-	H
7032	The device communication address used in the Ethernet is incorrect.	1. Check the communication setting in the master and the slave. 2. Check the communication cable.	-	H
7033	The device used in the Ethernet exceeds the device range.	1. Check the communication setting in the master and the slave. 2. Check the communication cable.	-	H
7034	The device length of the communication data in the Ethernet exceeds the limit.	1. Check the communication setting in the master and the slave. 2. Check the communication cable.	-	H

7037	The device checksum for the communication serial port of the Ethernet is incorrect.	1. Check the communication setting in the master and the slave. 2. Check the communication cable.	-	H
7041	The device communication function code in the USB is incorrect.	1. Check the communication setting in the master and the slave. 2. Check the communication cable.	-	H
7042	The device communication address used in the USB is incorrect.	1. Check the communication setting in the master and the slave. 2. Check the communication cable.	-	H
7043	The device used in the USB exceeds the device range.	1. Check the communication setting in the master and the slave. 2. Check the communication cable.	-	H
7044	The device length of the communication data in the USB exceeds the limit.	1. Check the communication setting in the master and the slave. 2. Check the communication cable.	-	H
7047	The device checksum for the communication serial port of the USB is incorrect.	1. Check the communication setting in the master and the slave. 2. Check the communication cable.	-	H
70B1	The device communication function code in function card 1 is incorrect.	1. Check the communication setting in the master and the slave. 2. Check the communication cable.	-	H
70B2	The device communication address used in function card 1 is incorrect.	1. Check the communication setting in the master and the slave. 2. Check the communication cable.	-	H
70B3	The device used in the function card 1 exceeds the device range.	1. Check the communication setting in the master and the slave. 2. Check the communication cable.	-	H
70B4	The device length of the communication data in function card 1 exceeds the limit.	1. Check the communication setting in the master and the slave. 2. Check the communication cable.	-	H
70B7	The device checksum for the communication serial port of function card 1 is incorrect.	1. Check the communication setting in the master and the slave. 2. Check the communication cable.	-	H
70C1	The device communication function code in function card 2 is incorrect.	1. Check the communication setting in the master and the slave. 2. Check the communication cable.	-	H
70C2	The device communication address used in function card 2 is incorrect.	1. Check the communication setting in the master and the slave. 2. Check the communication cable.	-	H
70C3	The device used in function card 2 exceeds the device range.	1. Check the communication setting in the master and the slave. 2. Check the communication cable.	-	H
70C4	The device length of the communication data in function card 2 exceeds the limit.	1. Check the communication setting in the master and the slave. 2. Check the communication cable.	-	H
70C7	The device checksum for the communication serial port of function card 2 is incorrect.	1. Check the communication setting in the master and the slave. 2. Check the communication cable.	-	H
7203	Invalid communication function code	1. Refer to the function codes defined by the communication protocols. 2. Check if the product firmware and the software	-	H

		used are the most updated versions. 3. Make a note of the operation procedures and screenshots of the error windows and hand this note to the company or the technicians from the agents.		
8105	The contents of the program downloaded are incorrect. The program syntax is incorrect.	1. Download the program and parameters again. 2. Check the communication cable. 3. Save all the projects and compress the projects into one compressed file and then hand this file to the company or the technicians from the agents.	-	H
8106	The contents of the program downloaded are incorrect. The length of the execution code exceeds the limit.	1. Download the program and parameters again. 2. Save all the projects and compress the projects into one compressed file and then hand this file to the company or the technicians from the agents.	-	H
8107	The contents of the program downloaded are incorrect. The length of the source code exceeds the limit.	1. Download the program and parameters again. 2. Save all the projects and compress the projects into one compressed file and then hand this file to the company or the technicians from the agents.	-	H
8000 - 8FFF	Errors occur between software and PLC.	1. Check if the product firmware and the software used are the most updated versions. 2. Make a note of the operation procedures and screenshots of the error windows and hand this note to the company or the technicians from the agents.		

12.3 Troubleshooting for Other I/O Modules

- **Introduction to troubleshooting modules**

Digital I/O, analog I/O, temperature measurement, positioning, counter, load cell, and network modules can be installed in an AS Series system. There are 2 types of error codes; error and warning. The CPU module and its modules stop operating when errors occur. The CPU modules and its modules do not stop operating when warnings are triggered.

12.3.1 Troubleshooting for Analog Modules (AD/DA/XA) and Temperature Modules (RTD/TC)

12

12.3.1.1 ERROR LED Indicators Are ON

You can set up HWCONFIG to have the following errors appear as warnings when they occur. Otherwise, when an error occurs, only an error message appears.

Error Code	Description	Solution
16#1605	Hardware failure	If the problem persists, contact the local authorized distributors.
16#1607	The external voltage is abnormal.	Check the power supply.
16#1608	The factory calibration or the CJC is abnormal.	If the problem persists, contact the local authorized distributors.

12.3.1.2 ERROR LED Indicators Blinking Every 0.2 Seconds

The following errors are specified as warnings to ensure that the CPU can still run even when the warnings are triggered by its modules. If you need the CPU STOP running immediately when the first 4 errors occur, you need to set them as errors.

Error Code	Description	Solution
16#1801	The external voltage is abnormal.	Check the power supply.
16#1802	Hardware failure	If the problem persists, contact the local authorized distributors.
16#1804	The factory calibration is abnormal.	If the problem persists, contact the local authorized distributors.
16#1807	The CJC is abnormal.	If the problem persists, contact the local authorized distributors.
16#1808	The signal received by channel 1 exceeds the range of analog inputs (temperature).	Check the signal received by channel 1
16#1809	The signal received by channel 2 exceeds the range of analog inputs (temperature).	Check the signal received by channel 2
16#180A	The signal received by channel 3 exceeds the range of analog inputs (temperature).	Check the signal received by channel 3
16#180B	The signal received by channel 4 exceeds the range of analog inputs (temperature).	Check the signal received by channel 4

Error Code	Description	Solution
16#180C	The signal received by channel 5 exceeds the range of analog inputs (temperature).	Check the signal received by channel 5
16#180D	The signal received by channel 6 exceeds the range of analog inputs (temperature).	Check the signal received by channel 6
16#180E	The signal received by channel 7 exceeds the range of analog inputs (temperature).	Check the signal received by channel 7
16#180F	The signal received by channel 8 exceeds the range of analog inputs (temperature).	Check the signal received by channel 8
-	When power-on, the module is not detected by CPU module.	Check if the connection between module and CPU module is working. If not, connect again.

12.3.2 Troubleshooting for the Positioning Module AS02/04PU

12.3.2.1 ERROR LED Indicators Blinking Every 0.2 Seconds

Error Code	Description	Solution
16#1802	Hardware failure	If the problem persists, contact the local authorized distributors.

12.3.3 Troubleshooting for the High-Speed Counter Module AS02HC

12.3.3.1 ERROR LED Indicators Are ON

Error Code	Description	Solution
16#1605	Counted result in the latched area is not retainable (major error)	Counted data is lost. Switch the module power OFF and ON again. The error code is cleared by the system. If the problem persists, contact the local authorized distributors.
16#1606	Module settings in the latched area is not retainable. (major error)	Module setting data is lost. Switch the module power OFF and ON again. Download the HWCONFIG settings again to clear the error code. If the problem persists, contact the local authorized distributors.
16#1607	Module setting error (major error)	Check if the setting in HWCONFIG is consistent with the actual placement. If the problem persists, contact the local authorized distributors.

12.3.3.2 ERROR LED Indicators Blinking Every 0.5 Seconds

The following errors are specified as warnings to ensure that the CPU module can still run even when the warnings are triggered by its AIO modules.

Error Code	Description	Solution
16#1800	Counter overflow / underflow on CH1	Check the counter result. If the alarm is not required, disable the alarm output function in HWCONFIG. Use any of the followings to clear the error code: clear, reset, preset the counter, restart the module, or execute DHCCNT instruction again.
16#1801	Counter overflow / underflow on CH2	
16#1802	Linear count exceeding the set upper/lower limit on CH1	Check the signal received by channel 1 and 2. Hardware counter is still counting; when the number is accumulated to the maximum and go back to the minimum, the error code will be cleared.
16#1803	Linear count exceeding the set upper/lower limit on CH2	
16#1804	The variation in relation to a SSI encoder position exceeding the limit on CH1	Check if there is any interruption and check the device specification to see if the offset setting is matching with the actual placement. When the next reading is normal, the error code will be cleared.
16#1805	The variation in relation to a SSI encoder position exceeding the limit on CH2	
16#1806	Abnormal SSI communication on CH1	Check the execution of DHCCNT instruction. If it is parity check, check is there is any interruption and check if the data format is correct. Check if the device wiring is secure, and if the encoder power supply is normal.
16#1807	Abnormal SSI communication on CH2	
16#1808	SSI absolute position cross zero point on CH1	Check the SSI absolute encoder specification and modify the setting accordingly. If the alarm is not required, disable the alarm output function in HWCONFIG. Use any of the followings to clear the error code: clear, reset, preset the counter, restart the module, or execute DHCCNT instruction again.
16#1809	SSI absolute position cross zero point on CH2	

12.3.4 Troubleshooting for the Load Cell Module AS02LC

12.3.4.1 ERROR LED Indicators Are ON

You can set up HWCONFIG to have the following errors appear as warnings when they occur. Otherwise, when an error occurs, only an error message appears.

Error Code	Description	Solution
16#1605	Hardware failure (that is, the driver board)	If the problem persists, contact the local authorized distributors.
16#1607	The external voltage is abnormal.	Check the power supply.

12.3.4.2 ERROR LED Indicators Blinking Every 0.2 Seconds

The following errors are specified as warnings to ensure that the CPU module can still run even when the warnings are triggered by its modules. The following first 3 error codes are set as warnings by default in HWCONFIG; CPU must STOP running immediately when the first 3 errors occur.

Error Code	Description	Solution
16#1801	The external voltage is abnormal.	Check the power supply.
16#1802	Hardware failure	If the problem persists, contact the local authorized distributors.
16#1807	Diver board failure	Check if the terminal is affected by noises or is short-circuited, i.e. EXC+ and EXC-. If the problem persists, contact the local authorized distributors.
16#1808	The signal received by channel 1 exceeds the range of analog inputs or the SEN voltage is abnormal.	Check the signal received by channel 1 and the cable connections.
16#1809	The signal received by channel 1 exceeds the weight limit.	Check the value input to channel 1 and the maximum weight setting.
16#180A	The factory calibration in channel 1 is incorrect.	Check the weight calibration in channel 1.
16#180B	The signal received by channel 2 exceeds the range of analog inputs or the SEN voltage is abnormal.	Check the signal received by channel 2 and the cable connections.
16#180C	The signal received by channel 2 exceeds the weight limit.	Check the value input to channel 2 and the maximum weight setting.
16#180D	The factory calibration in channel 2 is incorrect.	Check the weight calibration in channel 1.
-	When power-on, the module is not detected by CPU module.	Check if the connection between module and CPU module is working. If not, connect again.

12.3.5 Troubleshooting for the Module AS04SIL IO-Link as a Communication Module

12.3.5.1 ERROR LED Indicators (Module Status) Blinking Every 0.2 Seconds

The following error codes identify possible errors when the AS04SIL module is installed on the right side of the CPU module or RTU and acts as a communication module.

Error Code	Description	Solution
16#1605	Hardware failure	<ol style="list-style-type: none"> 1. Check that the module is securely installed. 2. Install a new AS04SIL or if the problem persists, contact the local authorized distributors.
16#1606	24VDC power supply is not sufficient and then recovered from low-voltage for less than 10 ms.	Check whether the 24 V power supply to the module is normal.

12.3.5.2 ERROR LED Indicators (Network Status) Are ON

The following error codes identify possible errors when the AS-SIL module is installed on the right side of the CPU module or RTU and acts as a communication module.

Error Code	Description	Solution
16#1802	No external power supply	Check the external power supply

12.3.5.3 ERROR LED Indicators (Network Status) Blinking Every 1 Seconds

The following error codes identify possible errors when the AS-SIL module is installed on the right side of the CPU module or RTU and acts as a communication module.

Error Code	Description	Solution
16#1800	Error occurs in IO-Link Master	See the following IO-Link Event Code table for more information.
16#1801	Error occurs in IO-Link device	See the following IO-Link Event Code table for more information.
16#1803	Error in the download of IO-Link device mapping tables	Redownload the configuration by the software.
16#1804	Failure to switch the process data parameter set	Check if the configurations of the actual connected device are the same as the ones in the software.
16#1805	A connection error occurs in IO-Link via communication port 1	1. Cut the external power off for 3 seconds and then put the power back on. 2. Redownload the configuration by the software.
16#1806	A connection error occurs in IO-Link via communication port 2	
16#1807	A connection error occurs in IO-Link via communication port 3	
16#1808	A connection error occurs in IO-Link via communication port 4	
16#1809	Device scanning error and the scanning is forced to stop	1. Cut the external power off for 3 seconds and then put the power back on. 2. Scan all device again

IO-Link Event Code Table

You can find the IO-Link event codes in the module data exchange area where the device states of communication port 1~4 are stored. Check the IO-Link device operation manual if the event occurred is from IO-Link devices.

IO-Link Event Codes	Type			Event	Solution	Source	
	Warning	Error	Notification			IO-Link Master	IO-Link Device
16#4000		√		Device temperature over-load	Lower load		√
16#4210	√			Device temperature over-run	Clear source of heat		√
16#5101		√		Device fuse blown	Change fuse		√
16#5110	√			Power supply voltage over-run	Check tolerance		√
16#5111	√			Power supply voltage under-run	Check tolerance		√
16#6320		√		Parameter error	Check device specifications		√
16#6321		√		Parameter missing	Check device specifications		√

IO-Link Event Codes	Type			Event	Solution	Source	
	Warning	Error	Notification			IO-Link Master	IO-Link Device
16#7710		V		Device short circuit	Check installation		V
16#8C10	V			Process variable range over-run	Check process data		V
16#8C20		V		Measurement range over-run	Check application		V
16#8C30	V			Process variable range under-run	Check process data		V
16#8CA0	V			No connected IO-Link device	Check installation	V	
16#8CA1	V			The version of the IO-Link protocol is different from the one configured.	Use matching IODD file and configured again.	V	
16#8CA2	V			Connected device is different from the one configured in the software	Check configurations and installation	V	
16#8CA3				Reserved		V	
16#8CA4		V		IO-Link device process cable short circuit	Check installation	V	
16#8CA5	V			Master temperature exceeds 135°C	Clear source of heat	V	
16#8CA6		V		Master temperature exceeds 160°C	Clear source of heat and lower load	V	
16#8CA7	V			Device power supply voltage under-run L+ (<18V)	Check the external power supply	V	
16#8CA8		V		Device power supply voltage under-run L+ (<9V)	Check the external power supply	V	
16#8CA9	V			Illegal device ID	Check device specifications	V	
16#8CAA	V			IO-Link process data range over-run	Check device specifications	V	
16#8CAB	V			Process data range over-run	Scan the device and download the configuration again	V	
16#8CAC		V		Data storage error	If the problem persists, contact the local authorized distributors.	V	
16#FF21			V	New connected device		V	
16#FF22			V	Device disconnected	Check installation	V	
16#FF23			V	Data storage identification mismatch	Set the Data Storage access locked and set it to backup / restore and then backing up data according to actual placement.	V	
16#FF24			V	Data storage not sufficient	Check device specifications	V	
16#FF25			V	Data storage parameter access denied	Check device specifications	V	

12.3.6 Troubleshooting for the Module AS00SCM as a Communication Module

12.3.6.1 ERROR LED Indicators Are ON

The following error codes identify possible errors when the AS00SCM module is installed on the right side of the CPU module and acts as a communication module.

Error Code	Description	Solution
16#1605	Hardware failure	<ol style="list-style-type: none"> 1. Check that the module is securely installed. 2. Install a new AS00SCM or if the problem persists, contact the local authorized distributors.
16#1606	The function card setting is incorrect.	<ol style="list-style-type: none"> 1. Check if the function card is securely installed. 2. Install a new function card or if the problem persists, contact the local authorized distributors. 3. Check if the setting in HWCONFIG is consistent with the function card setting. 4. Install a new AS00SCM or if the problem persists, contact the local authorized distributors.

12.3.6.2 ERROR LED Indicators Blinking Every 0.5 Seconds

The following error codes identify possible errors when the AS00SCM module is installed on the right side of the CPU module and acts as a communication module.

Error Code	Description	Solution
16#1802	Incorrect parameters	Check the parameter in HWCONFIG. Download the parameter again.
16#1803	Communication timeout	<ol style="list-style-type: none"> 1. Check whether the communication cable is properly connected. 2. Check if the station number and the communication format are correctly set. 3. Check if the connection with the function card is working correctly.
16#1804	The UD Link setting is incorrect.	<ol style="list-style-type: none"> 1. Check the settings of the UD Link. 2. Check the warning settings in the PLC.

The following error codes can only be viewed with SCMSOft; when the following errors occur, they are not shown on the LED indicators and the system does not send the error messages to the CPU module.

Error Code	Description	Solution
16#0107	The settings in HWCONFIG and manual settings are not consistent with function card 1.	Check the settings in HWCONFIG and manual settings for function card 1.
16#0108	The settings in HWCONFIG and manual settings are not consistent for function card 2.	Check the settings in HWCONFIG and manual settings for function card 2.
16#0201	Incorrect parameters	Check the parameter in HWCONFIG. Download the parameter again.

Error Code	Description	Solution
16#0301	Function card 1 communication timeout	<ol style="list-style-type: none"> 1. Check if the station number and the communication format are correctly set. 2. Check if the connection with the function card is working correctly.
16#0302	Function card 2 communication timeout	<ol style="list-style-type: none"> 1. Check if the station number and the communication format are correctly set. 2. Check if the connection with the function card is working correctly.
16#0400	Invalid UD Link Group ID for function card 1	<ol style="list-style-type: none"> 1. Check the UD Link settings. 2. Check the warning settings in the PLC.
16#0401	Invalid UD Link Group ID for function card 2	<ol style="list-style-type: none"> 1. Check the UD Link settings. 2. Check the warning settings in the PLC.
16#0402	Invalid UD Link Command for function card 1	<ol style="list-style-type: none"> 1. Check the UD Link settings. 2. Check the warning settings in the PLC.
16#0403	Invalid UD Link Command for function card 1	<ol style="list-style-type: none"> 1. Check the UD Link settings. 2. Check the warning settings in the PLC.

12.3.7 Troubleshooting for the Module AS00SCM as a Remote Module

Errors from the remote modules are regarded as warnings for AS Series CPU modules. The LED indicator of the CPU module blinks and the CPU module can still operate. Use flag SM30 to manage error presentation in the remote modules.

12.3.7.1 ERROR LED Indicators Are ON

Error codes:

Error Code	Description	Solution
16#1301	Hardware failure	<ol style="list-style-type: none"> 1. Check if the module is securely installed. 2. Change and install a new AS00SCM or if the problem persists, contact the local authorized distributors.
16#1302	The function card setting is incorrect.	<ol style="list-style-type: none"> 1. Check if the function card is securely installed with the AS-FCOPM card. 2. Change and install a new function card or if the problem persists, contact the local authorized distributors. 3. Check if the setting in HWCONFIG is consistent with the function card setting. 4. Install a new AS00SCM or if the problem persists, contact the local authorized distributors.
16#1304	More than eight remote modules on the right side of the CPU module.	Check the total number of remote modules on the right side of the CPU module (maximum is 8).

12.3.7.2 ERROR LED Indicators Blinking Every 0.5 Seconds

Warning type of error codes:

Error Code	Description	Solution
16#1506	Remote module had been stopped.	This error code should work with AS Series Remote Module Setting in ISPSOft. When this error code shows up, it indicates the remote module had been stopped: Master Disconnected, Master Reconnected, IO Module Alarm, or IO Module Timeout. Check and clear the problem and then power-off and then power-on the remote module to refresh its state. Refer to section 9.4.3 in AS Series Module Manual for more details.

12

12.3.7.3 ERROR LED Indicators Blinking Every 0.5 Seconds

Warning type of error codes:

Error Code	Description	Solution
16#1500	Remote module communication timeout	Make sure the communication cable is well connected
16#1502	Incorrect parameters	Check the parameter in HWCONFIG. Download the parameter again.
16#1503	Remote extension module communication timeout	Make sure the communication cable is well connected and the module is properly connected to the CPU module and turn the modules on again.
16#1505	The actual placement of the extension modules is NOT the same as it is set.	Check if the parameter in HWCONFIG is the same as the actual placement.
16#1604	Extension module communication timeout	1. Make sure the module is properly connected to the CPU module and turn the modules on again. 2. If the problem persists, contact the local authorized distributors.

12.3.7.4 ERROR LED Indicators Blinking Every 0.2 Seconds

This happens when the 24 VDC power supply for the remote module is not sufficient. Check the power supply. If the power supply is normal, remove the extension module from the CPU module and then check if the SCM remote module is out of order. Error codes:

Error Code	Description	Solution
16#1303	24VDC power supply is not sufficient and then recovered from low-voltage for less than 10 ms.	Check whether the 24 V power supply to the module is normal.

12.3.8 Troubleshooting for AS01DNET Modules

Refer to sections 12.4.9 and 12.4.10 for more details.

12.4 Error Codes and LED Indicators for Modules

12.4.1 Error Codes and LED Indicators for CPU Modules

A. Columns

- a. Error code: If an error occurs in the system, an error code is generated.
- b. Description: The description of the error
- c. CPU status: If the error occurs, the CPU stops running, keeps running, or shows the status you defined for the error.
 - Stop: The CPU stops running when the error occurs.
 - Continue: The CPU keeps running when the error occurs.
- d. LED indicator status: If the error occurs, the LED indicator is ON, OFF, or blinks.
 - ERROR: System error

● Descriptions

Module Type	LED indicator	Descriptions
CPU	Error LED	<p>There are five types of error indicator states for of the CPU module errors, including LED indicator ON, OFF, blinking fast, blinking normally, and blinking slowly. When the LED indicator is ON, blinking fast/normally, clear the problems first in order to run the CPU module. When the LED indicator is blinking slowly, indicating a warning type of error codes, it does not require immediate action. Clear the problems when the module is powered off.</p> <p>Error type:</p> <p>ON: A serious error occurs in the module.</p> <p>Blinking fast (every 0.2 seconds): unstable power supply or hardware Failure.</p> <p>Blinking normally (every 0.5 second): system program errors or system cannot run.</p> <p>Warning type:</p> <p>Blinking slowly (every 1 second and off for 3 seconds): a warning is triggered, but the system can still run.</p> <p>OFF:</p> <p>A warning is triggered, but the system can still run. You can modify the rules and use ISPSOft or SM/SR to show the warnings, instead of using indicators to show the errors.</p>

Error code	Description	CPU status	ERROR LED indicator				
			ON	Blinking fast	Blinking normally	Blinking slowly	OFF
000A	Scan timeout	Stop	V				
000C	The program in the PLC is damaged.	Stop			V		
000D	The initial value of the device and the PLC program are not completely downloaded.	Stop			V		
0010	CPU memory access is denied.	Stop			V		
0011	The PLC ID is incorrect.	Continue					V
0012	The PLC password is incorrect.	Continue					V
0020	CPU operation speed is not at its highest.	Stop			V		
0021	Failed to restore Delta device parameters back to defaults	H			H		
<p>Note: You can set to have PLC CPU stop running or not in HWCONFIG if this error occurs. If the setting is to have PLC CPU stops running once 16#0021 occurs, the PLC CPU will stop running and the ERROR LED will go blinking. If the setting is to have PLC CPU keep running, the error will be stated in the Error Log but ERROR LED will not go blinking.</p>							
0026	RTC cannot keep track of the current time (the battery LED is blinking.)	Continue					
0027	Battery low (the battery LED is ON.)	Continue					
0028	No response from RTC	Continue					V
002A	24VDC power supply is not sufficient and then is recovered from low-voltage for less than 10 ms.	Continue		V			
002D	The PLC maximum password attempts exceeded.	Continue					V
002E	The access to the external memory of the CPU is denied.	Stop			V		
002F	PLC programs are not consistent with the system logs.	Stop			V		
0040	The converted value in the function card 1 (AS-F2AD) or in the built-in AD input channel 1 exceeds the setting range.	Continue				V	
0041	The converted value in the function card 1 (AS-F2AD) or in the built-in AD input channel 2 exceeds the setting range.	Continue				V	
0042	The converted value in the input channel 1 of the function card 2 (AS-F2AD) exceeds the setting range.	Continue				V	
0043	The converted value in the input channel 2 of the function card 2 (AS-F2AD) exceeds the setting range.	Continue				V	
0044	Connection lost in the mode of current input 4 mA - 20 mA for the function card 1 (AS-F2AD) or for the built-in AD input channel 1.	Continue				V	
0045	Connection lost in the mode of current input 4 mA - 20 mA for the function card 1 (AS-F2AD) or for the built-in AD input channel 2.	Continue				V	
0046	Connection lost in the mode of current input 4 mA - 20 mA for the input channel 1 of the function card 2 (AS-F2AD).	Continue				V	
0047	Connection lost in the mode of current input 4 mA - 20 mA for the input channel 2 of the function card 2 (AS-F2AD).	Continue				V	

Error code	Description	CPU status	ERROR LED indicator				
			ON	Blinking fast	Blinking normally	Blinking slowly	OFF
0050	The memories in the latched special auxiliary relays are abnormal.	Continue					V
0051	The latched special data registers are abnormal.	Continue					V
0052	The memories in the latched auxiliary relays are abnormal.	Continue					V
0054	The latched counters are abnormal.	Continue					V
0055	The latched 32-bit counters are abnormal.	Continue					V
0056	The latched special auxiliary relay is abnormal.	Continue					V
0059	The latched data registers are abnormal.	Continue					V
005D	The CPU module does not detect a memory card.	Continue					V
005E	The memory card is initialized incorrectly.	Continue					V
0063	An error occurs when data is written to the memory card.	Continue					V
0064	A file in the memory card cannot be read.	Continue					V
0070	The actual placement of the function cards is not consistent with the settings.	Stop			V		
0102	The interrupt number exceeds the range.	Stop			V		
0202	The MC instruction exceeds the range.	Stop			V		
0302	The MCR instruction exceeds the range.	Stop			V		
0D03	The operands used in DHSCS are not used properly.	Stop			V		
0E05	The operands HCXXX used in DCNT are not used properly.	Stop			V		
1000 - 10FF	System error	Stop			V		
1300 - 130F	Errors occurred in the remote modules	Continue				V	
1402	The arrangement of the I/O modules is not consistent with the settings.	Stop			V		
140B	The number of connected communication modules exceed the maximum number 4.	Stop			V		
140C	The number of connected positioning modules exceed the maximum number 8.	Stop			V		
140D	The number of connected extension modules exceed the maximum number 32.	Stop			V		
140E	Number of remote modules exceeds the limit of eight on the right side of the CPU module.	Stop			V		
1500	Connection lost in the remote modules	Continue				V	
1502 - 150F	Errors occurred in the remote modules	Continue				V	

Error code	Description	CPU status	ERROR LED indicator				
			ON	Blinking fast	Blinking normally	Blinking slowly	OFF
1600	The ID of the extension module exceeds the range.	Stop			V		
1601	The ID of the extension module cannot be set.	Stop			V		
1602	The ID of the extension module is duplicated.	Stop			V		
1603	The extension module cannot be operated.	Stop			V		
1604	Extension module communication timeout	Stop			V		
1605	Hardware failure	Stop			V		
1606	Errors on the communication module function card	Stop			V		
1607	The external voltage is abnormal.	Stop			V		
1608	The Internal factory calibration or the CJC is abnormal.	Stop			V		
1609 - 160F	Reserved (Error codes for the extension modules)	Stop			V		
1800 - 180F	Errors occurred in the extension modules	Continue				V	
1900 - 191C	Heartbeat errors occurred in the slave in CANopen / ECAT communication. (Delta ASD-A2)	Continue				V	
1950	The initialization of the Delta ASD-A2 control has not yet been completed, the CANopen instructions cannot be executed.	Continue					V
19B0	Heartbeat timeout occurred in the slave mode	Continue					V
19B1	The data length of PDO (process data object) in the slave mode is not matched with the setting.	Continue					V
19E1	The data length of PDO (process data object) in the slave mode is not matched with the setting of the scan list. Refer to CANopen communication related descriptions in AS Series Operation Manual for more details on the error codes 19E1 to 19E8.	Continue					V
19E2	PDO in the slave mode is not received.	Continue					V
19E3	The function of auto downloading SDO fails at the first startup.	Continue					V
19E4	PDO configurations are set incorrectly.	Continue					V
19E5	The main settings are not consistent with the connected slave.	Continue					V
19E6	This slave does NOT exist in this network.	Continue					V

Error code	Description	CPU status	ERROR LED indicator				
			ON	Blinking fast	Blinking normally	Blinking slowly	OFF
19E7	Timeout on the slave error control	Continue					V
19E8	The node IDs of master and slave are duplicated.	Continue					V
19F3	Error in the configuration	Continue					V
19F4	CANopen communication is in the BUS-OFF state.	Continue					V
19FB	The sending registers exceed the range.	Continue					V
19FC	The receiving registers exceed the range.	Continue					V
2001	Not using the FCOMP card or not in the right mode for the ASDA-A2 while using the CANopen communication instruction.	Continue					V
2003	The device used in the program exceeds the device range or is illegal.	Continue					V
200A	Invalid instruction	Stop			V		
200B	The operand n or the other constant operands K/H exceed the range.	Continue					V
200C	The operands overlap.	Continue					V
200D	The binary to binary-coded decimal conversion is incorrect.	Continue					V
200E	The string does not end with 00.	Continue					V
2012	Incorrect division operation	Continue					V
2013	The value exceeds the range of values which can be represented by the floating-point numbers.	Continue					V
2014	The task designated by the TKON or YKOFF instruction is incorrect, or exceeds the range.	Continue					V
2017	The instruction BREAK is written outside of the FOR-NEXT loop.	Continue					V
2027	No such position planning table number or the format is incorrect.	Continue					V
2028	The high speed output instruction is being executed. Only one instruction can be executed at a time.	Continue					V
2030	During the execution of CSFO instruction, the output frequency exceeds the upper limit.	Continue					V
2031	During the execution of CSFO instruction, when the output frequency is set to 0, but even after 2 seconds, the output is still not complete.	Continue					V
6004	The IP address filter is set incorrectly.	Continue					V
600D	RJ45 port is not connected.	Continue					V
6010	The number of MODBUS TCP connections exceeds the range.	Continue			V		

Error code	Description	CPU status	ERROR LED indicator				
			ON	Blinking fast	Blinking normally	Blinking slowly	OFF
6011	The number of the EtherNet/IP connections exceeds the range.	Continue			V		
6012	There are devices using the same IP address.	Continue					V
6100	The email connection is busy.	Continue					V
6103	The trigger attachment mode in the email is set incorrectly.	Continue					V
6104	The attachment in the email does not exist.	Continue					V
6105	The attachment in the email is too big.	Continue					V
6106	There is an SMTP server response timeout.	Continue					V
6107	There is an SMTP server response timeout.	Continue					V
6108	SMTP verification failed	Continue					V
6200	The remote communication IP address set in the TCP socket function is illegal.	Continue					V
6201	The local communication port set in the TCP socket function is illegal.	Continue					V
6202	The remote communication port set in the TCP socket function is illegal.	Continue					V
6203	The device from which the data is sent in the TCP socket function is illegal.	Continue					V
6206	The device that receives the data in the TCP socket function is illegal.	Continue					V
6208	The data that is received through the TCP socket exceeds the device range.	Continue					V
6209	The remote communication IP address set in the UDP socket function is illegal.	Continue					V
620A	The local communication port set in the UDP socket function is illegal.	Continue					V
620C	The device from which the data is sent in the UDP socket function is illegal.	Continue					V
620F	The device that receives the data in the UDP socket function is illegal.	Continue					V
6210	The data that is received through the UDP socket exceeds the device range.	Continue					V
6212	There is no response from the remote device after the timeout period.	Continue					V
6213	The data received exceeds the limit.	Continue					V
6214	The remote device refuses the connection.	Continue					V
6215	The socket is not opened.	Continue					V
6217	The socket is opened.	Continue					V
6218	The data has been sent through the socket.	Continue					V
6219	The data has been received through the socket.	Continue					V
621A	The socket is closed.	Continue					V
7011	The device communication function code in COM1 is incorrect.	Continue					V

Error code	Description	CPU status	ERROR LED indicator				
			ON	Blinking fast	Blinking normally	Blinking slowly	OFF
7012	The device communication address used in COM1 is incorrect.	Continue					✓
7013	The device used in COM1 exceeds the device range.	Continue					✓
7014	The device length of the communication data in COM1 exceeds the limit.	Continue					✓
7017	The device checksum for the communication serial port of COM1 is incorrect.	Continue					✓
7021	The device communication function code in COM2 is incorrect.	Continue					✓
7022	The device communication address used in COM2 is incorrect.	Continue					✓
7023	The device used in COM2 exceeds the device range.	Continue					✓
7024	The device length of the communication data in COM2 exceeds the limit.	Continue					✓
7027	The device checksum for the communication serial port of COM2 is incorrect.	Continue					✓
7031	The device communication function code in Ethernet is incorrect.	Continue					✓
7032	The device communication address used in Ethernet is incorrect.	Continue					✓
7033	The device used in Ethernet exceeds the device range.	Continue					✓
7034	The device length of the communication data in Ethernet exceeds the limit.	Continue					✓
7037	The device checksum for the communication serial port of Ethernet is incorrect.	Continue					✓
7041	The device communication function code in USB is incorrect.	Continue					✓
7042	The device communication address used in USB is incorrect.	Continue					✓
7043	The device used in USB exceeds the device range.	Continue					✓
7044	The device length of the communication data in USB exceeds the limit.	Continue					✓
7047	The device checksum for the communication serial port of USB is incorrect.	Continue					✓
70B1	The device communication function code in function card 1 is incorrect.	Continue					✓
70B2	The device communication address used in function card 1 is incorrect.	Continue					✓
70B3	The device used in function card 1 exceeds the device range.	Continue					✓
70B4	The device length of the communication data in function card 1 exceeds the limit.	Continue					✓

Error code	Description	CPU status	ERROR LED indicator				
			ON	Blinking fast	Blinking normally	Blinking slowly	OFF
70B7	The device checksum for the communication serial port of function card 1 is incorrect.	Continue					V
70C1	The device communication function code in function card 2 is incorrect.	Continue					V
70C2	The device communication address used in function card 2 is incorrect.	Continue					V
70C3	The device used in function card 2 exceeds the device range.	Continue					V
70C4	The device length of the communication data in function card 2 exceeds the limit.	Continue					V
70C7	The device checksum for the communication serial port of function card 2 is incorrect.	Continue					V
7203	Invalid communication function code	Continue					V
8105	The contents of the downloaded program are incorrect. The program syntax is incorrect.	Continue					V
8106	The contents of the downloaded program are incorrect. The length of the execution code exceeds the limit.	Continue					V
8107	The contents of the downloaded program are incorrect. The length of the source code exceeds the limit.	Continue					V
8000 - 8FFF	Errors occur between software and PLC.	Continue					V
C000 - CFFF	The program syntax is incorrect.	Stop			V		

12.4.2 Error Codes and LED Indicators for Analog/Temperature Modules

Error code	Description	ERROR LED indicator status	
		A → D / D → A / A ↔D	ERROR
16#1605	Hardware failure	OFF	ON
16#1607	The external voltage is abnormal.	OFF	ON
16#1608	The factory calibration or the CJC is abnormal.	OFF	ON
16#1801*1	The external voltage is abnormal.	OFF	Blinking
16#1802*1	Hardware failure	OFF	Blinking
16#1804*1	The factory calibration is abnormal.	RUN: Blinking STOP: OFF	Blinking
16#1807*1	The CJC is abnormal.	OFF	Blinking
16#1808	The signal received by channel 1 exceeds the range of analog inputs (temperature).	RUN: Blinking STOP: OFF	Blinking
16#1809	The signal received by channel 2 exceeds the range of analog inputs (temperature).		
16#180A	The signal received by channel 3 exceeds the range of analog inputs (temperature).		
16#180B	The signal received by channel 4 exceeds the range of analog inputs (temperature).		
16#180C	The signal received by channel 5 exceeds the range of analog inputs (temperature).		
16#180D	The signal received by channel 6 exceeds the range of analog inputs (temperature).		
16#180E	The signal received by channel 7 exceeds the range of analog inputs (temperature).		
16#180F	The signal received by channel 8 exceeds the range of analog inputs (temperature).		
-	When power-on, the module is not detected by CPU module.	OFF	Blinking once or twice and after 2 seconds, it blinks repeatedly

*1: The errors are specified as warnings to ensure the CPU module can still run even when the warnings are triggered by its AIO modules. Set up HWCONFIG to have the following first 4 error codes appear as errors when they occur.

12.4.3 Error Codes and LED Indicators for Positioning Module AS02 / O4PU

Error code	Description	ERROR LED indicator status	
		A → D	ERROR
16#1802	Hardware failure	OFF	Blinking

12.4.4 Error Codes and LED Indicators for High Speed Counter Module AS02HC

Error code	Description	ERROR LED indicator status	
		ON	Blinking
16#1605	Counted result in the latched area is not retainable (major error)	√	
16#1606	Module settings in the latched area is not retainable. (major error)	√	
16#1607	Module setting error (major error)	√	
16#1800	Counter overflow / underflow on CH1		√
16#1801	Counter overflow / underflow on CH2		√
16#1802	Linear count exceeding the set upper/lower limit on CH1		√
16#1803	Linear count exceeding the set upper/lower limit on CH2		√
16#1804	The variation in relation to a SSI encoder position exceeding the limit on CH1		√
16#1805	The variation in relation to a SSI encoder position exceeding the limit on CH2		√
16#1806	Abnormal SSI communication on CH1		√
16#1807	Abnormal SSI communication on CH2		√
16#1808	SSI absolute position cross zero point on CH1		√
16#1809	SSI absolute position cross zero point on CH2		√

12.4.5 Error Codes and LED Indicators for Load Cell Module AS02LC

Error code	Description	ERROR LED indicator	
		A → D	ERROR
16#1605	Hardware failure (the diver board included)	OFF	ON
16#1607	The external voltage is abnormal.	OFF	ON
16#1801*1	The external voltage is abnormal.	OFF	Blinking
16#1802*1	Hardware failure	OFF	Blinking
16#1807*1	Diver board failure	OFF	Blinking
16#1808	The signal received by channel 1 exceeds the range of analog inputs or the SEN voltage is abnormal.	RUN: Blinking STOP: OFF	Blinking
16#1809	The signal received by channel 1 exceeds the weight limit.		
16#180A	The factory calibration in channel 1 is incorrect.		
16#180B	The signal received by channel 2 exceeds the range of analog inputs or the SEN voltage is abnormal.		
16#180C	The signal received by channel 2 exceeds the weight limit.		
16#180D	The factory calibration in channel 2 is incorrect.		

Error code	Description	ERROR LED indicator	
		A → D	ERROR
-	When power-on, the module is not detected by CPU module.	OFF	Blinking once or twice and after 2 seconds, it blinks repeatedly

*1: The following errors are specified as warnings to ensure the CPU module can still run even when the warnings are triggered by its AIO modules. You can set up HWCONFIG to have the following first 3 error codes appear as errors when they occur.

12.4.6 Error Codes and LED Indicators for Module AS04SIL IO-Link as a Communication Module

Error Code	Description	MS Status LED indicator	
		ON	Blinking
16#1605	Hardware failure		√
16#1606	24VDC power supply is not sufficient and then recovered from low-voltage for less than 10 ms.		√

Error Code	Description	NS LED indicator	
		ON	Blinking
16#1800	Error occurs in IO-Link Master		√
16#1801	Error occurs in IO-Link device		√
16#1802	No external power supply	√	
16#1803	Error in the download of IO-Link device mapping tables		√
16#1804	Failure to switch the process data parameter set		√
16#1805	A connection error occurs in IO-Link via communication port 1		√
16#1806	A connection error occurs in IO-Link via communication port 2		√
16#1807	A connection error occurs in IO-Link via communication port 3		√
16#1808	A connection error occurs in IO-Link via communication port 4		√
16#1809	Device scanning error and the scanning is forced to stop		√

12.4.7 Error Codes and LED Indicators for Module AS00SCM as a Communication Module

Error Code	Description	ERROR LED indicator status	
		ON	Blinking
16#1605	Hardware failure	√	
16#1606	The setting of the function card is incorrect.	√	
16#1802	Incorrect parameters		√
16#1803	Communication timeout		√
16#1804	The setting of the UD Link is incorrect.		√

12

12.4.8 Error Codes and LED Indicators for Module AS00SCM as a Remote Module

Error Code	Description	ERROR LED indicator status			
		ON	Blinking	Blinking slow	Blinking fast
16#1301	Hardware failure	√			
16#1302	The setting of the function card is incorrect.	√			
16#1303	24 VDC power supply is not sufficient and then is recovered from a low-voltage less than 10ms situation.				√
16#1304	More than eight remote modules on the right side of the CPU module.	√			
16#1500	Remote module communication timeout		√		
16#1502	Incorrect parameters		√		
16#1503	Extension module communication timeout		√		
16#1505	The actual placement of the extension modules is NOT the same as it is set.		√		
16#1506	Remote module had been stopped.			√	
16#1604	Extension module communication timeout		√		

12.4.9 Error Codes and LED Indicators for Module AS01DNET (Master/Slave Mode)

Code	Explanation	Correction
0~63	Node address of AS01DNET-A (in normal operation)	--
80	AS01DNET-A is in STOP status.	Turn the PLC to RUN and start I/O data exchange
F0	The node ID of AS01DNET is the same as that of other node or exceeds the allowed range.	1. Ensure that the node address of AS01DNET is unique. 2. Re-power AS01DNET.
F1	No configured slave in Scan List.	Configure the scan list and then download the configuration to AS01DNET.
F2	Too low voltage of the work power	Check if the power supply for AS01DNET and the PLC is normal.

Code	Explanation	Correction
F3	AS01DNET enters the test mode	Switch the function switch IN1 from On to Off and re-power AS01DNET-A.
F4	BUS-OFF	<ol style="list-style-type: none"> 1. Check if the network cable is normal and the shielded cable is grounded. 2. Check if the baud rates of all nodes in the network are same. 3. Check if the start and end of the network cable are both connected with a 121Ω terminal resistor. 4. Re-power AS01DNET-A.
F5	No network power	<ol style="list-style-type: none"> 1. Check if the network cable is normal. 2. Ensure that the network power is normal.
F6	Internal error; Flash or RAM check error	If the error still exists after re-power, send AS01DNET-A back for repair.
F8	Error produced in factory manufacturing	If the error still exists after re-power, send AS01DNET-A back for repair.
F9	Internal error; EEPROM access failure	If the error still exists after re-power, send AS01DNET-A back for repair.
FA	Invalid configuration data	<ol style="list-style-type: none"> 1. Configure the network correctly and re-download it to AS01DNET-A. 2. Check if the node address of one slave in the scan list is the same as that of AS01DNET-A.
E0	Identification parameters returned from the slave do not match the configuration data.	<ol style="list-style-type: none"> 1. Check if there is any change in node ID of the slave in the network. 2. Check if some node device in the network is replaced. 3. Re-configure the network.
E1	I/O Data size returned does not match that in the scan list.	Re-configure I/O data size of the slave, download the configuration to AS01DNET-A and run the PLC.
E2	<p>The slave device in the scan list does not exist or is offline when AS01DNET-A is in master mode.</p> <p>The I/O connection between the slave AS01DNET-A and the master is broken when AS01DNET-A is in slave mode.</p>	<ol style="list-style-type: none"> 1. Check if there is a change in the node address of the slave. 2. Check if the communication cable is disconnected or connected loosely. 3. Check if the bus cable length exceeds the maximum transmission distance. If so, the system may not be stable.
E3	AS01DNET-A fails to transmit data.	<ol style="list-style-type: none"> 1. Make sure that the connection between AS01DNET-A and the network is normal. 2. Check if the baud rate of AS01DNET-A is the same as that of other node in the network.
E4	Error detected in sequence of fragmented I/O data from the slave device.	Check if the slave is operating normally.
E5	The slave device returns error when AS01DNET-A attempts to communicate with it.	Check if the slave is operating normally.
E6	IO data size returned from the slave is bigger than that configured in Scan List.	Check that the IO data size of the slave should be the same as that configured in Scan List.
E7	AS01DNET-A is checking MAC ID.	If the code is displayed long, do the troubleshooting according to the following steps.

Code	Explanation	Correction
		<ol style="list-style-type: none"> 1. Make sure that at least two nodes work normally in the network. 2. Check if either end of the network is connected with the terminal resistor of 121Ω. 3. Check if the baud rates of the node devices in the network are same. 4. Check if the communication cable is normal so as to avoid that the cable is disconnected or connected loosely. 5. Check if the bus cable length exceeds the maximum transmission distance. If so, the system may not be stable. 6. Check if the shielded wire of the network cable is grounded. 7. Re-power AS01DNET-A scanner module.

12.4.10 Error Codes and LED Indicators for Module AS01DNET (RTU Mode)

Code	Indication	How to deal with
0~63	Node ID of the scanner module (When in RUN state)	No correction needed
F0	The node ID is repeated or exceeds allowed range.	<ol style="list-style-type: none"> 1. Ensure that the node ID of AS01DNET (RTU) is unique in the DeviceNet network within the range of 0~63. 2. Repower it on after changing the node ID.
F1	No I/O module is configured to AS01DNET (RTU) in the DeviceNet Builder software.	Add I/O modules in AS01DNET (RTU) in the DeviceNet Builder software and download the configuration data to AS01DNET (RTU) after the configuration is finished.
F2	The work voltage of AS01DNET (RTU) is too low.	Check if the power supply for AS01DNET (RTU) works normally.
F3	AS01DNET (RTU) enters the test mode.	Repower AS01DNET (RTU).
F4	AS01DNET (RTU) is the Bus-Off state.	<ol style="list-style-type: none"> 1. Check if the network communication cable is normal and the shielded cable is grounded. 2. Ensure the baud rates of all network nodes are same. 3. Check if the two ends of the network are both connected with a 120Ω terminal resistor. 4. Repower the scanner module.
F5	No network power supply for AS01DNET(RTU)	<ol style="list-style-type: none"> 1. Check if the network cable is normal. 2. Check if the network power supply is normal. (The external 24V DC network power supply is connected between red V+ and black V- of AS01DNET (RTU) .)
F6	Internal error; An error in the internal storage units of AS01DNET (RTU)	Return the product for repair if the error still exists after re-power on.
F7	Internal error; An error in the data exchange units of AS01DNET (RTU)	Return the product for repair if the error still exists after re-power on.
F8	Manufacture error	Return the product for repair if the error still exists after re-power on.

Code	Indication	How to deal with
F9	Internal error; An error in the access of the Flash of AS01DNET (RTU)	Return the product for repair if the error still exists after re-power on.
E4	Module error	Check if an error occurs in the modules connected to the right side of AS01DNET (RTU); Check if the module exists; Check if current module matches that configured in the software; Check if the unconfigured module is added.
E7	Repeated node ID detection	If the code has emerged for a long time, please shoot troubles in the methods below. 1. Ensure that there are at least two nodes working normally in the network. 2. Check if the two ends of the network are both connected with a 121Ω terminal resistor. 3. Ensure that the baud rates of all network nodes are same. 4. Check if the network cable has a problem such as being disconnected and loosened. 5. Check if the bus communication cable length exceeds maximum transmission distance. If the maximum transmission distance is exceeded, the stability of the system can not be ensured. 6. Check if the shielded wire of the network communication cable is grounded. 7. Turn on the power of AS01DNET (RTU) again.
E9	The number of I/O modules connected to AS01DNET (RTU) exceeds the maximum 8.	Check if the number of I/O modules connected to AS01DNET (RTU) is more than 8.
80	AS01DNET (RTU) is in STOP state.	1. Check if the RUN/STOP switch of the PLC connected to the DeviceNet master is turned to RUN. 2. Check if the value of control word of AS01DNET (RTU) is 1. For details, refer to section 11.5.4.3.4.
83	The AS01DNET (RTU) configuration in the software is being downloading.	Wait until the download of AS01DNET (RTU) configuration data is completed.

Chapter 13 Data Tracer and Data Logger

Table of Contents

13.1 Data Tracer	13-2
13.1.1 About Data Tracer.....	13-2
13.1.2 Example	13-4
13.2 Data Logger	13-5
13.2.1 About Data Logger.....	13-5
13.2.2 Related SM Flags and SR Registers.....	13-7
13.3 Delta Drive Parameters Backup and Restore	13-8
13.3.1 System Requirement	13-8
13.3.2 The Architecture Overview for Backup and Restore	13-8
13.3.3 Steps to Backup Delta Device Parameters	13-9
13.3.4 Steps to Restore Delta Device Parameters	13-12
13.3.5 FAQ	13-17

13.1 Data Tracer

This section uses ISPSOft for demonstration. For DIADesigner operation, refer to section 14.4.1 from DIADesigner software manual.

13.1.1 About Data Tracer

Data Tracer is used for the real-time collection of variable symbols, values, states in devices, after some trigger condition is met so as to draw curve charts for analysis of value trends. Refer to Section 22.2 in ISPSOft User Manual for more details.

Operation 1

- Compile the current project before using the function. Click Wizard> Data Tracer to open the Data Tracer window as shown below.

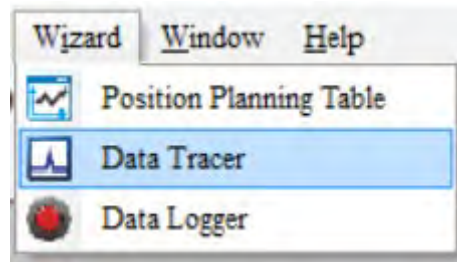

- Click the button  of **Symbol Name** to open the **Add Sample Source** window.

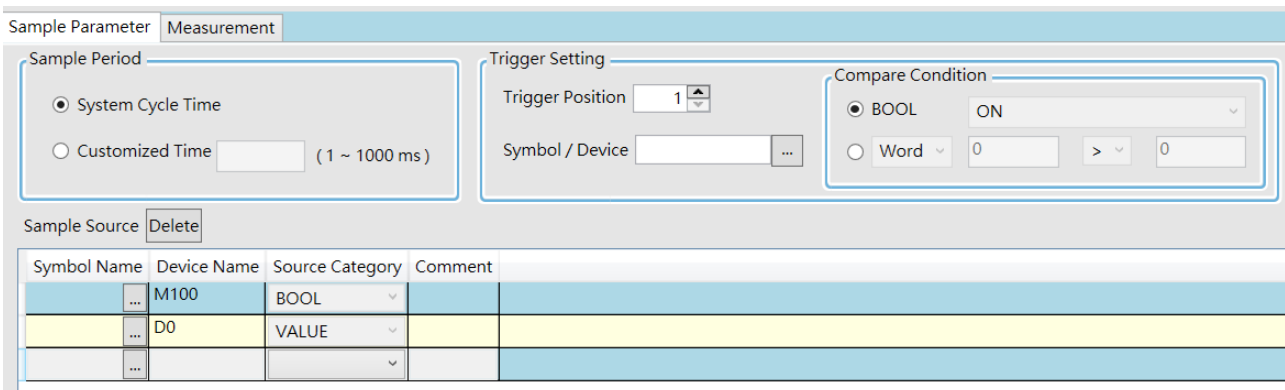

- Click the button  of **Symbol Name** in the **Add Sample Source** window and select the variable symbol name to be added in the **Choose Symbol** window or directly type a device name in the **Device Name** box.

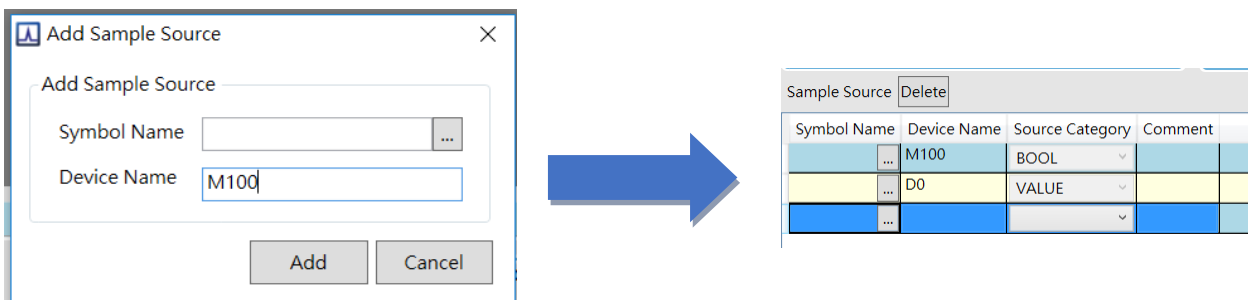

- Set up the sample period and trigger setting.

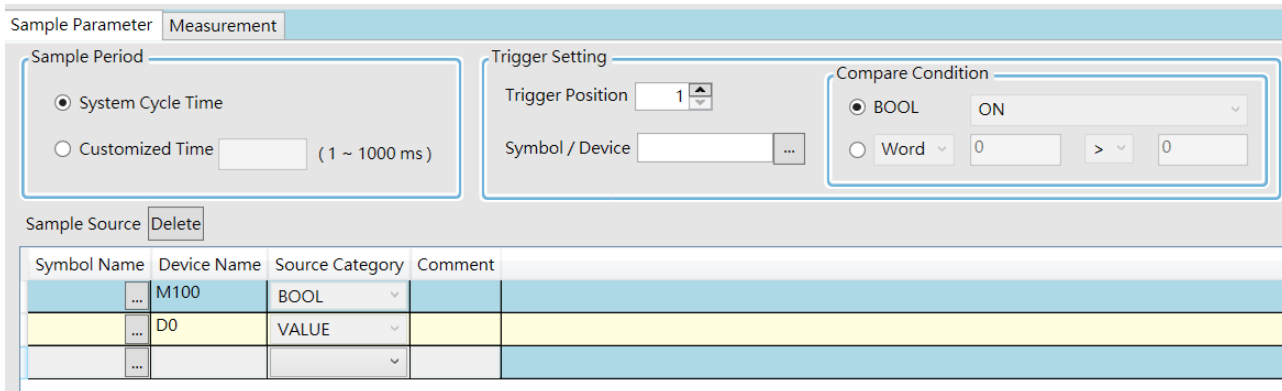

- After setting up the parameters, click on the icon toolbar to have the system in the online mode. Then click to download the settings to the PLC.

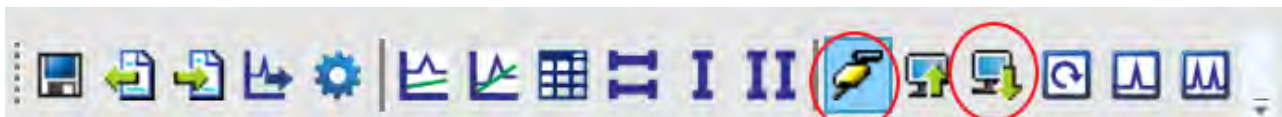

- After the sample parameter settings in the data tracer are completed and downloaded, any of the following three modes on the icon toolbar can be used for watching curves in the online mode.

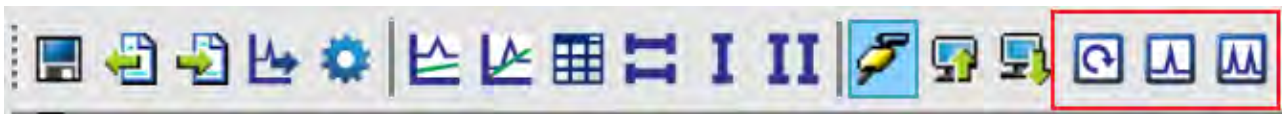

- Click on the icon toolbar to export the data to your computer for future use.

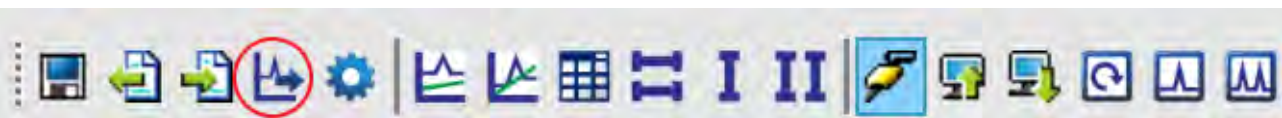

13.1.2 Example

If X0.0 is a signal to open/close externally. Use Data Trace to measure the width of time when X0.0 is ON.

- **Steps:**

① Open Data Tracer and enter X0.0 for monitoring.

② Set the Customized Time to 100 ms to take sampling, set the trigger device to X0.0, set the trigger position to 10, and then set the compare condition to ON as the image shown below.

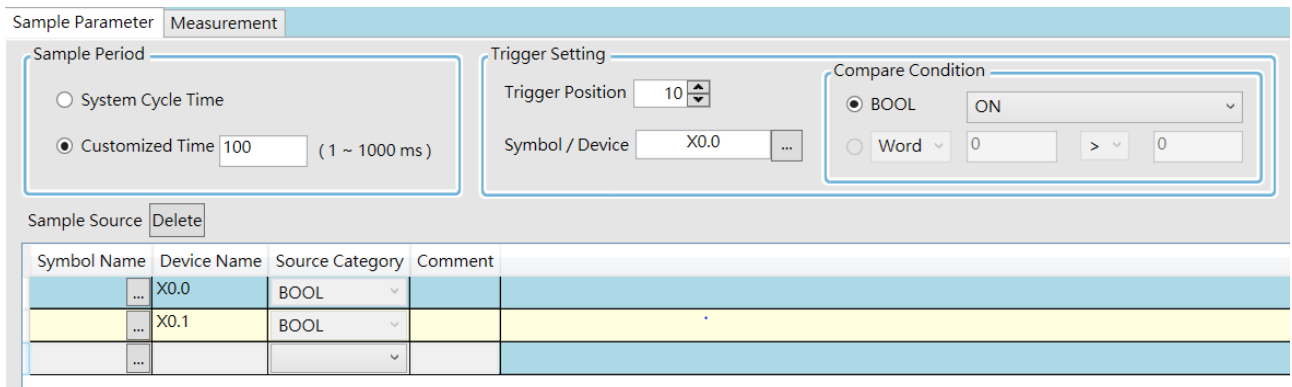

③ Set the mode to One-shot trigger and wait for the trigger (ON). Once it is triggered, it displays the recorded curve data.

④ The value in ΔX is 2500 ms, the time measured between two vertical lines, X1 and X2, for X0.0.

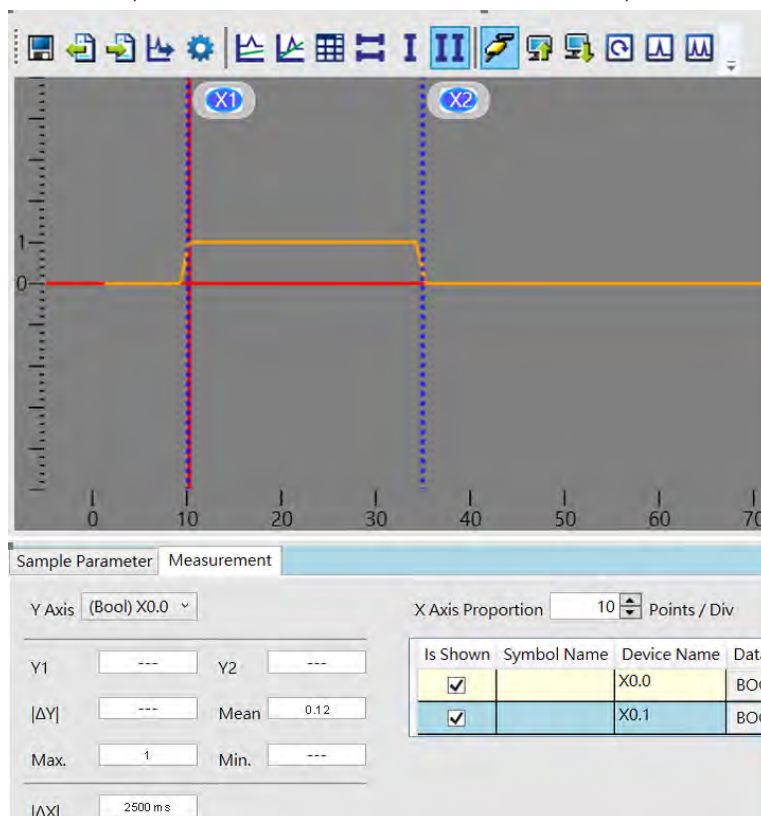

13.2 Data Logger

This section uses ISPSOft for demonstration. For DIADesigner operation, refer to section 14.4.2 from DIADesigner software manual.

13.2.1 About Data Logger

Data logger is used for the long-term recording of variable symbols, values, states in devices, and drawing curve charts. The data is stored in the PLC and the memory card of the PLC for analysis of value trends. Refer to Section 22.3 in ISPSOft User Manual for more details.

Operation A

- Compile the current project before using the function. Click Wizard> Data Logger to open the Data Logger window as shown below.

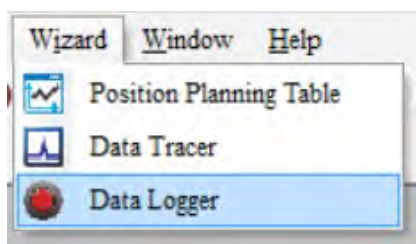

- Click the button  of **Symbol Name** to open the **Add Sample Source** window.

Sample Parameter Measurement

Parameters

Sample Points (1 ~ 16384 pts)

Sampling Method

Periodical Sampling (1 ~ 65535 sec)

Triggered Sampling (M0 ~ M8191)

Action When Sample Points Reach

Stop Recording

Continue Recording (Replace the old data)

Sample Source

Symbol Name	Device Name	Source Category	Comment
<input type="button" value="..."/>	M0	BOOL	
<input type="button" value="..."/>	D0	VALUE	
<input type="button" value="..."/>			

- Click the button  of **Symbol Name** in the **Add Sample Source** window and select the variable symbol name to be added in the **Choose Symbol** window or directly type a device name in the **Device Name** box.

Add Sample Source

Add Sample Source



Symbol Name

Device Name



Sample Source

Symbol Name	Device Name	Source Category	Comment
<input type="button" value="..."/>	M0	BOOL	
<input type="button" value="..."/>	D0	VALUE	
<input type="button" value="..."/>			

- After setting up the parameters, click  on the icon toolbar to have the system in the online mode. Then click  to download the settings to the PLC. And then click  to record data.

Note: From here you can also follow Operation B to complete the recording and saving.

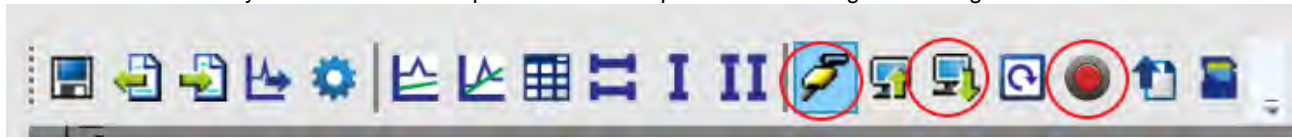

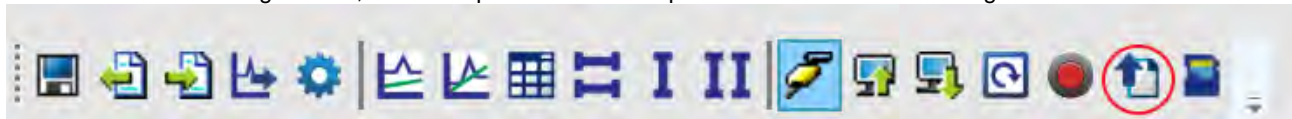

- When the recording is done, click the upload button to update the data for later viewing.

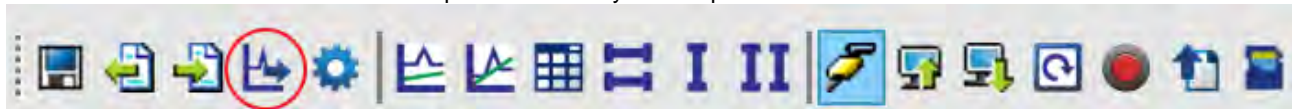

13

- Click  on the icon toolbar to export the data to your computer for future use.



- Click  on the icon toolbar or use SM and SR to save the data to the SD Card installed on the PLC.

Operation B

You can also use SM flags or SR registers to complete the data recording, data saving or set to store data on a SD card permanently. See the example below for reference.

Example:

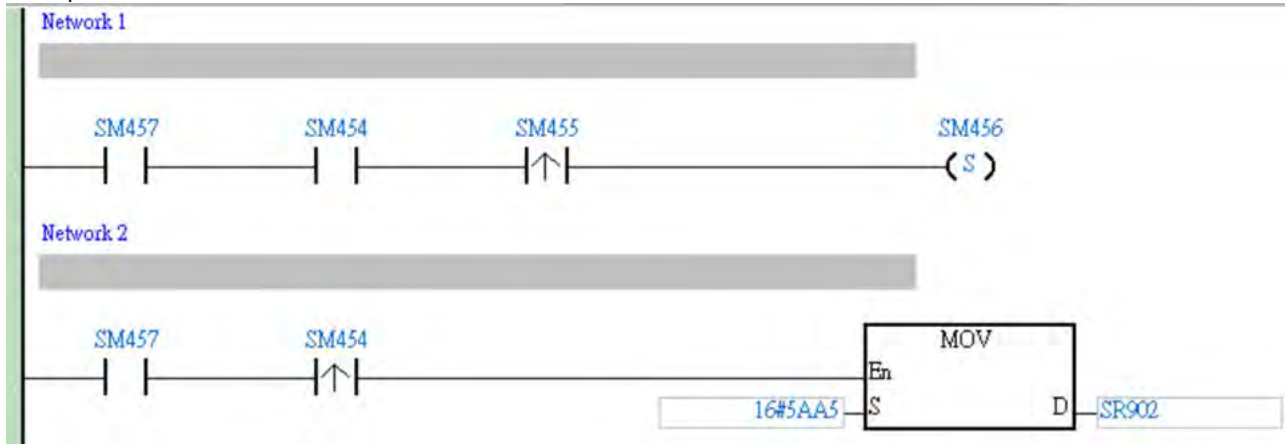

- Check if the flag SM457 is ON. If the flag SM457 is ON, it indicates the valid recorded parameters are downloaded in data logger. And that means the operation A is done correctly.
- Use inputs to enable/disable or set the flag SM454 to ON for the PLC to start recording. If you need to store data on a SD card, set SR902=16#5AA5.
- When SM455 is ON or when the quantity of data has met the value set in SR900 (32-bit value), the system start saving data on a SD card.
NOTE: While sending data to the SD card for storage, the PLC needs a period of undisturbing time, approximately tens of milliseconds. During this period, the PLC is not allowed to execute interrupts. Make sure the PLC is NOT executing any interrupts, especially the external input ones before starting to send data to the SD card for storage.

- When SM455 is switching from OFF to ON, set SM456 ON. And the PLC starts to store the recorded data on the SD card. The default path and the file name are as shown below:
 - ◆ Default saving path
 - AS100: \SDCard\PLC CARD\AS100\Log
 - AS200: \SDCard\PLC CARD\AS200\Log
 - AS300: \SDCard\PLC CARD\AS300\Log
 - ◆ Default file name
 - DATA_LOGGER_yyymmdd_hhmmss.log
 - EX: DATA_LOGGER_20181108_161901.log

13.2.2 Related SM Flags and SR Registers

SM / SR	Attr.	Description
SM450	R	Check here to see if a SD Card is installed in the PLC. ON: SD card inside OFF: No SD card
SM452	R	Check here to see if data is being stored on the SD card. ON: In the operation of storing OFF: Not in the operation of storing
SM453	R	Check here to see if there is any SD card operational error. ON: Abnormal OFF: Normal
SR453	R	Check here to see the last operational error code of the SD card. Note: Only available when SM453=ON
SM454	R/W	Set this flag to ON/OFF to start or stop recording. The system will not set this flag to OFF automatically even if the space for recording is full. You need to set the flag to OFF manually.
SM455	R	Check here to see if the recorded number has reached the set limit. ON: The quantity of recordings has reached the set number or the SD card is in cycle recording.
SM456	R/W	Used with SR902 to activate the settings in SR902 for the SD card. Note: Set the flag from OFF to ON and the PLC starts to store the recorded data on the SD card when SR902=16#5AA5.
SM457	R	Check here to see if there is any valid, downloaded, recorded parameters in the data logger. ON: The valid recorded parameters are downloaded in data logger.
SR900	R	Check here to see the quantity of the recorded data (32-bit value). Note: It increments the number of the recorded data by 1 for each record.
SR902	R/W	Control codes for recorded data. <ul style="list-style-type: none"> ● 16#5AA5: Store data to a default root and specified file name on the SD card. ● 0: The storing is done. ● Others: Invalid numbers Note: Used with SM456 to activate this setting.

Note: "R" in the column of attribute (Attr.) indicates the item is read only and the status can be read here.

"W" in the column of attribute (Attr.) indicates you can set, delete or write a value for this item.

13.3 Delta Drive Parameters Backup and Restore

This section uses ISPSOft for demonstration. For DIADesigner operation, refer to section 16.8 from DIADesigner software manual.

Delta device parameters can be backed up and restored. This function allows you to backup and restore the device parameters, including parameters of inverters and servo drives that are connected to the PLC CPU. You can backup the device parameters for later use. If a device is not functioning, you can change to a new one and use the backup the parameters to set up the new device quickly. Here we use AS Series PLC CPU as an example to backup and restore Delta device parameters. Refer to EIP Builder User Manual for detailed information on operation of other series.

13.3.1 System Requirement

Software: ISPSOft V3.10 or later, EIP Builder V1.07 or later

PLC CPU: AS Series PLC firmware V1.08 or later

Drive: C2000 Series inverter firmware V2.06 or later

EIP Communication Card: CMC-EIP01 firmware V1.08 or later

13.3.2 The Architecture Overview for Backup and Restore

Through EIP Builder, you can backup device parameters and store them in the SD card that is installed in AS Series PLC CPU. For restoration, you can use HMI to manage the SR from AS PLC CPU to restore the drive parameters to the Delta drive that is connected to the AS Series PLC CPU.

For AS300 Series PLC CPU, you can delay back up and restoration for up to 16 Delta drives at the same time.

For AS100 and AS200 Series PLC CPU, you can utilize back up and restoration for up to 8 Delta drives at the same time.

Find the architecture overview for back up and restoration below. Refer to Chapter 9 for details on the EtherNet/IP operation.

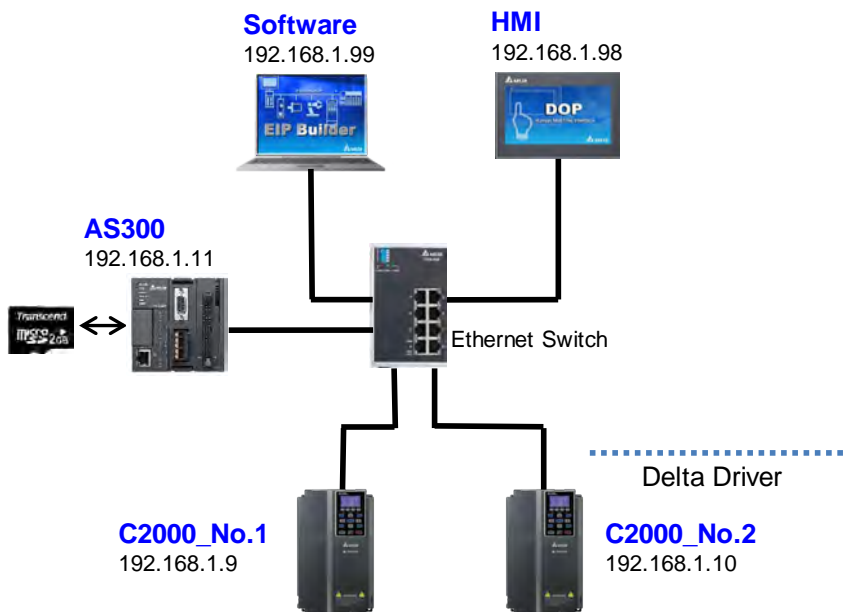

13.3.3 Steps to Backup Delta Device Parameters

Step 1: Open EIP Builder and make sure AS Series PLC CPU is well-connected and ready to communicate. And then make sure AS Series PLC CPU is also connected to the Delta drives and they are also ready to communicate.

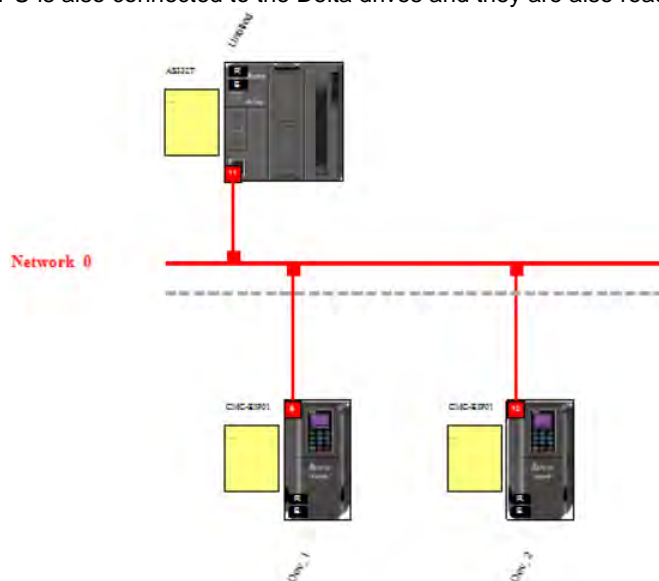

Step 2: Make sure a SD Card is installed in the AS Series PLC CPU and the AS Series PLC CPU is at the state of STOP.

Step 3: Click the **Uploader icon**  on the tool bar for backup.



Step 4: Select the parameters that you need to store for backup and click **Start**.

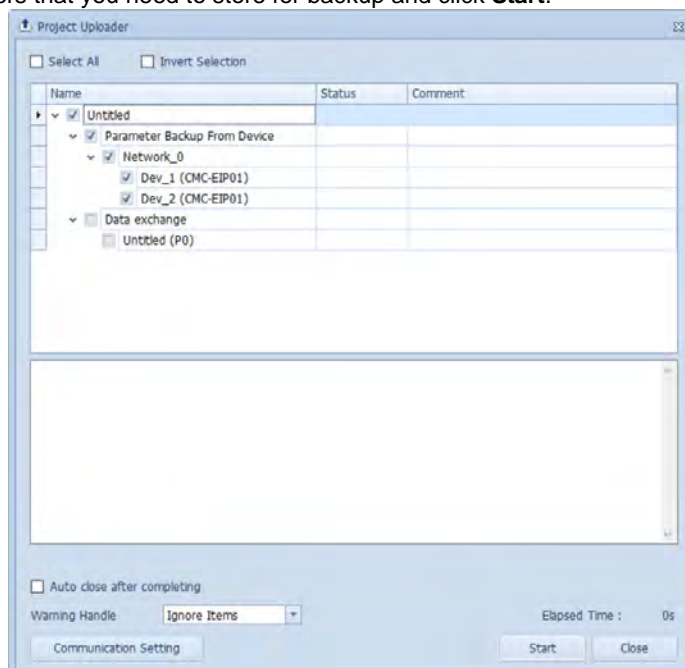

Step 5: Once all the selected parameters are uploaded to the computer, you can see the information “All done”.

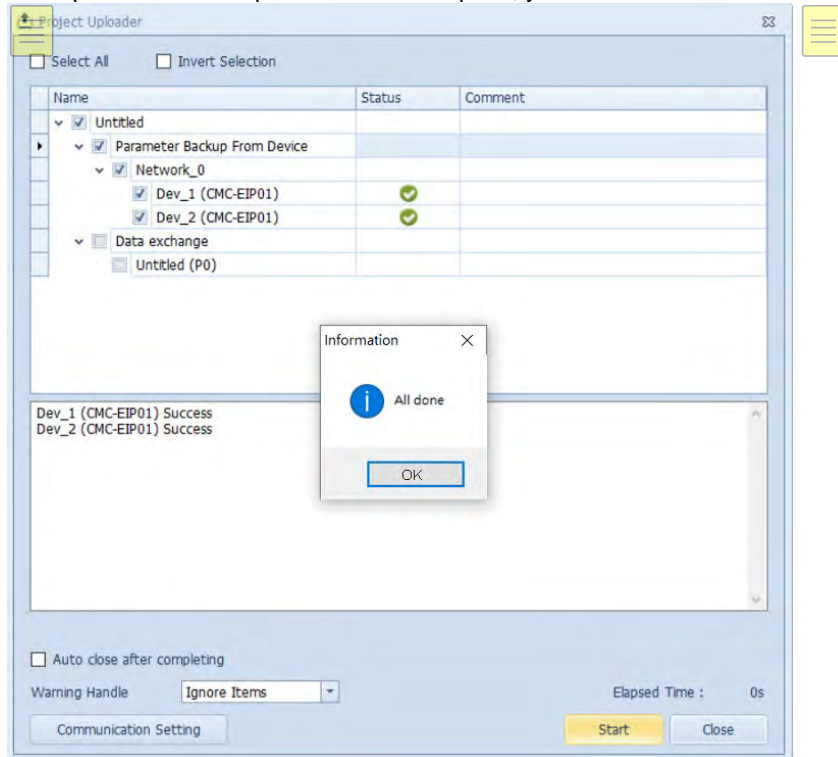

13

Step 6: Click the **Downloader icon**  on the tool bar to download the backup file from the computer to the SD card of AS Series PLC CPU.

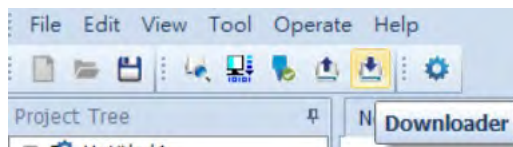

Step 7: Select the parameters that you need to download and click **Start**.

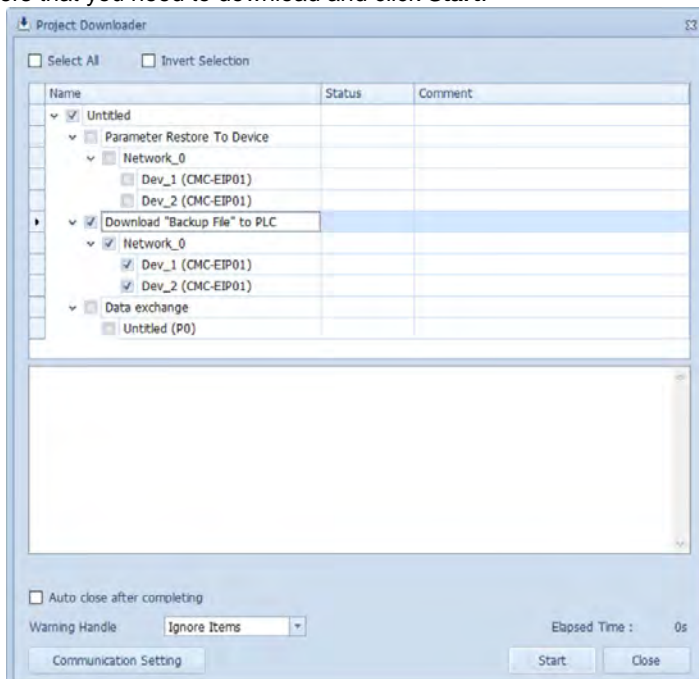

Step 8: Once all the selected parameters are downloaded to the SD card of the AS Series PLC CPU, you can see the information "All done".

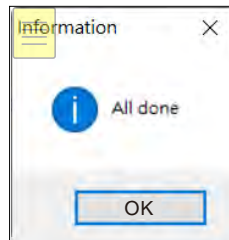

Step 9: Use your computer to check if the backup file is saved in the SD card.

Remarks:

- **Default backup file path**

AS100: \SDCard\PLC CARD\AS200\DevPara

AS200: \SDCard\PLC CARD\AS200\DevPara

AS300: \SDCard\PLC CARD\AS300\DevPara

- **File naming: mmmm_nn_tt_pppppppppppppppp.par**

mmm: device or module code (e.g. PLC CPU is 0000.)

nn: communication port number (e.g. PLC Ethernet communication port is 03.)

tt: communication protocol type (e.g. Ethernet communication is fixed to 01.)

pppppppppppppppp: device information (IP + ID + 000000 in the hexadecimal format)

For example: If the device IP is 192.168.1.9 and its ID is 9, the device information is C0A80109

(IP: 192 = 16#C0, 168=16#A8, 1=16#01, 9=16#09) + 09 (ID) + 000000 = C0A8010909000000.par

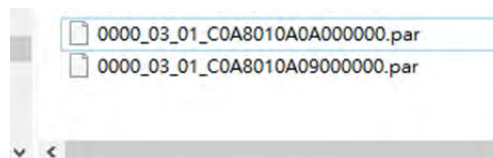

Step 10: You can use ISPSOft to set the Delta drive's number in SR1601 and SR1602 for easier operation when it is required to use the restoration function on site.

13.3.4 Steps to Restore Delta Device Parameters

Two ways you can use to restore the Delta device parameters. One is to use ISPSoft to perform the restoration and the other way is to send commands (SM/SR) to the SD card of the AS Series PLC CPU through HMI. Refer to section 3.1.4.16 Delta Device Parameters Backup and Restore from ISPSoft User Manual for more information. Here we focus on the operation of sending commands (SM/SR) to the SD card of the AS Series PLC CPU through HMI.

Use SM/SR devices to appoint which Delta drive should be restored. Refer to the table below. After you have set the configurations, the PLC executes the restorations when the PLC is Power-On or from Stop to Run.

SM / SR	Function	Description	Retainable
SR1600	Parameter restoration code	0: No action (default) 1: The AS Series PLC CPU executes the restoration when the PLC is Power-On or from Stop to Run. When the restoration is complete, reset the value to 0.	Yes
SR1601.0 ~ SR1601.15 and SR1602.0 ~ SR1602.15	Target device number to perform parameter restoration	SR1601.0: corresponding to target device #1 SR1601.1: corresponding to target device #2 : SR1601.15: corresponding to target device #16 OFF: No action (default) ON: Execute restoration on the appointed target device.	Yes
SR1603	The total number of Delta drives that error has occurred during restoration	0: No error occurred 1~16: The total number of Delta drives that error has occurred during restoration	No
SR1604	The last digit of the device's IP address that a most recent error occurred during restoration	0 ~ 255: The last digit of the device's IP address that a most recent error occurred during restoration. (Only valid when SM1161 is switched to ON. Find SM1161 description below.)	No
SR1605	The error code of the last device that error occurred	Refer to the error code table below.	No
SM1160	Parameter restoration complete	OFF: When the value in SR1600 changes from 1 to 0, reset SM1160 to OFF. ON: When the restoration is complete and successful, SM1160 switches to ON.	No
SM1161	Error occurred during parameter restoration	OFF: When the value in SR1600 changes from 1 to 0, reset SM1160 to OFF. ON: If any error occurred during restoration, SM1161 switches to ON.	No

In HWCONFIG, you can set up the handling method: what to do if an error occurs while restoring.

- **Execution delay time when power on:**

You can set up how long should the PLC CPU wait before the restoration begins. The default is 3 seconds. It means after power on, and after the PLC CPU detects its modules, it will wait for 3 seconds before executing restoration. But if the value in SR1600 is 0, the action here will be ignored.

Delta Device Parameter Restore Setting						
	Name	Setting Value	Unit	Default	Minimum	Maximum
⌘	Execution delay time when power on	3	1sec	3	0	180

- **When error occurs, CPU module:**

You can set up if an error occurs during restoration, the PLC CPU stops or keeps running (default). If an error occurs during restoration, the PLC CPU will show warning error LED and stores the error message "H'0021". Refer to the error code table below.

Delta Device Parameter Restore Setting						
	Name	Setting Value	Unit	Default	Minimum	Maximum
⌘	Execution delay time when power on	3	1sec	3	0	180
	When error occurs, CPU module	Keeps Running		Keeps Running	-	-

- **Delta Device Parameter Restore Setting:**

For the connected Delta devices, you can set up more configurations for security, including IP address, ID Number, Password Protection, and Compatible Check.

Note: Delta devices will also check for the compatibility, even if you have selected the option "Ignore Checks if Possible" here.

General Data Exchange						
		Device 1				
	Name	Setting Value	Unit	Default	Minimum	Maximum
	IP Address	192.168.1.73		192.168.1.1	1.1.1.1	223.255.255.255
	ID No.	1		1	1	247
	Password (Max Length: 8)				-	-
	Compatible Check	Partial Compatible		Partial Compatible	-	-

Example: Back up parameter from Delta drives, number 1, 3, 6 and 16 and execute restorations.

Backup

Step 1: Select the devices that you need to backup in EIP Builder. Here we select device 1, 3, 6 and 16.

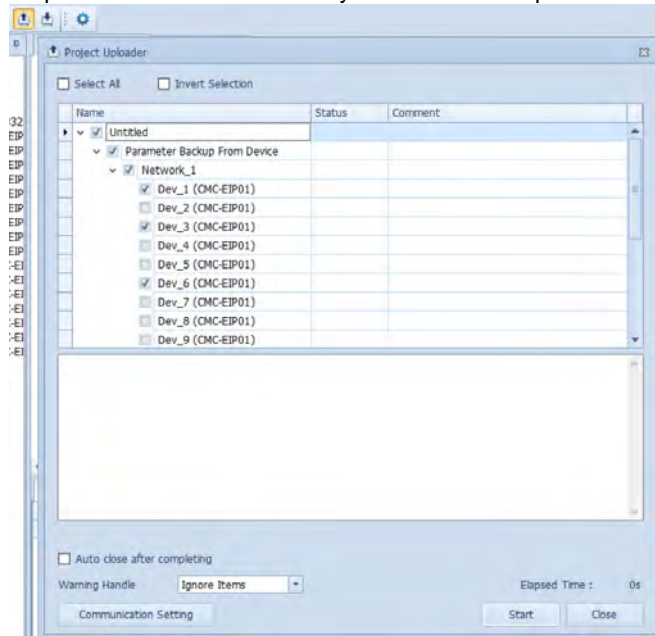

13

Step 2: Download the backup file from the computer to the SD card of AS Series PLC CPU.

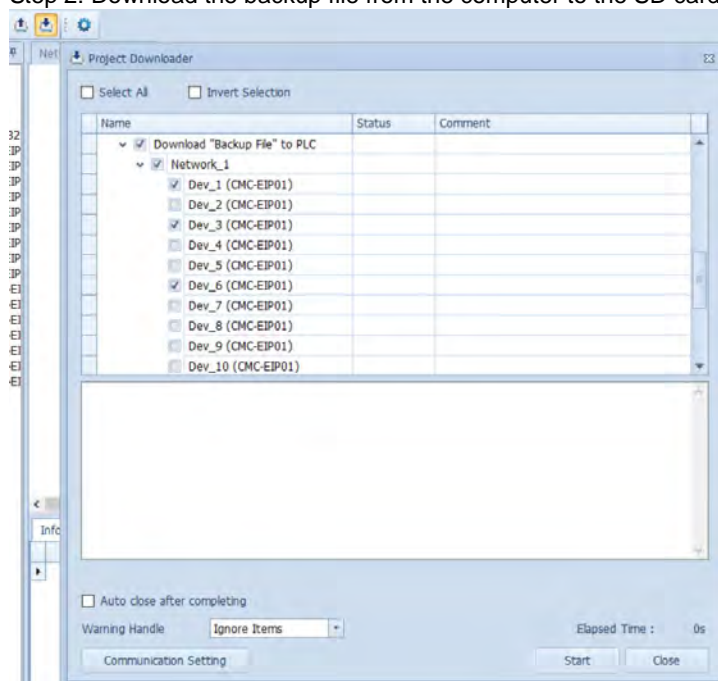

Step 3: Make sure you have the backup file ready and the IP addresses and Slave IDs in the backup file of the SD card are identical to the ones that need to be restored.

SD Card:

File naming: mmmm_nn_tt_pppppppppppppppppppp.par

mmmm: device or module code (e.g. PLC CPU is 0000.)

nn: communication port number (e.g. PLC Ethernet communication port is 03.)

tt: communication protocol type (e.g. Ethernet communication is fixed to 01.)

pppppppppppppppppppp: device information (IP + ID + 000000 in the hexadecimal format)

For example: If the device IP is 192.168.1.101 and its ID is 01, the device information is C0A80165

(IP: 192 = 16#C0, 168=16#A8, 1=16#01, 101=16#65) + 01 (ID) + 000000 = C0A8016501000000.par

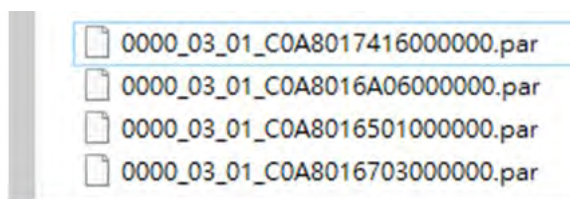

Step 4: You can use ISPSOft to set the Delta drive's number in SR1601 and SR1602 for easier operation when it is required to use the restoration function on site.

Restoration

Step 1: Check and make sure you have set the IP addresses, Slave IDs, and passwords of the Delta drives to be restored.

Step 2: Use the HMI, e.g., Delta DOP series HMI to set up SR1601=16#8025 (SR1601.0, SR1601.2, SR1601.5, SR1601.15; these 4 bits set to ON and others set to OFF.)

Note: You can use ISPSOft to set the Delta drive's number in SR1601 and SR1602 beforehand, it would be easier for personnel to execute restoration on site.

Step 3: Make sure a SD Card is installed in the AS Series PLC CPU and the AS Series PLC CPU is at the state of STOP.

Step 4: Use HMI to set SR1601 to 1. Switch PLC CPU from STOP to RUN.

Step 5: Check if the value in SM1160 of the PLC CPU. If it is ON, it indicates the restoration is complete. If it is not ON, go check if the value in SM1161 is ON. If it is ON, it indicates an error has occurred during restoration.

Troubleshooting

- When SM1161 is ON and the value in SR1603 is not 0.
- Read the value in SR1604 to find the last digit of the device's IP address that a most recent error occurred during restoration to find out which device is not functioning.
- Read the value in SR1605 or use the PRST_ErrRead to read the error code. See the table below for troubleshooting.

Type	Error Code in SR1605	Error Message	Solution
PLC setting and operation error	H'0001	CPU module can NOT detect SD card	Make sure SD card is installed securely. Unplug it and plug it in again.
	H'0002	No backup file in SD card.	Make sure there is a backup file in SD card.
	H'0003	Error occurred while reading data from SD card. For instance, failed to read or the file is corrupted.	Check if SD card is damaged.
	H'0004	Failed to write data into SD card.	Check if SD card is written proof or if it is damaged.
	H'0008	Restoration setting error (For example, the IP address to be restored is set as a broadcasting one. For restoration, the IP address should be one on one, not broadcasting.	Check if the naming of IP address and ID is the same as what is set in HWCONFIG.
	H'000A	Connection lost	Check if the network cable is well-connected and the wiring is correct.
Backup and restoration error	H'1000	Not supported parameter settings	Check if the Delta drive's firmware version in the backup file is matched with the one to be restored.
	H'1001	Device series not matched	Check if the Delta drive's series in the backup file is matched with the one to be restored.
	H'1002	Device version not matched	Check if the Delta drive's firmware version in the backup file is matched with the one to be restored.
	H'1003	Incompatible device voltage level	Check if the Delta drive's voltage level in the backup file is matched with the one to be restored.
	H'1004	Incompatible device power	Check if the Delta drive's power in the backup file is matched with the one to be restored.
	H'1010	Device model not matched	Check if the Delta drive's model in the backup file is matched with the one to be restored.
	H'1011	Incorrect device password	Check if the Delta drive's password is the same as what is set in HWCONFIG.
	H'1100	Device communication timeout	Check if the network cable is well-connected and free from noise interference.
	H'1101	Currently the device can NOT execute backup or restoration.	If the problem persists, contact the local authorized distributors of the Delta drive.
	H'1103	Currently the device can NOT compete the execution of backup or restoration.	If the problem persists, contact the local authorized distributors of the Delta drive.
H'1106	Device responds with incomplete data	If the problem persists, contact the	

Type	Error Code in SR1605	Error Message	Solution
		for backup/restoration	local authorized distributors of the Delta drive.
	H'1108	Device responds with an unexpected error.	Check if the network cable is well-connected and free from noise interference.
Restoration error	H'2000	Parameters exceed the upper limit.	If the problem persists, contact the local authorized distributors of the Delta drive.
	H'2001	Parameters are less than the lower limit.	If the problem persists, contact the local authorized distributors of the Delta drive.
	H'2002	Parameters can NOT be written.	If the problem persists, contact the local authorized distributors of the Delta drive.
	H'2003	Currently the device is at the state of RUN.	Switch the device to the state of STOP.
	H'2004	Currently the device is at the state of error.	Refer to the drive user manual for more information.
	H'2005	Incorrect device file	If the problem persists, contact the local authorized distributors of the Delta drive.
	H'2006	Number of device parameters not matched.	If the problem persists, contact the local authorized distributors of the Delta drive.
	H'2007	Execution of backup or restoration timeout	If the problem persists, contact the local authorized distributors of the Delta drive.

13.3.5 FAQ

Question 1: Is Ethernet/IP the only communication protocol for backup and restoration?

Answer: Yes, currently Ethernet/IP is the only communication protocol supported. RS485 communication will also be available in the near future.

Question 2: Are the file name and the folder path editable?

Answer: The file name of the backup file contains 4 sections, PLC Ethernet communication port, Ethernet communication protocol, and device information. Only the device information can be edited according to the device to be restored. See below for more details on the file naming.

File naming: mmmm_nn_tt_pppppppppppppppppppp.par

nn: communication port number (e.g. PLC Ethernet communication port is 03.)

tt: communication protocol type (e.g. Ethernet communication is fixed to 01.)

pppppppppppppppppppp: device information (IP + ID + 000000 in the hexadecimal format)

For example: If the device IP is 192.168.1.101 and its ID is 01, the device information is C0A80165

(IP: 192 = 16#C0, 168=16#A8, 1=16#01, 101=16#65) + 01 (ID) + 000000 = C0A8016501000000.par

Question 3: Can backup and restoration be executed when PLC CPU is at the state of RUN?

Answer: No. Backup and restoration can only be executed when PLC CPU is at the state of STOP. Since AS Series PLC CPU reads data from or writes data into the SD card, it affects the PLC scan time and may further affect the PLC operation.

MEMO

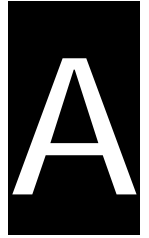

Appendix A Installing a USB Driver

Table of Contents

A.1 Installing the USB Driver for an AS Series CPU module in Windows XP with SP3	A-2
A.2 Installing the USB Driver for an AS Series CPU module in Windows 7	A-6
A.3 Installing the USB Driver for an AS Series CPU module in Windows 8	A-11
A.4 Installing the USB Driver for an AS Series CPU module in Windows 10	A-13
A.5 Notes on Utilizing USB Communication	A-16

A.1 Installing the USB Driver for an AS Series CPU module in Windows XP with SP3

The instructions below show how to install the USB driver for an AS Series CPU module on Windows XP. To install the USB driver on another operating system, refer to the instructions in the operating system for information on installing new hardware.

Before you install the USB driver, you must install ISPSOft version 3.00 or above on your computer.

- (1) Supply power to the AS Series CPU module. Connect the AS Series CPU module to a USB port on your computer with a USB cable. In the **Found New Hardware Wizard**, select **No, not this time** and then click **Next**.



- (2) The wizard displays the name of the detected USB device. Select **Install from a list or specific location (Advanced)** and then click **Next**.

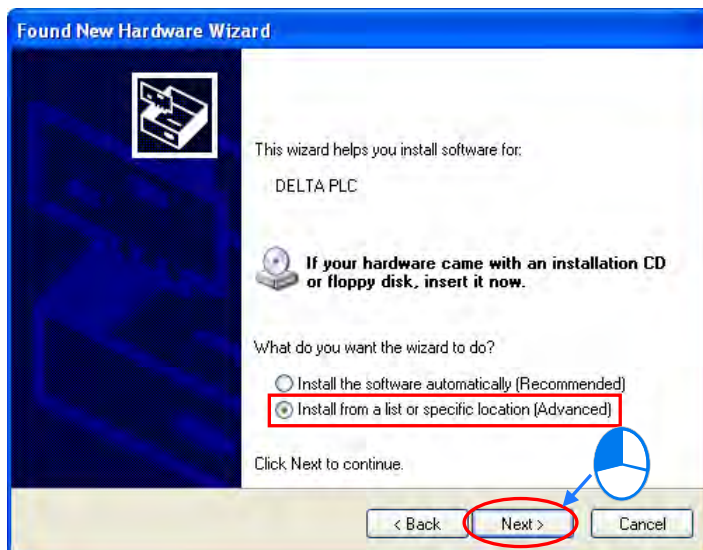

- (3) After you install ISPSOft version 3.00 or above, the driver for the AS CPU module is under the folder where you installed ISPSOft: **...ISPSOft\drivers\Delta_PLC_USB_Driver**.

Select **Include this location in the search** and enter the correct path, or click **Browse** to browse for the correct folder. Click **Next** to continue the installation.

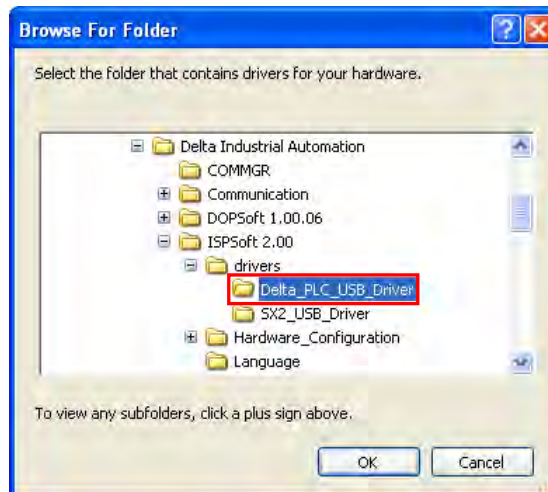
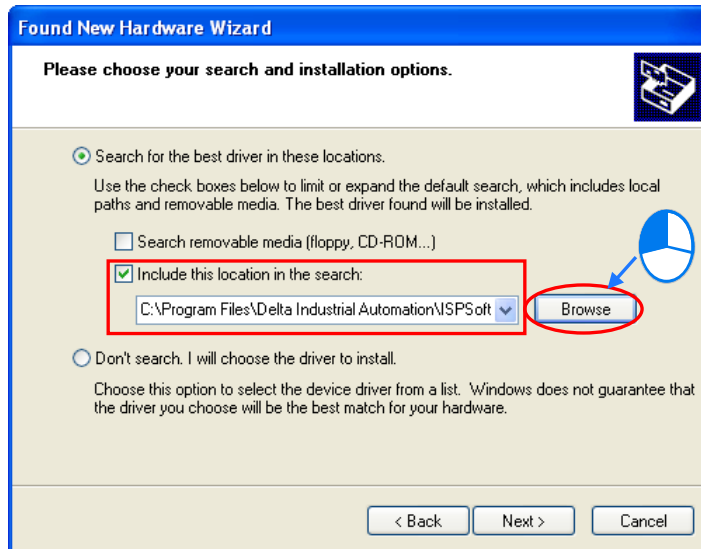

- (4) The system installs the driver. If the **Hardware Installation** message appears during the installation, click **Continue Anyway**.

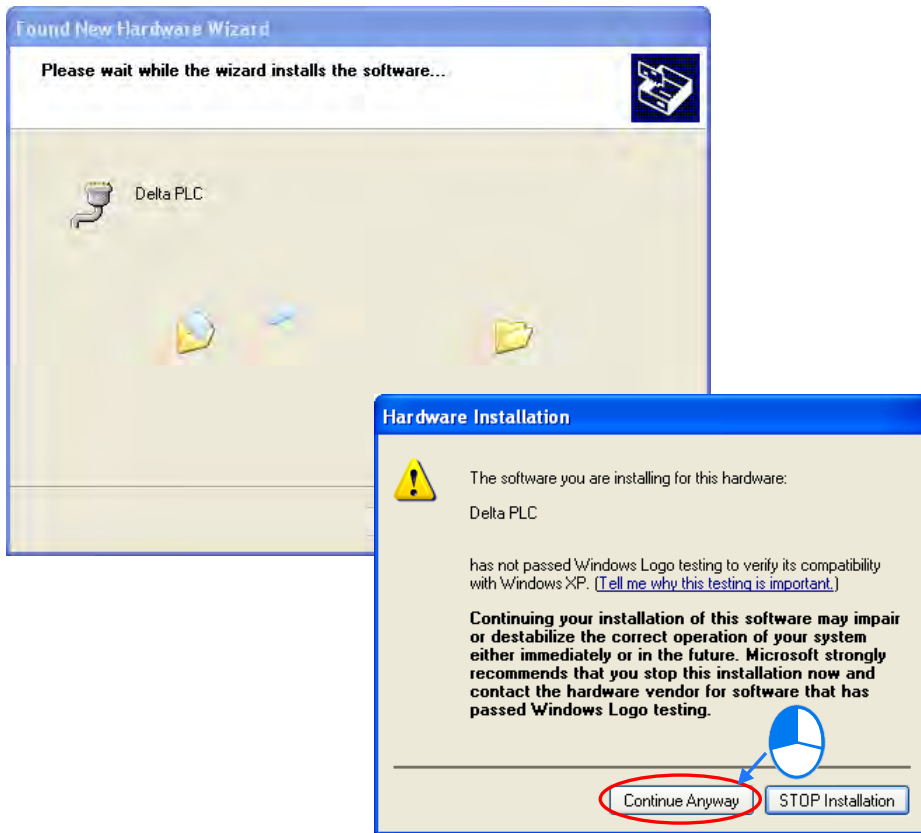

- (5) Click **Finish**.

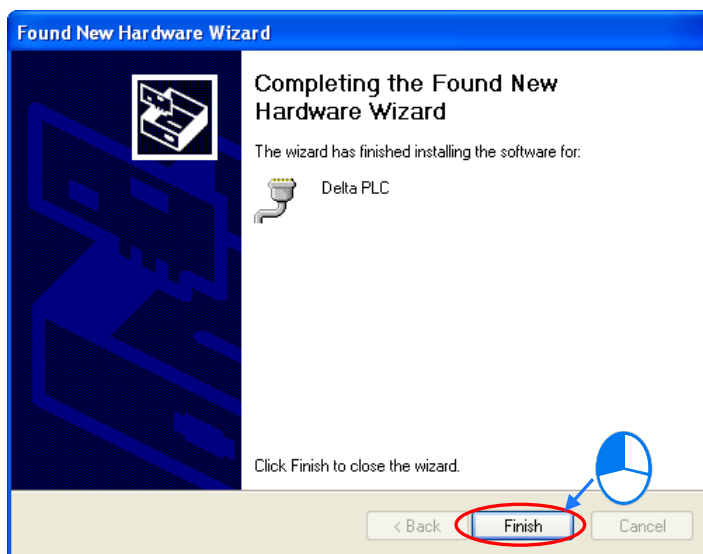

- (6) Open the Windows **Device Manager** window. If the **Delta PLC** port for the USB device is under **Ports (COM & LPT)**, the installation of the driver is successful, and Windows assigns a communication port number to the USB device.

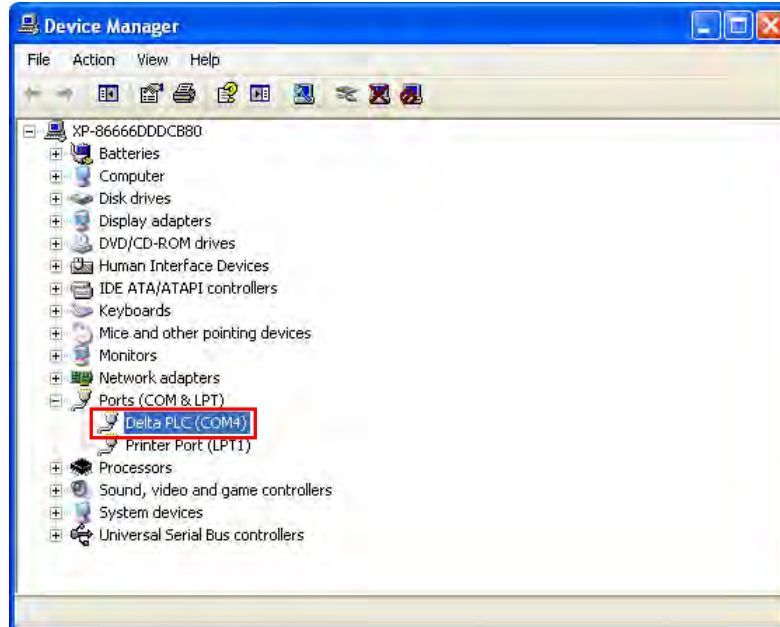

Additional remarks

- If you connect the PLC to a different USB port on the computer, the system may ask you to install the driver again. Follow the steps above, and install the driver again. After you install the driver, the communication port number that the operating system assigns to the USB device may have changed.
- If Windows XP has not been updated to the version SP3 on the computer, an error message stating the missing files will appear during the installation. Resolve this issue with one of the following steps.
 - (a) Cancel the installation, install Windows XP SP3 on the computer, and reinstall the driver according to the steps above.
 - (b) Get the file needed, and specify the path where the file is stored for the missing file in the error message window.

A.2 Installing the USB Driver for an AS Series CPU module in Windows 7

This section describes the steps to install the USB driver for an AS Series CPU module on Windows 7. To install the USB driver for an AS Series CPU module on another operating system, refer to the instructions in the operating system for information about installing new hardware.

Before you install the USB driver, you must install ISPSOft version 3.00 or above on your computer.

Supply power to the AS Series CPU module. Connect the AS Series CPU module to a USB port on the computer with a USB cable.

- (1) Windows detects the module. From the Windows **Control Panel**, open the **Device Manager**. The name of the USB device appears in the Device Manager window. Double-click the AS300.

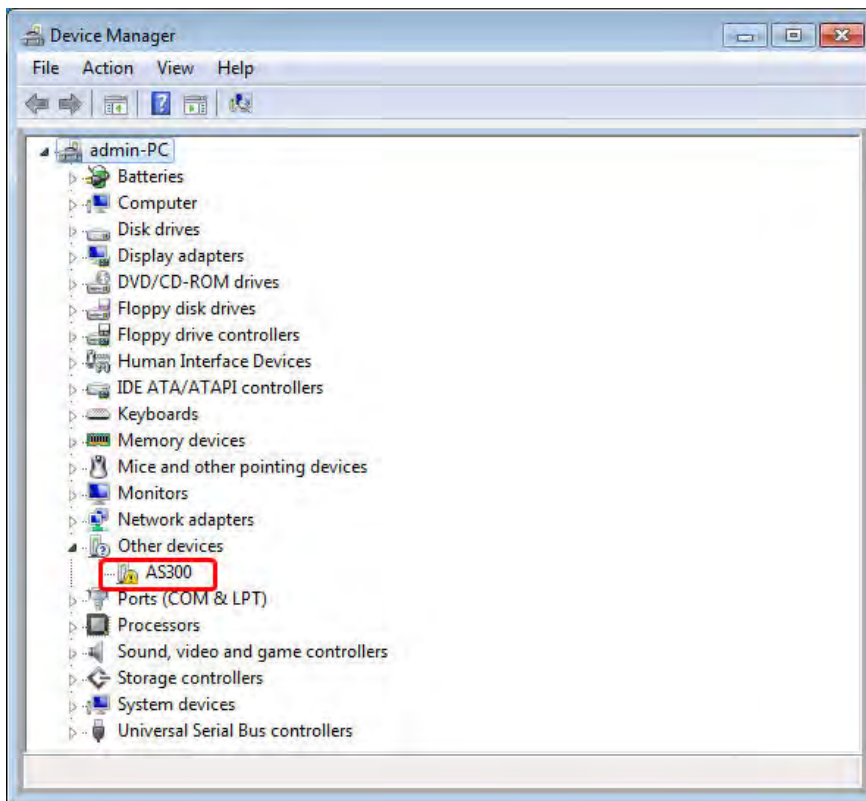

- (2) In the **AS300 Properties** dialog box, click **Update Driver.....**

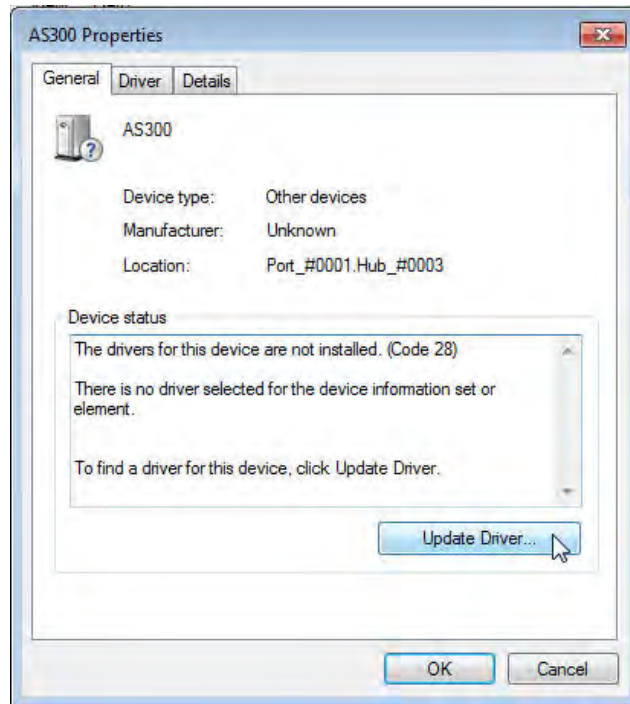

- (3) Click **Browse my computer for driver software.**

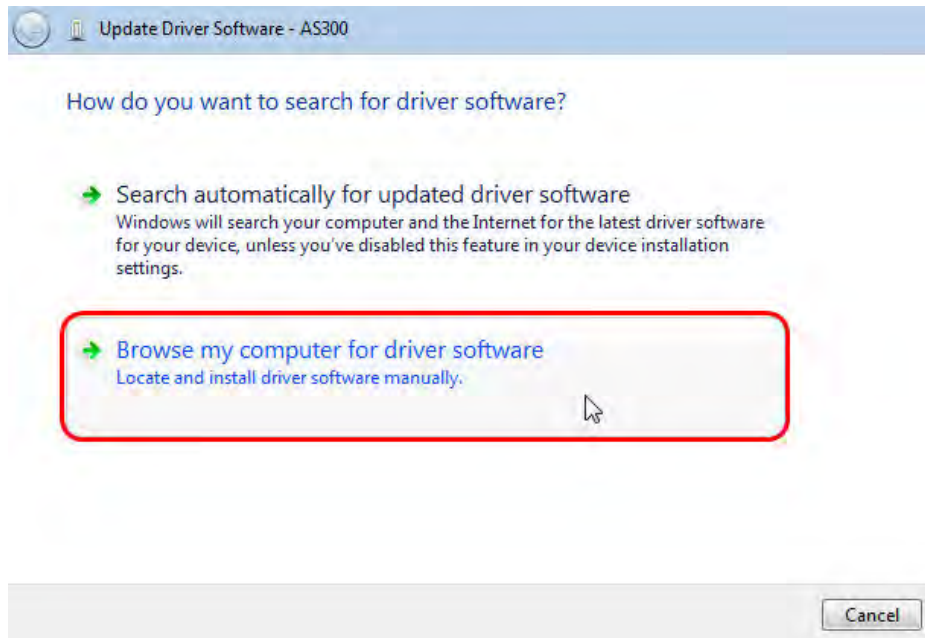

- (4) After you install ISPSOft version 3.00 or later, the driver for the AS Series CPU module is under the folder where you installed ISPSOft ...**ISPSOft\drivers\Delta_PLC_USB_Driver**. Enter the path to the driver, or click **Browse** to browse to the correct folder.

Specify the correct path. If you installed the driver for the AS series CPU module to another location, specify the corresponding path. Click **Next** to continue the installation.

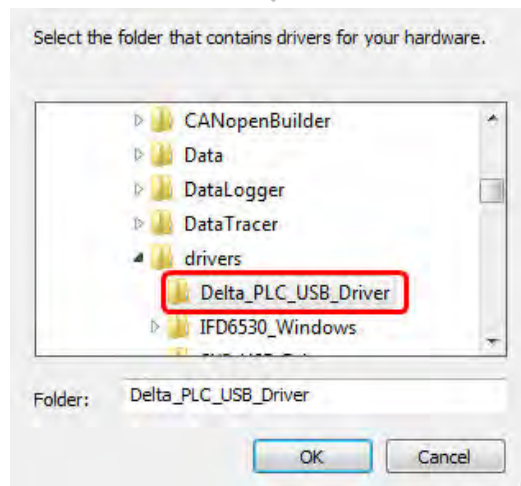
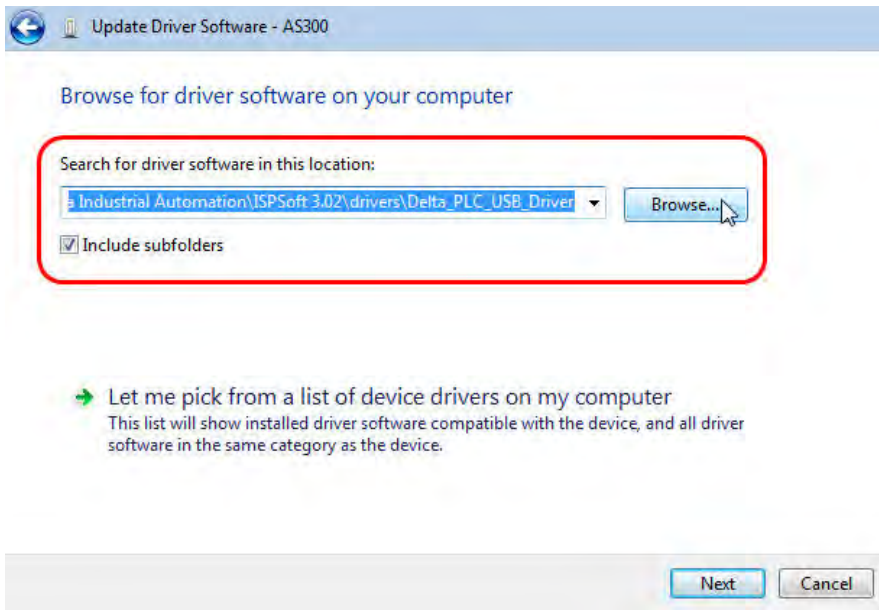

- (5) Click **OK**. The system installs the driver. If the **Windows Security** window appears during the installation, click **Install this driver software anyway**.



- (6) When the installation completes, click **Close**.

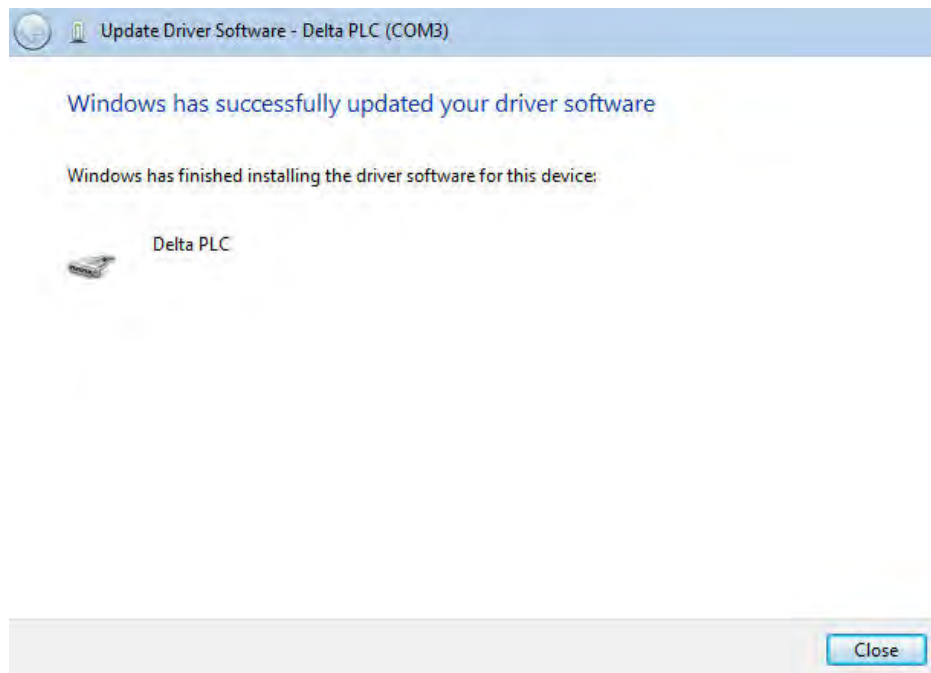

- (7) Open the **Device Manager** window again. If the name of the Delta USB device appears under **Ports (COM & LPT)**, the installation of the driver is successful. The operating system assigns a communication port number to the USB device.

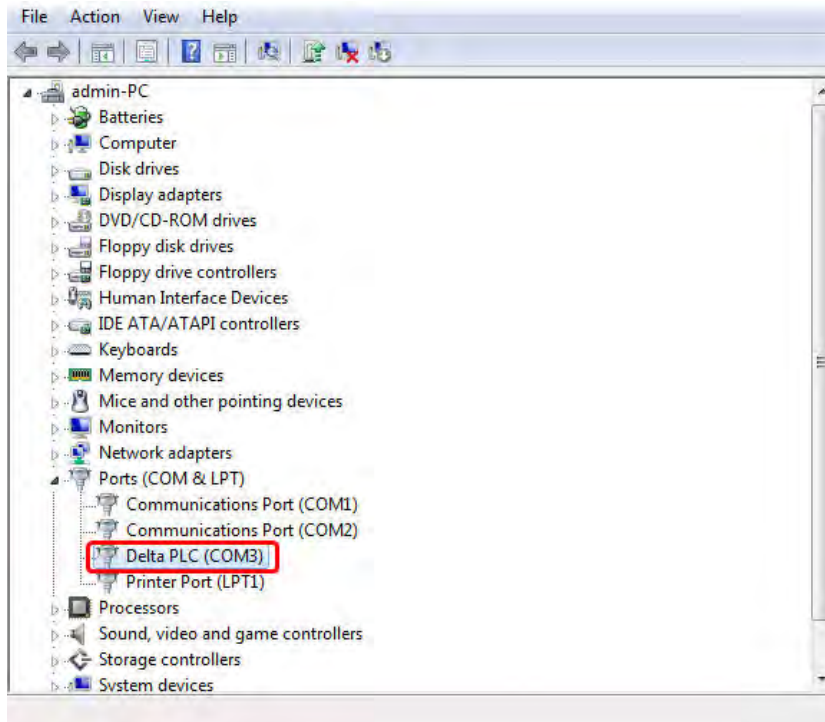

Additional remarks

- If you connect the PLC to a different USB port on the computer, the system may ask you to install the driver again. Install the driver again. After you install the driver, the communication port number that the operating system assigns to the USB device may have changed.

A.3 Installing the USB Driver for an AS Series CPU module in Windows 8

Windows 8 driver signature enforcement provides a way to improve the security of the operating system by validating the integrity of a driver or system file each time it is loaded into memory. Because the Delta PLC USB driver does not include the driver signature, this section shows you how to disable driver signature enforcement in Windows 8 to successfully install the Delta PLC USB driver. Once you disable the driver signature enforcement setting, it returns to its original state after you restart Windows.

Follow these steps to disable driver signature enforcement in Windows 8.

1. Press the Windows button  **[WIN] + [I]** on your keyboard to display the **Settings** window. Click **Change PC settings**.
2. The **PC settings** window appears. Click **General** and then click **Restart now** under **Advanced startup**.

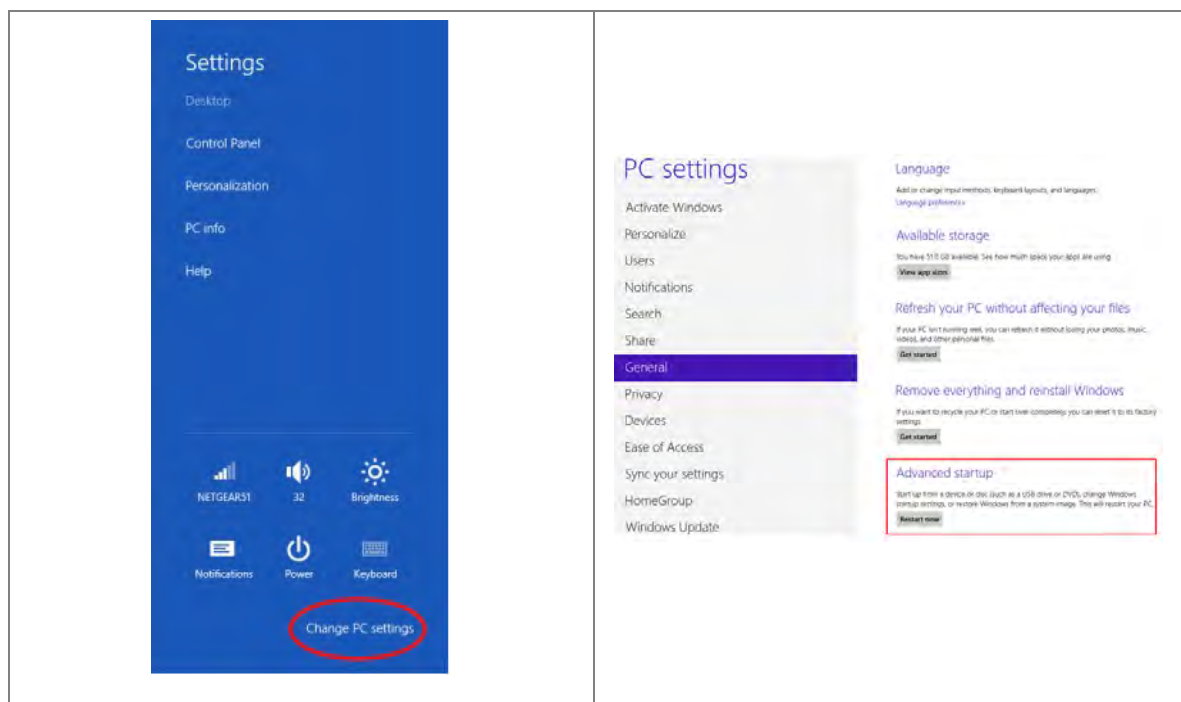

3. After the computer restarts, under **Choose an option**, click **Troubleshoot**. Under **Troubleshoot**, click **Advanced options**.

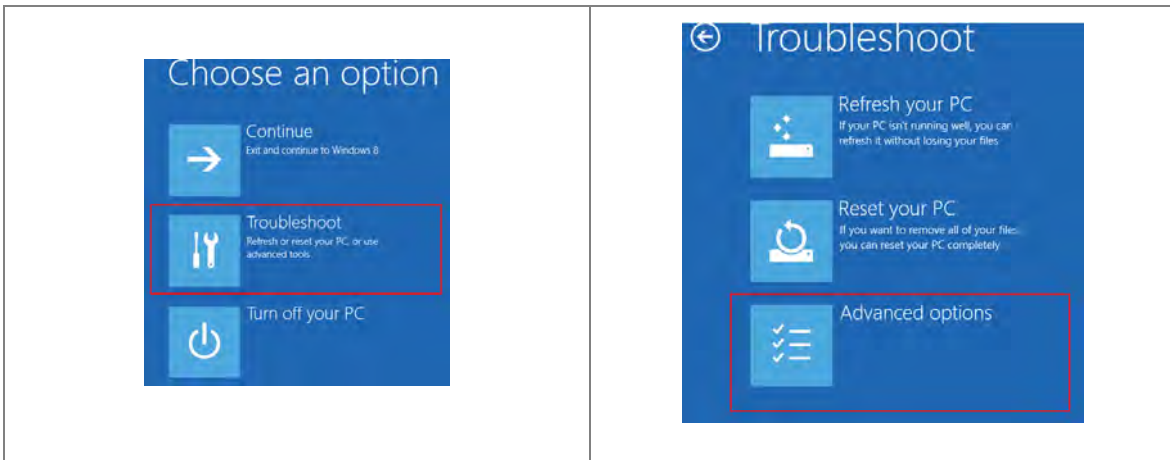

4. On the **Advanced options** page, click **Startup Settings**, and then on the **Startup Settings** page, click **Restart** to restart the computer.

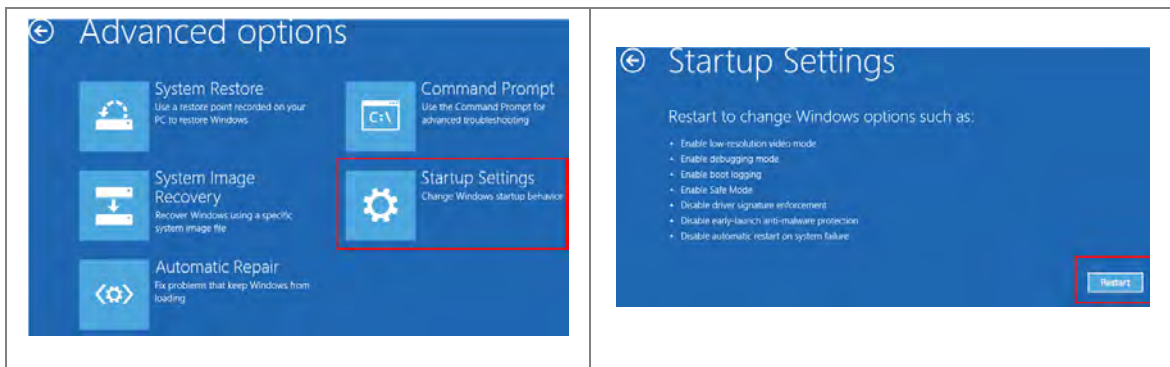

5. Press the 7 or F7 key on your keyboard to choose **Disable driver signature enforcement**. Press Enter and the system directs you back to the Windows 8 operating system. Install the Delta PLC USB driver now by connecting the AS Series CPU module to your computer's USB port. Refer to Section A2 for the steps to install the USB driver.

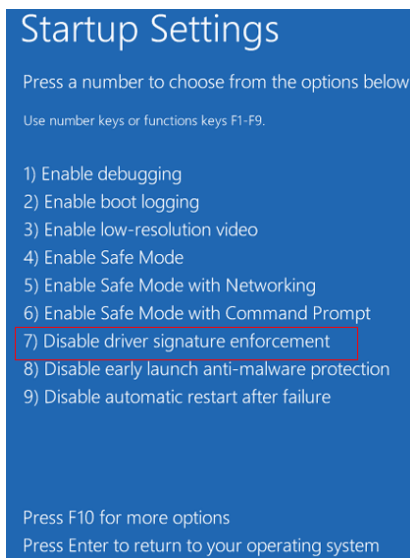

A.4 Installing the USB Driver for an AS Series CPU module in Windows 10

Windows 10 driver signature enforcement provides a way to improve the security of the operating system by validating the integrity of a driver or system file each time it is loaded into memory. Because the Delta PLC USB driver does not include the driver signature, this section shows you how to disable driver signature enforcement in Windows 10 to successfully install the Delta PLC USB. Once you disable the driver signature enforcement setting, it returns to its original state after restarting Windows.

This section describes the steps to disable driver signature enforcement in Windows 10.

1. Click the Windows **Start** button and then click **Settings**.
2. In the **Settings** window, click **Update & Security**.

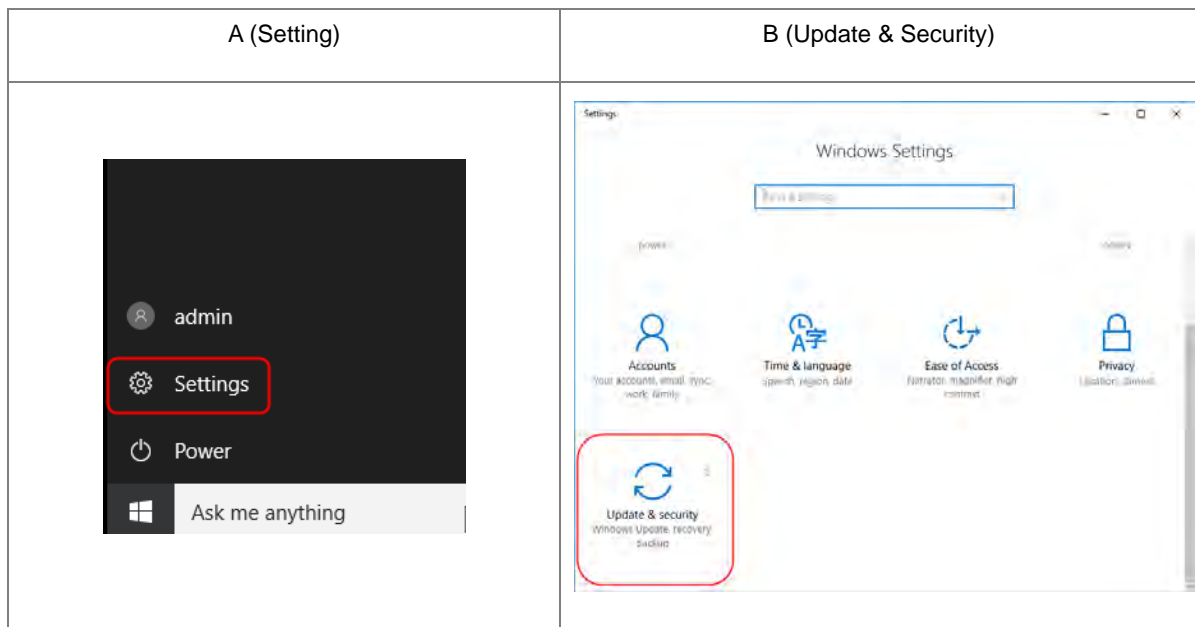

3. In the **Settings** window, click **Recovery**, and then click **Restart now**.

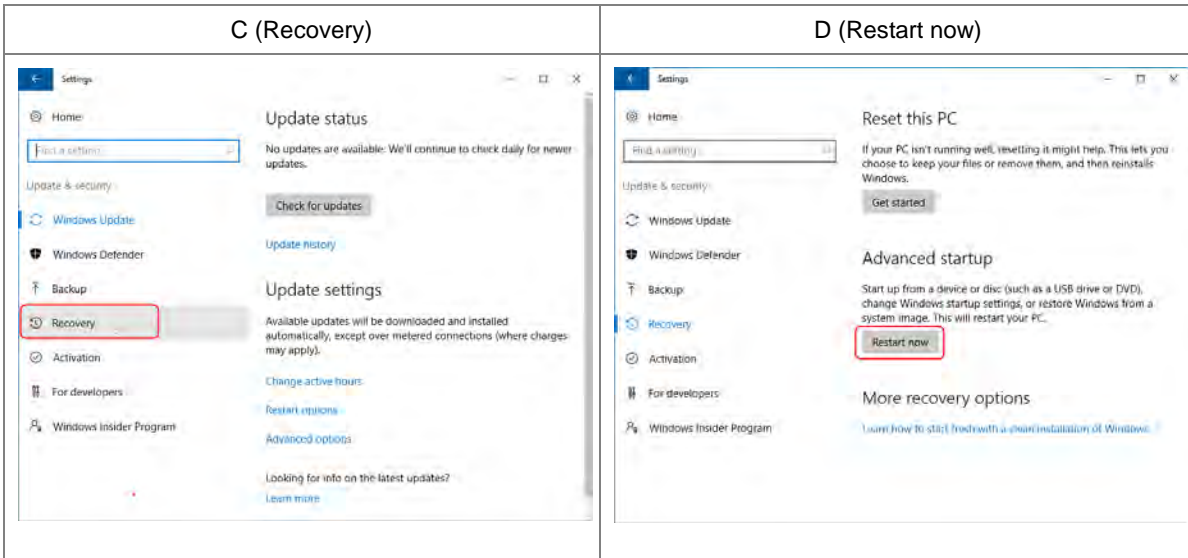

4. After the computer restarts, under **Choose an Option**, click **Troubleshoot**, and then click **Advanced options**.

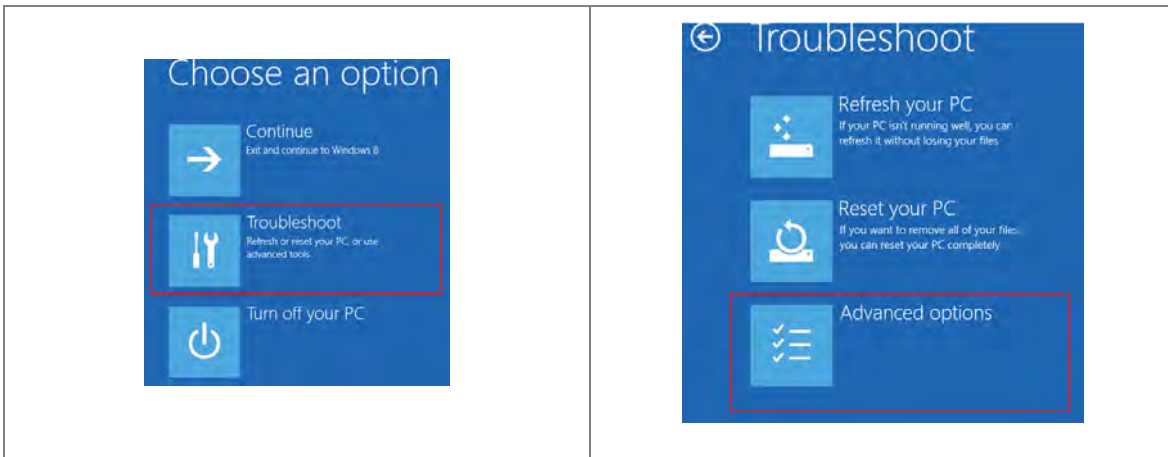

5. On the **Advanced options** page, click **Startup Settings**. On the **Startup Settings** page click **Restart** to restart the computer.

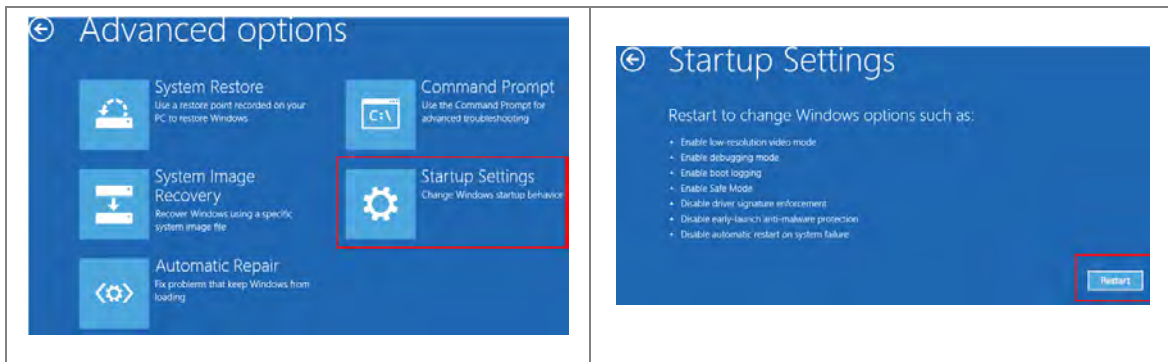

6. On your keyboard, press 7 or F7 to choose **Disable driver signature enforcement**, and the system directs you to the Windows 10 operating system page. Install the Delta PLC USB driver.

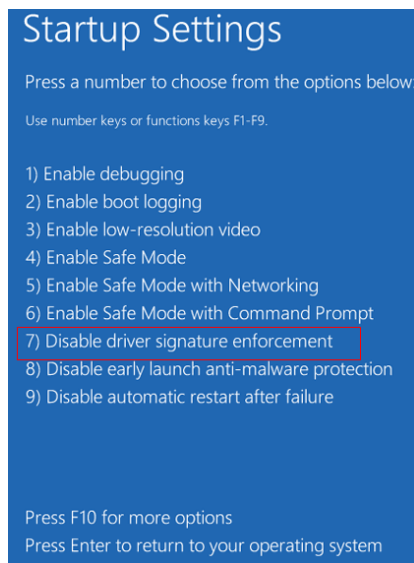

7. Install the USB driver for the AS Series CPU module by connecting the AS Series CPU module to your computer's USB port. Refer to Section A2 for the steps to install the USB driver.

A.5 Notes on Utilizing USB Communication

- Suggested to use USB communication in the following occasions: PLC program upload / download, PLC parameters monitoring, and firmware upgrade.
- Suggested NOT to use USB communication for applications that require long time communication and without any connection drop.
- When experiencing connection lost, you can unplug the USB cable and then plug it back in and try the communication again.
- For the first time USB communication user, you need to install the USB driver for the AS Series PLC CPU.
- If the communication is still not working after unplugging and plugging, you need to open the Devices (Windows settings -> Devices) to see if the USB driver is still valid. The USB driver may be lost due to Windows updates. If your USB driver is invalid, install the USB driver again.



Appendix B Device Addresses

Table of Contents

B.1 Standard Modbus Device Addresses	B-2
B.2 Function Codes and Number of Devices Supported for Modbus Protocols	B-3

B.1 Standard Modbus Device Addresses

Applicable to AS series PLC

Device	Type	Format	Device range	Modbus address (Decimal number)	AS Address (Hexadecimal number)
X	Bit	DD.DD	X0.0-X63.15	124577-125600	6000-63FF
	Word	DD	X0-X63	332769-332832	8000-803F
Y	Bit	DD.DD	Y0.0-Y63.15	040961-041984	A000-A3FF
	Word	DD	Y0-Y63	440961-441024	A000-A03F
M	Bit	DDDD	M0-M8191	000001-008192	0000-1FFF
SM	Bit	DDDD	SM0-SM4095	016385-020480	4000-4FFF
SR	Word	DDDD	SR0-SR2047	449153-451200	C000-C7FF
D	Word	DDDDD	D0-D29999	400001-430000	0000-752F
S	Bit	DDDD	S0-S2047	020481-022528	5000-57FF
T	Bit	DDD	T0-T511	057345-057856	E000-E1FF
	Word	DDD	T0-T511	457345-457856	E000-E1FF
C	Bit	DDD	C0-C511	061441-061952	F000-F1FF
	Word	DDD	C0-C511	461441-461952	F000-F1FF
HC	Bit	DDD	HC0-HC255	064513-064768	FC00-FCFF
	DWord	DDD	HC0-HC255	464513-464768	FC00-FCFF
E	Word	DD	E0-E9	465025-465039	FE00-FE09

B.2 Function Codes and Number of Devices Supported for Modbus Protocols

Applicable to AS series PLC

Function code	Name	Description	Number of devices supported (FW V1.06.00 or later)	Number of devices supported (FW V1.06.10 or later)
01	Read Coil Status	X, Y, M, SM, S, T, C, HC	1~256 bits	1~1600 bits
02	Read Discrete Input Status	X, Y, M, SM, S, T, C, HC	1~256 bits	1~1600 bits
03	Read Holding Registers	X, Y, SR, D, T, C, HC, E	1~100 words, (1~50 for HC)	1~100 words, (1~50 for HC)
04	Read Input Registers	X	1~100 words	1~100 words
05	Force Single Coil	Y, M, SM, S, T, C, HC	1 bit	1 bit
06	Preset Single Register	Y, SR, D, T, C, HC, E	1 word	1 word
0F	Force Multiple Coils	Y, M, SM, S, T, C, HC	1~256 bits	1~1600 bits
10	Preset Multiple Register	Y, SR, D, T, C, HC, E	1~100 words, (1~50 for HC)	1~100 words, (1~50 for HC)
17	Read/Write Multiple Register	Y, SR, D, T, C, HC, E	1~100 words, (1~50 for HC)	1~100 words, (1~50 for HC)

MEMO

B

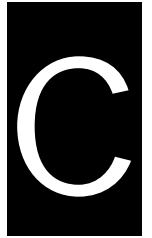

Appendix C EMC Standards

Table of Contents

C.1 EMC Standards for an AS Series System	C-2
C.1.1 AS Series System EMC Standards	C-2
C.1.2 Installation Instructions to meet EMC Standards	C-4
C.1.3 Cables	C-5

C.1 EMC Standards for an AS Series System

C.1.1 AS Series System EMC Standards

The EMC standards that are applicable to an AS series system are listed in the following tables.

- EMI

Port	Frequency range	Level (Normative)	Reference standard
Enclosure port (radiated) (measured at a distance of 10 meters)	30-230 MHz	40 dB ($\mu\text{V}/\text{m}$) quasi-peak	IEC 61000-6-4
	230-1000 MHz	47 dB ($\mu\text{V}/\text{m}$) quasi-peak	
AC power port (conducted)	0.15-0.5 MHz	79 dB (μV) quasi-peak	IEC 61000-6-4
		66 dB (μV) average	
	0.5-30 MHz	73 dB (μV) quasi-peak	
		60 dB (μV) average	

- EMS

Environmental phenomenon	Reference standard	Test		Test level
Electrostatic discharge	IEC 61000-4-2	Contact		± 4 kV
		Air		± 8 kV
Radio frequency electromagnetic field Amplitude modulated	IEC 61000-4-3	80% AM, 1 kHz sinusoidal	2.0-2.7 GHz	1 V/m
			1.4-2.0 GHz	3 V/m
			80-1000 MHz	10 V/m
Power frequency magnetic field	IEC 61000-4-8	60 Hz		30 A/m
		50 Hz		30 A/m

- **Conducted immunity test**

Environmental phenomenon		Fast transient burst	High energy surge	Radio frequency interference
Reference standard		IEC 61000-4-4	IEC 61000-4-5	IEC 61000-4-6
Interface/Port	Specific interface/port	Test level	Test level	Test level
Data communication	Shielded cable	1 kV	1 kV CM	10 V
	Unshielded cable	1 kV	1 kV CM	10 V
Digital and analog I/O	AC I/O (unshielded)	2 kV	2 kV CM 1 kV DM	10 V
	Analog or DC I/O(unshielded)	1 kV	1 kV CM	10 V
	All shielded lines (to the earth)	1 kV	1 kV CM	10 V
Equipment power	AC power	2 kV	2 kV CM 1 kV DM	10 V
	DC power	2 kV	0.5 kV CM 0.5 kV DM	10 V
I/O power and auxiliary power output	AC I/O and AC auxiliary power	2 kV	2 kV CM 1 kV DM	10 V
	DC I/O and DC auxiliary power	2 kV	0.5 kV CM 0.5 kV DM	10 V

C.1.2 Installation Instructions to meet EMC Standards

You must install an AS Series PLC in a control box. The control box protects the PLC and isolates electromagnetic interference generated by the PLC.

(1) Control box

- Use a conductive control box. Remove the paint on the plate bolts to ensure good contact between the inner plate and the control box.
- Connect the control box with a thick wire to ensure that the control box is well-grounded, even if there is high-frequency noise.
- The diameter of holes in the control box must be less than 10 millimeters (3.94 inches). Radio frequency noise may be emitted if the hole diameter is larger than 10 millimeters.
- Minimize the distance between the door of the control box and the PLC to prevent radio waves from leaking. You can also prevent radio waves from leaking by putting an EMI gasket on the painted surface.

(2) Connecting a power cable and a ground

Connect the PLC system power cable and the ground as described below.

- Provide a ground point near the power supply module. Use thick, short wires to connect the terminals LG and FG with the ground. The length of the wire should be less than 30 centimeters (11.18 inches). Noise generated by the PLC system is passed to the ground through LG and FG; therefore, the impedance should be as low as possible. Although the wires are used to reduce noise, they themselves carry a lot of noise. Using short wires can prevent the wires from acting as antennas.
- Twist the ground and the power cable together; the noise flowing through the power cable is then passed to the ground. The ground and the power cable do not need to be twisted if you install a filter on the power cable.

C.1.3 Cables

Grounding a shielded cable

Cables drawn from the control box carry high-frequency noise. When they are outside of the control box, they are like antennas emitting noise. The cables connected to digital input/output modules, analog input/output modules, temperature measurement modules, network modules, and motion control modules should all be shielded cables to prevent the emission of noise. Using shielded cables also increases the resistance to external noise. You improve the resistance to noise if the signal cables that are connected to the digital input/output modules, analog input/output modules, temperature measurement modules, network modules, and motion control modules are all shielded cables that are grounded properly. If you do not use shielded cables or ground the shielded cables correctly, noise resistance will not improve. Make sure the shield of any connected cable contacts the control box. You must scrape any paint off of the control box at the contact point. All fastening must be metal, and the shield must contact the surface of the control box. Use washers to correct any unevenness or use an abrasive to level the surface.

Ground the shield of a shielded cable as close to a module as possible. Ensure that there is no electromagnetic induction between grounded cables.

MEMO

C









Appendix D Maintenance and Inspection

Table of Contents

D.1 Cautions	D-2
D.2 Daily Maintenance	D-3
D.2.1 Required Inspection Tools	D-3
D.2.2 Daily Inspection	D-3
D.3 Periodic Maintenance	D-4
D3.1 Required Inspection Tools	D-4
D.3.2 Periodic Inspection	D-5

D.1 Cautions

Observe the following precautions before performing maintenance and inspection. **Incorrect or careless operation will lead to injury or equipment damage.**

-  ● To prevent a breakdown of an AS Series system or a fire, ensure that the ambient environment does not contain corrosive substances such as chloride gas, sulfide gas or flammable substances such as oil mist, cutting powder, or dirt.
-  ● To prevent the connectors from oxidizing and to prevent electric shock, do not touch the connectors.
-  ● To prevent electric shock, turn off the power before pulling the connectors or loosening the screws.
-  ● To prevent cable damage, and to prevent the connectors from being loosened, do not put weight on the cables or pull on them.
-  ● Ensure that the input voltage is within the rated range.
-  ● To prevent product breakdown, fire, or injury, do not disassemble or alter the modules.
- To prevent a controlled element from malfunctioning, ensure that the program and parameters are written into a new CPU module before restarting the AS Series system.
- To prevent incorrect output or equipment damage, refer to the related manuals for more information about operating the modules.
- To prevent damage to the modules, touch grounded metal or wear an antistatic wrist strap to release static electricity from your body before working on a module.
- To prevent noise from causing system breakdown, keep a proper distance from the system when using a cell phone or communication device.
- Do not install an AS Series system in direct sun or in a humid environment.
- To prevent the temperature of an element from being too high, maintain a proper distance between the AS Series system and heat sources such as coils, heating devices, and resistors.
- To protect an AS Series system, install an emergency stop switch and an overcurrent protection device.
- Inserting and pulling a module several times can loosen the contact between the module and the backplane.

- To prevent an unexpected shock from resulting in damage to the AS Series system and a controlled element, ensure that the modules are correctly and firmly installed.

D.2 Daily Maintenance

To keep an AS series system operating normally, ensure that the ambient environment and the AS series system conform to the cautions listed in section D.1. You can then perform the daily inspection described below. If you find any problems, follow the solution and perform any necessary maintenance.

D.2.1 Required Inspection Tools

- A screwdriver
- Industrial alcohol
- A clean cotton cloth

D.2.2 Daily Inspection

No.	Item	Inspection	Criterion	Remedy
1	Appearance	Check visually.	Dirt must not be present.	Remove the dirt.
2	Installing of a backplane	Check whether the set screws are loose.	The backplane must be installed firmly.	Tighten the screws.
		Check whether the backplane is installed on the DIN rail properly.		Install the backplane on the DIN rail properly.
3	Installing of a module	Check whether the module is loose that the projection is inserted into the hole on the backplane, and that the screw is tightened.	The projection under the module must be inserted into the hole in the backplane, and the screw must be tightened.	Install the module firmly.
4	Connection	Check whether the removable terminal block is loose.	The removable terminal block must not be loose.	Install the terminal block firmly.
		Check whether the connector is loose.	The connector must not be loose.	Tighten the screws on the connector.

No.	Item		Inspection	Criterion	Remedy
5	Power supply module	POWER LED indicator	Check whether the POWER LED indicator is ON.	The POWER LED indicator must be ON.	Please refer to Chapter 12 for more information about troubleshooting.
	CPU module	RUN LED indicator	When the CPU module is running, check whether the RUN LED is ON.	The RUN LED indicator must be ON.	
		ERROR LED indicator	Check whether the ERROR LED indicator is OFF.	The ERROR LED indicator must be OFF.	
		BUS FAULT LED indicator	Check whether the BUS FAULT LED indicator is OFF.	The BUS FAULT LED indicator must be OFF.	
		SYSTEM LED indicator	Check whether the SYSTEM LED indicator is OFF.	The SYSTEM LED indicator must be OFF.	
	LED indicators on an extension module*		Check whether the LED indicators on the extension module are ON.	If the LED indicators are ON, the module is operating normally.	

* Please refer to the Module Manual for more information related to the LED indicators on the extension modules.

D.3 Periodic Maintenance

In addition to daily inspection, you should perform periodic maintenance depending on the actual operating environment. After making sure that the ambient environment and the AS Series system conform to the cautions listed in Section D.1, perform the periodic inspection described below. If you find any problems, follow the solution and perform any necessary maintenance.

D3.1 Required Inspection Tools

- A screwdriver
- Industrial alcohol
- A clean cotton cloth
- A multimeter
- A thermometer
- A hygrometer

D.3.2 Periodic Inspection

No.	Item		Inspection	Criterion	Remedy
1	Ambient environment	Ambient temperature/humidity	The ambient temperature and the ambient humidity are measured by a thermometer and a hygrometer.	The ambient temperature and the ambient humidity must conform to the specifications for the modules or the backplane. If the specifications are different, the strictest specifications have priority.	To ensure that the system operates in a stable environment, determine why the environment varies, and resolve the issue.
		Atmosphere	Measure corrosive gas.	Corrosive gas must not be present.	
2	Supply voltage		Measure the AC power supply.	The power supply should meet the specifications for the power supply module.	Check the power supply.
3	Installation	Looseness	Check whether the module is loose.	The module must be installed firmly.	Please refer to Chapter 4 for more information on installing the module.
		Adhesion of dirt	Check the appearance.	Dirt must not be present.	Remove the dirt.
4	Connection	Looseness of terminal screws	Tighten the screws with a screwdriver.	The screws must not be loose.	Tighten the screws.
		Looseness of connectors	Pull the connectors.	The connectors must not be loose.	Tighten the screws on the connectors.
5	PLC system diagnosis		Check the error logs.	No new error occurs.	Please refer to section 12.1.3 for more information.

No.	Item	Inspection	Criterion	Remedy
6	Maximum scan time	Check the states of SR413 and SR414 through the device monitoring table in ISPSOft.	The maximum scan cycle must be within the range specified in the system specifications.	Determine why the scan time exceeds specifications.