



Digitized Automation for a Changing World

Delta Compact Modular Mid-range PLC AS Series



www.deltaww.com



Flexible, Smart, Friendly - The Best Choice for a Controller of Automated Equipment

The AS Series Compact Modular Mid-range PLC is a high performance multi-purpose controller designed for all kinds of automated equipment. It features Delta's self-developed 32-bit SoC CPUs for enhanced execution speed (40k steps/ms) and supports up to 32 extension modules or up to 1,024 inputs/outputs. The AS series provides accurate positioning control for up to 8 axes via CANopen motion network and 6 axes via pulse control (200 kHz). It is widely used in diverse automated equipment such as for electronics manufacturing, labeling, food packaging, and textile machines.

The AS Series Controller is equipped with CANopen and EtherNet/IP network communication for high-speed data transmission. The professional yet simple editing software DIADesigner delivers quick hardware and network configuration with built-in function blocks for different industries. It also provides multi-layer password protection for enhanced system security.

The AS Series adopts a rackless design and DIN rail clips for fast vertical module installation. The simple shape and dark gray exterior of the AS series help resist stains and dirt in harsh industrial environments.





High Efficiency Computing

- Advanced CPU performance
- Optimized execution efficiency
- Optimized I/O update rate
- Permanent data backup, no battery required



Accurate Axis Control

- Delta CANopen positioning control
- Simple control instructions
- High-speed pulse positioning control
- High-speed counter

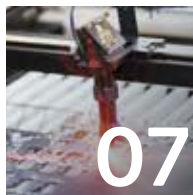

AS500 Motion Control Solution

- AS500 EtherCAT motion control system
- AS500 CANopen motion control system
- Higher scalability in DVP-MC & AS500
- Highly integrated CPU design



AX-3 CODESYS Control Solution

- AX-3 CODESYS control system
- Benefits of CODESYS platform
- Highly integrated CPU design



Simple Installation

- Easy installation process
- Convenient grounding protection
- Screwless installation procedure
- Loose-proof clip-type terminal block



AS Series Industrial Network Solution

- EtherNet/IP solution
- Remote I/O solution
- IIoT Applications
- EtherCAT Point-to-Point positioning solution
- Serial communication solution

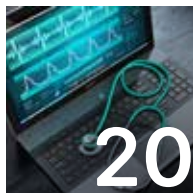

Programming & Diagnosis

- Modular programming structure
- Convenient editing environment
- Easy hardware configuration and parameter setting
- Complete setting tools
- Multiple password protection



Models and Specifications

- Model name explanation
- CPU
- AS Series I/O modules
- High-density modules and accessories
- Dimensions
- Ordering information

High Efficiency Computing



Delta's self-developed AS100/200/300 Series CPU provides 32-bit high-performance computing and a real-time operation system. As the core of a high-efficiency controller, it helps increase the productivity and adaptability of demanding equipment.



Advanced CPU Performance

■ High Execution Speed

- Max. number of inputs/outputs: 1,024
- Max. extension ability: 32 modules

Basic instruction / Boolean operation

AS100/200/300 series CPU 25 ns

AS500 series CPU 50 ns

AX-3 series CPU 2 ~ 5 ns



Optimized Execution Efficiency

General Scanning Method

Standard simplex scanning which sequentially goes through instructions by fixed schedule operation (e.g. I/O update). It significantly affects overall execution speed.

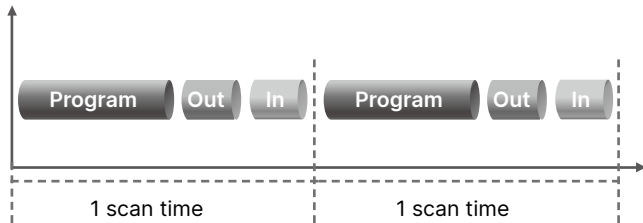

AS Series Scanning Method

Fixed schedule operations will be automatically processed by the CPU background program when scanning starts. This significantly enhances execution speed.

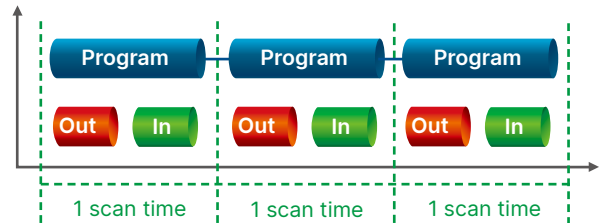

Optimized I/O updates

Common in the industry: PLC module bus update via serial communication

General serial communication: the signal is sequentially sent from the 1st module to the last module. The more modules the longer I/O update time it takes.

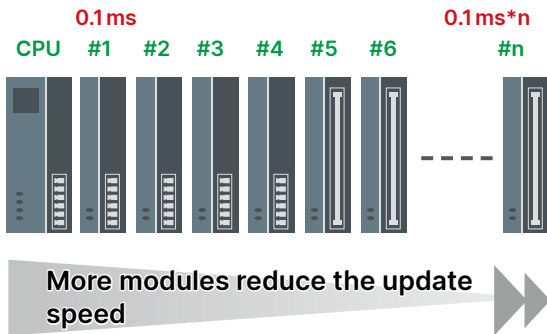

AS Series: PLC module bus update via optimized CAN protocol

CAN protocol: The signal is sent via optimized CAN bus protocol. The I/O update time is not significantly prolonged even with more modules.

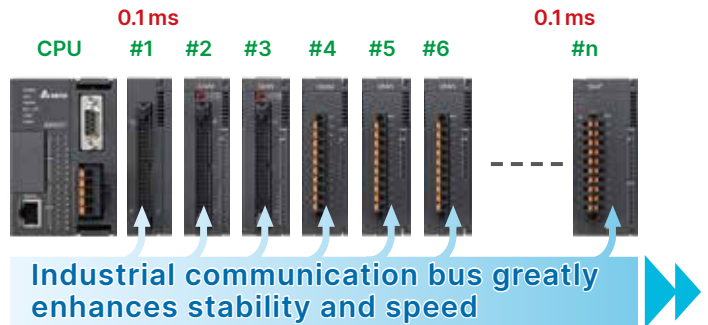

Note: The real updating performance will be different for different extension modules.

Permanent data backup, no battery required

Non-volatile memory material for data backup

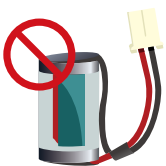

	PLC power off
PLC programs	permanent backup
Latched area	permanent backup

Lithium button battery for Real Time Clock (RTC) function



	PLC power off
RTC	keeps accurate time

Accurate Axis Control - Positioning Control Solution

AS100/200/300 CPU



CANopen DS301



Supports up to 8 Delta servo drives, 8 AC motor drives, and 7 AS RIO stations

AS100/200/300 positioning control - Delta's CANopen control

- AS100/200/300 supports up to 8 Delta servo drives and 8 AC motor drives (AS-FCOPM function card is needed for the AS300)
- Fast positioning configuration in one initialization instruction without building CANopen data exchange table
- Axis control by instructions provides easy maintenance and high PLC program readability

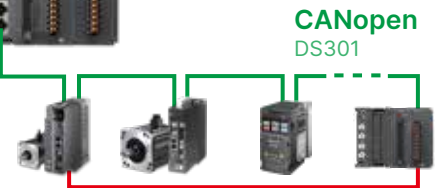

Supports up to 8 servo drives, 8 AC motor drives, and 7 AS RIO stations

Simple control instructions for Delta drives (AS100/200/300 series CPU only)

- Initialization: INITC
- Relative positioning: DRVIC (Servo only)
- Read and write parameter: COPRW
- Acceleration and deceleration: CASD
- Constant speed control: PLSVC
- Absolute positioning: DRVAC (Servo only)
- Start/Stop: ASDON
- Homing: ZRNC (Servo only)

ASDA-A2 back and forth motion control in 4 steps

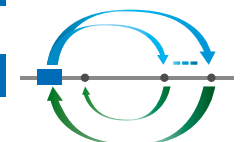
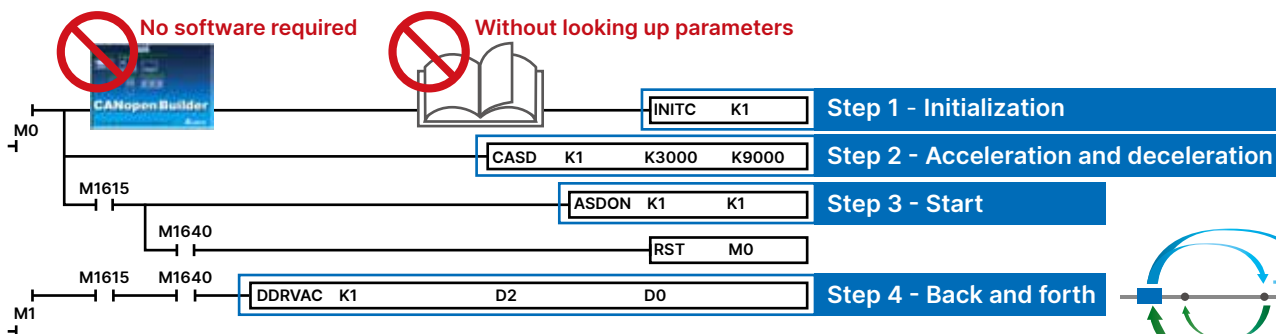

Dynamic modification of next speed and position.

Pulse 



Motion control of max. 6 Delta AC Servo Drives

■ Positioning control - high-speed pulse

- AS332T-A/AS332P-A transistor CPU: 6 axes (or 12 channels) 200 kHz
- AS324MT-A differential CPU: 2 axes 4 MHz + 4 axes 200 kHz
- Supports positioning planning table for fast positioning planning and path simulation (AS100/200/300 series CPU only)
- Choose any given 2 axes for linear and arc interpolation

* Note: Please refer to the product specification section (P.28) for more information on CPU models



AS100/200/300 CPU

AC Servo Drive
ASDA-B3 & ASDA-B2 Series

■ High-speed counter

- Real-time high precision monitoring:
AS332T-A/AS332P-A transistor CPU: 6 channels 200 kHz
AS324MT-A differential CPU: 2 channels 4 MHz / 4 channels 200 kHz
- Up to 16 external input interrupts
- High-speed counter setting tools

* Note: Please refer to the product specification section (P.28) for more information on CPU models

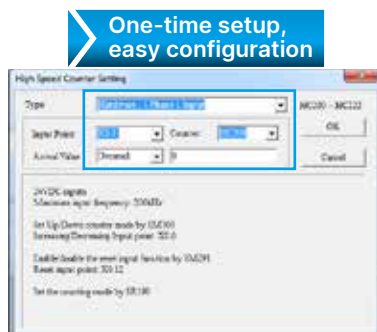

AS100/200/300 CPU

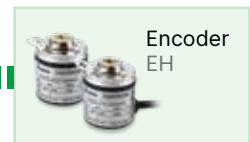

Encoder
EH

Regular
photoelectric sensor
PS-R

Flat-type
photoelectric sensor
PS-F

AS500 Motion Control Solution



AS500 EtherCAT motion control system

- AS516E CPU supports up to 16 Delta EtherCAT servos (min. sync time: 1 ms/16 axes)
- AS532ES/AS564ES CPUs support up to 32/64 Delta EtherCAT servos (Point-to-Point mode)
- Supports AS power, DIO, AIO, temperature and load cell expansion modules (max. 32 modules)
- 1GHz processor provides high operation performance
- Provides various motion commands: position, velocity, torque, multi-axis interpolation, E-gear, E-CAM, G-code, and more
- Built-in 16 DI & 8 DO, 2 incremental encoders, SSI absolute encoder, RS-232/485, Ethernet, CANopen DS301 and EtherCAT interfaces

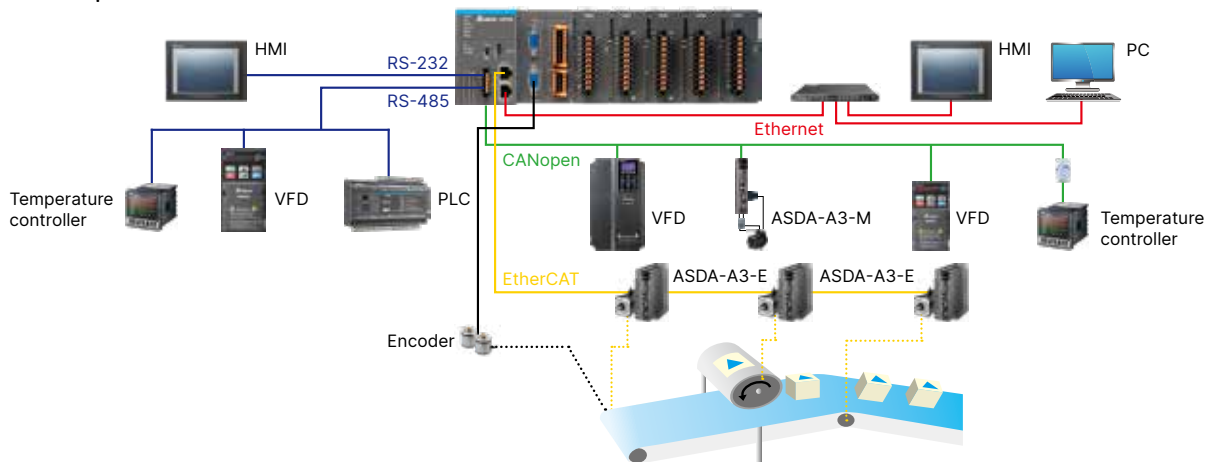

AS500 CANopen motion control system

- AS524C CPU supports up to 24 axes Delta CANopen servos (min. sync time: 2 ms/4 axes)
- Supports AS power, DIO, AIO, temperature and load cell expansion modules (max. 32 modules)
- 1GHz processor provides high operation performance
- Provides various motion commands: position, velocity, torque, multi-axis interpolation, E-gear, E-CAM, G-code, and more
- Built-in 16 DI & 8 DO, 2 incremental encoders, SSI absolute encoder, RS-232/485, Ethernet (x2), CANopen DS301 and CANopen motion interfaces

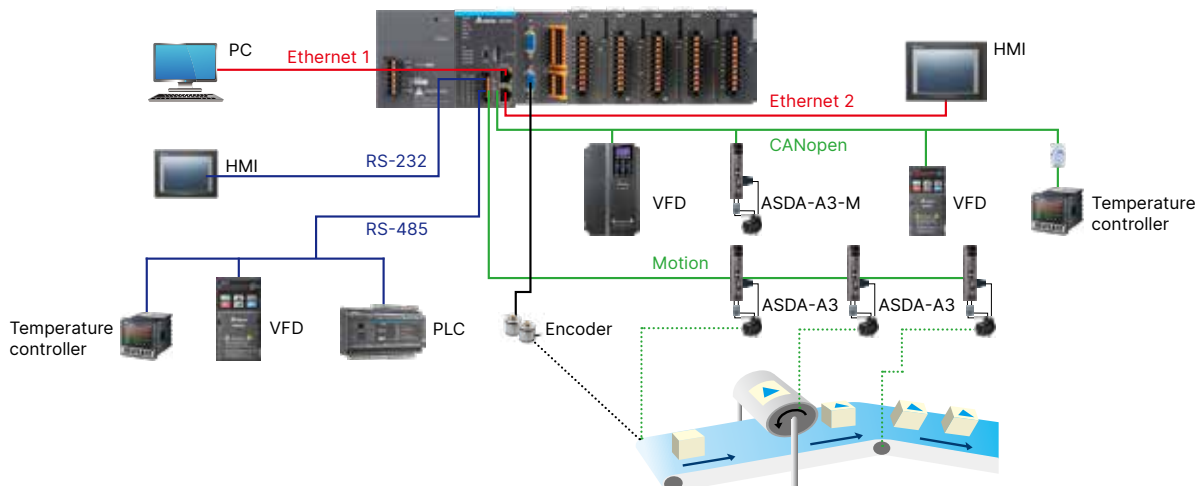

■ Higher scalability in DVP-MC and AS500

AS500 motion CPUs are designed with the Delta DVP-MC motion platform, which allows users to scale up/down their systems to AS/DVP systems without rewriting all programs

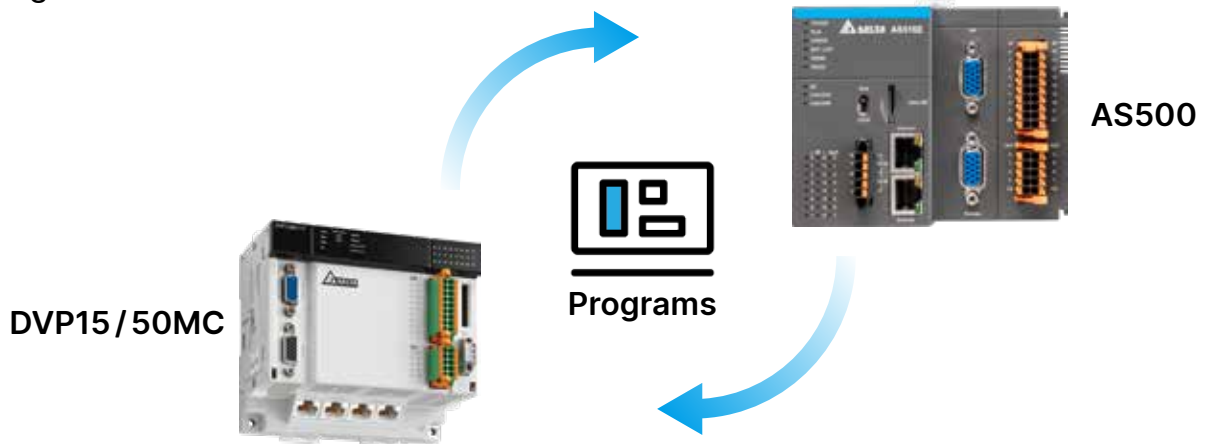

■ Highly integrated CPU design

The AS500 motion control CPUs feature various built-in I/O and communication protocols to satisfy customer needs for compact design and high performance

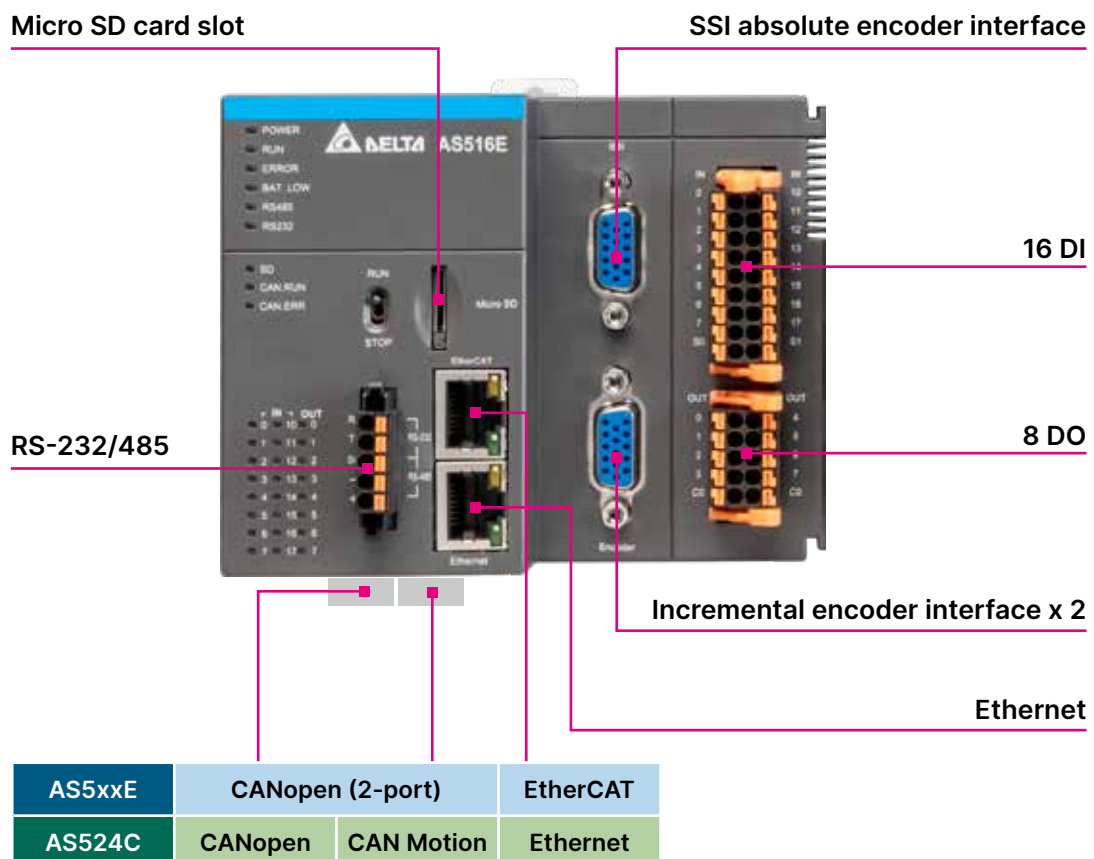

AX-3 CODESYS Control Solution



■ AX-3 CODESYS Control System

- Provides multiple controller solutions
 - EtherCAT motion controllers
 - AX-308E/AX-316E/AX-332E CPU supports up to 8/16/32 EtherCAT axes (AX-332E min. sync time: 1 ms / 32 axes)
 - AX-304EL/AX-364EL CPUs support up to 4/64 EtherCAT axes (Point-to-Point mode)
 - Logical controllers
 - AX-300N/AX-324N CPUs built-in 0/24 DIO points
- Supports AS power, DIO, AIO and temperature expansion modules (max. 32 modules)
- High performance, min. command execution time: 2 ns
- Provides various motion commands: position, velocity, torque, multi-axis interpolation, E-gear, E-CAM, and more
- Built-in 6 ~ 16 DI & 6 ~ 8 DO, incremental encoders, SSI absolute encoder, RS-232/422/485, Ethernet and EtherCAT interfaces

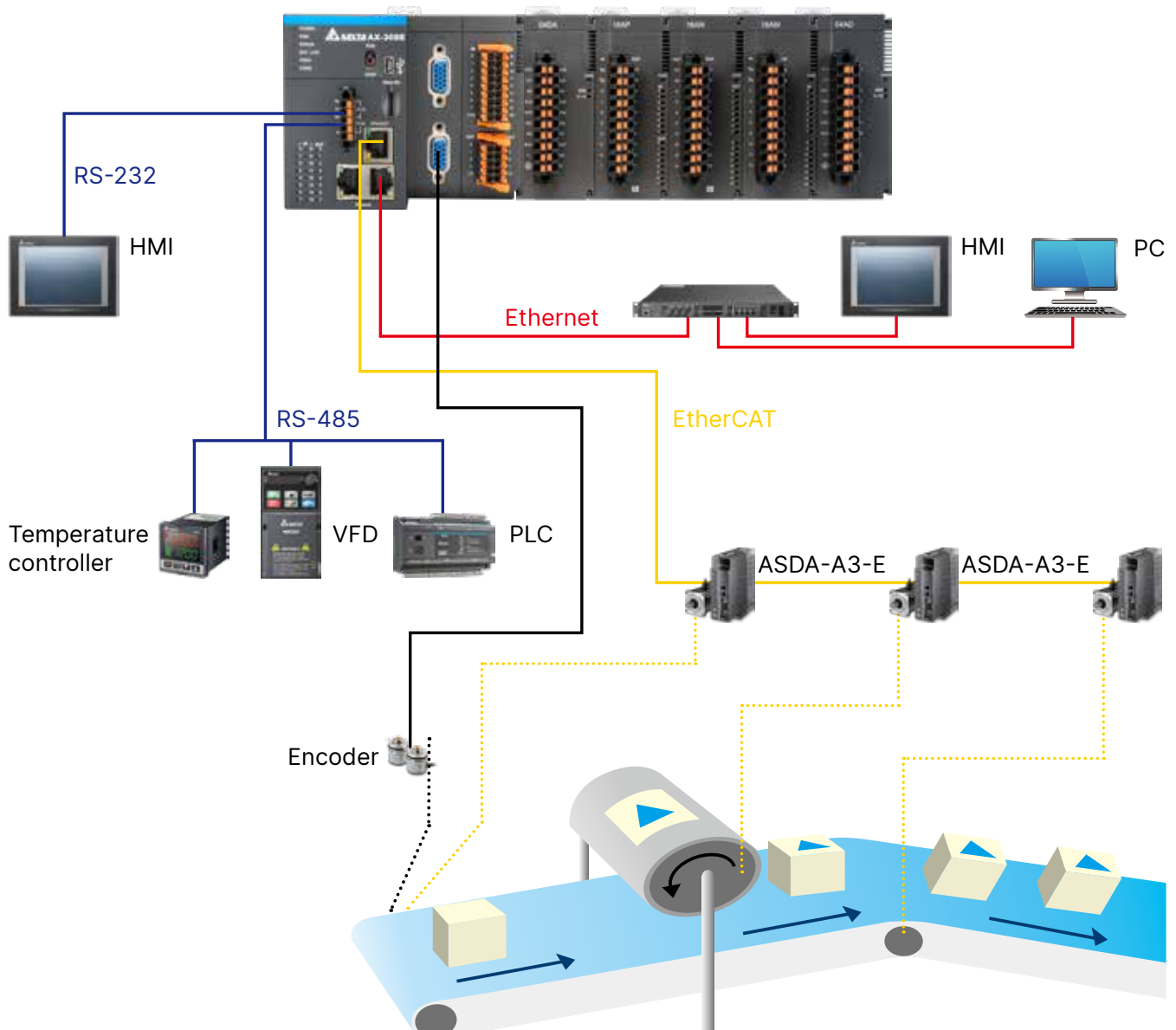

Note: Actual support functions will vary by series

■ Benefits of CODESYS platform

- IEC 61131-3 standards
- High performance and stable operation system
- Enhances project development efficiency with a standardized programming and controller development platform for parameter setting, configuration and PLCopen editing

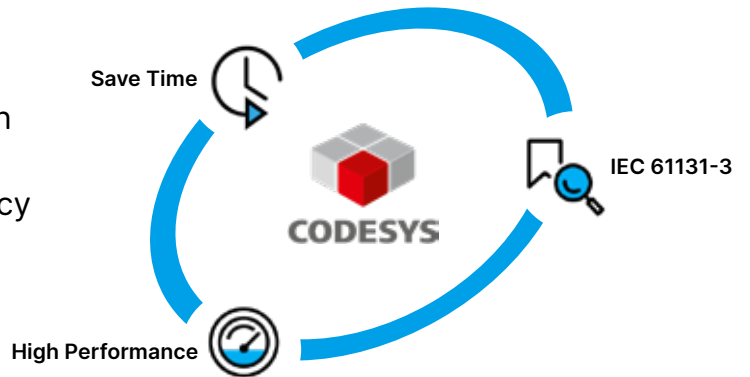

■ User-friendly programming software New

DIADesigner-AX is a new programming software for Delta AX series CPUs; it provides an optimized user-friendly programming environment and reduces programming time and effort for users

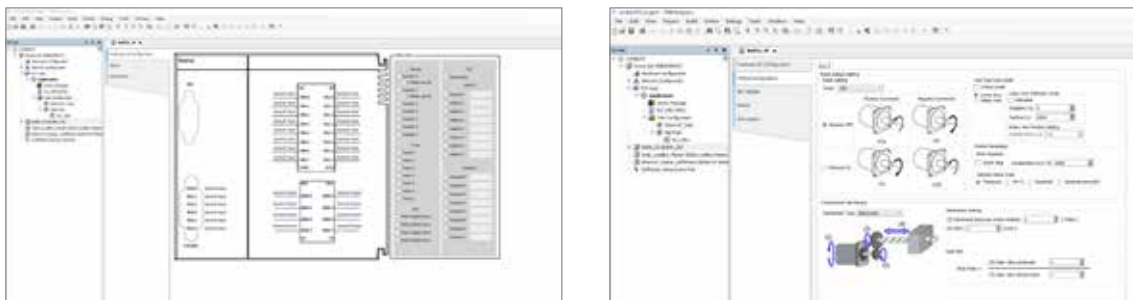

The user interface of built-in IO and axis parameter configuration

■ Highly integrated CPU design

The AX-3 motion control CPUs feature various built-in I/O and communication protocols to satisfy customer needs for compact design and high performance

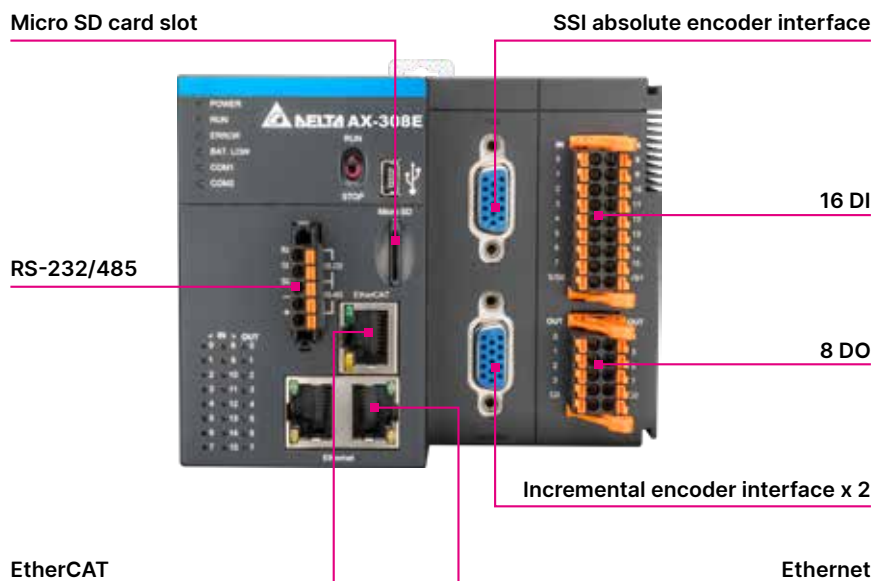

Note: Actual support functions will vary by series

Simple Installation



■ Easy installation

- Space-saving design, suitable for installation in control panels

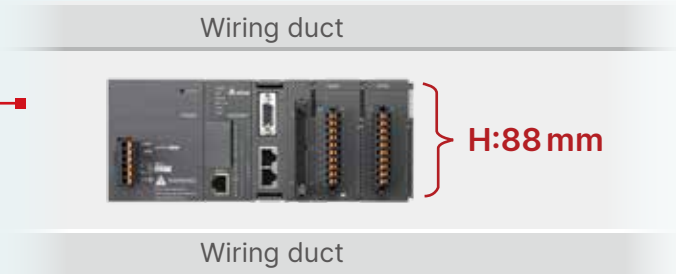
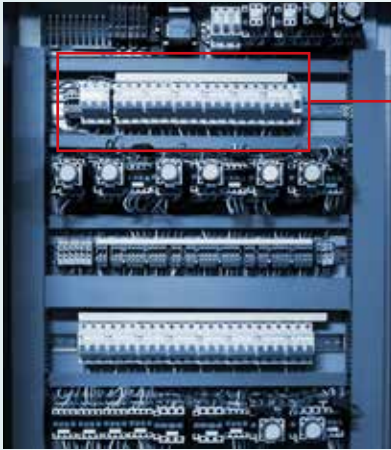

■ Rackless DIN-rail installation

▶ Robust slot and clip interlocking design

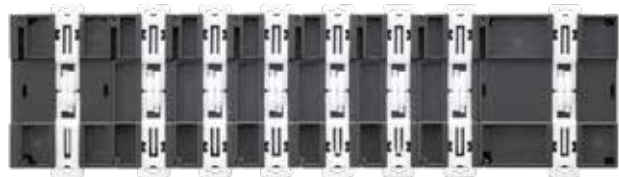

■ Fast disassembly

- Release the clip ring to easily take out the module from the front without moving adjacent modules



■ Simple installation process

- Press the clip rings and push the module to the desired position until you hear a "click" to finish installation

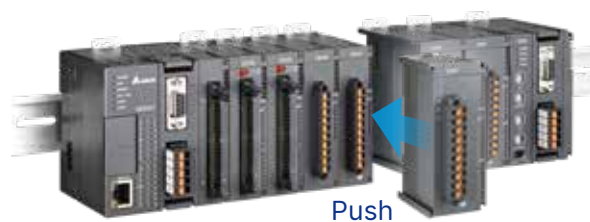

■ Convenient grounding protection

- DIN-rail installation: CPU module and expansion modules can be installed directly on DIN-rail without a backplane
- Installation with screws: pull out the installation clip ring and directly install it on the panel
- Both methods are equipped with ground protection

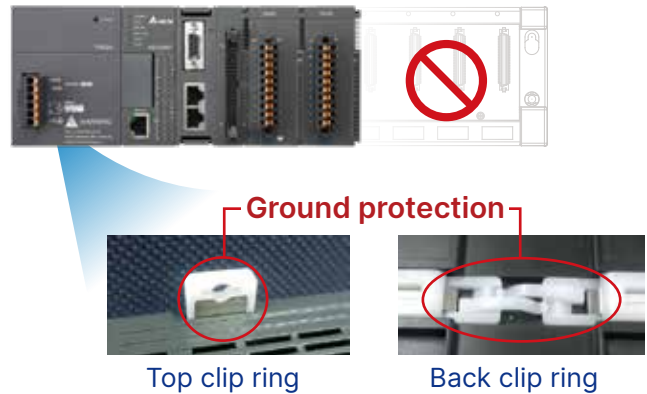

■ Screwless and time-saving installation

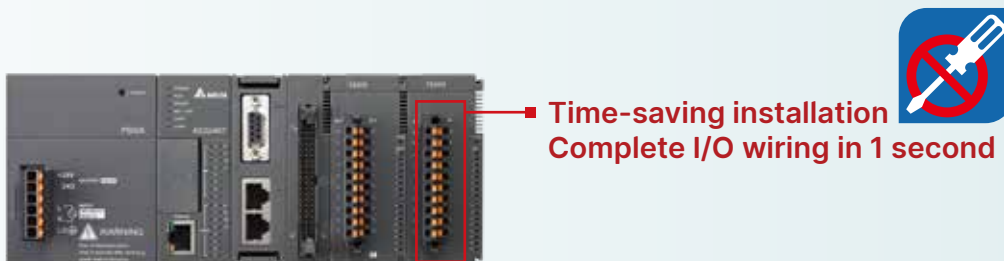

■ Robust loose-proof spring clamp terminal block

- In commonly used spring clamp terminal blocks, the clamping force is determined by the spring material, which decreases with the aging of the spring
- The AS Series adopts a full-covered spring clamp design that enhances the clamping force. When the wire is pulled-out (red arrow) and the spring moves up (green arrow), a downward force is generated (blue arrow) to clamp the wire

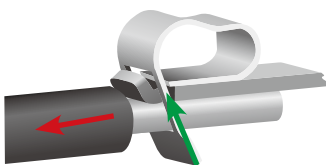

The green arrow is the clamping force, and the red arrow is the pull-out force.

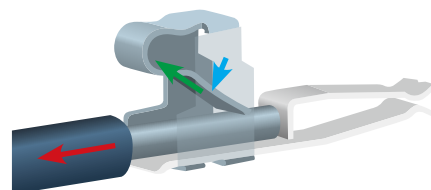

Industrial Network Solution

EtherNet/IP Solution

The open industrial Ethernet communication protocol for real-time control and data collection

EtherNet/IP

- Max. connection resource (AS300): 16 devices (adapters), 32 CIP connections
- Max. data transmission: 500 bytes/connection
- Performance: slave station data update in 1 scan time

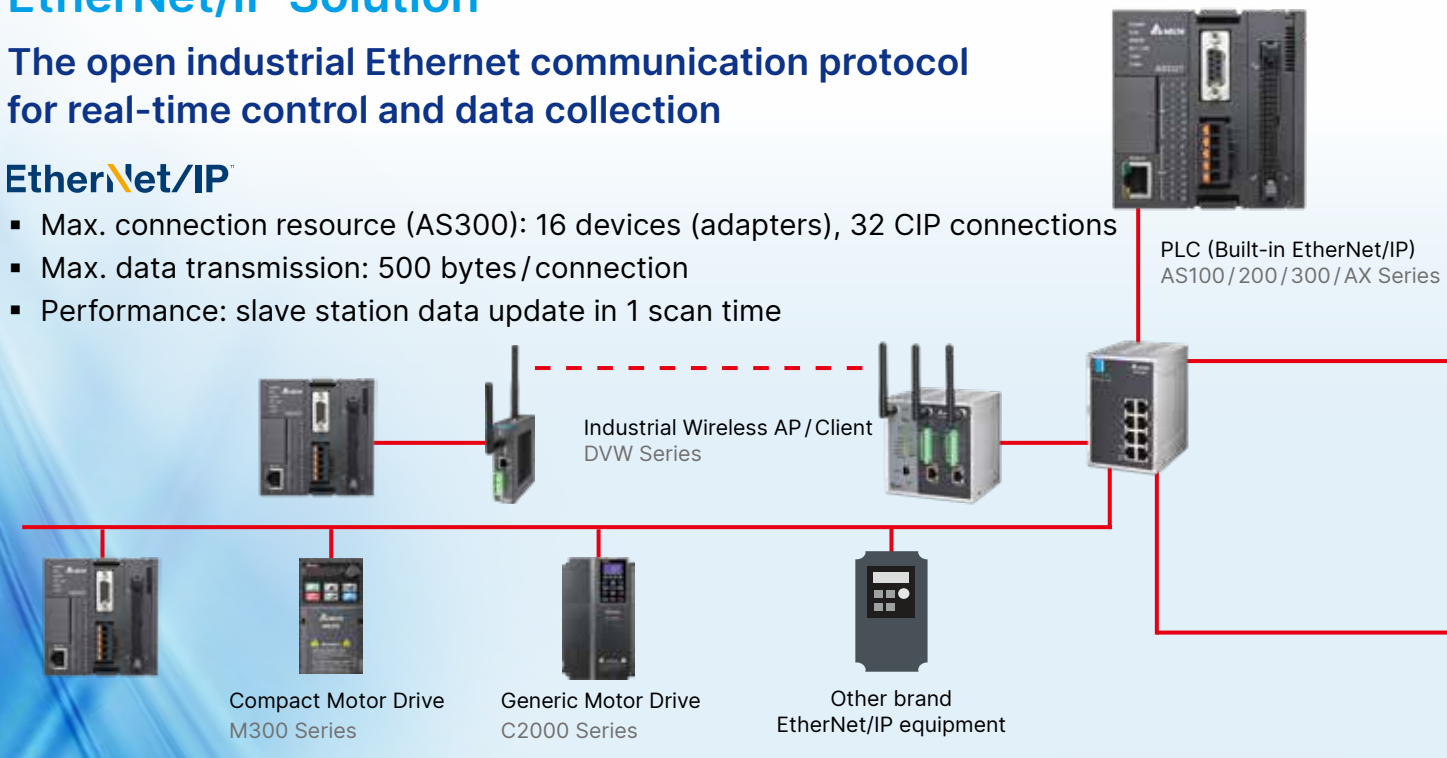

Flexible network system configuration

- Supports star, linear network topology for fast expansion and management on production lines
- Compatible with IT network, no independent network or IT technician required
- Combines with Delta IES solution to construct IoT for more automation applications and industrial 4.0 upgrades

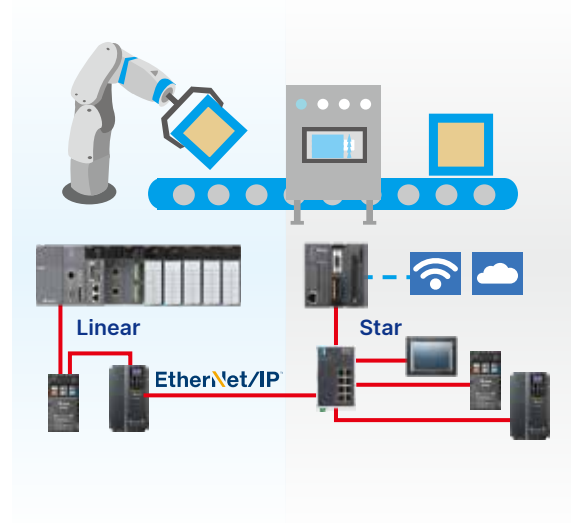

One cable, one network

- Complete Delta EtherNet/IP solution connects different equipment via Ethernet cable to simplify system networking
- Replaces traditional 3-layer industrial network structure with seamless connection via 100 MB high-speed network
- Complete industrial network diagnosis to shorten debug time

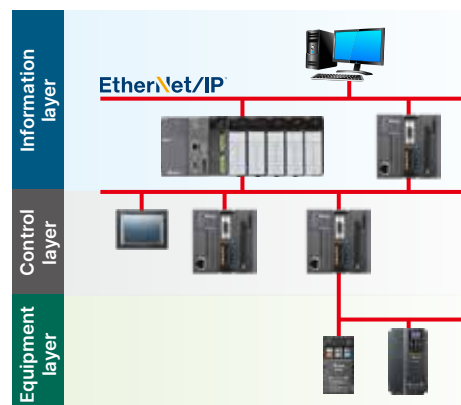

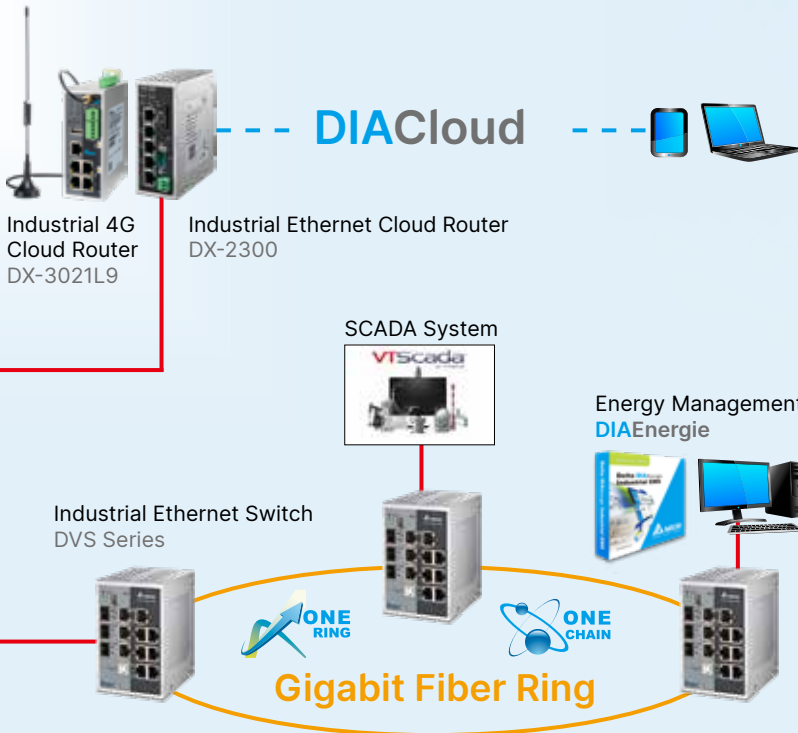

IoT & Industrial Ethernet

- DIACloud platform connection
- Redundancy ring recovery time < 20 ms
- Industrial class EMC testing

Software integration

- Consistent data exchange interface shortens learning time with fast system configuration
- Provides Delta's equipment parameter list for quick parameter matching without looking into a detailed manual
- EDS File provides quick connection with EtherNet/IP products of other brands

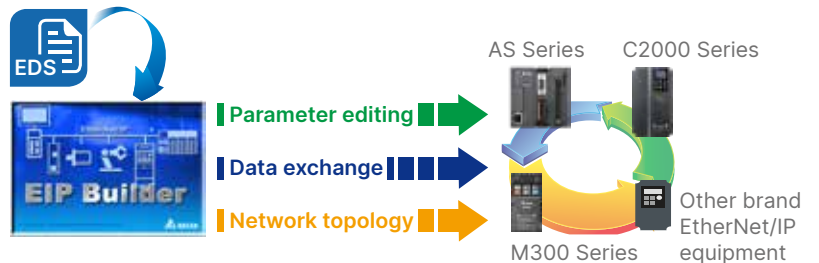

Accurate data update

- Provides real-time cyclic and acyclic data transmission and defines data priority between equipment
- Establishes multiple CIP links and defines different register priorities with one piece of equipment
- Executes data update based on user RPI. Updates all slave station data in one scan time
- Enhances stability by 70% compared to traditional Modbus TCP

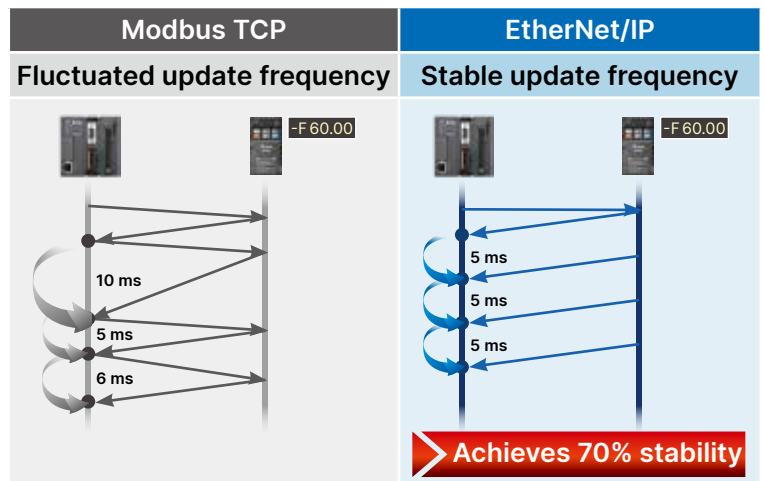

Industrial Internet of Things (IIoT) Applications

AS-FFTP01 communication card realizes various IIoT applications required by a smart machine: remote data access/visualization, connectivity to SCADA via OPC-UA, and connectivity to cloud via MQTT

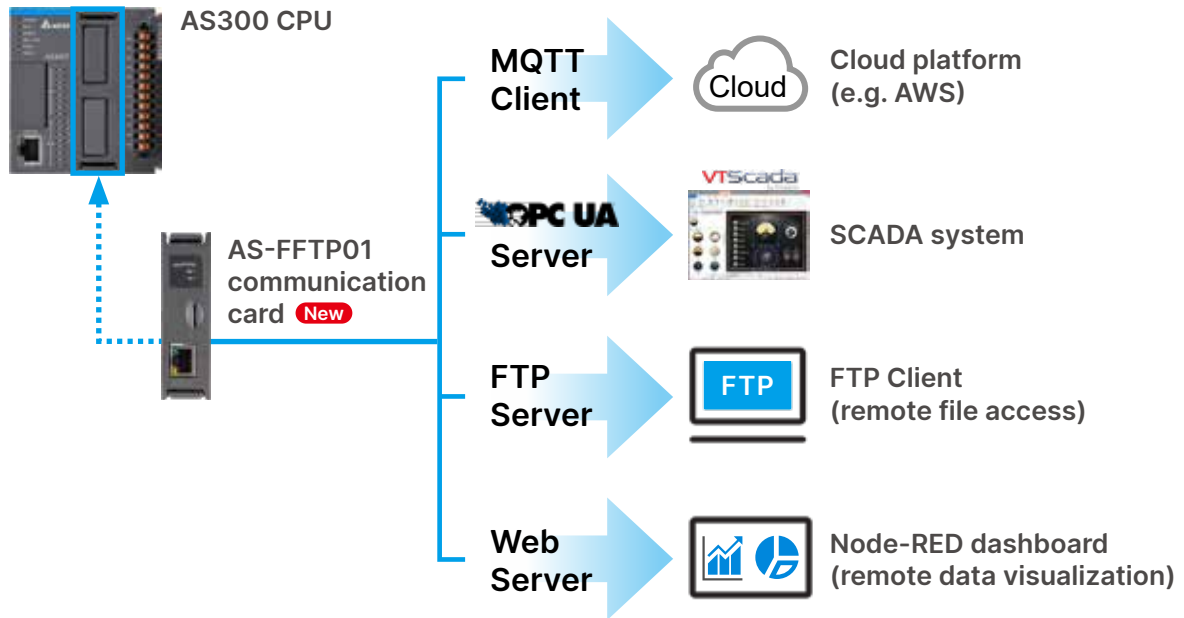

EtherCAT Point-to-Point Positioning Solution

AS-FECAT communication card provides up to 16 axes point-to-point positioning to construct EtherCAT network with Delta drives and remote I/Os



DIADesigner: EtherNet/IP

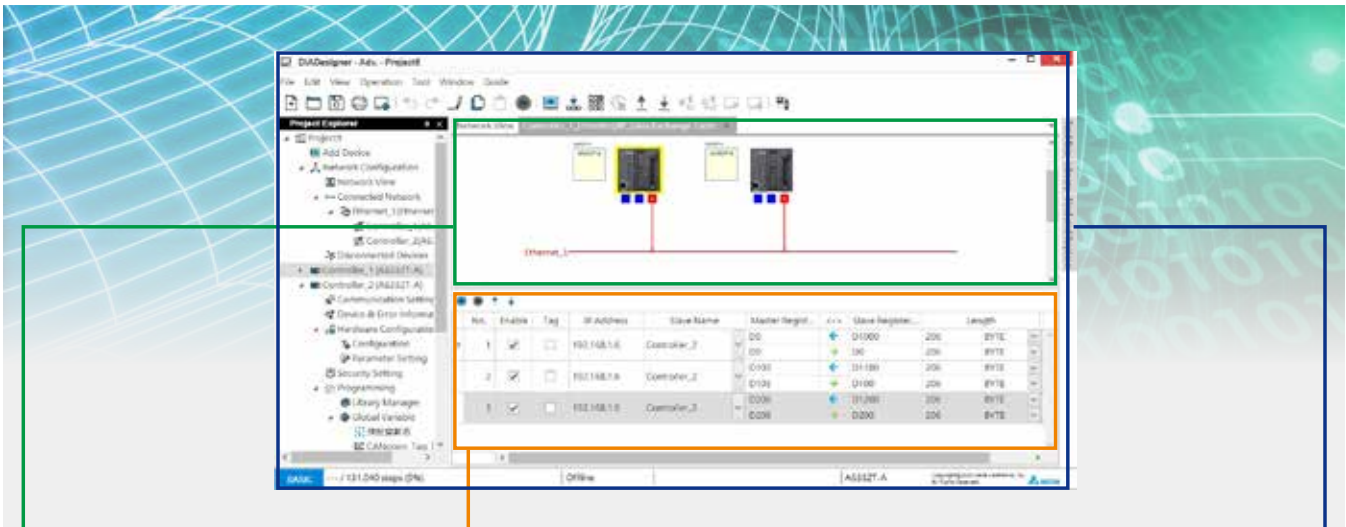

Visualized Network Mapping

- Direct network planning



Network Mapping Diagnosis

- Real-time network status and device indicators display



Parameter List

- Built-in parameter list of Delta's products



Data Exchange Table

- Data exchange via table blanks filling. PLC programming is not required

A screenshot of a data exchange table showing parameters and their values, including columns for parameter name, value, and status.

Data Input/Output Corresponding Table

- Preset data exchange on corresponding parameters
- Connecting equipment editing on corresponding parameters



Data Exchange Diagnosis

- Data exchange status and error codes



Visualized Product List

- Visualized equipment selection



Equipment Description Management Function



AS100/200/300 Remote I/O Solution

CANopen Remote I/O

- Max quantity of RIO stations: 15 stations
- Max quantity of IO modules (CPU right side + RIO (SCM) right side): 32 modules
 - Max DIO points: 1,024 points
 - Max quantity of AIO modules: 16 modules
 - Max quantity of communication modules: 4 modules (Only installed on CPU right side)
 - Max quantity of IO modules installed on RIO (SCM) right side: 8 modules
- AS-FCOPM can only be installed in slot 2 of the CPU and SCM
 - When an AS-FCOPM is installed in slot 2, slot 1 can be used to install another function card of identical size except AS-FCOPM
 - When SCM is working in RIO (RTU) mode, then slot 1 is disabled

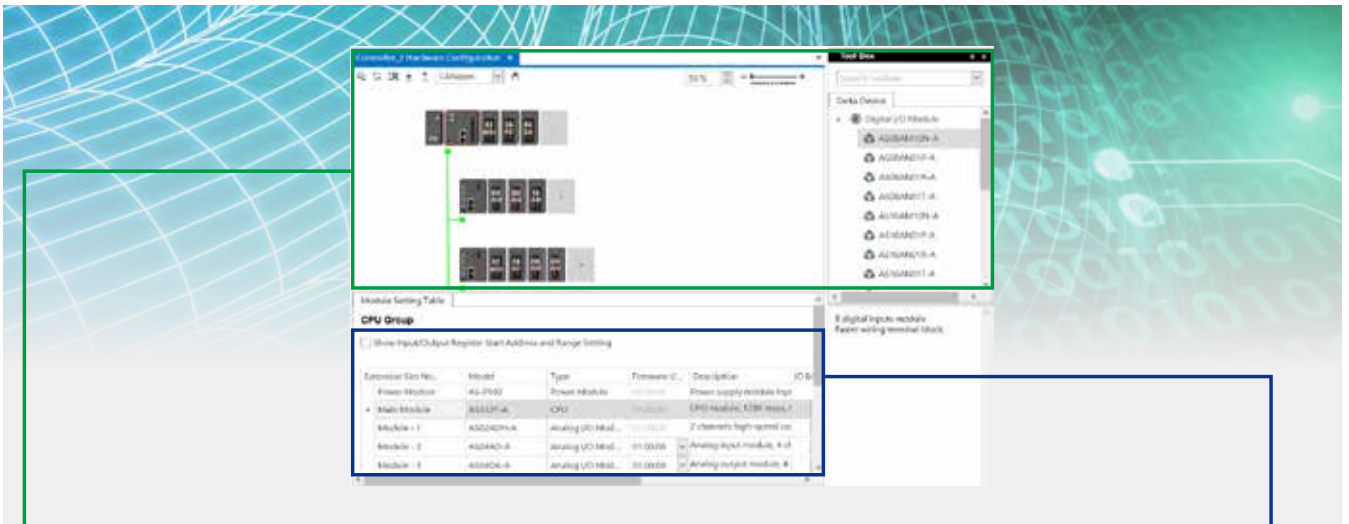
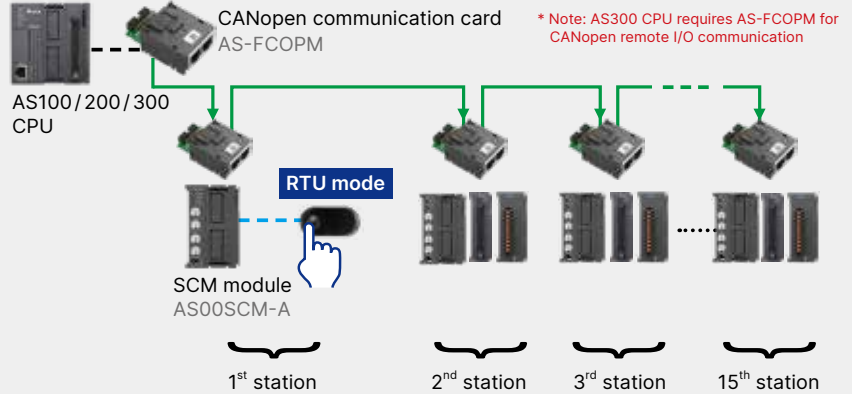

Hardware Configuration

- Hardware parameter complete planning



Visualized I/O Structure

- Direct I/O planning



I/O Product List

- Product description and specification



I/O without Planning

- Auto-mapping with I/O addresses in CPU (X, Y, and D)

Module	Type	Name	Input Connect Range	Output Connect Range	Comment
Power Module	Power Module	AS-PS00	0000 - 0000	0000 - 0000	
Function Card	Function Card	AS-FCOPM			
Main Module	AS100CPU	AS100CPU			
Module - 1	Analog I/O Module	AS100AI04	0000 - 0000	0000 - 0000	
Module - 2	Analog I/O Module	AS100AO4	0000 - 0000	0000 - 0000	
Module - 3	Analog I/O Module	AS100DI8	0000 - 0000	0000 - 0000	

Module	Type	Name	Input Connect Range	Output Connect Range	Comment
Power Module	Power Module	AS-PS00	0000 - 0000	0000 - 0000	
Function Card	Function Card	AS-FCOPM			
Main Module	AS100CPU	AS100CPU			
Module - 1	Analog I/O Module	AS100AI04	0000 - 0000	0000 - 0000	
Module - 2	Analog I/O Module	AS100AO4	0000 - 0000	0000 - 0000	
Module - 3	Analog I/O Module	AS100DI8	0000 - 0000	0000 - 0000	

Serial Communication Solution

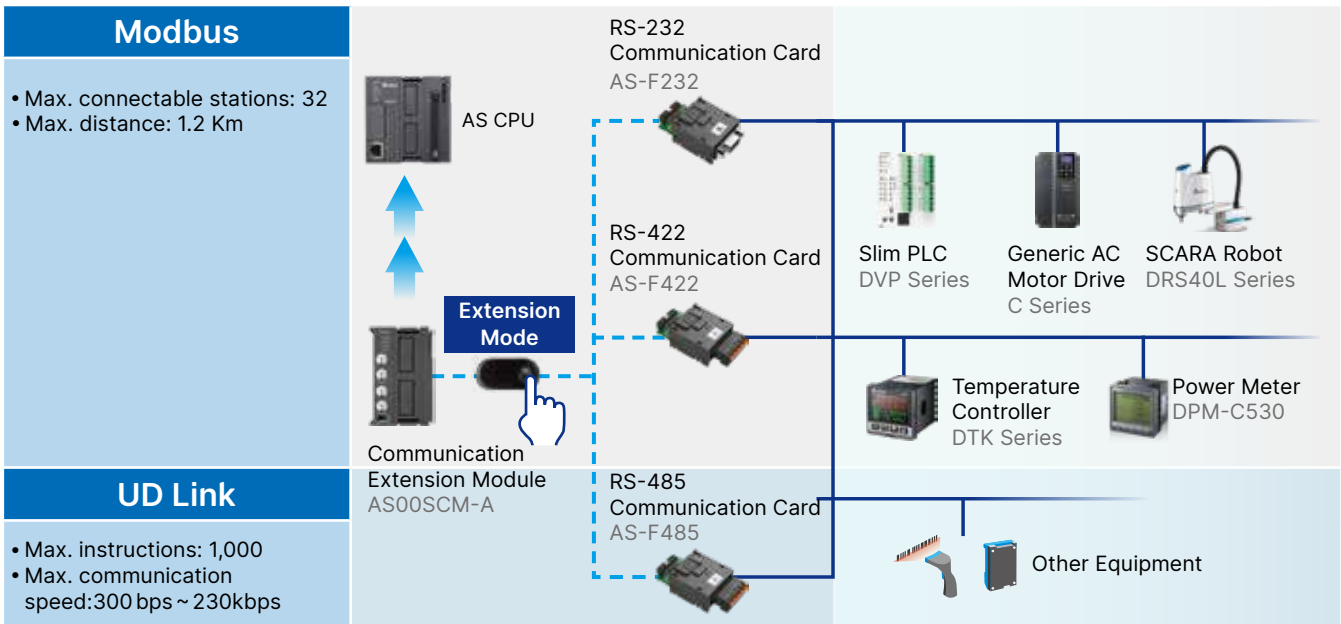

■ Modbus Mode

- Easy data exchange configuration

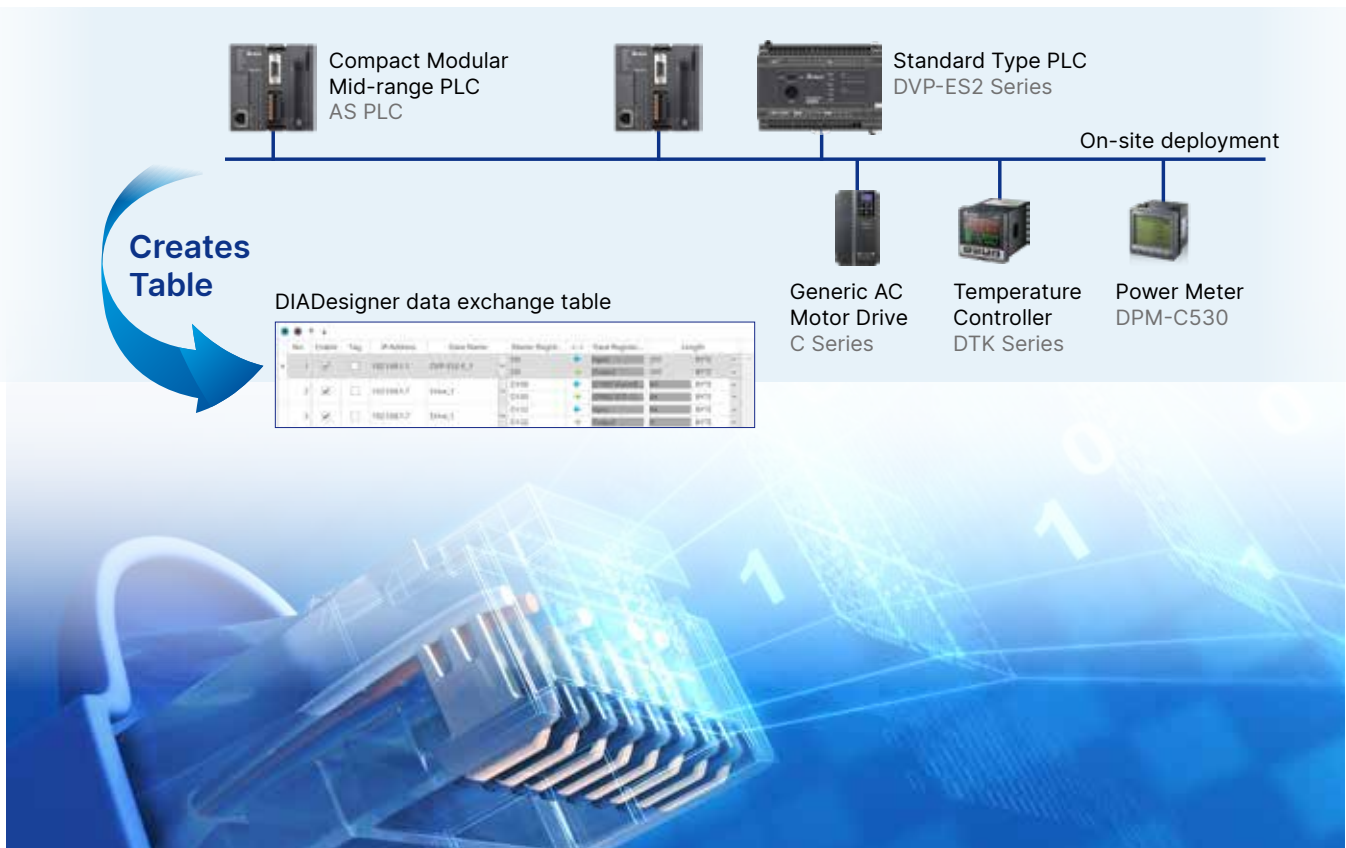

Serial Communication Solution

Real-time history log diagnosis

- AS00SCM stores 2k bytes history log; SCMSOft directly displays the log for real-time communication status monitoring with no additional monitoring software required

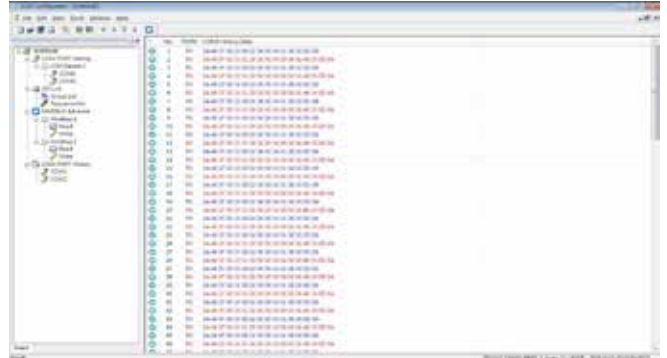

UD Link Mode (User-defined)

- Easy connection to end equipment via special communication protocols

Traditional programming structure

Instruction receiving, accessing, editing, transmitting, sequence control

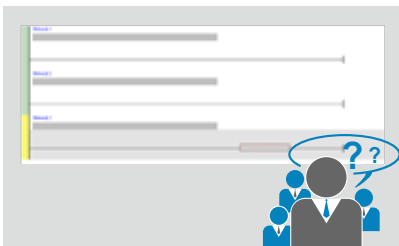

Connection to end equipment via special communication protocols

- Edits the transmitting/receiving packets via SCMSOft; format exchange and checksum calculation via AS00SCM
- Packet content auto-combination for logic control in PLC, reducing PLC program complexity
- Max. 1,000 transmitting/receiving packets

Packet No.	RX Packet Name
1	RX Packet1
2	RX Packet2
3	RX Packet3

Packet No.	TX Packet Name
1	TX Packet1
2	TX Packet2
3	TX Packet3

Packet Segment Edit

No.	Class	Format	Segment View
1	Message Constant	ASCII	"abcd"
2	Address Variable	Null	(R/D Register [4], 4)
3	Message Constant	ASCII	"efgh"

Up
Down
Delete

Command execution sequence planning

Command No.	Command Type	Send Packet	Recv Packet	Success	Fail	Retry	Repeat	Send Wait
1	Send & Receive	TX Packet1	RX Packet1	Goto : 1	Goto : 1	0	2	0
2	Send & Receive	TX Packet2	RX Packet2	Goto : 2	Goto : 1	0	3	0
3	Send & Receive	TX Packet21	RX Packet3	Goto : 3	Goto : 1	0	4	0
4	Send & Receive	TX Packet25	RX Packet4	Goto : 4	Goto : 1	0	5	0
5	Send & Receive	TX Packet28	RX Packet5	Goto : 5	Goto : 1	0	6	0

User-defined communication format editing

Programming & Diagnosis



DIADesigner IEC Programming Software

Easy operation greatly enhances efficiency

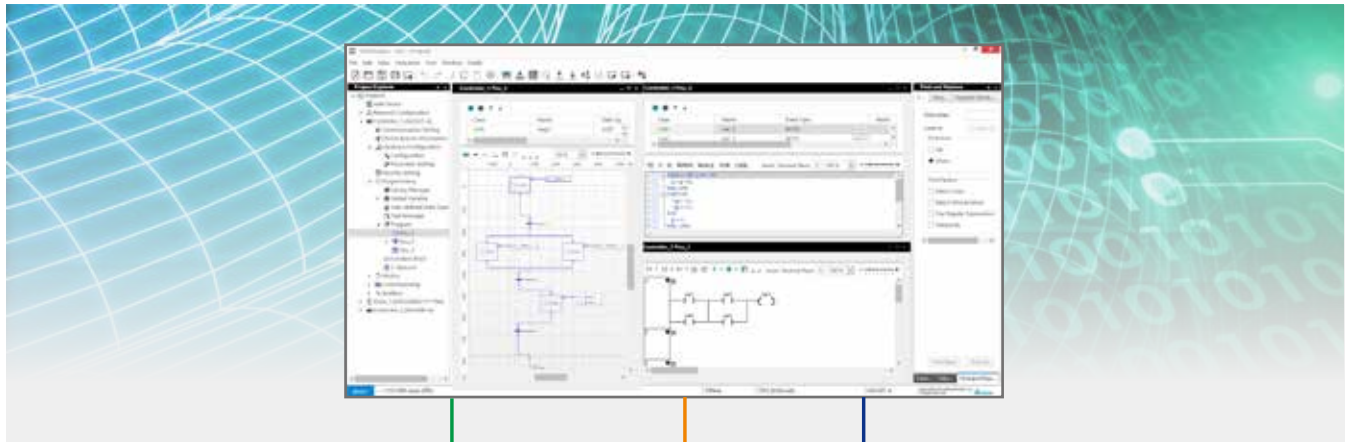

Data Tracer /Logger

- Data log and time-sequential analysis

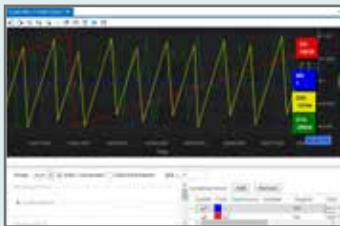

Positioning Planning Tool

- Table-structured position planning

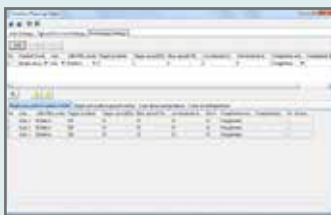

Projects for Multiple Devices

- Integrates multiple Delta products in one project

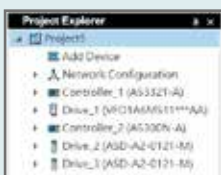

COMMGR

- Communication interface manager



AS200/300 CPU

Hardware Configuration

- Hardware configuration and parameter setting



Network Configuration

- Integrates fieldbus systems in one view, including EtherNet/IP, CANopen and Modbus



Modular Program Structure

Traditional program structure

Errors are often found in large-scale programs under a traditional structure and are hard to debug while increasing maintenance cost

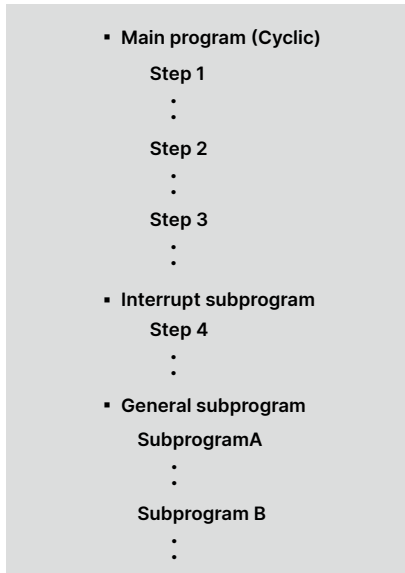

Modular program structure

Programming organization unit (POU) enables easy management in large-scale programs with high development efficiency

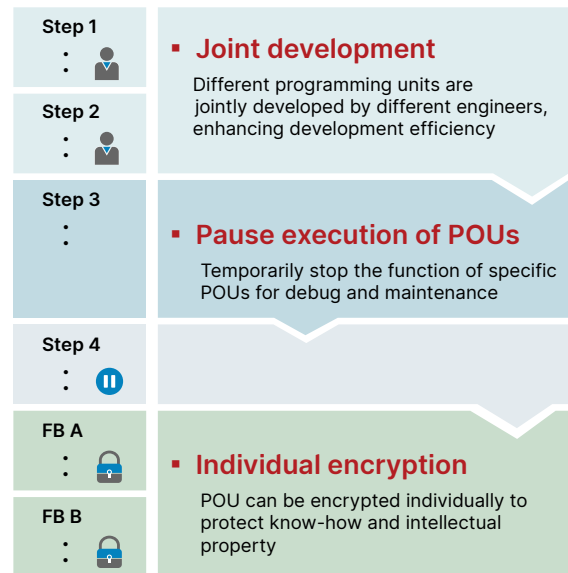

Modular Program Structure

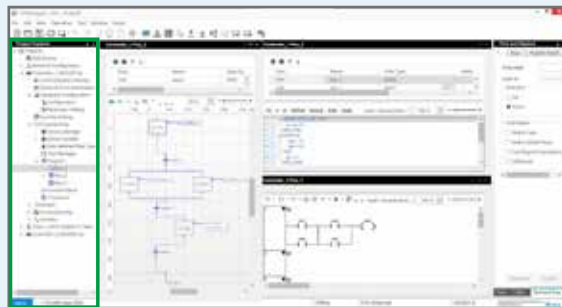

Interface display of task manager

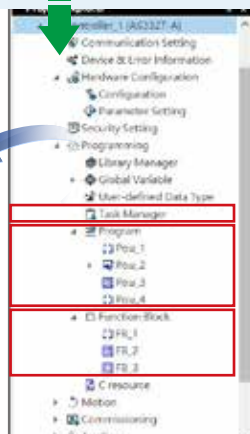

- Task manager**
 Plans the execution sequence of POUs and defines the nature of the tasks (cyclical or interruptive)
- POU management**
 Manages all POUs via a project tree and supports POU import/export for joint development or other uses
- User library**
 Various built-in Delta-developed FBs for users to choose and add to their library for quick use

Note: Actual support functions will vary by series

Convenient Programming

User-defined data type

In addition to basic data types, users can define structures and enumerations for flexible programming

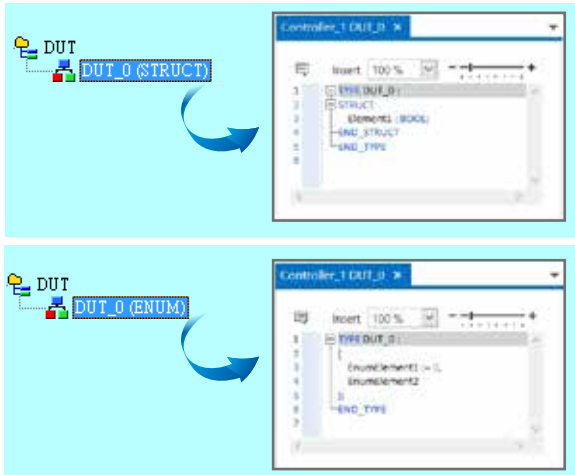

On-line programming / update

Supports program editing in monitoring mode and program updates during equipment operation for convenient debugging and maintenance



Debugging mode

Supports breakpoints, single step execution and other functions to enhance debugging efficiency

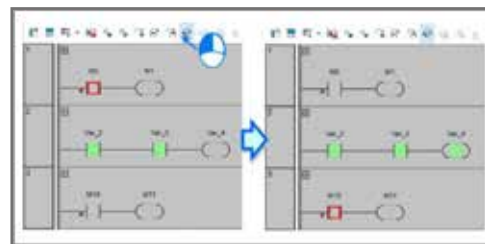

Multiple Programming Languages

Supports multiple programming languages in the same project

Ladder Diagram (LD)

DIADesigner provides a programming interface with the widely used LD language for faster programming

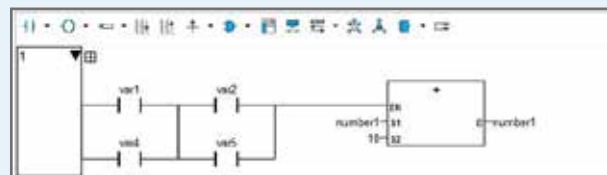

Structured Text (ST), C Language

Similar programming method to advanced programming language. It provides more convenient editing for complicated expression



Sequential Function Chart (SFC)

Direct and easy expression for the steps in flow charts, suitable for applications that require process control



Note: Actual support functions will vary by series

Easy Hardware Configuration and Parameter Setting

Hardware Configuration

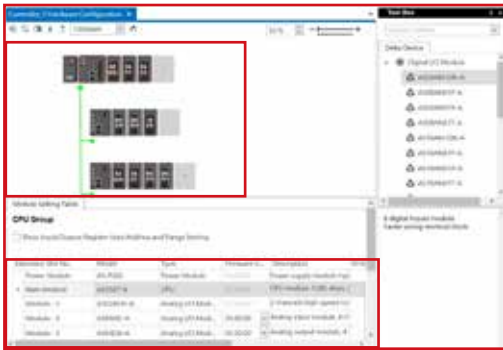

- **Graphic panel for module configuration**

Quick setup with automatic configuration imported by barcode scanning

- **I/O listing**

Direct display for corresponding device addresses after configuration



- **Parameter setting**

Fast parameter setting on controller and modules without manual reference or programming

Note: Fill the table to configure module parameters quickly. From/To instruction is not required for module initialization.

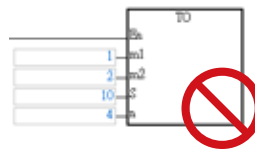

- **Module configuration method**

- **Smart module configuration**

Supports an advanced planning tool for a variety of network modules

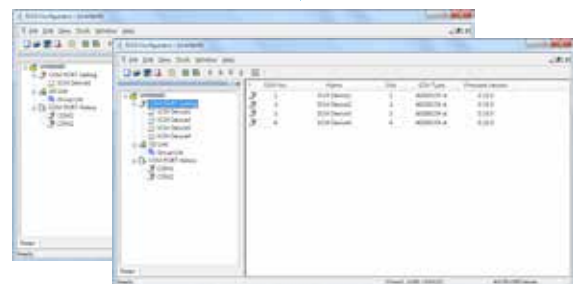
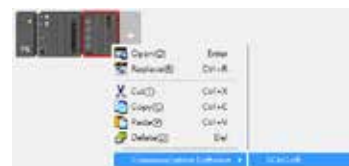
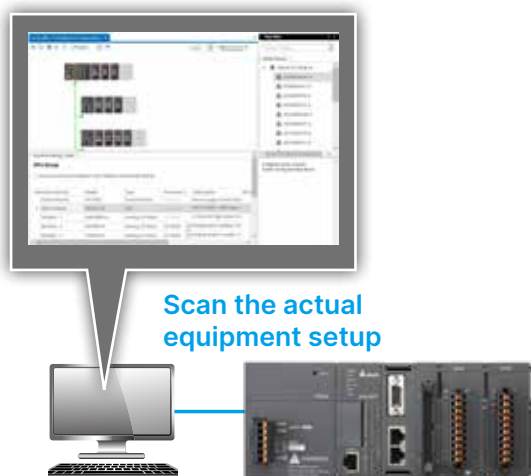

Note: Actual support functions will vary by series

Complete Diagnosis Tools for Quick and Effective System Monitoring

Data Logger / Tracer

- **Real-time monitoring:**
High-speed tracer for fast sampling within 1 scanning cycle
- **Stable logging:**
Long-time data logger savings of up to 32,768 data records, which can be transferred to SD card
- **Precise data acquisition:**
Supports a variety of sampling intervals and trigger modes
- **Convenient comparison:**
Multiple data logs in various data formats can be recorded at the same time for comparison
- **Efficient data analysis:**
Supports trend display, scaling, arrangement, merge and measurement

- Real-time
- Stable
- Precise

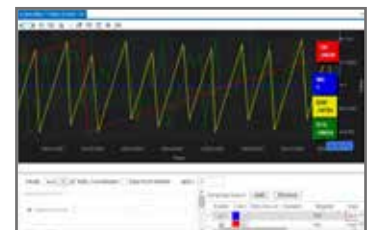

Real-time Module Monitoring

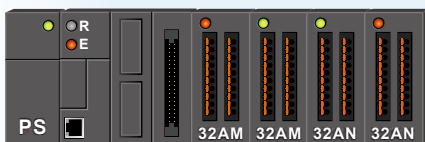

- **Visualized monitoring**
Direct monitoring interface provides real-time status on modules via LED indicators
- **Module comparison**
Real-time inspection of actual module settings to ensure consistency
- **Error logs**
Immediate inquiry for error messages and logs of anomalies
- **Module information**
Provides model name and version of current modules

Time	Module Name	Message	Status
2018-01-01 00:00:00	32AM	Power supply voltage is low	Warning
2018-01-01 00:00:01	32AM	Temperature of module is high	Warning
2018-01-01 00:00:02	32AN	Communication error with module	Error
2018-01-01 00:00:03	32AN	Module firmware update failed	Error
2018-01-01 00:00:04	32AM	Module settings changed	Info
2018-01-01 00:00:05	32AN	Module settings changed	Info
2018-01-01 00:00:06	32AM	Module settings changed	Info
2018-01-01 00:00:07	32AN	Module settings changed	Info
2018-01-01 00:00:08	32AM	Module settings changed	Info
2018-01-01 00:00:09	32AN	Module settings changed	Info
2018-01-01 00:00:10	32AM	Module settings changed	Info
2018-01-01 00:00:11	32AN	Module settings changed	Info
2018-01-01 00:00:12	32AM	Module settings changed	Info
2018-01-01 00:00:13	32AN	Module settings changed	Info
2018-01-01 00:00:14	32AM	Module settings changed	Info
2018-01-01 00:00:15	32AN	Module settings changed	Info
2018-01-01 00:00:16	32AM	Module settings changed	Info
2018-01-01 00:00:17	32AN	Module settings changed	Info
2018-01-01 00:00:18	32AM	Module settings changed	Info
2018-01-01 00:00:19	32AN	Module settings changed	Info
2018-01-01 00:00:20	32AM	Module settings changed	Info
2018-01-01 00:00:21	32AN	Module settings changed	Info
2018-01-01 00:00:22	32AM	Module settings changed	Info
2018-01-01 00:00:23	32AN	Module settings changed	Info
2018-01-01 00:00:24	32AM	Module settings changed	Info
2018-01-01 00:00:25	32AN	Module settings changed	Info
2018-01-01 00:00:26	32AM	Module settings changed	Info
2018-01-01 00:00:27	32AN	Module settings changed	Info
2018-01-01 00:00:28	32AM	Module settings changed	Info
2018-01-01 00:00:29	32AN	Module settings changed	Info
2018-01-01 00:00:30	32AM	Module settings changed	Info
2018-01-01 00:00:31	32AN	Module settings changed	Info
2018-01-01 00:00:32	32AM	Module settings changed	Info
2018-01-01 00:00:33	32AN	Module settings changed	Info
2018-01-01 00:00:34	32AM	Module settings changed	Info
2018-01-01 00:00:35	32AN	Module settings changed	Info
2018-01-01 00:00:36	32AM	Module settings changed	Info
2018-01-01 00:00:37	32AN	Module settings changed	Info
2018-01-01 00:00:38	32AM	Module settings changed	Info
2018-01-01 00:00:39	32AN	Module settings changed	Info
2018-01-01 00:00:40	32AM	Module settings changed	Info
2018-01-01 00:00:41	32AN	Module settings changed	Info
2018-01-01 00:00:42	32AM	Module settings changed	Info
2018-01-01 00:00:43	32AN	Module settings changed	Info
2018-01-01 00:00:44	32AM	Module settings changed	Info
2018-01-01 00:00:45	32AN	Module settings changed	Info
2018-01-01 00:00:46	32AM	Module settings changed	Info
2018-01-01 00:00:47	32AN	Module settings changed	Info
2018-01-01 00:00:48	32AM	Module settings changed	Info
2018-01-01 00:00:49	32AN	Module settings changed	Info
2018-01-01 00:00:50	32AM	Module settings changed	Info
2018-01-01 00:00:51	32AN	Module settings changed	Info
2018-01-01 00:00:52	32AM	Module settings changed	Info
2018-01-01 00:00:53	32AN	Module settings changed	Info
2018-01-01 00:00:54	32AM	Module settings changed	Info
2018-01-01 00:00:55	32AN	Module settings changed	Info
2018-01-01 00:00:56	32AM	Module settings changed	Info
2018-01-01 00:00:57	32AN	Module settings changed	Info
2018-01-01 00:00:58	32AM	Module settings changed	Info
2018-01-01 00:00:59	32AN	Module settings changed	Info
2018-01-01 00:01:00	32AM	Module settings changed	Info
2018-01-01 00:01:01	32AN	Module settings changed	Info
2018-01-01 00:01:02	32AM	Module settings changed	Info
2018-01-01 00:01:03	32AN	Module settings changed	Info
2018-01-01 00:01:04	32AM	Module settings changed	Info
2018-01-01 00:01:05	32AN	Module settings changed	Info
2018-01-01 00:01:06	32AM	Module settings changed	Info
2018-01-01 00:01:07	32AN	Module settings changed	Info
2018-01-01 00:01:08	32AM	Module settings changed	Info
2018-01-01 00:01:09	32AN	Module settings changed	Info
2018-01-01 00:01:10	32AM	Module settings changed	Info
2018-01-01 00:01:11	32AN	Module settings changed	Info
2018-01-01 00:01:12	32AM	Module settings changed	Info
2018-01-01 00:01:13	32AN	Module settings changed	Info
2018-01-01 00:01:14	32AM	Module settings changed	Info
2018-01-01 00:01:15	32AN	Module settings changed	Info
2018-01-01 00:01:16	32AM	Module settings changed	Info
2018-01-01 00:01:17	32AN	Module settings changed	Info
2018-01-01 00:01:18	32AM	Module settings changed	Info
2018-01-01 00:01:19	32AN	Module settings changed	Info
2018-01-01 00:01:20	32AM	Module settings changed	Info
2018-01-01 00:01:21	32AN	Module settings changed	Info
2018-01-01 00:01:22	32AM	Module settings changed	Info
2018-01-01 00:01:23	32AN	Module settings changed	Info
2018-01-01 00:01:24	32AM	Module settings changed	Info
2018-01-01 00:01:25	32AN	Module settings changed	Info
2018-01-01 00:01:26	32AM	Module settings changed	Info
2018-01-01 00:01:27	32AN	Module settings changed	Info
2018-01-01 00:01:28	32AM	Module settings changed	Info
2018-01-01 00:01:29	32AN	Module settings changed	Info
2018-01-01 00:01:30	32AM	Module settings changed	Info
2018-01-01 00:01:31	32AN	Module settings changed	Info
2018-01-01 00:01:32	32AM	Module settings changed	Info
2018-01-01 00:01:33	32AN	Module settings changed	Info
2018-01-01 00:01:34	32AM	Module settings changed	Info
2018-01-01 00:01:35	32AN	Module settings changed	Info
2018-01-01 00:01:36	32AM	Module settings changed	Info
2018-01-01 00:01:37	32AN	Module settings changed	Info
2018-01-01 00:01:38	32AM	Module settings changed	Info
2018-01-01 00:01:39	32AN	Module settings changed	Info
2018-01-01 00:01:40	32AM	Module settings changed	Info
2018-01-01 00:01:41	32AN	Module settings changed	Info
2018-01-01 00:01:42	32AM	Module settings changed	Info
2018-01-01 00:01:43	32AN	Module settings changed	Info
2018-01-01 00:01:44	32AM	Module settings changed	Info
2018-01-01 00:01:45	32AN	Module settings changed	Info
2018-01-01 00:01:46	32AM	Module settings changed	Info
2018-01-01 00:01:47	32AN	Module settings changed	Info
2018-01-01 00:01:48	32AM	Module settings changed	Info
2018-01-01 00:01:49	32AN	Module settings changed	Info
2018-01-01 00:01:50	32AM	Module settings changed	Info
2018-01-01 00:01:51	32AN	Module settings changed	Info
2018-01-01 00:01:52	32AM	Module settings changed	Info
2018-01-01 00:01:53	32AN	Module settings changed	Info
2018-01-01 00:01:54	32AM	Module settings changed	Info
2018-01-01 00:01:55	32AN	Module settings changed	Info
2018-01-01 00:01:56	32AM	Module settings changed	Info
2018-01-01 00:01:57	32AN	Module settings changed	Info
2018-01-01 00:01:58	32AM	Module settings changed	Info
2018-01-01 00:01:59	32AN	Module settings changed	Info
2018-01-01 00:02:00	32AM	Module settings changed	Info

Note: Actual support functions will vary by series

Convenient Software Wizards for Effortless Planning

(AS200/300 series only)

Positioning planning table

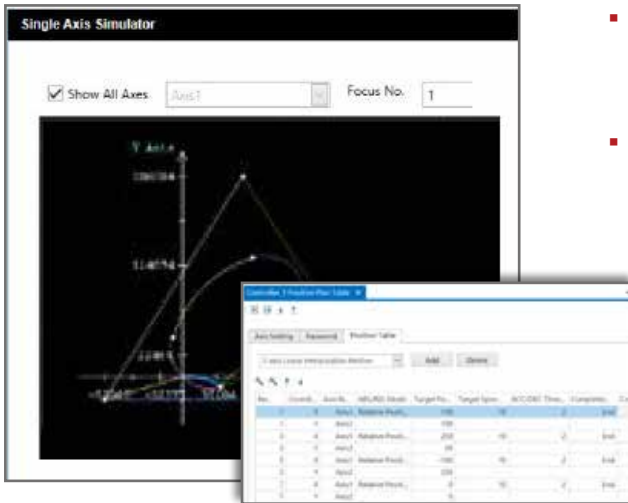

- **2D simulation**
Intuitive 2D track simulation without complicated calculation for real-time path planning
- **Path list**
Multiple combinations for positioning modes and tracks; fast path planning via table-structured planning
- **Axis parameter setting**
Intuitive configuration interface for easy axis parameter setting without manual reference

High-speed counter setting tool

- Counter index will display corresponding contact point, device and counter specification under counting mode
- Fast planning without manual reference for enhanced development efficiency



Multiple devices in one project

Integrates multiple Delta products and allows configuration and downloading in batches

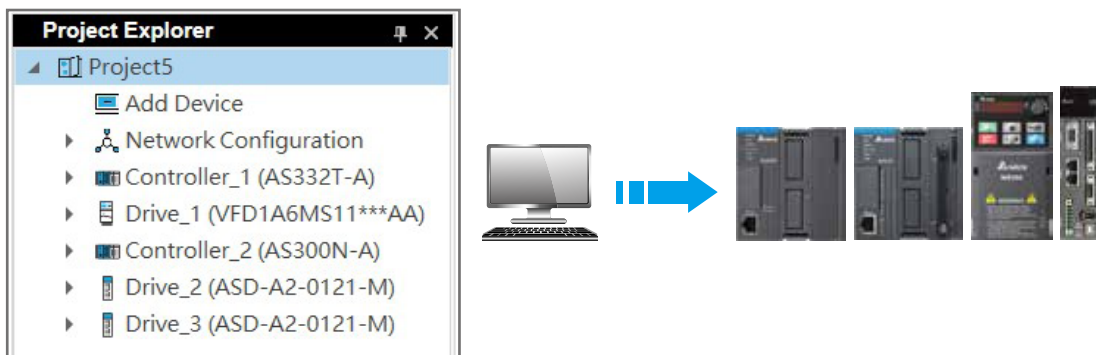

Note: Actual support functions will vary by series

Multiple Security Protection for Programs and Data

■ Security: provides 6 types of program protection for data safety

- 16-digit password protection on main program
- 16-digit password protection on FBs
- Access denial mechanism on error login
- Data upload protection function
- Verification between Project (Programming ID) and CPU (PLC ID)

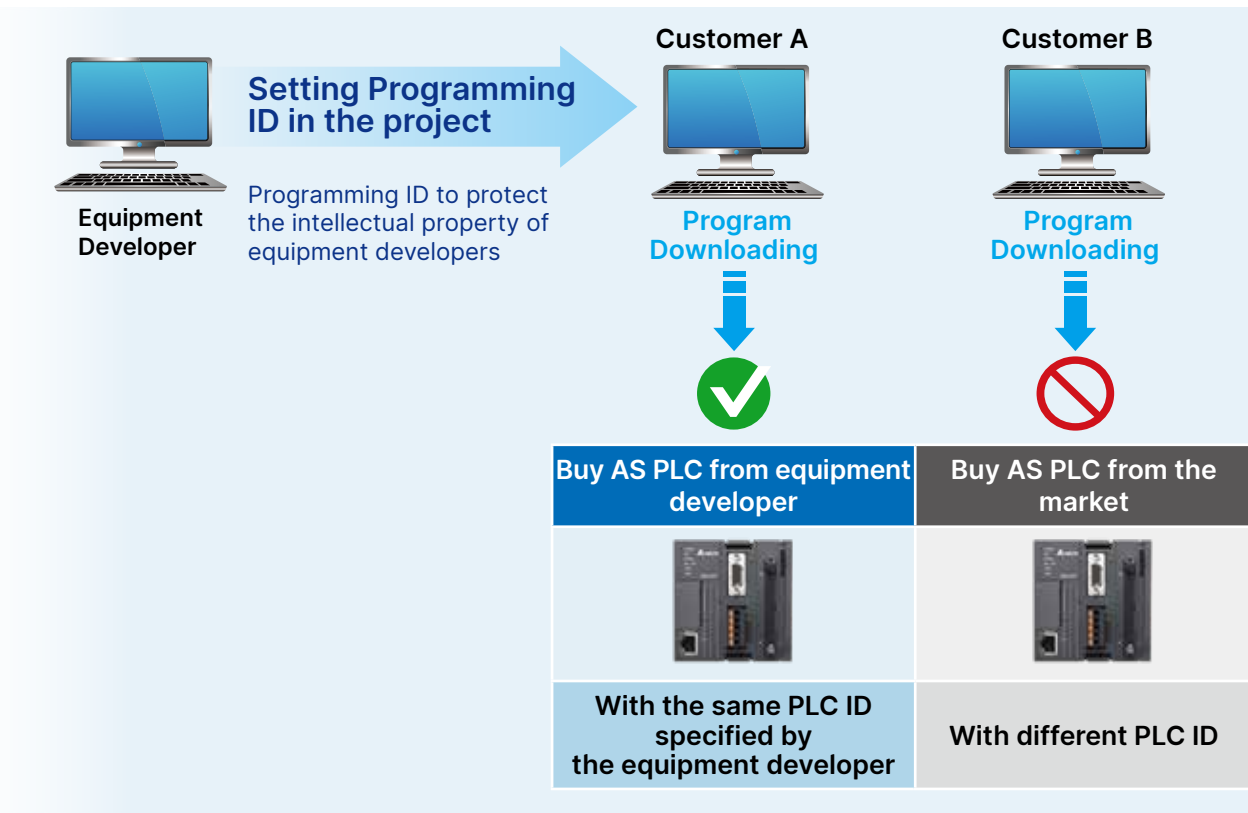

- Prevents direct copy from IC (AS200/300 series only)



Note: Actual support functions will vary by series

Model Name Explanation

CPUs

AS332T-A

AS	3	32		T		-	A
Series	Model	IO Pts. / Axis Qty.		Output Type / Motion Network			Type
	3: 300 2: 200 1: 100 5: 500 (Motion)	【100/200/300 CPU】 00: None 18: 18 pts. 20: 20 pts. 24: 24 pts. 28: 28 pts. 32: 32 pts. 48: 48 pts. 64: 64 pts.	【500 CPU】 16: 16 axes 24: 24 axes 32: 32 axes 64: 64 axes	【100/200/300 CPU】 N: None T: NPN P: PNP R: Relay MT: NPN+Diff.	【500 CPU】 C: CANopen, NPN E: EtherCAT, NPN EST: EtherCAT (P2P), NPN	【300/500 CPU】 A: HDC terminal B: EU terminal	【100/200 CPU】 A: Basic

AX-308EA0MA1T

AX-3	08	E	A0	MA1	T
Series	IO Pts. / Axis Qty.	Motion Network	CPU Spec.	SYS Spec.	Output Type
CODESYS	【Logical】 00: None 24: 24 pts. 【Motion】 04: 4 axes 08: 8 axes 16: 16 axes 32: 32 axes 64: 64 axes	E: EtherCAT EL: EtherCAT (P2P) N: None	Ax: Arm based, single core Px: x86 based, single core	(For internal use)	T: NPN P: PNP

Digital I/O Modules

AS08AM10N-A

AS	08	AM	1	0	N	-	A
Series	IO Pts.	Classification	Function		Output type		Type
	08: 8 Pts. 16: 16 Pts. 32: 32 Pts. 64: 64 Pts.	AM: Digital input AN: Digital output AP: Digital input/output	0: No input 1: DC input (24V)	0: No output 1: 0.5A transistor / 2A relay output 2: 0.1A transistor output	N: No output T: NPN P: PNP R: Relay		A: Basic

Analog I/O Modules

AS04AD-A

AS	04	AD	-	A
Series	IO Channels	Classification		Type
	02: 2-channel 04: 4-channel 06: 6-channel 08: 8-channel	AD: Analog input ADH: high speed analog input DA: Analog output XA: Analog input/output		A: Voltage/Current B: Voltage C: Current

Temperature & Load Cell Modules

AS04RTD-A

AS	04	RTD	-	A
Series	IO Channels	Classification		Type
	02: 2-channel 04: 4-channel 06: 6-channel 08: 8-channel	RTD: Platinum resistance thermometer TC: Thermocouple LC: Load cell		A: Basic

Function Cards

AS-F232

AS	-	F	232	
Series		Classification	Function	
		F: Function card	232: RS-232 422: RS-422 485: RS-485 COPM: CANopen 2AD: 2-channel analog input 2DA: 2-channel analog output	EN02: Ethernet PFN02: PROFINET OPC02: OPC UA FTP01: IIoT ECAT: EtherCAT

Positioning & High Speed Counter Modules

AS02PU-A

AS	02	PU	-	A
Series	IO Channels	Classification		Type
	02: 2-channel 04: 4-channel	HC: High-speed counter PU: Pulse-train output		A: Basic

Communication Modules

AS00SCM-A

AS	00	SCM	-	A
Series	Function	Classification		Function
	00: Basement 01: Basic 04: 4-CH	SCM: Serial DNET: DeviceNet SIL: IO-Link		A: Basic

Power Supply Modules

AS-PS02

AS	-	PS	02
Series		Classification	Function
		PS: Power supply	02: AC Input (100~240V) 02A: AC Input (100~240V) + DC Output (24V, 0.5A) 03C: AC input (100~240V) + DC output (24V, 3A) + RS-485

Product Models and Specifications

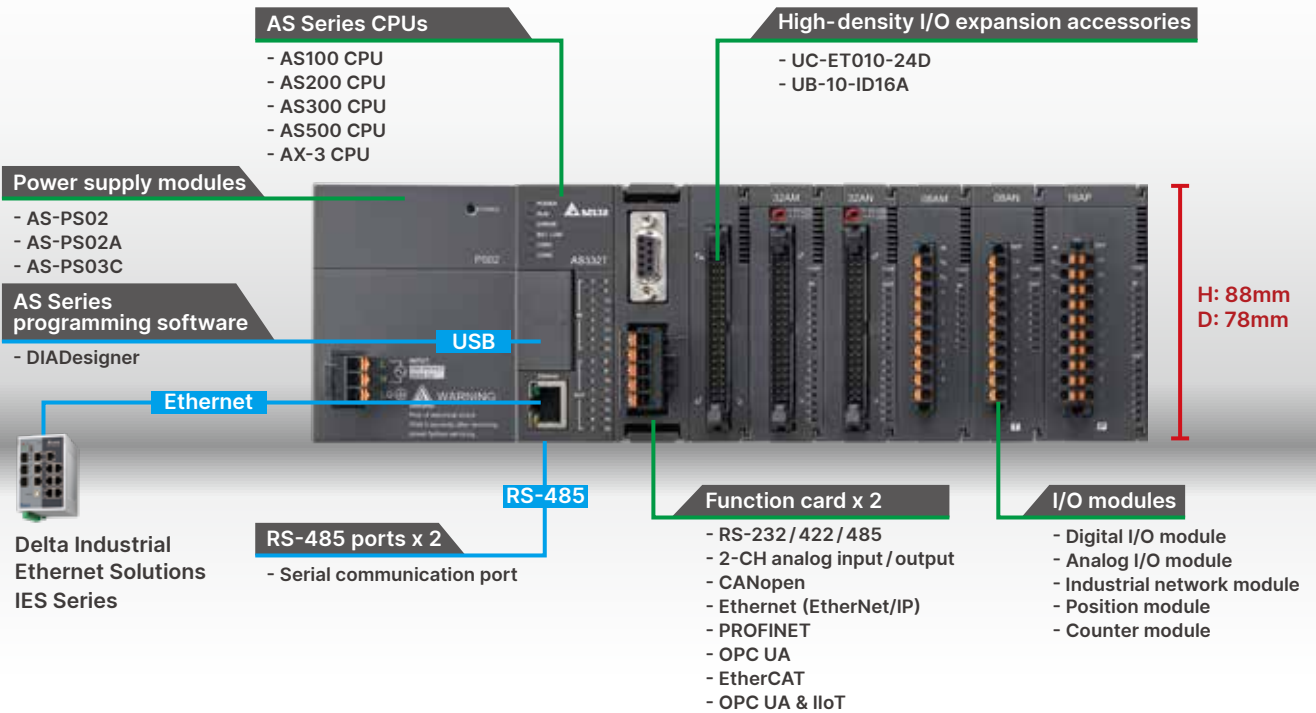

CPUs

AS500 CPUs



AS500 Series CPU Standard Specifications			
Program capacity 20MB	1GHz CPU	Expansion modules: 32	
USB/ RS-232 / 485 / Ethernet / CANopen	Micro SD Card	EtherNet/IP, Modbus CANopen	Advanced motion control
Model	Built-in I/O	Incremental Encoder	SSI Absolute Encoder
AS516E-B / AS524C-B AS532EST-B / AS564EST-B	16DI / 8DO	2 CHs	1 CH

AS300 CPUs



AS300 Series CPU Standard Specifications			
(*1: Needs CANopen function card; *2: Not supported by relay output models)			
Program capacity 128k steps	Basic instruction 25 ns	Real I/O capability: 1,024 pts Expansion modules: 32	
USB / RS-485 x 2 / EtherNet	Micro SD Card	Function card x 2	EtherNet/IP Modbus CANopen remote I/O ^(*) CANopen DS301 Position Control ^(*)
Model	Built-in I/O	High-speed Output ^(*)	High-speed Input
AS332T-A, AS332P-A	16 DI / 16 DO	6 axes 200 kHz pulse output	6 channels 200 kHz high-speed counters
AS324MT-A (Differential)	12 DI / 12 DO	2 axes 4 MHz + 4 axes 200 kHz pulse output	2 channels 4 MHz + 4 channels 200 kHz high-speed counters
AS320T-B / AS320P-B	8 DI / 12 DO	6 axes 200 kHz pulse output	4 channels 200 kHz high-speed counters
AS300N-A	-	-	-

CPUs

AS100 New / 200 CPUs



AS100/200 Series CPU Standard Specifications (*1: Not supported by relay output models)			
Program capacity 64k steps	Basic instruction 25 ns	Real I/O capability: 1,024 pts Expansion modules: 32	
USB/RS-485 x 2 / EtherNet/CANopen	Micro SD Card	EtherNet/IP, Modbus CANopen remote I/O	CANopen DS301 Position Control
Model	Built-in I/O	High-speed Output ^(*1)	High-speed Input
AS132T-A/AS132P-A/ AS132R-A/AS148T-A/ AS148P-A/AS148R-A/ AS164T-A/AS164P-A/ AS164R-A	AS132: 16DI/16DO AS148: 24DI/24DO AS164: 32DI/32DO	6 axes 200kHz pulse output	4 channels 200 kHz high-speed counters
AS228T-A/AS228P-A/ AS228R-A	16 DI/12 DO	6 axes 200kHz pulse output	4 channels 200 kHz high-speed counters
AS218TX-A/AS218PX-A/ AS218RX-A	8 DI/6 DO 2 AI/2 AO	3 axes 200kHz pulse output	4 channels 200 kHz high-speed counters



AX-3 CPU New



AX-3 Series CPU Standard Specifications			
Program capacity 8 MB ^(*1)	Basic instruction 5 ns ^(*2)	Expansion modules: 32	
USB/RS-232/485/ Ethernet (1G) ^(*3)	Micro SD Card	EtherNet/IP, Modbus	CODESYS solution
Model	Built-in I/O	Encoder	High-speed Input / Output
AX-308EA0MA1T AX-308EA0MA1P AX-316EA0MA1T AX-364ELA0MA1T	16 DI/8 DO	Incremental encoder: 2 CHs SSI absolute encoder: 1 CH	200 kHz pulse output: 4 axes 200 kHz high-speed counters: 6 CHs
AX-304ELA0PA1T AX-304ELA0PA1P AX-324NA0PA1P	16 DI/8 DO	-	200 kHz PWM output: 4 CHs 200 kHz high-speed counters: 6 CHs
AX-300NA0PA1	-	-	-
AX-332EP0MB1T	6 DI/6 DO	Incremental encoder: 1 CH SSI absolute encoder: 1 CH	200 kHz pulse output : 1 axis 200 kHz high-speed counters: 6 CHs

*1 : AX-332EP supports 128 MB *2 : AX-332EP supports up to 1.6 ns *3 : AX-332EP supports USB/RS-422/485/Ethernet (1G)

Power Supply Modules

Power Supply Modules Specifications			
AS-PS02 	Input 100 V _{AC} ~ 240 V _{AC}	AS-PS02A 	Input 100 V _{AC} ~ 240 V _{AC}
	24 V _{DC} , 2 A (for internal bus)		24 V _{DC} , 1.5 A (for internal bus) 24 V _{DC} , 0.5 A (for external I/O)
AS-PS03C 	Input 100 V _{AC} ~ 240 V _{AC}		
	24 V _{DC} , 3 A (for external I/O)		
	RS-485 (Modbus)		
	Provides information of power status/abnormal alarm/life prediction		

Product Specifications - AS300/200/100 Series

Model		AS332T-A AS332P-A	AS324MT-A	AS320T-B AS320P-B	AS300N-A	AS228 ^{(*)1} AS132 ^{(*)2} AS148 ^{(*)2} AS164 ^{(*)2}	AS218TX-A AS218PX-A AS218RX-A
Programming Languages		Ladder Diagram (LD), Structured Text (ST), Continuous Function Chart (CFC), Sequential Function Chart (SFC), C Language					
Instruction Processing Speed	LD Instruction	25 ns					
	MOV Instruction	0.15 μs					
	Elementary Arithmetic for Integers	0.92 μs ~ 1.02 μs					
	Elementary Arithmetic for Floating Point	1.69 ~ 1.85 μs					
Program Capacity		128k steps			64k steps		
Memory Capacity	Data (D)	64k words (including 30k user-defined, 30k software configuration and 4k special registers)					
	Extension (FR)	64k words (user parameter storage)					
Function Cards		The CPUs support up to 2 function cards			-		
Max. Extension Modules		32 modules (max. 16 analog modules / 4 communication modules)					
Max. Number of Real Inputs / Outputs		1,024 points (input & output)					
CPU Built-in Inputs / Outputs		16 DI / 16 DO	12 DI / 12 DO	8 DI / 12 DO	-	AS228: 16 DI / 12 DO AS132: 16 DI / 16 DO AS148: 24 DI / 24 DO AS164: 32 DI / 32 DO	8 DI / 6 DO & 2 AI / 2 AO
CPU Built-in Differential Inputs / Outputs		-	4 inputs + 4 outputs	-			
Input / Output Devices	X	1,024 inputs (X0.0 ~ X63.15)					
	Y	1,024 outputs (Y0.0 ~ Y63.15)					
Bit Devices	M	8,192 bits (M0 ~ M8191)					
	S	2,048 bits (S0 ~ S2047)					
Timer	T	512 (T0 ~ T511)					
16-bit Counter	C	512 (C0 ~ C511)					
32-bit Counter	HC	256 (HC0 ~ HC255)					
Pulse Output		Open collector: 6 axes, 200 kHz	Open collector: 4 axes, 200 kHz Differential: 2 axes, 4 MHz	Open collector: 6 axes, 200 kHz	-	Open collector: 6 axes, 200 kHz <i>(not supported in relay output models)</i>	Open collector: 3 axes, 200 kHz <i>(not supported in relay output models)</i>
High-Speed Counter		General: 6 CHs, 200 kHz	General: 4 CHs, 200 kHz Differential: 2 CHs, 4 MHz	General: 4 CHs, 200 kHz	-	General: 4 CHs, 200 kHz	General: 4 CHs, 200 kHz
DO Type		AS332T-A: NPN AS332P-A: PNP	Diff. / NPN	AS320T-B: NPN AS320P-B: PNP	-	AS1xxT-A: NPN AS228T-A: NPN AS1xxP-A: PNP AS228P-A: PNP AS1xxR-A: Relay AS228R-A: Relay	AS218TX-A: NPN AS218PX-A: PNP AS218RX-A: Relay
Built-in Communication Port		USB, Ethernet, RS-485 x 2				USB, Ethernet, RS-485 x2, CANopen	
Communication Protocol		Modbus, Modbus TCP, EtherNet/IP, CANopen (requires a CANopen function card)				Modbus, Modbus TCP, EtherNet/IP, CANopen	
Ethernet Connection Resource		Modbus (Client / Server): 32 / 32 EtherNet/IP (CIP): 32				Modbus (Client / Server): 16 / 16 EtherNet/IP (CIP): 16	
Data Backup (Without Battery)	Program	Flash ROM, rewritable up to 100,000 times					
	Latched Area	MRAM, no rewriting limit					
CANopen DS301	Connectable Slave Stations	Max. 64 points					
	CPDO Data Capacity (Host)	Max. 2,000 bytes (Read & Write)					
	PDO Data Capacity (Slave)	Max. 8 PDO (Read & Write); Max. 8 bytes for each PDO					
Real-time Clock (RTC)		General Lithium button battery (CR1620)					
Self-Diagnosis Function		CPU errors, built-in memory errors, and more					
Rated Input Current	AS-PS02 / AS-PS02A / AS-PS03C	110 V _{AC} ~ 240 V _{AC} (±10%)					
	CPU	24 V _{DC} (±10%)					
	Extension Modules	24 V _{DC} (±10%)					

*1: AS228: AS228T-A / AS228P-A / AS228R-A

*2: AS132: AS132T-A / AS132P-A / AS132R-A; AS148: AS148T-A / AS148P-A / AS148R-A; AS164: AS164T-A / AS164P-A / AS164R-A

Product Specifications - AS500 Series

Model		AS516E-B	AS532EST-B	AS564EST-B	AS524C-B
Programming Languages		Ladder Diagram (LD), Structured Text (ST)			
Instruction Processing Speed	Boolean Operation	0.05 μs			
	MOV Instruction	0.11 μs			
	Elementary Arithmetic for Integers	0.24 μs			
	Elementary Arithmetic for Floating Point	0.30 μs			
Program Capacity		20 MB			
Data Capacity		20 MB			
Max. Extension Modules		32 modules (max. 16 analog modules)			
CPU Built-in Inputs/Outputs		16 DI/8 DO			
CPU Built-in Encoder Interface		Incremental x 2 / SSI absolute x 1			
I/O Devices	I (Input)	128 bytes			
	Q (Output)	128 bytes			
Memory Devices	M (Memory)	128k bytes			
Pulse Output		-			
High-Speed Counter		-			
DO Type		NPN			
Built-in Communication Ports		USB, Ethernet, RS232, RS485, EtherCAT, CANopen			USB, Ethernet x2, RS232, RS485, CAN Motion, CANopen
Communication Protocols		Modbus, Modbus TCP, EtherNet/IP, EtherCAT, CANopen DS301			Modbus, Modbus TCP, EtherNet/IP, CANopen DS301 & DS402
Ethernet Connection Resource		Modbus TCP (Client/Server): 16/16 EtherNet/IP (CIP): 8			
Data Backup (Without Battery)	Program	Flash ROM, rewritable up to 100,000 times			
	Latched Area	MRAM, no rewriting limit			
Motion Network	Protocol	EtherCAT ^{*1}			CANopen (DS402) ^{*1}
	Total Axis (Real + Virtual)	32	64	64	32
	Total Real Axis (Motion + P2P)	16	32	64	24
	Total Real Axis (Motion)	16	4	8	24
	Connectable devices	64	64	96	24
CANopen (DS301)	PDO Data Capacity (Host)	CANopen DS301: Max. 8 PDO (read & write)			
	PDO Data Capacity (Slave)	CANopen DS301: Max. 8 PDO (read & write); Max. 8 bytes for each PDO			
Real-time Clock (RTC)		General Lithium button battery (CR1620)			
Self-Diagnosis Function		CPU errors, built-in memory errors, and more			
Rated Input Current	AS-PS02/ AS-PS02A/ AS-PS03C	110 V _{AC} ~ 240 V _{AC} (±10%)			
	CPU				
	Extension Modules	24 V _{DC} (±10%)			

*1: Delta drives only

Product Specifications - AX-3 Series

Model		AX-300NA	AX-324NA	AX-304EL	AX-364EL
Programming Languages		Ladder Diagram (LD), Structured Text (ST), Continuous Function Chart (CFC), Sequential Function Chart (SFC), Function Block Diagram (FBD), Instruction List (IL)			
Instruction Processing Speed	Boolean Operation	5 ns			
	MOV Instruction	-			
	Elementary Arithmetic for Integers	5 ns			
	Elementary Arithmetic for Floating Point	36 ns			
Program Capacity		8 MB			
Data Capacity		16 MB			
Max. Extension Modules		32 modules (max. 16 analog modules)			
CPU Built-in Inputs/Outputs		-	16 DI/8 DO		
CPU Built-in Encoder Interface		-			Incremental x 2 / SSI absolute x 1
I/O Devices	I (Input)	8,192 bytes			
	Q (Output)	8,192 bytes			
Memory Devices	M (Memory)	512k bytes			
Pulse Output		-	Open collector: 4 CHs, 200 kHz (PWM)		Open collector: 4 axes, 200 kHz
DO Type		-	NPN/PNP	NPN/PNP	NPN
High-Speed Counter		-	General: 6 CHs, 200 kHz		
Built-in Communication Ports		USB, Ethernet (Switch), RS232, RS485		USB, Ethernet (Switch) ^{*1} , RS232 ^{*2} , RS422 ^{*3} , RS485, EtherCAT	
Communication Protocols		Modbus, Modbus TCP, EtherNet/IP, OPC UA (Server)		Modbus, Modbus TCP, EtherNet/IP, EtherCAT, OPC UA (Server)	
Ethernet Connection Resource		Modbus TCP (Client+Server): 32 EtherNet/IP (CIP): 12			
Data Backup (Without Battery)	Program	Flash ROM, rewritable up to 100,000 times			
	Latched Area	MRAM, no rewriting limit			
Motion Network	Protocol	-		EtherCAT	
	Total Axis (Real + Virtual)	-	-	8	64 + 4 (PTO)
	Total Real Axis (Motion + P2P)	-	-	4	64 + 4 (PTO)
	Total Real Axis (Motion)	-	-	0	8 + 4 (PTO)
	Connectable devices	-	-	16	96
Real-time Clock (RTC)		General Lithium button battery (CR1620)			
Self-Diagnosis Function		CPU errors, built-in memory errors, and more			
Rated Input Current	AS-PS02 / AS-PS02A / AS-PS03C	110 V _{AC} ~ 240 V _{AC} (±10%)			
	CPU	24 V _{DC} (±10%)			
	Extension Modules	24 V _{DC} (±10%)			

*1: AX-304EL only supports 1 Ethernet port

*2: Not supported by AX-332EP

*3: Only supported by AX-332EP

Model		AX-308EA	AX-316EA	AX-332EP
Programming Languages		Ladder Diagram (LD), Structured Text (ST), Continuous Function Chart (CFC), Sequential Function Chart (SFC), Function Block Diagram (FBD), Instruction List (IL)		
Instruction Processing Speed	Boolean Operation	5 ns		1.6 ns
	MOV Instruction	-		
	Elementary Arithmetic for Integers	5 ns		1.6 ns
	Elementary Arithmetic for Floating Point	36 ns		1.6 ns
Program Capacity		8 MB		128 MB
Data Capacity		16 MB		256 MB
Max. Extension Modules		32 modules (max. 16 analog modules)		
CPU Built-in Inputs/Outputs		16 DI/8 DO		6 DI/6 DO
CPU Built-in Encoder Interface		Incremental x 2 / SSI absolute x 1		Incremental x 1 / SSI absolute x 1
I/O Devices	I (Input)	8,192 bytes		
	Q (Output)	8,192 bytes		
Memory Devices	M (Memory)	512k bytes		
Pulse Output		Open collector: 4 axes, 200 kHz		Open collector: 1 axis, 200 kHz
DO Type		NPN/PNP	NPN	NPN
High-Speed Counter		General: 6 CHs, 200 kHz		
Built-in Communication Ports		USB, Ethernet (Switch) ^{*1} , RS232 ^{*2} , RS422 ^{*3} , RS485, EtherCAT		
Communication Protocols		Modbus, Modbus TCP, EtherNet/IP, EtherCAT, OPC UA (Server)		
Ethernet Connection Resource		Modbus TCP (Client+Server): 32 EtherNet/IP (CIP): 12		
Data Backup (Without Battery)	Program	Flash ROM, rewritable up to 100,000 times		SSD
	Latched Area	MRAM, no rewriting limit		SSD
Motion Network	Protocol	EtherCAT		
	Total Axis (Real + Virtual)	16 + 4 (PTO)	32 + 4 (PTO)	64 + 1 (PTO)
	Total Real Axis (Motion + P2P)	8 + 4 (PTO)	16 + 4 (PTO)	32 + 1 (PTO)
	Total Real Axis (Motion)	8 + 4 (PTO)	16 + 4 (PTO)	32 + 1 (PTO)
	Connectable devices	64	64	256
Real-time Clock (RTC)		General Lithium button battery (CR1620)		Proprietary battery
Self-Diagnosis Function		CPU errors, built-in memory errors, and more		
Rated Input Current	AS-PS02 / AS-PS02A / AS-PS03C	110 V _{AC} ~ 240 V _{AC} (±10%)		
	CPU	24 V _{DC} (±10%)		
	Extension Modules	24 V _{DC} (±10%)		

*1: AX-304EL only supports 1 Ethernet port

*2: Not supported by AX-332EP

*3: Only supported by AX-332EP

Electrical and Environmental Specifications

Item		Specifications
Internal Power Consumption	AS332T-A AS332P-A AS324MT-A AS320T-B AS320P-B	150 mA
	AS300N-A	125 mA
	AS228T-A AS228P-A	150 mA
	AS218TX-A AS218PX-A	180 mA
	AS228R-A	190 mA
	AS218RX-A	200 mA
	AS132T-A AS132P-A	110 mA
	AS132R-A	160 mA
	AS148T-A AS148P-A	125 mA
	AS148R-A	200 mA
	AS164T-A AS164P-A	140 mA
	AS164R-A	240 mA
	AS516E-B AS524C-B AS532EST-B AS564EST-B	333 mA
	AX-308EA0MA1P/T AX-316EA0MA1T AX-364ELA0MA1T	458.3 mA
	AX-300NAOPA1	166.6 mA
	AX-304ELA0PA1P/T AX-324NA0PA1P	208.3 mA
AX-332EP0MB1T	1,000 mA	
Extension Modules	Digital relay output < 150 mA, other modules < 80 mA	
Operating Temperature		-20 ~ 60 °C (AX Series CPU: -20 ~ 55 °C)
Storage Temperature		-40 ~ 80 °C
Operating Humidity		5 ~ 95%, non-condensing
Storage Humidity		5 ~ 95%, non-condensing
Vibration		IEC 61131-2, IEC 60068-2-6 (TEST Fc); 5 Hz ≤ f ≤ 8.4 Hz, constant amplitude 3.5 mm; 8.4 Hz ≤ f ≤ 150 Hz, constant acceleration 1g
Shock		IEC 61131-2, IEC 60068-2-27 (TEST Ea); 15g peak, 11 ms duration, half-sine
Operating Environment		Non-corrosive gas
Installation		Inside of the control panel
Pollution Degree		2
Protection Rating		IP20
Conformal Coating		Yes

Ethernet Specifications

Item		AS300 Series	AS200/100 Series	Note	
Protocols		Modbus TCP, EtherNet/IP, SMTP, HTTP		Supports all protocols at the same time	
Modbus TCP	Connection (Server)	32	16		
	Connection (Client)	32	16		
	RTU-EN01 Connection	4	4		
Socket	TCP Connection	4	2		
	UDP Connection	4	2		
SMTP	E-mail Connection	4	2		
Operation Mode		Scanner / Adapter			
EtherNet/IP	CIP_IO Connection	CIP Connection	32 (Client + Server)	16 (Client + Server)	Shared with IO connection
		TCP Connection	16 (Client + Server)	8 (Client + Server)	Shared with IO connection
		Requested Packet Interval (RPI)	5 ms ~ 1,000 ms		Default: 20 ms
		Max. Performance	3,000 pps		
		Max. Capacity per Connection	500 bytes		
CIP_Explicit Message	Class 3 (Connected Type)	32 (Servers), shared with UCMM	16 (Servers), shared with UCMM	Shared with IO connection	
	UCMM (Unconnected Type)	32 (Clients + Servers), shared with Class 3	16 (Clients + Servers), shared with Class 3	Shared with IO connection	
	Supported CIP Objects	Identity, Message Router, Assembly, Connection Manager, Port, TCP/IP interface, Ethernet link, Vendor specific			
CIP_Produced TAG	Max. CIP Connections	32 (Servers)	16 (Servers)	Shared with IO connection	
	Max. Capacity	500 bytes (IO Connection) 400 bytes (Explicit Message)			
	Requested Packet Interval (RPI)	5 ms ~ 1000ms			
CIP_Consumed TAG	Max. CIP Connections	32 (Clients + Servers)	16 (Clients + Servers)	Shared with IO connection	
	Max. Capacity	400 bytes			
	Requested Packet Interval (RPI)	5 ms ~ 1000 ms			
AS00SCM (RTU) + AS-FEN02 Connection Nodes		15	8	AS00SCM RTU Mode	

Please visit [Delta's official website](#) for selection





Ethernet Specifications

Item		AS500 Series	AX-3 Series	Note	
Protocol		Modbus TCP, EtherNet/IP, Socket	Modbus TCP, EtherNet/IP, Socket, OPC-UA	Supports all protocols at the same time	
Modbus TCP	Connection (Server)	16	32		
	Connection (Client)				
Socket	TCP Connection	8			
	UDP Connection				
EtherNet/IP	Operation Mode		Adapter	Scanner / Adapter	
	CIP_IO Connection	CIP Connection	8	12	Shared with all servers
		TCP Connection	16	12	Shared with all servers
		Requested Packet Interval (RPI)	5 ms ~ 1,000 ms	20 ms ~ 1,000 ms	Default: 20 ms
		Max. Performance	3,000 pps	2,200 pps	
	Max. Capacity per Connection		500 bytes		
	CIP_Explicit Message	Class 3 (Connected Type)	8	12	Shared with all servers
UCMM (Unconnected Type)		16	12	Shared with all servers	
Supported CIP Objects		Identity, Message Router, Assembly, Connection Manager, Port, TCP/IP interface, Ethernet link, Vendor specific			





Item		AS500 Series	AX-3 Series
OPC UA (Server)	Default TCP Port		TCP: 4840 (configurable)
	CMax Sessions (Client)		5
	Max. Monitored Items		1,000
	Sampling Rate (ms)		100/300/500/1,000/2,500/5,000
	Max. Subscriptions		100
	Max. Published Variables		10,000
	Max. Value Attributes		10,000
	Max. Published Structure Definitions		100





I/O Modules

Digital Input Modules

				Rated input voltage 5 ~ 24 V _{DC}
8 inputs	16 inputs	32 inputs	64 inputs	Response time 1 ms
Easy wiring terminal block	Easy wiring terminal block	High-density MIL terminal block	High-density MIL terminal block	Filter function 1 ~ 20 ms
AS08AM10N-A	AS16AM10N-A	AS32AM10N-A	AS64AM10N-A	Screwless removable terminal block 8 / 16 inputs



Digital Output Modules

				NPN (Sink) or PNP (Source) module
8 outputs	8 outputs	8 outputs	32 outputs	Response time 1ms (Transistor) 10ms (Relay)
Easy wiring terminal block Transistor output NPN (Sink)	Easy wiring terminal block Relay output	Easy wiring terminal block Transistor output PNP (Source)	High-density MIL terminal block Transistor output NPN (Sink)	Screwless removable terminal block 8 / 16 outputs
AS08AN01T-A	AS08AN01R-A	AS08AN01P-A	AS32AN02T-A	







			
16 outputs	16 outputs	16 outputs	64 outputs
Easy wiring terminal block Transistor output NPN (Sink)	Easy wiring terminal block Relay output	Easy wiring terminal block Transistor output PNP (Source)	High-density MIL terminal block Transistor output NPN (Sink)
AS16AN01T-A	AS16AN01R-A	AS16AN01P-A	AS64AN02T-A

I/O Modules

Digital I/O Modules

			<p>NPN (Sink) or PNP (Source) module</p> <p>Rated input voltage 5 ~ 24 V_{DC} Filter function 1 ~ 20ms</p> <p>Screwless removable terminal block</p> <p>Response time 1 ms (Transistor) 10 ms (Relay)</p>
16 inputs / outputs	16 inputs / outputs	16 inputs / outputs	
Easy wiring terminal block 8 inputs/8 transistor outputs NPN (Sink)	Easy wiring terminal block 8 inputs 8 relay outputs	Easy wiring terminal block 8 inputs/8 transistor outputs PNP (Source)	
AS16AP11T-A	AS16AP11R-A	AS16AP11P-A	



Analog I/O Modules

					
2 channels	4 channels	8 channels	8 channels	4 channels	6 channels
Analog input	Analog input	Analog input	Analog input	Analog output	Analog input/output
AS02ADH-A New	AS04AD-A	AS08AD-B	AS08AD-C	AS04DA-A	AS06XA-A
Conversion time 20 μs/channel	Conversion time 2 ms/channel	50/60Hz filter		A: Voltage and current B: Voltage C: Current	Resolution AI: 16-bit AO: 12-bit
Accuracy ±0.2%	Accuracy ±0.2%	4/6/8 CHs		Module monitoring/configuration	Differential inputs

Load Cell Module

	Functions	
2 channels	50/60Hz filter	High-speed dynamic measurement
	2 channels of independent sampling	Accuracy 0.04% of full-scale
	2 CHs	Connectable to 4-wire/6-wire load cell sensor
Software		
Filter function	Multi-point calibration	
Online monitoring/configuration		
AS02LC-A		

Pulse Unit Modules

		Input: AS02PU: 200kHz
2 channels	4 channels	Output: AS02PU: 200kHz AS04PU: 100kHz
		Open Collector / Diff.
Differential	Open Collector	2/4 CHs
AS02PU-A	AS04PU-A	Support Motion APIs

High Speed Counter Module

	200kHz
2 channels	Incremental / Absolute (SSI)
	Open Collector / Diff.
Open collector / Diff.	2 CHs
AS02HC-A New	Compare / Capture

■ Temperature Measurement Modules



4 channels	6 channels
PT, NI temperature sensor	PT, NI temperature sensor
AS04RTD-A	AS06RTD-A

Conversion time 200 ms/channel		Resolution 0.1°C/0.18°F	Wire breaking detection
Overall accuracy ±0.1%	50/60 Hz filter	Module monitoring/configuration	4/6 CHs
Pt100/Ni100/Pt1000/Ni1000/JPt100/LG-Ni1000/Cu50/Cu100, resistor 0~300Ω, 0~3,000Ω			



4 channels	8 channels
TC temperature sensor	TC temperature sensor
AS04TC-A	AS08TC-A

Conversion time 200 ms/channel		Resolution 0.1°C/0.18°F	Disconnection detection
Overall accuracy ±0.5%	50/60 Hz filter	Module monitoring/configuration	4/8 CHs
J, K, R, S, T, E, N, B type thermocouple; ±100mV			

■ Communication Modules/Remote I/O Modules



2 COM ports
AS00SCM-A

COM port	RS-232C	RS-422	RS-485	CANopen	Ethernet	PROFINET
Function	Supports standard Modbus protocols and user-defined protocols			Slave mode and RTU mode	EtherNet/IP RTU mode	PROFINET RTU mode
Software	SCMSoft			CANopen Builder	EIP Builder	-

Note: The above functions need optional function cards



EtherCAT
ASRTU-EC16AP1TA New
ASRTU-EC16AP1PA New

COM port	EtherCAT
Function	RIO/ Built-in 8 DI/8 DO/ Supports right-side extension with AS Series modules
Software	EtherCAT master configuration software







DeviceNet
AS01DNET-A





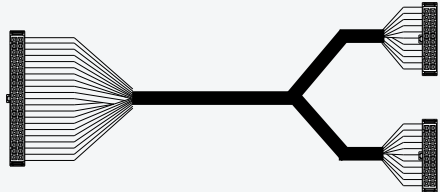



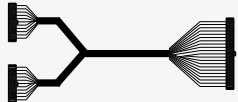

IO-Link
AS04SIL-A



COM port	DeviceNet	IO-Link (4-CH)
Function	Master/Slave/RIO	Master
Software	DeviceNet Builder	HWCONFIG

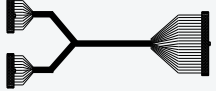

Accessory Selection for High-density Modules

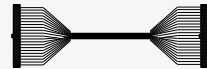
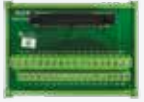
Model Name		
AS332T-A AS332P-A AS324MT-A	UC-ET010-24D (1M) UC-ET020-24D (2M) UC-ET030-24D (3M)	UB-10-ID16A
		
		UB-10-ID16A (NPN/PNP) UB-10-OR16A (NPN to Relay) UB-10-OR16B (PNP to Relay)
		 or 

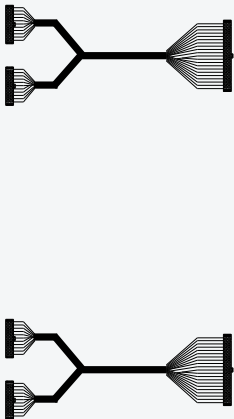
Model Name				
UB-10-ID16A	UC-ET010-24D (1M) UC-ET020-24D (2M) UC-ET030-24D (3M)	AS32AM10N-A	UC-ET010-24B (1M) UC-ET020-24B (2M) UC-ET030-24B (3M)	UB-10-ID32A
				

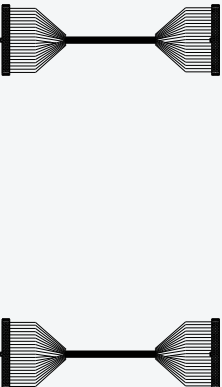
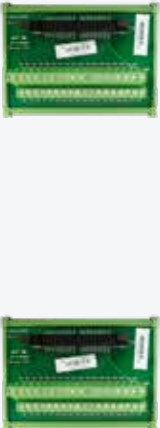
Model Name				
UB-10-ID16A or UB-10-OR16A (Relay)	UC-ET010-24D (1M) UC-ET020-24D (2M) UC-ET030-24D (3M)	AS32AN02T-A	UC-ET010-24B (1M) UC-ET020-24B (2M) UC-ET030-24B (3M)	UB-10-OT32A
 				

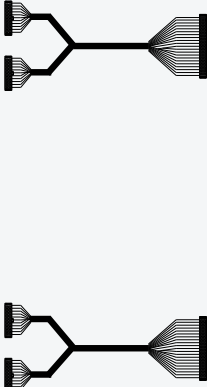
Model Name				
UB-10-ID16A	UC-ET010-24D (1M) UC-ET020-24D (2M) UC-ET030-24D (3M)	AS64AM10N-A	UC-ET010-24B (1M) UC-ET020-24B (2M) UC-ET030-24B (3M)	UB-10-ID32A
				

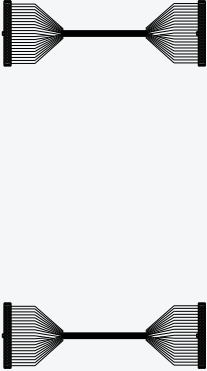
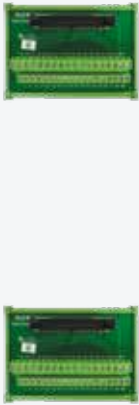
Model Name				
UB-10-ID16A or UB-10-OR16A (Relay)	UC-ET010-24D (1M) UC-ET020-24D (2M) UC-ET030-24D (3M)	AS64AN02T-A	UC-ET010-24B (1M) UC-ET020-24B (2M) UC-ET030-24B (3M)	UB-10-OT32A
				

Dimensions

CPUs

AS516E-B / AS524C-B / AS532EST-B / AS564EST-B

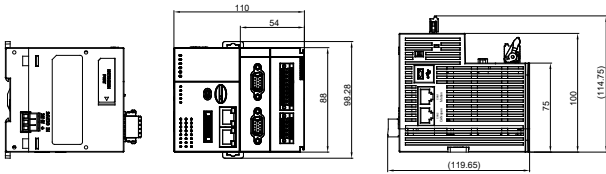

AX-308EA **New** / AX-316EA **New** / AX-364EL **New**

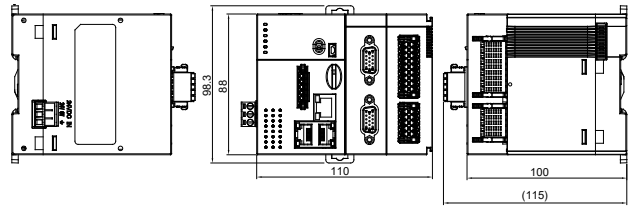

AX-304EL **New** / AX-324NA **New**

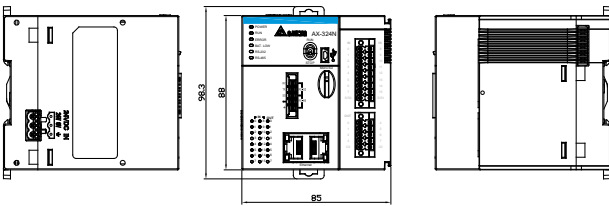

AX-300NA **New**

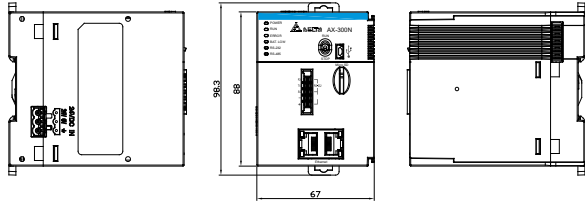

AX-332EP **New**

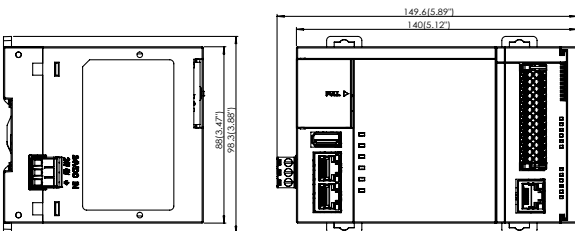

AS332T-A / AS332P-A / AS324MT-A

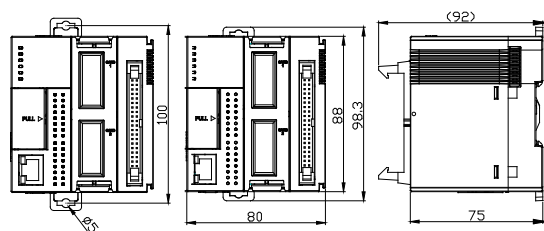

(Unit: mm)

CPUs

AS300N-A

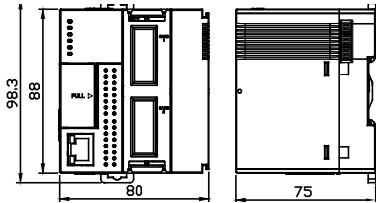

AS320T-B / AS320P-B

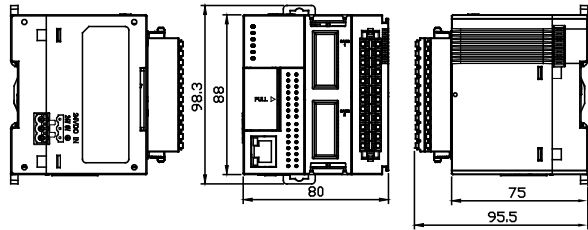

AS228T-A / AS228P-A / AS228R-A /
AS218TX-A / AS218PX-A / AS218RX-A

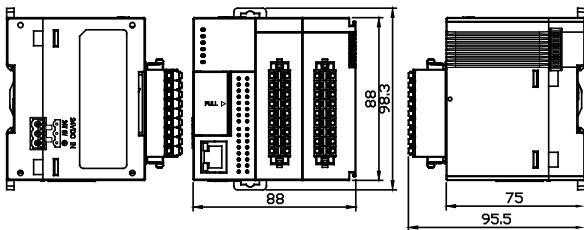

AS132P-A / AS132T-A / AS132R-A **New**

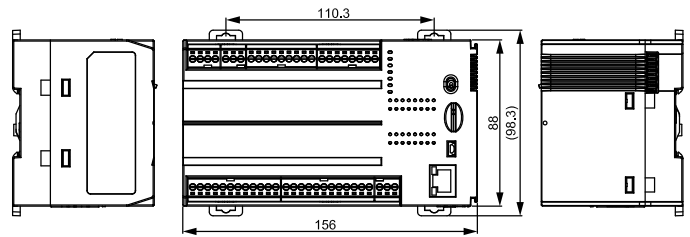

AS148P-A / AS148T-A / AS148R-A **New**

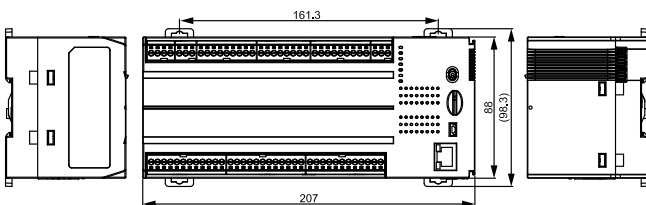

AS164P-A / AS164T-A / AS164R-A **New**

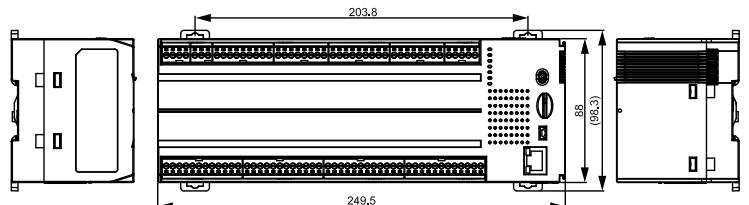

(Unit: mm)

Dimensions

Digital I/O Modules

AS08AM10N-A / AS08AN01R-A /
AS08AN01T-A / AS08AN01P-A

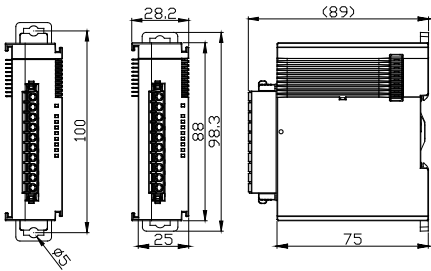

AS16AM10N-A / AS16AN01R-A / AS16AN01T-A /
AS16AN01P-A / AS16AP11R-A / AS16AP11T-A /
AS16AP11P-A

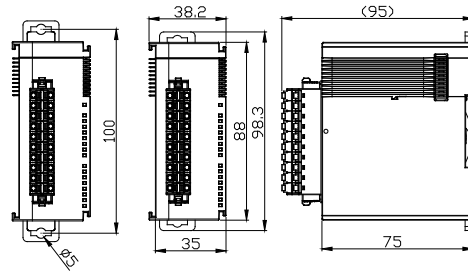

AS32AM10N-A / AS32AN02T-A

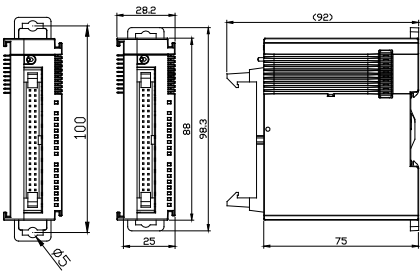

AS64AM10N-A / AS64AN02T-A

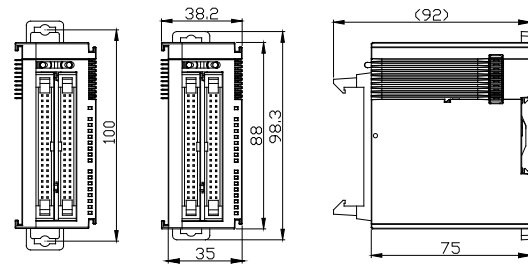

Power Supply Modules

AS-PS02 / AS-PS02A

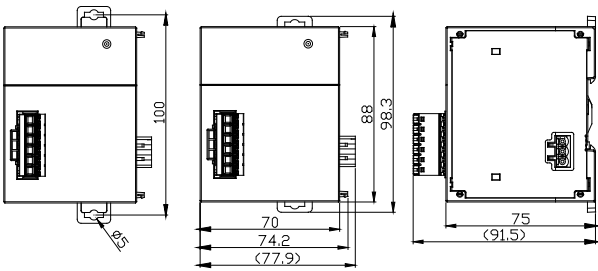

AS-PS03C **New**

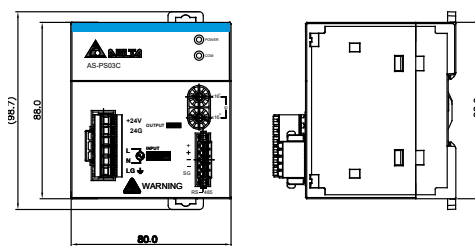

Pulse Unit Modules

AS02PU-A / AS04PU-A

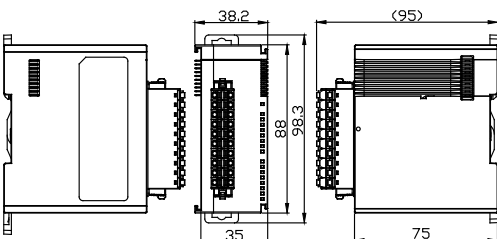

(Unit: mm)

Communication Modules / Remote I/O Modules

AS00SCM-A

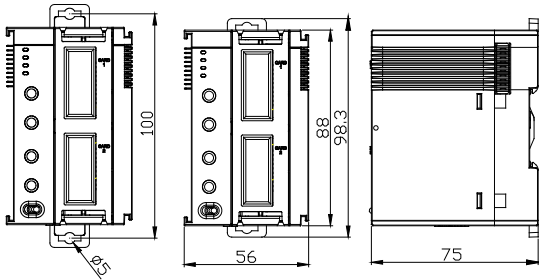

AS01DNET-A

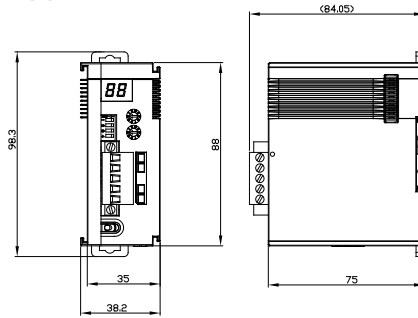

AS04SIL-A

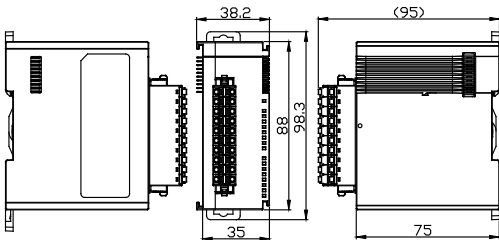

ASRTU-EC16AP1TA **New**, ASRTU-EC16AP1PA **New**

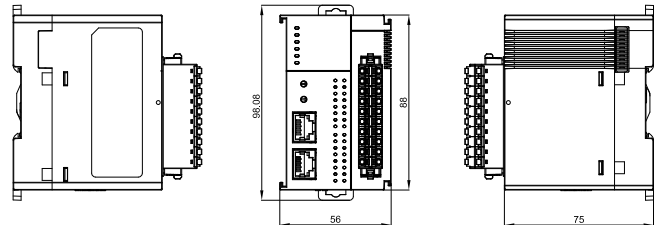

High-speed Counter Module

AS02HC-A **New**

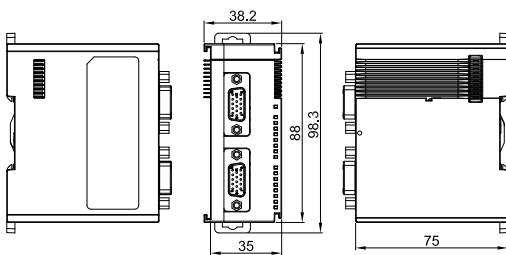

Analog Modules

AS02LC-A / AS04AD-A / AS04DA-A / AS04TC-A /
AS04RTD-A / AS06XA-A / AS08AD-B / AS08AD-C /
AS06RTD-A / AS08TC-A / AS02ADH-A **New**

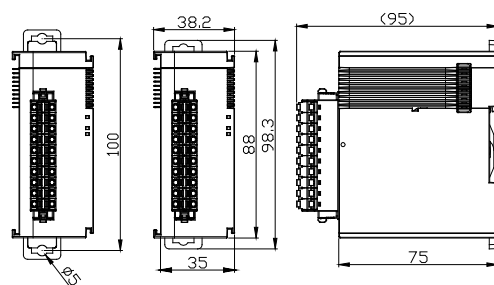

Connector Converter

UB-10-IO32D **New**

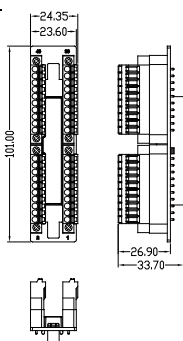

Note:

1. Can NOT be installed on two consecutive high-density modules (interference)
2. Will block LED visibility when installed on 32-point modules

(Unit: mm)

Dimensions

Function Cards

AS-F232

AS-FCOPM

AS-F2AD
AS-F2DA
AS-F422
AS-F485

AS-FEN02
AS-FPFN02 **New**
AS-FOPC02 **New**
AS-FECAT **New**

AS-FFTP01 **New**

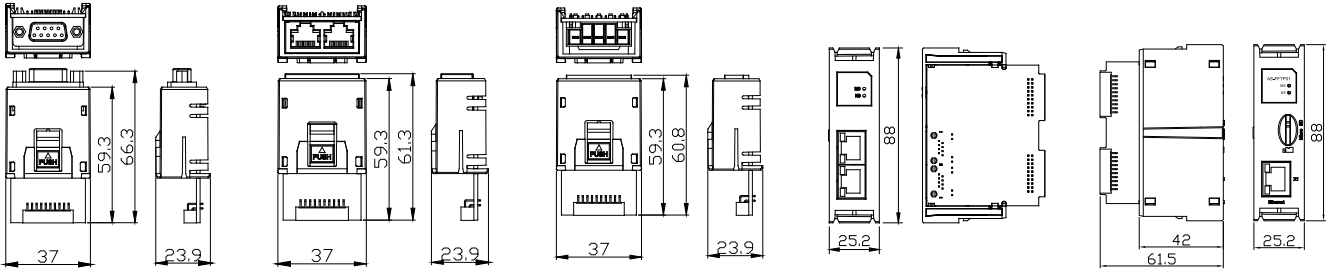

Cable (MIL)

UC-ET010-24D (1M) / UC-ET020-24D (2M) / UC-ET030-24D (3M)

UC-ET010-24B (1M) / UC-ET020-24B (2M) / UC-ET030-24B (3M)

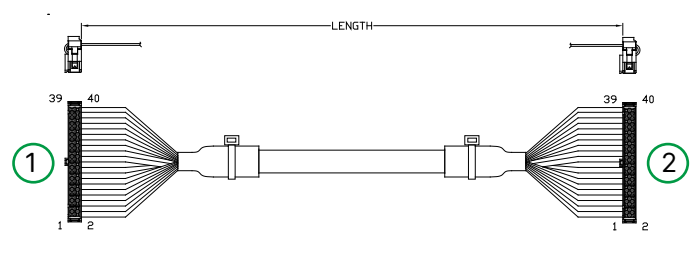
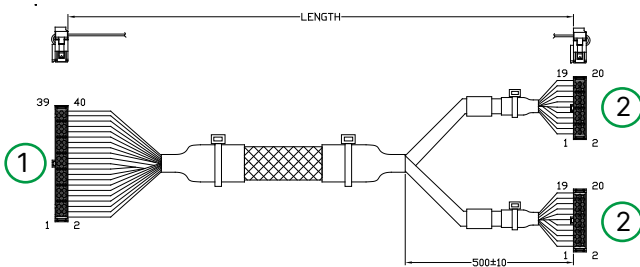

Serial	Name	Description
①	40-pin terminal	Connects to modules
②	20-pin terminal	Connects to external terminal modules UB-10-ID16A or UB-10-OR16A or UB-10-OR16B

Serial	Name	Description
①	40-pin terminal	Connects to modules
②	40-pin terminal	Connects to external terminal modules UB-10-ID32A or UB-10-OT32A

Installation Notes:

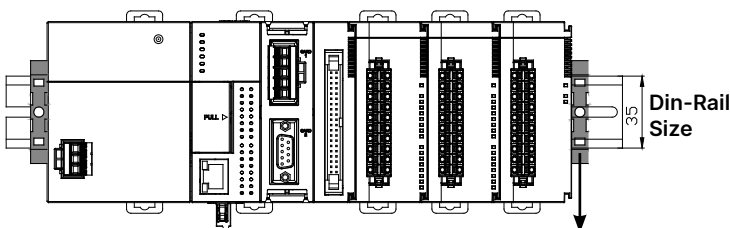

Suggested to install left/right-end stopper

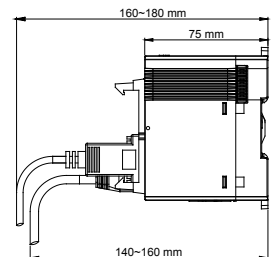
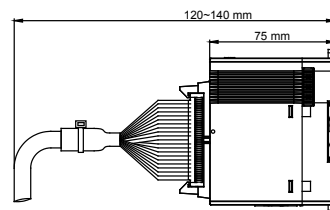

(Unit: mm)

External Terminal Modules

UB-10-OR16A / UB-10-OR16B

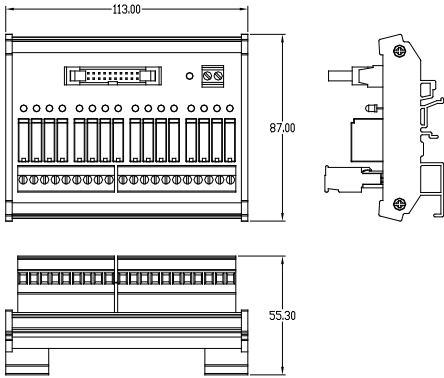

UB-10-OT32A

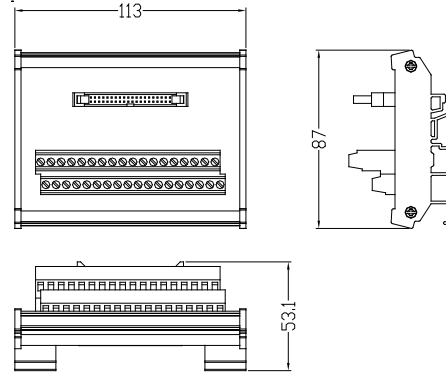

UB-10-ID16A

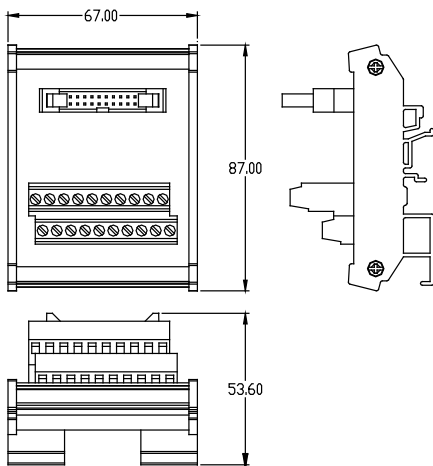

UB-10-ID32A

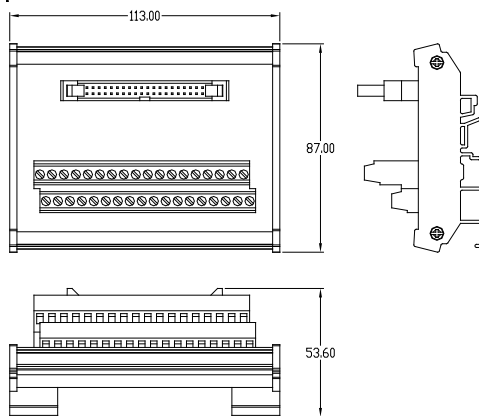

Auxiliary Connected Power Module

AS-ATXB

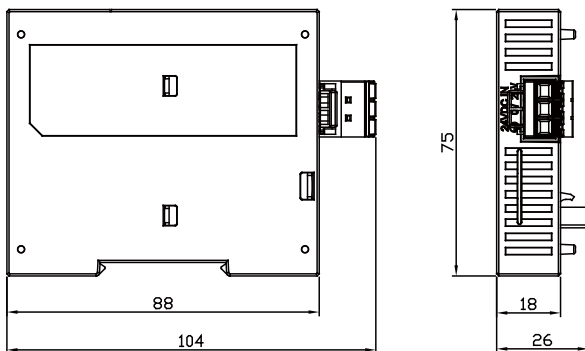

(Unit: mm)

Ordering Information

■ CPUs

Name	Model	Instruction Speed/Performance	Memory / CPU Clock	Max. Inputs & Outputs/Extension Module (Max. Extension Racks)	Memory Card	Certification
CPU	New AS100 AS200 AS300	LD: 25 ns MOV: 0.15 μs 40k steps/1ms (LD 40%, MOV 60%)	RAM: 2 MB ROM: 4 MB CPU clock: 400 MHz	Right-side + remote expansion: 1,024 pts/32 modules (Max. 15 racks)	Micro SD Max. 32 GB	CE/UL
	AS500	Boolean: 0.05 μs Integer: 0.24 μs Float: 0.30 μs	RAM: 20 MB ROM: 20 MB CPU clock: 1 GHz	Right-side expansion: 1,024 pts/32 modules		
	New AX-300NA0PA1 AX-304ELA0PA1P/T AX-308EA0MA1P/T AX-316EA0MA1T AX-324NA0PA1P AX-364ELA0MA1T	Boolean: 5 ns Integer: 5 ns Float: 36 ns	RAM: 16 MB ROM: 16 MB CPU clock: 800 MHz	Right-side expansion: 1,024 pts/32 modules		
	New AX-332EP0MB1T	Boolean: 1.6 ns Integer: 1.6 ns Float: 1.6 ns	RAM: 256 MB ROM: 128 MB CPU clock: 2 GHz	Right-side expansion: 1,024 pts/32 modules		

Name	Model	Program Capacity	Built-in I/O	DO Type	Terminal Block	High-speed Counter	Pulse-train Output	Built-in Communication	Function Card Slot
CPU	AS332T-A	128k steps	16 DI/16 DO	NPN	MIL	6 CHs, 200 kHz	6 Axes, 200 kHz (12 CHs, 200 kHz)	USB RS-485*2 Ethernet	2
	AS332P-A			PNP					
	AS324MT-A		12 DI/12 DO	Diff./NPN		2 CHs, 4 MHz (Diff.) 4 CHs, 200 kHz	2 Axes, 4 MHz (Diff.) 4 Axes, 200 kHz		
	AS320T-B		8 DI/12 DO	NPN	EU (Spring type)	4 CHs, 200 kHz	6 Axes, 200 kHz (12 CHs, 200 kHz)		
	AS320P-B			PNP					
	AS300N-A		-	-	-	-	-		
	AS228T-A	64k steps	16 DI/12 DO	NPN	EU (Spring type)	4 CHs, 200 kHz	6 Axes, 200 kHz (12 CHs, 200 kHz)	USB RS-485*2 Ethernet CANopen	-
	AS228P-A			PNP					
	AS228R-A			Relay					
	AS218TX-A		8 DI/6 DO 2 AI/2 AO ^(*)	NPN			3 Axes, 200 kHz (6 CHs, 200 kHz)		
	AS218PX-A			PNP			-		
	AS218RX-A			Relay			-		
	New AS132T-A	24 DI/24 DO	16 DI/16 DO	NPN	EU (Screw type)	6 Axes, 200 kHz (12 CHs, 200 kHz)	6 Axes, 200 kHz (12 CHs, 200 kHz)		
	New AS132P-A			PNP					
	New AS132R-A			Relay				-	
	New AS148T-A		32 DI/32 DO	NPN				6 Axes, 200 kHz (12 CHs, 200 kHz)	
	New AS148P-A			PNP					
	New AS148R-A			Relay					-
	New AS164T-A	-	-	NPN	EU (Spring type)	-	6 Axes, 200 kHz (12 CHs, 200 kHz)		
	New AS164P-A			PNP					
	New AS164R-A			Relay				-	
	New AX-300NA0PA1 ^{(*)2}	8MB	-	-	EU (Spring type)	-	-	USB RS-232 RS-485 Ethernet	
	New AX-324NA0PA1P ^{(*)2}		16 DI/8 DO	PNP	6 CHs, 200 kHz	4 CHs, 200 kHz (PWM)			

Note:

*1: Built-in AIO specification:

- AI: 12-bit, 3ms, supports ±10 V / ±20 mA / 4 ~ 20 mA

- AO: 12-bit, 2ms, supports ±10 V / ±20 mA

*2: Please contact our distributors for release date

■ CPUs

Name	Model	Program Capacity	Built-in I/O	DO Type	Terminal Block	High-speed Counter	Pulse-train Output	Built-in Communication	Function Card Slot
Motion CPU	AS516E-B (EtherCAT, 16 axes)	20MB	16 DI/8 DO	NPN	EU (Spring type)	-	-	USB RS-232 RS-485 Ethernet CANopen EtherCAT	-
	AS532EST-B ^{(*)2} (EtherCAT, 32 axes, P2P)								
	AS564EST-B ^{(*)2} (EtherCAT, 64 axes, P2P)								
	AS524C-B (CANopen, 24 axes)								
	New AX-304ELA0MA1T/P ^{(*)2} (EtherCAT, 4 axes, P2P)	8MB	6 DI/6 DO	NPN/PNP	EU (Spring type)	6 CHs, 200 kHz	4 CHs, 200 kHz (PMW)	USB RS-232 RS-485 Ethernet EtherCAT	-
	New AX-308EA0MA1P/T ^{(*)2} (EtherCAT, 8 axes)								
	New AX-316EA0MA1T ^{(*)2} (EtherCAT, 16 axes)								
	New AX-332EPOMB1T ^{(*)2} (EtherCAT, 32 axes)	128MB	6 DI/6 DO	NPN	EU (Spring type)	6 CHs, 200 kHz	1 Axis, 200 kHz	USB RS-422 RS-485 Ethernet EtherCAT	-
	New AX-364ELA0MA1T ^{(*)2} (EtherCAT, 64 axes, P2P)	8MB	16 DI/8 DO	NPN	EU (Spring type)	6 CHs, 200 kHz	4 Axes, 200 kHz	USB RS-232 RS-485 Ethernet EtherCAT	-

Note:

*1: Built-in AIO specification:

- AI: 12-bit, 3ms, supports $\pm 10\text{ V} / \pm 20\text{ mA} / 4 \sim 20\text{ mA}$

- AO: 12-bit, 2ms, supports $\pm 10\text{ V} / \pm 20\text{ mA}$

*2: Please contact our distributors for release date

Ordering Information

■ Software

Product Name	License	Descriptions	Supported Device
ISPSOft [V3]	Free	PLC programming software	AS Series ^(*) , AH Series, DVP Series
DIADesigner-AX [V1]	Free	PLC programming software	AX-3 Series
COMMGR [V1 & V2]	Free	Communication management software	AS Series, AH Series, DVP Series
DCISOft [V1]	Free	Ethernet configuration software	AH series Ethernet / serial communication modules, AS series SCM modules, DVP series built-in Ethernet PLCs, DVP series Ethernet / serial communication modules, IFD series Ethernet modules
	Free	SCM serial communication module planning software	AS Series / AH Series / DVP Series built-in CANopen communication modules
CANopen Builder [V5]	Free	CANopen configuration software / motion control programming software	AS Series / AH Series / DVP Series built-in Ethernet communication modules
EIP Builder [V1]	Free	EtherNet/IP configuration software	AS Series / AH Series / DVP Series built-in Ethernet communication modules
Delta OPC [V2] (HASP-20-OPC01)	Hardware License (USB)	Delta OPC Server	AS Series / AH Series
DIADesigner [V1]	Free	Integrated development & engineering software	<ul style="list-style-type: none"> • Controllers: AS Series • Motor Drives: C2000 Family, M300 Family, VFD-EL Family, MPD Series • Servo Drives: ASDA-A2-L & M Series, ASDA-B2-B & F Series, ASDA-A3-L & M Series, ASDA-B3-L & M Series • Temperature Controllers: DTC Series

*1: supports AS300/200 only; does not support AS100

■ Power Supply Modules

Name	Model	Input	Output	Certification
Power Supply Module	AS-PS02	100 ~ 240 V _{AC}	24 V _{DC} , 2 A (for modules on the rack)	CE / UL
	AS-PS02A		24 V _{DC} , 1.5 A (for modules on the rack) 24 V _{DC} , 0.5 A (for external I/O)	
	AS-PS03C ^(*) New		24 V _{DC} , 3 A (for external I/O) Built-in RS-485 (Modbus)	

*1: Please contact our distributors for release date

■ Communication Modules / Remote I/O Modules

Name	Model	Communication Card Installation	Power Consumption (Internal)	Specifications	Certification
Communication Extension Module	AS00SCM-A	2	0.6 W	<ul style="list-style-type: none"> RS-232 / RS-422 / RS-485 (with AS-F232 / 422 / 485) CANopen - Slave & RTU mode (with AS-FCOPM) Ethernet - EtherNet/IP RTU mode (with AS-FEN02) PROFINET - PROFINET RTU mode (with AS-FPFN02) 	CE/UL
DeviceNet Communication Module	AS01DNET-A	-	0.8 W	<ul style="list-style-type: none"> DeviceNet protocol Master / Slave modes RTU function 	
IO-Link Module	AS04SIL-A (*)		0.8 W	<ul style="list-style-type: none"> 4 channels 4.8 / 38.4 / 230.4 kbps Max. process data size: 32 bytes (channel) / 128 bytes (module) 	
EtherCAT Remote I/O Modul	New ASRTU-EC16AP1TA (*) ASRTU-EC16AP1PA (*)		1.8 W	<ul style="list-style-type: none"> EtherCAT Protocol Supports PDO, SDO, Hot Connect Built-in 8 DI (2CH 200 kHz) / 8 DO (2 axes 200 kHz) Supports right-side expansion with AS series DIO / AIO / load cell / temperature modules 	

*1. ASRTU-EC16AP1TA: NPN; ASRTU-EC16AP1PA: PNP; Please contact our distributors for release date

■ Digital I/O Modules

Name	Model	I/O	Signals	Terminal Block Type	Power Consumption (Internal)	Certification
Input Module	AS08AM10N-A	8	24 V _{DC} 5 mA	Removable terminal block	0.5 W	CE/UL
	AS16AM10N-A	16			0.5 W	
	AS32AM10N-A	32		MIL	0.48 W	
	AS64AM10N-A	64			0.72 W	

Name	Model	I/O	Signals	Terminal Block Type	Power Consumption (Internal)	Specifications	Certification
Output Module	AS08AN01R-A	8	240 V _{AC}	Removable terminal block	1.7 W	Relay	CE/UL
	AS16AN01R-A	16	24 V _{DC}		3.4 W	Relay	
	AS08AN01T-A	8	5 ~ 30 V _{DC} 0.5 A		0.72 W	Transistor NPN (Sink)	
	AS08AN01P-A	8			1.4 W	Transistor PNP (Source)	
	AS16AN01T-A	16	MIL	1.4 W	Transistor NPN (Sink)		
	AS16AN01P-A	16		1.4 W	Transistor PNP (Source)		
	AS32AN02T-A	32		5 ~ 30 V _{DC}	0.72 W	Transistor NPN (Sink)	
	AS64AN02T-A	64		0.1 A	1.44 W	Transistor NPN (Sink)	

Name	Model	I/O	Signals		Terminal Block Type	Power Consumption (Internal)	Specifications	Certification
			Input	Output				
Input / Output Module	AS16AP11R-A	16 (8 inputs / 8 outputs)	24 V _{DC} 5 mA	240 V _{AC} 24 V _{DC} 2 A	Removable terminal block	1.9 W	Relay	CE/UL
	AS16AP11T-A	16 (8 inputs / 8 outputs)		5 ~ 30 V _{DC} 0.5 A		0.7 W	Transistor NPN (Sink)	
	AS16AP11P-A	16 (8 inputs / 8 outputs)		0.7 W		Transistor PNP (Source)		

Ordering Information

■ Analog I/O Modules

Name	Model	Channel	Mode	Terminal Block Type	Power Consumption (Internal)	Specifications	Certification
Analog Input Module	New AS02ADH-A	2	1~5V 0~5V -5~5V 0~10V -10~10V 4~20mA 0~20mA -20~20mA	Removable terminal block	1.2W/2W	<ul style="list-style-type: none"> • Hardware resolution: 16-bit • Single channel on/off setting to enhance overall conversion efficiency • Conversion time: 20μs/2 channels • Disconnection detection mode: 1~5V/4~20mA • Built-in external trigger inputs (1 DI / ch) to achieve real time logging function 	CE/UL
	AS04AD-A	4			1.2W/2.16W	<ul style="list-style-type: none"> • Hardware resolution: 16-bit • Single channel on/off setting to enhance overall conversion efficiency • Conversion time: 2ms/channel • Disconnection detection mode: 1~5V/4~20mA 	
	AS08AD-B	8	1~5V 0~5V -5~5V 0~10V -10~10V		1.2W/2.5W		
	AS08AD-C		4~20mA 0~20mA -20~20mA				
Analog Output Module	AS04DA-A	4	0~10V -10~10V 4~20mA 0~20mA		1.2W/2.64W	<ul style="list-style-type: none"> • Hardware resolution: 12-bit • Single channel on/off setting • Conversion time: 250μs/channel 	
Analog Input/Output Module	AS06XA-A	Input: 4 Output: 2	<ul style="list-style-type: none"> • Input: 1~5V, 0~5V, -5~5V, 0~10V, -10~10V, 4~20mA, 0~20mA, -20~20mA • Output: 0~10V, -10~10V, 4~20mA, 0~20mA 		1.2W/2.16W	<ul style="list-style-type: none"> • Input resolution: 16-bit • Output resolution: 12-bit • Single channel on/off setting to enhance overall conversion efficiency • Conversion time: 2ms/channel • Disconnection detection mode: 1~5V/4~20mA 	

■ Temperature Measurement Modules

Name	Model	Channel	Mode	Terminal Block Type	Power Consumption (Internal)	Specifications	Certification
RTD Temperature Measurement Module	AS04RTD-A	4	Pt100 Ni100 Pt1000 Ni1000 JPt100	Removable terminal block	2W/1W	<ul style="list-style-type: none"> • Resolution: 0.1°C/0.18°F • Conversion time: 200 ms/channel • Overall accuracy: RTD: ±0.1% TC: ±0.5% • Disconnection detection mode • Module monitoring/setting/planning software 	CE/UL
	AS06RTD-A	6	LG-Ni1000 Cu50 Cu100 Input impedance 0~300Ω 0~3,000Ω				
Thermocouple Temperature Measurement Module	AS04TC-A	4	J,K,R,S, T,E,N,B -100~+100mV				
	AS08TC-A	8					

■ Load Cell Module



Name	Model	Channel	Mode	Terminal Block Type	Power Consumption (Internal)	Specifications	Certification
Load Cell Module	AS02LC-A	2	0~1 0~2 0~4 0~6 0~20 0~40 0~80 mV/V	Removable terminal block	0.75W/3W	<ul style="list-style-type: none"> • Resolution: 24-bit for hardware (ADC), 32-bit for data output • 4-wire/6-wire load cell sensor • Selectable signal input ranges • LCSofT software configuration • High-speed dynamic measurement • 50/60Hz active filtering 	CE/UL

Ordering Information

■ Motion Modules

Name	Model	Channel	Power Consumption (Internal)	Specifications	Certification
Position Module	AS02PU-A	2	1.5 W	<ul style="list-style-type: none"> • Differential • Output: 200 kHz x 2; Input: 200 kHz x 1 • Motion APIs 	CE/UL
	AS04PU-A	4		<ul style="list-style-type: none"> • Open collector • Output: 100 kHz x 4 • Motion APIs 	
High-speed Counter Module	AS02HC-A	2	3.6 W	<ul style="list-style-type: none"> • Open collector / Differential • 200kHz • Incremental / absolute (SSI) 	

■ Function Cards

Name	Model	Channel	Specifications	Certification
Communication Card	AS-F232	1	Serial COM, RS-232 interface, slave/host mode	CE
	AS-F422	1	Serial COM, RS-422 interface, slave/host mode	
	AS-F485	1	Serial COM, RS-485 interface, slave/host mode	
	AS-FCOPM	1	<ul style="list-style-type: none"> • CANopen port, supports DS301, AS Series remote control or Delta servo motor control • Built-in switchable terminal resistor (120Ω) 	
	AS-FEN02	1	Ethernet port, RJ45 x2 (Switch function), supports EtherNet/IP (Adapter mode)/Modbus TCP	
	AS-FPFN02	1	PROFINET port, RJ45 x2 (Switch function), supports PROFINET (Device mode)	
	AS-FOPC02	1	Ethernet port, RJ45 x2 (Switch function), supports OPC-UA (Server mode)/Modbus TCP	
	 AS-FFTP01 ^(*)	1	Ethernet port, RJ45 x1, supports high security OPC-UA (Server mode)/FTP Server/MQTT Client/Web Server (Node-RED)/Modbus TCP	
	 AS-FECAT ^(*)	2	EtherCAT/Ethernet port, RJ45 x2, configurable as one EtherCAT master and another Modbus TCP server. EtherCAT master supports up to 16 axes point-to-point positioning with Delta drives	
Analog I/O Card	AS-F2AD	2	2-channel analog input 0~10V (12-bit resolution), 4~20mA (11-bit resolution), conversion time: 3ms/channel	
	AS-F2DA	2	2-channel analog Output 0~10V, 4~20mA (12-bit resolution), conversion time: 2ms/channel	

Note 1: Please contact our distributors for release date

■ Function Card Installation Description

Name	Model	Occupied slot qty.	Acceptable installation card slot		
			AS300 CPU	AS00SCM (COM mode)	AS00SCM (RTU mode)
Communication Card	AS-F232	1	Slot 1, 2	Slot 1, 2	-
	AS-F422	1	Slot 1, 2	Slot 1, 2	-
	AS-F485	1	Slot 1, 2	Slot 1, 2	-
	AS-FCOPM	1	Slot 2	Slot 2 (Slot 1 will be disabled)	Slot 2 (Slot 1 will be disabled)
	AS-FEN02	2	Slot 2 (2 slots occupied)	-	Slot 2 (2 slots occupied)
	AS-FPFN02	2	Slot 2 (2 slots occupied)	-	Slot 2 (2 slots occupied)
	AS-FOPC02	2	Slot 2 (2 slots occupied)	-	-
	AS-FFTP01	2	Slot 2 (2 slots occupied)	-	-
	AS-FECAT	2	Slot 2 (2 slots occupied)	-	-
Analog I/O Card	AS-F2AD	1	Slot 1, 2	-	-
	AS-F2DA	1	Slot 1, 2	-	-

Ordering Information

■ Accessories

Name	Model	Descriptions	Specifications		Applicable Module
			Length	Connector / Terminal Block Type	
I/O Cable	UC-ET010-24B	I/O cable for connecting I/O modules and external terminal modules	1m	I/O extension cable (MIL connector IDC40 to IDC40) (Shielded)	AS32AM/AS64AM/AS32AN/AS64AN
	UC-ET010-24D		1m	I/O extension cable (MIL connector IDC40 to IDC20 x2) (Shielded)	AS332T/AS332P/AS324MT/AS32AM/AS64AM/AS32AN/AS64AN
	UC-ET020-24B		2m	I/O extension cable (MIL connector IDC40 to IDC40) (Shielded)	AS32AM/AS64AM/AS32AN/AS64AN
	UC-ET020-24D		2m	I/O extension cable (MIL connector IDC40 to IDC20 x2) (Shielded)	AS332T/AS332P/AS324MT/AS32AM/AS64AM/AS32AN/AS64AN
	UC-ET030-24B		3m	I/O extension cable (MIL connector IDC40 to IDC40) (Shielded)	AS32AM/AS64AM/AS32AN/AS64AN
	UC-ET030-24D		3m	I/O extension cable (MIL connector IDC40 to IDC20 x2) (Shielded)	AS332T/AS332P/AS324MT/AS32AM/AS64AM/AS32AN/AS64AN
Cables	UC-DN01Z-01A ^(*)	CANopen / DeviceNet cables	305.0m	Thick / Trunk cable	AS200 CPU AS01DNET-A TAP-CN01 TAP-CN02 TAP-CN03
	UC-DN01Z-02A ^(*)		305.0m	Thin / Drop cable	
	UC-CMC003-01A	CANopen / DeviceNet / DMCNET cables	0.3m	RJ45	
	UC-CMC005-01A		0.5m	RJ45	
	UC-CMC010-01A		1.0m	RJ45	
	UC-CMC015-01A		1.5m	RJ45	
	UC-CMC020-01A		2.0m	RJ45	
	UC-CMC030-01A		3.0m	RJ45	
	UC-CMC050-01A		5.0m	RJ45	
	UC-CMC100-01A		10.0m	RJ45	
	UC-CMC200-01A		20.0m	RJ45	

Note:

- Ordering unit: meter
- Not available in Taiwan

■ Accessories

Name	Model	Descriptions	Specifications		Applicable Module
			Length	Connector / Terminal Block Type	
Cables	UC-EMC003-02C	EtherCAT communication cable (High noise immunity)	0.3m	RJ45	AS-FECAT AS516E-B AS532EST-B AS564EST-B AX-304ELA0PA1P/T AX-308EA0MA1P/T AX-316EA0MA1T AX-332EP0MB1T AX-364ELA0MA1T
	UC-EMC005-02C		0.5m		
	UC-EMC010-02C		1m		
	UC-EMC020-02C		2m		
	UC-EMC050-02C		5m		
	UC-EMC100-02C		10m		
	UC-EMC200-02C		20m		
	UC-EMC003-02B	EtherCAT communication cable	0.3m	RJ45	
	UC-EMC005-02B		0.5m		
	UC-EMC010-02B		1m		
	UC-EMC020-02B		2m		
	UC-EMC030-02B		3m		
	UC-EMC050-02B		5m		
	UC-EMC100-02B		10m		

Note:

- Ordering unit: meter
- Not available in Taiwan

Ordering Information

■ Accessories

Name	Model	Descriptions	Specifications		Applicable Module
			Length	Connector / Terminal Block Type	
External terminal module	UB-10-ID16A	External terminal modules for digital modules	--	16 inputs or outputs (MIL connector, 20 Pins)	AS332T / AS332P / AS324MT / AS32AM / 64AM / AS32AN / AS64AN
	UB-10-ID32A			32 inputs (MIL connector, 40 Pins)	AS32AM / AS64AM
	UB-10-OT32A			32 transistor outputs (MIL connector, for NPN output)	AS32AN / AS64AN
	UB-10-OR16A			16 relay outputs (MIL connector, for NPN output)	AS332T / AS32AN02T / AS64AN02T
	UB-10-OR16B			16 relay outputs (MIL connector, for PNP output)	AS332P
	UB-10-IO32D			Connector converter (MIL → Spring) <small>(Can NOT be installed on two consecutive high-density modules) (Will block LED visibility when installed on 32-point I/O modules)</small>	AS332T / AS332P / AS324MT / AS32AM / AS32AN
Terminal resistors	TAP-TR01	CANopen/DeviceNet terminal resistors (RJ45)			
Distribution box	TAP-CP01	CANopen / DeviceNet distribution box	--	Power distribution box	
	TAP-CN01		--	1 for 2	
	TAP-CN02		--	1 for 4	
	TAP-CN03		--	1 for 4 (RJ45)	
Auxiliary connected power module	AS-ATXB	Moves the CPU power connector from left side to the bottom			
PLC programming cable	UC-PRG015-01A	Communication cable: PLC to PC	1.5 m	PLC (mini USB)	
	UC-PRG030-01A		3 m	PLC (mini USB)	
	UC-PRG030-20A	Communication cable: PLC / HMI (RJ45) to PC	3 m	PLC/HMI (RJ45)	

■ Starter Kit

Name	Model	Specifications
Delta PLC starter kit	UT-AS332-C	AS332T-A CPU, a power module and accessories

Global Operations

ASIA (Taiwan)



Taoyuan Technology Center (Green Building)



Taoyuan Plant 1



Tainan Plant (Diamond-rated Green Building)

ASIA (China)



Wujiang Plant 3



Shanghai Office

▲ 10 Factories

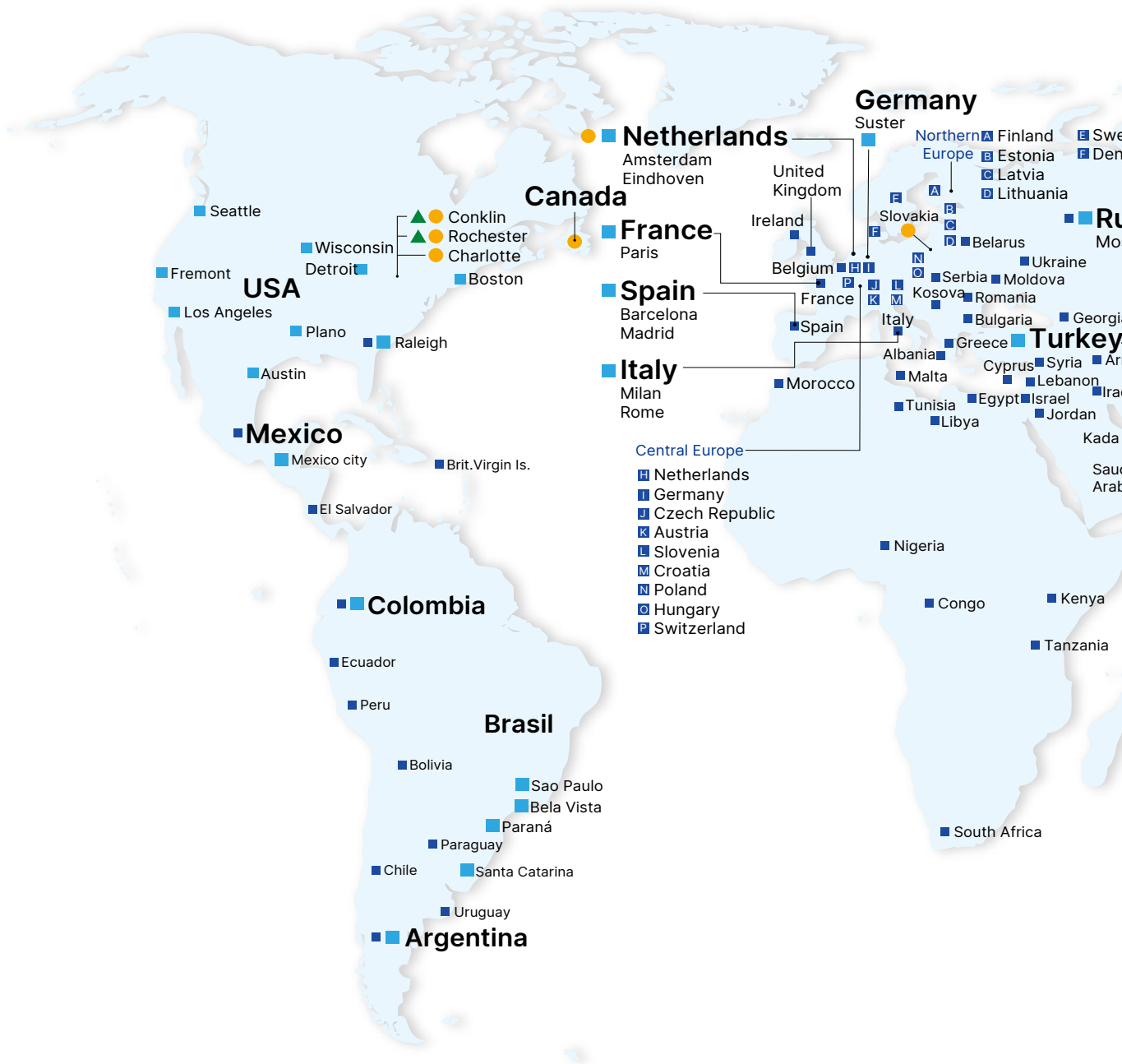

ASIA (Japan)



Tokyo Office

ASIA (India)



Rudrapur Plant (Green Building)

EUROPE



Amsterdam, the Netherlands

AMERICA



Research Triangle Park, U.S.A.

85 Branch Offices

19 R&D Centers

980 Distributors

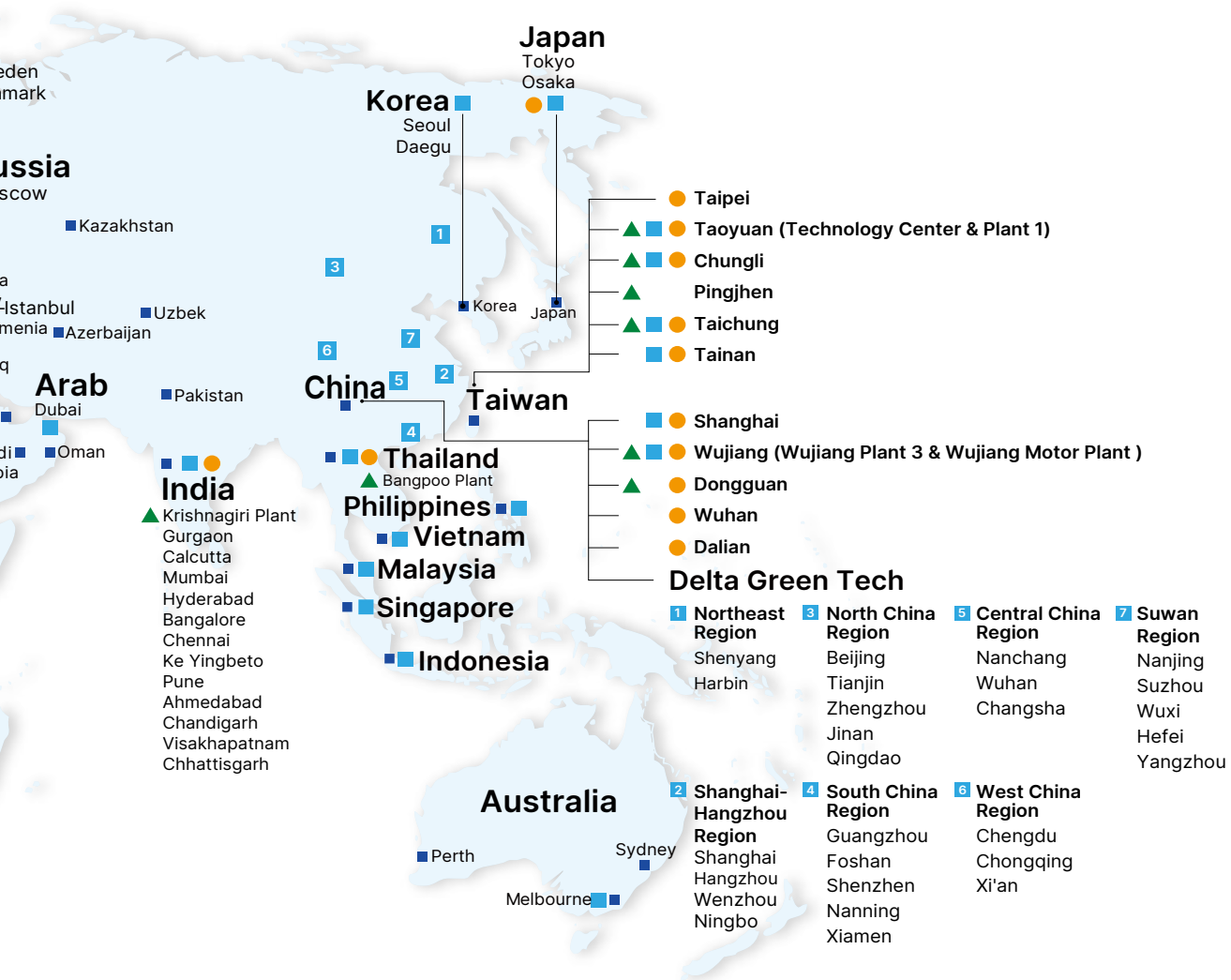



Smarter. Greener. Together.

Industrial Automation Headquarters

Taiwan: Delta Electronics, Inc.

Taoyuan Technology Center
No.18, Xinglong Rd., Taoyuan District,
Taoyuan City 33068, Taiwan
TEL: +886-3-362-6301 / FAX: +886-3-371-6301

Asia

China: Delta Electronics (Shanghai) Co., Ltd.

No.182 Minyu Rd., Pudong Shanghai, P.R.C.
Post code : 201209
TEL: +86-21-6872-3988 / FAX: +86-21-6872-3996
Customer Service: 400-820-9595

Japan: Delta Electronics (Japan), Inc.

Industrial Automation Sales Department
2-1-14 Shibadaimon, Minato-ku
Tokyo, Japan 105-0012
TEL: +81-3-5733-1155 / FAX: +81-3-5733-1255

Korea: Delta Electronics (Korea), Inc.

1511, 219, Gasan Digital 1-Ro., Geumcheon-gu,
Seoul, 08501 South Korea
TEL: +82-2-515-5305 / FAX: +82-2-515-5302

Singapore: Delta Energy Systems (Singapore) Pte Ltd.

4 Kaki Bukit Avenue 1, #05-04, Singapore 417939
TEL: +65-6747-5155 / FAX: +65-6744-9228

India: Delta Electronics (India) Pvt. Ltd.

Plot No.43, Sector 35, HSIIDC Gurgaon,
PIN 122001, Haryana, India
TEL: +91-124-4874900 / FAX: +91-124-4874945

Thailand: Delta Electronics (Thailand) PCL.

909 Soi 9, Moo 4, Bangpoo Industrial Estate (E.P.Z),
Pattana 1 Rd., T.Phraksa, A.Muang,
Samutprakarn 10280, Thailand
TEL: +66-2709-2800 / FAX: +66-2709-2827

Australia: Delta Electronics (Australia) Pty Ltd.

Unit 2, Building A, 18-24 Ricketts Road,
Mount Waverley, Victoria 3149 Australia
Mail: IA.au@deltaww.com
TEL: +61-1300-335-823 / +61-3-9543-3720

Americas

USA: Delta Electronics (Americas) Ltd.

5101 Davis Drive, Research Triangle Park, NC 27709, U.S.A.
TEL: +1-919-767-3813 / FAX: +1-919-767-3969

Brazil: Delta Electronics Brazil Ltd.

Estrada Velha Rio-São Paulo, 5300 Eugênio de
Melo - São José dos Campos CEP: 12247-004 - SP - Brazil
TEL: +55-12-3932-2300 / FAX: +55-12-3932-237

Mexico: Delta Electronics International Mexico S.A. de C.V.

Gustavo Baz No. 309 Edificio E PB 103
Colonia La Loma, CP 54060
Tlalnepantla, Estado de México
TEL: +52-55-3603-9200

EMEA

EMEA Headquarters: Delta Electronics (Netherlands) B.V.

Sales: Sales.IA.EMEA@deltaww.com
Marketing: Marketing.IA.EMEA@deltaww.com
Technical Support: iatechnicalsupport@deltaww.com
Customer Support: Customer-Support@deltaww.com
Service: Service.IA.emea@deltaww.com
TEL: +31(0)40 800 3900

BENELUX: Delta Electronics (Netherlands) B.V.

Automotive Campus 260, 5708 JZ Helmond, The Netherlands
Mail: Sales.IA.Benelux@deltaww.com
TEL: +31(0)40 800 3900

DACH: Delta Electronics (Netherlands) B.V.

Coesterweg 45, D-59494 Soest, Germany
Mail: Sales.IA.DACH@deltaww.com
TEL: +49 2921 987 238

France: Delta Electronics (France) S.A.

ZI du bois Challand 2, 15 rue des Pyrénées,
Lisses, 91090 Evry Cedex, France
Mail: Sales.IA.FR@deltaww.com
TEL: +33(0)1 69 77 82 60

Iberia: Delta Electronics Solutions (Spain) S.L.U

Ctra. De Villaverde a Vallecas, 265 1º Dcha Ed.
Hormigueras – P.I. de Vallecas 28031 Madrid
TEL: +34(0)91 223 74 20

Carrer Llacuna 166, 08018 Barcelona, Spain

Mail: Sales.IA.Iberia@deltaww.com

Italy: Delta Electronics (Italy) S.r.l.

Via Meda 2-22060 Novedrate(CO)
Piazza Grazioli 18 00186 Roma Italy
Mail: Sales.IA.Italy@deltaww.com
TEL: +39 039 8900365

Russia: Delta Energy System LLC

Vereyskaya Plaza II, office 112 Vereyskaya str.
17 121357 Moscow Russia
Mail: Sales.IA.RU@deltaww.com
TEL: +7 495 644 3240

Turkey: Delta Greentech Elektronik San. Ltd. Sti. (Turkey)

Şerifali Mah. Hendem Cad. Kule Sok. No:16-A
34775 Ümraniye – İstanbul
Mail: Sales.IA.Turkey@deltaww.com
TEL: + 90 216 499 9910

MEA: Eltek Dubai (Eltek MEA DMCC)

OFFICE 2504, 25th Floor, Saba Tower 1,
Jumeirah Lakes Towers, Dubai, UAE
Mail: Sales.IA.MEA@deltaww.com
TEL: +971(0)4 2690148

*We reserve the right to change the information in this catalogue without prior notice.